

# FCC RADIO TEST REPORT

## FCC 47 CFR PART 15 SUBPART C

<b>Test Standard</b>	<b>FCC Part 15.231+ IC RSS-210 Issue 10</b>
<b>Product name</b>	<b>Radio Frequency Transmitter SBRT</b>
<b>Model No.</b>	<b>GEN1</b>
<b>Trade name</b>	<b>Continental</b>
<b>Operation Freq.</b>	<b>TX: 433.66MHz &amp; 433.92MHz, RX: 125KHz</b>
<b>Test Result</b>	<b>Pass</b>
<b>Statements of Conformity</b>	<b>Determination of compliance is based on the results of the compliance measurement, not taking into account measurement instrumentation uncertainty.</b>

The test Result was tested by Compliance Certification Services Inc. The test data, data evaluation, test procedures, and equipment configurations shown in this report were given in ANSI C63.10: 2013 and compliance standards.

The test results of this report relate only to the tested sample (EUT) identified in this report.

The test Report of full or partial shall not copy. Without written approval of SGS Compliance Certification Services Inc. (Wugu Laboratory)

Approved by:



---

Shawn Wu  
Supervisor

Unless otherwise stated the results shown in this test report refer only to the sample(s) tested and such sample(s) are retained for 90 days only.  
除非另有說明，此報告結果僅對測試之樣品負責，同時此樣品僅保留90天。本報告未經本公司書面許可，不可部份複製。

This document is issued by the Company subject to its General Conditions of Service printed overleaf, available on request or accessible at <http://www.sgs.com.tw/Terms-and-Conditions> and, for electronic format documents, subject to Terms and Conditions for Electronic Documents at <http://www.sgs.com.tw/Terms-and-Conditions>. Attention is drawn to the limitation of liability, indemnification and jurisdiction issues defined therein. Any holder of this document is advised that information contained hereon reflects the Company's findings at the time of its intervention only and within the limits of client's instruction, if any. The Company's sole responsibility is to its Client and this document does not exonerate parties to a transaction from exercising all their rights and obligations under the transaction documents. This document cannot be reproduced, except in full, without prior written approval of the Company. Any unauthorized alteration, forgery or falsification of the content or appearance of this document is unlawful and offenders may be prosecuted to the fullest extent of the law.

### Revision History

Rev.	Issue Date	Revisions	Effect Page	Revised By
00	November 16, 2021	Initial Issue	ALL	Allison Chen
01	November 26, 2021	See the following Note Rev.(01)	ALL	Allison Chen
02	November 30, 2021	See the following Note Rev.(02)	P.16	Allison Chen

**Note:**

**Rev.(01)**

1. Modified test data for section 3.4, 4.2.4, 4.3.4, 4.5.4 and test photo.

**Rev.(02)**

1. Modified test procedure and test setup in section 4.2.2 and 4.2.3.

## Table of contents

<b>1. GENERAL INFORMATION</b> .....	<b>4</b>
<b>1.1 EUT INFORMATION</b> .....	<b>4</b>
<b>1.2 EUT CHANNEL INFORMATION</b> .....	<b>5</b>
<b>1.3 ANTENNA INFORMATION</b> .....	<b>5</b>
<b>1.4 MEASUREMENT UNCERTAINTY</b> .....	<b>6</b>
<b>1.5 FACILITIES AND TEST LOCATION</b> .....	<b>7</b>
<b>1.6 INSTRUMENT CALIBRATION</b> .....	<b>7</b>
<b>1.7 SUPPORT AND EUT ACCESSORIES EQUIPMENT</b> .....	<b>8</b>
<b>1.8 TEST METHODOLOGY AND APPLIED STANDARDS</b> .....	<b>8</b>
<b>2. TEST SUMMARY</b> .....	<b>9</b>
<b>3. DESCRIPTION OF TEST MODES</b> .....	<b>10</b>
<b>3.1 THE WORST MODE OF OPERATING CONDITION</b> .....	<b>10</b>
<b>3.2 THE WORST MODE OF MEASUREMENT</b> .....	<b>10</b>
<b>3.3 FCC PART 15.205 RESTRICTED BANDS OF OPERATIONS</b> .....	<b>11</b>
<b>3.4 EUT DUTY CYCLE</b> .....	<b>13</b>
<b>4. TEST RESULT</b> .....	<b>15</b>
<b>4.1 AC POWER LINE CONDUCTED EMISSION</b> .....	<b>15</b>
<b>4.2 EMISSION BANDWIDTH</b> .....	<b>16</b>
<b>4.3 FIELD STRENGTH OF FUNDAMENTAL</b> .....	<b>19</b>
<b>4.4 RADIATION UNWANTED EMISSION</b> .....	<b>26</b>
<b>4.5 OPERATION RESTRICTION</b> .....	<b>39</b>
<b>4.6 ANTENNA REQUIREMENT</b> .....	<b>42</b>
<b>APPENDIX 1 – PHOTOGRAPHS OF EUT</b>	

Report No.: TMWK2108000552KR

## 1. GENERAL INFORMATION

### 1.1 EUT INFORMATION

FCC Applicant / Manufacturer	Continental Automotive GmbH Siemensstrasse 12 SV C TS RBG EMC - Laboraroty Regensburg, 9355 Germany
IC Applicant / Manufacturer	Continental Automotive GmbH Siemenstrasse 12 Regensburg 93055 Germany ( Fedral Republic Of)
Factory	Continental Aguascalientes, Mexico Carretera Panamericana Sur Km 114 + 354, int. 9 Parque Industrial FINSA CP 20393 Aguascalientes , Mexico
Equipment	Radio Frequency Transmitter SBRT
Model Name	GEN1
Model Discrepancy	N/A
Received Date	September 8, 2021
Date of Test	September 14 ~ November 24, 2021
Periodic operation	<input checked="" type="checkbox"/> (1) A manually operated transmitter shall employ a switch that will automatically deactivate the transmitter within not more than 5 seconds of being released. <input type="checkbox"/> (2) A transmitter activated automatically shall cease transmission within 5 seconds after activation <input type="checkbox"/> (3) Periodic transmissions at regular predetermined intervals are not permitted. <input type="checkbox"/> (4) Periodic transmissions (lower field strength): each transmission is not greater than 1 sec and the silent period between transmissions is at least 30 times the duration of the transmission but in no case less than 10 sec.
Power Operation	Power from Battery: CR2450X x1 (Lithium: 3V)
Operation Frequency	TX: 433.66MHz & 433.92MHz RX: 125KHz
H/W Version	AF
S/W Version	0403

**Remark:**

1. For more details, please refer to the User's manual of the EUT.

Report No.: TMWK2108000552KR

## 1.2 EUT CHANNEL INFORMATION

Frequency Range	TX: 433.66MHz & 433.92MHz RX: 125KHz
Modulation Type	FSK

**Remark:**

Refer as ANSI 63.10:2013 clause 5.6.1 Table 4 for test channels

Number of frequencies to be tested		
Frequency range in which device operates	Number of frequencies	Location in frequency range of operation
<input checked="" type="checkbox"/> 1 MHz or less	1	Middle
<input type="checkbox"/> 1 MHz to 10 MHz	2	1 near top and 1 near bottom
<input type="checkbox"/> More than 10 MHz	3	1 near top, 1 near middle, and 1 near bottom

## 1.3 ANTENNA INFORMATION

Antenna Type	TX: Bult-in loop antenna RX: Coil Antenna
Antenna Gain	TX: -12.87 dBi RX: 0 dBi
Antenna Connector	N/A

**Remark:**

1. Disclaimer: Antenna information is provided by the applicant, test results of this report are applicable to the sample EUT received.

## 1.4 MEASUREMENT UNCERTAINTY

PARAMETER	UNCERTAINTY
AC Powerline Conducted Emission	+/- 1.2575
Emission bandwidth, 20dB bandwidth	+/- 0.0014
RF output power, conducted	+/- 1.14
Power density, conducted	+/- 1.40
3M Semi Anechoic Chamber / 30M~1G (Horizontally)	+/- 3.91
3M Semi Anechoic Chamber / 30M~1G (Vertically)	+/- 4.57
3M Semi Anechoic Chamber / 1G~6G	+/- 5.20
3M Semi Anechoic Chamber / 6G~18G	+/- 5.18
3M Semi Anechoic Chamber / 18G~40G	+/- 3.68

**Remark:**

- 1.This uncertainty represents an expanded uncertainty expressed at approximately the 95% confidence level using a coverage factor of k=2
2. ISO/IEC 17025 requires that an estimate of the measurement uncertainties associated with the emissions test results be included in the report.

Report No.: TMWK2108000552KR

## 1.5 FACILITIES AND TEST LOCATION

All measurement facilities used to collect the measurement data are located at  
No.11, Wugong 6th Rd., Wugu Dist., New Taipei City, Taiwan. (R.O.C.)  
CABID: TW1309

Test site	Test Engineer	Remark
AC Conduction Room	-	Not applicable, because EUT doesn't connect to AC Main Source direct.
Radiation	Jerry Chang / Lance Chen	-

**Remark:** The sites are constructed in conformance with the requirements of ANSI C63.7, ANSI C63.4 and CISPR Publication 22.

## 1.6 INSTRUMENT CALIBRATION

3M 966A Chamber Test Site					
Equipment	Manufacturer	Model	S/N	Cal Date	Cal Due
Bilog Antenna	Sunol Sciences	JB3	A030105	07/19/2021	07/18/2022
Coaxial Cable	HUBER SUHNER	SUCOFLEX 104PEA	20995	02/24/2021	02/23/2022
Coaxial Cable	EMCI	EMC105	190914+327109/4	09/19/2020	09/18/2021
Coaxial Cable	EMCI	EMC105	190914+327109/4	09/17/2021	09/16/2022
Digital Thermo-Hygro Meter	WISEWIND	1206	D07	01/06/2021	01/05/2022
Horn Antenna	ETS LINDGREN	3117	00055165	07/29/2021	07/28/2022
High Pass Filter	SOLVANG TECHNOLOGY INC.	STI15	9923	02/08/2021	02/07/2022
Pre-Amplifier	EMEC	EM330	060609	02/24/2021	02/23/2022
Pre-Amplifier	HP	8449B	3008A00965	12/25/2020	12/24/2021
Signal Analyzer	R&S	FSV 40	101073	09/17/2020	09/16/2021
Signal Analyzer	R&S	FSV 40	101073	09/07/2021	09/06/2022
EXA Signal Analyzer	KEYSIGHT	N9010B	MY55460167	09/07/2021	09/06/2022
Antenna Tower	CCS	CC-A-1F	N/A	N.C.R	N.C.R
Controller	CCS	CC-C-1F	N/A	N.C.R	N.C.R
Turn Table	CCS	CC-T-1F	N/A	N.C.R	N.C.R
<b>Software</b>	e3 6.11-20180419c				

**Remark:**

1. Each piece of equipment is scheduled for calibration once a year.
2. N.C.R. = No Calibration Required.

## 1.7 SUPPORT AND EUT ACCESSORIES EQUIPMENT

There are no accessories and support equipment be used during the test.

EUT Accessories Equipment					
No.	Equipment	Brand	Model	Series No.	FCC ID
	N/A				

Support Equipment					
No.	Equipment	Brand	Model	Series No.	FCC ID
1	NB(G)	Lenovo	IBM 1951	R33B65	CJ6UPA3489WL

## 1.8 TEST METHODOLOGY AND APPLIED STANDARDS

The test methodology, setups and results comply with all requirements in accordance with ANSI C63.10:2013, FCC 15.231, IC RSS-210, IC RSS-Gen Rules.



## 2. TEST SUMMARY

FCC Standard Sec.	IC Standard Sec.	Chapter	Test Item	Result
15.207	RSS-GEN Sec. 8.8	4.1	AC Power-line Conducted Emission	Not applicable
15.231(c)	RSS-210 A.1.3	4.2	Emission Bandwidth	Pass
15.231(b)	RSS-210 A.1.2	4.3	Fundamental Emission	Pass
15.209(b)	RSS-GEN Sec. 8.9	4.4	Transmitter Radiated Emission	Pass
15.231(a)(1)	RSS-210 A.1.2	4.5	Operation Restriction	Pass
15.203	RSS-GEN Sec. 6.8	4.6	Antenna Requirement	Pass

Report No.: TMWK2108000552KR

### 3. DESCRIPTION OF TEST MODES

#### 3.1 THE WORST MODE OF OPERATING CONDITION

Operation mode	TX: 433.66 & 433.92MHz RX: 125kHz
RF Field strength	<b>TX 433.66MHz</b> <u>Peak: 86.13 dBuV/m</u> <u>Average : 68.01 dBuV/m</u>  <b>TX 433.92MHz</b> <u>Peak: 84.59 dBuV/m</u> <u>Average : 64.63 dBuV/m</u>

Remark: Field strength performed Average level at 3m.

#### 3.2 THE WORST MODE OF MEASUREMENT

Radiated Emission Measurement Above 1G	
Test Condition	Radiated Emission Above 1G
Power supply Mode	Mode 1: EUT power by Battery
Worst Mode	<input checked="" type="checkbox"/> Mode 1 <input type="checkbox"/> Mode 2 <input type="checkbox"/> Mode 3 <input type="checkbox"/> Mode 4
Worst Position	<input type="checkbox"/> Placed in fixed position. <input type="checkbox"/> Placed in fixed position at X-Plane (E2-Plane) <input type="checkbox"/> Placed in fixed position at Y-Plane (E1-Plane) <input checked="" type="checkbox"/> Placed in fixed position at Z-Plane (H-Plane)

Radiated Emission Measurement Below 1G	
Test Condition	Radiated Emission Below 1G
Power supply Mode	Mode 1: EUT power by Battery
Worst Mode	<input checked="" type="checkbox"/> Mode 1 <input type="checkbox"/> Mode 2 <input type="checkbox"/> Mode 3 <input type="checkbox"/> Mode 4

Remark:

1. The worst mode was record in this test report.
2. EUT pre-scanned in three axis ,X,Y, Z and two polarity, for radiated measurement. The worst case(Z-Plane) were recorded in this report

### 3.3 FCC PART 15.205 RESTRICTED BANDS OF OPERATIONS

According to FCC 15.231(b), 15.231(e),

(b) In addition to the provisions of §15.205, the field strength of emissions from intentional radiators operated under this section shall not exceed the following:

Fundamental frequency (MHz)	Field strength of fundamental (microvolts/meter)	Field strength of spurious emissions (microvolts/meter)
40.66-40.70	2,250	225
70-130	1,250	125
130-174	<sup>1</sup> 1,250 to 3,750	<sup>1</sup> 125 to 375
174-260	3,750	375
260-470	<sup>1</sup> 3,750 to 12,500	<sup>1</sup> 375 to 1,250
Above 470	12,500	1,250

<sup>1</sup>Linear interpolations.

(1) The above field strength limits are specified at a distance of 3 meters. The tighter limits apply at the band edges.

(2) Intentional radiators operating under the provisions of this section shall demonstrate compliance with the limits on the field strength of emissions, as shown in the above table, based on the average value of the measured emissions. As an alternative, compliance with the limits in the above table may be based on the use of measurement instrumentation with a CISPR quasi-peak detector. The specific method of measurement employed shall be specified in the application for equipment authorization. If average emission measurements are employed, the provisions in §15.35 for averaging pulsed emissions and for limiting peak emissions apply. Further, compliance with the provisions of §15.205 shall be demonstrated using the measurement instrumentation specified in that section.

(3) The limits on the field strength of the spurious emissions in the above table are based on the fundamental frequency of the intentional radiator. Spurious emissions shall be attenuated to the average (or, alternatively, CISPR quasi-peak) limits shown in this table or to the general limits shown in §15.209, whichever limit permits a higher field strength.

(e) Intentional radiators may operate at a periodic rate exceeding that specified in paragraph (a) of this section and may be employed for any type of operation, including operation prohibited in paragraph (a) of this section, provided the intentional radiator complies with the provisions of paragraphs (b) through (d) of this section, except the field strength table in paragraph (b) of this section is replaced by the following:

<b>Fundamental frequency (MHz)</b>	<b>Field strength of fundamental (microvolts/meter)</b>	<b>Field strength of spurious emissions (microvolts/meter)</b>
40.66-40.70	1,000	100
70-130	500	50
130-174	500 to 1,500 <sup>1</sup>	50 to 150 <sup>1</sup>
174-260	1,500	150
260-470	1,500 to 5,000 <sup>1</sup>	150 to 500 <sup>1</sup>
Above 470	5,000	500

<sup>1</sup>Linear interpolations.

In addition, devices operated under the provisions of this paragraph shall be provided with a means for automatically limiting operation so that the duration of each transmission shall not be greater than one second and the silent period between transmissions shall be at least 30 times the duration of the transmission but in no case less than 10 seconds.

Report No.: TMWK2108000552KR

## 3.4 EUT DUTY CYCLE

### 433.66MHz

Temperature: 21.3°C                      Test Date: November 24, 2021  
Humidity: 54% RH                         Tested by: Lance Chen

Duty Cycle			
TX ON (ms)	TX All(ms)	Duty Cycle (%)	Duty Factor(dB)
12.41	100.00	12.41%	-18.12

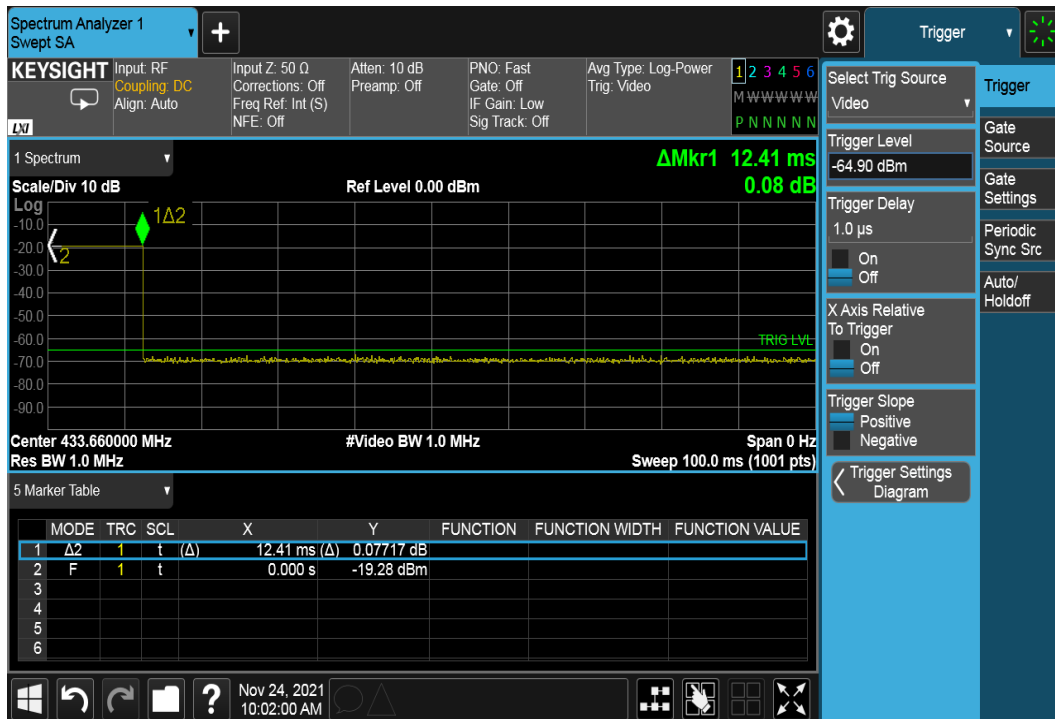

### Notes:

- The transmitter duty cycle was measured using a spectrum analyser in the time domain and calculated by  $20 \log (\text{Time}_{\text{on}} / [\text{Period or } 100 \text{ ms whichever is the lesser}])$
- The EUT transmits for a Time(on) of 12.41 milliseconds.  
 $20 \log (\text{Time}_{\text{on}} / [\text{Period or } 100 \text{ ms whichever is the lesser}])$   
 $20 \log ( 12.41 / 100.00) = -18.12 \text{ dB}$

Report No.: TMWK2108000552KR

## 433.92MHz

Temperature: 21.3°C

Test Date: November 24, 2021

Humidity: 54% RH

Tested by: Lance Chen

Duty Cycle			
TX ON (ms)	TX All(ms)	Duty Cycle (%)	Duty Factor(dB)
10.05	100.00	10.05%	<u>-19.96</u>

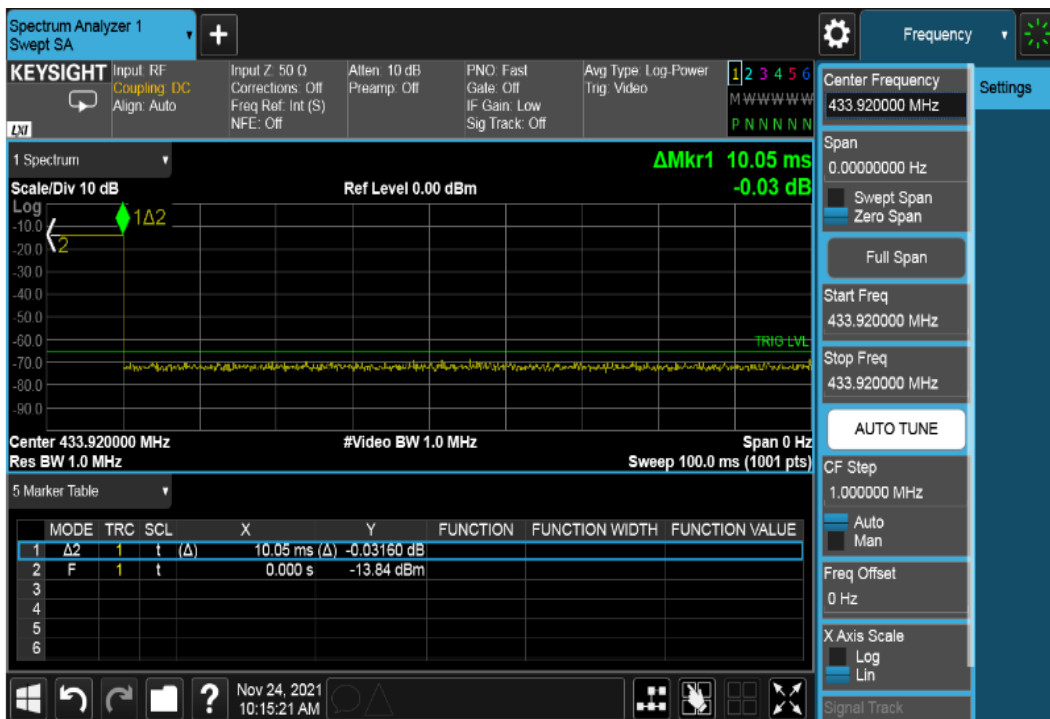

### Notes:

- The transmitter duty cycle was measured using a spectrum analyser in the time domain and calculated by  $20 \log (\text{Time}_{(on)} / [\text{Period or } 100 \text{ ms whichever is the lesser}])$
- The EUT transmits for a  $\text{Time}_{(on)}$  of 10.05 milliseconds.  
 $20 \log (\text{Time}_{(on)} / [\text{Period or } 100 \text{ ms whichever is the lesser}])$ .  
 $20 \log (10.05 / 100.00) = -19.96 \text{ dB}$

Report No.: TMWK2108000552KR

## 4. TEST RESULT

### 4.1 AC POWER LINE CONDUCTED EMISSION

#### 4.1.1 Test Limit

According to §15.207(a), RSS-Gen Sec.8.8,

Frequency Range (MHz)	Limits(dBμV)	
	Quasi-peak	Average
0.15 to 0.50	66 to 56*	56 to 46*
0.50 to 5	56	46
5 to 30	60	50

\* Decreases with the logarithm of the frequency.

#### 4.1.2 Test Procedure

Test method Refer as ANSI 63.10:2013 clause 6.2,

1. The EUT was placed on a table, which is 0.8m above ground plane.
2. Maximum procedure was performed on the six highest emissions to ensure EUT compliance.
3. Repeat above procedures until all frequency measured were complete

#### 4.1.3 Test Setup

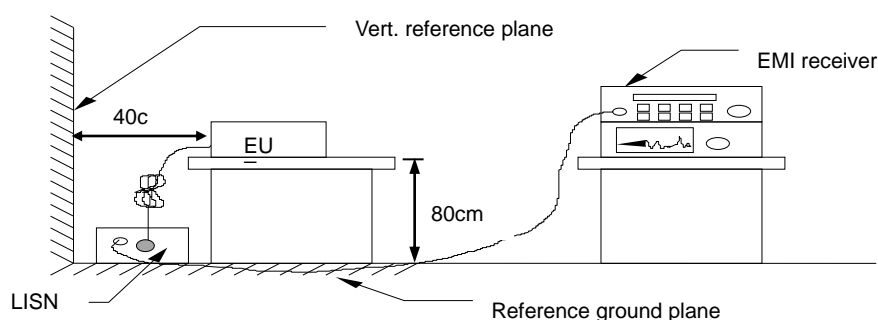

#### 4.1.4 Test Result

Not applicable, because EUT doesn't connect to AC Main Source direct.

## 4.2 EMISSION BANDWIDTH

### 4.2.1 Test Limit

According to §15.231(c), RSS-210 A.1.3,

Limit	<input checked="" type="checkbox"/> 70 MHz – 900 MHz : $F_c * 0.25 \%$ <input type="checkbox"/> Above 900 MHz : $F_c * 0.5 \%$
-------	---

### 4.2.2 Test Procedure

Test method Refer as ANSI 63.10:2013 clause 6.9.2,

SA set RBW = 1% ~ 5% OBW, VBW = three times the RBW and Detector = Peak, Trace mode = Max hold, Sweep = Auto. Measure the maximum width of the emission that is constrained by the frequencies associated with the Occupied Bandwidth (99%) and 20dB Bandwidth.

### 4.2.3 Test Setup

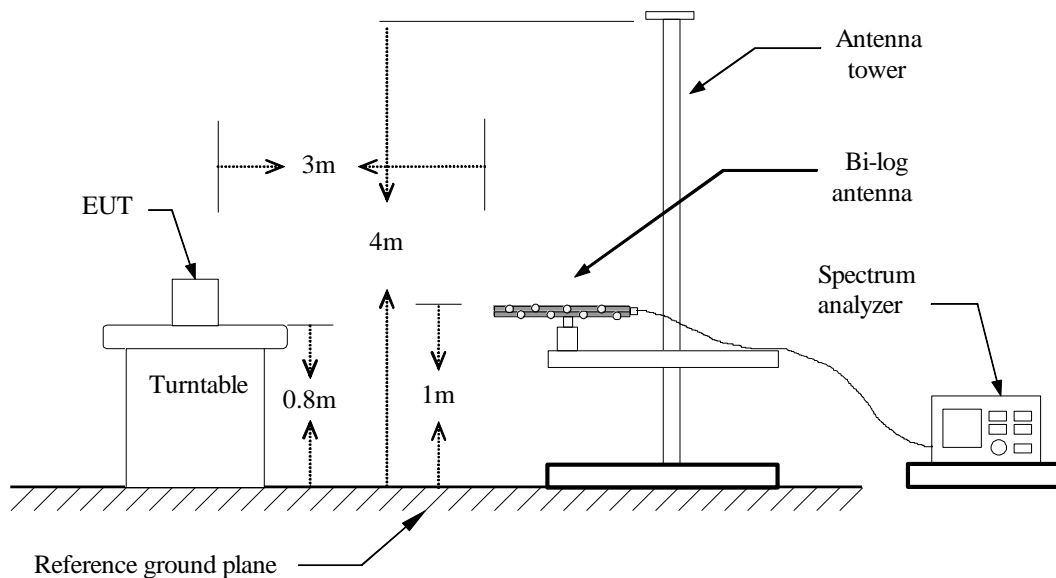



#### 4.2.4 Test Result

**Temperature:** 21.3°C

**Test Date:** November 24, 2021

**Humidity:** 54% RH

**Tested by:** Lance Chen

Spectrum Bandwidth				
Frequency (MHz)	20dB Bandwidth (KHz)	20dB Bandwidth Limits (MHz)	99% Occupied BW (KHz)	99% Bandwidth Limits (MHz)
433.66	50.05	1.04815	49.263	1.04815
433.92	103.3	1.0848	101.66	1.0848

Report No.: TMWK2108000552KR

## Test Data

### 20dB Bandwidth and 99% Occupied BW

#### 433.66MHz

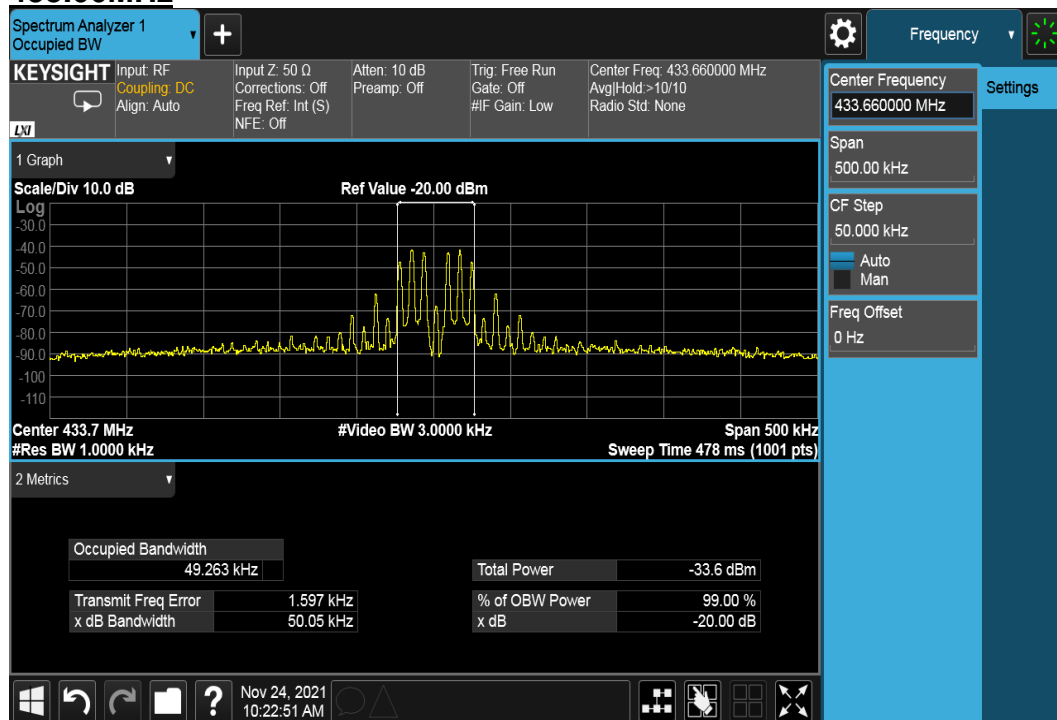

#### 433.92MHz

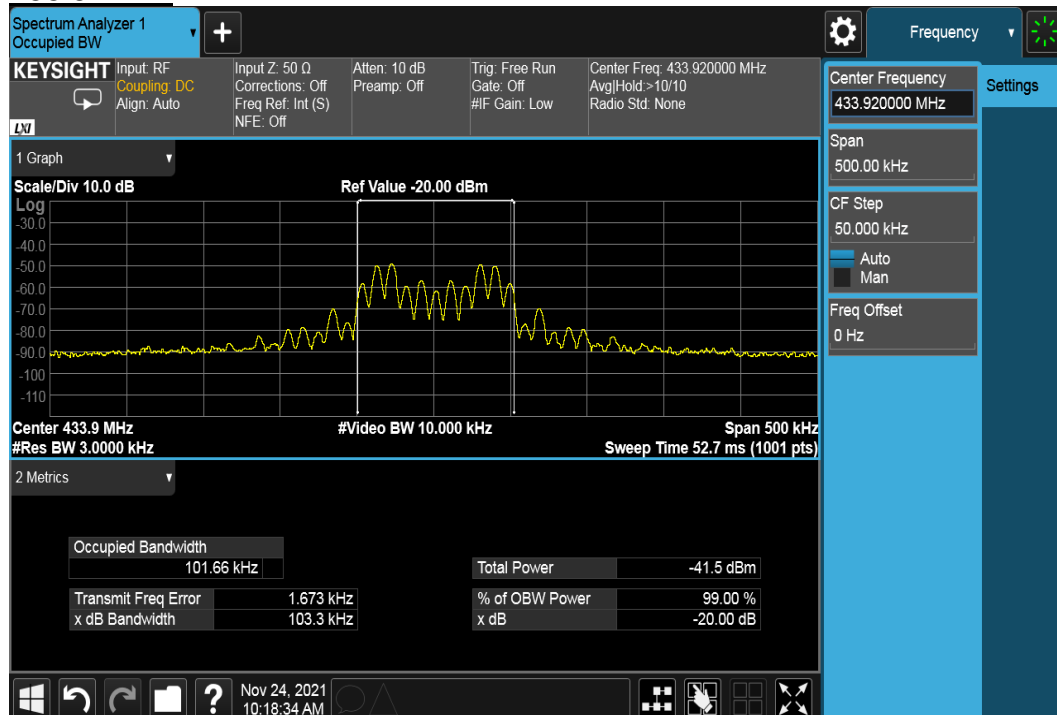

Report No.: TMWK2108000552KR

### 4.3 FIELD STRENGTH OF FUNDAMENTAL

#### 4.3.1 Test Limit

According to §15.231(b)

Fundamental frequency (MHz)	Field strength of fundamental (microvolts/meter)	Field strength of fundamental (microvolts/meter)
40.66-40.70	2,250	225
70-130	1,250	125
130-174	1,250 to 3,750	125 to 375
174-260	3,750	375
260-470	13,750 to 12,500	1375 to 1,250
Above 470	12,500	1,250

\* Linear interpolation with frequency, f, in MHz:

For 130-174 MHz: Field Strength ( $\mu\text{V/m}$ ) =  $(56.82 \times f) - 6136$

For 260-470 MHz: Field Strength ( $\mu\text{V/m}$ ) =  $(41.67 \times f) - 7083$

According to RSS-210 A.1.2

Table A1— Permissible Field Strength Limits for Momentarily Operated Devices	
Fundamental Frequency (MHz), Excluding Restricted Frequency Bands Specified in RSS-Gen	Field Strength of the Fundamental Emissions ( $\mu\text{V/m}$ at 3 m)
70-130	1,250
130-174	1,250 to 3,750*
174-260 (Note 1)	3,750
260-470 (Note 1)	3,750 to 12,500*
Above 470	12,500

\* Linear interpolation with frequency, f, in MHz:

For 130-174 MHz: Field Strength ( $\mu\text{V/m}$ ) =  $(56.82 \times f) - 6136$

For 260-470 MHz: Field Strength ( $\mu\text{V/m}$ ) =  $(41.67 \times f) - 7083$

**Note 1:** Frequency bands 225-328.6 MHz and 335.4-399.9 MHz are designated for the exclusive use of the Government of Canada. Manufacturers should be aware of possible harmful interference and degradation of their licence-exempt radio equipment in these frequency bands.

#### 4.3.2 Test Procedure

Test method Refer as ANSI 63.10:2013 clause 4.1.4 and clause 6.5

clause 4.1.4	<input checked="" type="checkbox"/> 4.1.4.2.2: Measurement Peak value. <input type="checkbox"/> 4.1.4.2.3: Duty cycle $\geq$ 100%. <input checked="" type="checkbox"/> 4.1.4.2.4: Measurement Average value.
--------------	--

### 4.3.3 Test Setup

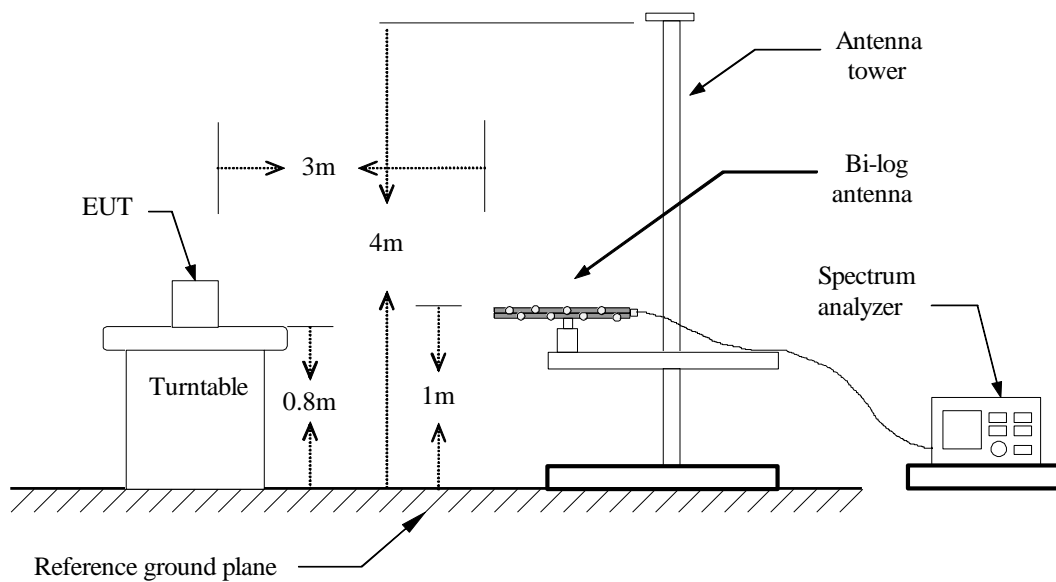

### 4.3.4 Test Result

Field Strength					
Frequency (MHz)	Fundamental (dBuV/m) at 3m	Limit (dBuV/m) at 3m	Margin (dB)	Axis/Pol.	Remark
433.66	68.01	80.82	-12.81	Z/V	AVG

**Remark:**

1. Fundamental measured method setting on spectrum, RBW=100 kHz, VBW=100kHz and Detector=Peak.
2. Average result = Peak result + Duty factor = 86.13dBuV/m -18.12= 68.01 dBuV/m
3. 260MHz ~ 470MHz limit is  $41.67 * (\text{Frequency, MHz}) - 7083$   
 $\text{Limit} = 41.67 * (433.66 \text{ MHz}) - 7083$   
 $= 10987.61220 \text{ (uV/m)}$   
 $\text{dBuV/m} = 20 \text{ Log (uV/m)} = 20 \text{ Log (10987.61220 uV/m)} = 80.82 \text{ dBuV/m}$

Field Strength					
Frequency (MHz)	Fundamental (dBuV/m) at 3m	Limit (dBuV/m) at 3m	Margin (dB)	Axis/Pol.	Remark
433.92	64.63	80.82	-16.19	Z/V	AVG

**Remark:**

1. Fundamental measured method setting on spectrum, RBW=100 kHz, VBW=100kHz and Detector=Peak.
2. Average result = Peak result + Duty factor =84.59 dBuV/m -19.96 = 64.63 dBuV/m
3. 260MHz ~ 470MHz limit is  $41.67 * (\text{Frequency, MHz}) - 7083$   
 $\text{Limit} = 41.67 * (433.92 \text{ MHz}) - 7083$   
 $= 10998.44640 \text{ (uV/m)}$   
 $\text{dBuV/m} = 20 \text{ Log (uV/m)} = 20 \text{ Log (10998.44640 uV/m)} = 80.82\text{dBuV/m}$

Report No.: TMWK2108000552KR

## Test Data

Test Mode:	TX-433.66MHz	Temp/Hum	20.0(°C)/ 55%RH
Test Item	Fundamental	Test Date	November 24, 2021
Axis/Polarize	Z-Plane / Ver.	Test Engineer	Jerry Chang
Detector	Peak & AVG		

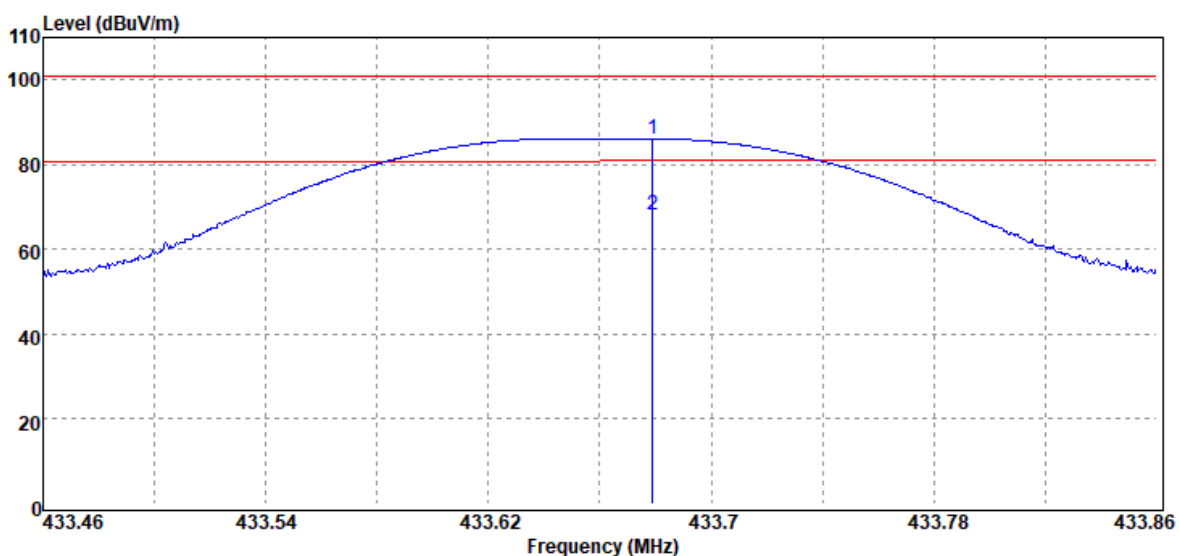

No	Frequency (MHz)	Detector Mode (PK/QP/AV)	Spectrum Reading Level (dBuV)	Factor (dB)	Actual FS (dBuV/m)	Limit @3m (dBuV/m)	Margin (dB)
1	433.68	Peak	90.98	-4.85	86.13	100.82	-14.69
2	433.68	Average	-	-18.12	68.01	80.82	-12.81

Note:

Average result = Peak result + Duty factor = 86.13 dBuV/m - 18.12 = 68.01 dBuV/m

Report No.: TMWK2108000552KR

Test Mode:	TX-433.66MHz	Temp/Hum	20.0(°C)/ 55%RH
Test Item	Fundamental	Test Date	November 24, 2021
Axis/Polarize	Z-Plane / Hor.	Test Engineer	Jerry Chang
Detector	Peak & AVG		

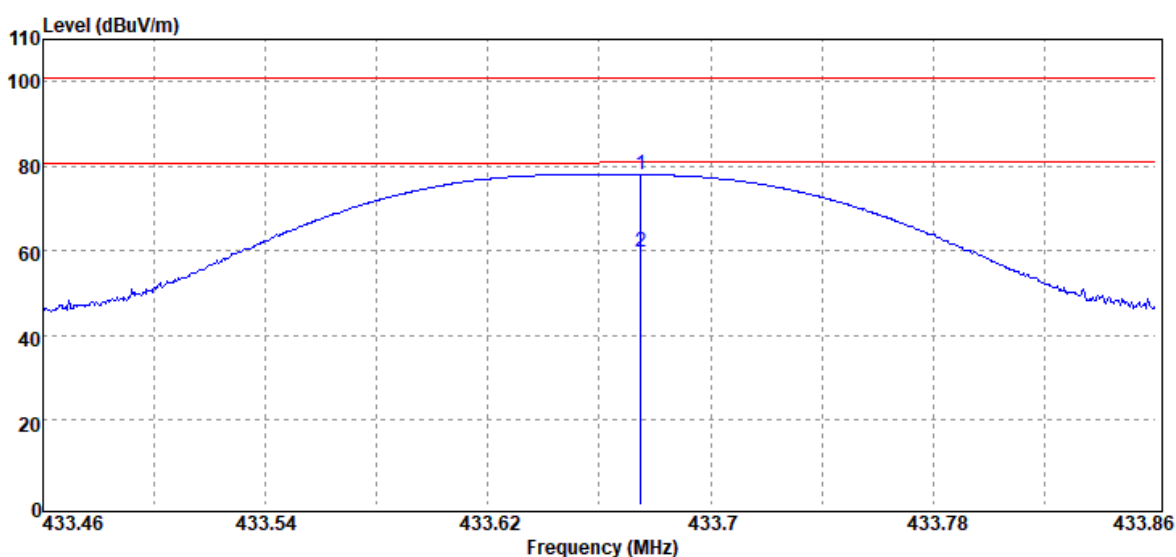

No	Frequency (MHz)	Detector Mode (PK/QP/AV)	Spectrum Reading Level (dBuV)	Factor (dB)	Actual FS (dBuV/m)	Limit @3m (dBuV/m)	Margin (dB)
1	433.68	Peak	82.81	-4.85	77.96	100.82	-22.86
2	433.68	Average	-	-18.12	59.84	80.82	-20.98

Note:

Average result = Peak result + Duty factor = 77.96 dBuV/m -18.12= 59.84 dBuV/m

Report No.: TMWK2108000552KR

Test Mode:	TX-433.92MHz	Temp/Hum	20.0(°C)/ 55%RH
Test Item	Fundamental	Test Date	November 24, 2021
Axis/Polarize	Z-Plane / Ver.	Test Engineer	Jerry Chang
Detector	Peak & AVG		

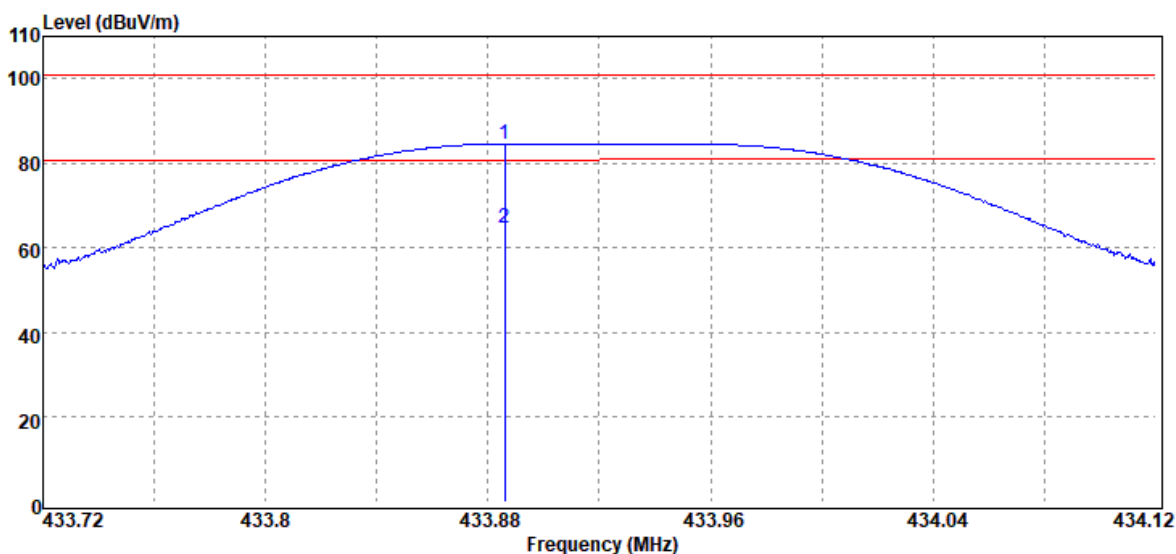

No	Frequency (MHz)	Detector Mode (PK/QP/AV)	Spectrum Reading Level (dBuV)	Factor (dB)	Actual FS (dBuV/m)	Limit @3m (dBuV/m)	Margin (dB)
1	433.89	Peak	89.43	-4.84	84.59	100.82	-16.23
2	433.89	Average	-	-19.96	64.63	80.82	-16.19

Note:

Average result = Peak result + Duty factor = 84.59 dBuV/m -19.96= 64.63 dBuV/m



Test Mode:	TX-433.66MHz	Temp/Hum	20.0(°C)/ 55%RH
Test Item	Fundamental	Test Date	November 24, 2021
Axis/Polarize	Z-Plane / Hor.	Test Engineer	Jerry Chang
Detector	Peak & AVG		

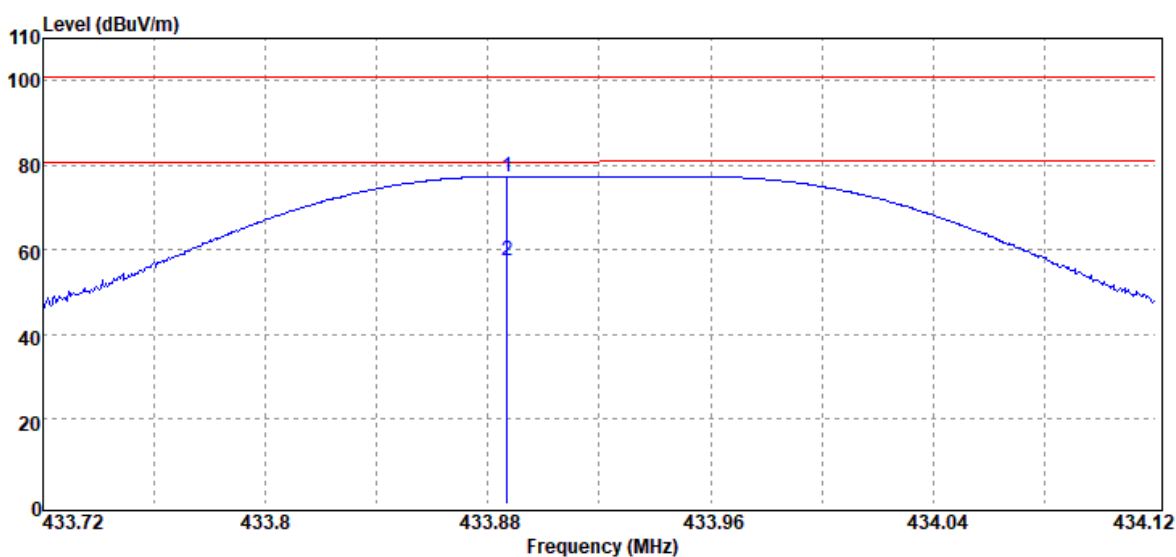

No	Frequency (MHz)	Detector Mode (PK/QP/AV)	Spectrum Reading Level (dBuV)	Factor (dB)	Actual FS (dBuV/m)	Limit @3m (dBuV/m)	Margin (dB)
1	433.89	Peak	82.27	-4.84	77.43	100.82	-23.39
2	433.89	Average	-	-19.96	57.47	80.82	-23.35

Note:

Average result = Peak result + Duty factor = 77.43 dBuV/m - 19.96 = 57.47 dBuV/m

Report No.: TMWK2108000552KR

## 4.4 RADIATION UNWANTED EMISSION

### 4.4.1 Test Limit

According to §15.231(b) and §15.209, §15.205

Unwanted emissions limit follow the table or the FCC Part 15.209, whichever limit permits higher field strength.

According to §15.231(b)

Fundamental frequency (MHz)	Field strength of fundamental (microvolts/meter)	Field strength of fundamental (microvolts/meter)
40.66-40.70	2,250	225
70-130	1,250	125
130-174	<sup>1</sup> 1,250 to 3,750	<sup>1</sup> 125 to 375
174-260	3,750	375
260-470	<sup>1</sup> 3,750 to 12,500	<sup>1</sup> 375 to 1,250
Above 470	12,500	1,250

<sup>1</sup>Linear interpolations.

According to RSS-210 A1.2 and RSS-GEN Sec. 8.9

Unwanted emissions shall comply with the general field strength limits specified in RSS-Gen or 10 times below the fundamental emissions field strength limit in table as below, whichever is less stringent.

According to RSS-210 A.1.4(d)

Fundamental frequency (MHz)	Field strength of Spurious emission (uv/m) at 3m	Field strength of Spurious emission (dBuv/m) at 3m
40.66-40.70	225	47
70-130	125	41.9
*130-174	*125-375	41.9-51.5
174-260	375	51.5
*260-470	*375-1250	51.5-61.9
Above 470	1250	61.9

<sup>1</sup>Linear interpolations.

**Below 30MHz**

Frequency (MHz)	Field Strength				
	( $\mu\text{V/m}$ )	( $\text{dB}\mu\text{V/m}$ )	Measurement Distance (meter)	( $\text{dB}\mu\text{V/m}$ )	Measurement Distance (meter)
0.009 - 0.490	2400/F(kHz)	48.52 – 13.80	300	128.52–104.84	3
0.490 - 1.705	24000/F(kHz)	33.80 – 22.97	30	73.80– 62.97	3
1.705 – 30.0	30	29.54	30	69.54	3

**Above 30MHz**

Frequency (MHz)	Field Strength		Measurement Distance (meter)
	( $\mu\text{V/m}$ )	( $\text{dB}\mu\text{V/m}$ )	
30-88	100	40.0	3
88-216	150	43.5	3
216-960	200	46.0	3
Above 960	500	54.0	3



### 4.4.3 Test Setup

#### 9kHz ~ 30MHz

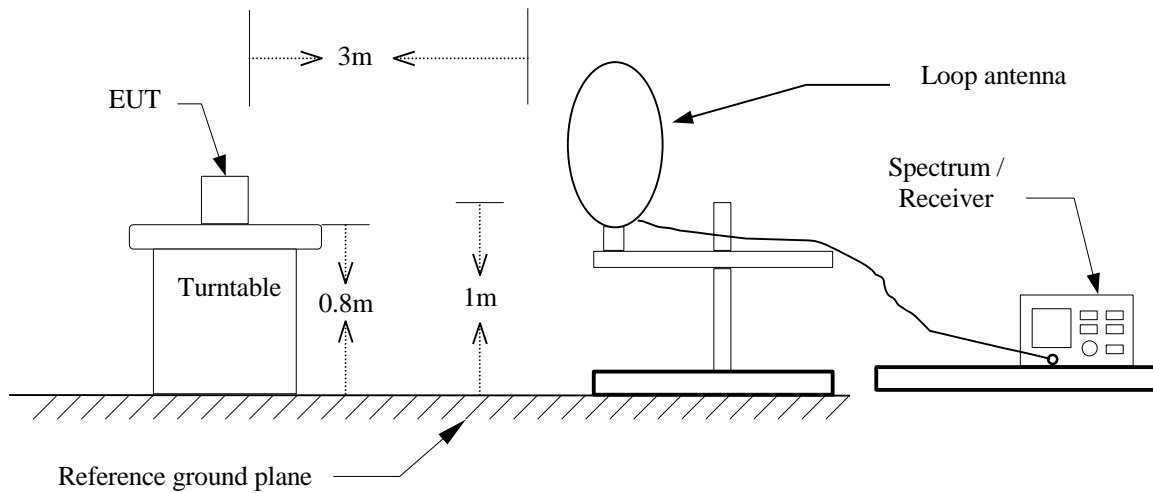

#### 30MHz ~ 1 GHz

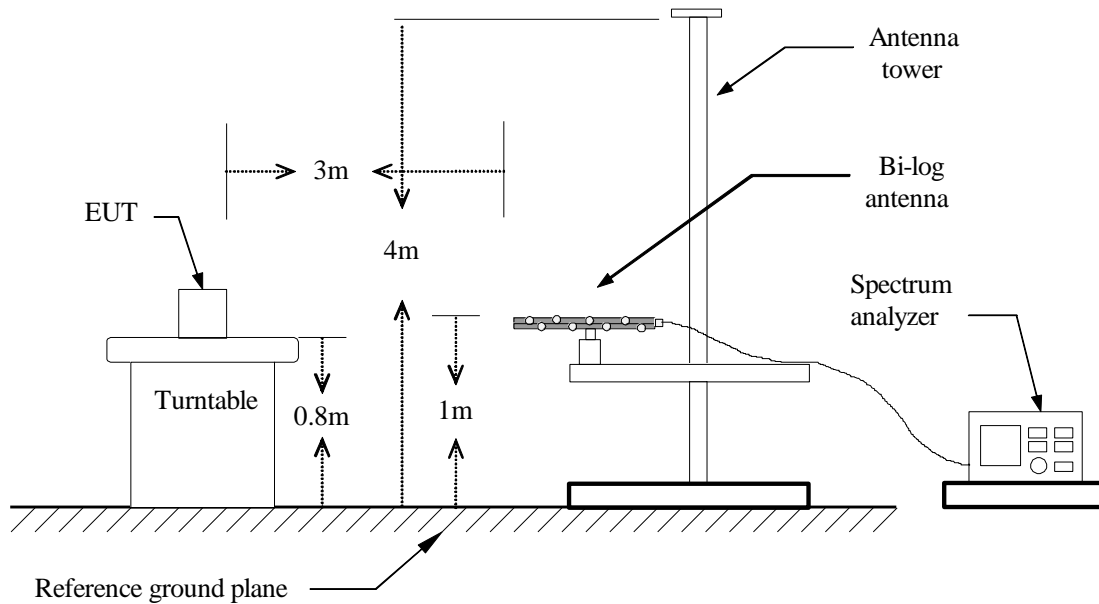

Report No.: TMWK2108000552KR

## Above 1 GHz

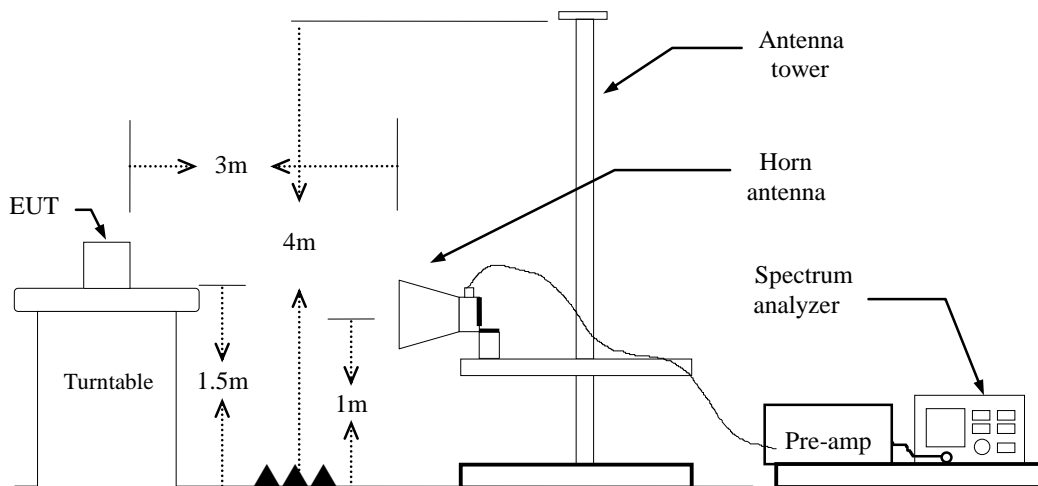

### 4.4.4 Test Result

Pass.

Report No.: TMWK2108000552KR

**Below 1GHz**

Test Mode:	TX-433.66MHz	Temp/Hum	23.3(°C)/ 59%RH
Test Item	Below 1GHz	Test Date	September 14, 2021
Polarize	Vertical	Test Engineer	Jerry Chang
Detector	Peak		

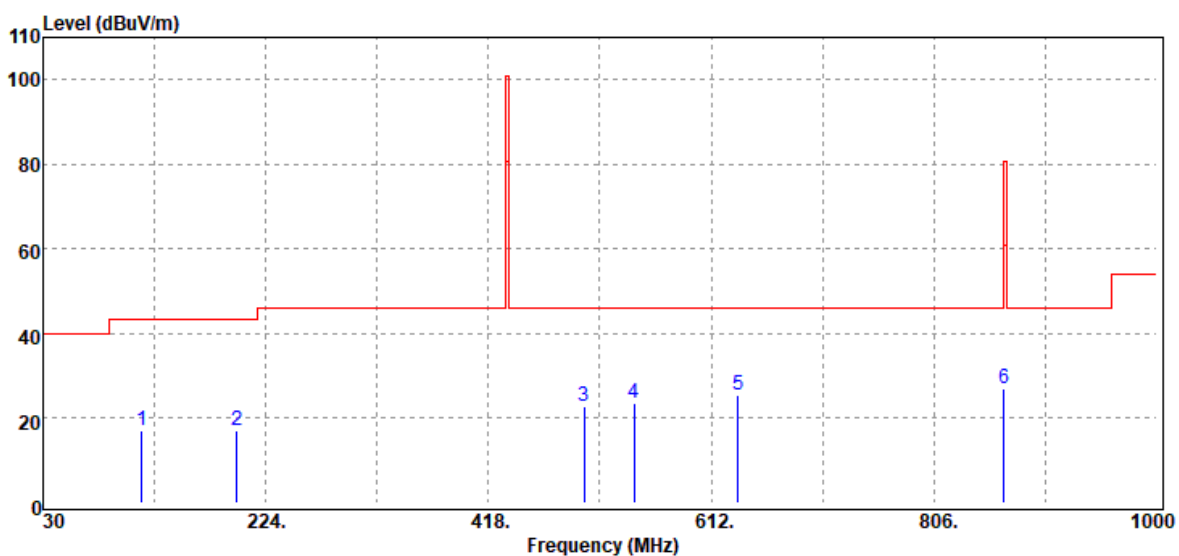

Frequency (MHz)	Detector Mode (PK/QP/AV)	Spectrum Reading Level (dBuV)	Factor (dB)	Actual FS (dBuV/m)	Limit @3m (dBuV/m)	Margin (dB)
116.33	Peak	26.78	-9.62	17.16	43.50	-26.34
198.78	Peak	26.83	-9.82	17.01	43.50	-26.49
501.42	Peak	26.08	-3.39	22.69	46.00	-23.31
545.07	Peak	26.54	-2.79	23.75	46.00	-22.25
635.28	Peak	26.23	-0.59	25.64	46.00	-20.36
867.32	Peak	24.65	2.49	27.14	80.82	-53.68

Report No.: TMWK2108000552KR

Test Mode:	TX-433.66MHz	Temp/Hum	23.3(°C)/ 59%RH
Test Item	Below 1GHz	Test Date	September 14, 2021
Polarize	Horizontal	Test Engineer	Jerry Chang
Detector	Peak		

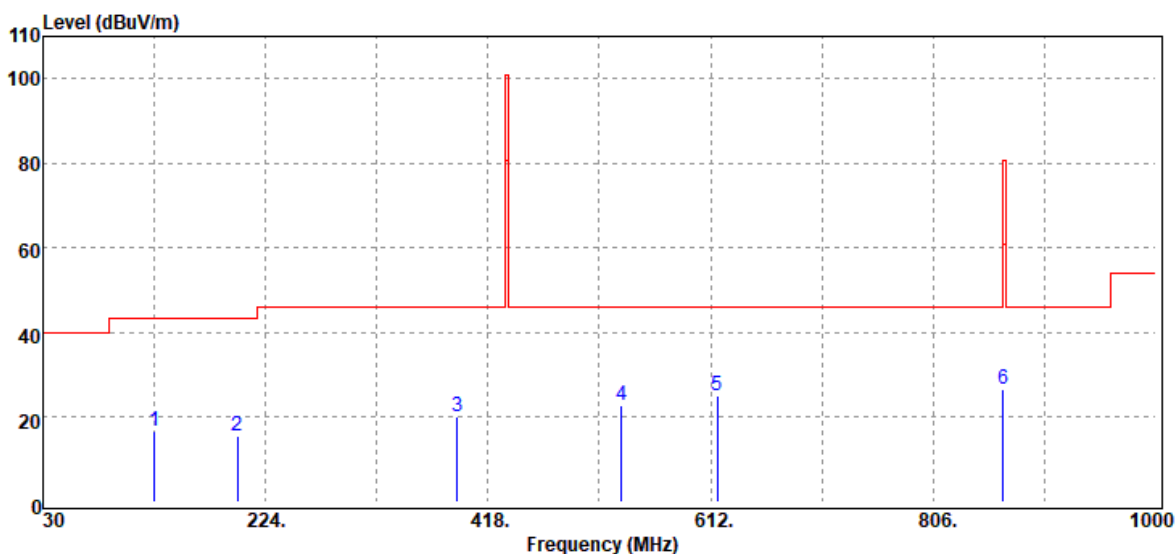

Frequency (MHz)	Detector Mode (PK/QP/AV)	Spectrum Reading Level (dBuV)	Factor (dB)	Actual FS (dBuV/m)	Limit @3m (dBuV/m)	Margin (dB)
127.00	Peak	25.93	-9.12	16.81	43.50	-26.69
199.75	Peak	25.20	-9.72	15.48	43.50	-28.02
390.84	Peak	26.70	-6.40	20.30	46.00	-25.70
534.40	Peak	25.86	-2.85	23.01	46.00	-22.99
617.82	Peak	26.60	-1.48	25.12	46.00	-20.88
867.32	Peak	24.28	2.49	26.77	80.82	-54.05



Test Mode:	TX-433.92MHz	Temp/Hum	23.3(°C)/ 59%RH
Test Item	Below 1GHz	Test Date	September 14, 2021
Polarize	Vertical	Test Engineer	Jerry Chang
Detector	Peak		

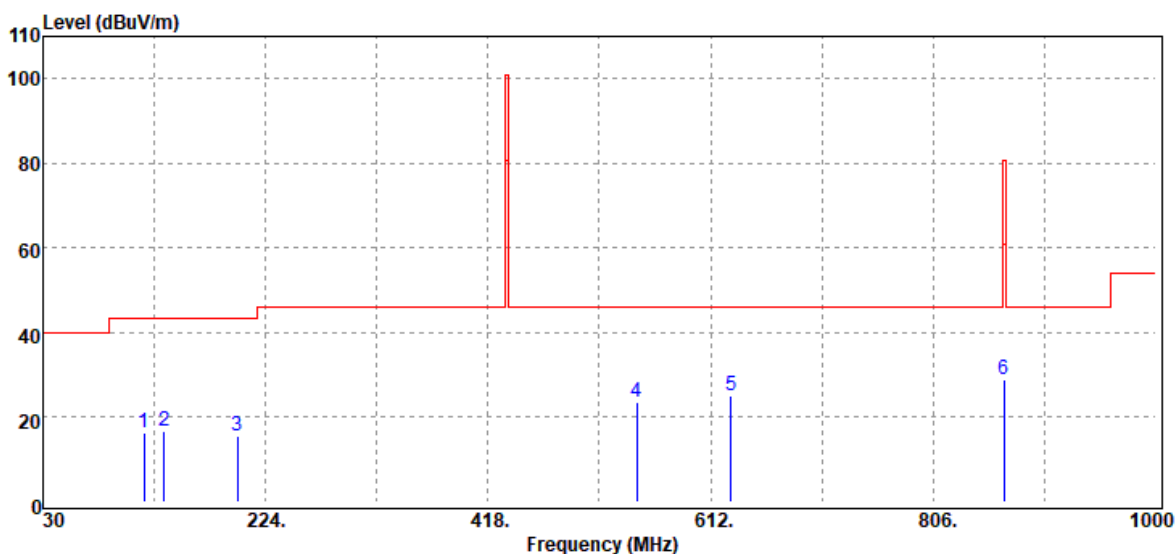

Frequency (MHz)	Detector Mode (PK/QP/AV)	Spectrum Reading Level (dBuV)	Factor (dB)	Actual FS (dBuV/m)	Limit @3m (dBuV/m)	Margin (dB)
118.27	Peak	25.87	-9.40	16.47	43.50	-27.03
135.73	Peak	26.34	-9.62	16.72	43.50	-26.78
199.75	Peak	25.26	-9.72	15.54	43.50	-27.96
547.98	Peak	26.36	-2.71	23.65	46.00	-22.35
629.46	Peak	25.84	-0.89	24.95	46.00	-21.05
867.84	Peak	26.56	2.47	29.03	80.82	-51.79

Report No.: TMWK2108000552KR

Test Mode:	TX-433.92MHz	Temp/Hum	23.3(°C)/ 59%RH
Test Item	Below 1GHz	Test Date	September 14, 2021
Polarize	Horizontal	Test Engineer	Jerry Chang
Detector	Peak		

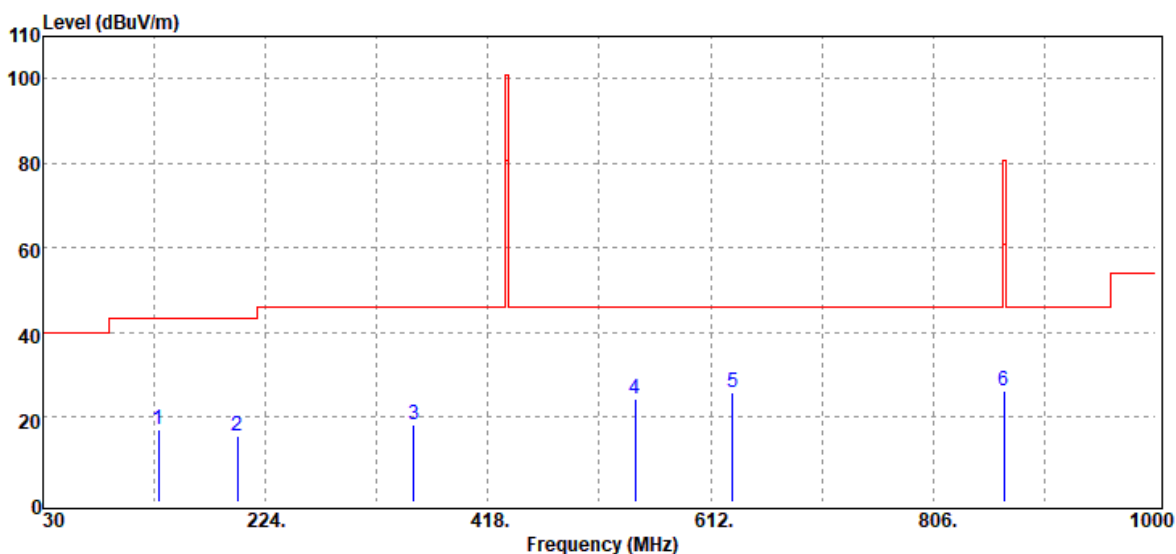

Frequency (MHz)	Detector Mode (PK/QP/AV)	Spectrum Reading Level (dBuV)	Factor (dB)	Actual FS (dBuV/m)	Limit @3m (dBuV/m)	Margin (dB)
130.43	Peak	26.24	-9.12	17.12	43.50	-26.38
199.30	Peak	25.20	-9.76	15.44	43.50	-28.06
353.53	Peak	25.85	-7.41	18.44	46.00	-27.56
546.56	Peak	27.14	-2.75	24.39	46.00	-21.61
630.95	Peak	26.55	-0.82	25.73	46.00	-20.27
867.84	Peak	23.64	2.47	26.11	80.82	-54.71

Report No.: TMWK2108000552KR

### Above 1GHz

Test Mode:	TX-433.66MHz	Temp/Hum	23.3(°C)/ 59%RH
Test Item	Above 1GHz	Test Date	September 14, 2021
Polarize	Vertical	Test Engineer	Jerry Chang
Detector	Peak		

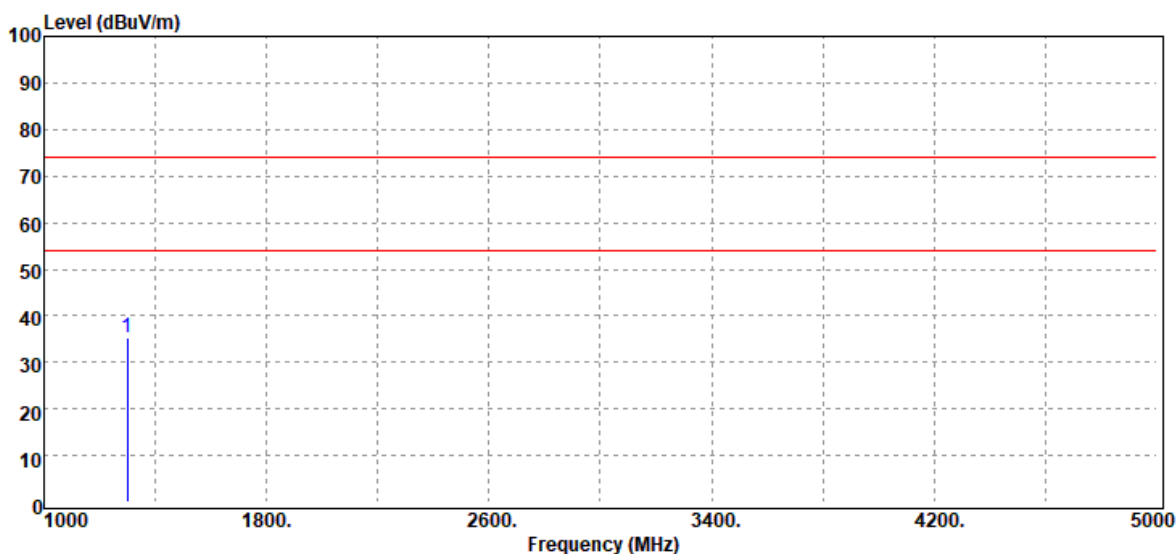

Frequency (MHz)	Detector Mode (PK/QP/AV)	Spectrum Reading Level (dBuV)	Factor (dB)	Actual FS (dBuV/m)	Limit @3m (dBuV/m)	Margin (dB)
1300.98	Peak	41.02	-5.69	35.33	74.00	-38.67
N/A						

**Remark:**

1. Measuring frequencies from 1 GHz to the 10th harmonic of highest fundamental frequency.

Test Mode:	TX-433.66MHz	Temp/Hum	23.3(°C)/ 59%RH
Test Item	Above 1GHz	Test Date	September 14, 2021
Polarize	Horizontal	Test Engineer	Jerry Chang
Detector	Peak		

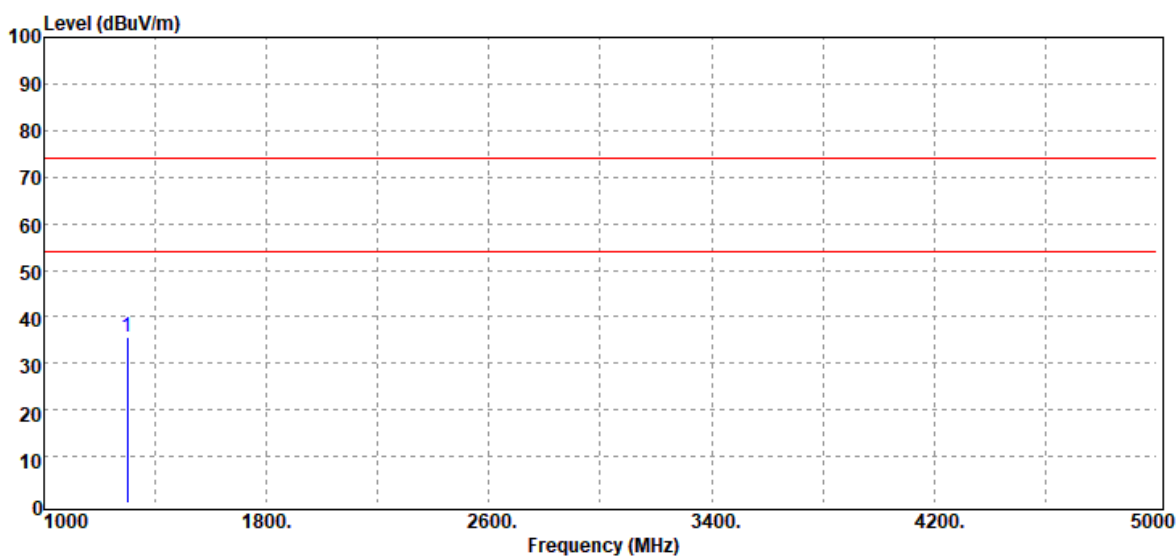

Frequency (MHz)	Detector Mode (PK/QP/AV)	Spectrum Reading Level (dBuV)	Factor (dB)	Actual FS (dBuV/m)	Limit @3m (dBuV/m)	Margin (dB)
1300.98	Peak	41.18	-5.69	35.49	74.00	-38.51
N/A						

**Remark:**

1. Measuring frequencies from 1 GHz to the 10th harmonic of highest fundamental frequency.

Report No.: TMWK2108000552KR

Test Mode:	TX-433.92MHz	Temp/Hum	23.3(°C)/ 59%RH
Test Item	Above 1GHz	Test Date	September 14, 2021
Polarize	Vertical	Test Engineer	Jerry Chang
Detector	Peak		

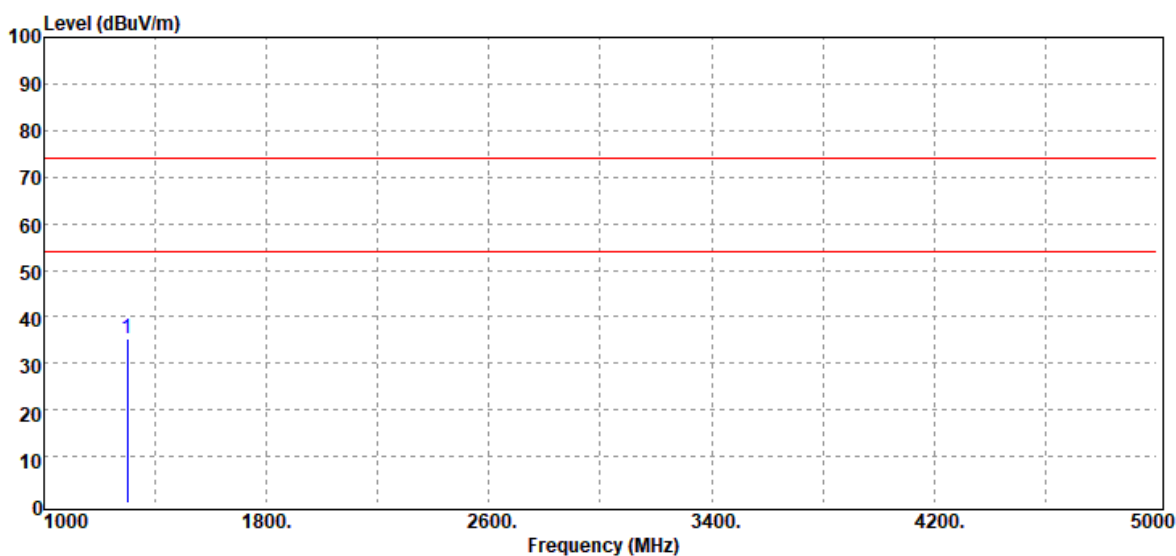

Frequency (MHz)	Detector Mode (PK/QP/AV)	Spectrum Reading Level (dBuV)	Factor (dB)	Actual FS (dBuV/m)	Limit @3m (dBuV/m)	Margin (dB)
1301.76	Peak	42.34	-5.69	36.65	74.00	-37.35
N/A						

**Remark:**

1. Measuring frequencies from 1 GHz to the 10th harmonic of highest fundamental frequency.

Report No.: TMWK2108000552KR

Test Mode:	TX-433.92MHz	Temp/Hum	23.3(°C)/ 59%RH
Test Item	Above 1GHz	Test Date	September 14, 2021
Polarize	Horizontal	Test Engineer	Jerry Chang
Detector	Peak		

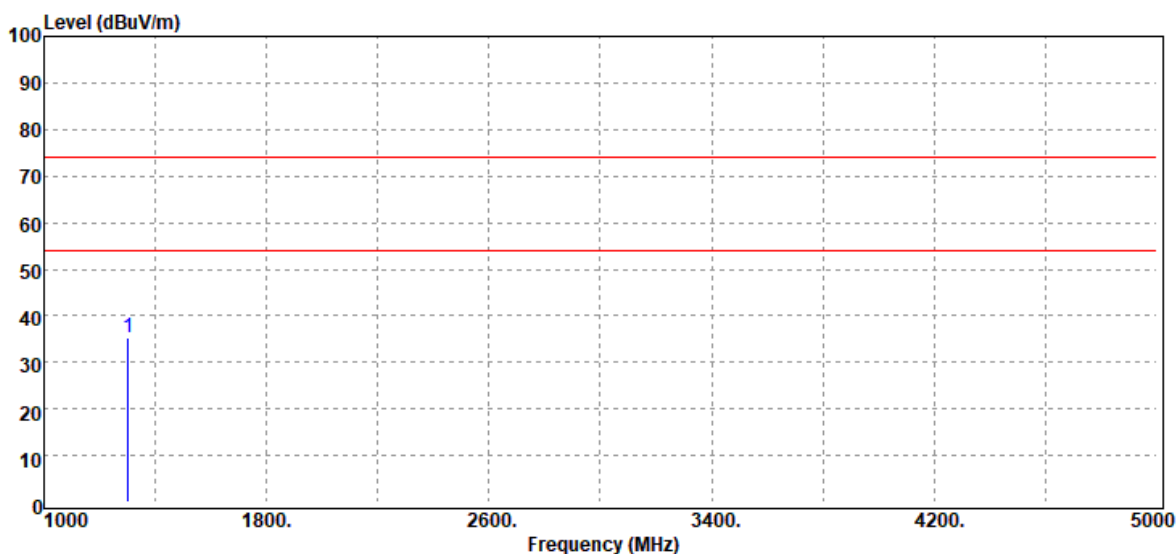

Frequency (MHz)	Detector Mode (PK/QP/AV)	Spectrum Reading Level (dBuV)	Factor (dB)	Actual FS (dBuV/m)	Limit @3m (dBuV/m)	Margin (dB)
1301.76	Peak	41.01	-5.69	35.32	74.00	-38.68
N/A						

**Remark:**

1. Measuring frequencies from 1 GHz to the 10th harmonic of highest fundamental frequency.

Report No.: TMWK2108000552KR

## 4.5 OPERATION RESTRICTION

### 4.5.1 Test Limit

15.231(a)(1),

A manually operated transmitter shall employ a switch that will automatically deactivate the transmitter within not more than 5 seconds of being released.

RSS-210 A1.2,

However, devices that are designed for limited use for the purpose of initial programming, reprogramming or installing, and not for regular operations, may operate for up to 5 seconds, provided such devices are used only occasionally in connection with each unit being programmed or installed.

### 4.5.2 Test Procedure

Test method Refer as ANSI 63.10:2013 clause 7.4

The Loop antenna connected to the spectrum analyzer, was touching to the transmitter antenna. Set the RBW=1MHz, VBW=1MHz, Detector = Peak, Trace mode = Max hold, Sweep = 1s. Measure

### 4.5.3 Test Setup

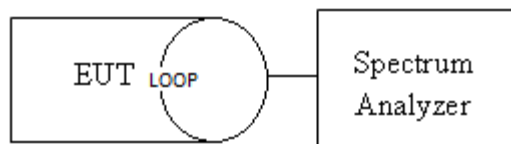

### 4.5.4 Test Result

Temperature: 21.3°C

Test Date: November 24 2021

Humidity: 54% RH

Tested by: Lance Chen

Dwell Time			
Operation condition (manually operated)	Pulse On Time (ms)	Limits	Result
433.66 MHz	12.5	5 sec	PASS
433.92 MHz	10.5	5 sec	PASS

## Test Data

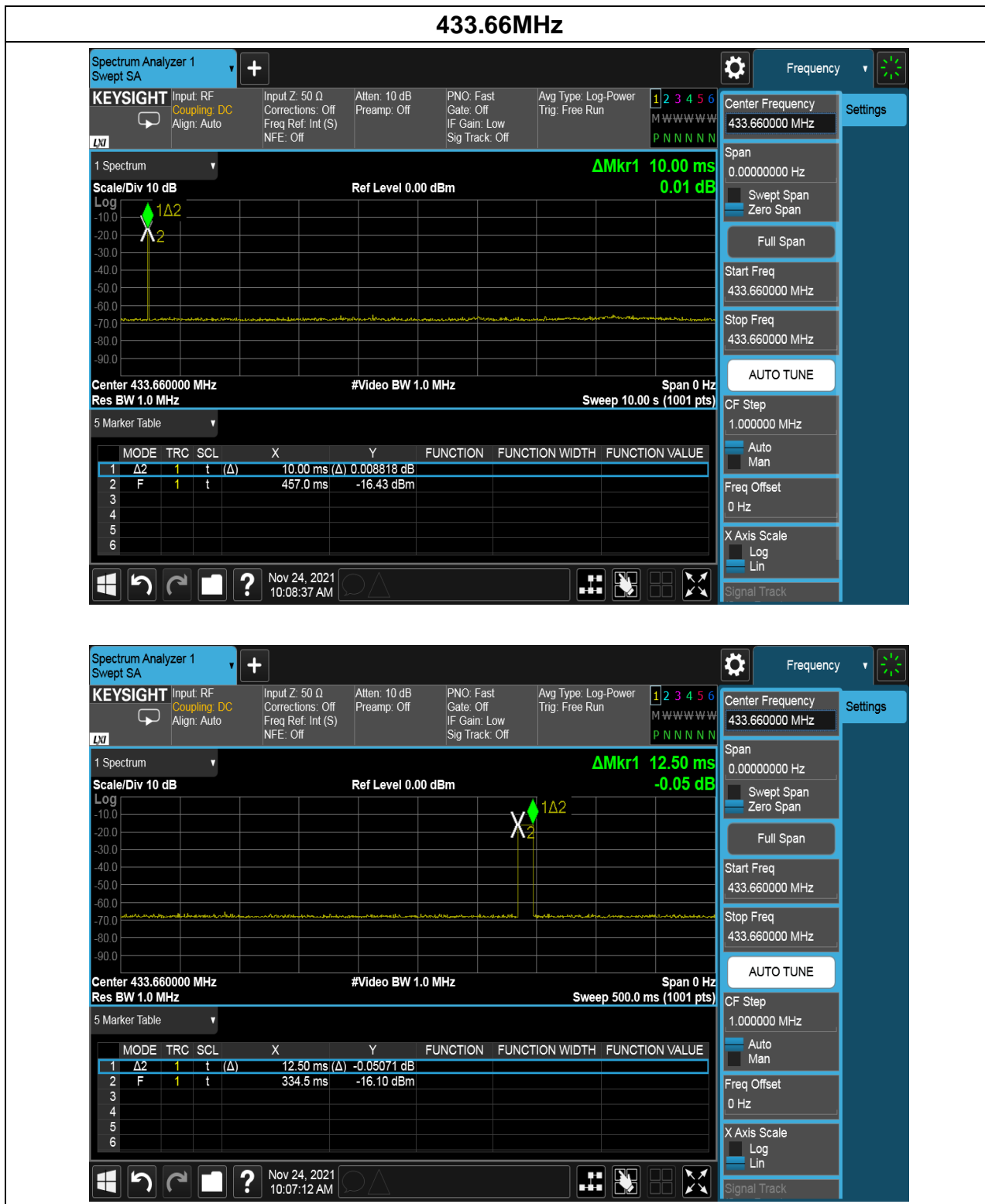



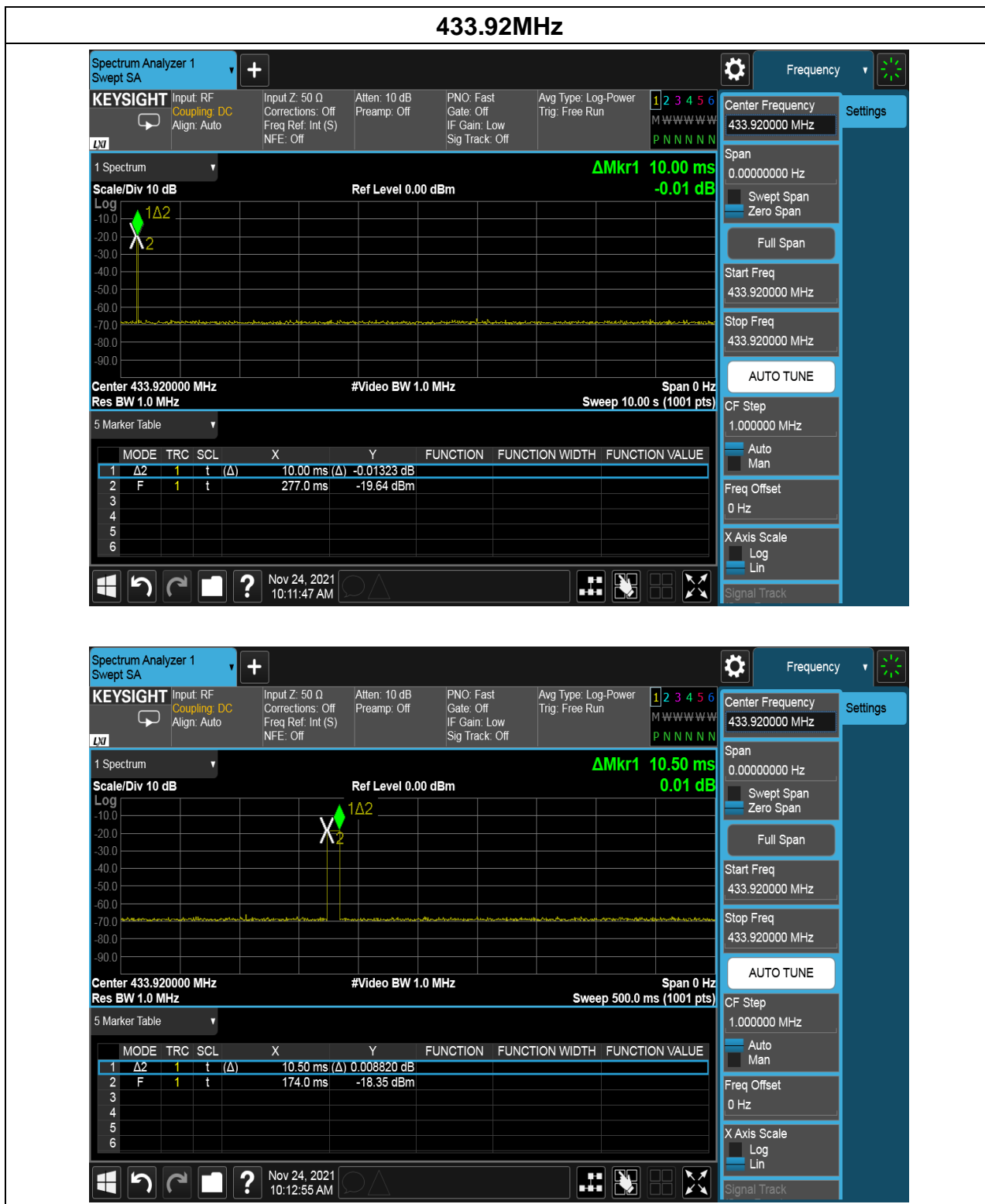

## 4.6 ANTENNA REQUIREMENT

### § 15.203 Antenna requirement.

An intentional radiator shall be designed to ensure that no antenna other than that furnished by the responsible party shall be used with the device. The use of a permanently attached antenna or of an antenna that uses a unique coupling to the intentional radiator shall be considered sufficient to comply with the provisions of this section. The manufacturer may design the unit so that a broken antenna can be replaced by the user, but the use of a standard antenna jack or electrical connector is prohibited. This requirement does not apply to carrier current devices or to devices operated under the provisions of §15.211, §15.213, §15.217, §15.219, or §15.221. Further, this requirement does not apply to intentional radiators that must be professionally installed, such as perimeter protection systems and some field disturbance sensors, or to other intentional radiators which, in accordance with §15.31(d), must be measured at the installation site. However, the installer shall be responsible for ensuring that the proper antenna is employed so that the limits in this part are not exceeded.

**- End of Test Report -**