

CETECOM™

CETECOM ICT Services
consulting - testing - certification >>>

TEST REPORT

Test report no.: 1-0493/15-01-06



Deutsche
Akkreditierungsstelle
D-PL-12076-01-00

Testing laboratory

CETECOM ICT Services GmbH

Untertuerkheimer Strasse 6 – 10

66117 Saarbruecken / Germany

Phone: + 49 681 5 98 - 0

Fax: + 49 681 5 98 - 9075

Internet: <http://www.cetecom.com>

e-mail: ict@cetecom.com

Accredited Testing Laboratory:

The testing laboratory (area of testing) is accredited according to DIN EN ISO/IEC 17025 (2005) by the Deutsche Akkreditierungsstelle GmbH (DAkkS)

The accreditation is valid for the scope of testing procedures as stated in the accreditation certificate with the registration number: D-PL-12076-01-00

Applicant

Continental Automotive GmbH

Siemensstrasse 12

93055 Regensburg / GERMANY

Phone: +49 (0) 941 790-0

Fax: +49 941 790-133554

Contact: Thomas Heselberger

e-mail: Thomas.heselberger@continental-corporation.com

Phone: +49 941 790-3554

Manufacturer

Continental Automotive GmbH

Siemensstrasse 12

93055 Regensburg / GERMANY

Test standard/s

47 CFR Part 15

Title 47 of the Code of Federal Regulations; Chapter I; Part 15 - Radio frequency devices

RSS - 210 Issue 8

Spectrum Management and Telecommunications Radio Standards Specification - Licence-exempt Radio Apparatus (All Frequency Bands): Category I Equipment

For further applied test standards please refer to section 3 of this test report.

Test Item

Kind of test item: WPC, NFC, GSM Coupler

Model name: D-WMI 2015 A

FCC ID: KR5DWMI2015A

IC: 7812D-DWMI2015A

Frequency: 13.56 MHz

Technology tested: NFC

Antenna: Integrated & external antenna

Power supply: 8.0 V to 16.0 V AC

Temperature range: -20°C to +40°C



This test report is electronically signed and valid without handwriting signature. For verification of the electronic signatures, the public keys can be requested at the testing laboratory.

Test report authorized:

Stefan Bös
Lab Manager
Radio Communications & EMC

Test performed:

David Lang
Lab Manager
Radio Communications & EMC

1 Table of contents

1 Table of contents2

2 General information3

 2.1 Notes and disclaimer3

 2.2 Application details.....3

3 Test standard/s3

 3.1 Measurement guidance.....4

4 Test environment.....5

5 Test item5

 5.1 General description5

 5.2 Additional information5

6 Test laboratories sub-contracted5

7 Description of the test setup6

 7.1 Shielded semi anechoic chamber.....7

 7.2 Shielded fully anechoic chamber8

 7.3 Radiated measurements RF laboratory9

 7.4 Frequency error10

8 Sequence of testing11

 8.1 Sequence of testing radiated spurious 9 kHz to 30 MHz.....11

 8.2 Sequence of testing radiated spurious 30 MHz to 1 GHz.....12

9 Measurement uncertainty13

10 Summary of measurement results.....14

11 Additional comments14

12 Measurement results15

 12.1 Timing of the transmitter.....15

 12.2 Occupied bandwidth.....17

 12.3 Field strength of the fundamental19

 12.4 Field strength of the harmonics and spurious20

 12.5 Frequency error25

13 Observations26

Annex A Document history26

Annex B Further information.....26

Annex C Accreditation Certificate27

2 General information

2.1 Notes and disclaimer

The test results of this test report relate exclusively to the test item specified in this test report. CETECOM ICT Services GmbH does not assume responsibility for any conclusions and generalizations drawn from the test results with regard to other specimens or samples of the type of the equipment represented by the test item. The test report may only be reproduced or published in full. Reproduction or publication of extracts from the report requires the prior written approval of CETECOM ICT Services GmbH.

The testing service provided by CETECOM ICT Services GmbH has been rendered under the current "General Terms and Conditions for CETECOM ICT Services GmbH".

CETECOM ICT Services GmbH will not be liable for any loss or damage resulting from false, inaccurate, inappropriate or incomplete product information provided by the customer.

Under no circumstances does the CETECOM ICT Services GmbH test report include any endorsement or warranty regarding the functionality, quality or performance of any other product or service provided.

Under no circumstances does the CETECOM ICT Services GmbH test report include or imply any product or service warranties from CETECOM ICT Services GmbH, including, without limitation, any implied warranties of merchantability, fitness for purpose, or non-infringement, all of which are expressly disclaimed by CETECOM ICT Services GmbH.

All rights and remedies regarding vendor's products and services for which CETECOM ICT Services GmbH has prepared this test report shall be provided by the party offering such products or services and not by CETECOM ICT Services GmbH.

In no case this test report can be considered as a Letter of Approval.

This test report is electronically signed and valid without handwritten signature. For verification of the electronic signatures, the public keys can be requested at the testing laboratory.

2.2 Application details

Date of receipt of order:	2015-09-17
Date of receipt of test item:	2015-09-23
Start of test:	2015-09-23
End of test:	2015-10-16
Person(s) present during the test:	-/-

3 Test standard/s

Test standard	Date	Test standard description
47 CFR Part 15		Title 47 of the Code of Federal Regulations; Chapter I; Part 15 - Radio frequency devices
RSS - 210 Issue 8	December 2010	Spectrum Management and Telecommunications Radio Standards Specification - Licence-exempt Radio Apparatus (All Frequency Bands): Category I Equipment
RSS - 210 Issue 8 Amendment 1	February 2015	RSS-210, Amendment 1 — Licence-Exempt, Low-Power Radio Apparatus Operating in the Television Bands (February 2015)
RSS - Gen Issue 4	November 2014	Spectrum Management and Telecommunications Radio Standards Specifications - General Requirements and Information for the Certification of Radio Apparatus

3.1 Measurement guidance

Guidance	Version	Description
ANSI C63.4-2014	-/-	American national standard for methods of measurement of radio-noise emissions from low-voltage electrical and electronic equipment in the range of 9 kHz to 40 GHz
ANSI C63.10-2013	-/-	American national standard of procedures for compliance testing of unlicensed wireless devices

4 Test environment

Temperature	:	T_{nom} T_{max} T_{min}	+22 °C during room temperature tests +55 °C during high temperature tests -20 °C during low temperature tests
Relative humidity content	:		55 %
Barometric pressure	:		not relevant for this kind of testing
Power supply	:	V_{nom} V_{max} V_{min}	4.0 V DC by Battery -/- V No variation required for the tests -/- V No variation required for the tests

5 Test item

5.1 General description

Kind of test item	:	WPC, NFC, GSM Coupler
Type identification	:	D-WMI 2015 A
PMN	:	D-WMI 2015 A
HVIN	:	D-WMI 2015 A
FVIN	:	-/-
HMN	:	-/-
S/N serial number	:	1600092 (internal antenna) 1600066 (external antenna)
HW hardware status	:	C2.1
SW software status	:	SW 10
Frequency band	:	13.56 MHz
Type of radio transmission	:	modulated carrier
Use of frequency spectrum	:	
Type of modulation	:	ASK
Number of channels	:	1
Antenna	:	Integrated & external antenna
Power supply	:	8.0 V to 16.0 V AC, 50/60 Hz
Temperature range	:	-20°C to +40°C

5.2 Additional information

The content of the following annexes is defined in the QA. It may be that not all of the listed annexes are necessary for this report, thus some values in between may be missing.

Test setup- and EUT-photos are included in test report:

- 1-0493/15-01-01_AnnexA
- 1-0493/15-01-01_AnnexB
- 1-0493/15-01-01_AnnexD

6 Test laboratories sub-contracted

None

7 Description of the test setup

Typically, the calibrations of the test apparatus are commissioned to and performed by an accredited calibration laboratory. The calibration intervals are determined in accordance with the DIN EN ISO/IEC 17025. In addition to the external calibrations, the laboratory executes comparison measurements with other calibrated test systems or effective verifications. Weekly chamber inspections and range calibrations are performed. Where possible, RF generating and signaling equipment as well as measuring receivers and analyzers are connected to an external high-precision 10 MHz reference (GPS-based or rubidium frequency standard).

In order to simplify the identification of the equipment used at some special tests, some items of test equipment and ancillaries can be provided with an identifier or number in the equipment list below (Lab/Item).

Agenda: Kind of Calibration

k	calibration / calibrated	EK	limited calibration
ne	not required (k, ev, izw, zw not required)	zw	cyclical maintenance (external cyclical maintenance)
ev	periodic self verification	izw	internal cyclical maintenance
Ve	long-term stability recognized	g	blocked for accredited testing
v/k!	Attention: extended calibration interval		
NK!	Attention: not calibrated	*)	next calibration ordered / currently in progress

7.1 Shielded semi anechoic chamber

The radiated measurements are performed in vertical and horizontal plane in the frequency range from 9 kHz to 1 GHz in semi-anechoic chambers. The EUT is positioned on a non-conductive support with a height of 0.80 m above a conductive ground plane that covers the whole chamber. The receiving antennas are confirmed with specifications ANSI C63.10-2013, American National Standard for Testing Unlicensed Wireless Devices. These antennas can be moved over the height range between 1.0 m and 4.0 m in order to search for maximum field strength emitted from EUT. The measurement distances between EUT and receiving antennas are indicated in the test setups for the various frequency ranges. For each measurement, the EUT is rotated in all three axes until the maximum field strength is received. The wanted and unwanted emissions are received by spectrum analyzers where the detector modes and resolution bandwidths over various frequency ranges are set according to requirement ANSI C63.

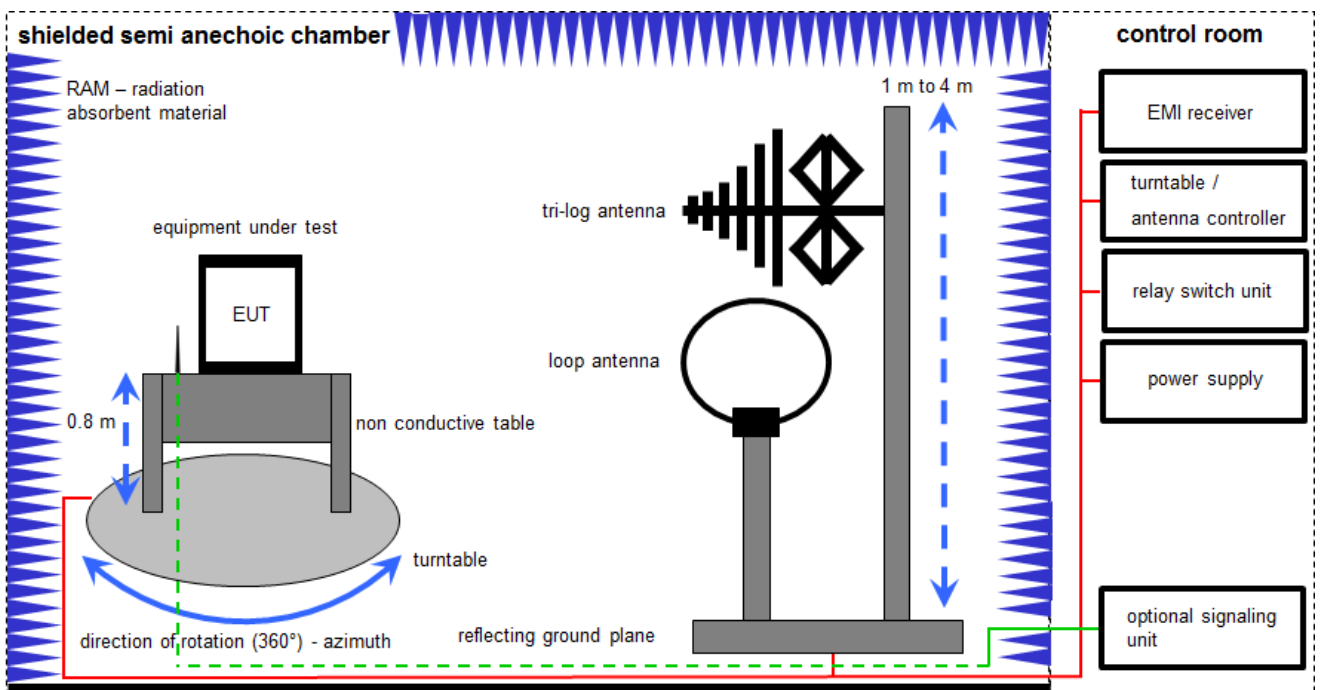

Measurement distance: tri-log antenna 10 meter; loop antenna 10 meter

$$FS = UR + CL + AF$$

(FS-field strength; UR-voltage at the receiver; CL-loss of the cable; AF-antenna factor)

Example calculation:

$$FS [dB\mu V/m] = 12.35 [dB\mu V/m] + 1.90 [dB] + 16.80 [dB/m] = 31.05 [dB\mu V/m] (35.69 \mu V/m)$$

Equipment table:

No.	Lab / Item	Equipment	Type	Manufacturer	Serial No.	INV. No Cetecom	Kind of Calibration	Last Calibration	Next Calibration
1	A1/A2	DC power supply, 60Vdc, 50A, 1200 W	6032A	HP	2920A04466	300000580	ne	-/-	-/-
2	A1/A2	EMI Test Receiver	ESCI 3	R&S	100083	300003312	k	26.01.2015	26.01.2016
3	A1/A2	Antenna Tower	Model 2175	ETS-Lindgren	64762	300003745	izw	-/-	-/-
4	A1/A2	Positioning Controller	Model 2090	ETS-Lindgren	64672	300003746	izw	-/-	-/-
5	A1/A2	Turntable Interface-Box	Model 105637	ETS-Lindgren	44583	300003747	izw	-/-	-/-
6	A1	TRILOG Broadband Test-Antenna 30 MHz - 3 GHz	VULB9163	Schwarzbeck	295	300003787	k	22.04.2014	22.04.2016
7	A2	Active Loop Antenna 10 kHz to 30 MHz	6502	EMCO/2	8905-2342	300000256	k	24.06.2015	24.06.2017

7.2 Shielded fully anechoic chamber

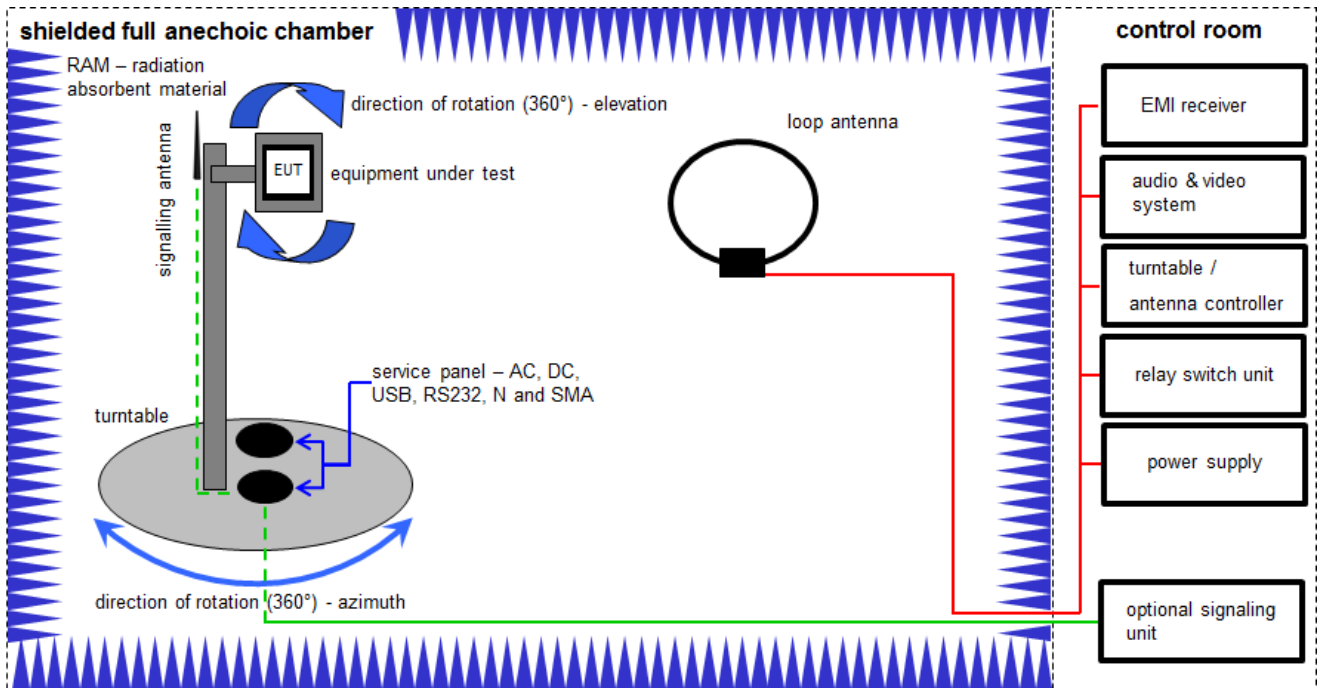

Measurement distance: loop antenna 3 meter

$$FS = UR + CA + AF$$

(FS-field strength; UR-voltage at the receiver; CA-loss of the signal path; AF-antenna factor)

Example calculation:

$$FS [dB\mu V/m] = 40.0 [dB\mu V/m] + (-35.8) [dB] + 32.9 [dB/m] = 37.1 [dB\mu V/m] (71.61 \mu V/m)$$

Equipment table:

No.	Lab / Item	Equipment	Type	Manufacturer	Serial No.	INV. No Cetecom	Kind of Calibration	Last Calibration	Next Calibration
1	B	DC power supply, 60Vdc, 50A, 1200 W	6032A	HP	2818A03450	300001040	Ve	20.01.2015	20.01.2018
2	B	Switch / Control Unit	3488A	HP	*	300000199	ne	-/-	-/-
3	B	Active Loop Antenna 10 kHz to 30 MHz	6502	EMCO/2	8905-2342	300000256	k	24.06.2015	24.06.2017
4	B	MXE EMI Receiver 20 Hz to 26,5 GHz	N9038A	Agilent Technologies	MY51210197	300004405	k	06.03.2015	06.03.2016

7.3 Radiated measurements RF laboratory

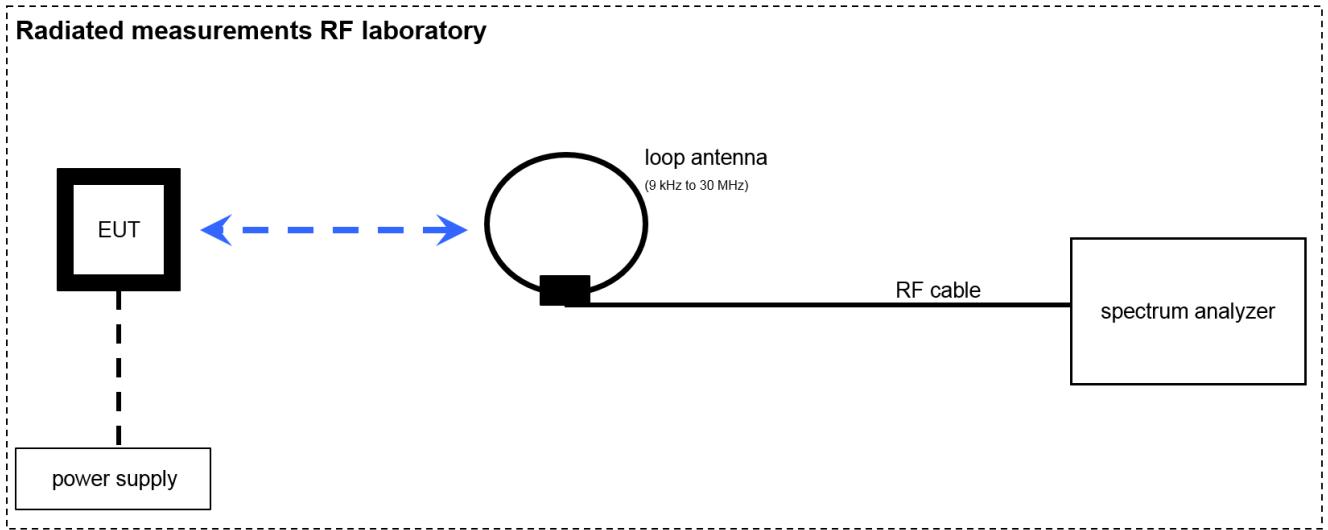

Equipment table:

No.	Lab / Item	Equipment	Type	Manufacturer	Serial No.	INV. No Cetecom	Kind of Calibration	Last Calibration	Next Calibration
1	C	DC power supply, 60Vdc, 50A, 1200 W	6032A	HP	2920A04590	300001041	Ve	20.01.2015	20.01.2018
2	C	Signal Analyzer 20Hz-26,5GHz-150 to + 30 DBM	FSiQ26	R&S	835111/0004	300002678	Ve	22.01.2015	22.01.2017
3	C	Active Loop Antenna 10 kHz to 30 MHz	6502	EMCO/2	8905-2342	300000256	k	24.06.2015	24.06.2017
4	C	RF Cable BNC	RG58	Huber & Suhner	101713	400001209	ev	-/-	-/-

7.4 Frequency error

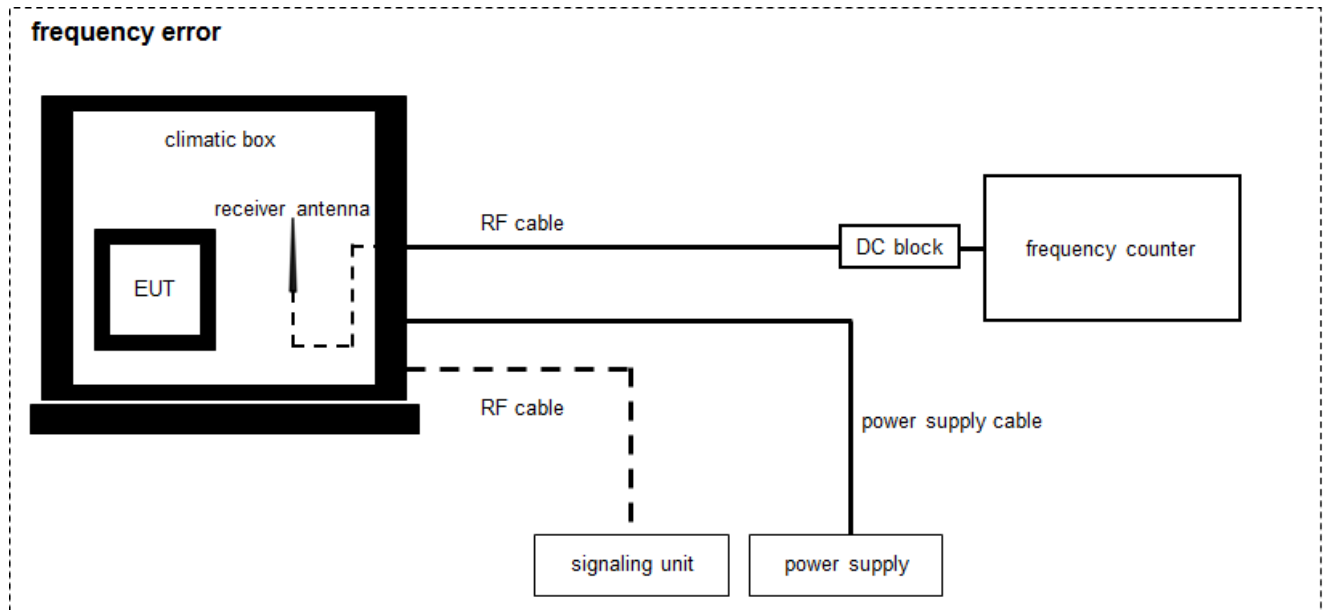

Equipment table:

No.	Lab / Item	Equipment	Type	Manufacturer	Serial No.	INV. No Cetecom	Kind of Calibration	Last Calibration	Next Calibration
1	D	DC power supply, 60Vdc, 50A, 1200 W	6032A	HP	2920A04590	300001041	Ve	20.01.2015	20.01.2018
2	D	Signal Analyzer 20Hz-26,5GHz-150 to + 30 DBM	FSiQ26	R&S	835111/0004	300002678	Ve	22.01.2015	22.01.2017
3	D	Active Loop Antenna 10 kHz to 30 MHz	6502	EMCO/2	8905-2342	300000256	k	24.06.2015	24.06.2017
4	D	Temperature Test Chamber	VT 4002	Heraeus Voetsch	521/83761	300002326	ev	03.09.2015	03.09.2017
5	D	RF Cable BNC	RG58	Huber & Suhner	101713	400001209	ev	-/-	-/-

8 Sequence of testing

8.1 Sequence of testing radiated spurious 9 kHz to 30 MHz

Setup

- The equipment is set up to simulate normal operation mode as described in the user manual or defined by the manufacturer.
- If the EUT is a tabletop system, a 2-axis positioner with 1.5 m height is used.
- If the EUT is a floor standing device, it is placed directly on the turn table.
- Auxiliary equipment and cables are positioned to simulate normal operation conditions as described in ANSI C 63.4.
- The AC power port of the EUT (if available) is connected to a power outlet below the turntable.
- Measurement distance is 3 m (see ANSI C 63.4) – see test details.
- EUT is set into operation.

Premeasurement

- The turntable rotates from 0° to 315° using 45° steps.
- The antenna height is 1.5 m.
- At each turntable position the analyzer sweeps with positive-peak detector to find the maximum of all emissions.

Final measurement

- Identified emissions during the premeasurement are maximized by the software by rotating the turntable from 0° to 360°. In case of the 2-axis positioner is used the elevation axis is also rotated from 0° to 360°.
- The final measurement is done in the position (turntable and elevation) causing the highest emissions with quasi-peak (as described in ANSI C 63.4).
- Final levels, frequency, measuring time, bandwidth, turntable position, correction factor, margin to the limit and limit will be recorded. A plot with the graph of the premeasurement and the limit is stored.

8.2 Sequence of testing radiated spurious 30 MHz to 1 GHz

Setup

- The equipment is set up to simulate normal operation mode as described in the user manual or defined by the manufacturer.
- If the EUT is a tabletop system, a table with 0.8 m height is used, which is placed on the ground plane.
- If the EUT is a floor standing device, it is placed on the ground plane with insulation between both.
- Auxiliary equipment and cables are positioned to simulate normal operation conditions as described in ANSI C 63.4.
- The AC power port of the EUT (if available) is connected to a power outlet below the turntable.
- Measurement distance is 10 m or 3 m (see ANSI C 63.4) – see test details.
- EUT is set into operation.

Premeasurement

- The turntable rotates from 0° to 315° using 45° steps.
- The antenna is polarized vertical and horizontal.
- The antenna height changes from 1 m to 3 m.
- At each turntable position, antenna polarization and height the analyzer sweeps three times in peak to find the maximum of all emissions.

Final measurement

- The final measurement is performed for at least six highest peaks according to the requirements of the ANSI C63.4.
- Based on antenna and turntable positions at which the peak values are measured the software maximize the peaks by changing turntable position $\pm 45^\circ$ and antenna height between 1 and 4 m.
- The final measurement is done with quasi-peak detector (as described in ANSI C 63.4).
- Final levels, frequency, measuring time, bandwidth, antenna height, antenna polarization, turntable angle, correction factor, margin to the limit and limit are recorded. A plot with the graph of the premeasurement with marked maximum final results and the limit is stored.

9 Measurement uncertainty

Measurement uncertainty	
Test case	Uncertainty
Antenna gain	± 3 dB
Spectrum bandwidth	± 21.5 kHz absolute; ± 15.0 kHz relative
Maximum output power	± 1 dB
Detailed conducted spurious emissions @ the band edge	± 1 dB
Band edge compliance radiated	± 3 dB
Spurious emissions conducted	± 3 dB
Spurious emissions radiated below 30 MHz	± 3 dB
Spurious emissions radiated 30 MHz to 1 GHz	± 3 dB
Spurious emissions radiated 1 GHz to 12.75 GHz	± 3.7 dB
Spurious emissions radiated above 12.75 GHz	± 4.5 dB
Spurious emissions conducted below 30 MHz (AC conducted)	± 2.6 dB

10 Summary of measurement results

<input checked="" type="checkbox"/>	No deviations from the technical specifications were ascertained
<input type="checkbox"/>	There were deviations from the technical specifications ascertained
<input type="checkbox"/>	This test report is only a partial test report. The content and verdict of the performed test cases are listed below.

TC Identifier	Description	Verdict	Date	Remark
RF-Testing	CFR Part 15 RSS 210 Issue 8 RSS Gen Issue 4	See table!	2015-10-21	-/-

Test specification clause	Test case	Temperature conditions	Power source conditions	C	NC	NA	NP	Remark
RSS Gen Issue 4	Occupied bandwidth	Nominal	Nominal	<input checked="" type="checkbox"/>	<input type="checkbox"/>	<input type="checkbox"/>	<input type="checkbox"/>	No pass/fail criteria!
§ 15.35 (c)/ RSS-GEN Issue 3	Timing of the transmitter (Duty cycle correction factor)	Nominal	Nominal	<input checked="" type="checkbox"/>	<input type="checkbox"/>	<input type="checkbox"/>	<input type="checkbox"/>	-/-
§ 15.225 (a)	Field strength of the fundamental	Nominal	Nominal	<input checked="" type="checkbox"/>	<input type="checkbox"/>	<input type="checkbox"/>	<input type="checkbox"/>	-/-
§ 15.209 & § 15.225 (b-d)	Field strength of the harmonics and spurious	Nominal	Nominal	<input checked="" type="checkbox"/>	<input type="checkbox"/>	<input type="checkbox"/>	<input type="checkbox"/>	-/-
§ 15.109	Receiver spurious emissions and cabinet radiations	Nominal	Nominal	<input type="checkbox"/>	<input type="checkbox"/>	<input checked="" type="checkbox"/>	<input type="checkbox"/>	Permanently co-located transmitter.
§15.107 §15.207	Conducted limits	Nominal	Nominal	<input type="checkbox"/>	<input type="checkbox"/>	<input checked="" type="checkbox"/>	<input type="checkbox"/>	Battery powered.
§ 15.225 (a)	Frequency tolerance	Normal & extreme conditions	Normal & extreme conditions	<input checked="" type="checkbox"/>	<input type="checkbox"/>	<input type="checkbox"/>	<input type="checkbox"/>	-/-

Note: C = Complies; NC = Not complies; NA = Not applicable; NP = Not performed

11 Additional comments

Reference documents: None

Special test descriptions: None

Configuration descriptions: The DUT was tested in two different antenna configurations (internal & external antenna). For detailed view refer to the EUT photo documentation.

12 Measurement results**12.1 Timing of the transmitter****Measurement:**

Measurement parameter	
Detector:	Positive peak
Sweep time:	100 ms
Resolution bandwidth:	100 kHz
Video bandwidth:	300 kHz
Span:	Zero span
Trace-Mode:	Single sweep
Used equipment:	See chapter 7.3 (Item C)
Measurement uncertainty:	See chapter 9

Limits:

FCC	IC
Timing of the transmitter	
<p>(c) Unless otherwise specified, e.g. Section 15.255(b), when the radiated emission limits are expressed in terms of the average value of the emission, and pulsed operation is employed, the measurement field strength shall be determined by averaging over one complete pulse train, including blanking intervals, as long as the pulse train does not exceed 0.1 seconds. As an alternative (provided the transmitter operates for longer than 0.1 seconds) or in cases where the pulse train exceeds 0.1 seconds, the measured field strength shall be determined from the average absolute voltage during a 0.1 second interval during which the field strength is at its maximum value. The exact method of calculating the average field strength shall be submitted with any application for certification or shall be retained in the measurement data file for equipment subject to notification or verification.</p>	

Result:

Plot 1: Timing of the Transmitter

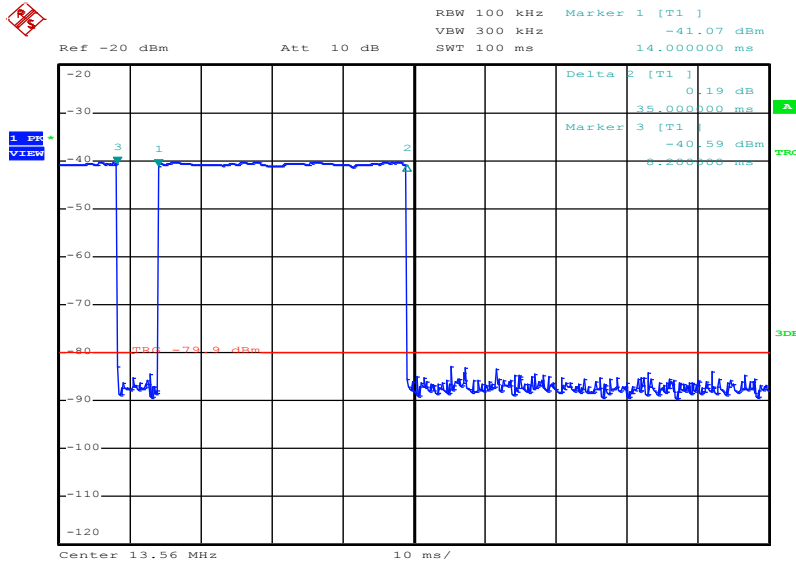

Date: 16.OCT.2015 17:20:30

Transmit time (Tx on) = 43.2 ms
 Tx on + Tx off = 100 ms

The peak-to-average correction factor is calculated with $20\text{Log} [\text{Tx on}/(\text{Tx on} + \text{Tx off})]$.
 Hereby the peak-to-average correction factor is -7.2 dB.

12.2 Occupied bandwidth**Measurement:**

The emission bandwidth (x dB) is defined as the frequency range between two points, one above and one below the carrier frequency, at which the spectral density of the emission is attenuated x dB below the maximum in-band spectral density of the modulated signal.

Measurement parameters	
Detector:	Peak
Resolution bandwidth:	1 % – 5 % of the occupied bandwidth
Video bandwidth:	≥ 3x RBW
Trace mode:	Max hold
Analyser function:	99 % power function
Used equipment:	See chapter 7.3 (Item C)
Measurement uncertainty:	See chapter 9

Limit:

IC
for RSP-100 test report coversheet only

Result – internal antenna:

99% emission bandwidth
293 kHz

Result – external antenna:

99% emission bandwidth
302 kHz

Plots:

Plot 1: 99 % emission bandwidth – internal antenna

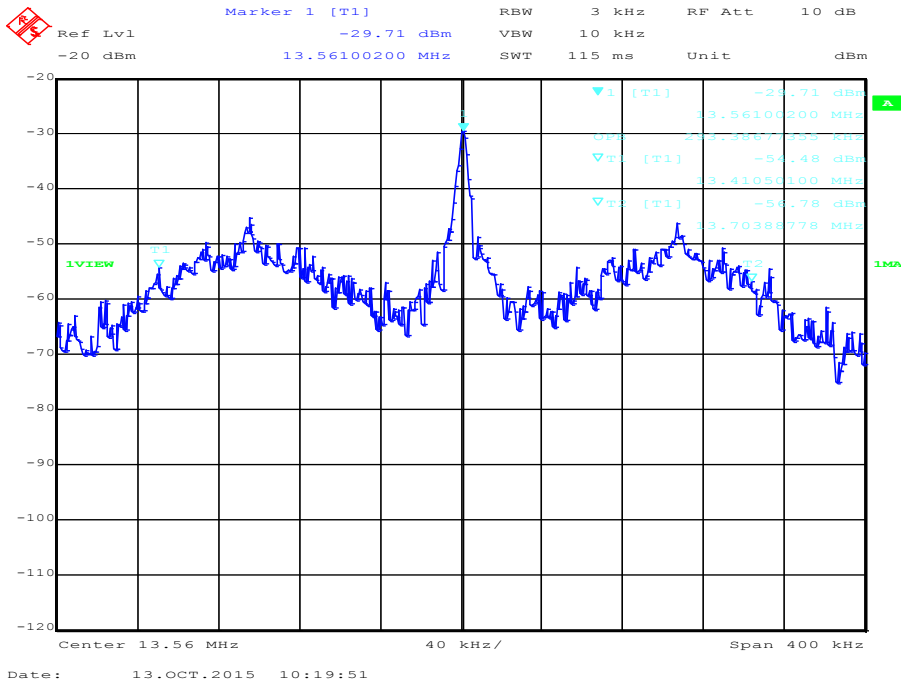

Plot 2: 99 % emission bandwidth – external antenna

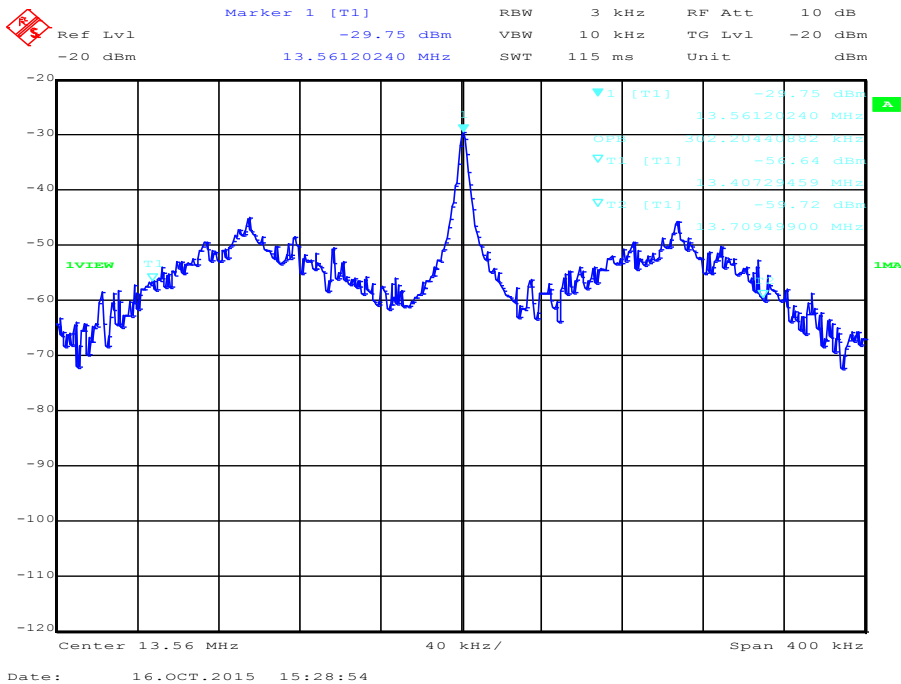

12.3 Field strength of the fundamental

Measurement:

The maximum detected field strength for the carrier signal.

Measurement parameters	
Detector:	Quasi peak / peak (worst case)
Resolution bandwidth:	120 kHz
Video bandwidth:	≥ 3x RBW
Trace mode:	Max hold
Used equipment:	See chapter 7.1 (Item A.2)
Measurement uncertainty:	See chapter 9

Limit:

FCC & IC		
Frequency (MHz)	Field strength (µV/m)	Measurement distance (m)
13.553 to 13.567	15,848 (84 dBµV/m)	30

Recalculation:

According to ANSI C63.10	
Frequency	Formula
13.56 MHz	$FS_{limit} = FS_{max} - 40 \log\left(\frac{d_{nearfield}}{d_{measure}}\right) - 20 \log\left(\frac{d_{limit}}{d_{nearfield}}\right) *$

* Correction factor = 22.7 dB

According to ANSI C63.10

Result – internal antenna:

Field strength of the fundamental		
Frequency	13.56 MHz	
Distance	@ 3 m	@ 30 m
Measured / calculated value	69.6 dBµV/m	46.9 dBµV/m

Result – external antenna:

Field strength of the fundamental		
Frequency	13.56 MHz	
Distance	@ 3 m	@ 30 m
Measured / calculated value	69.9 dBµV/m	47.2 dBµV/m

12.4 Field strength of the harmonics and spurious

Measurement:

The maximum detected field strength for the harmonics and spurious.

Measurement parameters	
Detector:	Quasi peak / average or peak (worst case – pre-scan)
Resolution bandwidth:	F < 150 kHz: 200 Hz 150 kHz < F < 30 MHz: 9 kHz 30 MHz < F < 1 GHz: 120 kHz
Video bandwidth:	F < 150 kHz: 1 kHz 150 kHz < F < 30 MHz: 100 kHz 30 MHz < F < 1 GHz: 300 kHz
Trace mode:	Max hold
Used equipment:	See chapter 7.1 (Item A1)
Measurement uncertainty:	See chapter 9

Limit:

FCC & IC		
Frequency (MHz)	Field strength (dB μ V/m)	Measurement distance (m)
0.009 – 0.490	2400/F(kHz)	300
0.490 – 1.705	24000/F(kHz)	30
1.705 – 30	30 (29.5 dB μ V/m)	30
30 – 88	100 (40 dB μ V/m)	3
88 – 216	150 (43.5 dB μ V/m)	3
216 – 960	200 (46 dB μ V/m)	3

Note: For a reduced measurement distance, please take a look at the limit line and the ANSI C63.10-2013 sub clause 6.4 radiated emissions from unlicensed wireless devices below 30 MHz.

Result:

Detected emissions			
Frequency (MHz)	Detector	Resolution bandwidth (kHz)	Detected value
For frequencies < all emissions greater 10 dB below limit *			
For frequencies > 30 MHz see result table below plots			

* Note: Fundamental not rated.

Plots:

Plot 1: 9 kHz – 30 MHz, magnetic emissions – internal antenna

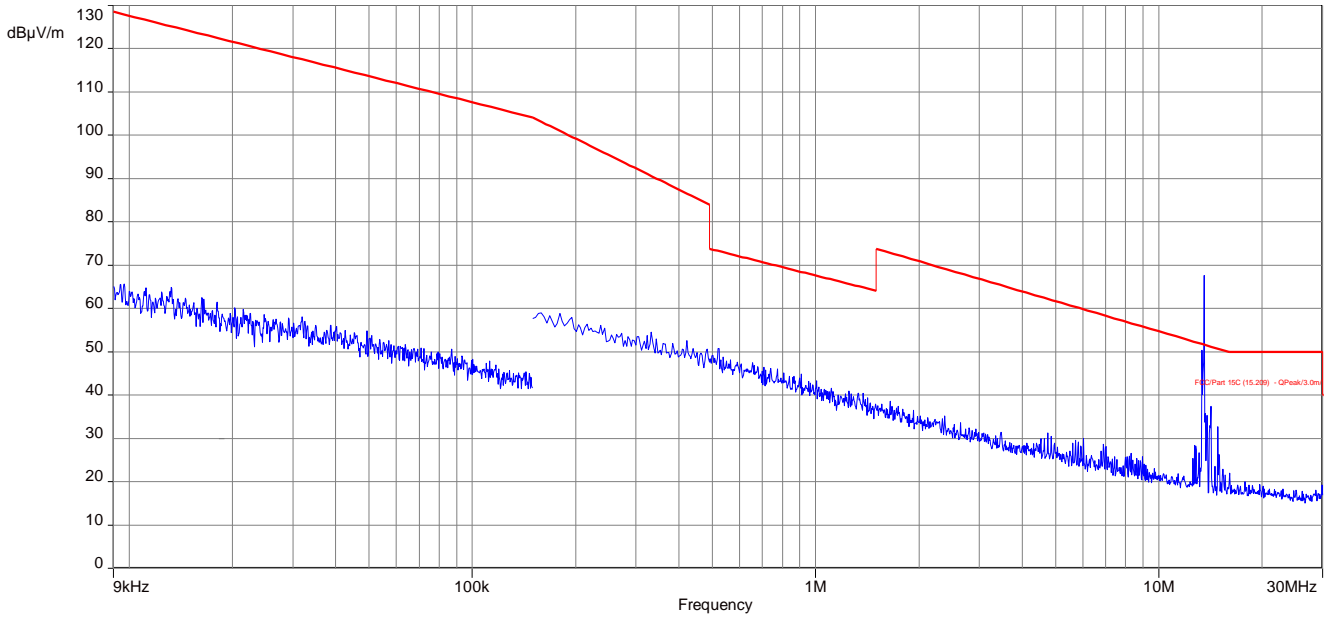

Plot 2: Spectrum mask – internal antenna (the limits are recalculated according to the ANSI C63.10-2013 sub clause 6.4)

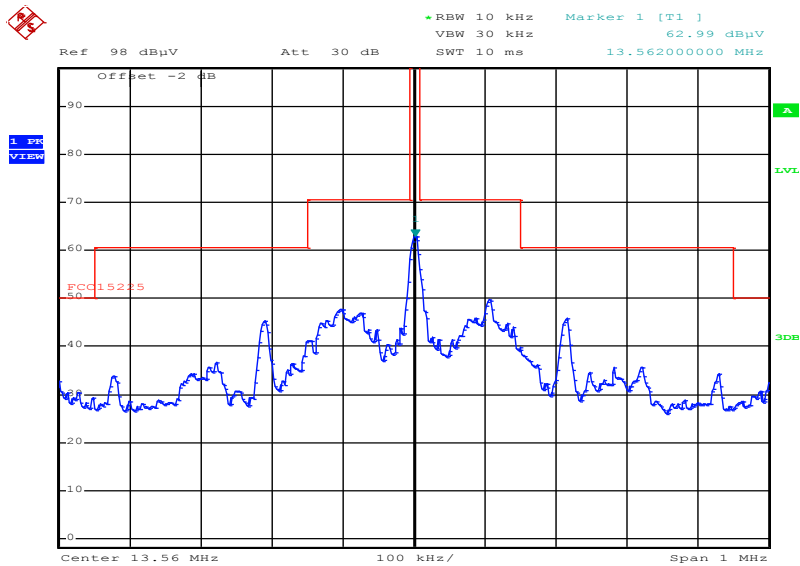

Date: 16.OCT.2015 17:09:43

Plot 3: 30 MHz – 1 GHz, vertical and horizontal polarization – internal antenna

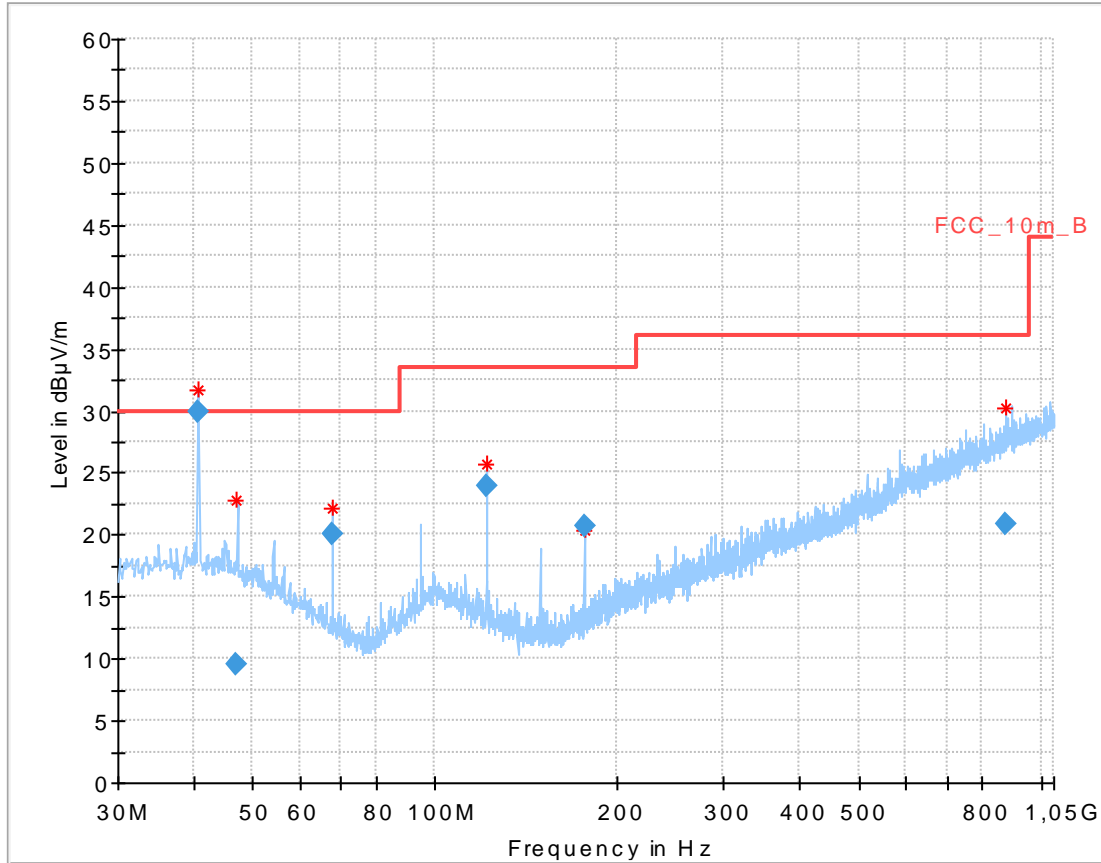

Frequency (MHz)	QuasiPeak (dBµV/m)	Limit (dBµV/m)	Margin (dB)	Meas. Time (ms)	Bandwidth (kHz)	Height (cm)	Pol	Azimuth (deg)	Corr. (dB)
40.685550	29.98	30.00	0.02	1000.0	120.000	100.0	V	278	14.0
47.024400	9.61	30.00	20.39	1000.0	120.000	103.0	V	73	13.4
67.788750	20.03	30.00	9.97	1000.0	120.000	400.0	V	297	8.9
122.040150	23.91	33.50	9.59	1000.0	120.000	102.0	V	278	10.0
176.292600	20.66	33.50	12.84	1000.0	120.000	98.0	V	119	10.1
871.679100	20.81	36.00	15.19	1000.0	120.000	101.0	V	265	23.7

Plot 6: 9 kHz – 30 MHz, magnetic emissions – external antenna

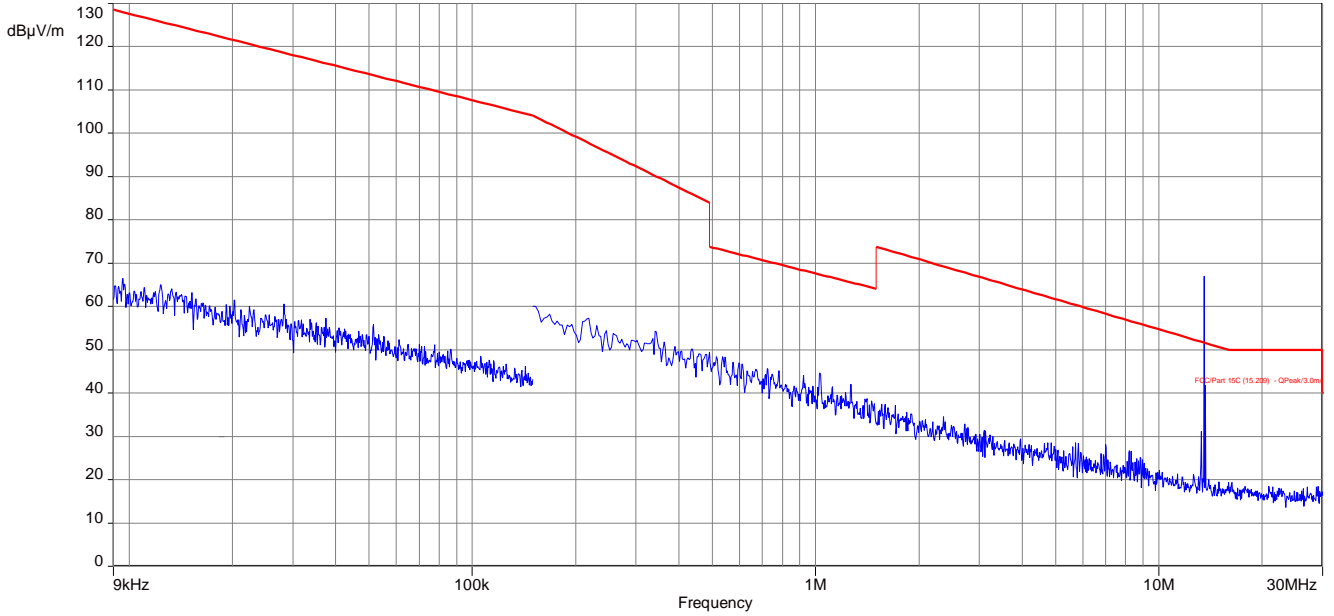

Plot 7: Spectrum mask – external antenna (the limits are recalculated according to the ANSI C63.10-2013 sub clause 6.4)

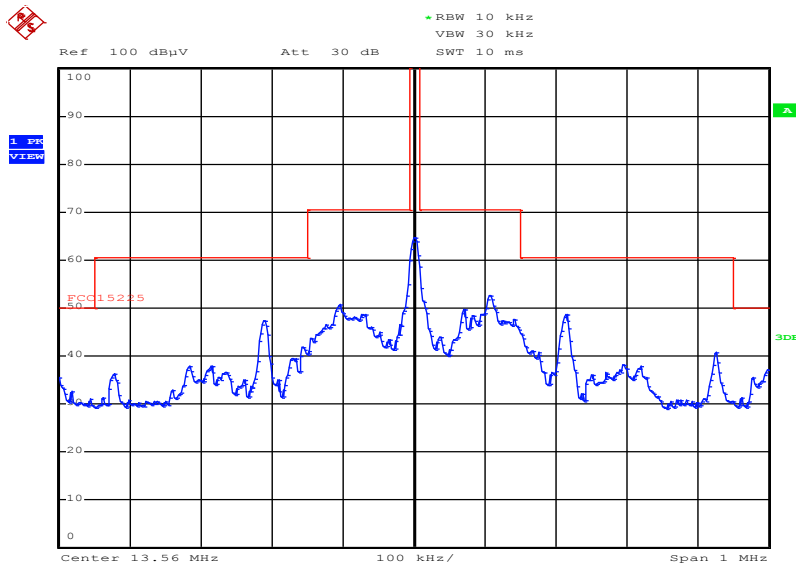

Date: 16.OCT.2015 17:03:47

Plot 8: 30 MHz – 1 GHz, vertical and horizontal polarization – external antenna

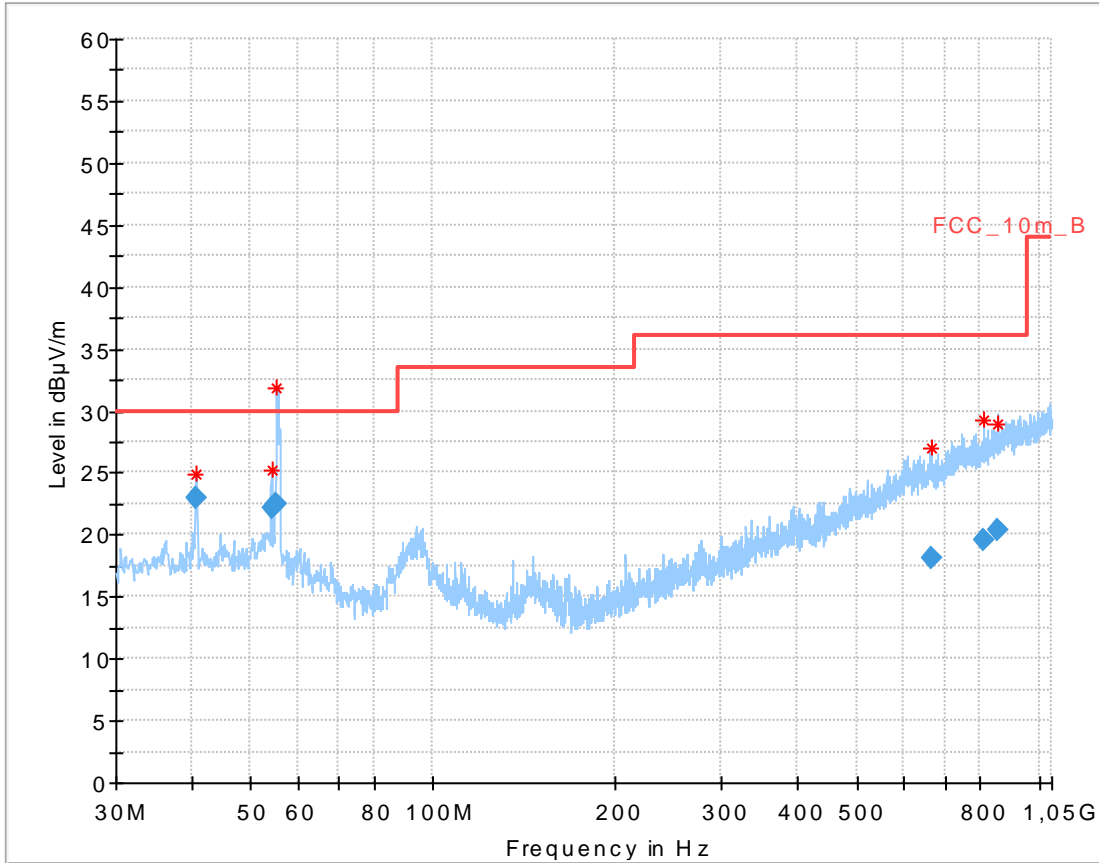

Frequency (MHz)	QuasiPeak (dBµV/m)	Limit (dBµV/m)	Margin (dB)	Meas. Time (ms)	Bandwidth (kHz)	Height (cm)	Pol	Azimuth (deg)	Corr. (dB)
40.672350	23.03	30.00	6.97	1000.0	120.000	171.0	V	278	14.0
54.229800	22.20	30.00	7.80	1000.0	120.000	103.0	V	97	12.0
55.274700	22.52	30.00	7.48	1000.0	120.000	272.0	V	277	11.8
666.072000	18.04	36.00	17.96	1000.0	120.000	200.0	V	282	21.2
810.473400	19.59	36.00	16.41	1000.0	120.000	200.0	H	118	22.9
852.108300	20.37	36.00	15.63	1000.0	120.000	400.0	V	140	23.5

12.5 Frequency error

Measurement:

The maximum detected field strength for the spurious.

Measurement parameters	
Detector:	Peak detector
Resolution bandwidth:	10 Hz / 100 Hz
Video bandwidth:	> RBW
Trace mode:	Max hold
Used equipment:	See chapter 7.4 (Item D)
Measurement uncertainty:	See chapter 9

Limit:

FCC
The frequency tolerance of the carrier signal shall be maintained within +/- 0.01% of the operating frequency over a temperature variation of -20 degrees to +50 degrees C at normal supply voltage, and for a variation in the primary supply voltage from 85% to 115% of the rated supply voltage at a temperature of 20 degrees C. (±1.356 kHz)

Result: Temperature variation

Frequency tolerance		
Frequency deviation (Hz)	Conditions	Result
692	-20 °C & 100% voltage	compliant
710	-10 °C & 100% voltage	compliant
698	0 °C & 100% voltage	compliant
673	+10 °C & 100% voltage	compliant
591	+20 °C & 100% voltage	compliant
579	+30 °C & 100% voltage	compliant
560	+40 °C & 100% voltage	compliant
510	+50 °C & 100% voltage	compliant

Result: Voltage variation

Frequency tolerance		
Frequency deviation (Hz)	Temperature	Result
620	+20 °C & 85% voltage	compliant
623	+20 °C & 100% voltage	compliant
624	+20 °C & 115% voltage	compliant

13 Observations

No observations except those reported with the single test cases have been made.

Annex A Document history

Version	Applied changes	Date of release
	Initial release	2015-10-21

Annex B Further information

Glossary

AVG	-	Average
DUT	-	Device under test
EMC	-	Electromagnetic Compatibility
EN	-	European Standard
EUT	-	Equipment under test
ETSI	-	European Telecommunications Standard Institute
FCC	-	Federal Communication Commission
FCC ID	-	Company Identifier at FCC
HW	-	Hardware
IC	-	Industry Canada
Inv. No.	-	Inventory number
N/A	-	Not applicable
PP	-	Positive peak
QP	-	Quasi peak
S/N	-	Serial number
SW	-	Software
PMN		Product marketing name
HMN		Host marketing name
HVIN		Hardware version identification number
FVIN		Firmware version identification number

Annex C Accreditation Certificate

Front side of certificate

Back side of certificate



Deutsche Akkreditierungsstelle GmbH

Belehrung gemäß § 8 Absatz 1 AkkStelleG i.V.m. § 1 Absatz 1 AkkStelleGBV
 Unterzeichnerin der Multilateralen Abkommen
 von EA, ILAC und IAF zur gegenseitigen Anerkennung

Akkreditierung



Die Deutsche Akkreditierungsstelle GmbH bestätigt hiermit, dass das Prüflaboratorium

CETECOM ICT Services GmbH
 Untertürkheimer Straße 6-10, 66117 Saarbrücken

die Kompetenz nach DIN EN ISO/IEC 17025:2005 besitzt, Prüfungen in folgenden Bereichen durchzuführen:

- Drahtgebundene Kommunikation einschließlich xDSL
- VoIP und DECT
- Akustik
- Funk einschließlich WLAN
- Short Range Devices (SRD)
- RFID
- WiFiMax und Richtfunk
- Mobilfunk (GSM / DCS, Over the Air (OTA) Performance)
- Elektromagnetische Verträglichkeit (EMV) einschließlich Automotive
- Produktsicherheit
- SAR und Hearing Aid Compatibility (HAC)
- Umweltsimulation
- Smart Card Terminals
- Bluetooth
- Wi-Fi Services

Die Akkreditierungsurkunde gilt nur in Verbindung mit dem Bescheid vom 07.03.2014 mit der Akkreditierungsnummer D-PL-12076-01 und ist gültig bis 17.01.2018. Sie besteht aus diesem Deckblatt, der Rückseite des Deckblatts und der folgenden Anlage mit insgesamt 77 Seiten.

Registrierungsnummer der Urkunde: D-PL-12076-01-00

Frankfurt am Main, 07.03.2014
 2018/03/07/01/0001

[Signature]
 In Auftrag gegeben von: Ralf Eger
 Akkreditierungsstelle

Deutsche Akkreditierungsstelle GmbH

Standort Berlin Spittelmarkt 10 10117 Berlin	Standort Frankfurt am Main Gartenstraße 6 60594 Frankfurt am Main	Standort Braunschweig Blindenslee 100 38115 Braunschweig
--	---	--

Die auszugsweise Veröffentlichung der Akkreditierungsurkunde bedarf der vorherigen schriftlichen Zustimmung der Deutschen Akkreditierungsstelle GmbH (DAkkS). Ausgenommen davon ist die separate Weiterverbreitung des Deckblattes durch die umseitig genannte Kontaktpersonenbewertungsstelle in unveränderter Form.

Es darf nicht der Anschein erweckt werden, dass sich die Akkreditierung auch auf Bereiche erstreckt, die über den durch die DAkkS bestätigten Akkreditierungsbereich hinausgehen.

Die Akkreditierung erfolgte gemäß des Gesetzes über die Akkreditierungsstelle (AkkStelleG) vom 31. Juli 2009 (BGBl. I S. 2009) sowie der Verordnung (EG) Nr. 765/2008 des Europäischen Parlaments und des Rates vom 9. Juli 2008 über die Vorschriften für die Akkreditierung und Marktüberwachung im Zusammenhang mit der Vermarktung von Produkten (Abt. L 218 vom 9. Juli 2008, S. 30). Die DAkkS ist Unterzeichnerin der Multilateralen Abkommen zur gegenseitigen Anerkennung der Ergebnisse von Prüfungen für Akkreditierungen (EA), das International Accreditation Forum (IAF) und der International Laboratory Accreditation Cooperation (ILAC). Die Unterzeichner dieser Abkommen erkennen ihre Akkreditierungen gegenseitig an.

Der aktuelle Stand der Mitgliedschaft kann folgenden Webseiten entnommen werden:
 EA: www.europas-accreditation.org
 IAF: www.iaf.org
 ILAC: www.ilac.org

Note:

The current certificate including annex is published on our website (see link below) or may be received from CETECOM ICT Services on request.

<https://www.cetecom.com/en/cetecom-group/europe/germany-saarbruecken/accreditations.html>