

FCC CERTIFICATION TEST REPORT

FOR

Applicant	:	Continental Automotive GmbH
Address	:	Siemensstrasse 12 SV C TS RBG EMC-Laboratory Regensburg 93055 Germany
Equipment under test	:	DHS Audi Q7 NFC
Model No.	:	DHSQ7NFC
Trade Mark	:	Continental
FCC ID	:	KR5DHSQ7NFC
Manufacturer	:	Continental Automotive GmbH
Address	:	Siemensstrasse 12 SV C TS RBG EMC-Laboratory Regensburg 93055 Germany

Issued By: Dongguan Dongdian Testing Service Co., Ltd.

Add: No. 17, Zongbu Road 2, Songshan Lake Sci&Tech, Industry Park, Dongguan
City, Guangdong Province, China, 523808

Tel: +86-0769-38826678, **E-mail:** ddt@dgddt.com, <http://www.dgddt.com>

REPORT

TABLE OF CONTENTS

- Test report declares.....3
- 1 Summary of test results 5
- 2 General test information..... 6
 - 2.1. Description of EUT 6
 - 2.2. Accessories of EUT 6
 - 2.3. Assistant equipment used for test..... 6
 - 2.4. Block diagram of EUT configuration for test..... 6
 - 2.5. Deviations of test standard 6
 - 2.6. Test environment conditions 6
 - 2.7. Test laboratory 6
 - 2.8. Measurement uncertainty 7
- 3 Equipment used during test 8
- 4 20dB Bandwidth 9
 - 4.1. Block diagram of test setup 9
 - 4.2. Limits 9
 - 4.3. Test Procedure..... 9
 - 4.4. Test Result 9
 - 4.5. Original test data 10
- 5 Frequency Tolerance 11
 - 5.1. Limit..... 11
 - 5.2. Block diagram of test setup 11
 - 5.3. Test Procedure..... 11
 - 5.4. Test result..... 11
- 6 Radiated emission 12
 - 6.1. Block diagram of test setup 12
 - 6.2. Limit..... 13
 - 6.3. Test Procedure..... 14
 - 6.4. Test result..... 15
- 7 Power Line Conducted Emission..... 18
 - 7.1. Block diagram of test setup 18
 - 7.2. Power Line Conducted Emission Limits 18
 - 7.3. Test Procedure..... 18
 - 7.4. Test Result 19
- 8 Antenna Requirements 20

TEST REPORT DECLARE

Applicant	:	Continental Automotive GmbH
Address	:	Siemensstrasse 12 SV C TS RBG EMC-Laboratory Regensburg 93055 Germany
Equipment under Test	:	DHS Audi Q7 NFC
Model No.	:	DHSQ7NFC
Trade Mark	:	Continental
Manufacturer	:	Continental Automotive GmbH
Address	:	Siemensstrasse 12 SV C TS RBG EMC-Laboratory Regensburg 93055 Germany

Test Standard Used:

FCC Rules and Regulations Part 15 Subpart C

Test procedure used:

ANSI C63.10:2013

We Declare:

The equipment described above is tested by Dongguan Dongdian Testing Service Co., Ltd and in the configuration tested the equipment complied with the standards specified above. The test results are contained in this test report and Dongguan Dongdian Testing Service Co., Ltd is assumed of full responsibility for the accuracy and completeness of these tests.

After test and evaluation, our opinion is that the equipment provided for test compliance with the requirement of the above FCC standards.

Report No:	DDT-R18101701-1E2		
Date of Receipt:	Oct. 17, 2018	Date of Test:	Oct. 17, 2018 ~ Nov. 15, 2018

Prepared By:

Ella Gong

Ella Gong/Engineer

Approved By:



Damon Hu/EMC Manager

Note: This report applies to above tested sample only. This report shall not be reproduced in parts without written approval of Dongguan Dongdian Testing Service Co., Ltd.

Revision history

Rev.	Revisions	Issue Date	Revised By
---	Initial issue	Nov. 15, 2018	

1 Summary of test results

Description of Test Item	Standard	Results
20dB Bandwidth	FCC Part 15: 15.215 ANSI C63.10:2013	PASS
Frequency tolerance	FCC Part 15:15.225 ANSI C63.10:2013	PASS
Radiated Emission	FCC Part 15: 15.209 FCC Part 15: 15.225 ANSI C63.10:2013	PASS
Power Line Conducted Emissions	FCC Part 15: 15.207 ANSI C63.10:2013	N/A
Antenna requirement	FCC Part 15: 15.203 ANSI C63.10:2013	PASS

Note: N/A is an abbreviation for Not Applicable.

2 General test information

2.1. Description of EUT

EUT* Name	: DHS Audi Q7 NFC
Model Number	: DHSQ7NFC
EUT function description	: Please reference user manual of this device
Power supply	: DC 12V
Operation frequency	: 13.56MHz
Antenna Type	: Inductive loop coil antenna
Sample Type	: Series production

Note1: EUT is the ab. of equipment under test.

2.2. Accessories of EUT

Description of Accessories	Manufacturer	Model number or Type	Serial No.	Other
/	/	/	/	/

2.3. Assistant equipment used for test

Assistant equipment	Manufacturer	Model number or Type	EMC Compliance	Other
Control box	/	/	/	/

2.4. Block diagram of EUT configuration for test

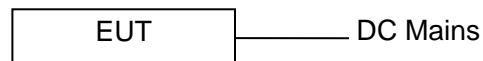

2.5. Deviations of test standard

No Deviation.

2.6. Test environment conditions

During the measurement the environmental conditions were within the listed ranges:

/	Normal Conditions	Extreme Conditions
Temperature range:	21-25°C	-40°C and 80°C
Humidity range:	40-75%	40-75%
Pressure range:	86-106kPa	86-106kPa
Power supply	DC 12V	DC 10.2 and 13.8V (from 85% to 115% of the rated supply voltage)

Note: The supply voltage was declared by the manufacturer.

2.7. Test laboratory

Dongguan Dongdian Testing Service Co., Ltd.

Add: No. 17, Zongbu Road 2, Songshan Lake Sci&Tech, Industry Park, Dongguan City,
Guangdong Province, China, 523808

Tel: +86-0769-38826678 <http://www.dgddt.com>

CNAS Accreditation No. L6451; A2LA Accreditation No. 3870.01

Designation Number: CN1182; Test Firm Registration Number: 540522

Industry Canada site registration number: 10288A-1

2.8. Measurement uncertainty

Test Item	Uncertainty
Uncertainty for Radiation Emission test (9kHz-30MHz)	3.32dB (150KHz-30MHz)
	3.72dB (9KHz-150KHz)
Uncertainty for Radiation Emission test (30MHz-1GHz)	4.70 dB (Antenna Polarize: V)
	4.84 dB (Antenna Polarize: H)
Uncertainty for Radiation Emission test (1GHz to 18GHz)	4.10dB(1-6GHz)
	4.40dB (6GHz-18GHz)
Bandwidth	1.1%
Uncertainty for radio frequency (RBW<20KHz)	3×10^{-8}
Note: This uncertainty represents an expanded uncertainty expressed at approximately the 95% confidence level using a coverage factor of k=2.	

3 Equipment used during test

Equipment	Manufacturer	Model No.	Serial No.	Last Cal.	Cal. Interval
RF Connected Test (Tonscend RF Measurement System)					
Spectrum analyzer	R&S	FSU26	200071	Oct. 12, 2018	1Year
Wideband Radio Communication tester	R&S	CMW500	117491	Jun. 29, 2018	1 Year
Vector Signal Generator	Agilent	E8267D	US49060192	Oct. 12, 2018	1Year
Vector Signal Generator	Agilent	N5182A	MY48180737	Jun. 29, 2018	1 Year
Power Sensor	Agilent	U2021XA	MY55150010	Oct. 21, 2018	1Year
Power Sensor	Agilent	U2021XA	MY55150011	Oct. 23, 2018	1Year
DC Power Source	MATRIS	MPS-3005L-3	D813058W	Aug. 18, 2018	1Year
Attenuator	Mini-Circuits	BW-S10W2	101109	Aug. 18, 2018	1Year
RF Cable	Micable	C10-01-01-1	100309	Oct. 21, 2018	1Year
Temp&Humi Programmable	ZHIXIANG	ZXGDJS-150L	ZX170110-A	Oct. 21, 2018	1Year
Test Software	JS Tonscend	JS1120-3	Ver.2.7	N/A	N/A
USB Data acquisition	Agilent	U2531A	TW55043503	N/A	N/A
Radiated Emission Test (1# chamber)					
EMI Test Receiver	R&S	ESU8	100316	Oct. 12, 2018	1 Year
Spectrum analyzer	Agilent	E4447A	MY50180031	Jun. 29, 2018	1 Year
Trilog Broadband Antenna	Schwarzbeck	VULB9163	9163-462	Nov. 09, 2018	1 Year
Active Loop antenna	Schwarzbeck	FMZB-1519	1519-038	Oct. 17, 2018	1 Year
Double Ridged Horn Antenna	R&S	HF907	100276	Nov. 09, 2018	1 Year
Broad Band Horn Antenna	Schwarzbeck	BBHA 9170	790	Oct. 21, 2018	1 Year
Pre-amplifier	TERA-MW	TRLA-0040G35	101303	Oct. 12, 2018	1 Year
Pre-amplifier	A.H.	PAM-0118	360	Oct. 21, 2018	1 Year
RF Cable	HUBSER	CP-X2+ CP-X1	W11.03+ W12.02	Nov. 08, 2018	1Year
RF Cable	N/A	SMAJ-SMAJ-1M+ SMAJ-SMAJ-11M	17070133+1 7070131	Oct. 21, 2018	1 Year
Test software	Audix	E3	V 6.11111b	N/A	N/A

4 20dB Bandwidth

4.1. Block diagram of test setup

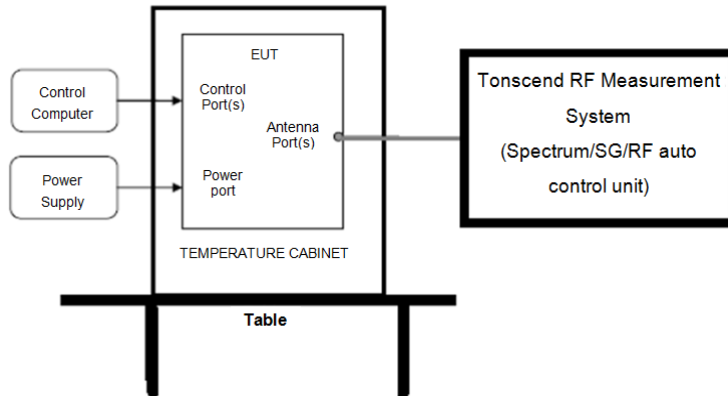

4.2. Limits

Intentional radiators operating under the alternative provisions to the general emission limits, as contained in § 15.217 through 15.257 and in Subpart E of this part, must be designed to ensure that the 20 dB bandwidth of the emission, or whatever bandwidth may otherwise be specified in the specific rule section under which the equipment operates, is contained within the frequency band designated in the rule section under which the equipment is operated.

4.3. Test Procedure

- (1) Connect EUT's antenna output to spectrum analyzer by RF cable.
- (2) Set the spectrum analyzer as follows:

RBW:	5kHz
VBW:	20kHz
Detector Mode:	Peak
Sweep time:	auto
Trace mode	Max hold
- (3) Allow the trace to stabilize, measure the 20dB bandwidth of signal.

4.4. Test Result

Mode	Freq. (MHz)	20dB bandwidth Result (kHz)	Conclusion
ASK	13.56	14.423	PASS

4.5. Original test data

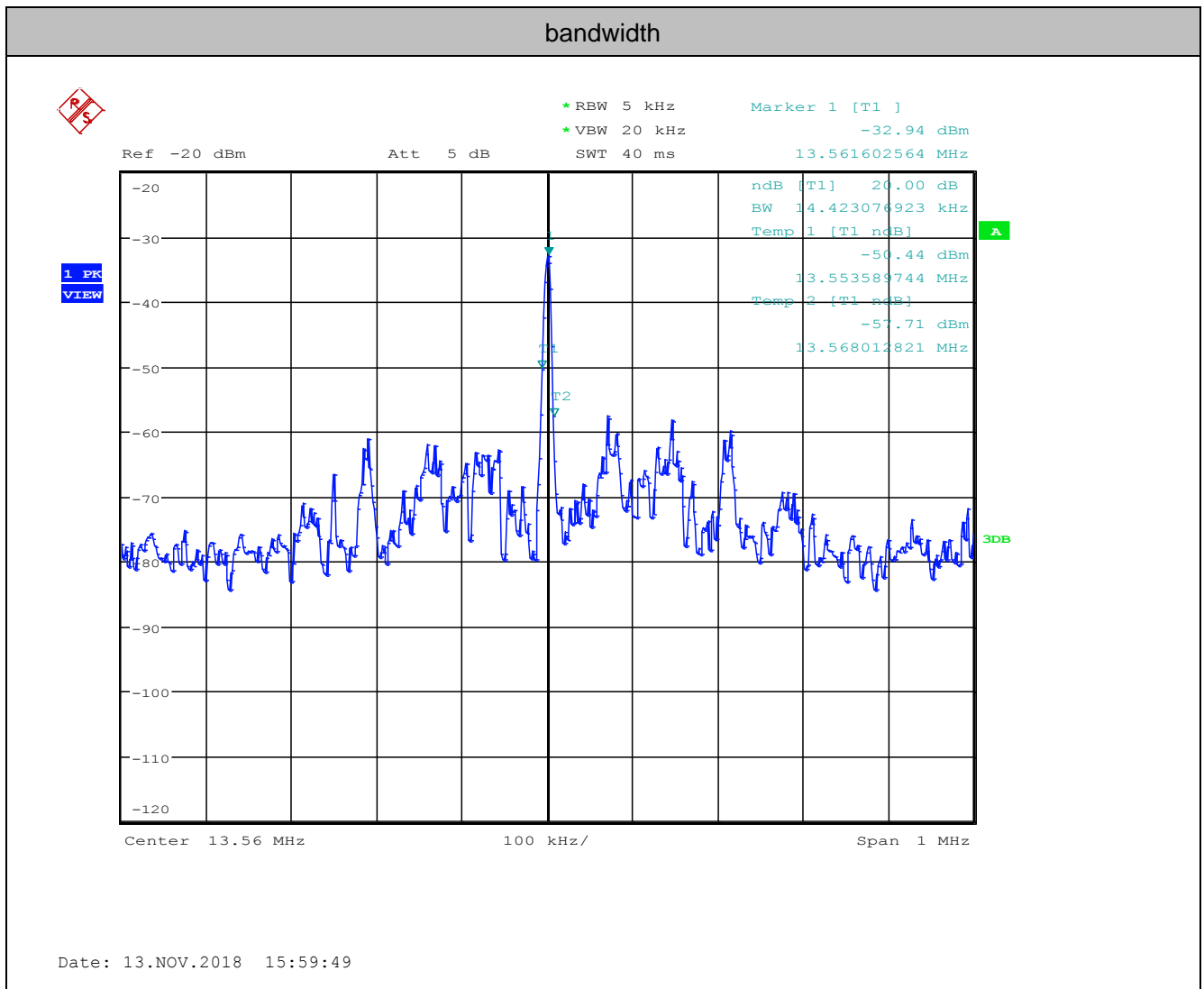

5 Frequency Tolerance

5.1. Limit

As contained in § 15.225 the frequency tolerance of the carrier signal shall be maintained within $\pm 0.01\%$ of the operating frequency over a temperature variation of -20 degrees to $+50$ degrees C at normal supply Voltage, and for a variation in the primary supply voltage from 85% to 115% of the rated supply voltage at a temperature of 20 degrees C. For battery operated equipment, the equipment tests shall be performed using a new battery.

5.2. Block diagram of test setup

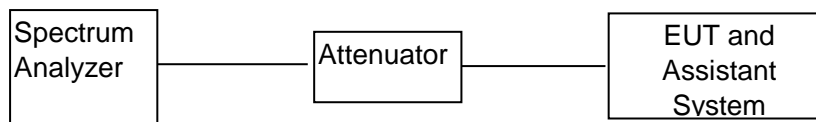

5.3. Test Procedure

(1) Connected the EUT's antenna port to the Spectrum Analyzer by suitable attenuator, set the Spectrum Analyzer as below:

Centre Frequency: The centre frequency of the channel under test.

Resolution BW: 10 KHz.

Video BW: 10 KHz.

Span: 1MHz.

Detector: Peak.

Trace Mode: Max Hold.

(2) When the trace is complete, find the peak value of the power envelope and record the frequency.

5.4. Test result

Mode	Condition		Result			Limit ppm
	Temperature (°C)	Voltage (V)	Measured (MHz)	Tolerance (kHz)	Tolerance (ppm)	
Carrier Tx Mode	NT	NV	13.5606	0.60	44.25	100
	-20	NV	13.5606	0.60	44.25	100
	50	NV	13.5606	0.60	44.25	100
	NT	DC 10.2	13.5605	0.50	36.87	100
	NT	DC 13.8	13.5606	0.60	44.25	100

Note: NT:20°C, NV:DC 12V

6 Radiated emission

6.1. Block diagram of test setup

In 3m Anechoic Chamber Test Setup Diagram for 9kHz~30MHz

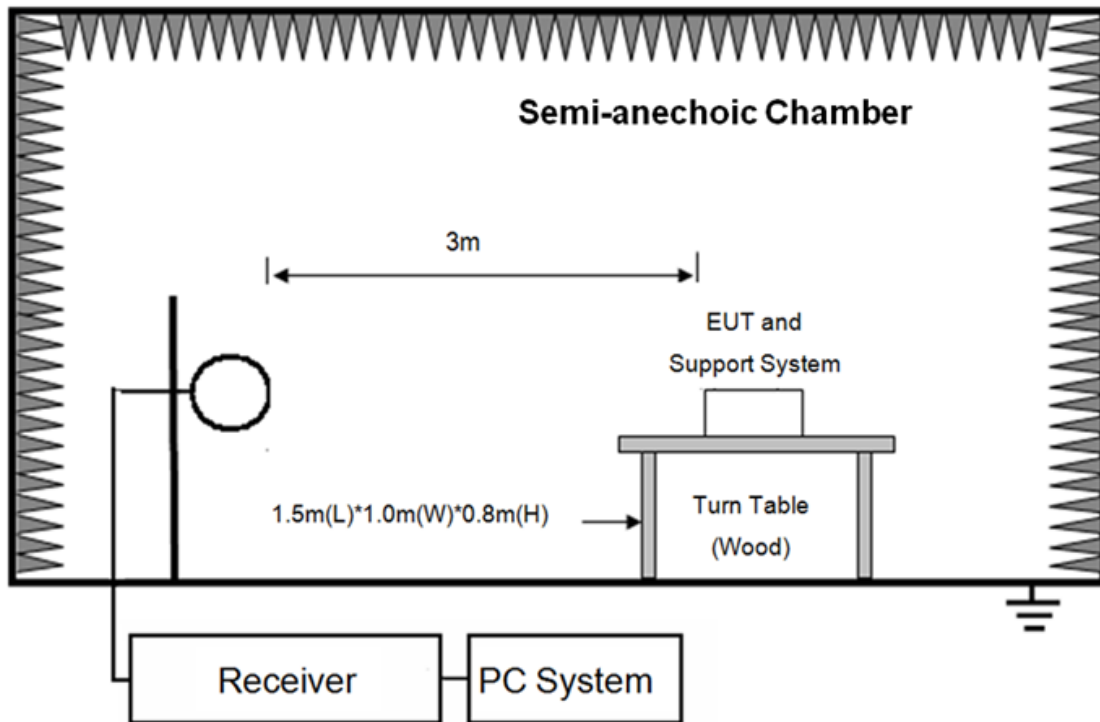

In 3m Anechoic Chamber Test Setup Diagram for 30MHz~1GHz

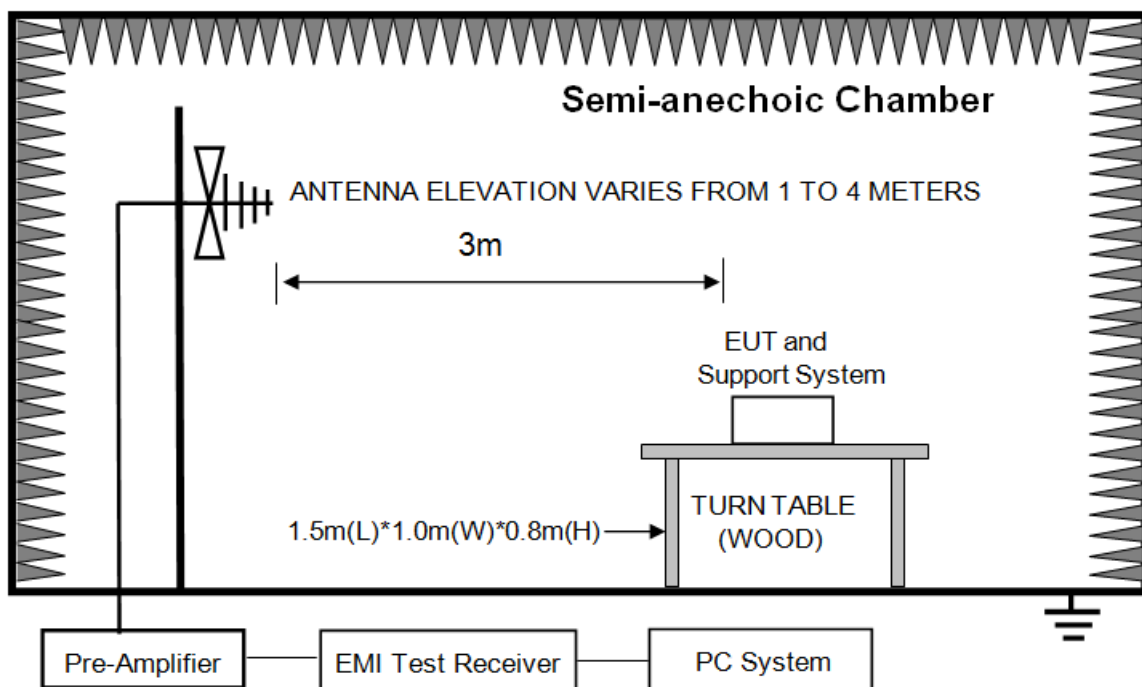

6.2. Limit

Operation within the band 13.110-14.010 MHz as contained in §15.225:

- (a) The field strength of any emissions within the band 13.553-13.567 MHz shall not exceed 15,848 microvolts/meter at 30 meters.
- (b) Within the bands 13.410-13.553 MHz and 13.567-13.710 MHz, the field strength of any emissions shall not exceed 334 microvolts/meter at 30 meters.
- (c) Within the bands 13.110-13.410 MHz and 13.710-14.010 MHz the field strength of any emissions shall not exceed 106 microvolts/meter at 30 meters.
- (d) The field strength of any emissions appearing outside of the 13.110-14.010 MHz band shall not exceed the general radiated emission limits in §15.209.

FREQUENCY MHz	DISTANCE Meters	FIELD STRENGTHS LIMIT	
		$\mu\text{V}/\text{m}$	$\text{dB}(\mu\text{V})/\text{m}$
0.009 ~ 0.490	300	$2400/\text{F}(\text{KHz})$	$67.6-20\log(\text{F})$
0.490 ~ 1.705	30	$24000/\text{F}(\text{KHz})$	$87.6-20\log(\text{F})$
1.705 ~ 13.110	30	30	29.54
13.110 ~ 13.410	30	106	40.51
13.410~ 13.553	30	334	50.47
13.553~13.567	30	15848	84.00
13.567~13.710	30	334	50.47
13.710~14.010	30	106	40.51
14.010~30	30	30	29.54
30 ~ 88	3	100	40.0
88 ~ 216	3	150	43.5
216 ~ 960	3	200	46.0
960 ~ 1000	3	500	54.0

Note: (1)The emission limits shown in the above table are based on measurements employing a CISPR QP detector except for the frequency bands 9-90KHz, 110-490KHz and above 1000MHz.Radiated emissions limits in these three bands are based on measurements employing an average detector.

(2) At frequencies below 30MHz, measurement may be performed at a distance closer than that specified, and the limit at closer measurement distance can be extrapolated by below formula:

$$\text{Limit}_{3\text{m}}(\text{dBuV}/\text{m}) = \text{Limit}_{300\text{m}}(\text{dBuV}/\text{m}) + 40\text{Log}(300\text{m}/3\text{m}) = \text{Limit}_{300\text{m}}(\text{dBuV}/\text{m}) + 80$$

$$\text{Limit}_{3\text{m}}(\text{dBuV}/\text{m}) = \text{Limit}_{30\text{m}}(\text{dBuV}/\text{m}) + 40\text{Log}(30\text{m}/3\text{m}) = \text{Limit}_{30\text{m}}(\text{dBuV}/\text{m}) + 40$$

FREQUENCY MHz	DISTANCE Meters	FIELD STRENGTHS LIMIT $\text{dB}(\mu\text{V})/\text{m}$
0.009 ~ 0.490	3	$147.6-20\log(\text{F})$
0.490 ~ 1.705	3	$127.6-20\log(\text{F})$
1.705 ~ 13.110	3	69.54
13.110 ~ 13.410	3	80.51
13.410 ~ 13.553	3	90.47

13.553 ~ 13.567	3	124.00
13.567 ~ 13.710	3	90.47
13.710 ~ 14.010	3	80.51
14.010 ~ 30	3	69.54
30 ~ 88	3	40.00
88 ~ 216	3	43.50
216 ~ 960	3	46.00
960 ~ 1000	3	54.00

6.3. Test Procedure

(1) EUT was placed on a non-metallic table, 100 cm above the ground plane inside a semi-anechoic chamber.

(2) Test antenna was located 3m from the EUT on an adjustable mast, and the antenna used as below table.

Test frequency range	Test antenna used	Test antenna distance
9KHz-30MHz	Active Loop antenna	3m
30MHz-1GHz	Trilog Broadband Antenna	3m

According ANSI C63.10:2013 clause 6.4.4.2 and 6.5.3, for measurements below 30 MHz, the loop antenna was positioned with its plane vertical from the EUT and rotated about its vertical axis for maximum response at each azimuth position around the EUT. And the loop antenna also be positioned with its plane horizontal at the specified distance from the EUT. The center of the loop is 1 m above the ground. for measurement above 30MHz, the Trilog Broadband Antenna or Horn Antenna was located 3m from EUT, Measurements were made with the antenna positioned in both the horizontal and vertical planes of Polarization, and the measurement antenna was varied from 1 m to 4 m. in height above the reference ground plane to obtain the maximum signal strength.

(3) Below pre-scan procedure was first performed in order to find prominent frequency spectrum radiated emissions from 9KHz to 1GHz:

(a) Scanning the peak frequency spectrum with the antenna specified in step (3), and the EUT was rotated 360 degree, the antenna height was varied from 1m to 4m(Except loop antenna, it's fixed 1m above ground.)

(b) Change work frequency or channel of device if practicable.

(c) Change modulation type of device if practicable.

(d) Rotated EUT though three orthogonal axes to determine the attitude of EUT arrangement produces highest emissions. Spectrum frequency from 9KHz to 1GHz (tenth harmonic of fundamental frequency) was investigated.

(4) For final emissions measurements at each frequency of interest, the EUT was rotated and the antenna height was varied between 1m and 4m in order to maximize the emission. Measurements in both horizontal and vertical polarities were made and the data was

recorded. In order to find the maximum emission, the relative positions of equipments and all of the interface cables were changed according to ANSI C63.10 2013 on Radiated Emission test.

(5) The emissions from 9KHz to 1GHz were measured based on CISPR QP detector except for the frequency bands 9-90KHz, 110-490KHz, for emissions from 9KHz-90KHz,110KHz-490KHz and above 1GHz were measured based on average detector, for emissions above 1GHz, peak emissions also be measured and need comply with Peak limit.

(6) The emissions from 9KHz to 1GHz, QP or average values were measured with EMI receiver with below RBW.

Frequency band	RBW
9KHz-150KHz	200Hz
150KHz-30MHz	9KHz
30MHz-1GHz	120KHz

6.4. Test result

PASS. (See below detailed test result)

Frequency (MHz)	Result @3m (dBuV/m)	Limit @3m (dBuV/m)	Detector	Conclusion
0.050	55.97	113.62	Average	PASS
0.050	59.23	133.62	Peak	PASS
0.080	56.07	109.54	Average	PASS
0.080	58.85	119.54	Peak	PASS
0.100	49.05	107.60	QP	PASS
5.200	54.67	69.54	QP	PASS
13.110	51.60	69.54	QP	PASS
14.010	50.61	69.54	QP	PASS
13.410	51.03	80.50	QP	PASS
13.710	50.12	80.50	QP	PASS
13.553	56.14	90.50	QP	PASS
13.560	71.95	124.00	QP	PASS
13.567	56.33	90.50	QP	PASS
21.490	50.79	69.54	QP	PASS

TR-4-E-009 Radiated Emission Test Result

Test Site : DDT 3m Chamber 1#

D:\2018 RE1# Report Data\Q18101701-1E DHS Audi Q7
NFC\FCC 30-1G.EM6

Test Date : 2018-11-12

Tested By : Talent

EUT : DHS Audi Q7 NFC

Model Number : DHSQ7NFC

Power Supply : DC12V

Test Mode : Tx mode

Condition : Temp:24.5'C, Humi:55.5%,
Press:100.1kPa

Antenna/Distance : 2018 VULB 9161/3m/VERTICAL

Memo :

Data: 7

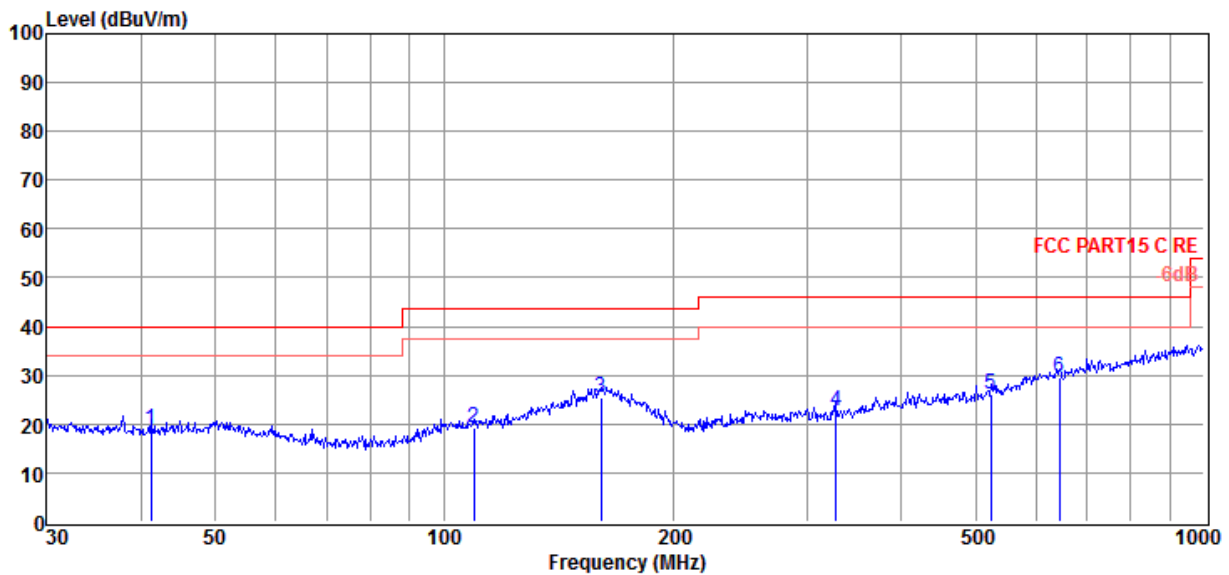

Item (Mark)	Freq. (MHz)	Read Level (dBμV)	Antenna Factor (dB/m)	Cable Loss dB	Result Level (dBμV/m)	Limit Line (dBμV/m)	Over Limit (dB)	Detector	Polarization
1	41.13	2.88	12.13	3.89	18.90	40.00	-21.10	QP	VERTICAL
2	109.41	1.69	12.94	4.49	19.12	43.50	-24.38	QP	VERTICAL
3	160.91	1.91	18.67	4.83	25.41	43.50	-18.09	QP	VERTICAL
4	327.89	3.46	13.44	5.65	22.55	46.00	-23.45	QP	VERTICAL
5	524.55	3.00	17.43	5.67	26.10	46.00	-19.90	QP	VERTICAL
6	645.12	3.24	19.35	6.83	29.42	46.00	-16.58	QP	VERTICAL

Note: 1. Result Level = Read Level + Antenna Factor + Cable loss.

2. If Peak Result complies with QP limit, QP Result is deemed to comply with QP limit.

3. Test setup: RBW: 120 kHz, VBW: 300 kHz, Sweep time: auto.

TR-4-E-009 Radiated Emission Test Result

Test Site : DDT 3m Chamber 1#
Test Date : 2018-11-12
EUT : DHS Audi Q7 NFC
Power Supply : DC12V
Condition : Temp:24.5'C, Humi:55.5%, Press:100.1kPa
Memo :

D:\2018 RE1# Report Data\Q18101701-1E DHS Audi Q7 NFC\FCC 30-1G.EM6
Tested By : Talent
Model Number : DHSQ7NFC
Test Mode : Tx mode
Antenna/Distance : 2018 VULB 9161/3m/HORIZONTAL

Data: 8

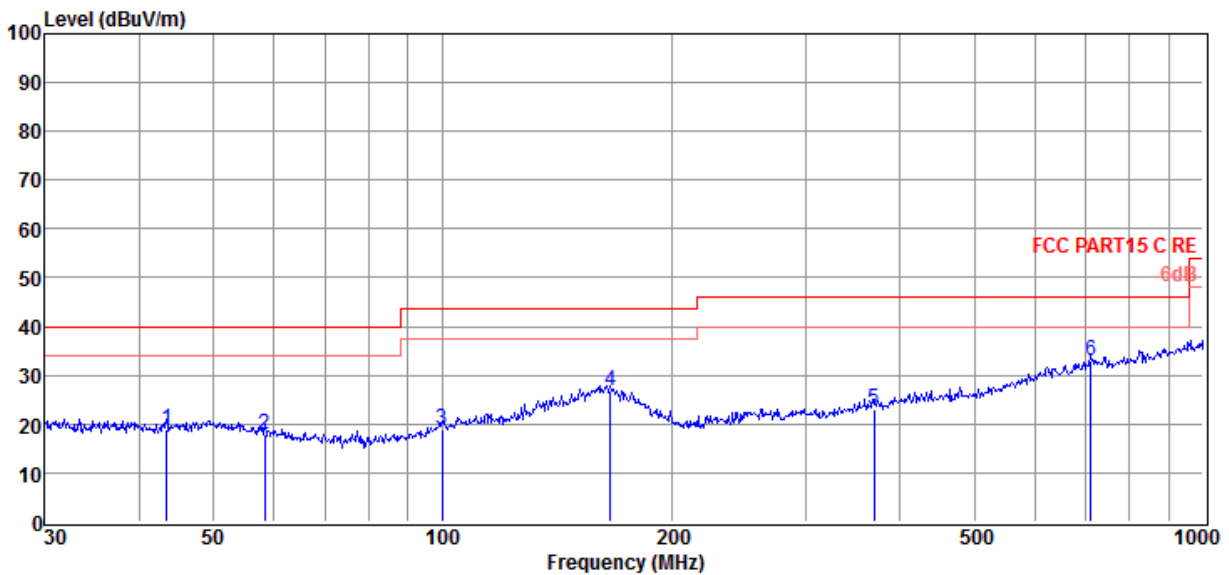

Item (Mark)	Freq. (MHz)	Read Level (dBμV)	Antenna Factor (dB/m)	Cable Loss (dB)	Result Level (dBμV/m)	Limit Line (dBμV/m)	Over Limit (dB)	Detector	Polarization
1	43.35	2.29	12.61	3.91	18.81	40.00	-21.19	QP	HORIZONTAL
2	58.41	2.94	10.96	4.08	17.98	40.00	-22.02	QP	HORIZONTAL
3	99.88	1.97	12.36	4.41	18.74	43.50	-24.76	QP	HORIZONTAL
4	166.07	3.30	18.78	4.86	26.94	43.50	-16.56	QP	HORIZONTAL
5	369.41	2.34	14.97	5.83	23.14	46.00	-22.86	QP	HORIZONTAL
6	711.67	5.50	20.38	7.05	32.93	46.00	-13.07	QP	HORIZONTAL

Note: 1. Result Level = Read Level + Antenna Factor + Cable loss.
 2. If Peak Result complies with QP limit, QP Result is deemed to comply with QP limit.
 3. Test setup: RBW: 120 kHz, VBW: 300 kHz, Sweep time: auto.

7 Power Line Conducted Emission

7.1. Block diagram of test setup

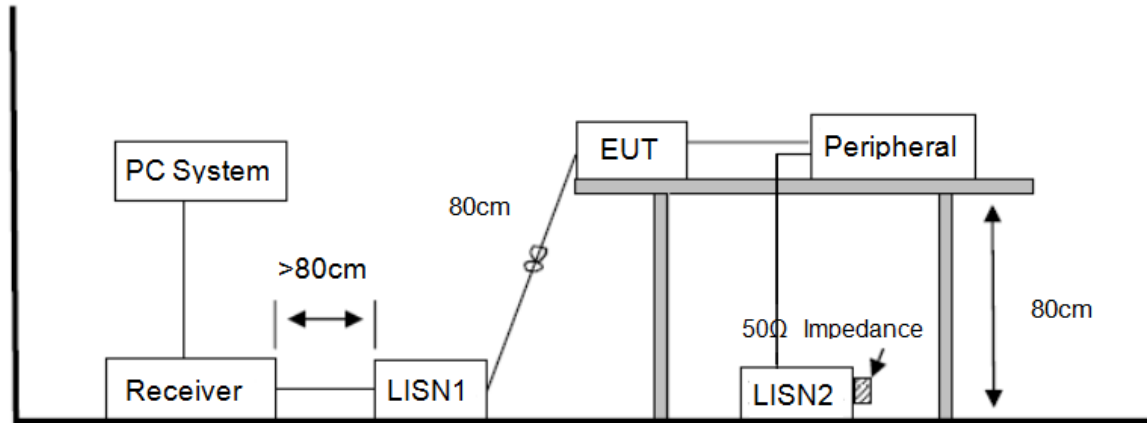

7.2. Power Line Conducted Emission Limits

Frequency	Quasi-Peak Level dB(μ V)	Average Level dB(μ V)
150kHz ~ 500kHz	66 ~ 56*	56 ~ 46*
500kHz ~ 5MHz	56	46
5MHz ~ 30MHz	60	50

Note 1: * Decreasing linearly with logarithm of frequency.

Note 2: The lower limit shall apply at the transition frequencies.

7.3. Test Procedure

The EUT and Support equipment, if needed, were put placed on a non-metallic table, 80cm above the ground plane.

Configuration EUT to simulate typical usage as described in clause 2.4 and test equipment as described in clause 10.2 of this report.

All I/O cables were positioned to simulate typical actual usage as per ANSI C63.10.

All support equipment power received from a second LISN.

Emissions were measured on each current carrying line of the EUT using an EMI Test Receiver connected to the LISN powering the EUT.

The Receiver scanned from 150 kHz to 30MHz for emissions in each of the test modes.

During the above scans, the emissions were maximized by cable manipulation.

The test mode(s) described in clause 2.4 were scanned during the preliminary test.

After the preliminary scan, we found the test mode producing the highest emission level.

The EUT configuration and worse cable configuration of the above highest emission levels were recorded for reference of the final test.

EUT and support equipment were set up on the test bench as per the configuration with highest emission level in the preliminary test.

A scan was taken on both power lines, Neutral and Line, recording at least the six highest emissions.

Emission frequency and amplitude were recorded into a computer in which correction factors were used to calculate the emission level and compare reading to the applicable limit.

The test data of the worst-case condition(s) was recorded.

The bandwidth of test receiver is set at 9 KHz.

7.4. Test Result

Not Applicable

According to 15.207(C): Measurements to demonstrate compliance with the conducted limits are not required for devices which only employ battery power for operation and which do not operate from the AC power lines or contain provisions for operation while connected to the AC power lines.

8 Antenna Requirements

For intentional device, according to FCC 47 CFR Section 15.203, An intentional radiator shall be designed to ensure that no antenna other than that furnished by the responsible party shall be used with the device. The use of a permanently attached antenna or of an antenna that uses a unique coupling to the intentional radiator shall be considered sufficient to comply with the provisions of this section. The manufacturer may design the unit so that a broken antenna can be replaced by the user, but the use of a standard antenna jack or electrical connector is prohibited.

END OF REPORT