

PRODUCT OVERVIEW

FOR HOMOLOGATION USAGE

Project: Door Handle Sensor AUDI B9 NFC

Homologation Id.: CE/ KR5DHSB9NFC

Product name	Variant	Continental Part number	Audi Part number
DHS Audi B9 NFC - L	NFC Left	A2C14976701	8W1 927 753
DHS Audi B9 NFC - R	NFC Right	A2C14976801	8W1 927 754

History:

Date	Version	Maturity	Short description
2018-02-21	AA	Draft	Creation for B9NFC project
2018-03-14	AB	Draft	Technical description – usage for homologation
2018-03-19	AC	Release	Homologation market Set-up with Test tool quick start

Designed by Thierry Guidet		Date	Department	
Released by				
	Designation			
	IMS ID nr	Version AC	Document version as of mars 21, 2018	Pages 1 of 35

Transmittal, reproduction, dissemination and/or editing of this document as well as utilization of its contents and communication thereof to others without express authorization are prohibited.

Offenders will be held liable for payment of damages. All rights created by patent grant or registration of a utility model or design patent are reserved.

1. Table Of Content

2.	General	4
2.1.	Contact	4
2.2.	Glossary	4
2.3.	Validity and Track changes	5
3.	Power of attorney	6
4.	Confidentiality Request Letter	6
5.	General form	7
6.	Antenna Data Information	8
7.	Block diagram and technical description of the block diagram	9
7.1.	Example of sensor use	9
8.	Electrical diagrams	10
8.1.	Electronics Structure and Interface.....	10
8.1.1.	Electronics Block Diagram	10
8.1.2.	Operating Temperature Range.....	10
8.1.3.	Operating Voltage Range.....	10
8.1.4.	Sleep Power Consumption	12
8.1.5.	CAN Voltage Range.....	12
8.1.6.	CAN Communication	12
9.	Technical specifications.....	13
9.1.	Type of Sensor	13
9.2.	Sensor Functions	13
9.3.	Misuse Protections	14
9.4.	NFC Reader Principle	14
9.5.	NFC Communication Module	15
9.5.1.	NFC Communication - Transceiver	15
9.5.2.	NFC Matching	15
9.5.3.	NFC Antenna Positioning.....	16
9.5.4.	NFC Antenna Distance	16
9.5.5.	NFC Actuator test	17
9.6.	Connector requirements	18

Designed by Thierry Guidet		Date	Department	
Released by				
	Designation			
	IMS ID nr	Version AC	Document version as of mars 21, 2018	Pages 2 of 35

Transmittal, reproduction, dissemination and/or editing of this document as well as utilization of its contents and communication thereof to others without express authorization are prohibited.

Offenders will be held liable for payment of damages. All rights created by patent grant or registration of a utility model or design patent are reserved.

9.6.1.	ConnectorA Reference	18
9.6.2.	Connector B Reference.....	19
9.7.	Variants.....	20
9.7.1.	Right/Left Variants.....	20
10.	Photographs	21
11.	Operational description.....	22
11.1.	Actuator test.....	22
12.	Bill of materials.....	24
13.	Mechanical diagrams.....	24
14.	Risk Assessment	25
15.	Product label design	26
16.	User manual	26
17.	Homologation setup.....	26
17.1.	General Test conditions.....	26
18.	Delivery parts	27
19.	Testing tool.....	27
19.1.	DHS connection instructions:	28
19.2.	Test box signals description:	30
19.3.	Test Box procedure.....	34
19.3.1.	Test box function:.....	34

Designed by Thierry Guidet		Date	Department	
Released by				
	Designation			
	IMS ID nr	Version AC	Document version as of mars 21, 2018	Pages 3 of 35

Transmittal, reproduction, dissemination and/or editing of this document as well as utilization of its contents and communication thereof to others without express authorization are prohibited.

Offenders will be held liable for payment of damages. All rights created by patent grant or registration of a utility model or design patent are reserved.

2. General

2.1. Contact

Function:	Name:	Email	Phone
Project Leader	Steffen Eckhardt	Steffen.eckhardt@continental.com	(+33) 56119
Homologation contact	Said Bouguern	Said.bouguern@continental.com	
System Engineer	Thierry Guidet	Thierry.guidet@continental.com	(+33) 56119 5740
Electronic Engineer	Joel Carniaux		
Mechanical Engineer	Florian Brunet		
Software Engineer	Thomas Canova		

2.2. Glossary

D5/Q7/B9:	Audi platforms names
DH:	Door Handle (means Outside Door Handle)
DHS:	Door Handle Sensor Module (Unlock and Lock capacitive sensors)
LF:	Low Frequency (125kHz signal for communication from ECU to Keyfob)
RF:	Radio-Frequency (433 MHz signal for communication from Keyfob to ECU)
ECU:	Electronic Control Unit
BCM:	Body Controller Module
NFC :	Near Field Communication
PCD :	Proximity Coupling Device (the Reader)
PICC :	Proximity Integrated Circuit Card (the Smartcard/the Smartphone)
HW:	Hardware
SW:	Software
RT:	Room Temperature
DV:	Design Validation
PV:	Product Validation
EMC:	Electro Magnetic Compatibility
FMTT:	Flash Monitoring and Tuning Tool (Continental Development Tool)
FMDD:	Continental Development Tool replacing the FMTT

Designed by Thierry Guidet		Date	Department	
Released by				
	Designation			
	IMS ID nr	Version AC	Document version as of mars 21, 2018	Pages 4 of 35

Transmittal, reproduction, dissemination and/or editing of this document as well as utilization of its contents and communication thereof to others without express authorization are prohibited.

Offenders will be held liable for payment of damages. All rights created by patent grant or registration of a utility model or design patent are reserved.

2.3. Validity and Track changes

Items or parameters values changed compared to previous revision are highlighted in yellow.

Items or parameters values to be defined or to be confirmed are highlighted in blue.

Designed by Thierry Guidet		Date	Department	
Released by		Designation		
	IMS ID nr	Version AC	Document version as of mars 21, 2018	Pages 5 of 35

Transmittal, reproduction, dissemination and/or editing of this document as well as utilization of its contents and communication thereof to others without express authorization are prohibited.

Offenders will be held liable for payment of damages. All rights created by patent grant or registration of a utility model or design patent are reserved.

3. Power of attorney

"To authorize DEKRA to act as approvals agent.

Templates provided by DEKRA Testing and Certification, S.A.U."



EU Agent letter



FCC Agent letter

4. Confidentiality Request Letter

"Required for USA, to ask for Long Term and/or Short Term Confidentiality.

Template provided by DEKRA Testing and Certification, S.A.U."



FCC Confidentiality request Letter

Designed by Thierry Guidet		Date	Department	
Released by				
	Designation			
	IMS ID nr	Version AC	Document version as of mars 21, 2018	Pages 6 of 35

Transmittal, reproduction, dissemination and/or editing of this document as well as utilization of its contents and communication thereof to others without express authorization are prohibited.

Offenders will be held liable for payment of damages. All rights created by patent grant or registration of a utility model or design patent are reserved.

5. General form

General data to be included in the test reports

Countries homologation list

Country	Applicable normative
Austria	CE
Belgium	CE
Bulgaria	CE
Croatia	CE
Czech Republic	CE
Danmark	CE
Estonia	CE
Finland	CE
France	CE
Germany	CE
Great Britain / North Ireland	CE
Greece	CE
Hungary	CE
Ireland	CE
Italy (San Marino, Vatican)	CE
Latvia	CE
Lithuania	CE
Luxemburg	CE
Malta	CE
Netherlands	CE
Norway	CE
Poland	CE
Portugal	CE
Romania	CE
Slovenia	CE
Slowak Republic	CE
Spain (Andorra, Balearic Islans, Canay Islands)	CE
Sweden	CE
Switzerland	CE
Turkey	CE
USA	FCC

Designed by Thierry Guidet		Date	Department	
Released by		Designation		
	IMS ID nr	Version AC	Document version as of mars 21, 2018	Pages 7 of 35

Transmittal, reproduction, dissemination and/or editing of this document as well as utilization of its contents and communication thereof to others without express authorization are prohibited.

Offenders will be held liable for payment of damages. All rights created by patent grant or registration of a utility model or design patent are reserved.

6. Antenna Data Information

Right Foil antenna

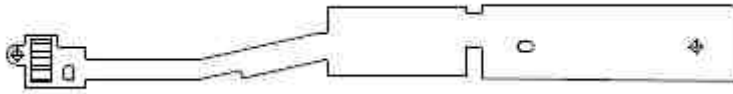

Left Foil antenna

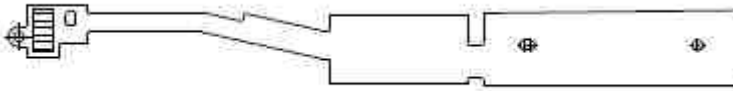

Designed by Thierry Guidet		Date	Department	
Released by				
Continental	Designation			
	IMS ID nr	Version AC	Document version as of mars 21, 2018	Pages 8 of 35

Transmittal, reproduction, dissemination and/or editing of this document as well as utilization of its contents and communication thereof to others without express authorization are prohibited.

Offenders will be held liable for payment of damages. All rights created by patent grant or registration of a utility model or design patent are reserved.

7. Block diagram and technical description of the block diagram

"The signal path and the frequency shall be indicated at each block.

Oscillators must be shown. "

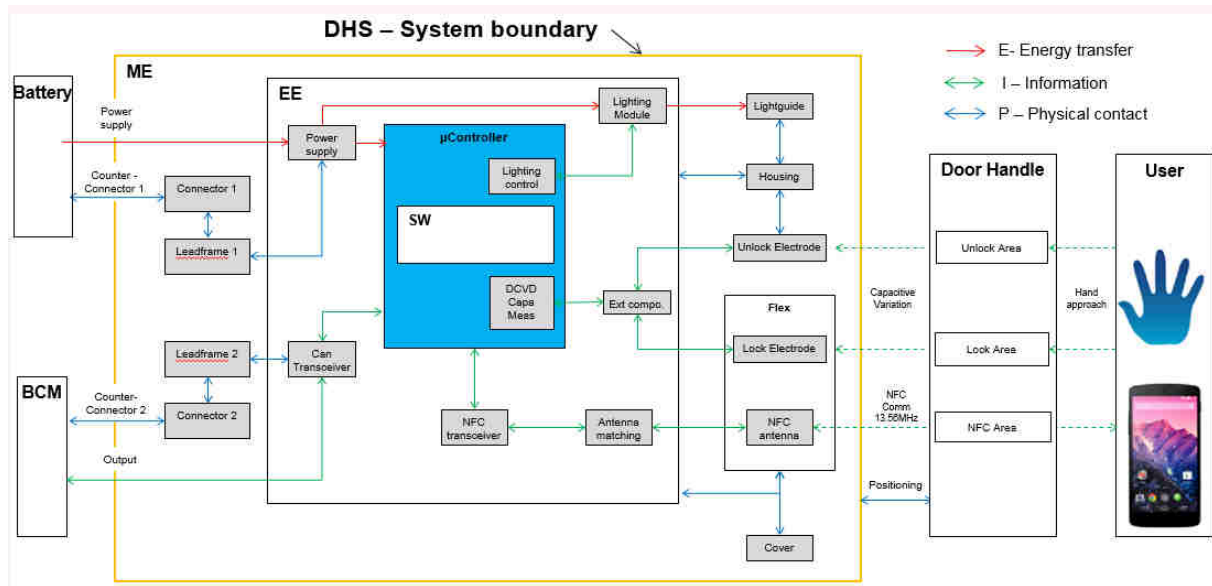

7.1. Example of sensor use

Example of Vehicle Access Process (Unlocking):

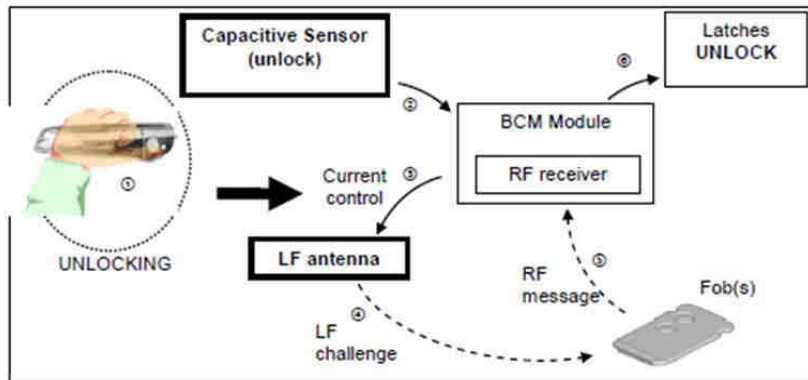

As the user's hand approaches the capacitive sensor UNLOCK detection area, sensor communicates detection to BCM Module. Then, the corresponding LF antenna on front side is driven by system to send LF challenge to fob(s) to perform the user's identification process.

The same principle is used to Lock the vehicle, with a capacitive sensor LOCK detection area.

Designed by Thierry Guidet		Date	Department	
Released by				
	Designation			
	IMS ID nr	Version AC	Document version as of mars 21, 2018	Pages 9 of 35

Transmittal, reproduction, dissemination and/or editing of this document as well as utilization of its contents and communication thereof to others without express authorization are prohibited.

Offenders will be held liable for payment of damages. All rights created by patent grant or registration of a utility model or design patent are reserved.

The NFC device tap is used to toggle the vehicle locking status.

8. Electrical diagrams

8.1. Electronics Structure and Interface

8.1.1. Electronics Block Diagram

The Electronics shall be compliant with the following Block Diagram.

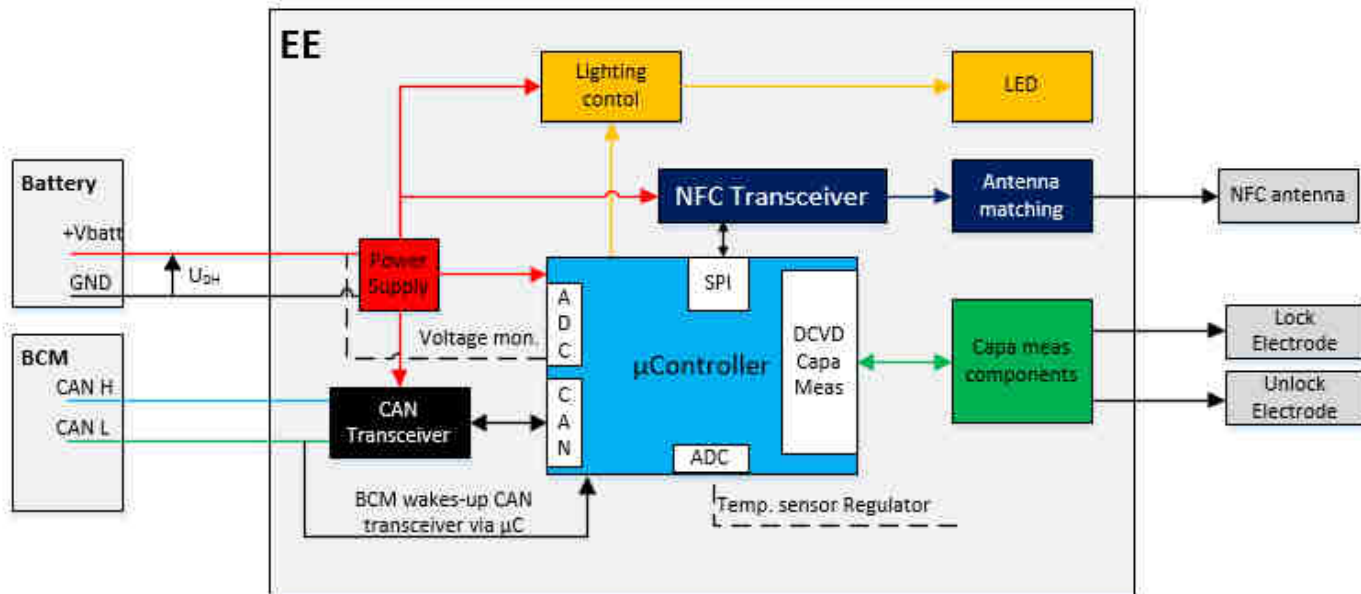

8.1.2. Operating Temperature Range

The Electronic Design shall guaranty all electrical parameters over operating Temperature range - 40°C to +70°C, unless otherwise stated.

Components that are subjet to heat dissipation (regulator, LED, resistances...) shall be fonctionnal in the Temperature range -40°C to +125°C.

8.1.3. Operating Voltage Range

The Electronic Design shall guaranty all electrical parameters over operating Voltage range $U_{DH} = 8V$ to 16V, unless otherwise stated.

Peak Power Consumption

The Electronic Design shall guarantee the following peak power consumption:

Designed by Thierry Guidet		Date	Department	
Released by				
	Designation			
	IMS ID nr	Version AC	Document version as of mars 21, 2018	Pages 10 of 35

Transmittal, reproduction, dissemination and/or editing of this document as well as utilization of its contents and communication thereof to others without express authorization are prohibited.

Offenders will be held liable for payment of damages. All rights created by patent grant or registration of a utility model or design patent are reserved.

Parameter	Description	Min	Typ	Max	U.	Comments
IqpkOFF	Peak Quiescent Current		220	290	mA	μController Awake, NFC polling CAN On Lighting ON

Designed by Thierry Guidet		Date	Department	
Released by		Designation		
	IMS ID nr	Version AC	Document version as of mars 21, 2018	Pages 11 of 35

Transmittal, reproduction, dissemination and/or editing of this document as well as utilization of its contents and communication thereof to others without express authorization are prohibited.

Offenders will be held liable for payment of damages. All rights created by patent grant or registration of a utility model or design patent are reserved.

8.1.4. Sleep Power Consumption

The Electronic Design shall guarantee the following power consumption in Sleep Mode:

Parameter	Description	Min	Typ	Max	U.	Comments
Iq_low	Quiescent Current in Sleep Mode			67	μA	μController in Sleep Mode, No NFC polling No Capacitive Measurement CAN in Sleep Mode

8.1.5. CAN Voltage Range

The Electronic Design shall guaranty the CAN functionality (communication possible) over operating Voltage range UDH = 6V to 18V.

In case voltage exceed 18V, CAN shall not be operational more than 1 minute.

In case voltage exceed 26V, CAN shall stop immediatly the CAN communication.

Overvoltage and undervoltage are managed by self check algorithm. Thresholds have tolerances up to 27.5V.

See [Requirement 259998](#)

8.1.6. CAN Communication

The Electronics shall embed a BCM interface module, to handle CAN High-Speed Communication (500kbts/s).

Designed by Thierry Guidet		Date	Department	
Released by		Designation		
	IMS ID nr	Version AC	Document version as of mars 21, 2018	Pages 12 of 35

Transmittal, reproduction, dissemination and/or editing of this document as well as utilization of its contents and communication thereof to others without express authorization are prohibited.

Offenders will be held liable for payment of damages. All rights created by patent grant or registration of a utility model or design patent are reserved.

9. Technical specifications

Complete technical specifications: Frequency bands, EIRP, ITU designation of class of emissions, channeling, channel spacing, number of channels, channel bandwidth, method of oscillation, modulations,

9.1. Type of Sensor

This sensor is a DHS.

The DHS is a standalone module with capacitive, NFC, pocket and ground lighting.

This module is integrated into a DH, and used in Keyless Entry System, enabling 'key-free' Vehicle Unlocking and Locking.



DHS

Door Handle

9.2. Sensor Functions

The DHS has 5 main functions :

- Unlock Function : Capacitive detection with 2 detections ranges.
- Lock Function : Capacitive detection with 2 detections ranges.
- NFC Function : Read/Write function of NFC Smartcards/Smartphones.
- Pocket lighting : Illumination of the pocket of the door handle.
- Ground lighting : Illumination of the ground below the door handle

Designed by Thierry Guidet		Date	Department	
Released by				
	Designation			
	IMS ID nr	Version AC	Document version as of mars 21, 2018	Pages 13 of 35

Transmittal, reproduction, dissemination and/or editing of this document as well as utilization of its contents and communication thereof to others without express authorization are prohibited.

Offenders will be held liable for payment of damages. All rights created by patent grant or registration of a utility model or design patent are reserved.

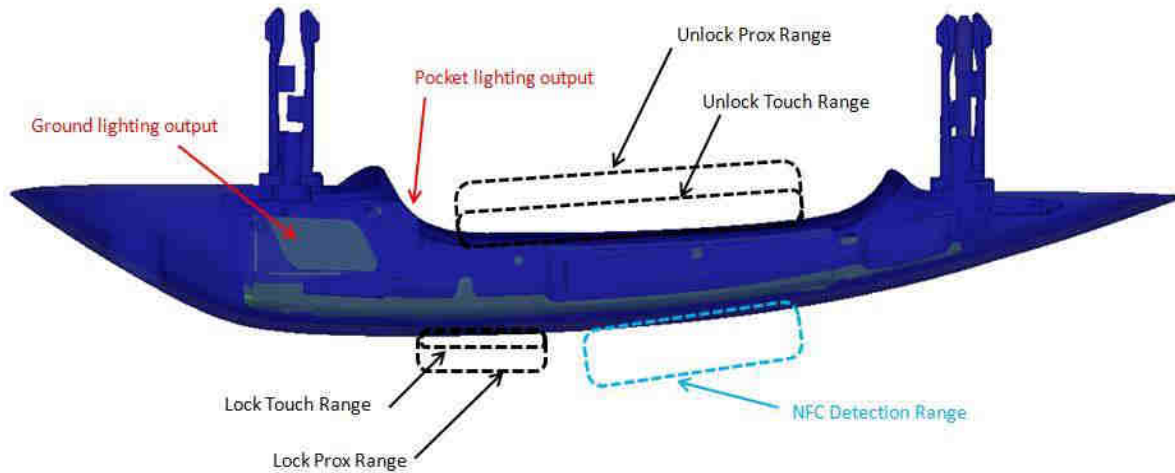

9.3. Misuse Protections

After 20 lock/unlock activations in less than 10 seconds the sensor deactivates detection functions for 30s.

After 20 NFC activations with wrong TAG in less than 10 seconds the sensor deactivates NFC function for 30s.

9.4. NFC Reader Principle

The NFC principle is based on electromagnetic coupling between 2 devices at close distance (few cm).

The PCD emits a electromagnetic field on a 13.56 Mhz carrier. It will power the PICC via Induction.

The PCD can transmit data via Miller Coding and receive data back via Load modulation.

Designed by Thierry Guidet		Date	Department	
Released by				
Continental	Designation			
	IMS ID nr	Version AC	Document version as of mars 21, 2018	Pages 14 of 35

Transmittal, reproduction, dissemination and/or editing of this document as well as utilization of its contents and communication thereof to others without express authorization are prohibited.

Offenders will be held liable for payment of damages. All rights created by patent grant or registration of a utility model or design patent are reserved.

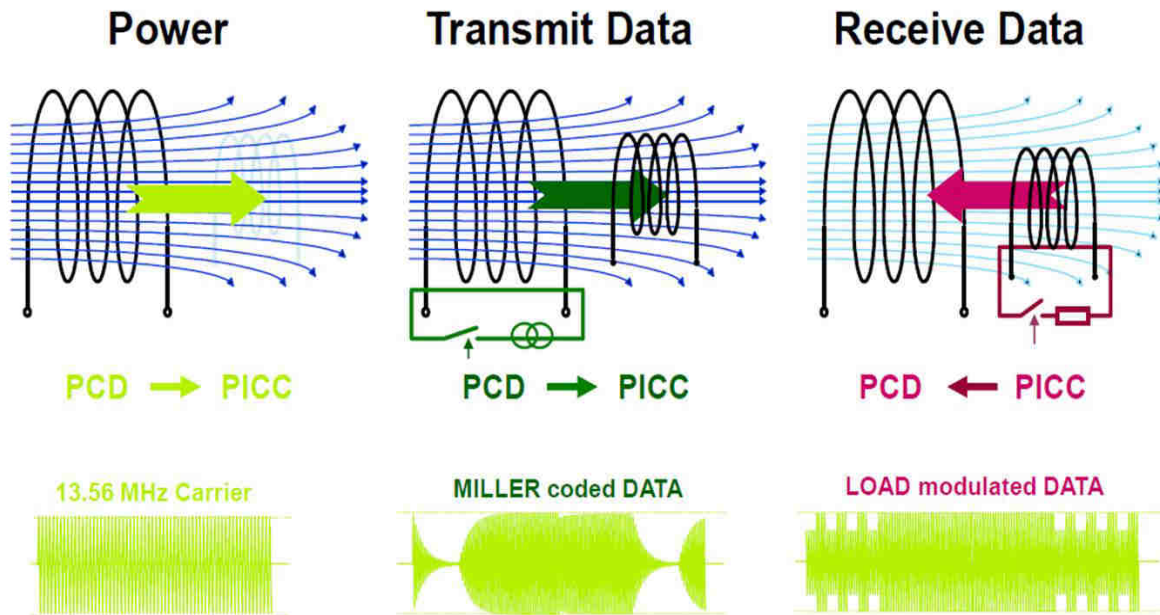

9.5. NFC Communication Module

9.5.1. NFC Communication - Transceiver

The Electronics shall embed a NFC transceiver to enable the NFC bi-directional communication.

Reference: AMS AS3914

9.5.2. NFC Matching

The Electronics shall embed matching component, in order to adapt the impedance between the NFC transceiver and the NFC Antenna. The input data for the matching is :

- Antenna Size : as defined in Requirement [259860](#)
- Antenna $L_s = 1 \mu\text{H}$ (+/-3%)
- Antenna $R_s = 1.7 \text{ Ohms}$ (+/-3%)
- Ferrite : Ferrite mandatory in order to avoid impact of PCB / Antenna relative position on NFC performance
- Quality factor $Q = 20$
- Impedance [target@13.56](#) Mhz, $Z = 40 \text{ ohms}$: This adjustment is to limit the current under 200 mA (worst case) while NFC communication (limit of regulator).
- RDSO = 0 ohm
- EMC filter frequency : 10.7MHz
- VSP RF = 3.9 V : This adjustment comes from worst case calculation on VSP RF voltage regulator.

Storage Temperature Range

The Mechanical Design shall guarantee the sensor robustness over Temperature storage range: -40°C to $+90^\circ\text{C}$.

Designed by Thierry Guidet		Date	Department	
Released by		Designation		
	IMS ID nr	Version AC	Document version as of mars 21, 2018	Pages 15 of 35

Transmittal, reproduction, dissemination and/or editing of this document as well as utilization of its contents and communication thereof to others without express authorization are prohibited.

Offenders will be held liable for payment of damages. All rights created by patent grant or registration of a utility model or design patent are reserved.

Operating Temperature Range

The Mechanical Design shall guarantee the sensor robustness over Temperature operating range: -40°C to +70°C.

Maximum temperature

The sensor PU and PCB materials shall resist to temperatures up to 115°C during 1 minute because of thermal dissipation due to Lighting module.

Housing / Cover Materials

The Housing and Cover materials shall be PBT-BASF Ultradur.

Module Sealing

The DHS shall be sealed with PolyUrethane (PU) resin.
The sealing process shall ensure absolute water tightness.

9.5.3. NFC Antenna Positioning

The NFC Antenna shall be positioned in the middle of the DH.

X-Axis : NFC Antenna shall be positioned as parallel as possible with the outer shape of the DH. (max 3°)

Z-Axis : NFC Antenna shall be positioned as parallel as possible with the outer shape of the DH. (max 3°)

9.5.4. NFC Antenna Distance

Y-Axis :The Distance from NFC Antenna to the outer shape of the DH (defined in the middle of Unlock Electrode) shall be maximum of 4 mm.

Designed by Thierry Guidet		Date	Department	
Released by				
	Designation			
	IMS ID nr	Version AC	Document version as of mars 21, 2018	Pages 16 of 35

9.5.5. NFC Actuator test

When DHS receive the frame **NFC_01** with signal **Stellgliedtest_NFC set**, the DHS shall perform the actuator test requirement as described below :

1. It shall turn on the antenna for a delay set to 10sec., and look for an external device with RF discovery polling rate as short as possible
2. If it finds an appropriate counterpart (NFC-A Type 4), it shall activate and send the SELECT command.
3. It shall feedback the result by changing the parameter "authenticated NFC-counterpart"

The DHS Application shall execute the actuator test (when requested) at any time regardless of the Misuse or K15 State and ESM.

It is required that the field is turned on during the complete duration of the actuator test.

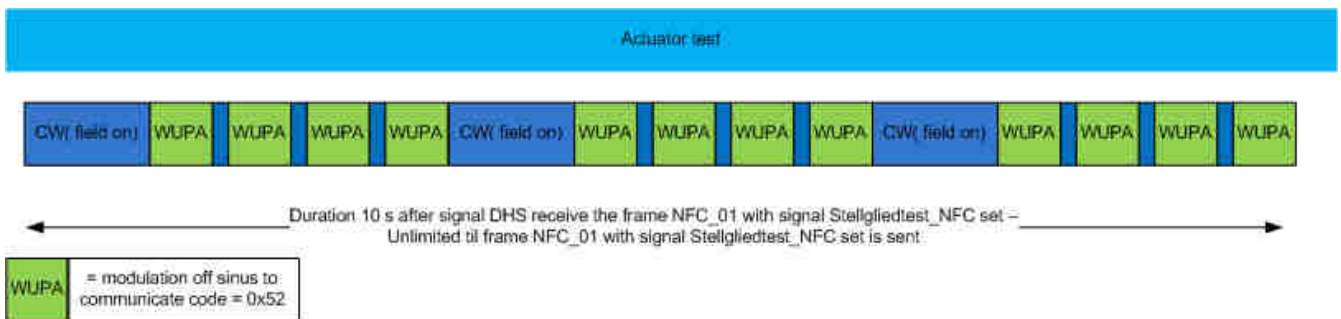

REQA is replaced by WUPA to ensure several communication possible whereas field is kept on.

The DHS shall stop the actuator test if:

- Stopped by Test box
- After 10sec if no Test Box connected to the DUT (Actuator mode test set by CAN, for example)

Designed by Thierry Guidet		Date	Department	
Released by		Designation		
	IMS ID nr	Version AC	Document version as of mars 21, 2018	Pages 17 of 35

9.6. Connector requirements

The DHS shall integrate 2 overmolded connectors : Connector A and Connector B.
Connectors position is described below.

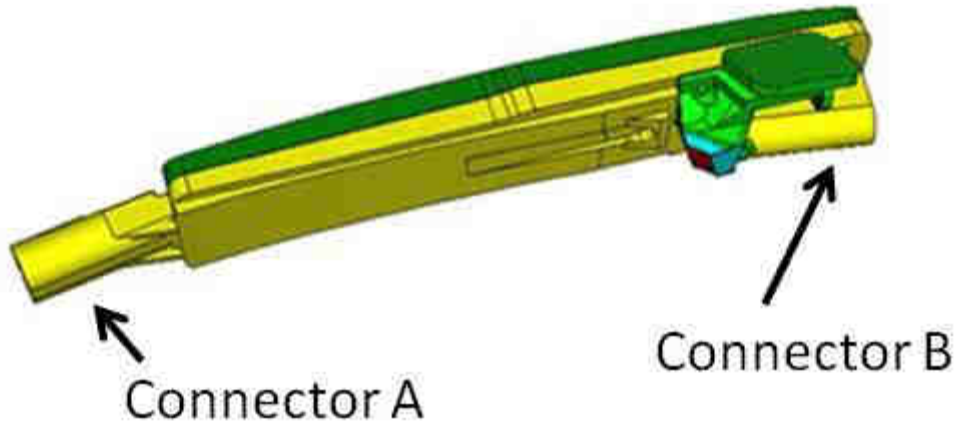

9.6.1. ConnectorA Reference

Connector A Designation: Hirschmann MSC 1.2 - 2 ways - Variant 1- **Coding B**

Reference: Hirschmann 8W0_900_962_D

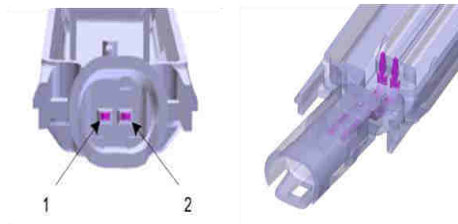

The coding shall be identical for all variants (Left/Right).

ConnectorA Pinout

Pin number	Pin Name	Wire Color*	Signal Description
1	Vbatt	Grey	KI30 - Power Supply
2	Gnd	Black	KI31 - Electrical Ground

*Wire color is only an indication for development (connector integrated in DHS housing)

Designed by Thierry Guidet		Date	Department	
Released by		Designation		
	IMS ID nr	Version AC	Document version as of mars 21, 2018	Pages 18 of 35

Transmittal, reproduction, dissemination and/or editing of this document as well as utilization of its contents and communication thereof to others without express authorization are prohibited.

Offenders will be held liable for payment of damages. All rights created by patent grant or registration of a utility model or design patent are reserved.

9.6.2. Connector B Reference

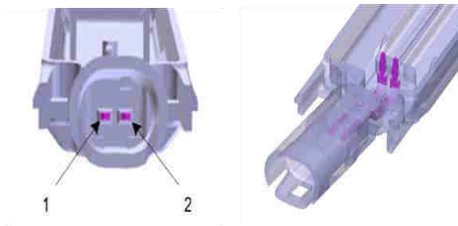
Connector B Designation: Hirschmann MSC 1.2 - 2 ways - Variant 1- **Coding A**
Reference: Hirschmann 8W0_900_962_D

The coding shall be identical for all variants (Left/Right).

Connector B Pinout

Number	Pin Name	Wire Color*	Signal Description
1	CAN-H	Blue	CAN - High
2	CAN-L	Green	CAN - Low

*Wire color is only an indication for development (connector integrated in DHS housing)

Designed by Thierry Guidet		Date	Department	
Released by		Designation		
	IMS ID nr	Version AC	Document version as of mars 21, 2018	Pages 19 of 35

Transmittal, reproduction, dissemination and/or editing of this document as well as utilization of its contents and communication thereof to others without express authorization are prohibited.

Offenders will be held liable for payment of damages. All rights created by patent grant or registration of a utility model or design patent are reserved.

9.7. Variants

9.7.1. Right/Left Variants

There shall be 2 mechanicals variants:

1 for Right Handle.

1 for Left Handle.

These variants shall differ only by the:

- housing & cover shape
- Flex-PCB shape
- Lightguide shape
- PCB shape

Unlock electrode shape shall be identical for both left and right version.

Designed by Thierry Guidet		Date	Department		
Released by		Designation			
	IMS ID nr	Version AC	Document version as of mars 21, 2018	Pages 20 of 35	

Transmittal, reproduction, dissemination and/or editing of this document as well as utilization of its contents and communication thereof to others without express authorization are prohibited.

Offenders will be held liable for payment of damages. All rights created by patent grant or registration of a utility model or design patent are reserved.

10. Photographs

Internal and external pictures of the device and all the components and boards



Designed by Thierry Guidet		Date	Department	
Released by				
Continental	Designation			
	IMS ID nr	Version AC	Document version as of mars 21, 2018	Pages 21 of 35

Transmittal, reproduction, dissemination and/or editing of this document as well as utilization of its contents and communication thereof to others without express authorization are prohibited.

Offenders will be held liable for payment of damages. All rights created by patent grant or registration of a utility model or design patent are reserved.

11. Operational description

Functionnal mode

The DHS is designed to send information to the CAN bus on following user events:

- When a user hand is detected closed to the UNLOCK pad
- When a user hand is detected closed to the LOCK pad
- When a card or a smartphone is detected closed to the NFC pad

NFC test mode

Test mode NFC is activated when setting CAN signal on CAN bus

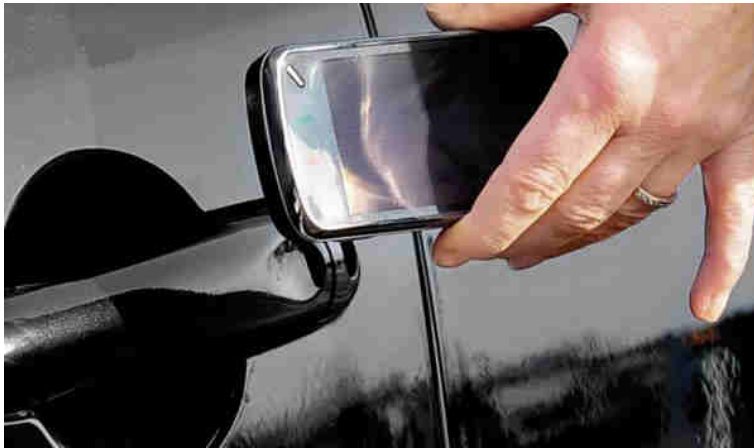

When the car driver put his smartphone close to the door handle (*), then the UNLOCK signal is sent to the BCM.

(*) and authenticated

11.1. Actuator test

When DHS receive the frame **NFC_01** with signal **Stellgliedtest_NFC set**, the DHS shall perform the actuator test requirement as described below :

The DHS Application shall execute the actuator test (when requested) at any time regardless of the Misuse or K15 State and ESM.(Energy Saving Mode)

It is required that the field is turned on during the complete duration of the actuator test.

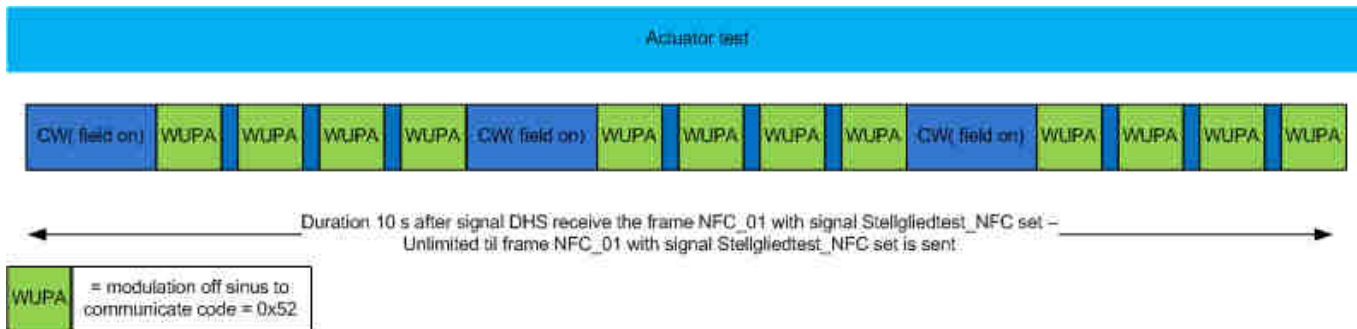

Designed by Thierry Guidet		Date	Department	
Released by				
	Designation			
	IMS ID nr	Version AC	Document version as of mars 21, 2018	Pages 22 of 35

REQA is replaced by WUPA to ensure several communication possible whereas field is kept on.

The DHS shall stop the acuator test if:

- the timeout of p_t_tgs_actuator_test s expires

Designed by Thierry Guidet		Date	Department		
Released by		Designation			
	IMS ID nr	Version AC	Document version as of mars 21, 2018	Pages 23 of 35	

Transmittal, reproduction, dissemination and/or editing of this document as well as utilization of its contents and communication thereof to others without express authorization are prohibited.

Offenders will be held liable for payment of damages. All rights created by patent grant or registration of a utility model or design patent are reserved.

12. Bill of materials

Nr

13. Mechanical diagrams

Component placement diagrams and PCB layout diagrams

The DHS module is composed of:

-a packaging:

- plastic housing
- plastic cover
- a PMMA lightguide
- potting material
- foam pad on Lock Area (the function is to keep the water out of the zone)

-2 connection modules:

- leadframe
- connectors

-an electronic detection module:

- PCB with electronic circuit (for detection technology)
- Unlock Electrode (sensitive element) metal-stamping soldered on the PCB
- Lock Electrode (sensitive element) and NFC antenna on Flex-PCB soldered on the PCB
- Ferrite element pasted on Flex below NFC antenna
- LED

Designed by Thierry Guidet		Date	Department	
Released by				
	Designation			
	IMS ID nr	Version AC	Document version as of mars 21, 2018	Pages 24 of 35

Transmittal, reproduction, dissemination and/or editing of this document as well as utilization of its contents and communication thereof to others without express authorization are prohibited.

Offenders will be held liable for payment of damages. All rights created by patent grant or registration of a utility model or design patent are reserved.

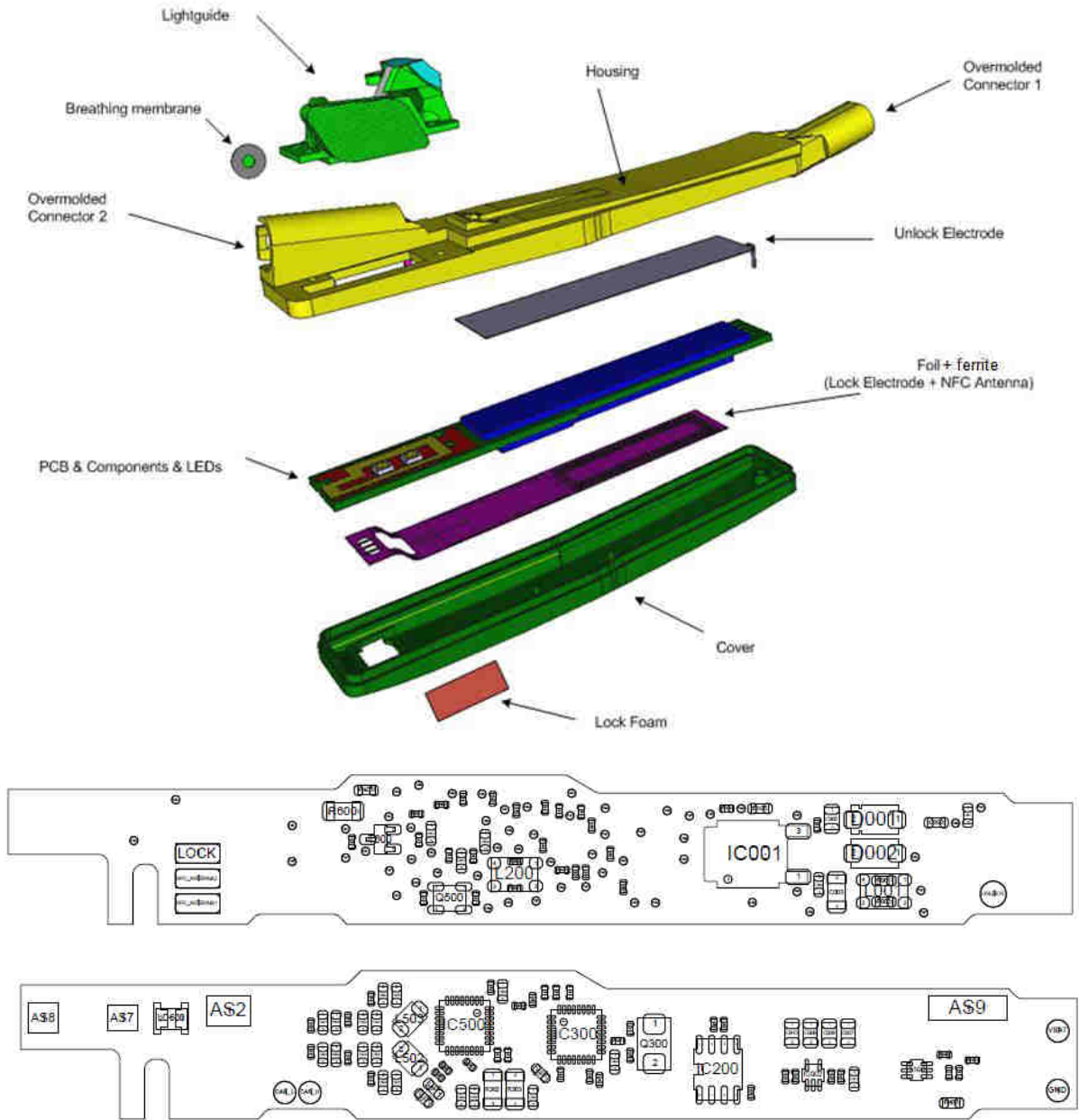

14. Risk Assessment

A risk assessment analyzing the possible risks and demonstrating how they are reduced to comply with the essential requirement

NR

Designed by Thierry Guidet		Date	Department	
Released by				
Continental	Designation			
	IMS ID nr	Version AC	Document version as of mars 21, 2018	Pages 25 of 35

Transmittal, reproduction, dissemination and/or editing of this document as well as utilization of its contents and communication thereof to others without express authorization are prohibited.

Offenders will be held liable for payment of damages. All rights created by patent grant or registration of a utility model or design patent are reserved.

15. Product label design

"Including labeling requirements of USA and EU.

In the case of EU, this is not reviewed by the NB, but it is needed to properly label the product before marketing the product in EU"



16. User manual

"Including regulatory notices for FCC and user manual requirements for EU. .

In the case of EU, this is not reviewed by the NB, but EU requirements must be included before marketing the product in EU. "

Refer to Testing Tool instruction chapter.

17. Homologation setup

17.1. General Test conditions

General test conditions valid for all tests :

- All materials within 100mm around the door handle sensor during the test process (includes Handle fixations - "Sensor fixture" / "Holder", sockets, base plate, ... -, actuation system – robot, arms, ...-, tester mechanics, ...) shall be made of non conductive material and as electrostatic neutral as possible (ie PEEK or PA66 GF30) in order to avoid influence on detection distance.
- Conductive environment (Robot, arms, jig walls, etc ...) shall be at least 100mm away from Door Handle Assembly throughout the test sequence (except for Targets themselves).
- The connector positions, and then the bed-of-nails, shall be 100 mm away from the sensitive areas during the test.
- The DHS shall have its dedicated power supply. This power supply shall be a low noise linear power supply (switch mode power supplies are prohibited)
- No noise shall be visible by oscilloscope on DHS supply line.

Designed by Thierry Guidet		Date	Department	
Released by		Designation		
	IMS ID nr	Version AC	Document version as of mars 21, 2018	Pages 26 of 35

Transmittal, reproduction, dissemination and/or editing of this document as well as utilization of its contents and communication thereof to others without express authorization are prohibited.

Offenders will be held liable for payment of damages. All rights created by patent grant or registration of a utility model or design patent are reserved.

18. Delivery parts

Nb part delivered : 6 Sensors shall be delivered (3 sensor Left, 3 sensors Right)

Part marking : H20 S0020 01K

SW version : 0020

Id part	Type	S/N	comments
1	DHS Left	183	
2	DHS Left	186	
3	DHS Left	203	
4	DHS Right	170	
5	DHS Right	176	
6	DHS Right	177	
8	Test Box	nr	Already shipped with D5NFC package
9	Wires	Nr	set of wires (A and B coding)
10	Tag for NFC detection	Nr	Already shipped with D5NFC package

19. Testing tool

Testing tool : GO/no GO/ Testing mode Testing box

Same Tooling as for D5NFC product.

Photo



Designed by Thierry Guidet		Date	Department	
Released by				
	Designation			
	IMS ID nr	Version AC	Document version as of mars 21, 2018	Pages 27 of 35

Transmittal, reproduction, dissemination and/or editing of this document as well as utilization of its contents and communication thereof to others without express authorization are prohibited.

Offenders will be held liable for payment of damages. All rights created by patent grant or registration of a utility model or design patent are reserved.

User Manual

19.1. DHS connection instructions:

Global overview when sensor is plugged to testbox:

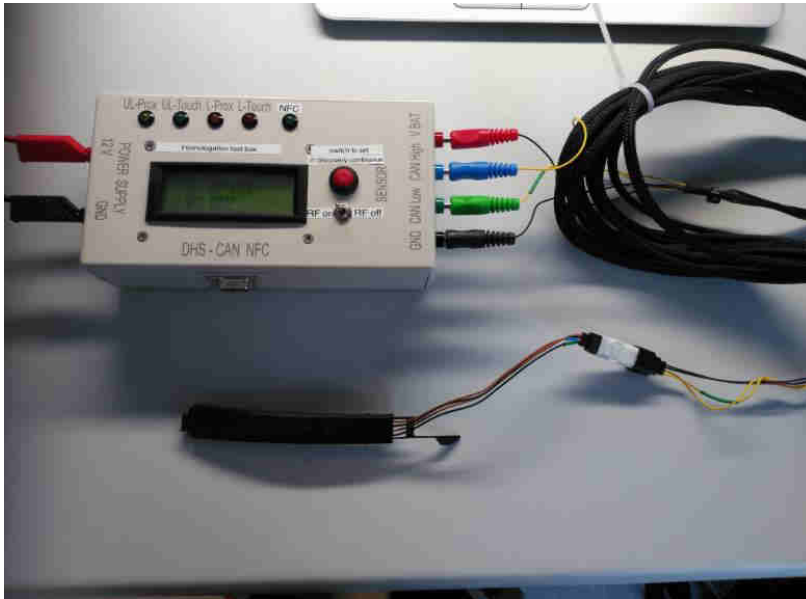

Supply test box with 12V.

Plug DHS Vbat and GND to corresponding Vbat and GND input on test box:

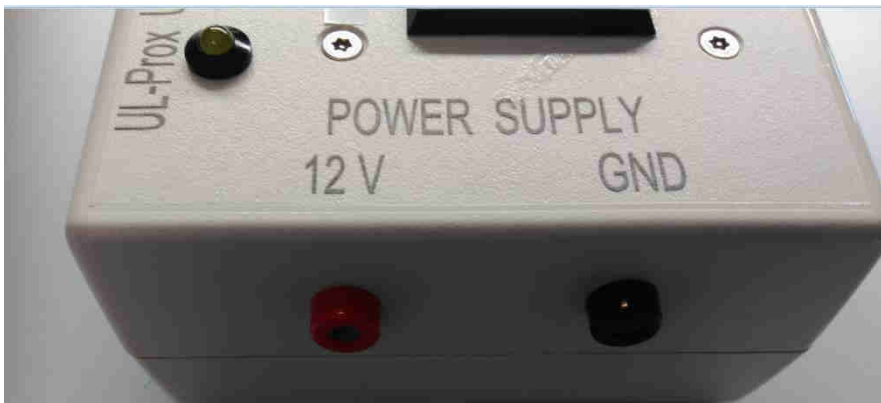

Plug DHS CAN low and Can High to corresponding CAN low and Can High input on test box with color corresponding plugs:

Designed by Thierry Guidet		Date	Department	
Released by				
Continental	Designation			
	IMS ID nr	Version AC	Document version as of mars 21, 2018	Pages 28 of 35

Transmittal, reproduction, dissemination and/or editing of this document as well as utilization of its contents and communication thereof to others without express authorization are prohibited.

Offenders will be held liable for payment of damages. All rights created by patent grant or registration of a utility model or design patent are reserved.



Designed by Thierry Guidet		Date	Department	
Released by				
Continental	Designation			
	IMS ID nr	Version AC	Document version as of mars 21, 2018	Pages 29 of 35

Transmittal, reproduction, dissemination and/or editing of this document as well as utilization of its contents and communication thereof to others without express authorization are prohibited.

Offenders will be held liable for payment of damages. All rights created by patent grant or registration of a utility model or design patent are reserved.

19.2. Test box signals description:

LEDs are available to check visually if sensor is working.



For each lead an output is available and can be connected directly to any recorder (oscilloscope,...). High level means no detection, low level means detection.

Designed by Thierry Guidet		Date	Department	
Released by				
Continental	Designation			
	IMS ID nr	Version AC	Document version as of mars 21, 2018	Pages 30 of 35

Transmittal, reproduction, dissemination and/or editing of this document as well as utilization of its contents and communication thereof to others without express authorization are prohibited.

Offenders will be held liable for payment of damages. All rights created by patent grant or registration of a utility model or design patent are reserved.

19.2.1.1. Lock Touch example

Below example with lock touch : L_Touch output is plugged to oscilloscope – GND also :

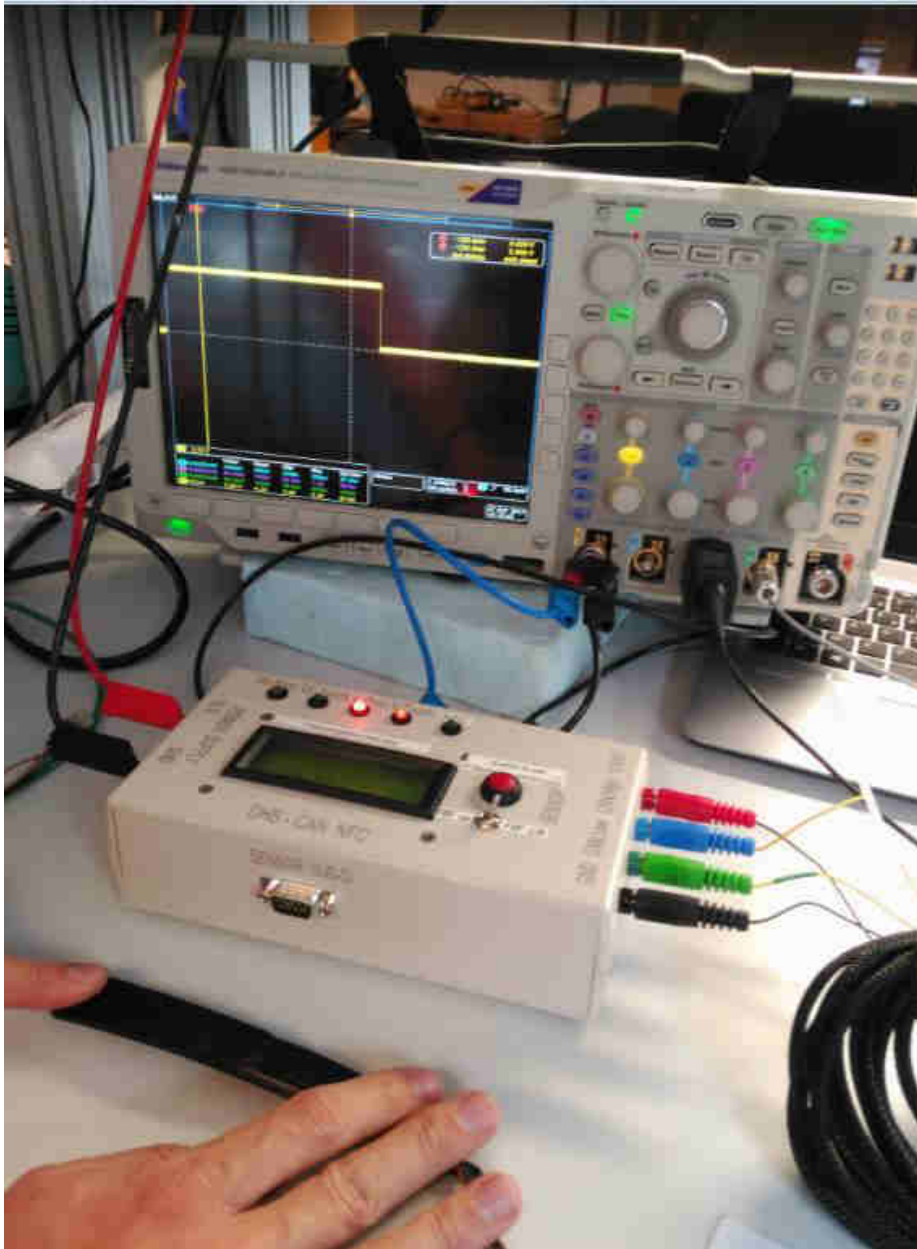

Designed by Thierry Guidet		Date	Department	
Released by				
Continental	Designation			
	IMS ID nr	Version AC	Document version as of mars 21, 2018	Pages 31 of 35

Transmittal, reproduction, dissemination and/or editing of this document as well as utilization of its contents and communication thereof to others without express authorization are prohibited.

Offenders will be held liable for payment of damages. All rights created by patent grant or registration of a utility model or design patent are reserved.

19.2.1.2. *Unlock Touch detection*

Unlock prox/touch detection : touch hand in unlock area :

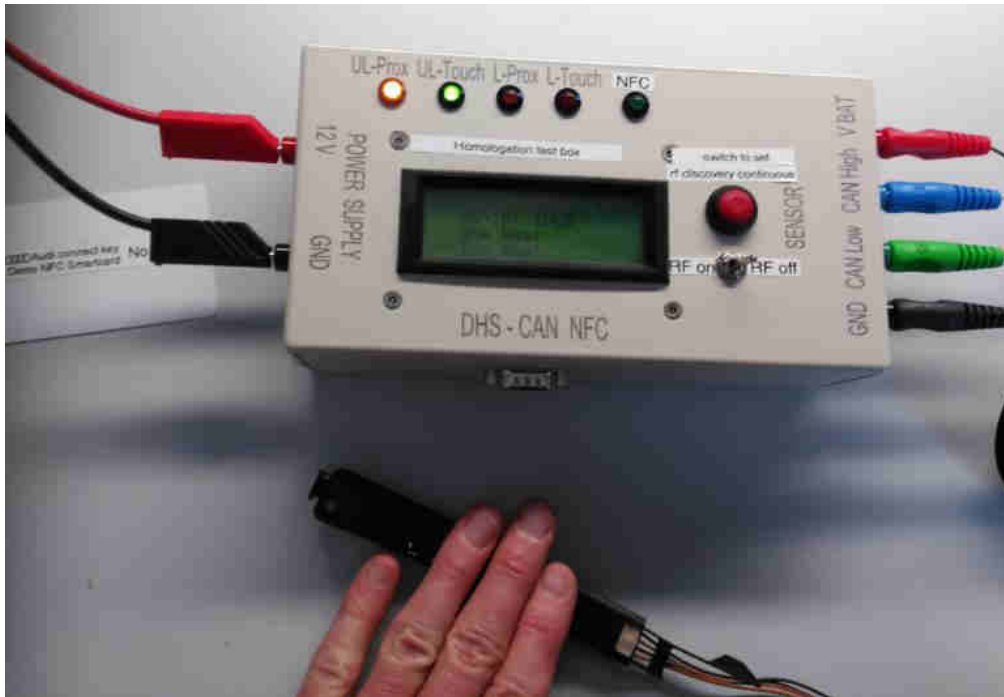

19.2.1.3. *Lock Prox/Touch detection*

Lock prox/touch detection : touch hand in unlock area :

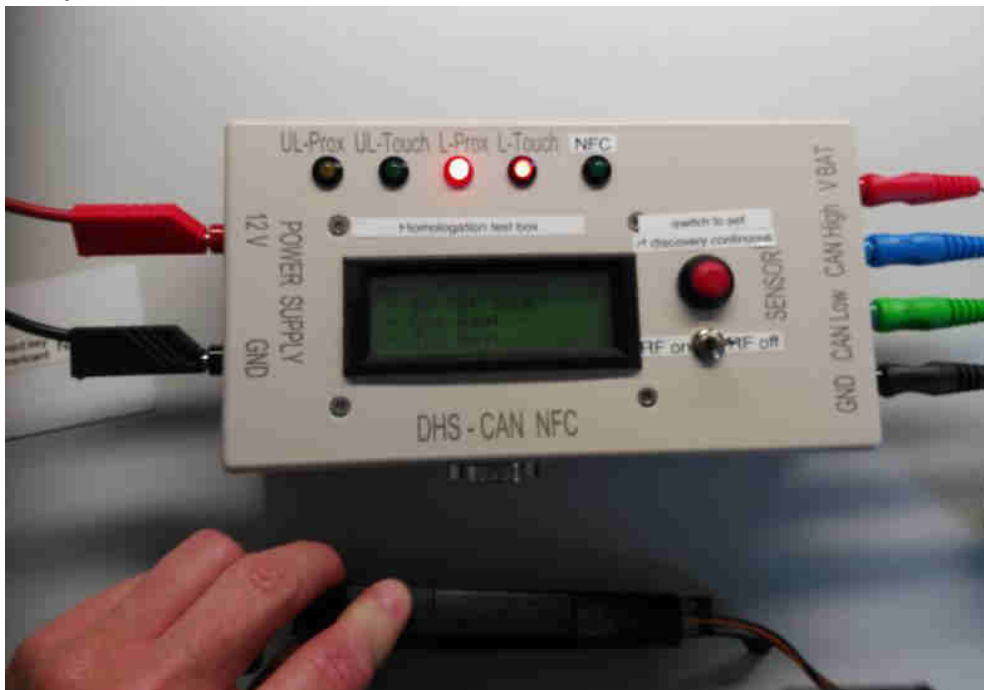

Designed by Thierry Guidet		Date	Department	
Released by				
Continental	Designation			
	IMS ID nr	Version AC	Document version as of mars 21, 2018	Pages 32 of 35

Transmittal, reproduction, dissemination and/or editing of this document as well as utilization of its contents and communication thereof to others without express authorization are prohibited.

Offenders will be held liable for payment of damages. All rights created by patent grant or registration of a utility model or design patent are reserved.

19.2.1.4. NFC detection

NFC detection : approach TAG against NFC area : message on test box = "SE-ID:OK"

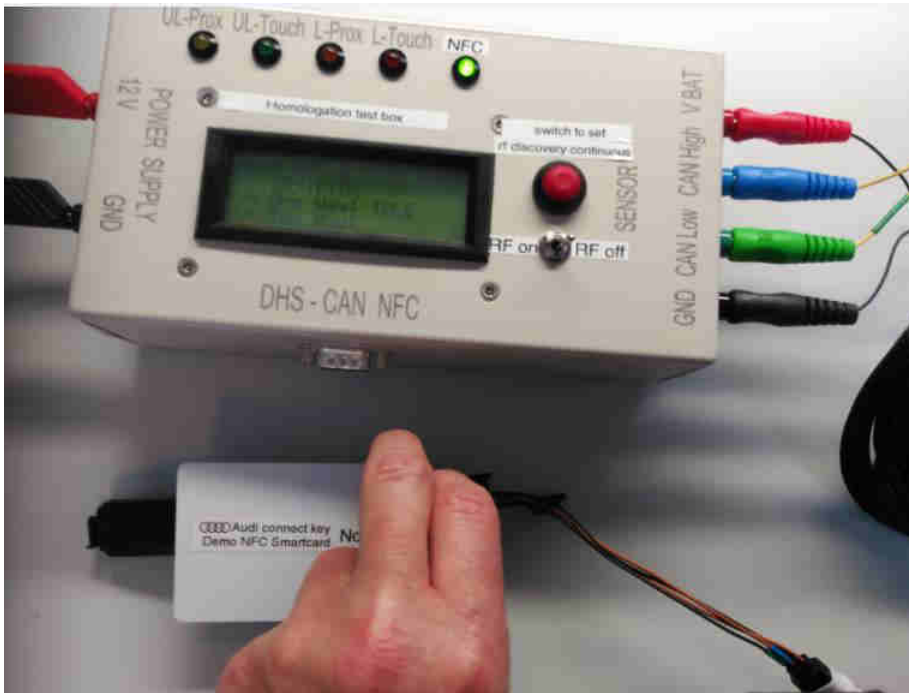

Designed by Thierry Guidet		Date	Department	
Released by				
Continental	Designation			
	IMS ID nr	Version AC	Document version as of mars 21, 2018	Pages 33 of 35

Transmittal, reproduction, dissemination and/or editing of this document as well as utilization of its contents and communication thereof to others without express authorization are prohibited.

Offenders will be held liable for payment of damages. All rights created by patent grant or registration of a utility model or design patent are reserved.

19.3. Test Box procedure

Before to start any test, check for each LED and corresponding output that sensor is working fine:

- touch lock area with thumb for at least 300 ms => check lock prox and lock touch function
- touch unlock area with hand for at least 200 ms => check unlock prox and unlock touch function
- approach TAG against NFC area => check NFC function

19.3.1. Test box function:

To set the sensor in “normal mode”, as it is in vehicle configuration without communication with BCM, let the switch in position RF-OFF.

To set the sensor in “RF Discovery mode”, set the switch in position RF-ON. The sensor will send continuous WUPA as described in chapter “actuator test”.



To check no loss of detection Tag provided by continental shall lay against the DHS in front of NFC Area as describe in chapter”NFC detection area”.

Designed by Thierry Guidet		Date	Department	
Released by				
Continental	Designation			
	IMS ID nr	Version AC	Document version as of mars 21, 2018	Pages 34 of 35

Transmittal, reproduction, dissemination and/or editing of this document as well as utilization of its contents and communication thereof to others without express authorization are prohibited.

Offenders will be held liable for payment of damages. All rights created by patent grant or registration of a utility model or design patent are reserved.

To exit the sensor from “RF Discovery mode”, set the switch in position RF-OFF. The sensor will exit from this mode to normal mode in about 1s.



Designed by Thierry Guidet		Date	Department	
Released by				
Continental	Designation			
	IMS ID nr	Version AC	Document version as of mars 21, 2018	Pages 35 of 35

Transmittal, reproduction, dissemination and/or editing of this document as well as utilization of its contents and communication thereof to others without express authorization are prohibited.

Offenders will be held liable for payment of damages. All rights created by patent grant or registration of a utility model or design patent are reserved.

FCC Regulatory notices

Modification statement

Continental Automotive GmbH has not approved any changes or modifications to this device by the user. Any changes or modifications could void the user's authority to operate the equipment.

Interference statement

This device complies with Part 15 of the FCC Rules. Operation is subject to the following two conditions: (1) this device may not cause interference, and (2) this device must accept any interference, including interference that may cause undesired operation of the device.

Wireless notice

This device complies with FCC radiation exposure limits set forth for an uncontrolled environment and meets the FCC radio frequency (RF) Exposure Guidelines. This transmitter must not be co-located or operating in conjunction with any other antenna or transmitter.

FCC Class B digital device notice

This equipment has been tested and found to comply with the limits for a Class B digital device, pursuant to part 15 of the FCC Rules. These limits are designed to provide reasonable protection against harmful interference in a residential installation. This equipment generates, uses and can radiate radio frequency energy and, if not installed and used in accordance with the instructions, may cause harmful interference to radio communications. However, there is no guarantee that interference will not occur in a particular installation. If this equipment does cause harmful interference to radio or television reception, which can be determined by turning the equipment off and on, the user is encouraged to try to correct the interference by one or more of the following measures:

- Reorient or relocate the receiving antenna.
- Increase the separation between the equipment and receiver.
- Connect the equipment into an outlet on a circuit different from that to which the receiver is connected.
- Consult the dealer or an experienced radio/TV technician for help.