



FCC ID: KR541580430
Report No.: T200507W04-RP

Page 1 / 27
Rev. 02

FCC 47 CFR PART 15 SUBPART C

TEST REPORT

For

Integrated Body Controller

Trade Name: Continental

Model: 41580430

Issued to

**Continental Automotive GmbH
Siemensstrasse 12 SV C TS RBG EMC-Laboratory
Regensburg, 93055 Germany**

Issued by

Compliance Certification Services Inc.

**Wugu Laboratory
No.11, Wugong 6th Rd., Wugu Dist.,
New Taipei City, Taiwan. (R.O.C.)
Issued Date: July 14, 2020**

Unless otherwise stated the results shown in this test report refer only to the sample(s) tested and such sample(s) are retained for 90 days only.
除非另有說明，此報告結果僅對測試之樣品負責，同時此樣品僅保留90天。本報告未經本公司書面許可，不可部份複製。

This document is issued by the Company subject to its General Conditions of Service printed overleaf, available on request or accessible at <http://www.sgs.com.tw/Terms-and-Conditions> and, for electronic format documents, subject to Terms and Conditions for Electronic Documents at <http://www.sgs.com.tw/Terms-and-Conditions>. Attention is drawn to the limitation of liability, indemnification and jurisdiction issues defined therein. Any holder of this document is advised that information contained hereon reflects the Company's findings at the time of its intervention only and within the limits of client's instruction, if any. The Company's sole responsibility is to its Client and this document does not exonerate parties to a transaction from exercising all their rights and obligations under the transaction documents. This document cannot be reproduced, except in full, without prior written approval of the Company. Any unauthorized alteration, forgery or falsification of the content or appearance of this document is unlawful and offenders may be prosecuted to the fullest extent of the law.

Revision History

Rev.	Issue Date	Revisions	Effect Page	Revised By
00	June 11, 2020	Initial Issue	ALL	Allison Chen
01	July 1, 2020	See the following note Rev.(01)	P.4, P.6, P.14-15, P.20-21	Allison Chen
02	July 14, 2020	See the following note Rev.(02)	P.10	Allison Chen

Rev.(01)

1. Added test sample number in section 2.
2. Revised calibration date about the DC power supply in section 7.2.
3. Revised test result of FH at 20dB in section 8.1.
4. Added fundamental strength in section 8.2.
5. Revised test period.

Rev.(02)

1. Remove above 1GHz test mode in section 4.5.

TABLE OF CONTENTS

1. TEST RESULT CERTIFICATION.....	4
2. EUT DESCRIPTION.....	6
3. TEST SUMMARY.....	7
4. TEST METHODOLOGY.....	8
4.1 EUT CONFIGURATION.....	8
4.2 EUT EXERCISE.....	8
4.3 GENERAL TEST PROCEDURES.....	8
4.4 FCC PART 15.205 RESTRICTED BANDS OF OPERATIONS.....	9
4.5 DESCRIPTION OF TEST MODES.....	10
5. INSTRUMENT CALIBRATION.....	11
5.1 MEASURING INSTRUMENT CALIBRATION.....	11
5.2 MEASUREMENT EQUIPMENT USED.....	11
5.3 MEASUREMENT UNCERTAINTY.....	12
6. FACILITIES AND ACCREDITATIONS.....	13
6.1 FACILITIES.....	13
6.2 EQUIPMENT.....	13
7. SETUP OF EQUIPMENT UNDER TEST.....	14
7.1 SETUP CONFIGURATION OF EUT.....	14
7.2 SUPPORT EQUIPMENT.....	14
8. TEST REQUIREMENTS.....	15
8.1 20dB BANDWIDTH.....	15
8.2 TRANSMITTER RADIATED EMISSION.....	17
8.3 AC CONDUCTED EMISSION.....	26
8.4 ANTENNA REQUIREMENT.....	27
APPENDIX A PHOTOGRAPHS OF TEST SETUP.....	A-1
APPENDIX 1 - PHOTOGRAPHS OF EUT	

1. TEST RESULT CERTIFICATION

Applicant: Continental Automotive GmbH
Siemensstrasse 12 SV C TS RBG EMC-Laboratory
Regensburg, 93055 Germany

Manufacturer: Continental Automotive GmbH
Siemensstrasse 12 SV C TS RBG EMC-Laboratory
Regensburg, 93055 Germany

Factor: 1. Continental Automotive Changchun Co., Ltd. Jingyue
Branch
5800, Shengtai Street Changchun, Jilin Province, P.R. China
130000
2. CONTINENTAL AUTOMOTIVE GUADALAJARA MEXICO
S DE RL DE CV
Camino a la Tijera No. 3, K.m. 3.5 Carretera Guadalajara
Morelia. Colonia la Tijera. 45640 Tlajomulco de Zúñiga,
Jalisco, México

Equipment Under Test: Integrated Body Controller

Trade Name: Continental

Model: 41580430

Date of Test: May 13 ~ 20, 2020



Report No.: T200507W04-RP

Page 5 / 27
Rev. 02

APPLICABLE STANDARDS	
STANDARD	TEST RESULT
FCC 47 CFR Part 15.209	No non-compliance noted

Statements of Conformity
Determination of compliance is based on the results of the compliance measurement, not taking into account measurement instrumentation uncertainty.

We hereby certify that:

All test results conform to above mentioned standards.

The above equipment was tested by Compliance Certification Services Inc. The test data, data evaluation, test procedures, and equipment configurations shown in this report were made in accordance with the procedures given in ANSI C63.10: 2013 and the energy emitted by the sample EUT tested as described in this report is in compliance with the requirements of FCC Rules Part15.203, Part15.207, Part15.209. Part15.215.

The test results of this report relate only to the tested sample EUT identified in this report.

Approved by:

Kevin Tsai
Deputy Manager
Compliance Certification Services Inc.

2. EUT DESCRIPTION

Product	Integrated Body Controller
Trade Name	Continental
Model Number	41580430
Model Discrepancy	N/A
Received Date	May 7, 2020
Power Supply	Power from power supply. (DC 13.5V)
Frequency Band	TX: 125kHz, RX: 433.92MHz
Antenna Designation	Low Frequency Antenna / 0 dBi
Test Sample #	300400100164

Remark:

1. *The sample selected for test was production product and was provided by manufacturer.*

3. TEST SUMMARY

Standard Sec.	Chapter	Test Item	Result
15.215	8.1	20dB Bandwidth	Pass
15.209	8.2	Transmitter Radiated Emission	Pass
15.207	8.3	AC Power-line Conducted Emission	N/A
15.203	8.4	Antenna Requirement	Pass

Report No.: T200507W04-RP

4. TEST METHODOLOGY

The tests documented in this report were performed in accordance with ANSI C63.10: 2013 , ANSI C63.4 2014 and FCC CFR 47 Part 15.203, 15.207.15.209,15.215.

4.1 EUT CONFIGURATION

The EUT configuration for testing is installed on RF field strength measurement to meet the Commissions requirement and operating in a manner that intends to maximize its emission characteristics in a continuous normal application.

4.2 EUT EXERCISE

The EUT was operated in the engineering mode to fix the TX frequency that was for the purpose of the measurements.

According to its specifications, the EUT must comply with the requirements of the Section 15.203, 15.207.15.209, 15.215 under the FCC Rules Part 15 Subpart C and ANSI C63.10: 2013.

4.3 GENERAL TEST PROCEDURES

Conducted Emissions

The EUT is placed on the turntable, which is 0.8 m above ground plane. According to the requirements in ANSI C63.10: 2013, Conducted emissions from the EUT measured in the frequency range between 0.15 MHz and 30MHz was using CISPR Quasi-peak and average detector modes.

Radiated Emissions

The EUT is placed on a turn table, which is 0.8 m above ground plane. The turntable shall rotate 360 degrees to determine the position of maximum emission level. The EUT is set 3m away from the receiving antenna, which varied from 1m to 4m to find out the highest emission. And also, each emission was to be maximized by changing the polarization of receiving antenna both horizontal and vertical. In order to find out the maximum emissions, exploratory radiated emission measurements were made according to the requirements in ANSI C63.10: 2013.

Report No.: T200507W04-RP

4.4 FCC PART 15.205 RESTRICTED BANDS OF OPERATIONS

(a) Except as shown in other rules, only spurious emissions are permitted in any of the frequency bands listed below:

MHz	MHz	MHz	GHz
0.090 - 0.110	16.42 - 16.423	399.9 - 410	4.5 - 5.15
¹ 0.495 - 0.505	16.69475 - 16.69525	608 - 614	5.35 - 5.46
2.1735 - 2.1905	16.80425 - 16.80475	960 - 1240	7.25 - 7.75
4.125 - 4.128	25.5 - 25.67	1300 - 1427	8.025 - 8.5
4.17725 - 4.17775	37.5 - 38.25	1435 - 1626.5	9.0 - 9.2
4.20725 - 4.20775	73 - 74.6	1645.5 - 1646.5	9.3 - 9.5
6.215 - 6.218	74.8 - 75.2	1660 - 1710	10.6 - 12.7
6.26775 - 6.26825	108 - 121.94	1718.8 - 1722.2	13.25 - 13.4
6.31175 - 6.31225	123 - 138	2200 - 2300	14.47 - 14.5
8.291 - 8.294	149.9 - 150.05	2310 - 2390	15.35 - 16.2
8.362 - 8.366	156.52475 -	2483.5 - 2500	17.7 - 21.4
8.37625 - 8.38675	156.52525	2655 - 2900	22.01 - 23.12
8.41425 - 8.41475	156.7 - 156.9	3260 - 3267	23.6 - 24.0
12.29 - 12.293	162.0125 - 167.17	3332 - 3339	31.2 - 31.8
12.51975 - 12.52025	167.72 - 173.2	3345.8 - 3358	36.43 - 36.5
12.57675 - 12.57725	240 - 285	3600 - 4400	(²)
13.36 - 13.41	322 - 335.4		

¹ Until February 1, 1999, this restricted band shall be 0.490-0.510 MHz.

² Above 38.6

(b) Except as provided by other rules, the field strength of emissions appearing within these frequency bands shall not exceed the limits shown in Section 15.209. At frequencies equal to or less than 1000 MHz, compliance with the limits in Section 15.209 shall be demonstrated using measurement instrumentation employing a CISPR quasi-peak detector. Above 1000 MHz, compliance with the emission limits in Section 15.209 shall be demonstrated based on the average value of the measured emissions. The provisions in Section 15.35 apply to these measurements.

4.5 DESCRIPTION OF TEST MODES

The EUT (model: 41580430) had been tested under operating condition.

Radiated Emission Measurement Below 1G	
Test Condition	Radiated Emission Below 1G
Power supply Mode	Mode 1: EUT power by Power supply
Worst Mode	<input checked="" type="checkbox"/> Mode 1 <input type="checkbox"/> Mode 2 <input type="checkbox"/> Mode 3 <input type="checkbox"/> Mode 4

Remark:

1. The worst mode was record in this test report.
2. EUT pre-scanned in three axis ,X, Y, Z and two polarity, for radiated measurement. The worst case(X-Plane) were recorded in this report

Report No.: T200507W04-RP

5. INSTRUMENT CALIBRATION

5.1 MEASURING INSTRUMENT CALIBRATION

The measuring equipment, which was utilized in performing the tests documented herein, has been calibrated in accordance with the manufacturer's recommendations for utilizing calibration equipment, which is traceable to recognized national standards.

5.2 MEASUREMENT EQUIPMENT USED

Equipment Used for Emissions Measurement

Remark: Each piece of equipment is scheduled for calibration once a year.

RF Conducted Test Site					
Equipment	Manufacturer	Model	S/N	Cal Date	Cal Due
Signal Analyzer	R&S	FSV 40	101073	09/25/2019	09/24/2020
Software	N/A				

3M 966 Chamber Test Site					
Equipment	Manufacturer	Model	S/N	Cal Date	Cal Due
Bilog Antenna	Sunol Sciences	JB3	A030105	07/26/2019	07/25/2020
Coaxial Cable	HUBER SUHNER	SUCOFLEX 104PEA	20995	02/25/2020	02/24/2021
Coaxial Cable	EMCI	EMC105	190914+25111	09/20/2019	09/19/2020
Digital Thermo-Hygro Meter	WISEWIND	1206	D07	01/15/2020	01/14/2021
double Ridged Guide Horn Antenna	ETC	MCTD 1209	DRH13M02003	10/04/2019	10/03/2020
High Pass Filter	SOLVANG TECHNOLOGY INC.	ST115	9923	02/25/2020	02/24/2021
Loop Ant	COM-POWER	AL-130	121051	03/27/2020	03/26/2021
Pre-Amplifier	EMEC	EM330	060609	02/25/2020	02/24/2021
Pre-Amplifier	HP	8449B	3008A00965	02/25/2020	02/24/2021
Signal Analyzer	R&S	FSV 40	101073	09/25/2019	09/24/2020
PSA Series Spectrum Analyzer	Agilent	E4446A	MY46180323	05/29/2019	05/28/2020
Antenna Tower	CCS	CC-A-1F	N/A	N.C.R	N.C.R
Controller	CCS	CC-C-1F	N/A	N.C.R	N.C.R
Turn Table	CCS	CC-T-1F	N/A	N.C.R	N.C.R
Software	e3 6.11-20180413				

Remark: Each piece of equipment is scheduled for calibration once a year.

5.3 MEASUREMENT UNCERTAINTY

PARAMETER	UNCERTAINTY
AC Powerline Conducted Emission	+/- 1.2575
Emission bandwidth, 20dB bandwidth	+/- 0.0014
RF output power, conducted	+/- 1.14
Power density, conducted	+/- 1.40
3M Semi Anechoic Chamber / 30M~200M	+/- 4.12
3M Semi Anechoic Chamber / 200M~1000M	+/- 4.68
3M Semi Anechoic Chamber / 1G~8G	+/- 5.18
3M Semi Anechoic Chamber / 8G~18G	+/- 5.47
3M Semi Anechoic Chamber / 18G~26G	+/- 3.81
3M Semi Anechoic Chamber / 26G~40G	+/- 3.87

Remark: This uncertainty represents an expanded uncertainty expressed at approximately the 95% confidence level using a coverage factor of $k=2$.

Report No.: T200507W04-RP

6. FACILITIES AND ACCREDITATIONS

6.1 FACILITIES

All measurement facilities used to collect the measurement data are located at

No.199, Chunghsen Road, Hsintien City, Taipei Hsien, Taiwan, R.O.C.

Tel: 886-2-2217-0894 / Fax: 886-2-2217-1029

No.11, Wugong 6th Rd., Wugu Dist., New Taipei City, Taiwan. (R.O.C.)

Tel: 886-2-2299-9720 / Fax: 886-2-2299-9721

The sites are constructed in conformance with the requirements of ANSI C63.7, ANSI C63.4 and CISPR Publication 22.

6.2 EQUIPMENT

Radiated emissions are measured with one or more of the following types of linearly polarized antennas: tuned dipole, biconical, log periodic, bi-log, and/or ridged waveguide, horn. Spectrum analyzers with pre-selectors and quasi-peak detectors are used to perform radiated measurements.

Calibrated wideband preamplifiers, coaxial cables, and coaxial attenuators are also used for making measurements.

All receiving equipment conforms to CISPR Publication 16-1, "Radio Interference Measuring Apparatus and Measurement Methods."

7. SETUP OF EQUIPMENT UNDER TEST

7.1 SETUP CONFIGURATION OF EUT

See test photographs attached in Appendix II for the actual connections between EUT and support equipment.

7.2 SUPPORT EQUIPMENT

No.	Device Type	Brand	Model	S/N	Cal Date	Cal Due
1	DC Power Supplies	GW Instek	SPS-3610	GPE880163	01/10/2020	01/09/2021

Remark:

1. All the equipment/cables were placed in the worst-case configuration to maximize the emission during the test.
2. Grounding was established in accordance with the manufacturer's requirements and conditions for the intended use.

Report No.: T200507W04-RP

8. TEST REQUIREMENTS

8.1 20dB BANDWIDTH

Definition

According to FCC Part 15.215 (c) ,Intentional radiators operating under the alternative provisions to the general emission limits, as contained in §§15.217 through 15.257 and in subpart E of this part, must be designed to ensure that the 20 dB bandwidth of the emission, or whatever bandwidth may otherwise be specified in the specific rule section under which the equipment operates, is contained within the frequency band designated in the rule section under which the equipment is operated.

Test Configuration

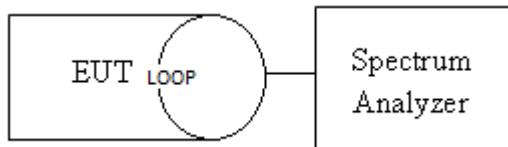

TEST PROCEDURE

The Loop antenna connected to the spectrum analyzer, was touching to the transmitter antenna. Set the RBW=1KHz, VBW ≥ 3 x RBW, Detector = Peak, Trace mode = Max hold, Sweep = 500ms. Measure the maximum width of the emission that is constrained by the frequencies associated with the Occupied Bandwidth.

TEST RESULTS

No non-compliance noted

Test Condition	Frequency(kHz)	99% Bandwidth (kHz)	F _L at 20dB BW (kHz)	F _H at 20dB BW (kHz)	20dB Bandwidth (kHz)	Limit
Operating mode	125.0	12.098	118.806	131.252	12.446	N/A

Report No.: T200507W04-RP

Test Data

20dB & 99%OBW

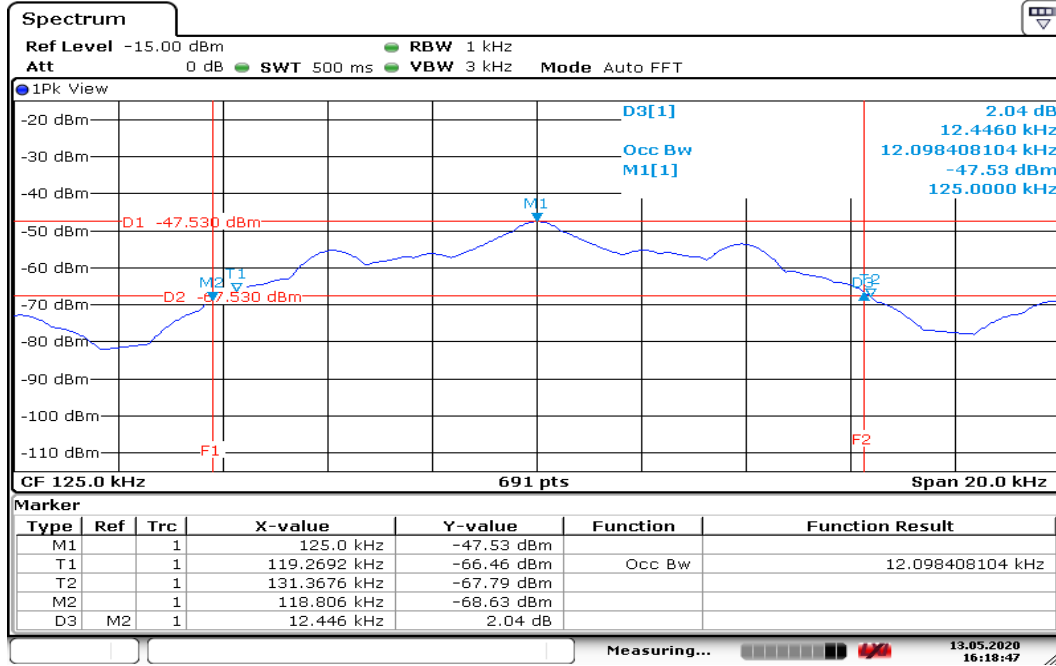

Date: 13.MAY.2020 16:18:47

8.2 TRANSMITTER RADIATED EMISSION

LIMIT

1. According to FCC PART 15.209(a), except as provided elsewhere in this Subpart, the emissions from an intentional radiator shall not exceed the field strength levels specified in the following table:

Frequency (MHz)	Field Strength ($\mu\text{V/m}$)	Measurement Distance (m)
0.009 - 0.490	2400/F(kHz)	300
0.490 - 1.705	24000/F(kHz)	30
1.705 – 30.0	30	30
30-88	100	3
88-216	150	3
216-960	200	3
Above 960	500	3

Remark: Except as provided in other rules, fundamental emissions from intentional radiators operating under this Section shall not be located in the frequency bands 54-72 MHz, 76-88 MHz, 174-216 MHz or 470-806 MHz. However, operation within these frequency bands is permitted under other sections of this Part, e.g., Sections 15.231 and 15.241.

2. In the above emission table, the tighter limit applies at the band edges.

Below 30MHz

Frequency (MHz)	Field Strength		Measurement Distance (meter)	Field Strength (dB $\mu\text{V/m}$)	Measurement Distance (meter)
	($\mu\text{V/m}$)	(dB $\mu\text{V/m}$)			
0.009 - 0.490	2400/F(kHz)	48.52 – 13.80	300	128.52–93.80	3
0.490 - 1.705	24000/F(kHz)	33.80 – 22.97	30	73.80– 62.97	3
1.705 – 30.0	30	29.54	30	69.54	3

Remark: According to Part 15.31(f)(2), the transfer formula as below:

$Limit@3m = 20\log(Limit@300m) + 40\log(Limit\ define\ distance(300m) / (Measurement\ distance(3m)))$

Above 30MHz

Frequency (MHz)	Field Strength		Measurement Distance (meter)
	($\mu\text{V/m}$)	(dB $\mu\text{V/m}$)	
30-88	100	40.0	3
88-216	150	43.5	3
216-960	200	46.0	3
Above 960	500	54.0	3

Test Configuration

9kHz ~ 30MHz

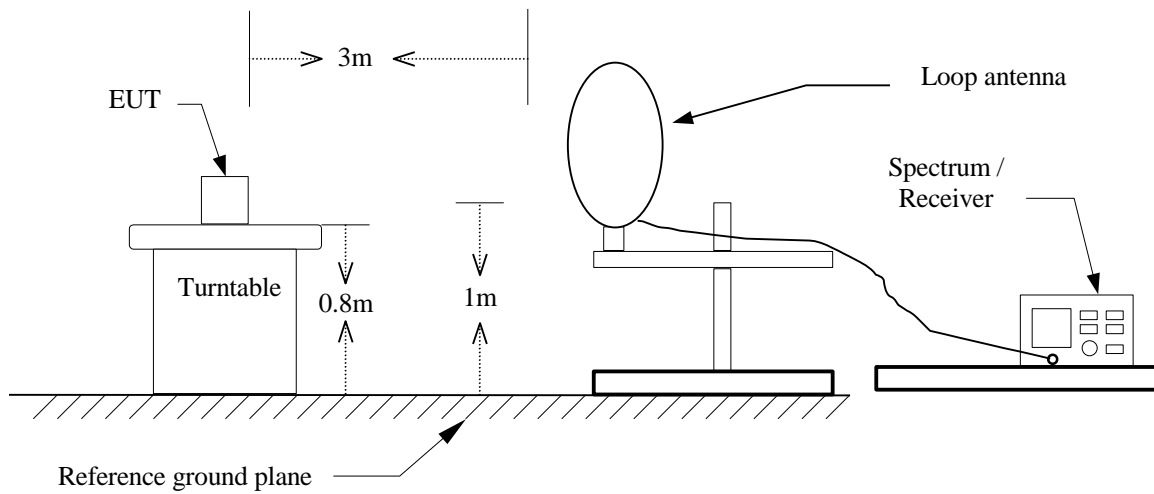

30MHz ~ 1GHz

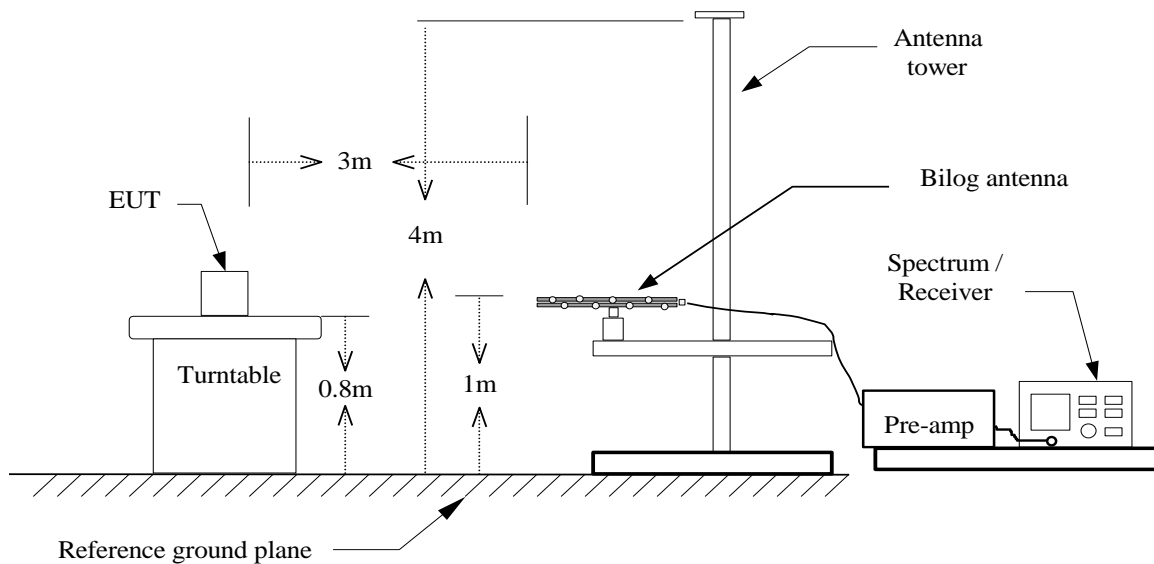

Report No.: T200507W04-RP

TEST PROCEDURE

For 9KHz ~ 30MHz

1. The EUT is placed on a turntable, which is 0.8m above ground plane.
2. The turntable shall be rotated for 360 degrees to determine the position of maximum emission level.
3. EUT is set 3m away from the receiving antenna, which is varied from 1m to find out the highest emissions.
4. Maximum procedure was performed on the six highest emissions to ensure EUT compliance.
5. And also, each emission was to be maximized by changing the polarization of receiving antenna both horizontal and vertical.
6. Set the spectrum analyzer in the following setting as:
Below 1GHz:
RBW=200kHz / VBW=600kHz / Sweep=AUTO
7. Repeat above procedures until the measurements for all frequencies are complete.
8. Test distance for frequencies at below 30 MHz, measurements may be performed at a distance closer than the EUT limit distance; however, an attempt should be made to avoid making measurements in the near field. When performing measurements below 30 MHz at a closer distance than the limit distance, the results shall be extrapolated to the specified distance by either making measurements at a minimum of two or more distances on at least one radial to determine the proper extrapolation factor or by using the square of an inverse linear distance extrapolation factor (40 dB/decade). The test report shall specify the extrapolation method used to determine compliance of the EUT.

For 30MHz ~ 1GHz

1. The EUT is placed on a turntable, which is 0.8m above ground plane.
2. The turntable shall be rotated for 360 degrees to determine the position of maximum emission level.
3. EUT is set 3m away from the receiving antenna, which is varied from 1m to 4m to find out the highest emissions.
4. Maximum procedure was performed on the six highest emissions to ensure EUT compliance.
5. And also, each emission was to be maximized by changing the polarization of receiving antenna both horizontal and vertical.
6. Set the spectrum analyzer in the following setting as:
RBW=100kHz / VBW=300kHz / Sweep=AUTO
7. Repeat above procedures until the measurements for all frequencies are complete.

Report No.: T200507W04-RP

Fundamental Strength

Operation Mode: Main

Test Date: May 20, 2020

Temperature: 23.6°C

Tested by: Jerry Chang

Humidity: 45% RH

Antenna Pol.: Vertical

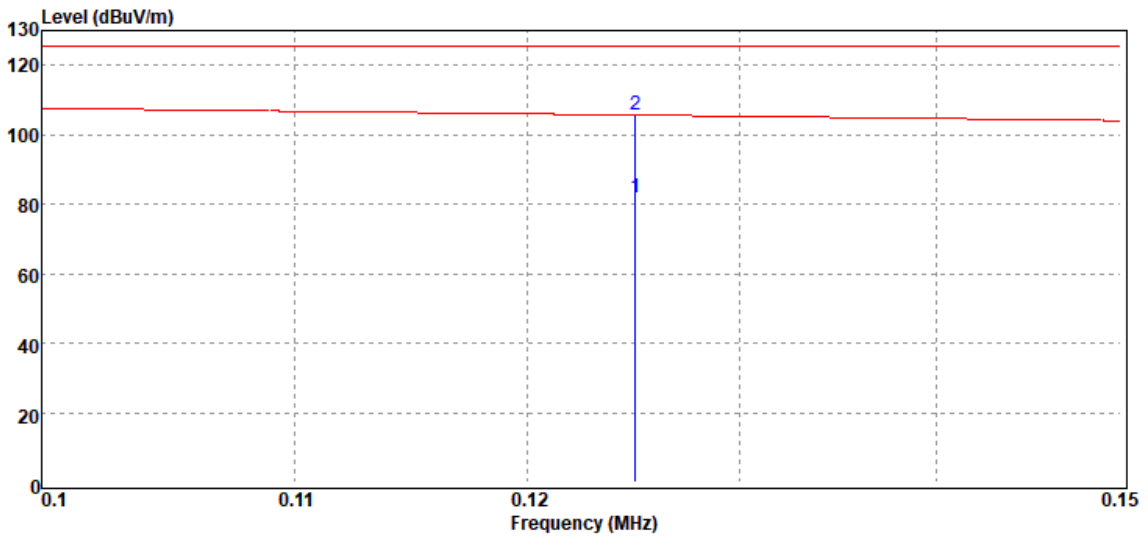

Freq. MHz	Detector Mode PK/QP/AV	Spectrum Reading Level dB μ V	Factor dB	Actual FS dB μ V/m	Limit @3m dB μ V/m	Margin dB
0.13	Average	-	-23.38	82.14	105.67	-23.53
0.13	Peak	92.43	13.09	105.52	125.67	-20.15
N/A						

Report No.: T200507W04-RP

Operation Mode: Operating mode
Temperature: 23.6°C
Humidity: 45% RH

Test Date: May 20, 2020
Tested by: Jerry Chang
Antenna Pol.: Horizontal

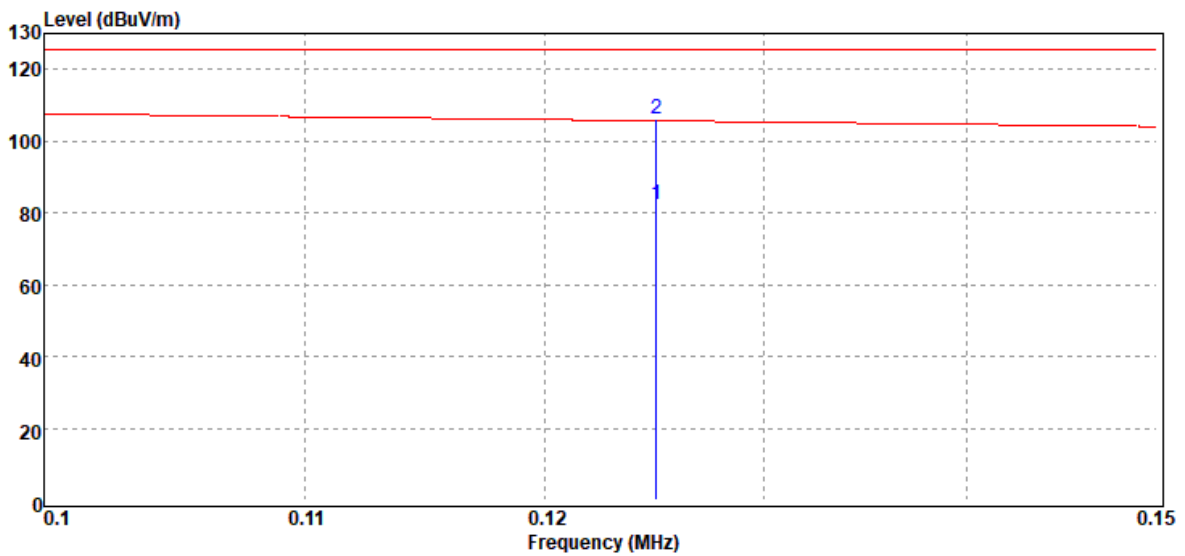

Freq. MHz	Detector Mode PK/QP/AV	Spectrum Reading Level dB μ V	Factor dB	Actual FS dB μ V/m	Limit @3m dB μ V/m	Margin dB
0.13	Average	-	-23.72	82.49	105.67	-23.18
0.13	Peak	93.12	13.09	106.21	125.67	-19.46
N/A						

Report No.: T200507W04-RP

9 kHz – 30MHz

Operation Mode: Operating mode

Test Date: May 20, 2020

Temperature: 23.6°C

Tested by: Jerry Chang

Humidity: 45% RH

Antenna Pol.: Vertical

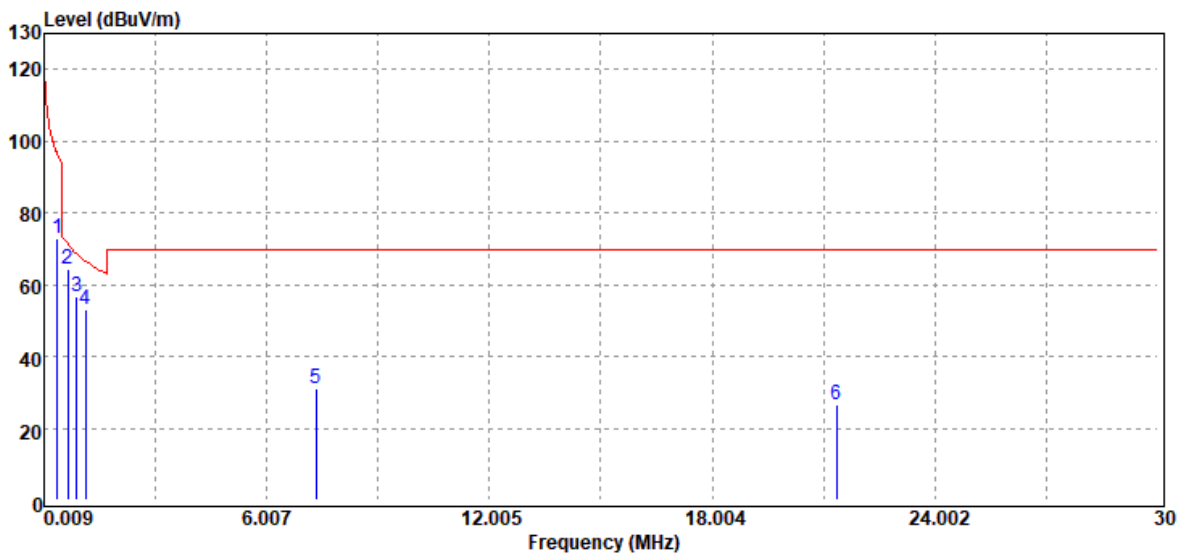

Freq. MHz	Detector Mode PK/QP/AV	Spectrum Reading Level dB μ V	Factor dB	Actual FS dB μ V/m	Limit @3m dB μ V/m	Margin dB
0.37	Peak	58.85	13.84	72.69	96.26	-23.57
0.64	Peak	50.27	13.90	64.17	71.50	-7.33
0.88	Peak	42.57	13.95	56.52	68.73	-12.21
1.12	Peak	39.17	14.00	53.17	66.63	-13.46
7.33	Peak	15.62	15.28	30.90	69.54	-38.64
21.36	Peak	11.84	14.75	26.59	69.54	-42.95

Remark:

1. the frequency bands 9-90 kHz, 110-490 kHz measurements employing an average detector and other below 1GHz measurements employing a CISPR quasi-peak detector.

Report No.: T200507W04-RP

Operation Mode: Operating mode
Temperature: 23.6°C
Humidity: 45% RH

Test Date: May 20, 2020
Tested by: Jerry Chang
Antenna Pol.: Horizontal

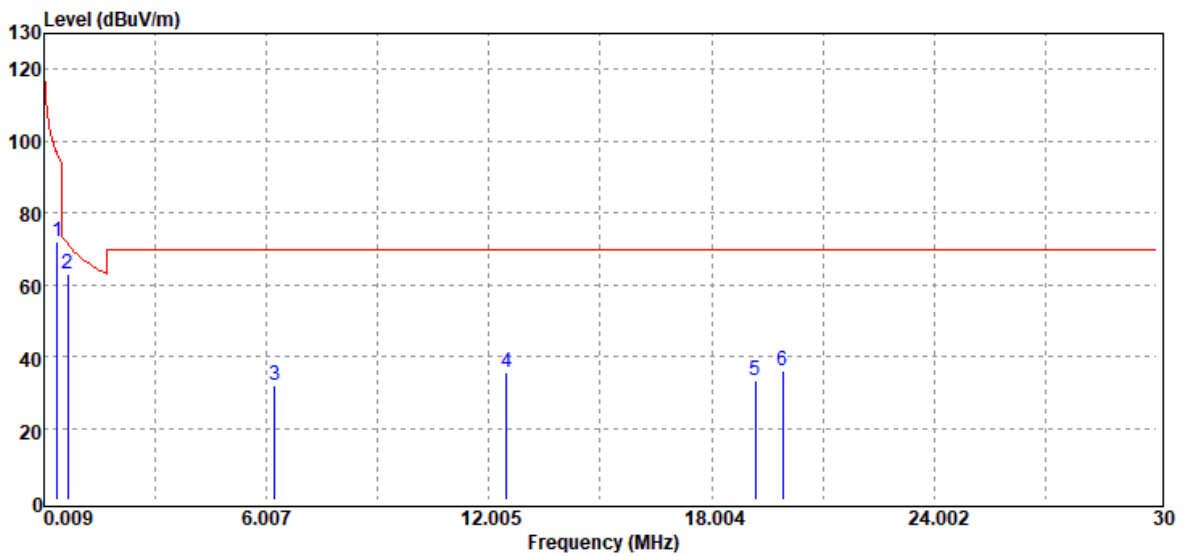

Freq. MHz	Detector Mode PK/QP/AV	Spectrum Reading Level dB μ V	Factor dB	Actual FS dB μ V/m	Limit @3m dB μ V/m	Margin dB
0.37	Peak	58.24	13.84	72.08	96.26	-24.18
0.64	Peak	49.25	13.90	63.15	71.50	-8.35
6.22	Peak	16.86	15.13	31.99	69.54	-37.55
12.49	Peak	20.29	15.40	35.69	69.54	-33.85
19.17	Peak	18.08	15.12	33.20	69.54	-36.34
19.92	Peak	20.72	15.09	35.81	69.54	-33.73

Remark:

1. the frequency bands 9-90 kHz, 110-490 kHz measurements employing an average detector and other below 1GHz measurements employing a CISPR quasi-peak detector.

Report No.: T200507W04-RP

Below 1 GHz

Operation Mode: Operating mode

Test Date: May 20, 2020

Temperature: 23.6°C

Tested by: Jerry Chang

Humidity: 45% RH

Antenna Pol.: Vertical

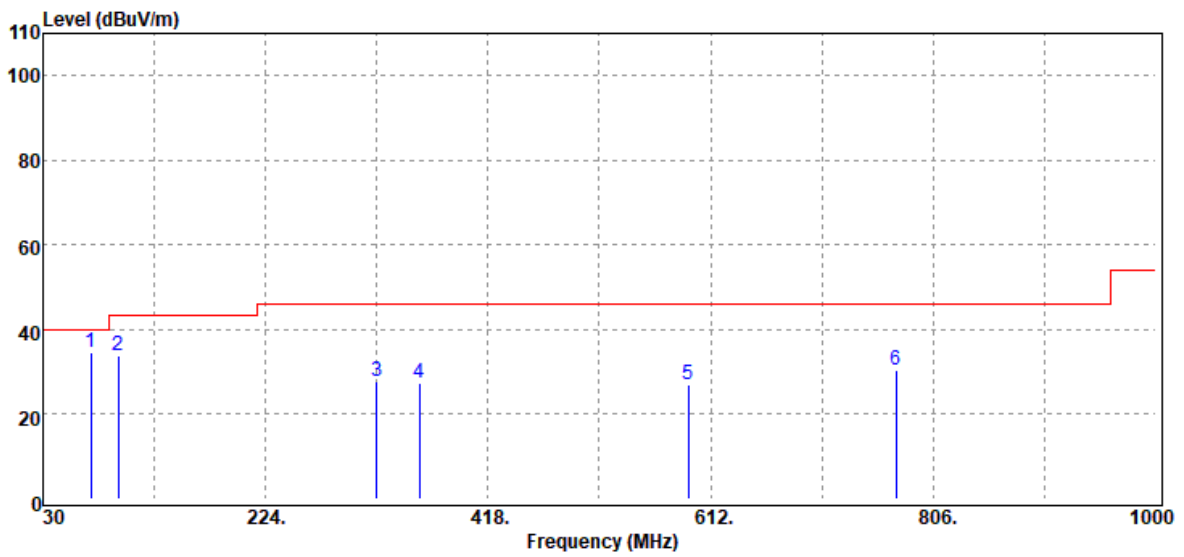

Freq. MHz	Detector Mode PK/QP/AV	Spectrum Reading Level dB μ V	Factor dB	Actual FS dB μ V/m	Limit @3m dB μ V/m	Margin dB
71.71	Peak	49.73	-14.95	34.78	40.00	-5.22
95.96	Peak	47.96	-14.12	33.84	43.50	-9.66
321.00	Peak	35.53	-7.88	27.65	46.00	-18.35
357.86	Peak	34.22	-6.88	27.34	46.00	-18.66
592.60	Peak	29.01	-2.11	26.90	46.00	-19.10
773.99	Peak	29.32	1.28	30.60	46.00	-15.40

Report No.: T200507W04-RP

Operation Mode: Operating mode
Temperature: 23.6°C
Humidity: 45% RH

Test Date: May 20, 2020
Tested by: Jerry Chang
Antenna Pol.: Horizontal

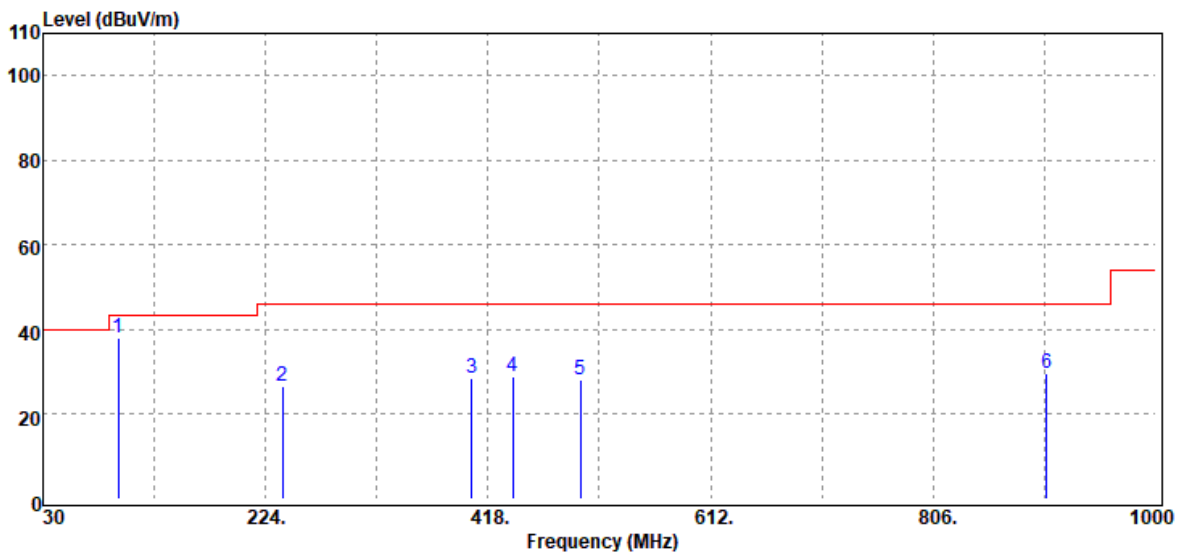

Freq. MHz	Detector Mode PK/QP/AV	Spectrum Reading Level dBμV	Factor dB	Actual FS dBμV/m	Limit @3m dBμV/m	Margin dB
95.96	Peak	52.16	-14.12	38.04	43.50	-5.46
238.55	Peak	37.13	-10.65	26.48	46.00	-19.52
403.45	Peak	34.20	-5.76	28.44	46.00	-17.56
439.34	Peak	33.66	-4.55	29.11	46.00	-16.89
498.51	Peak	31.48	-3.27	28.21	46.00	-17.79
904.94	Peak	25.97	3.58	29.55	46.00	-16.45

Report No.: T200507W04-RP

8.3 AC CONDUCTED EMISSION

LIMIT

According to §15.207(a) , for an intentional radiator that is designed to be connected to the public utility (AC) power line, the radio frequency voltage that is conducted back onto the AC power line on any frequency or frequencies within the band 150 kHz to 30 MHz shall not exceed the limits in the following table, as measured using a 50 μ H/50 ohms line impedance stabilization network (LISN). Compliance with the provisions of this paragraph shall be based on the measurement of the radio frequency voltage between each power line and ground at the power terminal. The lower limit applies at the boundary between the frequency ranges.

Frequency Range (MHz)	Limits (dB μ V)	
	Quasi-peak	Average
0.15 to 0.50	66 to 56*	56 to 46*
0.50 to 5	56	46
5 to 30	60	50

Test Configuration

See test photographs attached in Appendix II for the actual connections between EUT and support equipment.

TEST PROCEDURE

1. The EUT was placed on a table, which is 0.8m above ground plane.
2. Maximum procedure was performed on the six highest emissions to ensure EUT compliance.
3. Repeat above procedures until all frequency measured were complete

TEST RESULTS

Not applicable, because EUT doesn't connect to AC Main Source direct.

8.4 ANTENNA REQUIREMENT

An intentional radiator shall be designed to ensure that no antenna other than that furnished by the responsible party shall be used with the device. The use of a permanently attached antenna or of an antenna that uses a unique coupling to the intentional radiator shall be considered sufficient to comply with the provisions of this section. The manufacturer may design the unit so that a broken antenna can be replaced by the user, but the use of a standard antenna jack or electrical connector is prohibited. This requirement does not apply to carrier current devices or to devices operated under the provisions of §15.211, §15.213, §15.217, §15.219, or §15.221. Further, this requirement does not apply to intentional radiators that must be professionally installed, such as perimeter protection systems and some field disturbance sensors, or to other intentional radiators which, in accordance with §15.31(d), must be measured at the installation site. However, the installer shall be responsible for ensuring that the proper antenna is employed so that the limits in this part are not exceeded.

- End of Test Report -