

# FCC RADIO TEST REPORT

## FCC 47 CFR PART 15 SUBPART C

<b>Test Standard</b>	<b>FCC Part 15.231</b>
<b>FCC ID</b>	<b>KR5180528</b>
<b>Trade name</b>	<b>Continental</b>
<b>Product name</b>	<b>PAG Transmitter (Car Key)</b>
<b>Model No.</b>	<b>PAG-KEY-433-180528, PAG-KEY-434-180528</b>
<b>Operation Freq.</b>	<b>433.92 MHz &amp; 434.42 MHz</b>
<b>Test Result</b>	<b>Pass</b>

The test Result was tested by Compliance Certification Services Inc. The test data, data evaluation, test procedures, and equipment configurations shown in this report were given in ANSI C63.10: 2013 and compliance standards.

The test results of this report relate only to the tested sample (EUT) identified in this report.

The test Report of full or partial shall not copy. Without written approval of SGS Compliance Certification Services Inc.(Wugu Laboratory)



Approved by:

Reviewed by:



---

Sam Chuang  
Manager

---

Jerry Chuang  
Engineer

## **Revision History**

Rev.	Issue Date	Revisions	Revised By
00	January 22, 2018	Initial Issue	Allison Chen
01	March 26, 2018	Modify section 4.2.2	Angel Cheng

# Table of contents

<b>1. GENERAL INFORMATION .....</b>	<b>4</b>
<b>1.1 EUT INFORMATION .....</b>	<b>4</b>
<b>1.2 EUT CHANNEL INFORMATION .....</b>	<b>5</b>
<b>1.3 ANTENNA INFORMATION .....</b>	<b>5</b>
<b>1.4 MEASUREMENT UNCERTAINTY .....</b>	<b>6</b>
<b>1.5 FACILITIES AND TEST LOCATION .....</b>	<b>7</b>
<b>1.6 INSTRUMENT CALIBRATION .....</b>	<b>7</b>
<b>1.7 SUPPORT AND EUT ACCESSORIES EQUIPMENT .....</b>	<b>8</b>
<b>1.8 TEST METHODOLOGY AND APPLIED STANDARDS .....</b>	<b>8</b>
<b>2. TEST SUMMERY .....</b>	<b>9</b>
<b>3. DESCRIPTION OF TEST MODES .....</b>	<b>10</b>
<b>3.1 THE WORST MODE OF OPERATING CONDITION .....</b>	<b>10</b>
<b>3.2 THE WORST MODE OF MEASUREMENT .....</b>	<b>10</b>
<b>3.3 EUT DUTY CYCLE .....</b>	<b>11</b>
<b>4. TEST RESULT .....</b>	<b>13</b>
<b>4.1 AC POWER LINE CONDUCTED EMISSION .....</b>	<b>13</b>
<b>4.2 EMISSION BANDWIDTH .....</b>	<b>14</b>
<b>4.3 FIELD STRENGTH OF FUNDAMENTAL .....</b>	<b>17</b>
<b>4.4 RADIATION UNWANTED EMISSION .....</b>	<b>21</b>
<b>4.5 OPERATION RESTRICTION .....</b>	<b>33</b>
<b>APPENDIX 1 – PHOTOGRAPHS OF EUT</b>	

# 1. GENERAL INFORMATION

## 1.1 EUT INFORMATION

Applicant	Continental Automotive GmbH Siemensstrasse 12 SV C TS RBG EMC-Laboratory Regensburg, 93055 Germany
Manufacturer	Huf Hülbeck & Fürst GmbH & Co. KG Steeger Straße 17, 42551 Velbert, Germany
Equipment	PAG Transmitter (Car Key)
Model Name	PAG-KEY-433-180528, PAG-KEY-434-180528
Model Discrepancy	Different from operation frequency see as below: PAG-KEY-433-180528 →TX 433.92MHz / RX 125kHz PAG-KEY-434-180528 →TX 434.42MHz / RX 125kHz
Received Date	January 5, 2018
Date of Test	January 11 ~ January 22, 2018
Periodic operation	<input checked="" type="checkbox"/> (1) A manually operated transmitter shall employ a switch that will automatically deactivate the transmitter within not more than 5 seconds of being released. <input type="checkbox"/> (2) A transmitter activated automatically shall cease transmission within 5 seconds after activation <input type="checkbox"/> (3) Periodic transmissions at regular predetermined intervals are not permitted. <input type="checkbox"/> (4) Periodic transmissions (lower field strength): each transmission is not greater than 1 sec and the silent period between transmissions is at least 30 times the duration of the transmission but in no case less than 10 sec.
Power Operation	Battery 1 x CR2032 (Lithium Standard-Battery: 3V)

## 1.2 EUT CHANNEL INFORMATION

Frequency Range	433.92 MHz, 434.42 MHz
Modulation Type	ASK
Bandwidth	110.2749 KHz
Number of Channels	1 channel

**Remark:**

Refer as ANSI 63.10:2013 clause 5.6.1 Table 4 for test channels

Number of frequencies to be tested		
Frequency range in which device operates	Number of frequencies	Location in frequency range of operation
<input checked="" type="checkbox"/> 1 MHz or less	1	Middle
<input type="checkbox"/> 1 MHz to 10 MHz	2	1 near top and 1 near bottom
<input type="checkbox"/> More than 10 MHz	3	1 near top, 1 near middle, and 1 near bottom

## 1.3 ANTENNA INFORMATION

Antenna Type	Loop antenna (PCB routed antenna)
Antenna Gain	-20.01dBi

## 1.4 MEASUREMENT UNCERTAINTY

PARAMETER	UNCERTAINTY
AC Powerline Conducted Emission	+/- 1.2575
Emission bandwidth, 20dB bandwidth	+/- 1.4003
RF output power, conducted	+/- 1.1372
Power density, conducted	+/- 1.4003
3M Semi Anechoic Chamber / 30M~200M	+/- 4.0138
3M Semi Anechoic Chamber / 200M~1000M	+/- 3.9483
3M Semi Anechoic Chamber / 1GHz~8GHz	+/- 2.5975
3M Semi Anechoic Chamber / 8GHz~18GHz	+/- 2.6112
3M Semi Anechoic Chamber / 18GHz~26GHz	+/- 2.7389
3M Semi Anechoic Chamber / 26GHz~40GHz	+/- 2.9683
3M Semi Anechoic Chamber / 40GHz~60GHz	+/- 1.8509
3M Semi Anechoic Chamber / 60GHz~75GHz	+/- 1.9869
3M Semi Anechoic Chamber / 75GHz~110GHz	+/- 2.9651
3M Semi Anechoic Chamber / 110GHz~170GHz	+/- 2.7807
3M Semi Anechoic Chamber / 170GHz~220GHz	+/- 3.6437
3M Semi Anechoic Chamber / 220GHz~325GHz	+/- 4.2982

**Remark:**

1. This uncertainty represents an expanded uncertainty expressed at approximately the 95% confidence level using a coverage factor of  $k=2$
2. ISO/IEC 17025 requires that an estimate of the measurement uncertainties associated with the emissions test results be included in the report.

## 1.5 FACILITIES AND TEST LOCATION

All measurement facilities used to collect the measurement data are located at  
 No.11, Wugong 6th Rd., Wugu Dist., New Taipei City 24891, Taiwan. (R.O.C.)

Test site	Test Engineer	Remark
AC Conduction Room	N/A	Not applicable
Radiation	Jerry Chuang	-
RF Conducted	Jerry Chuang	-

**Remark:** The sites are constructed in conformance with the requirements of ANSI C63.7, ANSI C63.4 and CISPR Publication 22.

## 1.6 INSTRUMENT CALIBRATION

RF Conducted Test Site					
Equipment	Manufacturer	Model	S/N	Cal Date	Cal Due
Spectrum Analyzer	R&S	FSV 40	101073	10/02/2017	10/01/2018

3M 966 Chamber Test Site					
Equipment	Manufacturer	Model	S/N	Cal Date	Cal Due
Bilog Antenna	Sunol Sciences	JB3	A030105	06/20/2017	06/19/2018
Pre-Amplifier	EMEC	EM330	60609	06/07/2017	06/06/2018
Spectrum Analyzer	Agilent	E4446A	US42510252	11/27/2017	11/26/2018
Antenna Tower	CCS	CC-A-1F	N/A	N.C.R	N.C.R
Controller	CCS	CC-C-1F	N/A	N.C.R	N.C.R
Turn Table	CCS	CC-T-1F	N/A	N.C.R	N.C.R
Pre-Amplifier	HP	8449B	3008A00965	06/27/2017	06/26/2018
Filter	N/A	580-6000	N/A	N/A	N/A
Cable	HUBER SUHNER	SUCOFLEX 104PEA	25157	07/31/2017	07/30/2018
Cable	HUBER SUHNER	SUCOFLEX 104PEA	20995	07/31/2017	07/30/2018
Horn Antenna	EMCO	3117	55165	02/20/2017	02/19/2018

**Remark:** Each piece of equipment is scheduled for calibration once a year.

## 1.7 SUPPORT AND EUT ACCESSORIES EQUIPMENT

There are no accessories and support equipment be used during the test.

EUT Accessories Equipment					
No.	Equipment	Brand	Model	Series No.	FCC ID
	N/A				

Support Equipment					
No.	Equipment	Brand	Model	Series No.	FCC ID
	N/A				

## 1.8 TEST METHODOLOGY AND APPLIED STANDARDS

The test methodology, setups and results comply with all requirements in accordance with ANSI C63.10:2013, FCC 15.231 Rules.



## 2. TEST SUMMERY

Standard Sec.	Chapter	Test Item	Result
15.203	1.2	Antenna Requirement	Pass
15.207	4.1	AC Power-line Conducted Emission	Not applicable
15.231(c)	4.2	Emission Bandwidth	Pass
15.231(b)	4.3	Fundamental Emission	Pass
15.209(b)	4.4	Transmitter Radiated Emission	Pass
15.231(a)(1)	4.5	Operation Restriction	Pass

### 3. DESCRIPTION OF TEST MODES

#### 3.1 THE WORST MODE OF OPERATING CONDITION

Operation mode	433.92 MHz
RF Filed strength	<u>Peak: 78.91 dBuv/m</u> <u>Average : 72.29 dBuv/m</u>

Operation mode	434.42 MHz
RF Filed strength	<u>Peak: 78.67 dBuv/m</u> <u>Average : 70.81 dBuv/m</u>

Remark: Field strength performed Average level at 3m.

#### 3.2 THE WORST MODE OF MEASUREMENT

Radiated Emission Measurement Above 1G	
Test Condition	Band edge, Emission for Unwanted and Fundamental
DC Voltage	DC 3V
Test Mode	Mode 1:EUT power by Battery.
Worst Mode	<input checked="" type="checkbox"/> Mode 1 <input type="checkbox"/> Mode 2 <input type="checkbox"/> Mode 3 <input type="checkbox"/> Mode 4
Worst Position	<input type="checkbox"/> Placed in fixed position. <input checked="" type="checkbox"/> Placed in fixed position at X-Plane (E2-Plane) <input type="checkbox"/> Placed in fixed position at Y-Plane (E1-Plane) <input type="checkbox"/> Placed in fixed position at Z-Plane (H-Plane)
Worst Polarity	<input checked="" type="checkbox"/> Horizontal <input type="checkbox"/> Vertical

Radiated Emission Measurement Below 1G	
Test Condition	Radiated Emission Below 1G
DC Voltage	DC 3V
Test Mode	Mode 1:EUT power by Battery.
Worst Mode	<input checked="" type="checkbox"/> Mode 1 <input type="checkbox"/> Mode 2 <input type="checkbox"/> Mode 3 <input type="checkbox"/> Mode 4

Remark:

1. The worst mode was record in this test report.
2. EUT pre-scanned in three axis ,X,Y, Z and two polarity, Horizontal and Vertical for radiated measurement. The worst case(X-Plane and Horizontal) were recorded in this report
3. For below 1G, Radiation emission were performed the EUT transmit at the highest output power channel as worse case.

### 3.3 EUT DUTY CYCLE

#### 433.92MHz

Duty Cycle	
TX ON (ms)	Duty Factor(dB)
46.667	-6.62

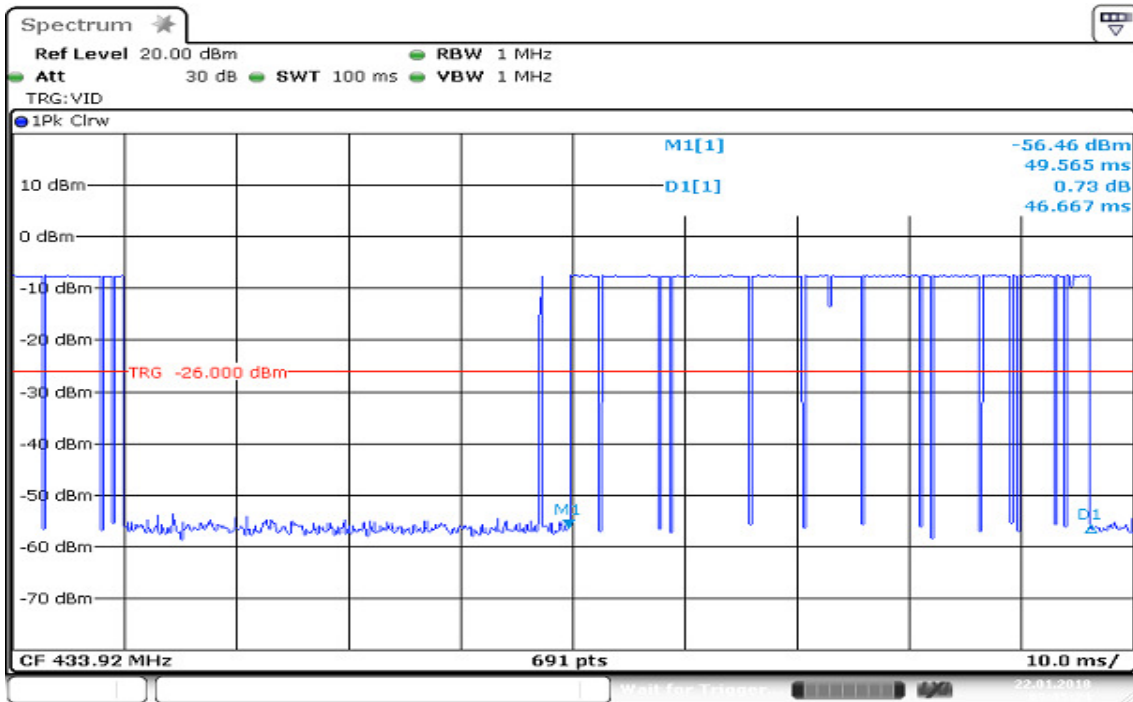

Notes:

1. The transmitter duty cycle was measured using a spectrum analyser in the time domain and calculated by  $20 \log(\text{Time}_{(on)} / [\text{Period or } 100 \text{ ms whichever is the lesser}])$
2. The EUT transmits for a  $\text{Time}_{(on)}$  of 46.667 milliseconds within the specified 100ms period.  
 $20 \log(\text{Time}_{(on)} / [\text{Period or } 100 \text{ ms whichever is the lesser}])$   
 $20 \log(46.667/100) = -6.62\text{dB}$

**434.42 MHz**

Duty Cycle	
TX ON (ms)	Duty Factor(dB)
40.435	-7.86

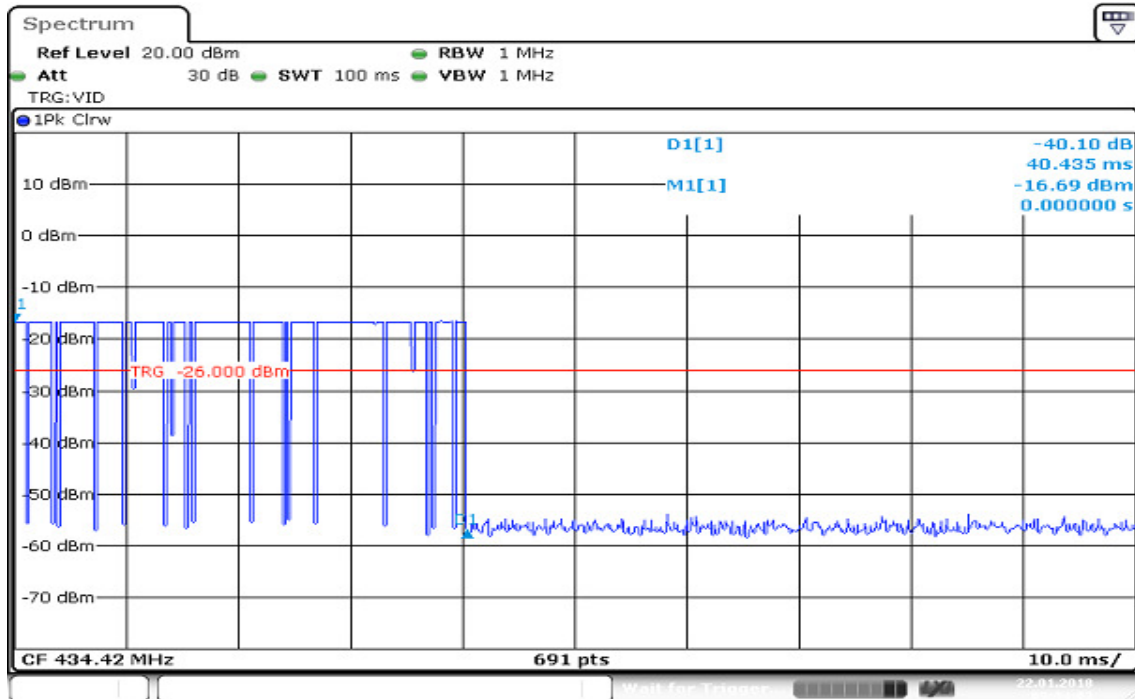

Date: 22.JAN.2018 09:34:03

**Notes:**

1. The transmitter duty cycle was measured using a spectrum analyser in the time domain and calculated by  $20 \log(\text{Time}_{(on)} / [\text{Period or } 100 \text{ ms whichever is the lesser}])$
2. The EUT transmits for a  $\text{Time}_{(on)}$  of 40.435 milliseconds within the specified 100ms period.

$$20 \log (\text{Time}_{(on)} / [\text{Period or } 100 \text{ ms whichever is the lesser}]).$$

$$20 \log (40.435/100) = -7.86\text{dB}$$

## 4. TEST RESULT

### 4.1 AC POWER LINE CONDUCTED EMISSION

#### 4.1.1 Test Limit

According to §15.207(a) ,

Frequency Range (MHz)	Limits(dB $\mu$ V)	
	Quasi-peak	Average
0.15 to 0.50	66 to 56*	56 to 46*
0.50 to 5	56	46
5 to 30	60	50

\* Decreases with the logarithm of the frequency.

#### 4.1.2 Test Procedure

Test method Refer as ANSI 63.10:2013 clause 6.2,

1. The EUT was placed on a table, which is 0.8m above ground plane.
2. Maximum procedure was performed on the six highest emissions to ensure EUT compliance.
3. Repeat above procedures until all frequency measured were complete

#### 4.1.3 Test Setup

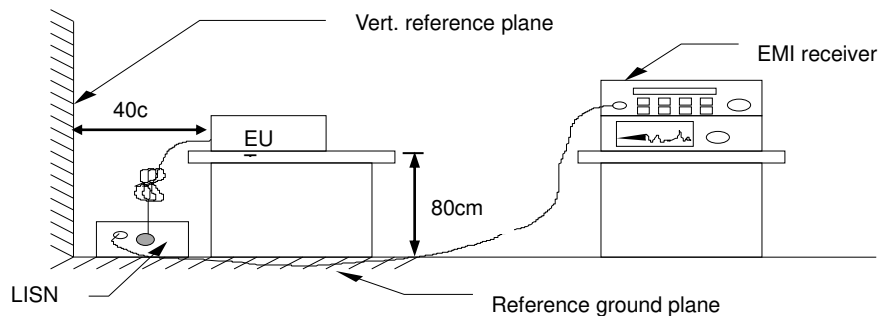

#### 4.1.4 Test Result

**Not applicable**

## 4.2 EMISSION BANDWIDTH

### 4.2.1 Test Limit

According to §15.231© ,

Limit	<input checked="" type="checkbox"/> 70 MHz – 900 MHz : $F_c * 0.25 \%$ <input type="checkbox"/> Above 900 MHz : $F_c * 0.5 \%$
-------	---

### 4.2.2 Test Procedure

Test method Refer as ANSI 63.10:2013 clause 6.9.2,

1. The EUT RF output connected to the spectrum analyzer by RF cable.
2. Setting maximum power transmit of EUT
3. RBW=10KHz, VBW  $\geq 3 \times$  RBW, Detector = Peak, Trace mode = Max hold, Sweep = Auto., to measurement 20dB Bandwidth
4. SA set RBW = 1% ~ 5% OBW, VBW = three times the RBW and Detector = Peak, to measurement 99% Bandwidth
5. Measure and record the result of 20 dB Bandwidth and 99% Bandwidth. in the test report.

### 4.2.3 Test Setup

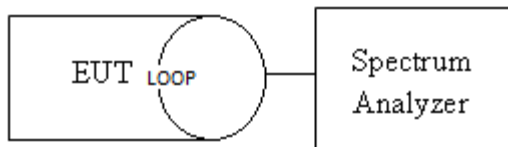

### 4.2.4 Test Result

Spectrum Bandwidth			
Frequency (MHz)	99% Occupied BW (KHz)	20dB Bandwidth (KHz)	20dB Bandwidth Limits (MHz)
433.92	110.2749	32.130	1.0848
434.42	110.2749	32.130	1.0860

**Test Data**

**433.92 MHz  
20dB Bandwidth**

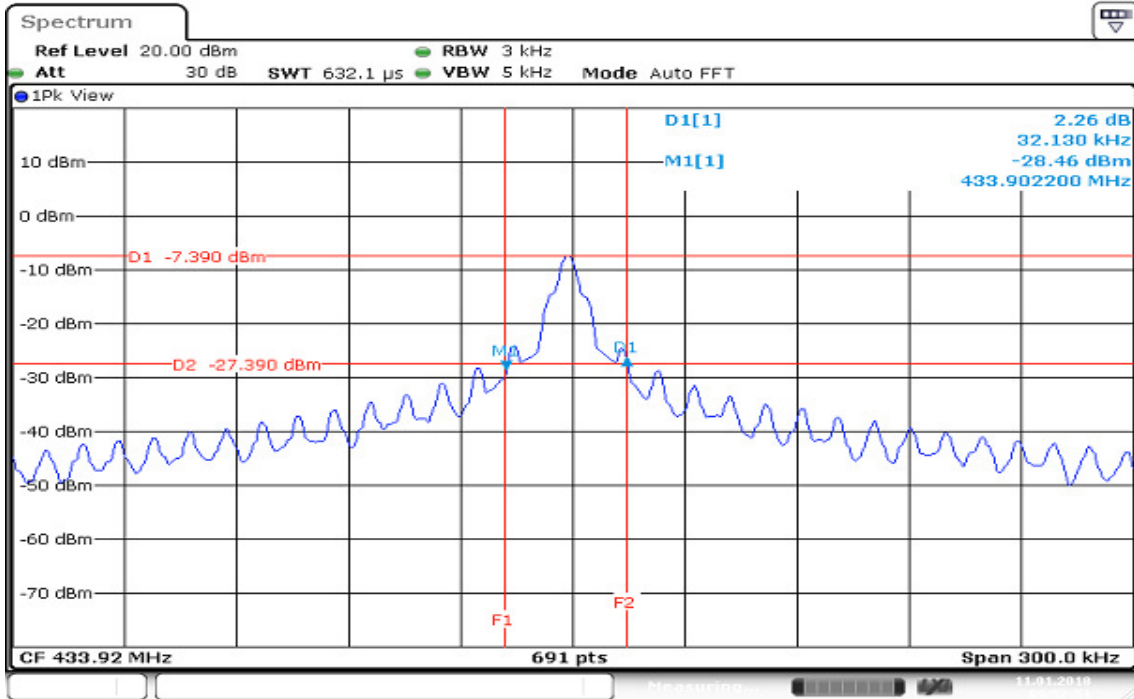

Date: 11 JAN 2018 09:57:51

**99% Occupied BW**

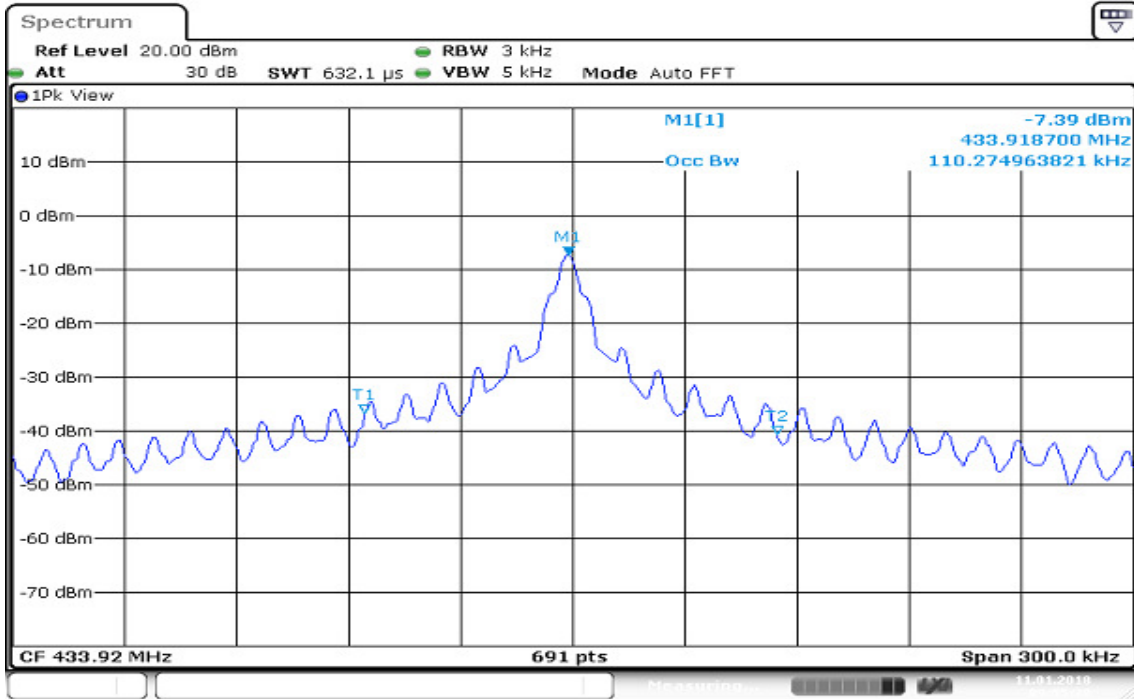

Date: 11 JAN 2018 09:55:39

### 434.42 MHz 20dB Bandwidth

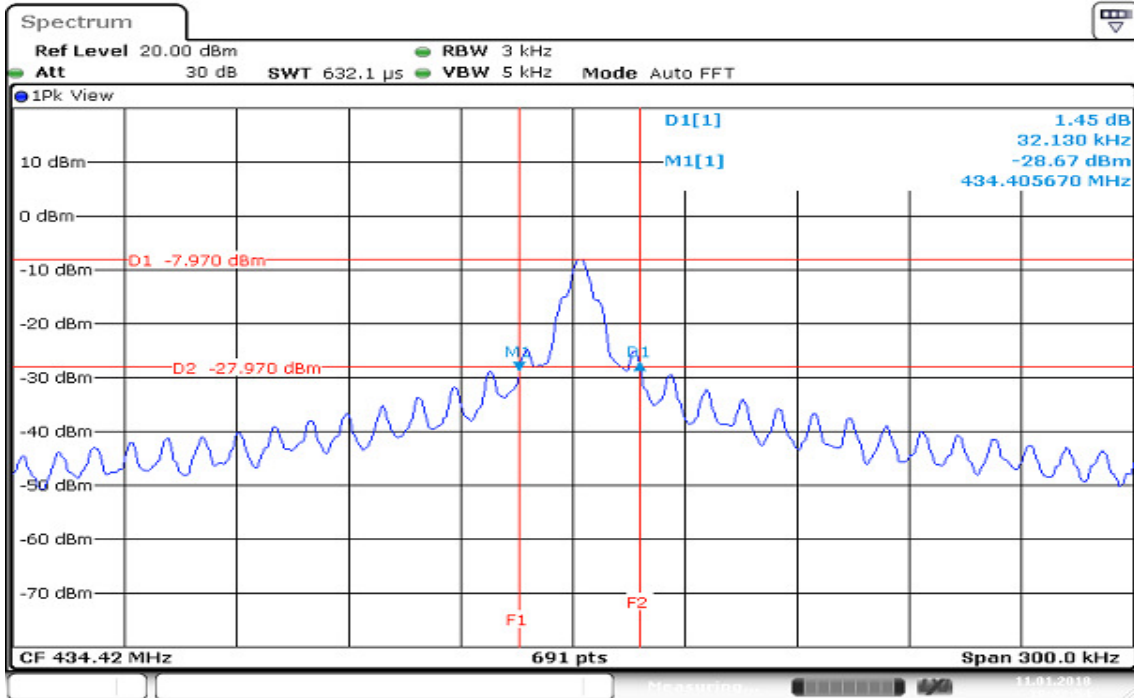

### 99% Occupied BW

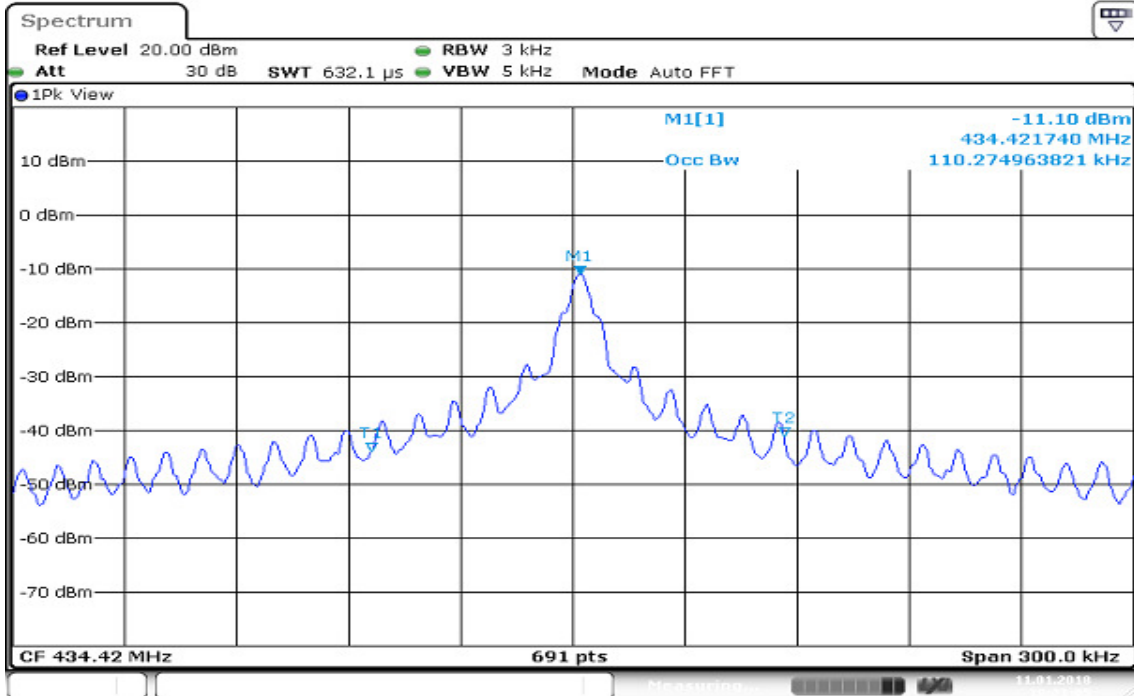



### 4.3 FIELD STRENGTH OF FUNDAMENTAL

#### 4.3.1 Test Limit

According to §15.231(b)

Fundamental frequency (MHz)	Field strength of fundamental (uv/m) at 3m	Field strength of fundamental (dBuv/m) at 3m
40.66-40.70	2,250	67
70-130	1,250	61.9
*130-174	*1,250 to 3,750	61.9-71.5
174-260	3,750	71.5
*260-470	*3,750 to 12,500	71.5-81.9
Above 470	12,500	81.9

**REMARK:**

1. Linear interpolations
2. Based on the average value of the measured Field strength of fundamental.

#### 4.3.2 Test Procedure

Test method Refer as ANSI 63.10:2013 clause 4.1.4 and clause 6.5

clause 4.1.4	<input checked="" type="checkbox"/> 4.1.4.2.2: Measurement Peak value. <input type="checkbox"/> 4.1.4.2.3: Duty cycle ≥ 100%. <input checked="" type="checkbox"/> 4.1.4.2.4: Measurement Average value.
--------------	---

### 4.3.3 Test Setup

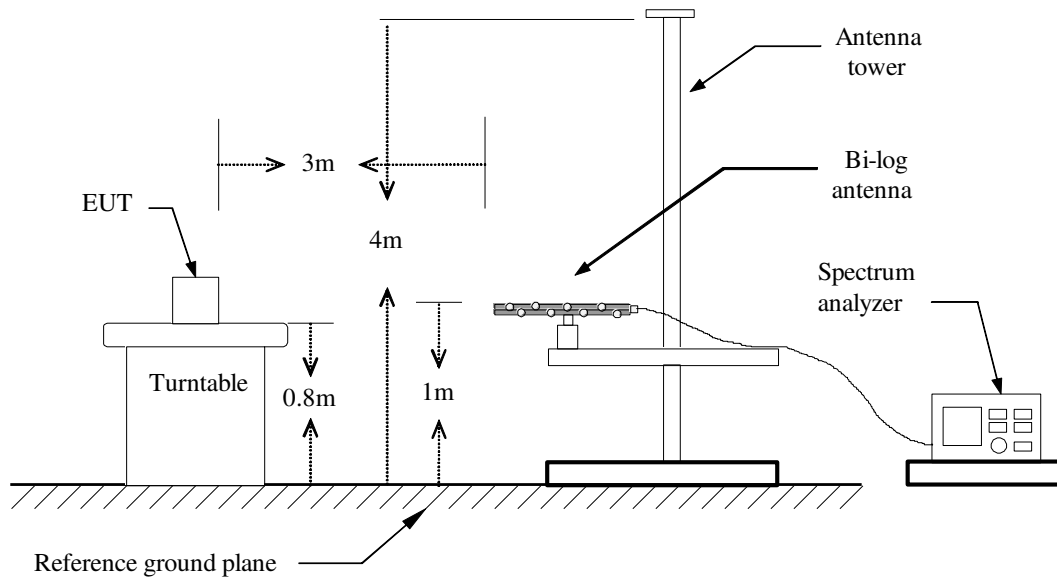

### 4.3.4 Test Result

#### 433.92 MHz

Field Strength					
Frequency (MHz)	Fundamental (dBuV/m) at 3m	Limit (dBuV/m) at 3m	Margin (dB)	Axis/Pol.	Remark
433.9180	72.29	80.82	-8.53	X/H	AVG

**Remark:**

1. Fundamental measured method setting on spectrum, RBW=100 kHz, VBW=100kHz and Detector=Peak.
2. Average result = Peak result + Duty factor = 78.91 dBuV/m – 6.62 = 72.29 dBuV/m
3. 260MHz ~ 470MHz limit is  $41.6667 * (\text{Frequency, MHz}) - 7083.3333$   
 $\text{Limit} = 41.6667 * (433.9180 \text{ MHz}) - 7083.3333$   
 $= 10996.59783 \text{ (uV/m)}$   
 $\text{dBuV/m} = 20 \text{ Log (uV/m)} = 20 \text{ Log (10996.59783 uV/m)} = 80.82\text{dBuV/m}$

#### 434.42 MHz

Field Strength					
Frequency (MHz)	Fundamental (dBuV/m) at 3m	Limit (dBuV/m) at 3m	Margin (dB)	Axis/Pol.	Remark
434.4220	70.81	80.84	-10.03	X/H	AVG

**Remark:**

1. Fundamental measured method setting on spectrum, RBW=100 kHz, VBW=100kHz and Detector=Peak.
2. Average result = Peak result + Duty factor = 78.67 dBuV/m – 7.86 = 70.81 dBuV/m
3. 260MHz ~ 470MHz limit is  $41.6667 * (\text{Frequency, MHz}) - 7083.3333$   
 $\text{Limit} = 41.6667 * (434.4220 \text{ MHz}) - 7083.3333$   
 $= 11017.59785 \text{ (uV/m)}$   
 $\text{dBuV/m} = 20 \text{ Log (uV/m)} = 20 \text{ Log (11017.59785 uV/m)} = 80.84\text{dBuV/m}$

### Test Data

Test Mode:	TX-433.92MHz	Temp/Hum	24(°C)/ 33%RH
Test Item	Fundamental	Test Date	2018/01/10
Axis/Polarize	X-Plane/Hor.	Test Engineer	Jerry Chuang
Detector	Peak	Test Voltage:	3Vdc

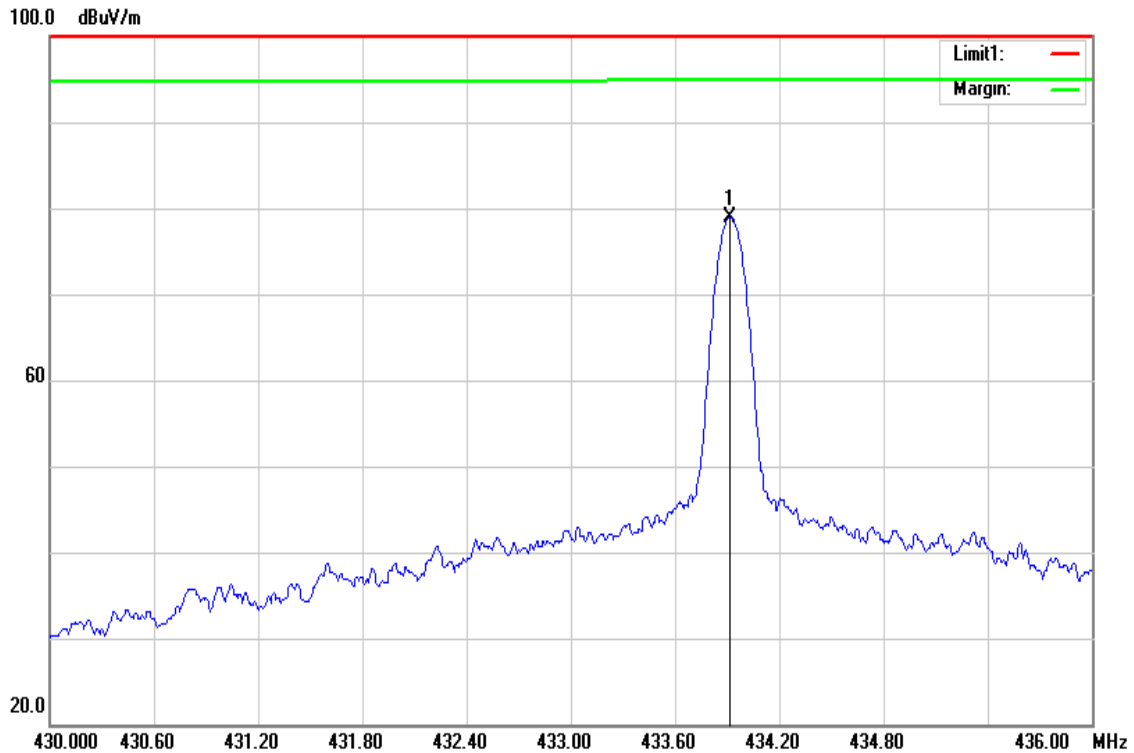

No	Frequency (MHz)	Reading (dBuV)	Correct Factor(dB/m)	Result (dBuV/m)	Limit (dBuV/m)	Margin (dB)	Remark
1	433.9180	89.08	-10.17	78.91	100.82	-21.91	peak

Test Mode:	TX-434.42MHz	Temp/Hum	24(°C)/ 33%RH
Test Item	Fundamental	Test Date	2018/01/10
Axis/Polarize	X-Plane/Hor.	Test Engineer	Jerry Chuang
Detector	Peak	Test Voltage:	3Vdc

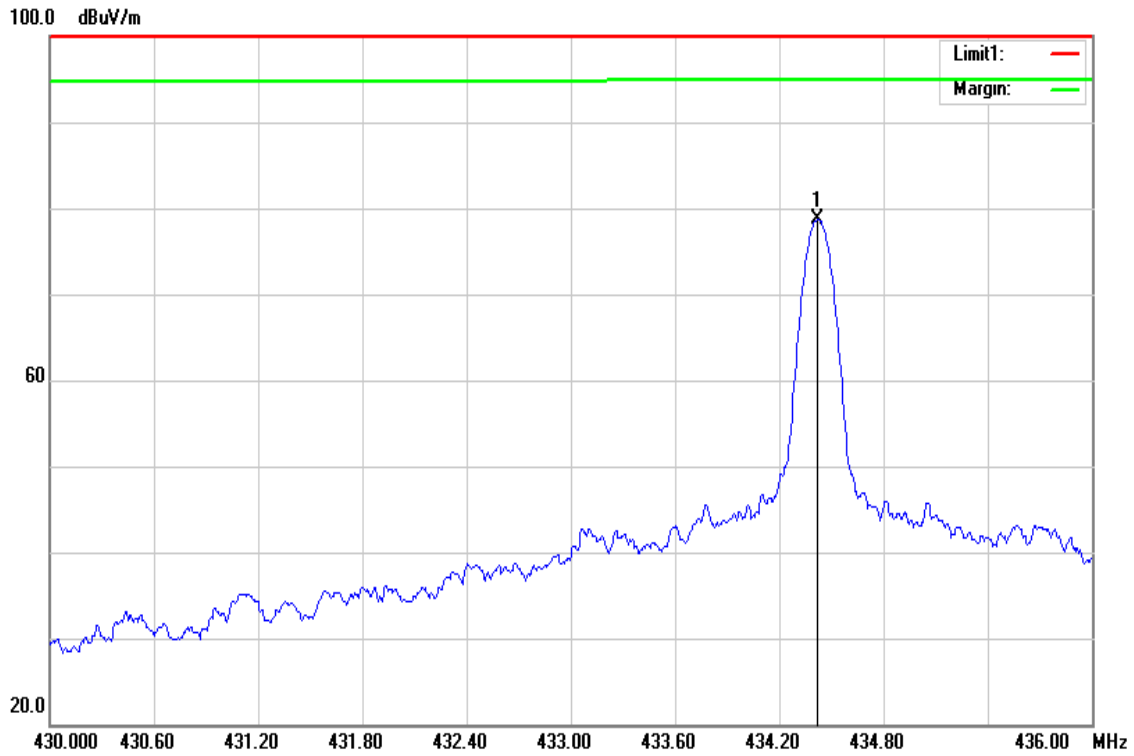

No	Frequency (MHz)	Reading (dBuV)	Correct Factor(dB/m)	Result (dBuV/m)	Limit (dBuV/m)	Margin (dB)	Remark
1	434.4220	88.83	-10.16	78.67	100.84	-22.17	peak

## 4.4 RADIATION UNWANTED EMISSION

### 4.4.1 Test Limit

According to §15.231(e) and §15.209

Unwanted emissions limit follow the table or the FCC Part 15.209, whichever limit permits higher field strength.

According to §15.231(b)

Fundamental frequency (MHz)	Field strength of Spurious emission (uv/m) at 3m	Field strength of Spurious emission (dBuv/m) at 3m
40.66-40.70	225	47
70-130	125	41.9
*130-174	*125-375	41.9-51.5
174-260	375	51.5
*260-470	*375-1250	51.5-61.9
Above 470	1250	61.9

**REMARK:**

1. Linear interpolations
2. Based on the average value of the measured Field strength of fundamental.

### Below 30MHz

Frequency (MHz)	Field Strength				
	(µV/m)	(dBµV/m)	Measurement Distance (meter)	(dBµV/m)	Measurement Distance (meter)
0.009 - 0.490	2400/F(kHz)	48.52 – 13.80	300	128.52–104.84	3
0.490 - 1.705	24000/F(kHz)	33.80 – 22.97	30	73.80– 62.97	3
1.705 – 30.0	30	29.54	30	69.54	3

### Above 30MHz

Frequency (MHz)	Field Strength		Measurement Distance (meter)
	(µV/m)	(dBµV/m)	
30-88	100	40.0	3
88-216	150	43.5	3
216-960	200	46.0	3
Above 960	500	54.0	3

### 4.4.2 Test Procedure

Test method Refer as ANSI 63.10:2013

<input checked="" type="checkbox"/> Unwanted Emission	<input checked="" type="checkbox"/> clause 4.1.4.2.2: Measurement Peak value. <input type="checkbox"/> clause 4.1.4.2.3: Duty cycle $\geq$ 100%. <input checked="" type="checkbox"/> clause 4.1.4.2.4: Measurement Average value.
---	---

<input checked="" type="checkbox"/> Radiated Emission	<input checked="" type="checkbox"/> clause 6.4: below 30 MHz and test distance is 3m. <input checked="" type="checkbox"/> clause 6.5: below 30 MHz -1 GHz and test distance is 3m. <input checked="" type="checkbox"/> clause 6.6: Above 30 MHz and test distance is 3m.
---	--

1. The EUT is placed on a turntable, which is 0.8m for test below 1GHz and 1.5m for test above 1GHz, above ground plane.
2. The turntable shall be rotated for 360 degrees to determine the position of maximum emission level.
3. EUT is set 3m away from the receiving antenna, which is varied from 1m to 4m to find out the highest emissions.
4. Maximum procedure was performed on the six highest emissions to ensure EUT compliance.
5. And also, each emission was to be maximized by changing the polarization of receiving antenna both horizontal and vertical.
6. Set the spectrum analyzer in the following setting as:  
 Below 1GHz:  
                     RBW=100kHz / VBW=300kHz / Sweep=AUTO  
 Above 1GHz:  
           (a)PEAK: RBW=1MHz / VBW=3MHz / Sweep=AUTO  
           (b)AVERAGE: RBW=1MHz,
7. Repeat above procedures until the measurements for all frequencies are complete.

**Remark.**

1. The EUT has a oscillator operating at 27.6 MHz, harmonic/spurious was verified. And didn't catch any emission at 27.6MHz.
2. Although these tests were performed other than open area test site, adequate comparison measurements were confirmed against 30 m open are test site. Therefore sufficient tests were made to demonstrate that the alternative site produces results that correlate with the ones of tests made in an open field based on KDB 937606.
3. No emission found between lowest internal used/generated frequency to 30MHz (9kHz~30MHz).

### 4.4.3 Test Setup

#### 9kHz ~ 30MHz

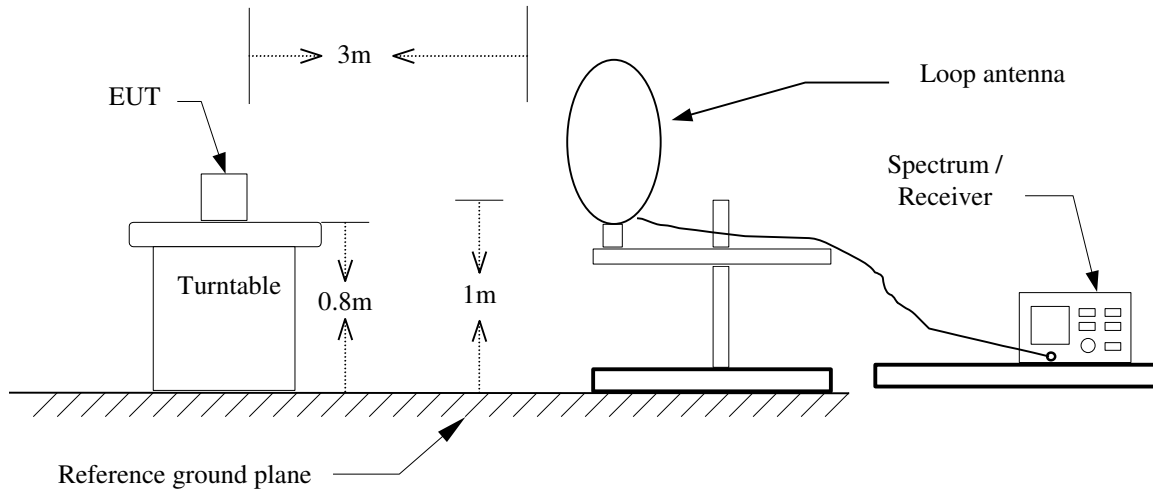

#### 30MHz ~ 1 GHz

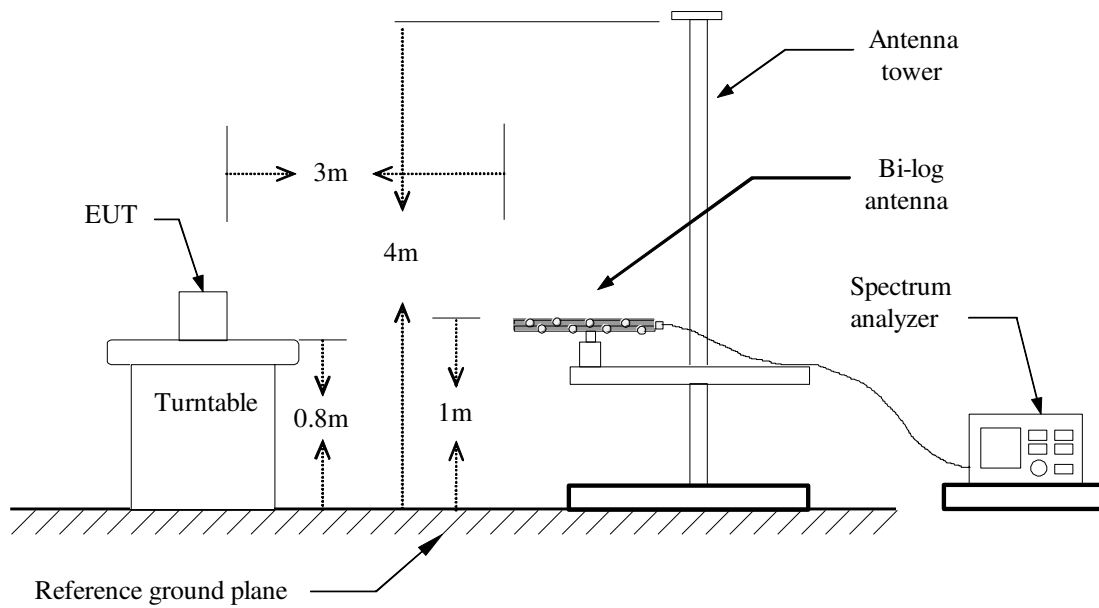

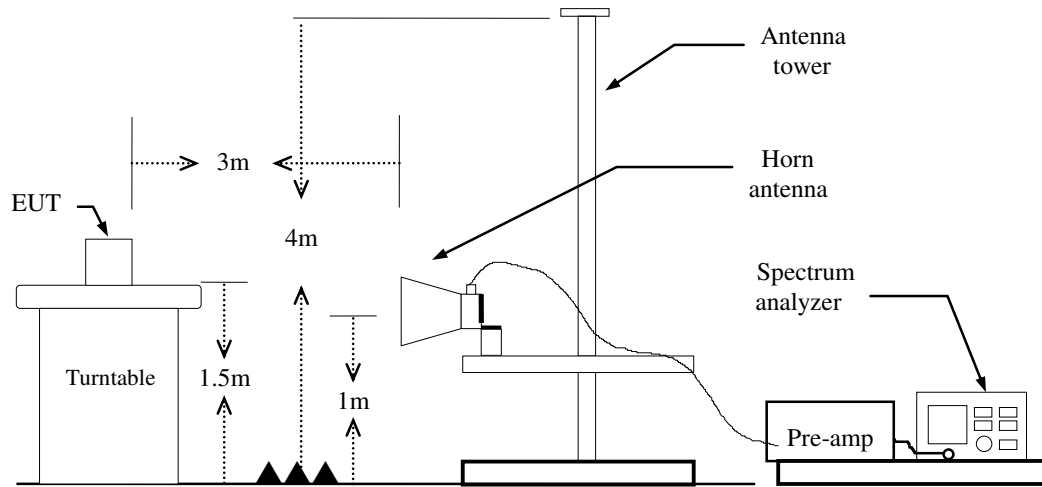
**Above 1 GHz****4.4.4 Test Result****Pass.**



**Test Data**

**Below 1GHz**

Test Mode:	TX-433.92MHz	Temp/Hum	24(°C)/ 33%RH
Test Item	Below 1GHz	Test Date	2018/01/10
Polarize	Vertical	Test Engineer	Jerry Chuang
Detector	Peak	Test Voltage:	3Vdc

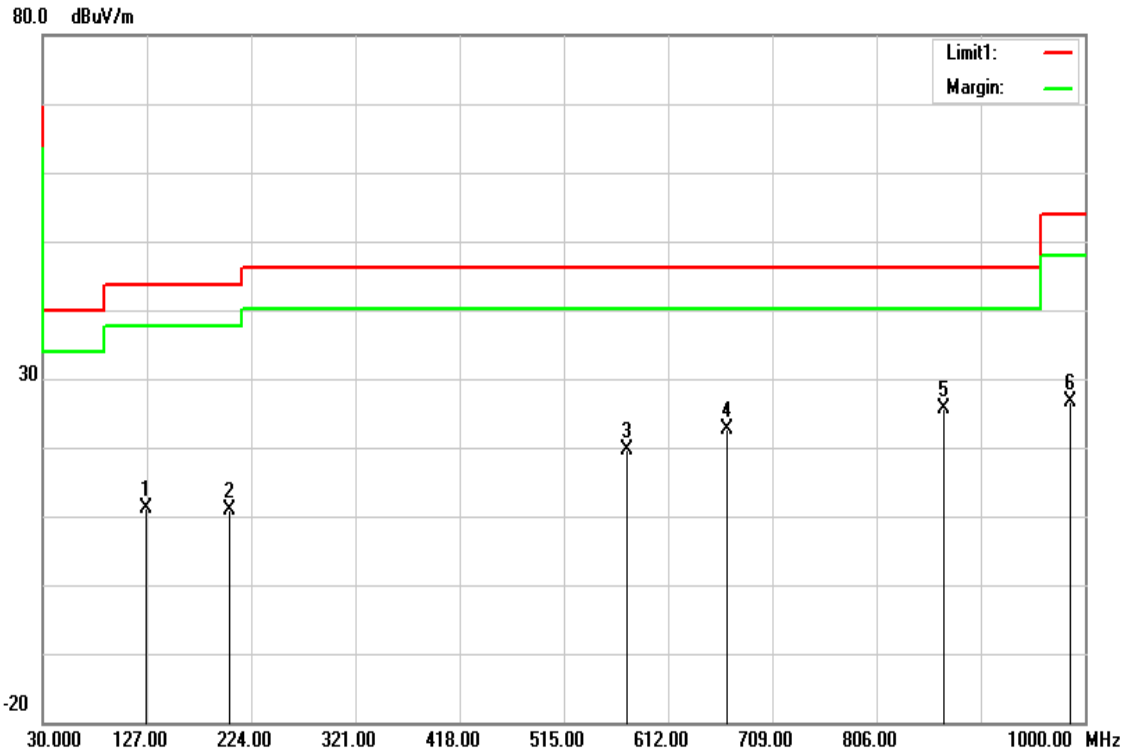

Frequency (MHz)	Reading (dBuV)	Correction Factor (dB/m)	Result (dBuV/m)	Limit (dBuV/m)	Margin (dB)	Remark
126.0300	26.29	-15.16	11.13	43.52	-32.39	peak
203.6300	26.49	-15.67	10.82	43.52	-32.70	peak
573.2000	26.89	-7.26	19.63	46.02	-26.39	peak
667.2900	28.05	-5.32	22.73	46.02	-23.29	peak
868.0800	28.21	-2.55	25.66	46.02	-20.36	peak
986.4200	27.44	-0.80	26.64	54.00	-27.36	peak

Test Mode:	TX-433.92MHz	Temp/Hum	24(°C)/ 33%RH
Test Item	Below 1GHz	Test Date	2018/01/10
Polarize	Horizontal	Test Engineer	Jerry Chuang
Detector	Peak	Test Voltage:	3Vdc

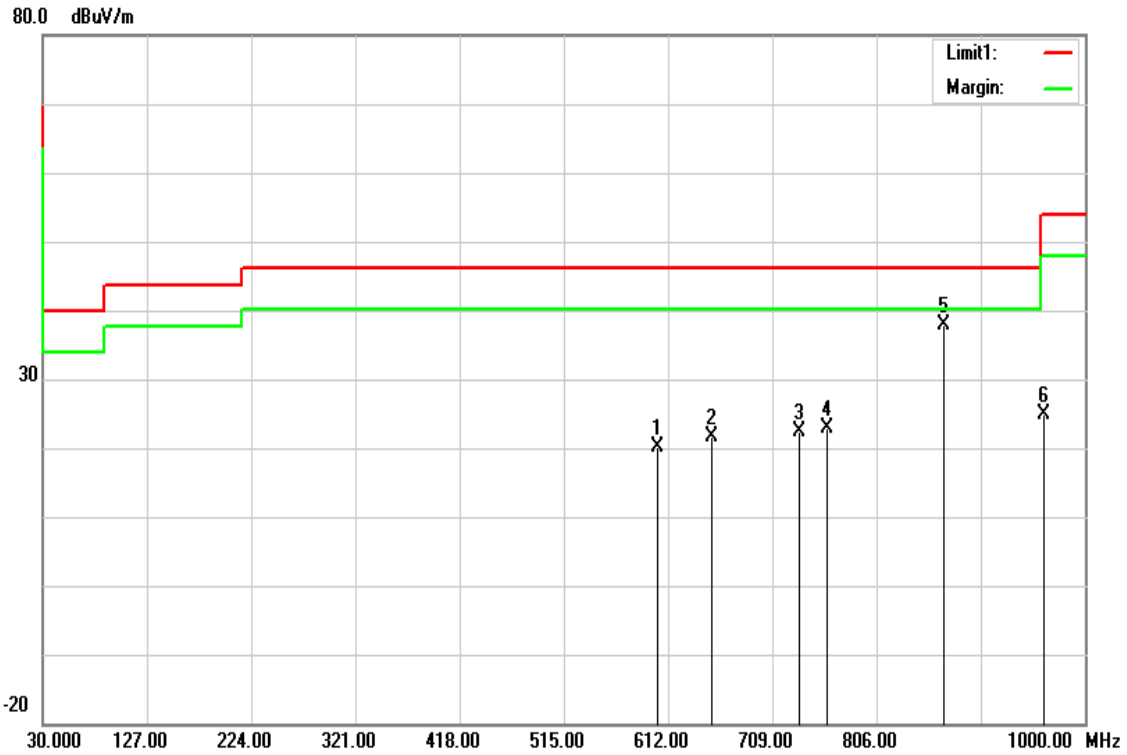

Frequency (MHz)	Reading (dBuV)	Correction Factor (dB/m)	Result (dBuV/m)	Limit (dBuV/m)	Margin (dB)	Remark
602.3000	27.00	-6.87	20.13	46.02	-25.89	peak
652.7400	27.17	-5.51	21.66	46.02	-24.36	peak
734.2200	26.93	-4.48	22.45	46.02	-23.57	peak
760.4100	26.87	-4.11	22.76	46.02	-23.26	peak
868.0800	40.32	-2.55	37.77	46.02	-8.25	peak
961.2000	25.87	-1.07	24.80	54.00	-29.20	peak

**Below 1GHz**

Test Mode:	TX-434.42MHz	Temp/Hum	24(°C)/ 33%RH
Test Item	Below 1GHz	Test Date	2018/01/10
Polarize	Vertical	Test Engineer	Jerry Chuang
Detector	Peak	Test Voltage:	3Vdc

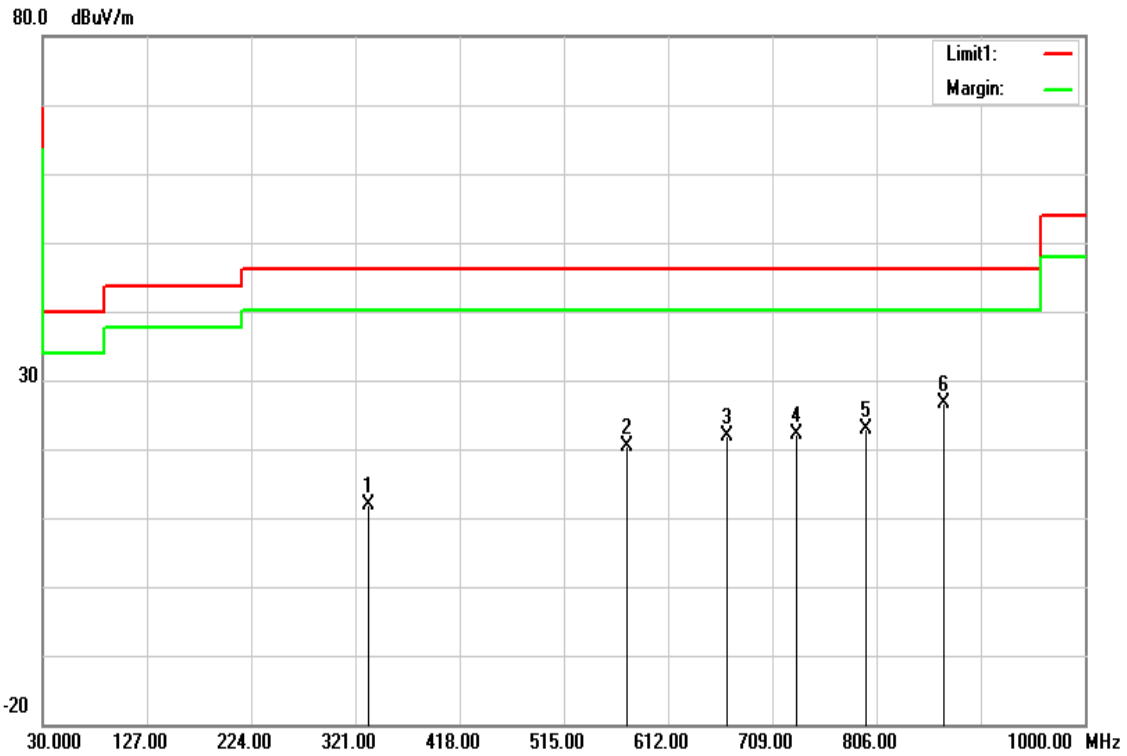

Frequency (MHz)	Reading (dBuV)	Correction Factor (dB/m)	Result (dBuV/m)	Limit (dBuV/m)	Margin (dB)	Remark
332.6400	25.36	-13.36	12.00	46.02	-34.02	peak
573.2000	27.56	-7.26	20.30	46.02	-25.72	peak
667.2900	27.27	-5.32	21.95	46.02	-24.07	peak
731.3100	26.62	-4.51	22.11	46.02	-23.91	peak
796.3000	26.23	-3.44	22.79	46.02	-23.23	peak
869.0500	29.10	-2.53	26.57	46.02	-19.45	peak

Test Mode:	TX	Temp/Hum	24(°C)/ 33%RH
Test Item	Below 1GHz	Test Date	2018/01/10
Polarize	Horizontal	Test Engineer	Jerry Chuang
Detector	Peak	Test Voltage:	3Vdc

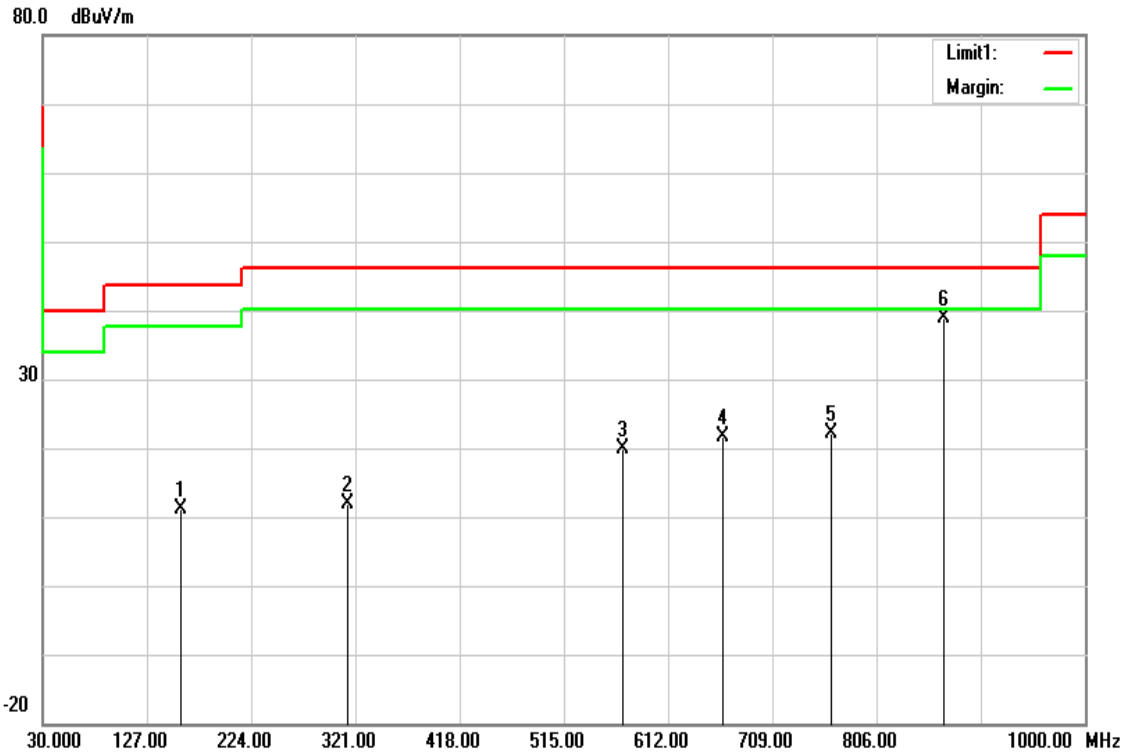

Frequency (MHz)	Reading (dBuV)	Correction Factor (dB/m)	Result (dBuV/m)	Limit (dBuV/m)	Margin (dB)	Remark
158.0400	26.95	-15.91	11.04	43.52	-32.48	peak
314.2100	25.74	-13.75	11.99	46.02	-34.03	peak
570.2900	27.07	-7.30	19.77	46.02	-26.25	peak
663.4100	26.95	-5.37	21.58	46.02	-24.44	peak
763.3200	26.18	-4.05	22.13	46.02	-23.89	peak
869.0500	41.40	-2.53	38.87	46.02	-7.15	peak

**Above 1GHz**

Test Mode:	TX-433.92MHz	Temp/Hum	24(°C)/ 33%RH
Test Item	Above 1GHz	Test Date	2018/01/10
Polarize	Vertical	Test Engineer	Jerry Chuang
Detector	Peak	Test Voltage:	3Vdc

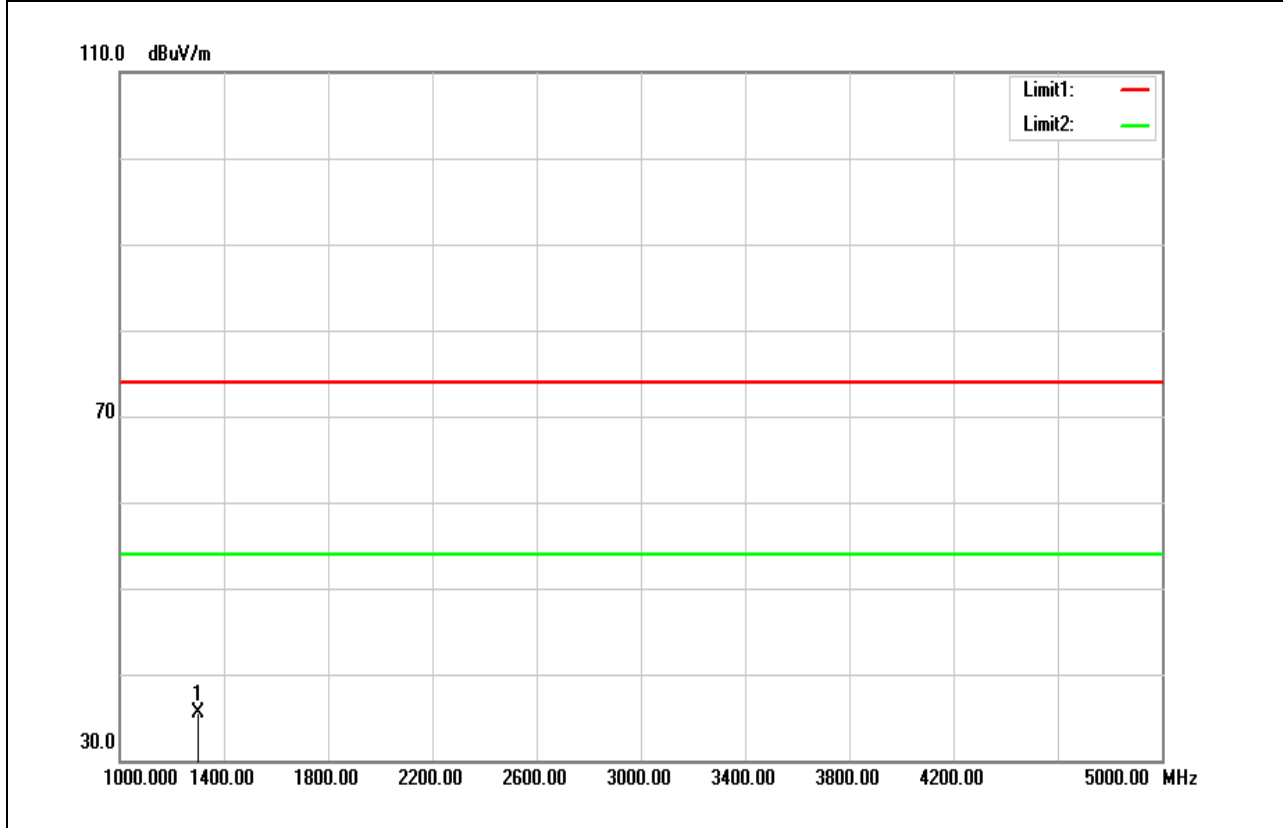

Frequency (MHz)	Reading (dBuV)	Correction Factor (dB/m)	Result (dBuV/m)	Limit (dBuV/m)	Margin (dB)	Remark
1300.000	44.13	-8.66	35.47	74.00	-38.53	peak
N/A						

**Remark:**

1. Measuring frequencies from 1 GHz to the 10th harmonic of highest fundamental frequency.

Test Mode:	TX-433.92MHz	Temp/Hum	24(°C)/ 33%RH
Test Item	Above 1GHz	Test Date	2018/01/10
Polarize	Horizontal	Test Engineer	Jerry Chuang
Detector	Peak	Test Voltage:	3Vdc

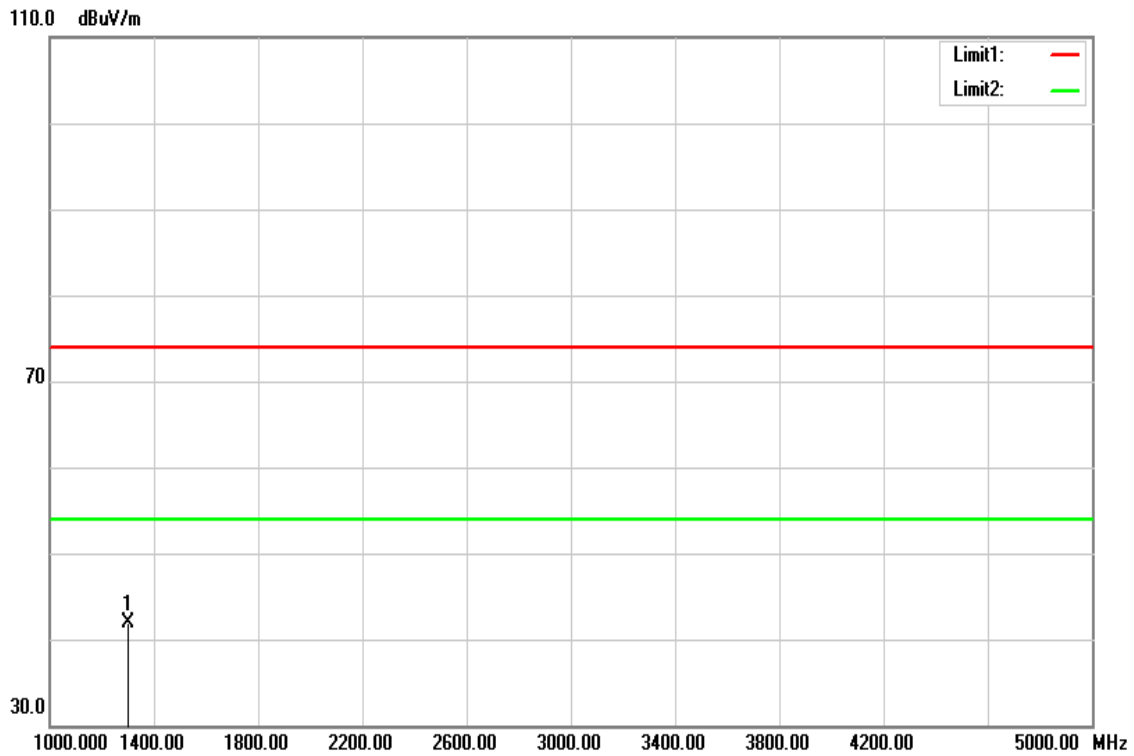

Frequency (MHz)	Reading (dBuV)	Correction Factor (dB/m)	Result (dBuV/m)	Limit (dBuV/m)	Margin (dB)	Remark
1300.000	50.57	-8.66	41.91	74.00	-32.09	peak
N/A						

**Remark:**

1. Measuring frequencies from 1 GHz to the 10th harmonic of highest fundamental frequency.

**Above 1GHz**

Test Mode:	TX-434.42MHz	Temp/Hum	24(°C)/ 33%RH
Test Item	Above 1GHz	Test Date	2018/01/10
Polarize	Vertical	Test Engineer	Jerry Chuang
Detector	Peak	Test Voltage:	3Vdc

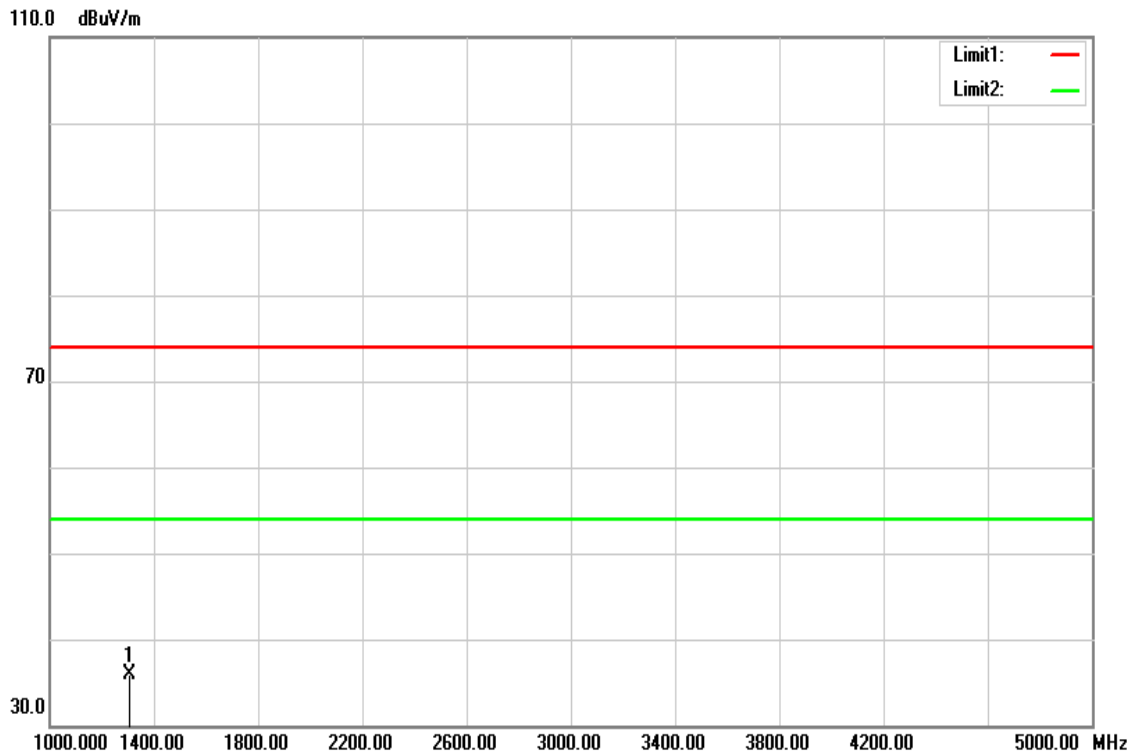

Frequency (MHz)	Reading (dBuV)	Correction Factor (dB/m)	Result (dBuV/m)	Limit (dBuV/m)	Margin (dB)	Remark
1304.000	44.59	-8.65	35.94	74.00	-38.06	peak
N/A						

**Remark:**

1. Measuring frequencies from 1 GHz to the 10th harmonic of highest fundamental frequency.

Test Mode:	TX-434.42MHz	Temp/Hum	24(°C)/ 33%RH
Test Item	Above 1GHz	Test Date	2018/01/10
Polarize	Horizontal	Test Engineer	Jerry Chuang
Detector	Peak	Test Voltage:	3Vdc

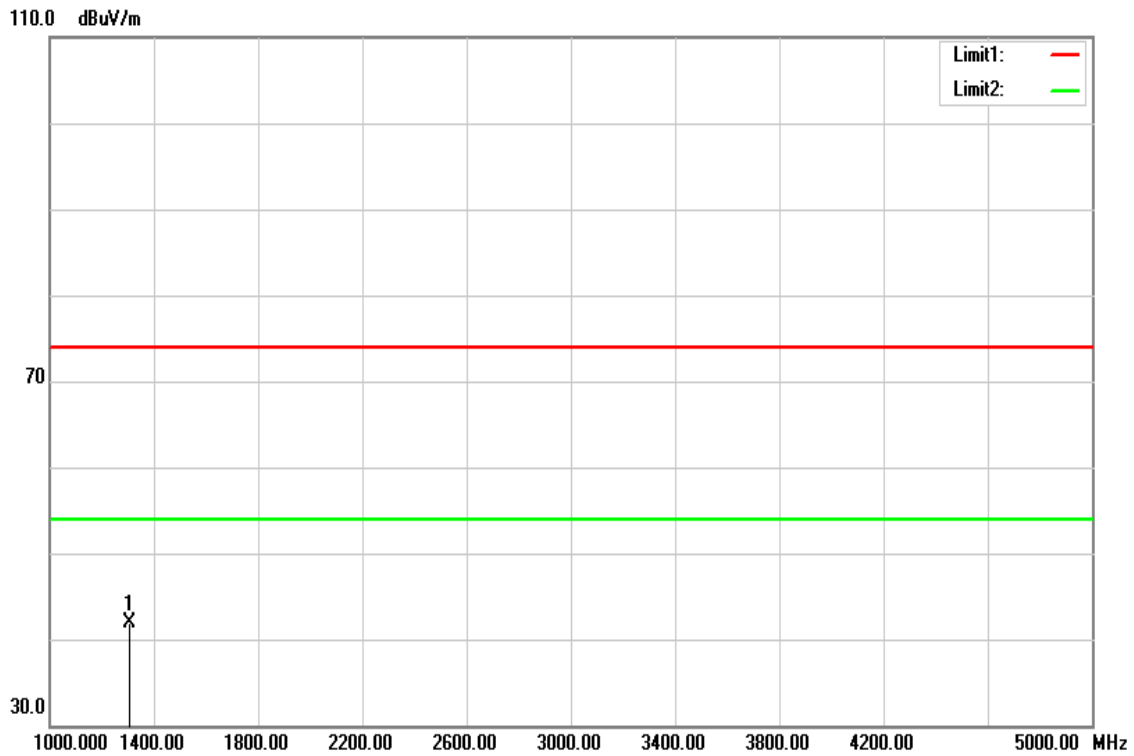

Frequency (MHz)	Reading (dBuV)	Correction Factor (dB/m)	Result (dBuV/m)	Limit (dBuV/m)	Margin (dB)	Remark
1304.000	50.63	-8.65	41.98	74.00	-32.02	peak
N/A						

**Remark:**

1. Measuring frequencies from 1 GHz to the 10th harmonic of highest fundamental frequency.



## 4.5 OPERATION RESTRICTION

### 4.5.1 Test Limit

15.231(a)(1), A manually operated transmitter shall employ a switch that will automatically deactivate the transmitter within not more than 5 seconds of being released.

### 4.5.2 Test Procedure

Test method Refer as ANSI 63.10:2013 clause 7.4

The Loop antenna connected to the spectrum analyzer, was touching to the transmitter antenna. Set the RBW=1MHz, VBW ≥ 3 x RBW, Detector = Peak, Trace mode = Max hold, Sweep = 200s.Measure

### 4.5.3 Test Setup

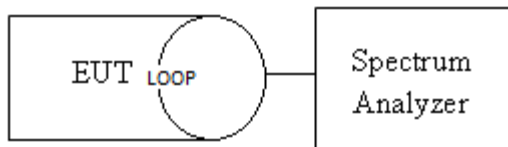

### 4.5.4 Test Result

Dwell Time (433.92MHz)		
Operation condition	Burst Duration	Limits
Automatically Operated	231.9 ms	5 sec

Dwell Time (434.42MHz)		
Operation condition	Burst Duration	Limits
Automatically Operated	289.9 ms	5 sec

**Test Data**

