



FCC ID: KR5-DHSHMCNFCRG3
Report No.: T190909W01-RP

Page: 1 / 37
Rev.: 01

FCC 47 CFR PART 15 SUBPART C

TEST REPORT

For

NFC Door Handle Sensor

Model No.:
DHS HMC NFC RG3

Trade Name: Continental

Issued to

Continental Automotive GmbH
Siemensstrasse 12 SV C TS RBG EMC-Laboratory
Regensburg, 93055 Germany

Issued by

Compliance Certification Services Inc.
Wugu Laboratory
No.11, Wugong 6th Rd., Wugu Dist.,
New Taipei City 24891, Taiwan. (R.O.C.)
Issued Date: October 07, 2019

Unless otherwise stated the results shown in this test report refer only to the sample(s) tested and such sample(s) are retained for 90 days only.
除非另有說明，此報告結果僅對測試之樣品負責，同時此樣品僅保留90天。本報告未經本公司書面許可，不可部分複製。

This document is issued by the Company subject to its General Conditions of Service printed overleaf, available on request or accessible at www.sgs.com/terms_and_conditions.htm and for electronic format documents, subject to Terms and Conditions for Electronic Documents at www.sgs.com/terms_e-document.htm. Attention is drawn to the limitation of liability, indemnification and jurisdiction issues defined therein. Any holder of this document is advised that information contained hereon reflects the Company's findings at the time of its intervention only and within the limits of Client's instructions, if any. The Company's sole responsibility is to its Client and this document does not exonerate parties to a transaction from exercising all their rights and obligations under the transaction documents. This document cannot be reproduced except in full, without prior written approval of the Company. Any unauthorized alteration, forgery or falsification of the content or appearance of this document is unlawful and offenders may be prosecuted to the fullest extent of the law.

Revision History

| Rev. | Issue Date | Revisions | Effect Page | Revised By |
|------|------------------|----------------------------------|-------------|------------|
| 00 | October 03, 2019 | Initial Issue | ALL | May Lin |
| 01 | October 07, 2019 | See the following Note Rev. (01) | P.5 | May Lin |

Rev (01):

1. Added the remark.

TABLE OF CONTENTS

| | |
|---|------------|
| 1. TEST RESULT CERTIFICATION | 4 |
| 2. EUT DESCRIPTION | 5 |
| 3. TEST METHODOLOGY | 6 |
| 3.1 EUT CONFIGURATION..... | 6 |
| 3.2 FCC PART 15.205 RESTRICTED BANDS OF OPERATIONS..... | 6 |
| 3.3 DESCRIPTION OF TEST MODES..... | 7 |
| 4. TEST SUMMARY | 8 |
| 5. INSTRUMENT CALIBRATION | 9 |
| 5.1 MEASURING INSTRUMENT CALIBRATION..... | 9 |
| 5.2 MEASUREMENT EQUIPMENT USED..... | 9 |
| 5.3 MEASUREMENT UNCERTAINTY..... | 10 |
| 6. FACILITIES AND ACCREDITATIONS | 11 |
| 6.1 FACILITIES..... | 11 |
| 6.2 EQUIPMENT..... | 11 |
| 7. SETUP OF EQUIPMENT UNDER TEST | 12 |
| 7.1 SETUP CONFIGURATION OF EUT..... | 12 |
| 7.2 SUPPORT EQUIPMENT..... | 12 |
| 8. FCC PART 15.225 REQUIREMENTS | 13 |
| 8.1 OCCUPIED BANDWIDTH (99%) AND 20 DB BANDWIDTH..... | 13 |
| 8.2 RADIATED EMISSIONS..... | 15 |
| 8.3 FREQUENCY STABILITY..... | 34 |
| 8.4 POWERLINE CONDUCTED EMISSIONS..... | 36 |
| APPENDIX A PHOTOGRAPHS OF TEST SETUP | A-1 |
| APPENDIX 1 - PHOTOGRAPHS OF EUT | |

Report No.: T190909W01-RP

1. TEST RESULT CERTIFICATION

Applicant: Continental Automotive GmbH
Siemensstrasse 12 SV C TS RBG EMC-Laboratory
Regensburg, 93055 Germany

Manufacturer: Continental Automotive GmbH
Siemensstrasse 12 SV C TS RBG EMC-Laboratory
Regensburg, 93055 Germany

Factory: Continental Automotive Electronics LLC
74-7, Geumhoseonmal-gil, Bugang-myeon, Sejong-si, 339-942,
Korea

Equipment Under Test: NFC Door Handle Sensor

Trade Name: Continental

Model No.: DHS HMC NFC RG3

Date of Test: September 16 ~ 17, 2019

| APPLICABLE STANDARDS | |
|---|-------------------------|
| STANDARD | TEST RESULT |
| FCC 47 CFR Part 15 Subpart C | No non-compliance noted |
| Statements of Conformity | |
| Determination of compliance is based on the results of the compliance measurement, not taking into account measurement instrumentation uncertainty. | |

We hereby certify that:

The above equipment was tested by Compliance Certification Services Inc. The test data, data evaluation, test procedures, and equipment configurations shown in this report were made in accordance with the procedures given in ANSI C63.10: 2013 and the energy emitted by the sample tested as described in this report is in compliance with the requirements of FCC Rules Part 15.225.

The test results of this report relate only to the tested sample identified in this report.

Approved by:

Tested by:

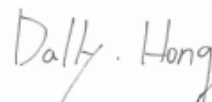
Kevin Tsai
Deputy Manager
Compliance Certification Services Inc.

Dally Hong
Engineer
Compliance Certification Services Inc.

2. EUT DESCRIPTION

| | |
|-----------------------------|--|
| Product | NFC Door Handle Sensor |
| Model No. | DHS HMC NFC RG3 |
| Model Discrepancy | N/A |
| Trade | Continental |
| Received Date | September 09, 2019 |
| Power Supply | Power from power supply. (DC12V) |
| Frequency Range | 13.56MHz |
| Modulation Technique | ASK |
| Number of Channels | 1 Channel |
| Antenna Requirement | Antenna type: Flex NFC antenna Antenna gain (max): 0dBi |

Remark:

- 1. The sample selected for test was engineering sample that approximated to production product and was provided by manufacturer.*
- 2. Left and right door handle is the same that we performed all the testing, the worst case was the right door handel of radiated emissions.*

Report No.: T190909W01-RP

3. TEST METHODOLOGY

The tests documented in this report were performed in accordance with ANSI C63.10: 2013 and FCC CFR 47 Part 15.207, 15.209, 15.225.

3.1 EUT CONFIGURATION

The EUT configuration for testing is installed on RF field strength measurement to meet the Commissions requirement and operating in a manner that intends to maximize its emission characteristics in a continuous normal application.

3.2 FCC PART 15.205 RESTRICTED BANDS OF OPERATIONS

(a) Except as shown in paragraph (d) of this section, only spurious emissions are permitted in any of the frequency bands listed below:

| MHz | MHz | MHz | GHz |
|----------------------------|---------------------|-----------------|------------------|
| 0.090 - 0.110 | 16.42 - 16.423 | 399.9 - 410 | 4.5 - 5.15 |
| ¹ 0.495 - 0.505 | 16.69475 - 16.69525 | 608 - 614 | 5.35 - 5.46 |
| 2.1735 - 2.1905 | 16.80425 - 16.80475 | 960 - 1240 | 7.25 - 7.75 |
| 4.125 - 4.128 | 25.5 - 25.67 | 1300 - 1427 | 8.025 - 8.5 |
| 4.17725 - 4.17775 | 37.5 - 38.25 | 1435 - 1626.5 | 9.0 - 9.2 |
| 4.20725 - 4.20775 | 73 - 74.6 | 1645.5 - 1646.5 | 9.3 - 9.5 |
| 6.215 - 6.218 | 74.8 - 75.2 | 1660 - 1710 | 10.6 - 12.7 |
| 6.26775 - 6.26825 | 108 - 121.94 | 1718.8 - 1722.2 | 13.25 - 13.4 |
| 6.31175 - 6.31225 | 123 - 138 | 2200 - 2300 | 14.47 - 14.5 |
| 8.291 - 8.294 | 149.9 - 150.05 | 2310 - 2390 | 15.35 - 16.2 |
| 8.362 - 8.366 | 156.52475 - | 2483.5 - 2500 | 17.7 - 21.4 |
| 8.37625 - 8.38675 | 156.52525 | 2655 - 2900 | 22.01 - 23.12 |
| 8.41425 - 8.41475 | 156.7 - 156.9 | 3260 - 3267 | 23.6 - 24.0 |
| 12.29 - 12.293 | 162.0125 - 167.17 | 3332 - 3339 | 31.2 - 31.8 |
| 12.51975 - 12.52025 | 167.72 - 173.2 | 3345.8 - 3358 | 36.43 - 36.5 |
| 12.57675 - 12.57725 | 240 - 285 | 3600 - 4400 | (²) |
| 13.36 - 13.41 | 322 - 335.4 | | |

¹ Until February 1, 1999, this restricted band shall be 0.490-0.510 MHz.

² Above 38.6

(b) Except as provided in paragraphs (d) and (e), the field strength of emissions appearing within these frequency bands shall not exceed the limits shown in Section 15.209. At frequencies equal to or less than 1000 MHz, compliance with the limits in Section 15.209 shall be demonstrated using measurement instrumentation employing a CISPR quasi-peak detector. Above 1000 MHz, compliance with the emission limits in Section 15.209 shall be demonstrated based on the average value of the measured emissions. The provisions in Section 15.35 apply to these measurements.

Report No.: T190909W01-RP

3.3 DESCRIPTION OF TEST MODES

The EUT had been tested under engineering test mode condition and the EUT staying in continuous transmitting mode.

All modes and data rates were investigated and it was determined that ISO 14443A/B and ISO 18092 Type y, 106/212/424/848 kbps.

All data rates were investigated and it was determined that 106 Kbps was considered worst-case. Therefore, all testing was performed in 106 Kbps mode.

3.4.1 The worst mode of measurement

| Radiated Emission Measurement Above 1G | |
|--|---|
| Test Condition | Band edge, Emission for Unwanted and Fundamental |
| Power supply Mode | Mode 1: EUT power by Power supply (DC 12V) |
| Worst Mode | <input checked="" type="checkbox"/> Mode 1 <input type="checkbox"/> Mode 2 <input type="checkbox"/> Mode 3 <input type="checkbox"/> Mode 4 |
| Worst Position | <input type="checkbox"/> Placed in fixed position. <input type="checkbox"/> Placed in fixed position at X-Plane (E2-Plane) <input checked="" type="checkbox"/> Placed in fixed position at Y-Plane (E1-Plane) <input type="checkbox"/> Placed in fixed position at Z-Plane (H-Plane) |
| Worst Polarity | <input checked="" type="checkbox"/> Horizontal <input type="checkbox"/> Vertical |

| Radiated Emission Measurement Below 1G | |
|--|--|
| Test Condition | Radiated Emission Below 1G |
| Power supply Mode | Mode 1: EUT power by Power supply (DC 12V) |
| Worst Mode | <input checked="" type="checkbox"/> Mode 1 <input type="checkbox"/> Mode 2 <input type="checkbox"/> Mode 3 <input type="checkbox"/> Mode 4 |

Remark:

1. The worst mode was record in this test report.
2. EUT pre-scanned in three axis, X, Y, Z for radiated measurement. The worst case (Y-Plane) were recorded in this report

4. TEST SUMMARY

| FCC Standard Sec. | Chapter | Test Item | Result |
|-------------------|---------|---|--------|
| 15.203 | 2 | Antenna Requirement | Pass |
| 15.215 | 8.1 | Occupied Bandwidth (99%) and 20dB Bandwidth | Pass |
| 15.209 | 8.2 | Radiated Emissions | Pass |
| 15.225 | 8.3 | Frequency Stability | Pass |
| 15.207 | 8.4 | AC Power-line Conducted Emission | N/A |

Report No.: T190909W01-RP

5. INSTRUMENT CALIBRATION

5.1 MEASURING INSTRUMENT CALIBRATION

The measuring equipment, which was utilized in performing the tests documented herein, has been calibrated in accordance with the manufacturer's recommendations for utilizing calibration equipment, which is traceable to recognized national standards.

5.2 MEASUREMENT EQUIPMENT USED

Equipment Used for Emissions Measurement

| Conducted Emissions Test Site | | | | | |
|-----------------------------------|--------------|--------------|------------|------------------|-----------------|
| Name of Equipment | Manufacturer | Model | S/N | Calibration Date | Calibration Due |
| EXA Signal Analyzer | KEYSIGHT | N9010B | MY55460167 | 07/31/2019 | 07/30/2020 |
| Thermostatic/ Humidity Chamber | GWINSTEK | GTC-288MH-CC | TH160402 | 05/16/2019 | 05/15/2020 |
| Software | N/A | | | | |

| Wugu 966 Chamber A | | | | | |
|---------------------------------|------------------|--------------------|------------|------------------|-----------------|
| Name of Equipment | Manufacturer | Model | S/N | Calibration Date | Calibration Due |
| Bilog Antenna | Sunol Sciences | JB3 | A030105 | 07/26/2019 | 07/25/2020 |
| Cable | HUBER SUHNER | SUCOFLEX 104PEA | 20995 | 02/26/2019 | 02/25/2020 |
| Digital Thermo- Hygro Meter | WISEWIND | 1206 | D07 | 01/30/2019 | 01/29/2020 |
| Loop Ant | COM-POWER | AL-130 | 121051 | 03/22/2019 | 03/21/2020 |
| Pre-Amplifier | EMEC | EM330 | 060609 | 02/26/2019 | 02/25/2020 |
| PSA Series Spectrum Analyzer | Agilent | E4446A | MY46180323 | 05/29/2019 | 05/28/2020 |
| Antenna Tower | CCS | CC-A-1F | N/A | N.C.R | N.C.R |
| Controller | CCS | CC-C-1F | N/A | N.C.R | N.C.R |
| Turn Table | CCS | CC-T-1F | N/A | N.C.R | N.C.R |
| Software | e3 6.11-20180413 | | | | |

| AC Conducted Emissions Test Site | | | | | |
|----------------------------------|--------------|-------|-----|----------|---------|
| Equipment | Manufacturer | Model | S/N | Cal Date | Cal Due |
| N/A | | | | | |

Remark: Each piece of equipment is scheduled for calibration once a year

5.3 MEASUREMENT UNCERTAINTY

| PARAMETER | UNCERTAINTY |
|---------------------------------------|-------------|
| Powerline Conducted Emission | +/- 2.96 |
| 3M Semi Anechoic Chamber / 30M~200M | +/- 4.0138 |
| 3M Semi Anechoic Chamber / 200M~1000M | +/- 3.9483 |
| 3M Semi Anechoic Chamber / 1G~8G | +/- 2.5975 |
| 3M Semi Anechoic Chamber / 8G~18G | +/- 2.6112 |
| 3M Semi Anechoic Chamber / 18G~26G | +/- 2.7389 |
| 3M Semi Anechoic Chamber / 26G~40G | +/- 2.9683 |

Remark: This uncertainty represents an expanded uncertainty expressed at approximately the 95% confidence level using a coverage factor of $k=2$.

Report No.: T190909W01-RP

6. FACILITIES AND ACCREDITATIONS

6.1 FACILITIES

All measurement facilities used to collect the measurement data are located at

- No.199, Chunghsen Road, Hsintien City, Taipei Hsien, Taiwan, R.O.C.
Tel: 886-2-2217-0894 / Fax: 886-2-2217-1029
- No.11, Wugong 6th Rd., Wugu Dist., New Taipei City 24891, Taiwan. (R.O.C.)
Tel: 886-2-2299-9720 / Fax: 886-2-2298-4045

The sites are constructed in conformance with the requirements of ANSI C63.7, ANSI C63.10: 2013 and CISPR Publication 22.

6.2 EQUIPMENT

Radiated emissions are measured with one or more of the following types of linearly polarized antennas: tuned dipole, bucolical, log periodic, bi-log, and/or ridged waveguide, horn. Spectrum analyzers with pre-selectors and quasi-peak detectors are used to perform radiated measurements.

Conducted emissions are measured with Line Impedance Stabilization Networks and EMI Test Receivers.

Calibrated wideband preamplifiers, coaxial cables, and coaxial attenuators are also used for making measurements.

All receiving equipment conforms to CISPR Publication 16-1, "Radio Interference Measuring Apparatus and Measurement Methods."

7. SETUP OF EQUIPMENT UNDER TEST

7.1 SETUP CONFIGURATION OF EUT

See test photographs attached in Appendix A for the actual connections between EUT and support equipment.

7.2 SUPPORT EQUIPMENT

| No. | Device Type | Brand | Model | Series No. | FCC ID | Cable length & Type Describe |
|-----|-------------|-------|-------|------------|--------|------------------------------|
| | N/A | | | | | |

Remark:

- 1. All the equipment/cables were placed in the worst-case configuration to maximize the emission during the test.*
- 2. Grounding was established in accordance with the manufacturer's requirements and conditions for the intended use.*

Report No.: T190909W01-RP

8. FCC PART 15.225 REQUIREMENTS

8.1 OCCUPIED BANDWIDTH (99%) AND 20 dB BANDWIDTH

TEST CONFIGURATION

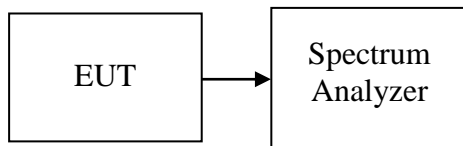

TEST PROCEDURE

1. Place the EUT on the table and set it in the transmitting mode.
2. Remove the antenna from the EUT and then connect a low loss RF cable from the antenna port to the spectrum analyzer.
3. Set the spectrum analyzer as RBW=1kHz, VBW = 3kHz, Span = 10kHz, Sweep = auto.
4. Record the max. reading.

TEST RESULTS

No non-compliance noted

| Test Condition | Frequency(MHz) | Occupied Bandwidth 99% (kHz) | 20 dB Bandwidth (kHz) |
|----------------|----------------|------------------------------|-----------------------|
| NFC | 13.56 | 2.413 | 2.820 |

Report No.: T190909W01-RP

Test Plot

20dB Bandwidth



99% Bandwidth

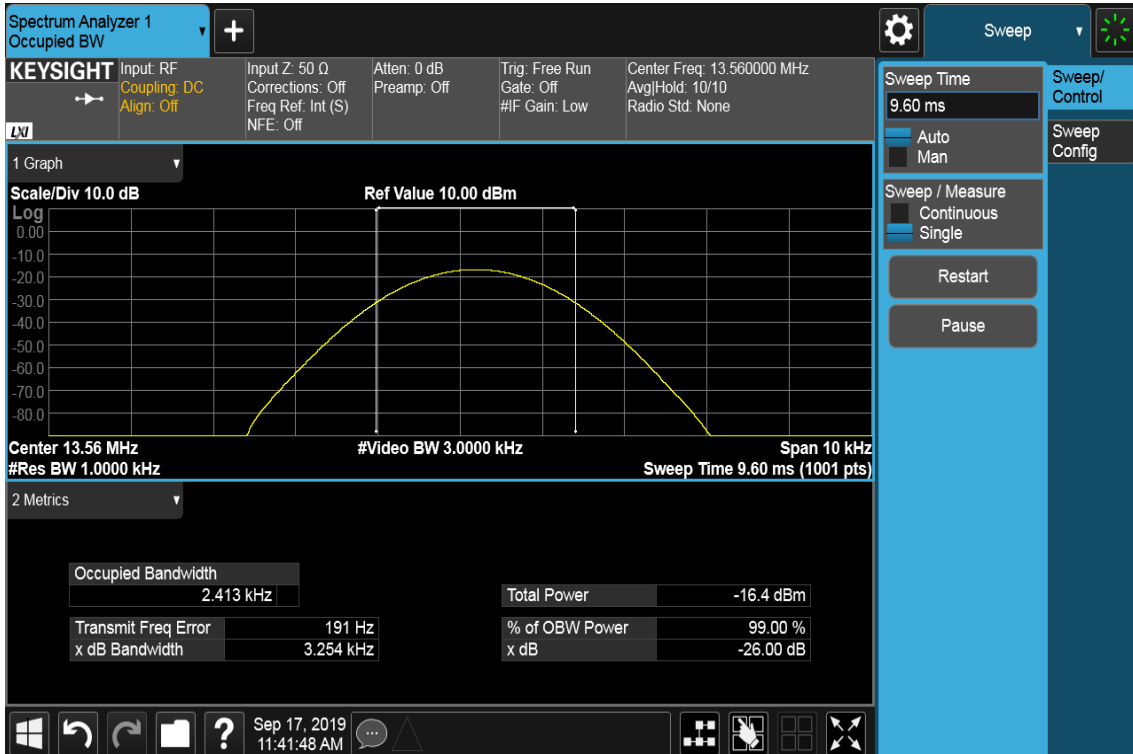

Report No.: T190909W01-RP

8.2 RADIATED EMISSIONS

LIMIT

According to §15.225

- (a) The field strength of any emissions within the band 13.553 – 13.567 MHz shall not exceed 15,848 microvolts / meter at 30 meters.
- (b) Within the bands 13.410 – 13.553 MHz and 13.567 -13.710 MHz, the field strength of any emissions shall not exceed 334 microvolts / meter at 30 meters.
- (c) Within the bands 13.110 – 13.410 MHz and 13.710 – 14.010 MHz the field strength of any emissions shall not exceed 106 microvolts / meter at 30 meters.
- (d) The field strength of any emissions appearing outside of the 13.110 – 14.010 MHz and shall not exceed the general radiated emission limits in §15.209.

According to §15.225, except as provided elsewhere in this Subpart, the emissions from an intentional radiator shall not exceed the field strength levels specified in the following table:

| Frequency (MHz) | Field Strength (µV/m at meter) | Measurement Distance (meter) |
|-----------------|--------------------------------|------------------------------|
| 0.009 – 0.490 | 2400 / F (kHz) | 300 |
| 0.490 – 1.705 | 24000 / F (kHz) | 30 |
| 1.705 – 30.0 | 30 | 30 |
| 30 - 88 | 100** | 3 |
| 88-216 | 150** | 3 |
| 216-960 | 200** | 3 |
| Above 960 | 500 | 3 |

** Except as provided in paragraph (g), fundamental emissions from intentional radiators operating under this Section shall not be located in the frequency bands 54-72 MHz, 76-88 MHz, 174-216 MHz or 470-806 MHz. However, operation within these frequency bands is permitted under other sections of this Part, e.g., Sections 15.231 and 15.241.

Report No.: T190909W01-RP

Test Configuration

9kHz ~ 30MHz

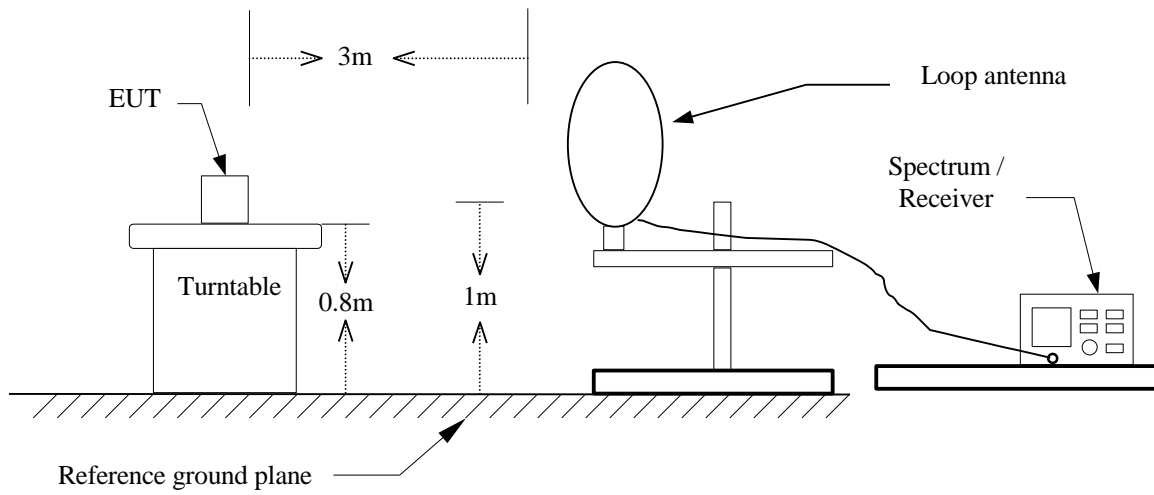

30MHz ~ 1GHz

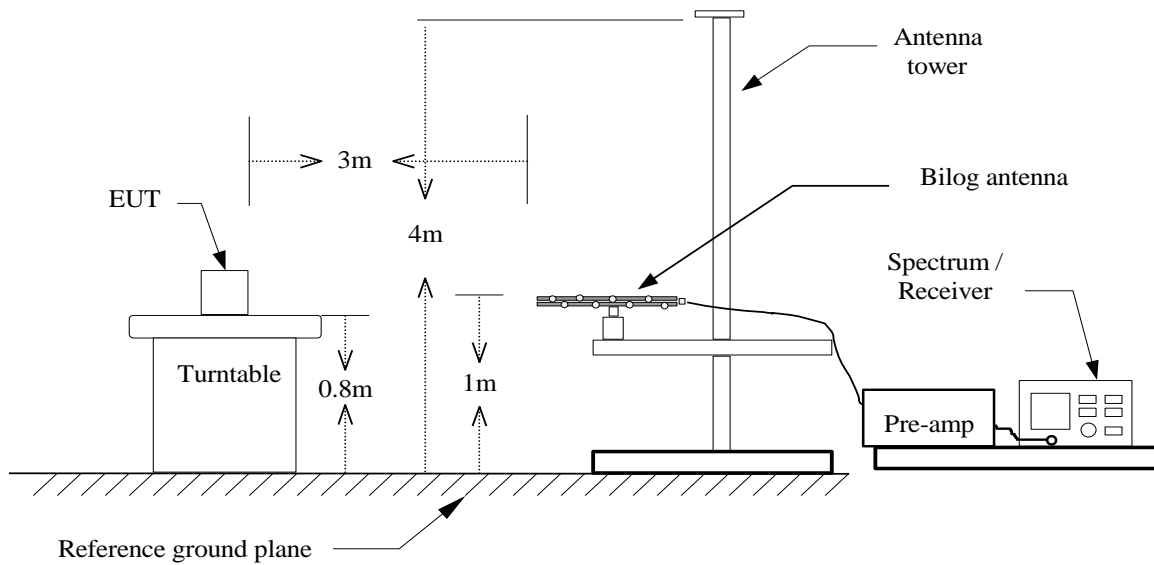

Report No.: T190909W01-RP

TEST PROCEDURE

For 9kHz ~ 30MHz

1. The EUT is placed on a turntable, which is 0.8m above ground plane.
2. The turntable shall be rotated for 360 degrees to determine the position of maximum emission level.
3. EUT is set 3m away from the receiving antenna, The center of the loop shall be 1 m above the ground then to find out the highest emissions.
4. Maximum procedure was performed on the six highest emissions to ensure EUT compliance.
5. Set the spectrum analyzer in the following setting as:
9KHz-490KHz : RBW=200Hz / VBW=1kHz / Sweep=AUTO
490KHz-30MHz : RBW=10kHz / VBW=30kHz / Sweep=AUTO
6. Repeat above procedures until the measurements for all frequencies are complete.

For 30MHz ~ 1GHz

1. The EUT is placed on a turntable, which is 0.8m above ground plane.
2. The turntable shall be rotated for 360 degrees to determine the position of maximum emission level.
3. EUT is set 3m away from the receiving antenna, which is varied from 1m to find out the highest emissions.
4. Maximum procedure was performed on the six highest emissions to ensure EUT compliance.
5. And also, each emission was to be maximized by changing the polarization of receiving antenna both horizontal and vertical.
6. Set the spectrum analyzer in the following setting as:
RBW=100kHz / VBW=300kHz / Sweep=AUTO
7. Repeat above procedures until the measurements for all frequencies are complete.

Remark :

Although these tests were performed other than open area test site, adequate comparison measurements were confirmed against 30 m open area test site. Therefore sufficient tests were made to demonstrate that the alternative site produces results that correlate with the ones of tests made in an open field based on KDB 414788.

Report No.: T190909W01-RP

For Right door handle (The worst case)

| | | | |
|------------------------|---------|-------------------|--------------------|
| Operation Mode: | TX mode | Test Date: | September 16, 2019 |
| Temperature: | 26.5°C | Tested by: | Jerry Lu |
| Humidity: | 50 % RH | Polarity: | Ver. |

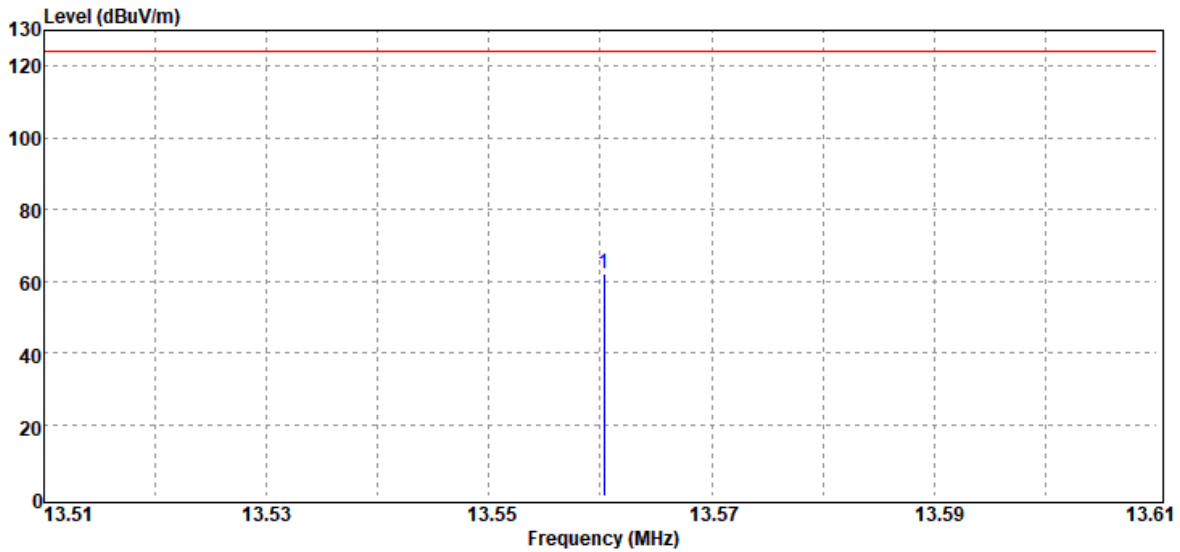

| No. | Frequency (MHz) | Reading (dBuV) | Correct Factor(dB/m) | Result (dBuV/m) | Limit (dBuV/m) | Margin (dB) | Remark |
|-----|--------------------|-------------------|-------------------------|--------------------|-------------------|----------------|--------|
| 1 | 13.56 | 46.10 | 15.91 | 62.01 | 124.00 | -61.99 | Peak |

Remark:

1. Radiated emissions measured were made with an instrument using peak/quasi-peak/average detector mode.
2. Measurements above show only up to 6 maximum emissions noted, or would be lesser, with " N/A " remark, if no specific emissions from the EUT are recorded (ie: margin>20dB from the applicable limit) and considered that's already beyond the background noise floor.
3. Margin (dB) = Result (dBuV/m) – Limit (dBuV/m).

Report No.: T190909W01-RP

| | | | |
|------------------------|---------|-------------------|--------------------|
| Operation Mode: | TX mode | Test Date: | September 16, 2019 |
| Temperature: | 26.5°C | Tested by: | Jerry Lu |
| Humidity: | 50 % RH | Polarity: | Hor. |

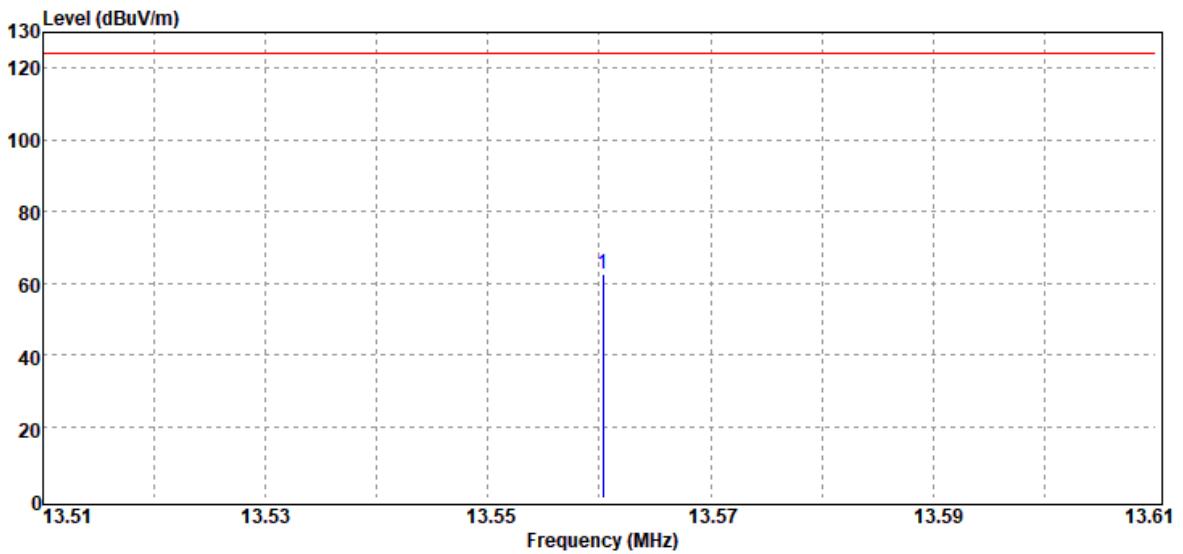

| No. | Frequency (MHz) | Reading (dBuV) | Correct Factor(dB/m) | Result (dBuV/m) | Limit (dBuV/m) | Margin (dB) | Remark |
|-----|--------------------|-------------------|-------------------------|--------------------|-------------------|----------------|--------|
| 1 | 13.56 | 46.63 | 15.91 | 62.54 | 124.00 | -61.46 | Peak |

Remark:

1. Radiated emissions measured were made with an instrument using peak/quasi-peak/average detector mode.
2. Measurements above show only up to 6 maximum emissions noted, or would be lesser, with " N/A " remark, if no specific emissions from the EUT are recorded (ie: margin>20dB from the applicable limit) and considered that's already beyond the background noise floor.
3. Margin (dB) = Result (dBuV/m) – Limit (dBuV/m).

Report No.: T190909W01-RP

Operation Mode: TX mode
Temperature: 26.5°C
Humidity: 50 % RH

Test Date: September 16, 2019
Tested by: Jerry Lu
Polarity: Ver.

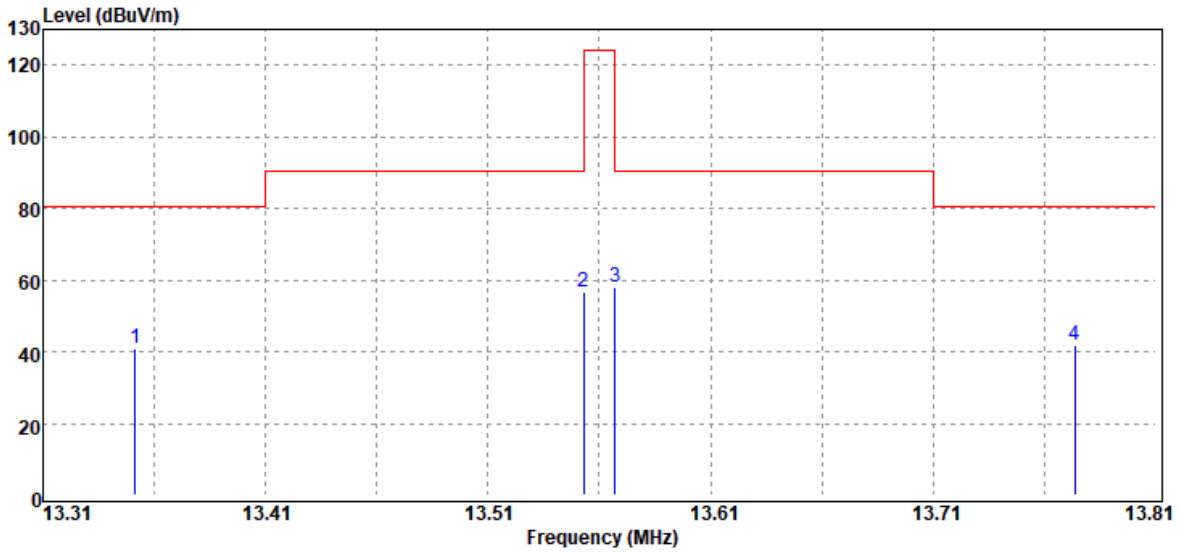

| No. | Frequency (MHz) | Reading (dBuV) | Correct Factor(dB/m) | Result (dBuV/m) | Limit (dBuV/m) | Margin (dB) | Remark |
|-----|-----------------|----------------|----------------------|-----------------|----------------|-------------|--------|
| 1 | 13.35 | 24.99 | 15.92 | 40.91 | 80.54 | -39.63 | Peak |
| 2 | 13.55 | 40.91 | 15.91 | 56.82 | 90.47 | -33.65 | Peak |
| 3 | 13.57 | 42.18 | 15.91 | 58.09 | 90.47 | -32.38 | Peak |
| 4 | 13.77 | 26.09 | 15.90 | 41.99 | 80.50 | -38.51 | Peak |

Remark:

1. Radiated emissions measured were made with an instrument using peak/quasi-peak/average detector mode.
2. Measurements above show only up to 6 maximum emissions noted, or would be lesser, with " N/A " remark, if no specific emissions from the EUT are recorded (ie: margin>20dB from the applicable limit) and considered that's already beyond the background noise floor.
3. Margin (dB) = Result (dBuV/m) – Limit (dBuV/m).

Report No.: T190909W01-RP

Operation Mode: TX mode
Temperature: 26.5°C
Humidity: 50 % RH

Test Date: September 16, 2019
Tested by: Jerry Lu
Polarity: Hor.

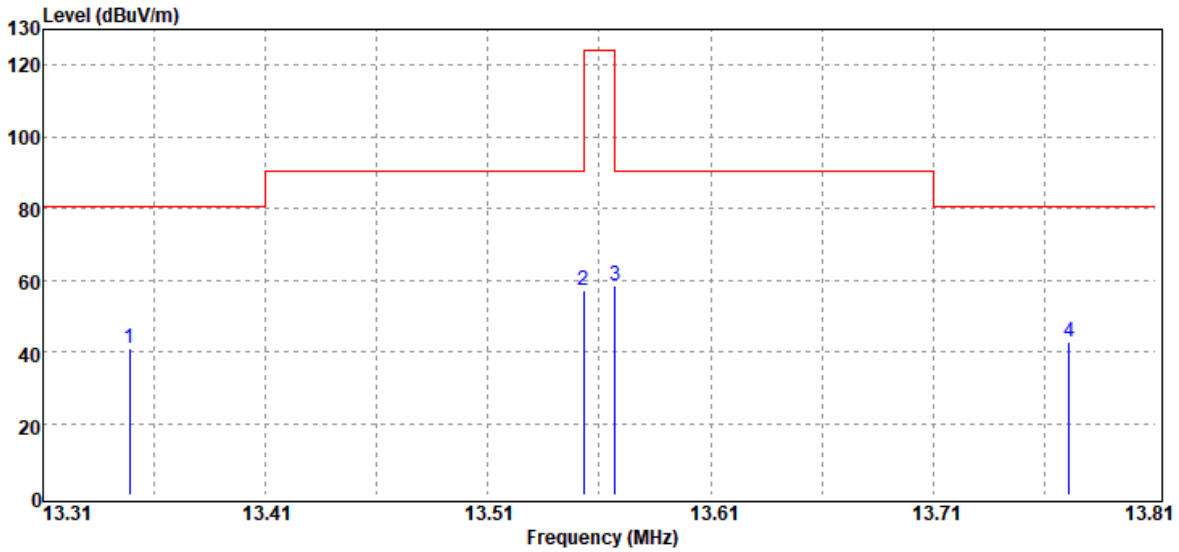

| No. | Frequency (MHz) | Reading (dBuV) | Correct Factor(dB/m) | Result (dBuV/m) | Limit (dBuV/m) | Margin (dB) | Remark |
|-----|-----------------|----------------|----------------------|-----------------|----------------|-------------|--------|
| 1 | 13.35 | 24.86 | 15.92 | 40.78 | 80.54 | -39.76 | Peak |
| 2 | 13.55 | 41.28 | 15.91 | 57.19 | 90.47 | -33.28 | Peak |
| 3 | 13.57 | 42.43 | 15.91 | 58.34 | 90.47 | -32.13 | Peak |
| 4 | 13.77 | 26.68 | 15.90 | 42.58 | 80.50 | -37.92 | Peak |

Remark:

1. Radiated emissions measured were made with an instrument using peak/quasi-peak/average detector mode.
2. Measurements above show only up to 6 maximum emissions noted, or would be lesser, with " N/A " remark, if no specific emissions from the EUT are recorded (ie: margin>20dB from the applicable limit) and considered that's already beyond the background noise floor.
3. Margin (dB) = Result (dBuV/m) – Limit (dBuV/m).

Report No.: T190909W01-RP

For Left door handle

| | | | |
|------------------------|---------|-------------------|--------------------|
| Operation Mode: | TX mode | Test Date: | September 16, 2019 |
| Temperature: | 26.5°C | Tested by: | Jerry Lu |
| Humidity: | 50 % RH | Polarity: | Ver. |

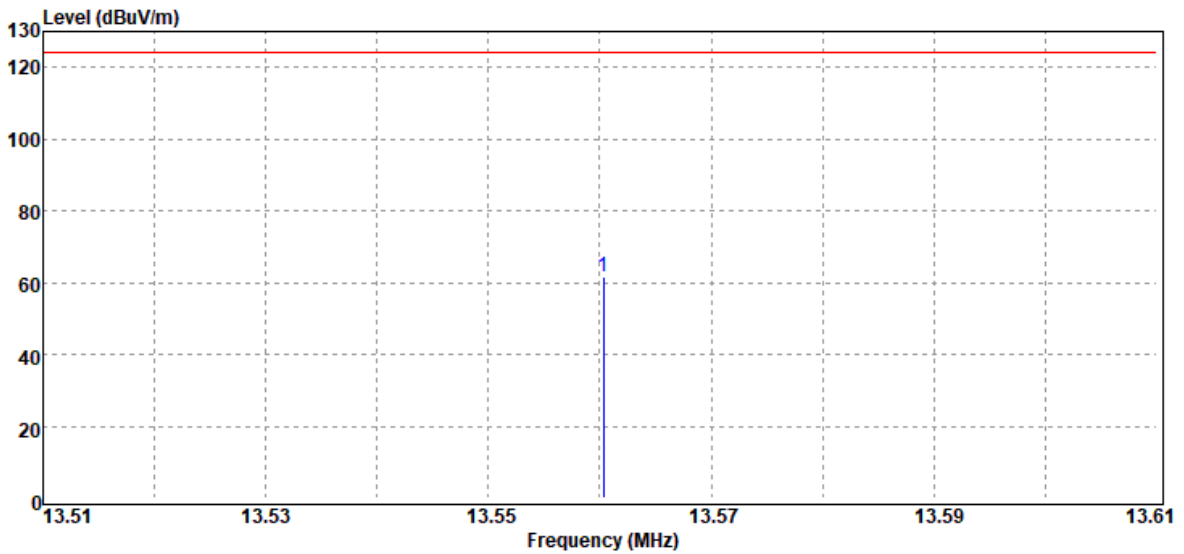

| No. | Frequency (MHz) | Reading (dBuV) | Correct Factor(dB/m) | Result (dBuV/m) | Limit (dBuV/m) | Margin (dB) | Remark |
|-----|-----------------|----------------|----------------------|-----------------|----------------|-------------|--------|
| 1 | 13.56 | 45.88 | 15.91 | 61.79 | 124.00 | -62.21 | Peak |

Remark:

1. Radiated emissions measured were made with an instrument using peak/quasi-peak/average detector mode.
2. Measurements above show only up to 6 maximum emissions noted, or would be lesser, with " N/A " remark, if no specific emissions from the EUT are recorded (ie: margin>20dB from the applicable limit) and considered that's already beyond the background noise floor.
3. Margin (dB) = Result (dBuV/m) – Limit (dBuV/m).

Report No.: T190909W01-RP

| | | | |
|------------------------|---------|-------------------|--------------------|
| Operation Mode: | TX mode | Test Date: | September 16, 2019 |
| Temperature: | 26.5°C | Tested by: | Jerry Lu |
| Humidity: | 50 % RH | Polarity: | Hor. |

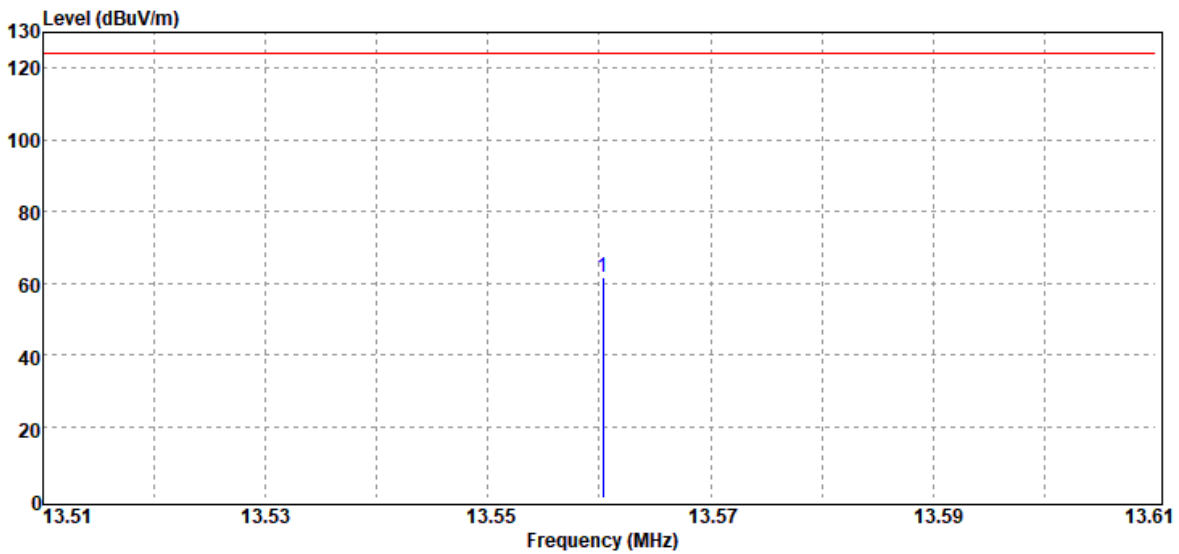

| No. | Frequency (MHz) | Reading (dBuV) | Correct Factor(dB/m) | Result (dBuV/m) | Limit (dBuV/m) | Margin (dB) | Remark |
|-----|--------------------|-------------------|-------------------------|--------------------|-------------------|----------------|--------|
| 1 | 13.56 | 45.55 | 15.91 | 61.46 | 124.00 | -62.54 | Peak |

Remark:

1. Radiated emissions measured were made with an instrument using peak/quasi-peak/average detector mode.
2. Measurements above show only up to 6 maximum emissions noted, or would be lesser, with " N/A " remark, if no specific emissions from the EUT are recorded (ie: margin>20dB from the applicable limit) and considered that's already beyond the background noise floor.
3. Margin (dB) = Result (dBuV/m) – Limit (dBuV/m).

Report No.: T190909W01-RP

| | | | |
|------------------------|---------|-------------------|--------------------|
| Operation Mode: | TX mode | Test Date: | September 16, 2019 |
| Temperature: | 26.5°C | Tested by: | Jerry Lu |
| Humidity: | 50 % RH | Polarity: | Ver. |

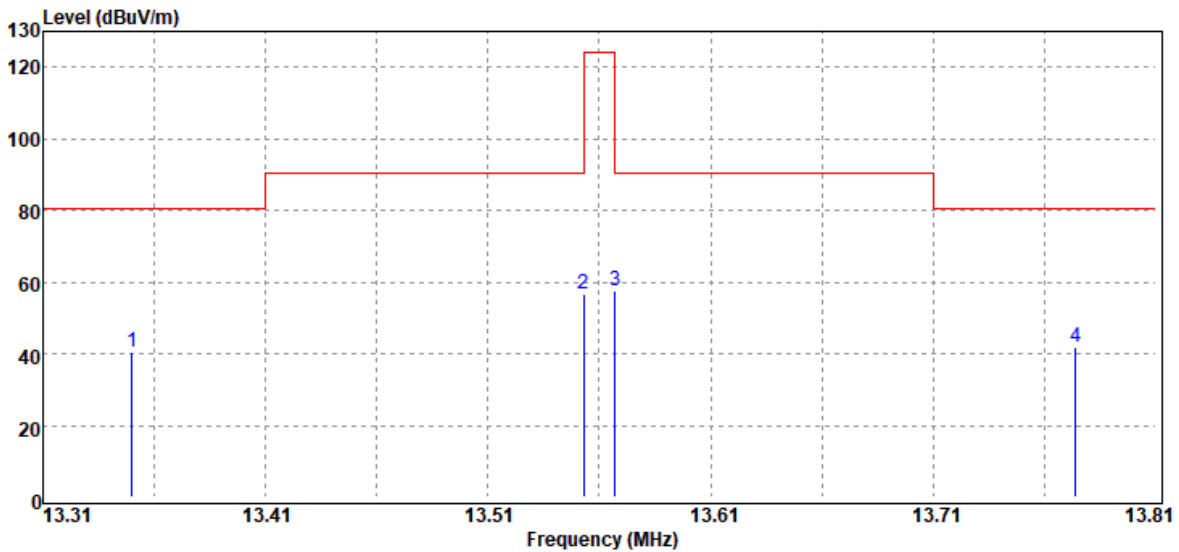

| No. | Frequency (MHz) | Reading (dBuV) | Correct Factor(dB/m) | Result (dBuV/m) | Limit (dBuV/m) | Margin (dB) | Remark |
|-----|-----------------|----------------|----------------------|-----------------|----------------|-------------|--------|
| 1 | 13.35 | 24.64 | 15.92 | 40.56 | 80.54 | -39.98 | Peak |
| 2 | 13.55 | 40.57 | 15.91 | 56.48 | 90.47 | -33.99 | Peak |
| 3 | 13.57 | 41.68 | 15.91 | 57.59 | 90.47 | -32.88 | Peak |
| 4 | 13.77 | 25.73 | 15.90 | 41.63 | 80.50 | -38.87 | Peak |

Remark:

1. Radiated emissions measured were made with an instrument using peak/quasi-peak/average detector mode.
2. Measurements above show only up to 6 maximum emissions noted, or would be lesser, with " N/A " remark, if no specific emissions from the EUT are recorded (ie: margin>20dB from the applicable limit) and considered that's already beyond the background noise floor.
3. Margin (dB) = Result (dBuV/m) – Limit (dBuV/m).

Report No.: T190909W01-RP

| | | | |
|------------------------|---------|-------------------|--------------------|
| Operation Mode: | TX mode | Test Date: | September 16, 2019 |
| Temperature: | 26.5°C | Tested by: | Jerry Lu |
| Humidity: | 50 % RH | Polarity: | Hor. |

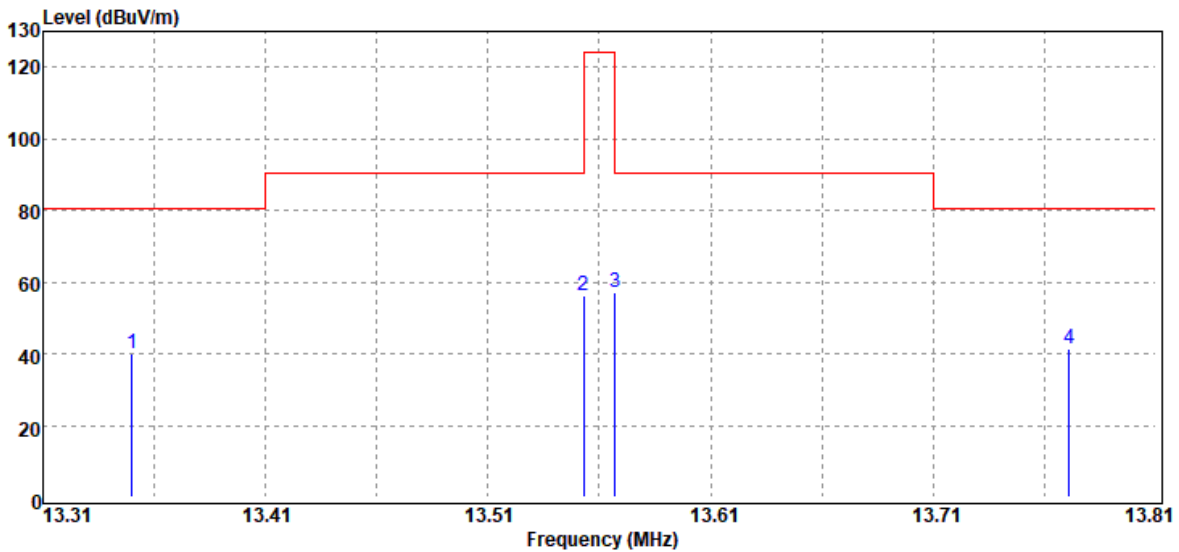

| No. | Frequency (MHz) | Reading (dBuV) | Correct Factor(dB/m) | Result (dBuV/m) | Limit (dBuV/m) | Margin (dB) | Remark |
|-----|-----------------|----------------|----------------------|-----------------|----------------|-------------|--------|
| 1 | 13.35 | 24.17 | 15.92 | 40.09 | 80.54 | -40.45 | Peak |
| 2 | 13.55 | 40.27 | 15.91 | 56.18 | 90.47 | -34.29 | Peak |
| 3 | 13.57 | 41.36 | 15.91 | 57.27 | 90.47 | -33.20 | Peak |
| 4 | 13.77 | 25.42 | 15.90 | 41.32 | 80.50 | -39.18 | Peak |

Remark:

1. Radiated emissions measured were made with an instrument using peak/quasi-peak/average detector mode.
2. Measurements above show only up to 6 maximum emissions noted, or would be lesser, with " N/A " remark, if no specific emissions from the EUT are recorded (ie: margin>20dB from the applicable limit) and considered that's already beyond the background noise floor.
3. Margin (dB) = Result (dBuV/m) – Limit (dBuV/m).

Report No.: T190909W01-RP

For Right door handle (The worst case)

9kHz ~ 30MHz

Operation Mode: TX mode
Temperature: 26.5°C
Humidity: 50 % RH

Test Date: September 16, 2019
Tested by: Jerry Lu
Polarity: Ver.

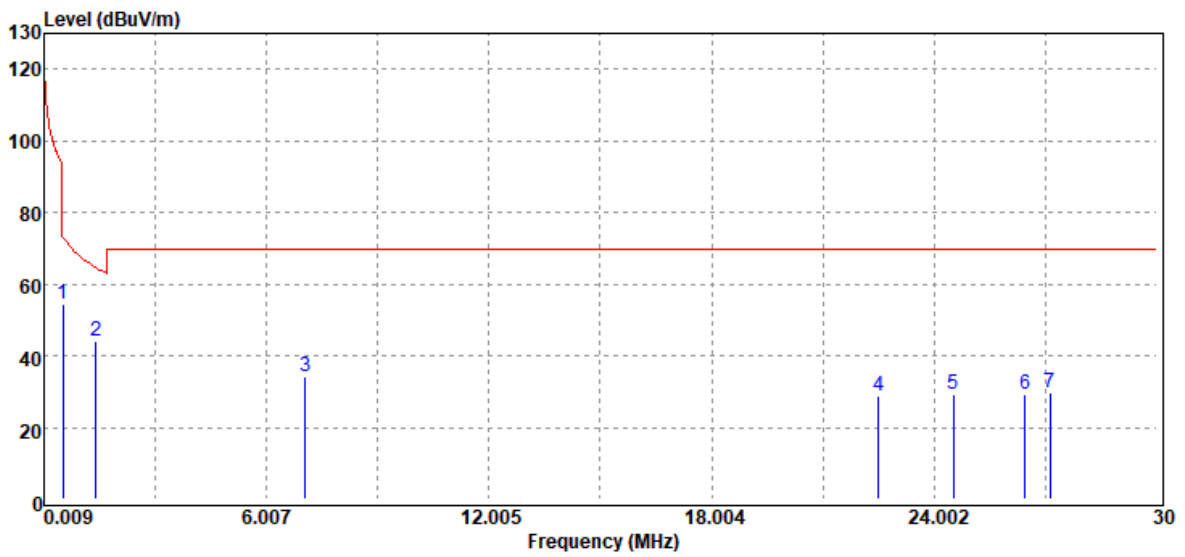

| Frequency (MHz) | Reading (dBuV) | Correction Factor (dB/m) | Result (dBuV/m) | Limit (dBuV/m) | Margin (dB) | Detector Mode (PK/QP/AVG) |
|-----------------|----------------|--------------------------|-----------------|----------------|-------------|---------------------------|
| 0.52 | 39.91 | 14.39 | 54.30 | 73.31 | -19.01 | Peak |
| 1.42 | 29.18 | 14.81 | 43.99 | 64.57 | -20.58 | Peak |
| 7.06 | 18.26 | 15.76 | 34.02 | 69.54 | -35.52 | Peak |
| 22.50 | 13.80 | 15.03 | 28.83 | 69.54 | -40.71 | Peak |
| 24.51 | 14.41 | 14.63 | 29.04 | 69.54 | -40.50 | Peak |
| 26.46 | 14.84 | 14.27 | 29.11 | 69.54 | -40.43 | Peak |
| 27.12 | 15.33 | 14.16 | 29.49 | 69.54 | -40.05 | Peak |

Report No.: T190909W01-RP

Operation Mode: TX mode
Temperature: 26.5°C
Humidity: 50 % RH

Test Date: September 16, 2019
Tested by: Jerry Lu
Polarity: Hor.

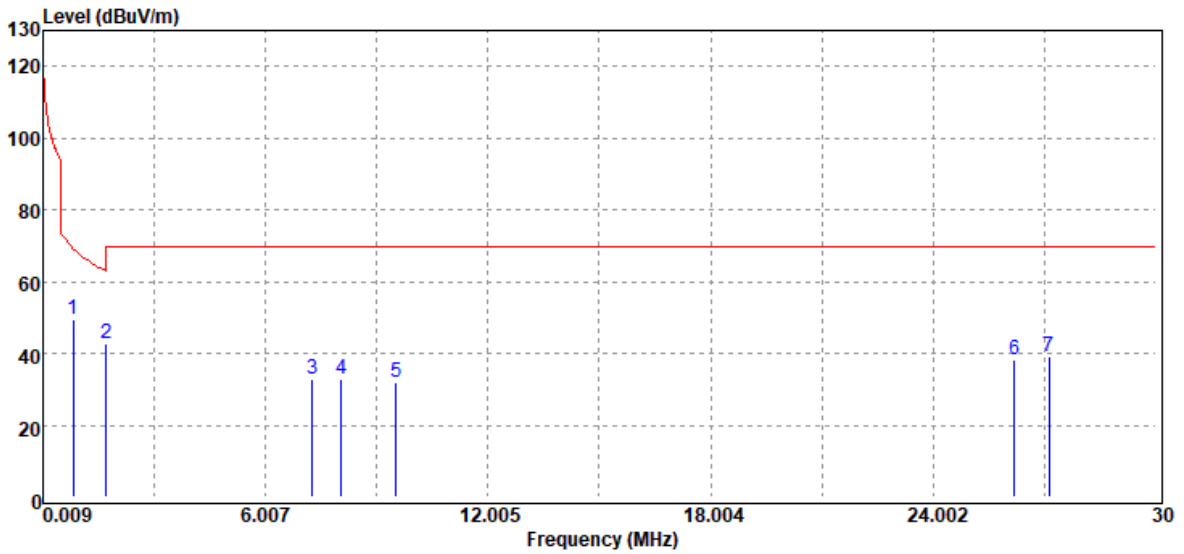

| Frequency (MHz) | Reading (dBuV) | Correction Factor (dB/m) | Result (dBuV/m) | Limit (dBuV/m) | Margin (dB) | Detector Mode (PK/QP/AVG) |
|-----------------|----------------|--------------------------|-----------------|----------------|-------------|---------------------------|
| 0.82 | 35.05 | 14.60 | 49.65 | 69.34 | -19.69 | Peak |
| 1.72 | 27.78 | 14.88 | 42.66 | 69.54 | -26.88 | Peak |
| 7.27 | 17.24 | 15.79 | 33.03 | 69.54 | -36.51 | Peak |
| 8.05 | 16.80 | 15.91 | 32.71 | 69.54 | -36.83 | Peak |
| 9.52 | 15.72 | 16.11 | 31.83 | 69.54 | -37.71 | Peak |
| 26.19 | 23.82 | 14.32 | 38.14 | 69.54 | -31.40 | Peak |
| 27.12 | 25.12 | 14.16 | 39.28 | 69.54 | -30.26 | Peak |

Report No.: T190909W01-RP

30MHz ~ 1GHz

Operation Mode: TX mode
Temperature: 26.5°C
Humidity: 50 % RH

Test Date: September 17, 2019
Tested by: Jerry Lu

| Frequency (MHz) | Reading (dBuV) | Correction Factor (dB/m) | Result (dBuV/m) | Limit 3m (dBuV/m) | Margin (dB) | Detector Mode (PK/QP/AVG) | Polarity (V/H) |
|-----------------|----------------|--------------------------|-----------------|-------------------|-------------|---------------------------|----------------|
| 175.50 | 42.41 | -11.11 | 31.30 | 43.50 | -12.20 | Peak | V |
| 243.40 | 39.41 | -10.28 | 29.13 | 46.00 | -16.87 | Peak | V |
| 335.55 | 33.05 | -7.18 | 25.87 | 46.00 | -20.13 | Peak | V |
| 416.06 | 32.78 | -4.89 | 27.89 | 46.00 | -18.11 | Peak | V |
| 495.60 | 31.93 | -3.04 | 28.89 | 46.00 | -17.11 | Peak | V |
| 639.16 | 30.89 | -0.28 | 30.61 | 46.00 | -15.39 | Peak | V |
| 240.49 | 44.14 | -10.25 | 33.89 | 46.00 | -12.11 | Peak | H |
| 335.55 | 37.88 | -7.18 | 30.70 | 46.00 | -15.30 | Peak | H |
| 511.12 | 31.53 | -2.94 | 28.59 | 46.00 | -17.41 | Peak | H |
| 576.11 | 33.76 | -1.82 | 31.94 | 46.00 | -14.06 | Peak | H |
| 687.66 | 29.99 | -0.28 | 29.71 | 46.00 | -16.29 | Peak | H |
| 769.14 | 29.19 | 1.59 | 30.78 | 46.00 | -15.22 | Peak | H |

Vertical

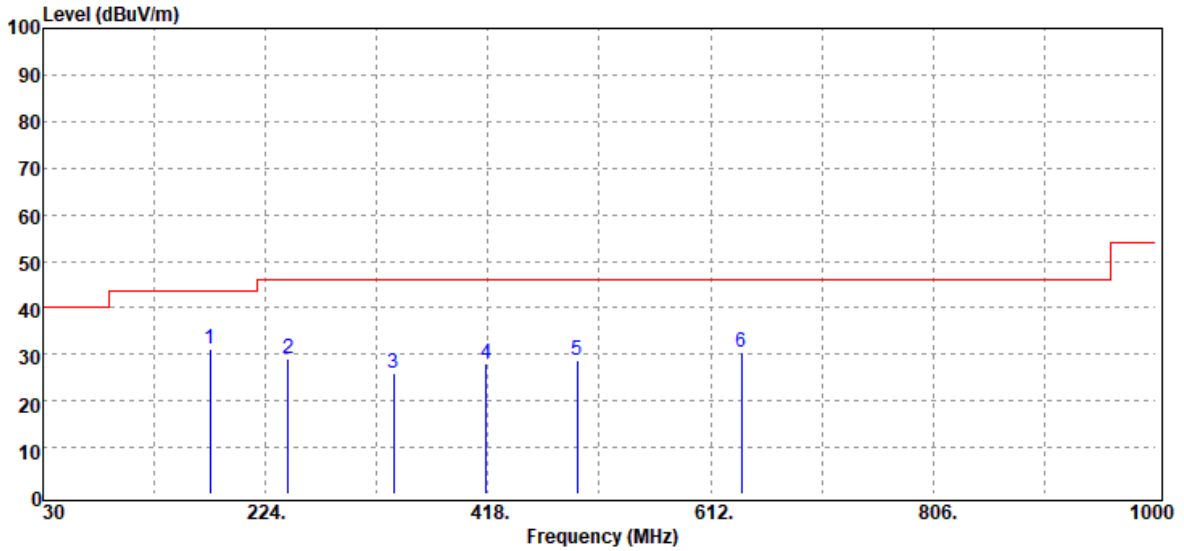

Horizontal

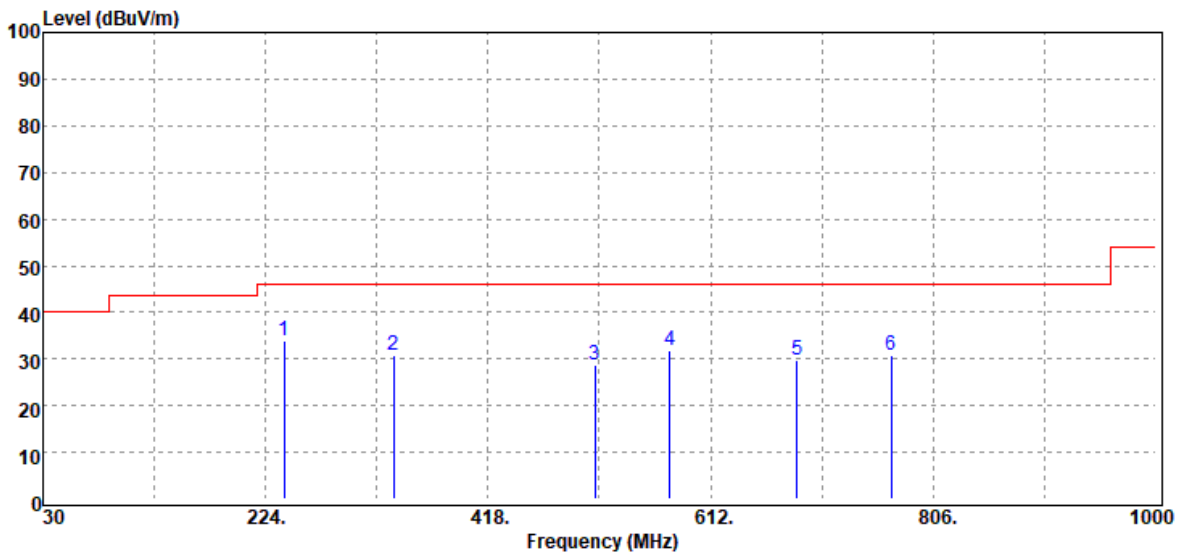

Report No.: T190909W01-RP

For Left door handle

9kHz ~ 30MHz

Operation Mode: TX mode
Temperature: 26.5°C
Humidity: 50 % RH

Test Date: September 16, 2019
Tested by: Jerry Lu
Polarity: Ver.

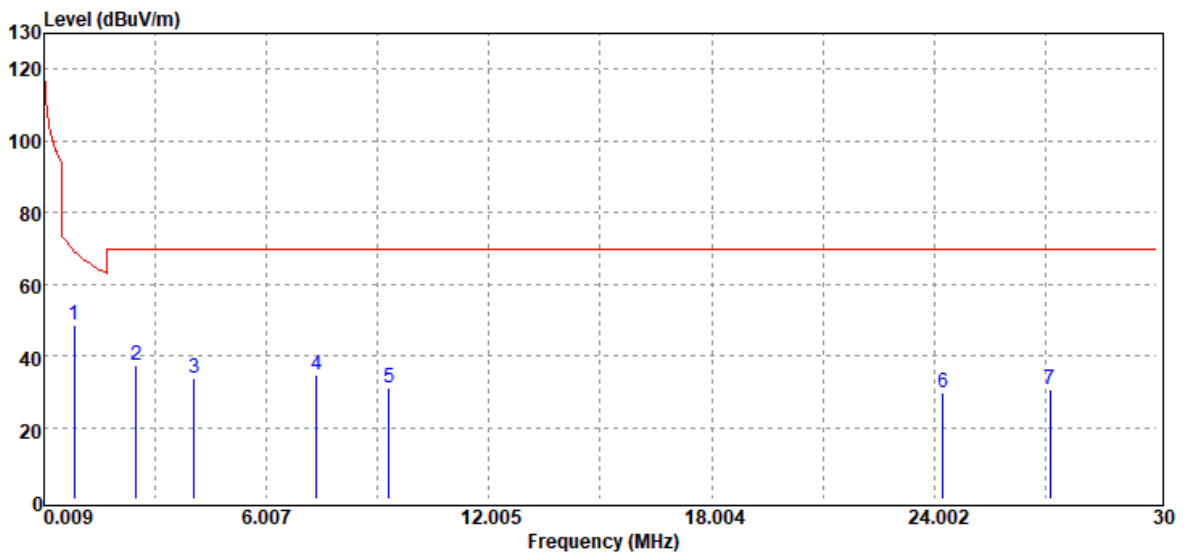

| Frequency (MHz) | Reading (dBuV) | Correction Factor (dB/m) | Result (dBuV/m) | Limit (dBuV/m) | Margin (dB) | Detector Mode (PK/QP/AVG) |
|-----------------|----------------|--------------------------|-----------------|----------------|-------------|---------------------------|
| 0.82 | 33.79 | 14.60 | 48.39 | 69.34 | -20.95 | Peak |
| 2.50 | 22.42 | 15.01 | 37.43 | 69.54 | -32.11 | Peak |
| 4.06 | 18.60 | 15.24 | 33.84 | 69.54 | -35.70 | Peak |
| 7.36 | 18.83 | 15.81 | 34.64 | 69.54 | -34.90 | Peak |
| 9.31 | 15.08 | 16.08 | 31.16 | 69.54 | -38.38 | Peak |
| 24.24 | 14.90 | 14.68 | 29.58 | 69.54 | -39.96 | Peak |
| 27.12 | 16.54 | 14.16 | 30.70 | 69.54 | -38.84 | Peak |

Report No.: T190909W01-RP

Operation Mode: TX mode
Temperature: 26.5°C
Humidity: 50 % RH

Test Date: September 16, 2019
Tested by: Jerry Lu
Polarity: Hor.

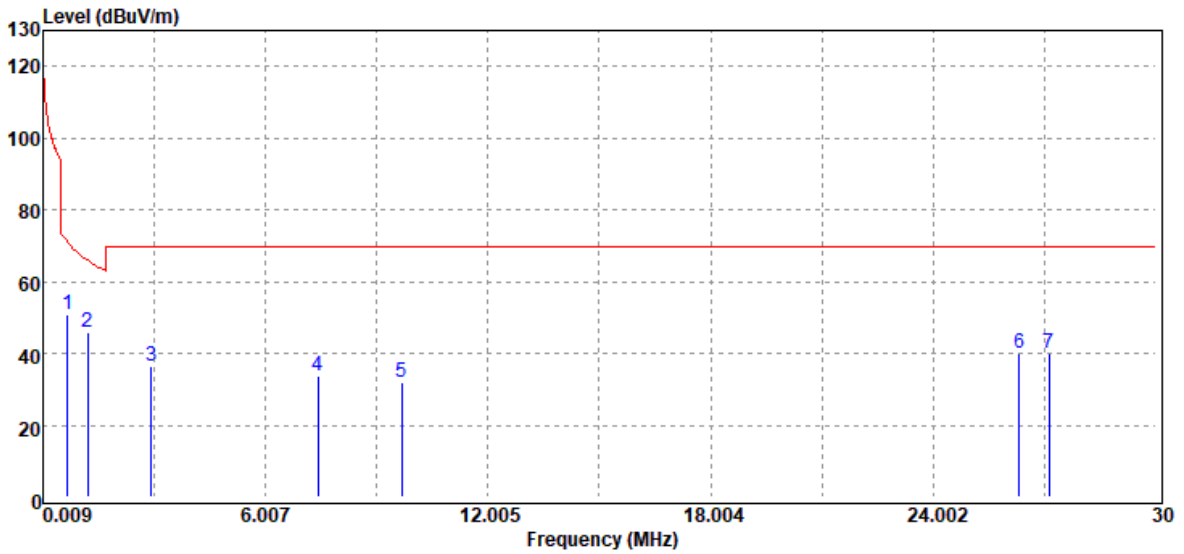

| Frequency (MHz) | Reading (dBuV) | Correction Factor (dB/m) | Result (dBuV/m) | Limit (dBuV/m) | Margin (dB) | Detector Mode (PK/QP/AVG) |
|-----------------|----------------|--------------------------|-----------------|----------------|-------------|---------------------------|
| 0.67 | 36.33 | 14.50 | 50.83 | 71.11 | -20.28 | Peak |
| 1.21 | 31.10 | 14.75 | 45.85 | 65.96 | -20.11 | Peak |
| 2.92 | 21.44 | 15.06 | 36.50 | 69.54 | -33.04 | Peak |
| 7.42 | 17.90 | 15.82 | 33.72 | 69.54 | -35.82 | Peak |
| 9.67 | 15.87 | 16.13 | 32.00 | 69.54 | -37.54 | Peak |
| 26.31 | 25.62 | 14.30 | 39.92 | 69.54 | -29.62 | Peak |
| 27.12 | 26.08 | 14.16 | 40.24 | 69.54 | -29.30 | Peak |

Report No.: T190909W01-RP

30MHz ~ 1GHz

Operation Mode: TX mode
Temperature: 26.5°C
Humidity: 50 % RH

Test Date: September 17, 2019
Tested by: Jerry Lu

| Frequency (MHz) | Reading (dBuV) | Correction Factor (dB/m) | Result (dBuV/m) | Limit 3m (dBuV/m) | Margin (dB) | Detector Mode (PK/QP/AVG) | Polarity (V/H) |
|-----------------|----------------|--------------------------|-----------------|-------------------|-------------|---------------------------|----------------|
| 202.66 | 40.88 | -10.40 | 30.48 | 43.50 | -13.02 | Peak | V |
| 303.54 | 36.52 | -8.12 | 28.40 | 46.00 | -17.60 | Peak | V |
| 434.49 | 34.33 | -4.23 | 30.10 | 46.00 | -15.90 | Peak | V |
| 527.61 | 33.49 | -2.38 | 31.11 | 46.00 | -14.89 | Peak | V |
| 576.11 | 34.00 | -1.82 | 32.18 | 46.00 | -13.82 | Peak | V |
| 736.16 | 29.91 | 1.49 | 31.40 | 46.00 | -14.60 | Peak | V |
| 240.49 | 43.08 | -10.25 | 32.83 | 46.00 | -13.17 | Peak | H |
| 335.55 | 36.89 | -7.18 | 29.71 | 46.00 | -16.29 | Peak | H |
| 434.49 | 32.74 | -4.23 | 28.51 | 46.00 | -17.49 | Peak | H |
| 576.11 | 32.78 | -1.82 | 30.96 | 46.00 | -15.04 | Peak | H |
| 672.14 | 33.50 | 0.02 | 33.52 | 46.00 | -12.48 | Peak | H |
| 736.16 | 30.29 | 1.49 | 31.78 | 46.00 | -14.22 | Peak | H |

Vertical

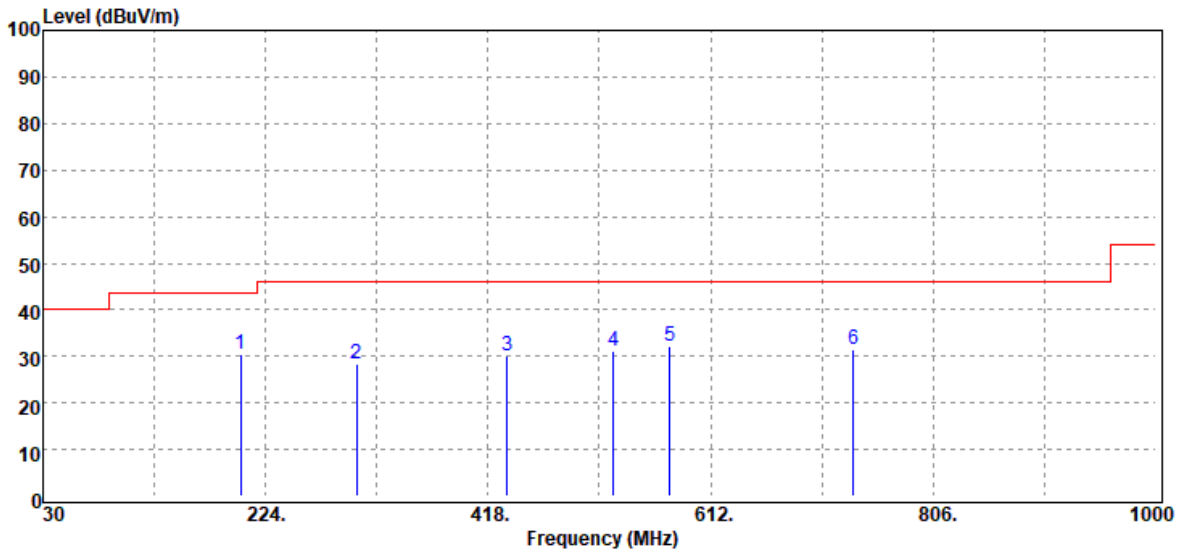

Horizontal

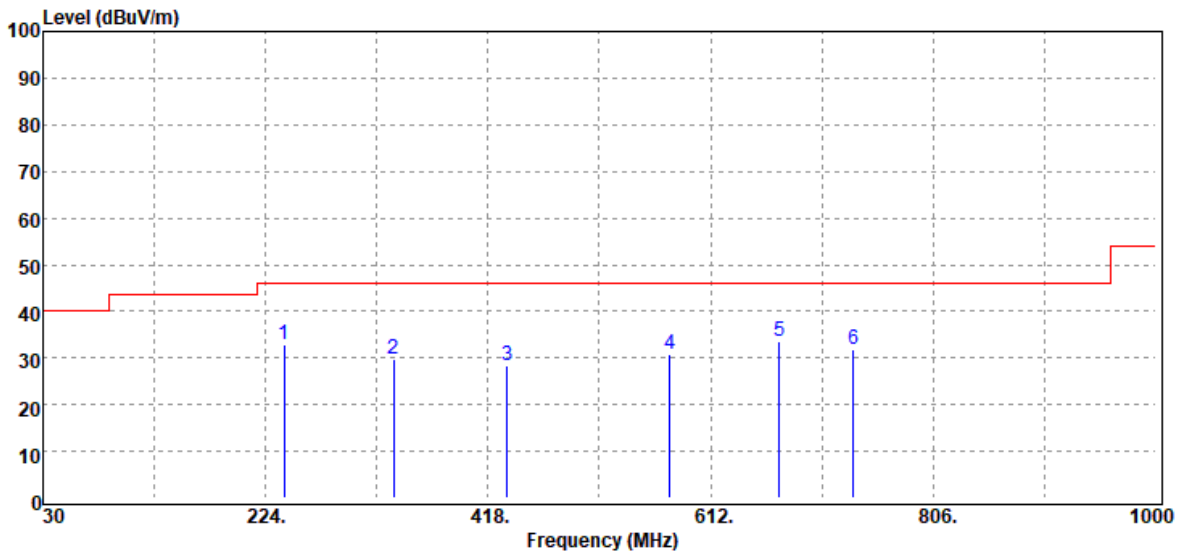

Report No.: T190909W01-RP

8.3 FREQUENCY STABILITY

LIMIT

According to §15.225(e),

The frequency tolerance of the carrier signal shall be maintained within +/- 0.01% of the operating frequency over a temperature variation of -40 degrees to +75 degrees C at normal supply voltage, and for a variation in the primary supply voltage from 85% to 115% of the rated supply voltage at a temperature of 20 degrees C. For battery operated equipment, the equipment tests shall be performed using a new battery.

Test Configuration

Temperature and Voltage Measurement (under normal and extreme test conditions)

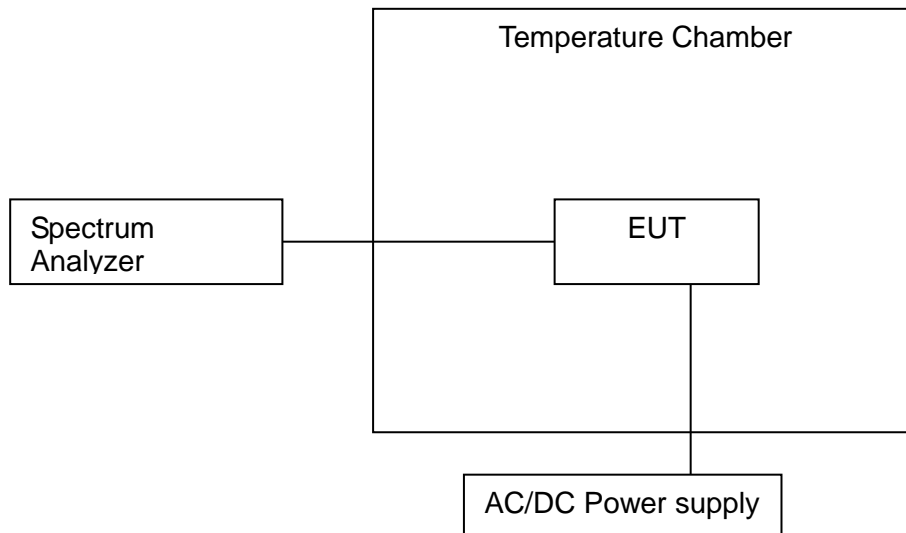

TEST PROCEDURE

1. Turn the EUT off, and place it inside the environmental temperature chamber.
2. Set the temperature control on the chamber to the highest specified in the regulatory requirements for the type of device and allow the oscillator heater and the chamber temperature to stabilize.
3. Set the spectrum analyzer as RBW=1kHz, VBW = RBW, Span = 200kHz, Sweep = auto.
4. Turn the EUT on and record the operating frequency at startup and two, five, and ten minutes after the EUT is energized.
5. Switch off the EUT and Lower the chamber temperature by not more than 10 °C and allow the temperature inside the chamber to stabilize.
6. Mark the peak frequency and measure the frequency tolerance using frequency counter function.
7. Repeat step 4 through step 6 down to the lowest specified temperature.

Report No.: T190909W01-RP

TEST RESULTS

No non-compliance noted.

TEST DATA

| Condition | | | Frequency Error (ppm) | | | | | | | | | | Result |
|-------------------------------------|-----------------|------------|-----------------------|-----------|-----------|-----------|-------|-------|-------|--------|-------------|------|--------|
| Temperature | Modulation Mode | Test Freq. | 0 min | 2 min | 5 min | 10 min | 0 min | 2 min | 5 min | 10 min | Limit (ppm) | | |
| | | | Normal | | | | | | | | | | |
| T _{20°C} V _{max} | CW | 13.56 | 13.560370 | 13.560370 | 13.560370 | 13.560372 | 27.30 | 27.30 | 27.30 | 27.43 | 100 | Pass | |
| T _{20°C} V _{min} | CW | 13.56 | 13.560373 | 13.560374 | 13.560373 | 13.560372 | 27.53 | 27.58 | 27.49 | 27.42 | | Pass | |
| | | | Extreme | | | | | | | | | | |
| T _{75°C} V _{nom} | CW | 13.56 | 13.560375 | 13.560675 | 13.560375 | 13.560375 | 27.64 | 49.77 | 27.64 | 27.65 | 100 | Pass | |
| T _{70°C} V _{nom} | CW | 13.56 | 13.560375 | 13.560375 | 13.560375 | 13.560375 | 27.63 | 27.62 | 27.62 | 27.65 | | Pass | |
| T _{60°C} V _{nom} | CW | 13.56 | 13.560374 | 13.560375 | 13.560375 | 13.560375 | 27.60 | 27.64 | 27.66 | 27.65 | | Pass | |
| T _{50°C} V _{nom} | CW | 13.56 | 13.560375 | 13.560375 | 13.560375 | 13.560375 | 27.64 | 27.66 | 27.63 | 27.64 | | Pass | |
| T _{40°C} V _{nom} | CW | 13.56 | 13.560375 | 13.560375 | 13.560375 | 13.560375 | 27.66 | 27.63 | 27.63 | 27.64 | | Pass | |
| T _{30°C} V _{nom} | CW | 13.56 | 13.560375 | 13.560375 | 13.560675 | 13.560675 | 27.64 | 27.64 | 49.75 | 49.76 | | Pass | |
| T _{20°C} V _{nom} | CW | 13.56 | 13.560692 | 13.560635 | 13.560336 | 13.560345 | 51.01 | 46.84 | 24.77 | 25.46 | | Pass | |
| T _{10°C} V _{nom} | CW | 13.56 | 13.560375 | 13.560375 | 13.560975 | 13.560376 | 27.63 | 27.64 | 71.87 | 27.70 | | Pass | |
| T _{0°C} V _{nom} | CW | 13.56 | 13.560374 | 13.560675 | 13.560674 | 13.560375 | 27.61 | 49.76 | 49.69 | 27.63 | | Pass | |
| T _{-10°C} V _{nom} | CW | 13.56 | 13.560675 | 13.560675 | 13.560375 | 13.560675 | 49.77 | 49.78 | 27.66 | 49.76 | | Pass | |
| T _{-20°C} V _{nom} | CW | 13.56 | 13.560674 | 13.560674 | 13.560375 | 13.560675 | 49.71 | 49.72 | 27.65 | 49.78 | | Pass | |
| T _{-30°C} V _{nom} | CW | 13.56 | 13.560674 | 13.560374 | 13.560375 | 13.560675 | 49.73 | 27.62 | 27.67 | 49.75 | | Pass | |
| T _{-40°C} V _{nom} | CW | 13.56 | 13.560375 | 13.560375 | 13.560675 | 13.560675 | 27.66 | 27.66 | 49.78 | 49.75 | | Pass | |

Remark: V_{nom}: 12
V_{max}: 13.2
V_{min}: 10.8

8.4 POWERLINE CONDUCTED EMISSIONS

LIMIT

According to §15.207(a), for an intentional radiator that is designed to be connected to the public utility (AC) power line, the radio frequency voltage that is conducted back onto the AC power line on any frequency or frequencies within the band 150 kHz to 30 MHz shall not exceed the limits in the following table, as measured using a 50 μ H/50 ohms line impedance stabilization network (LISN). Compliance with the provisions of this paragraph shall be based on the measurement of the radio frequency voltage between each power line and ground at the power terminal. The lower limit applies at the boundary between the frequency ranges.

| Frequency Range (MHz) | Limits (dB μ V) | |
|--------------------------|------------------------|-----------|
| | Quasi-peak | Average |
| 0.15 to 0.50 | 66 to 56* | 56 to 46* |
| 0.50 to 5 | 56 | 46 |
| 5 to 30 | 60 | 50 |

* Decreases with the logarithm of the frequency.

TEST PROCEDURE

1. The EUT was placed on a table, which is 0.8m above ground plane.
2. Maximum procedure was performed on the six highest emissions to ensure EUT compliance.
3. Repeat above procedures until all frequency measured were complete.

TEST RESULTS

The initial step in collecting conducted data is a spectrum analyzer peak scan of the measurement range. Significant peaks are then marked as shown on the following data page, and these signals are then quasi-peaked.

Test Data

Not applicable, because EUT not connect to AC Main Source direct.

- End of Test Report -