



FCC ID: KR5-DHSHMCNFCDN8 ISED No: 7812D-DHSHMCNFCDN8  
Report No.: T181207W01-RP

Page: 1 / 27  
Rev.: 01

## FCC 47 CFR PART 15 SUBPART C & INDUSTRY CANADA RSS-210

### TEST REPORT

For

**NFC Door Handle Sensor**

**Model No.:**

**DHS HMC NFC DN8**

**Trade Name: Continental**

*Issued to*

**Continental Automotive GmbH  
Siemensstrasse 12  
SV C TS RBG EMC-Laboratory  
Regensburg, 93055  
Germany**

*Issued by*

**Compliance Certification Services Inc.  
Wugu Laboratory  
No.11, Wugong 6th Rd., Wugu Dist.,  
New Taipei City 24891, Taiwan. (R.O.C.)  
Issued Date: February 12, 2019**

Unless otherwise stated the results shown in this test report refer only to the sample(s) tested and such sample(s) are retained for 90 days only.  
除非另有說明，此報告結果僅對測試之樣品負責，同時此樣品僅保留90天。本報告未經本公司書面許可，不可部分複製。

This document is issued by the Company subject to its General Conditions of Service printed overleaf, available on request or accessible at [www.sgs.com/terms\\_and\\_conditions.htm](http://www.sgs.com/terms_and_conditions.htm) and for electronic format documents, subject to Terms and Conditions for Electronic Documents at [www.sgs.com/terms\\_e-document.htm](http://www.sgs.com/terms_e-document.htm). Attention is drawn to the limitation of liability, indemnification and jurisdiction issues defined therein. Any holder of this document is advised that information contained hereon reflects the Company's findings at the time of its intervention only and within the limits of Client's instructions, if any. The Company's sole responsibility is to its Client and this document does not exonerate parties to a transaction from exercising all their rights and obligations under the transaction documents. This document cannot be reproduced except in full, without prior written approval of the Company. Any unauthorized alteration, forgery or falsification of the content or appearance of this document is unlawful and offenders may be prosecuted to the fullest extent of the law.

**Revision History**

Rev.	Issue Date	Revisions	Effect Page	Revised By
00	January 7, 2019	Initial Issue	ALL	Allison Chen
01	February 12, 2019	<ol style="list-style-type: none"> <li>1. Revised zip code for address.</li> <li>2. Revised KDB 937606 to KDB 414788.</li> <li>3. Added IC Limit and description of "Polarity (V/H)" for test data in section 8.2.</li> <li>4. Added IC Limit and revised test data in section 8.3.</li> <li>5. Added Test Summary in section 3.</li> <li>6. Added "RSS-210 Issue 9" in table of applicable standard.</li> <li>7. Added IC restricted band table in section 4.3.</li> </ol>	P.1, 4, 8, 17, 19, 23, 25-26	Allison Chen

## TABLE OF CONTENTS

<b>1. TEST RESULT CERTIFICATION.....</b>	<b>4</b>
<b>2. EUT DESCRIPTION.....</b>	<b>5</b>
<b>3. TEST SUMMERY.....</b>	<b>6</b>
<b>4. TEST METHODOLOGY.....</b>	<b>7</b>
4.1 EUT CONFIGURATION.....	7
4.2 FCC PART 15.205 RESTRICTED BANDS OF OPERATIONS.....	7
4.3 RSS GEN SECTION 8.10 RESTRICTED BANDS OF OPERATIONS.....	8
4.4 DESCRIPTION OF TEST MODES.....	9
<b>5. INSTRUMENT CALIBRATION.....</b>	<b>10</b>
5.1 MEASURING INSTRUMENT CALIBRATION.....	10
5.2 MEASUREMENT EQUIPMENT USED.....	10
5.3 MEASUREMENT UNCERTAINTY.....	11
<b>6. FACILITIES AND ACCREDITATIONS.....</b>	<b>12</b>
6.1 FACILITIES.....	12
6.2 EQUIPMENT.....	12
<b>7. SETUP OF EQUIPMENT UNDER TEST.....</b>	<b>13</b>
7.1 SETUP CONFIGURATION OF EUT.....	13
7.2 SUPPORT EQUIPMENT.....	13
<b>8. FCC PART 15.225 REQUIREMENTS &amp; RSS-210 REQUIREMENTS.....</b>	<b>14</b>
8.1 OCCUPIED BANDWIDTH(99%) AND 20 DB BANDWIDTH.....	14
8.2 RADIATED EMISSIONS.....	16
8.3 FREQUENCY STABILITY.....	25
8.4 POWERLINE CONDUCTED EMISSIONS.....	27
<b>APPENDIX A PHOTOGRAPHS OF TEST SETUP.....</b>	<b>A-1</b>
<b>APPENDIX 1 - PHOTOGRAPHS OF EUT</b>	

## 1. TEST RESULT CERTIFICATION

**Applicant:** Continental Automotive GmbH  
Siemensstrasse 12  
SV C TS RBG EMC-Laboratory  
Regensburg, 93055  
Germany

**Manufacturer:** Continental Automotive GmbH  
Siemensstrasse 12  
SV C TS RBG EMC-Laboratory  
Regensburg, 93055  
Germany

**Factory:** Continental Automotive Electronics LLC.  
74-7, Geumhoseonmal-gil, Bugang-myeon, Sejong-si, 339-942,  
Korea

**Equipment Under Test:** NFC Door Handle Sensor

**Trade Name:** Continental

**Model No.:** DHS HMC NFC DN8

**Date of Test:** December 10 ~ 12, 2018

APPLICABLE STANDARDS	
STANDARD	TEST RESULT
FCC 47 CFR Part 15 Subpart C & RSS-210 Issue 9 and RSS-GEN Issue 5	No non-compliance noted

### We hereby certify that:

The above equipment was tested by Compliance Certification Services Inc. The test data, data evaluation, test procedures, and equipment configurations shown in this report were made in accordance with the procedures given in ANSI C63.10: 2013 and the energy emitted by the sample tested as described in this report is in compliance with the requirements of FCC Rules Part 15.225.

The test results of this report relate only to the tested sample identified in this report.

Approved by:

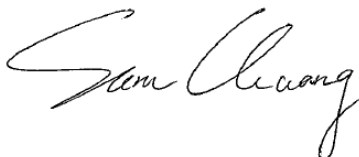

Sam Chuang  
Manager  
Compliance Certification Services Inc.

Tested by:



Jerry Chuang  
Engineer  
Compliance Certification Services Inc.

## 2. EUT DESCRIPTION

<b>Product</b>	NFC Door Handle Sensor
<b>Model No.</b>	DHS HMC NFC DN8
<b>Model Discrepancy</b>	N/A
<b>Trade</b>	Continental
<b>Received Date</b>	December 07, 2018
<b>Power Supply</b>	Power from power supply. (DC12V)
<b>Frequency Range</b>	13.56MHz
<b>Modulation Technique</b>	ASK
<b>Number of Channels</b>	1 Channel
<b>Antenna Requirement</b>	Antenna type: Antenna on Flex-PCB Antenna gain (max): -67.7dBi

**Remark:**

1. *The sample selected for test was engineering sample that approximated to production product and was provided by manufacturer.*

### 3. TEST SUMMERY

FCC Standard Sec.	IC Standard Sec.	Chapter	Test Item	Result
15.203	RSS-GEN Sec. 8.3	2	Antenna Requirement	Pass
15.215	RSS-210	8.1	Occupied Bandwidth (99%) and 20dB Bandwidth	Pass
15.209	RSS-210	8.2	Radiated Emissions	Pass
15.225	RSS-210	8.3	Frequency Stability	Pass
15.207	RSS-GEN Sec. 8.8	8.4	AC Power-line Conducted Emission	N/A

Report No.: T181207W01-RP

## 4. TEST METHODOLOGY

The tests documented in this report were performed in accordance with ANSI C63.10: 2013 and FCC CFR 47 Part 15.207, 15.209, 15.225.

The tests documented in this report were performed in accordance with IC RSS-210, IC RSS-Gen, and ANSI C63.10: 2013

### 4.1 EUT CONFIGURATION

The EUT configuration for testing is installed on RF field strength measurement to meet the Commissions requirement and operating in a manner that intends to maximize its emission characteristics in a continuous normal application.

### 4.2 FCC PART 15.205 RESTRICTED BANDS OF OPERATIONS

(a) Except as shown in paragraph (d) of this section, only spurious emissions are permitted in any of the frequency bands listed below:

MHz	MHz	MHz	GHz
0.090 - 0.110	16.42 - 16.423	399.9 - 410	4.5 - 5.15
0.495 - 0.505	16.69475 - 16.69525	608 - 614	5.35 - 5.46
2.1735 - 2.1905	16.80425 - 16.80475	960 - 1240	7.25 - 7.75
4.125 - 4.128	25.5 - 25.67	1300 - 1427	8.025 - 8.5
4.17725 - 4.17775	37.5 - 38.25	1435 - 1626.5	9.0 - 9.2
4.20725 - 4.20775	73 - 74.6	1645.5 - 1646.5	9.3 - 9.5
6.215 - 6.218	74.8 - 75.2	1660 - 1710	10.6 - 12.7
6.26775 - 6.26825	108 - 121.94	1718.8 - 1722.2	13.25 - 13.4
6.31175 - 6.31225	123 - 138	2200 - 2300	14.47 - 14.5
8.291 - 8.294	149.9 - 150.05	2310 - 2390	15.35 - 16.2
8.362 - 8.366	156.52475 -	2483.5 - 2500	17.7 - 21.4
8.37625 - 8.38675	156.52525	2655 - 2900	22.01 - 23.12
8.41425 - 8.41475	156.7 - 156.9	3260 - 3267	23.6 - 24.0
12.29 - 12.293	162.0125 - 167.17	3332 - 3339	31.2 - 31.8
12.51975 - 12.52025	167.72 - 173.2	3345.8 - 3358	36.43 - 36.5
12.57675 - 12.57725	240 - 285	3600 - 4400	( <sup>2</sup> )
13.36 - 13.41	322 - 335.4		

<sup>1</sup> Until February 1, 1999, this restricted band shall be 0.490-0.510 MHz.

<sup>2</sup> Above 38.6

(b) Except as provided in paragraphs (d) and (e), the field strength of emissions appearing within these frequency bands shall not exceed the limits shown in Section 15.209. At frequencies equal to or less than 1000 MHz, compliance with the limits in Section 15.209 shall be demonstrated using measurement instrumentation employing a CISPR quasi-peak detector. Above 1000 MHz, compliance with the emission limits in Section 15.209 shall be demonstrated based on the average value of the measured emissions. The provisions in Section 15.35 apply to these measurements.

### 4.3 RSS GEN SECTION 8.10 RESTRICTED BANDS OF OPERATIONS

(a) Except as shown in paragraph (d) of this section, only spurious emissions are permitted in any of the frequency bands listed below:

MHz	MHz	MHz	GHz
0.090 - 0.110	16.42 - 16.423	399.9 - 410	4.5 - 5.15
<sup>1</sup> 0.495 - 0.505	16.69475 - 16.69525	608 - 614	5.35 - 5.46
2.1735 - 2.1905	16.80425 - 16.80475	960 - 1240	7.25 - 7.75
4.125 - 4.128	25.5 - 25.67	1300 - 1427	8.025 - 8.5
4.17725 - 4.17775	37.5 - 38.25	1435 - 1626.5	9.0 - 9.2
4.20725 - 4.20775	73 - 74.6	1645.5 - 1646.5	9.3 - 9.5
6.215 - 6.218	74.8 - 75.2	1660 - 1710	10.6 - 12.7
6.26775 - 6.26825	108 - 121.94	1718.8 - 1722.2	13.25 - 13.4
6.31175 - 6.31225	123 - 138	2200 - 2300	14.47 - 14.5
8.291 - 8.294	149.9 - 150.05	2310 - 2390	15.35 - 16.2
8.362 - 8.366	156.52475 -	2483.5 - 2500	17.7 - 21.4
8.37625 - 8.38675	156.52525	2655 - 2900	22.01 - 23.12
8.41425 - 8.41475	156.7 - 156.9	3260 - 3267	23.6 - 24.0
12.29 - 12.293	162.0125 - 167.17	3332 - 3339	31.2 - 31.8
12.51975 - 12.52025	167.72 - 173.2	3345.8 - 3358	36.43 - 36.5
12.57675 - 12.57725	240 - 285	3600 - 4400	( <sup>2</sup> )
13.36 - 13.41	322 - 335.4		

<sup>1</sup> Until February 1, 1999, this restricted band shall be 0.490-0.510 MHz.

<sup>2</sup> Above 38.6

(b) Except as provided in paragraphs (d) and (e), the field strength of emissions appearing within these frequency bands shall not exceed the limits shown in Section 15.209. At frequencies equal to or less than 1000 MHz, compliance with the limits in Section 15.209 shall be demonstrated using measurement instrumentation employing a CISPR quasi-peak detector. Above 1000 MHz, compliance with the emission limits in Section 15.209 shall be demonstrated based on the average value of the measured emissions. The provisions in Section 15.35 apply to these measurements.



Report No.: T181207W01-RP

#### 4.4 DESCRIPTION OF TEST MODES

The EUT had been tested under engineering test mode condition and the EUT staying in continuous transmitting mode.

All modes and data rates were investigated and it was determined that ISO 14443A/B and ISO 18092 Type y, 106/212/424/848 kbps.

All data rates were investigated and it was determined that 106 Kbps was considered worst-case. Therefore, all testing was performed in 106 Kbps mode.

##### 4.4.1 The worst mode of measurement

Radiated Emission Measurement Above 1G	
Test Condition	Band edge, Emission for Unwanted and Fundamental
Power supply Mode	Mode 1:EUT power by Power Supply(DC 12V)
Worst Mode	<input checked="" type="checkbox"/> Mode 1 <input type="checkbox"/> Mode 2 <input type="checkbox"/> Mode 3 <input type="checkbox"/> Mode 4
Worst Position	<input type="checkbox"/> Placed in fixed position. <input type="checkbox"/> Placed in fixed position at X-Plane (E2-Plane) <input checked="" type="checkbox"/> Placed in fixed position at Y-Plane (E1-Plane) <input type="checkbox"/> Placed in fixed position at Z-Plane (H-Plane)
Worst Polarity	<input checked="" type="checkbox"/> Horizontal <input type="checkbox"/> Vertical

Radiated Emission Measurement Below 1G	
Test Condition	Radiated Emission Below 1G
Power supply Mode	Mode 1:EUT power by Power Supply(DC 12V)
Worst Mode	<input checked="" type="checkbox"/> Mode 1 <input type="checkbox"/> Mode 2 <input type="checkbox"/> Mode 3 <input type="checkbox"/> Mode 4

Remark:

1. The worst mode was record in this test report.
2. EUT pre-scanned in three axis ,X, Y, Z and two polarity, Horizontal and Vertical for radiated measurement. The worst case(Y-Plane and Horizontal) were recorded in this report

## 5. INSTRUMENT CALIBRATION

### 5.1 MEASURING INSTRUMENT CALIBRATION

The measuring equipment, which was utilized in performing the tests documented herein, has been calibrated in accordance with the manufacturer's recommendations for utilizing calibration equipment, which is traceable to recognized national standards.

### 5.2 MEASUREMENT EQUIPMENT USED

#### Equipment Used for Emissions Measurement

Conducted Emissions Test Site					
Name of Equipment	Manufacturer	Model	S/N	Calibration Date	Calibration Due
Signal Analyzer	R&S	FSV 40	101073	09/27/2018	09/26/2019
Thermostatic/Hygrosatic Chamber	TAICHY	MHG-150LF	930619	10/08/2018	10/07/2019

Wugu 966 Chamber A					
Name of Equipment	Manufacturer	Model	S/N	Calibration Date	Calibration Due
Bilog Antenna	Sunol Sciences	JB3	A030105	07/13/2018	07/12/2019
Cable	HUBER SUHNER	SUCOFLEX 104PEA	20995	06/29/2018	06/28/2019
Digital Thermo-Hygro Meter	WISEWIND	1206	D07	02/08/2018	02/07/2019
Loop Ant	COM-POWER	AL-130	121051	03/21/2018	03/20/2019
Pre-Amplifier	EMEC	EM330	060609	06/29/2018	06/28/2019
PSA Series Spectrum Analyzer	Agilent	E4446A	MY46180323	05/31/2018	05/30/2019
Antenna Tower	CCS	CC-A-1F	N/A	N.C.R	N.C.R
Controller	CCS	CC-C-1F	N/A	N.C.R	N.C.R
Turn Table	CCS	CC-T-1F	N/A	N.C.R	N.C.R

**Remark:** Each piece of equipment is scheduled for calibration once a year

### 5.3 MEASUREMENT UNCERTAINTY

PARAMETER	UNCERTAINTY
Powerline Conducted Emission	+/- 2.96
3M Semi Anechoic Chamber / 30M~200M	+/- 4.0138
3M Semi Anechoic Chamber / 200M~1000M	+/- 3.9483
3M Semi Anechoic Chamber / 1G~8G	+/- 2.5975
3M Semi Anechoic Chamber / 8G~18G	+/- 2.6112
3M Semi Anechoic Chamber / 18G~26G	+/- 2.7389
3M Semi Anechoic Chamber / 26G~40G	+/- 2.9683

**Remark:** This uncertainty represents an expanded uncertainty expressed at approximately the 95% confidence level using a coverage factor of  $k=2$ .

## 6. FACILITIES AND ACCREDITATIONS

### 6.1 FACILITIES

All measurement facilities used to collect the measurement data are located at

- No.199, Chunghsen Road, Hsintien City, Taipei Hsien, Taiwan, R.O.C.  
Tel: 886-2-2217-0894 / Fax: 886-2-2217-1029
- No.11, Wugong 6th Rd., Wugu Dist., New Taipei City 24891, Taiwan. (R.O.C.)  
Tel: 886-2-2299-9720 / Fax: 886-2-2298-4045

The sites are constructed in conformance with the requirements of ANSI C63.7, ANSI C63.10: 2013 and CISPR Publication 22.

### 6.2 EQUIPMENT

Radiated emissions are measured with one or more of the following types of linearly polarized antennas: tuned dipole, bucolical, log periodic, bi-log, and/or ridged waveguide, horn. Spectrum analyzers with pre-selectors and quasi-peak detectors are used to perform radiated measurements.

Conducted emissions are measured with Line Impedance Stabilization Networks and EMI Test Receivers.

Calibrated wideband preamplifiers, coaxial cables, and coaxial attenuators are also used for making measurements.

All receiving equipment conforms to CISPR Publication 16-1, "Radio Interference Measuring Apparatus and Measurement Methods."

## 7. SETUP OF EQUIPMENT UNDER TEST

### 7.1 SETUP CONFIGURATION OF EUT

See test photographs attached in Appendix A for the actual connections between EUT and support equipment.

### 7.2 SUPPORT EQUIPMENT

No.	Device Type	Brand	Model	Series No.	FCC ID	Cable length & Type Describe
1.	DC Power Source	GWINSTEK	SPS-3610	N/A	N/A	DC Cable 1.5m shielding

**Remark:**

- 1. All the equipment/cables were placed in the worst-case configuration to maximize the emission during the test.*
- 2. Grounding was established in accordance with the manufacturer's requirements and conditions for the intended use.*

## 8. FCC PART 15.225 REQUIREMENTS & RSS-210 REQUIREMENTS

### 8.1 OCCUPIED BANDWIDTH(99%) AND 20 dB BANDWIDTH TEST CONFIGURATION

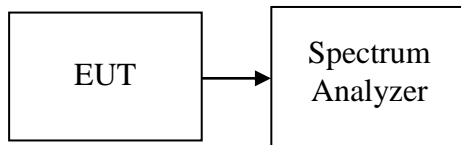

### TEST PROCEDURE

1. Place the EUT on the table and set it in the transmitting mode.
2. Remove the antenna from the EUT and then connect a low loss RF cable from the antenna port to the spectrum analyzer.
3. Set the spectrum analyzer as RBW=1kHz, VBW = 3kHz, Span = 10kHz, Sweep = auto.
4. Record the max. reading.

### TEST RESULTS

*No non-compliance noted*

Test Condition	Frequency(MHz)	Occupied Bandwidth 99% (kHz)	20 dB Bandwidth (kHz)
NFC	13.56	2.2286	2.5180

Report No.: T181207W01-RP

## Test Plot

### 20dB Bandwidth

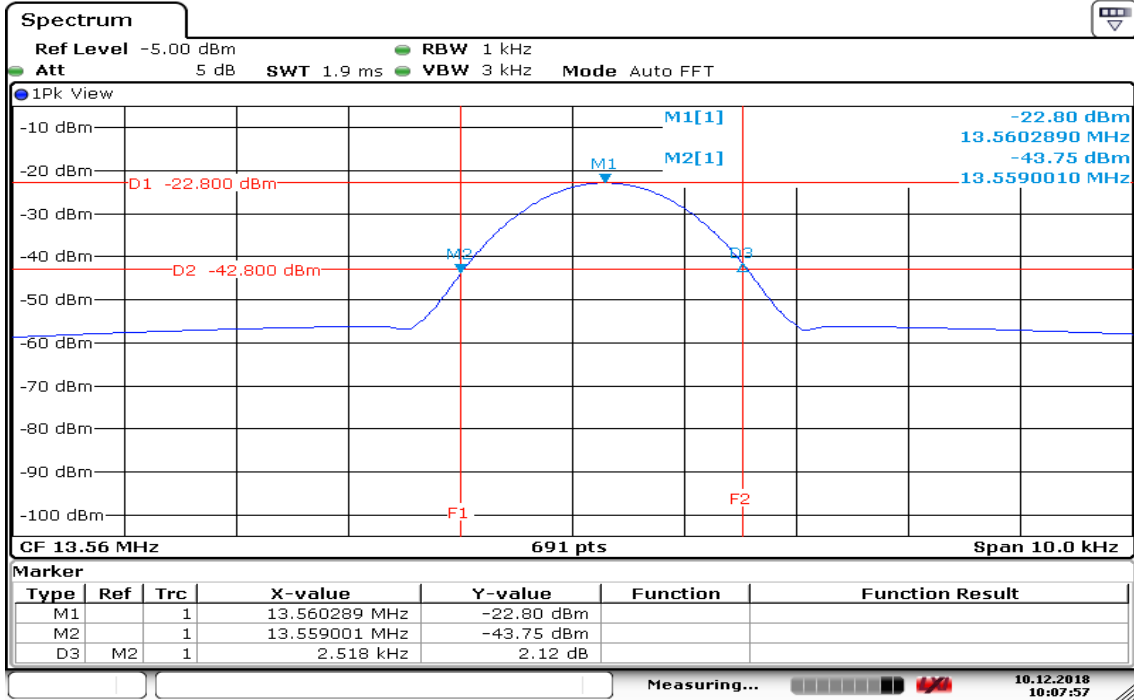

Date: 10.DEC.2018 10:07:58

### 99% Bandwidth

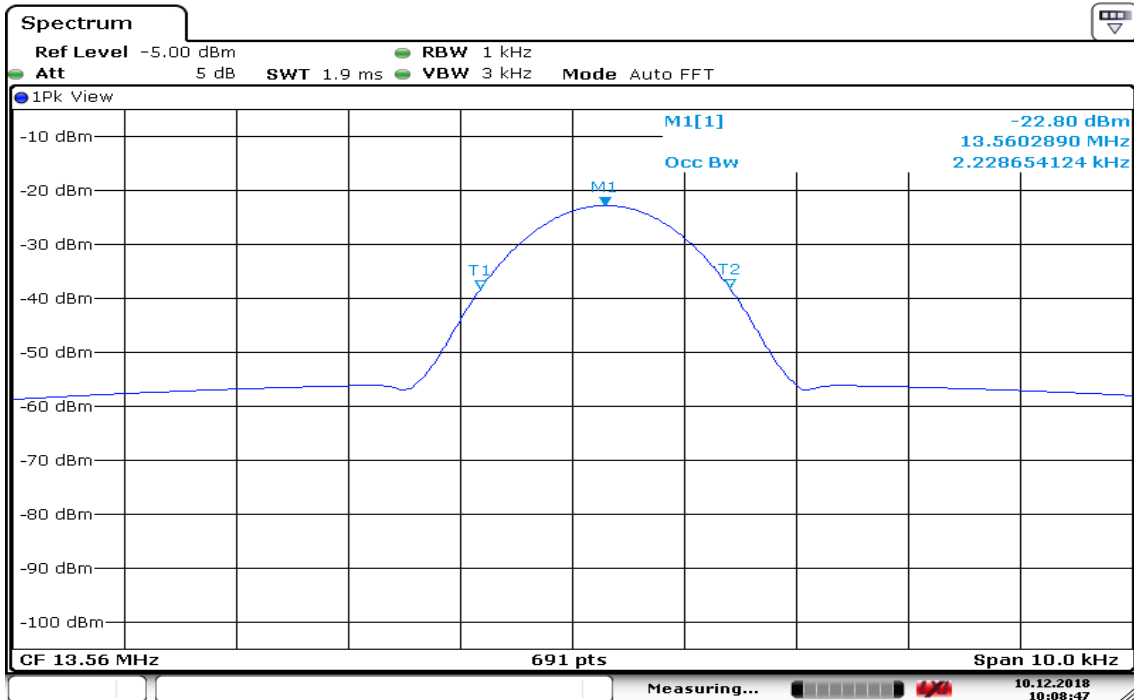

Date: 10.DEC.2018 10:08:47

Report No.: T181207W01-RP

## 8.2 RADIATED EMISSIONS

### LIMIT

According to §15.225

- (a) The field strength of any emissions within the band 13.553 – 13.567 MHz shall not exceed 15,848 microvolts / meter at 30 meters.
- (b) Within the bands 13.410 – 13.553 MHz and 13.567 -13.710 MHz, the field strength of any emissions shall not exceed 334 microvolts / meter at 30 meters.
- (c) Within the bands 13.110 – 13.410 MHz and 13.710 – 14.010 MHz the field strength of any emissions shall not exceed 106 microvolts / meter at 30 meters.
- (d) The field strength of any emissions appearing outside of the 13.110 – 14.010 MHz and shall not exceed the general radiated emission limits in §15.209.

According to §15.225, except as provided elsewhere in this Subpart, the emissions from an intentional radiator shall not exceed the field strength levels specified in the following table:

Frequency (MHz)	Field Strength (µV/m at meter)	Measurement Distance (meter)
0.009 – 0.490	2400 / F (kHz)	300
0.490 – 1.705	24000 / F (kHz)	30
1.705 – 30.0	30	30
30 - 88	100**	3
88-216	150**	3
216-960	200**	3
Above 960	500	3

\*\* Except as provided in paragraph (g), fundamental emissions from intentional radiators operating under this Section shall not be located in the frequency bands 54-72 MHz, 76-88 MHz, 174-216 MHz or 470-806 MHz. However, operation within these frequency bands is permitted under other sections of this Part, e.g., Sections 15.231 and 15.241.



Report No.: T181207W01-RP

According to RSS 210 §B.6

The field strength of any emission shall not exceed the following limits:

- (a) 15.848 mV/m (84 dB $\mu$ V/m) at 30 m, within the band 13.553-13.567 MHz;
- (b) 334  $\mu$ V/m (50.5 dB $\mu$ V/m) at 30 m, within the bands 13.410-13.553 MHz and 13.567-13.710 MHz;
- (c) 106  $\mu$ V/m (40.5 dB $\mu$ V/m) at 30 m, within the bands 13.110-13.410 MHz and 13.710-14.010 MHz; and
- (d) RSS-General field strength limits for frequencies outside the band 13.110-14.010 MHz.

### **Below 30 MHz**

Frequency	Magnetic field strength (H-Field) ( $\mu$ A/m)	Measurement Distance (metres)
9-490 kHz <sup>Note 1</sup>	6.37/F (F in kHz)	300
490-1,705 kHz	63.7/F (F in kHz)	30
1.705-30 MHz	0.08	30

*Note 1: The emission limits for the ranges 9-90 kHz and 110-490 kHz are based on measurements employing a linear average detector.*

### **Above 30 MHz**

Frequency	Field strength ( $\mu$ V/m at 3 m)
30-88	100
88-216	150
216-960	200
Above 960	500

Report No.: T181207W01-RP

## Test Configuration

**9kHz ~ 30MHz**

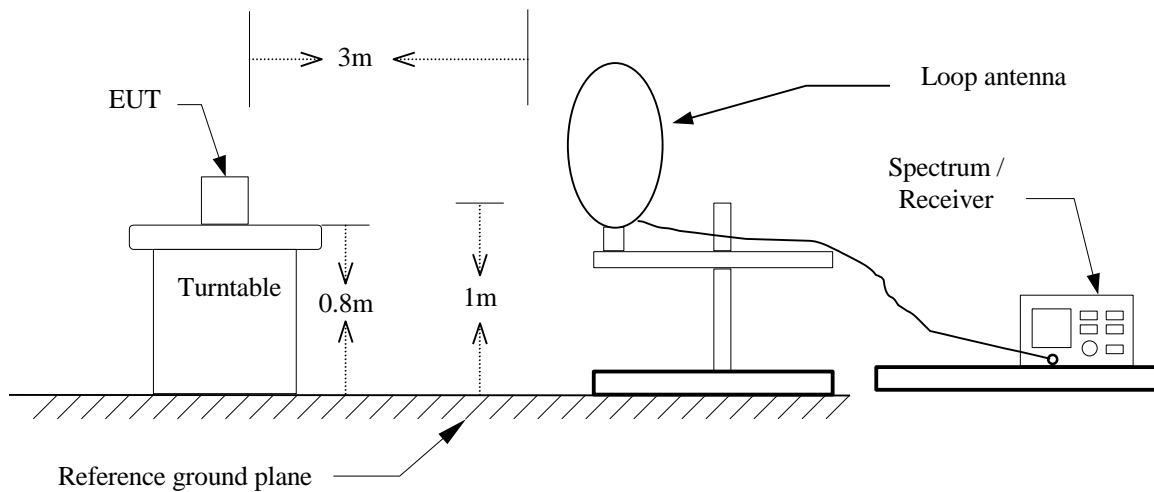

**30MHz ~ 1GHz**

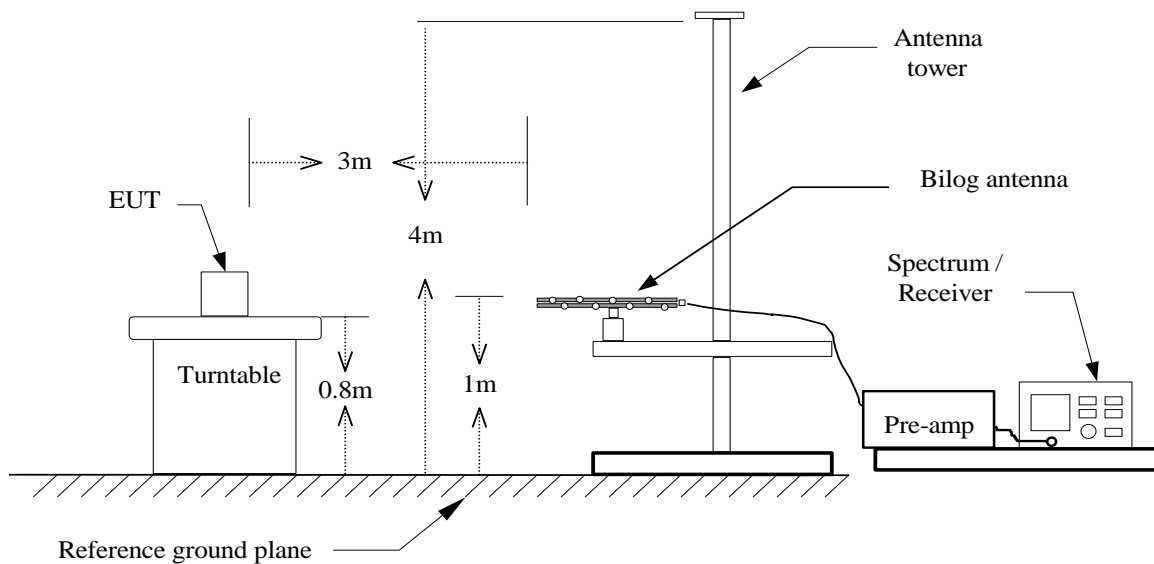

Report No.: T181207W01-RP

## **TEST PROCEDURE**

### **For 9kHz ~ 30MHz**

1. The EUT is placed on a turntable, which is 0.8m above ground plane.
2. The turntable shall be rotated for 360 degrees to determine the position of maximum emission level.
3. EUT is set 3m away from the receiving antenna, The center of the loop shall be 1 m above the ground then to find out the highest emissions.
4. Maximum procedure was performed on the six highest emissions to ensure EUT compliance.
5. Set the spectrum analyzer in the following setting as:  
9KHz-490KHz : RBW=200Hz / VBW=1kHz / Sweep=AUTO  
490KHz-30MHz : RBW=10kHz / VBW=30kHz / Sweep=AUTO
6. Repeat above procedures until the measurements for all frequencies are complete.

### **For 30MHz ~ 1GHz**

1. The EUT is placed on a turntable, which is 0.8m above ground plane.
2. The turntable shall be rotated for 360 degrees to determine the position of maximum emission level.
3. EUT is set 3m away from the receiving antenna, which is varied from 1m to find out the highest emissions.
4. Maximum procedure was performed on the six highest emissions to ensure EUT compliance.
5. And also, each emission was to be maximized by changing the polarization of receiving antenna both horizontal and vertical.
6. Set the spectrum analyzer in the following setting as:  
RBW=100kHz / VBW=300kHz / Sweep=AUTO
7. Repeat above procedures until the measurements for all frequencies are complete.

### *Remark :*

*Although these tests were performed other than open area test site, adequate comparison measurements were confirmed against 30 m open area test site. Therefore sufficient tests were made to demonstrate that the alternative site produces results that correlate with the ones of tests made in an open field based on KDB 414788.*

Report No.: T181207W01-RP

**Operation Mode:** TX mode  
**Temperature:** 23.1°C  
**Humidity:** 55 % RH

**Test Date:** December 12, 2018  
**Tested by:** Jerry Chuang  
**Polarity:** Ver. / Hor.

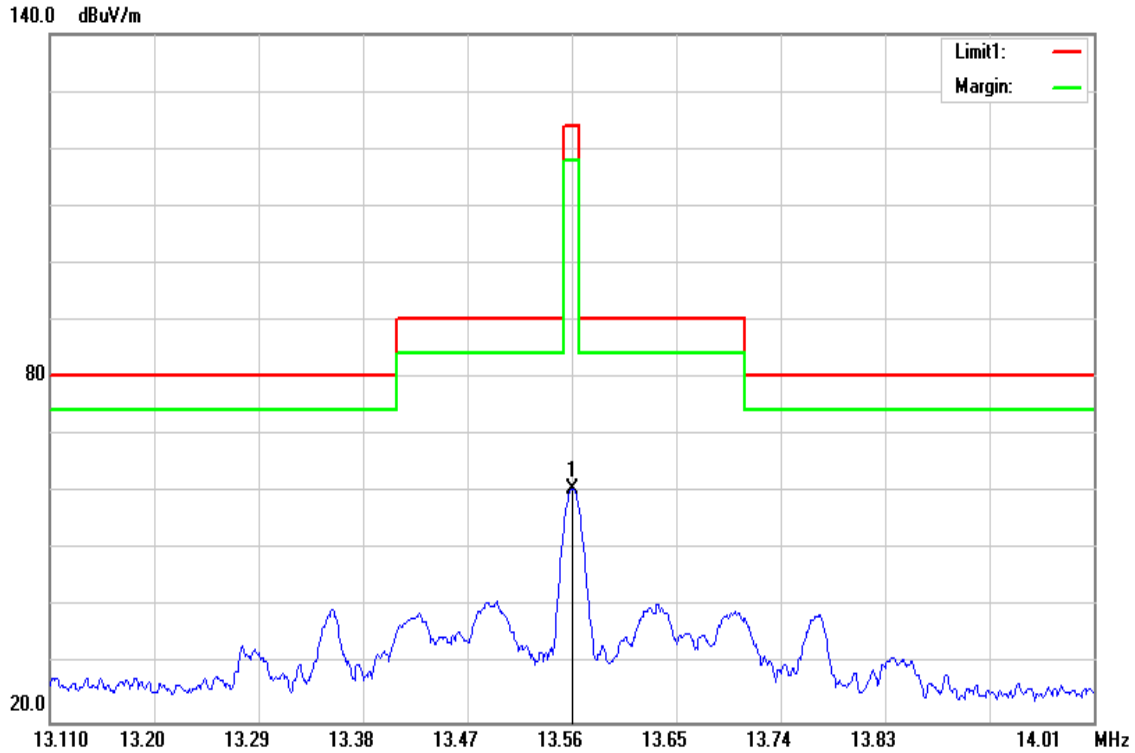

No.	Frequency (MHz)	Reading (dBuV)	Correct Factor(dB/m)	Result (dBuV/m)	Limit (dBuV/m)	Margin (dB)	Remark
1	13.5609	45.26	15.42	60.68	124.00	-63.32	peak

**Remark:**

1. Radiated emissions measured were made with an instrument using peak/quasi-peak/average detector mode.
2. Measurements above show only up to 6 maximum emissions noted, or would be lesser, with " N/A " remark, if no specific emissions from the EUT are recorded (ie: margin>20dB from the applicable limit) and considered that's already beyond the background noise floor.
3. Margin (dB) = Result (dBuV/m) – Limit (dBuV/m).

Report No.: T181207W01-RP

### 9kHz ~ 490kHz

**Operation Mode:** TX mode  
**Temperature:** 23.1°C  
**Humidity:** 55 % RH

**Test Date:** December 12, 2018  
**Tested by:** Jerry Chuang

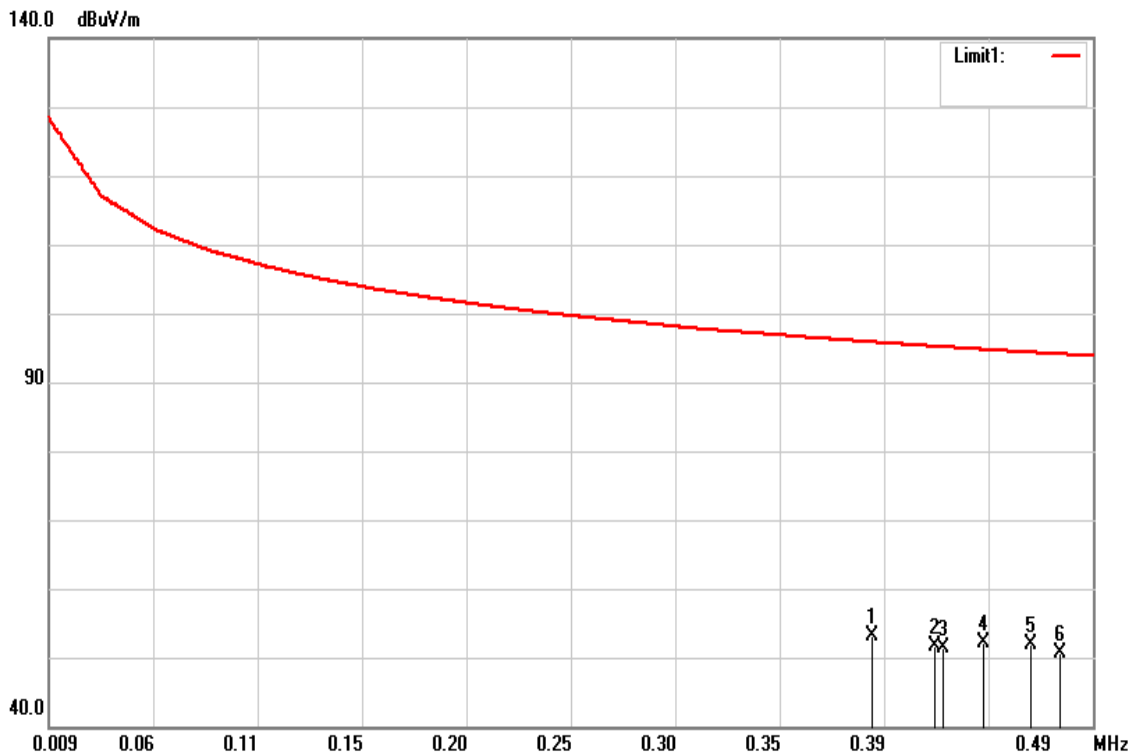

Frequency (MHz)	Reading (dBuV)	Correction Factor (dB/m)	Result (dBuV/m)	Limit (dBuV/m)	Margin (dB)	Detector Mode (PK/QP/AVG)
0.3885	39.15	13.87	53.02	95.80	-42.78	peak
0.4174	37.77	13.88	51.65	95.19	-43.54	peak
0.4212	37.45	13.88	51.33	95.11	-43.78	peak
0.4395	38.18	13.88	52.06	94.73	-42.67	peak
0.4611	38.10	13.88	51.98	94.32	-42.34	peak
0.4751	36.82	13.89	50.71	94.06	-43.35	peak

Report No.: T181207W01-RP

### 490kHz ~ 30MHz

**Operation Mode:** TX mode  
**Temperature:** 23.1°C  
**Humidity:** 55 % RH

**Test Date:** December 12, 2018  
**Tested by:** Jerry Chuang

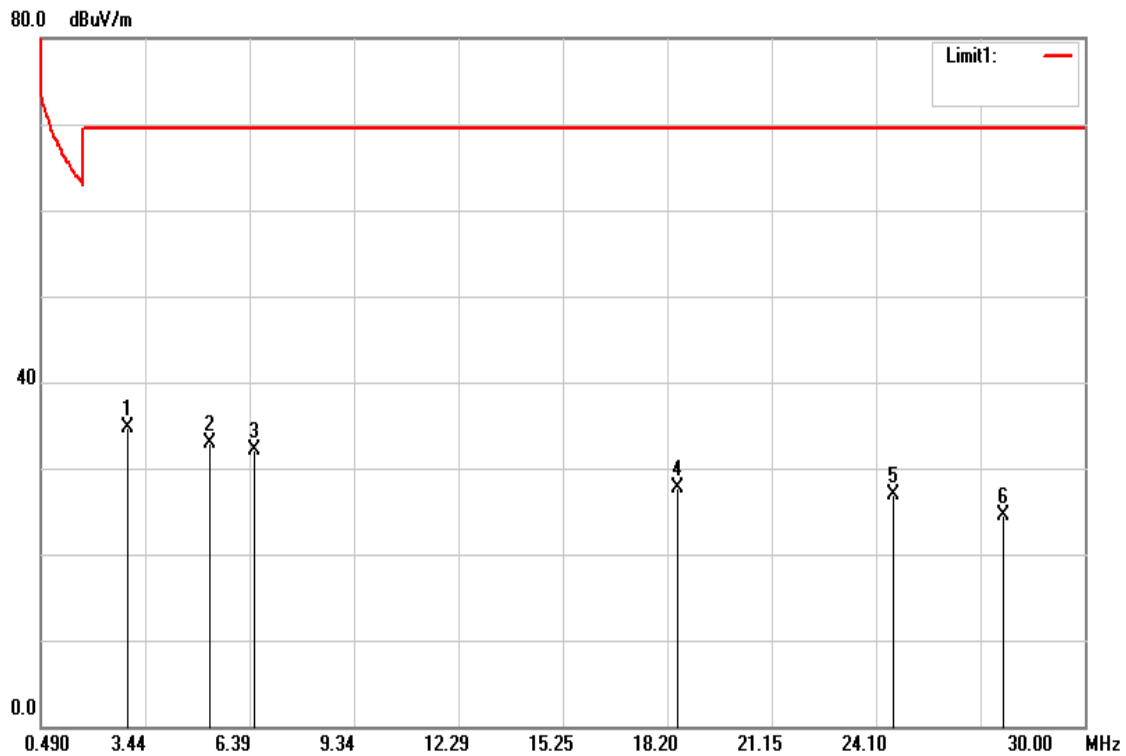

Frequency (MHz)	Reading (dBuV)	Correction Factor (dB/m)	Result (dBuV/m)	Limit (dBuV/m)	Margin (dB)	Detector Mode (PK/QP/AVG)
2.9393	20.22	14.41	34.63	69.54	-34.91	peak
5.2706	18.02	14.86	32.88	69.54	-36.66	peak
6.5396	17.08	15.07	32.15	69.54	-37.39	peak
18.4911	12.53	15.13	27.66	69.54	-41.88	peak
24.5702	12.87	14.01	26.88	69.54	-42.66	peak
27.6982	11.12	13.31	24.43	69.54	-45.11	peak

Report No.: T181207W01-RP

**30MHz ~ 1GHz**

**Operation Mode:** TX mode  
**Temperature:** 23.1°C  
**Humidity:** 55 % RH

**Test Date:** December 12, 2018  
**Tested by:** Jerry Chuang

Frequency (MHz)	Reading (dBuV)	Correction Factor (dB/m)	Result (dBuV/m)	Limit 3m (dBuV/m)	Margin (dB)	Detector Mode (PK/QP/AVG)	Polarity (V/H)
63.9500	53.48	-14.84	38.64	40.00	-1.36	QP	V
95.9600	54.32	-13.11	41.21	43.52	-2.31	QP	V
127.9700	48.99	-8.68	40.31	43.52	-3.21	QP	V
224.0000	50.30	-10.56	39.74	46.02	-6.28	QP	V
320.0300	47.23	-6.90	40.33	46.02	-5.69	QP	V
432.5500	44.33	-3.69	40.64	46.02	-5.38	QP	V
208.4800	51.09	-9.59	41.50	43.52	-2.02	QP	H
272.5000	52.18	-8.21	43.97	46.02	-2.05	QP	H
304.5100	50.22	-7.37	42.85	46.02	-3.17	QP	H
400.5400	44.43	-4.78	39.65	46.02	-6.37	QP	H
496.5700	38.39	-2.27	36.12	46.02	-9.90	peak	H
623.6400	33.20	0.11	33.31	46.02	-12.71	peak	H

Report No.: T181207W01-RP

## Vertical

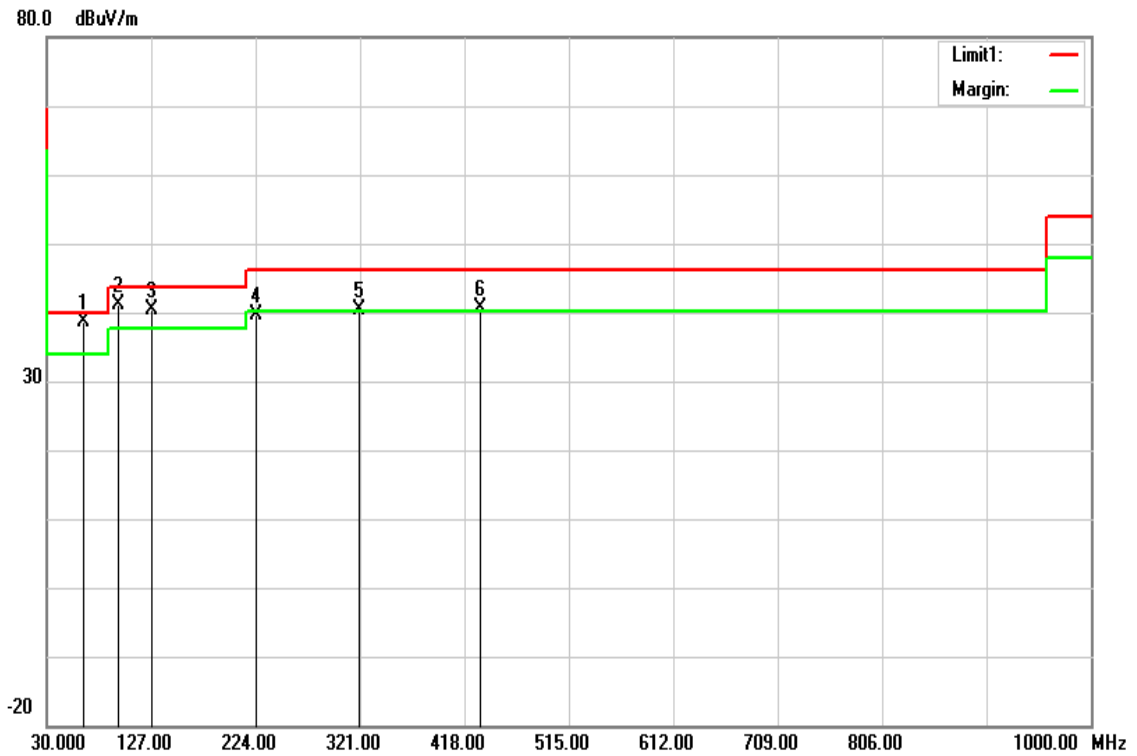

## Horizontal

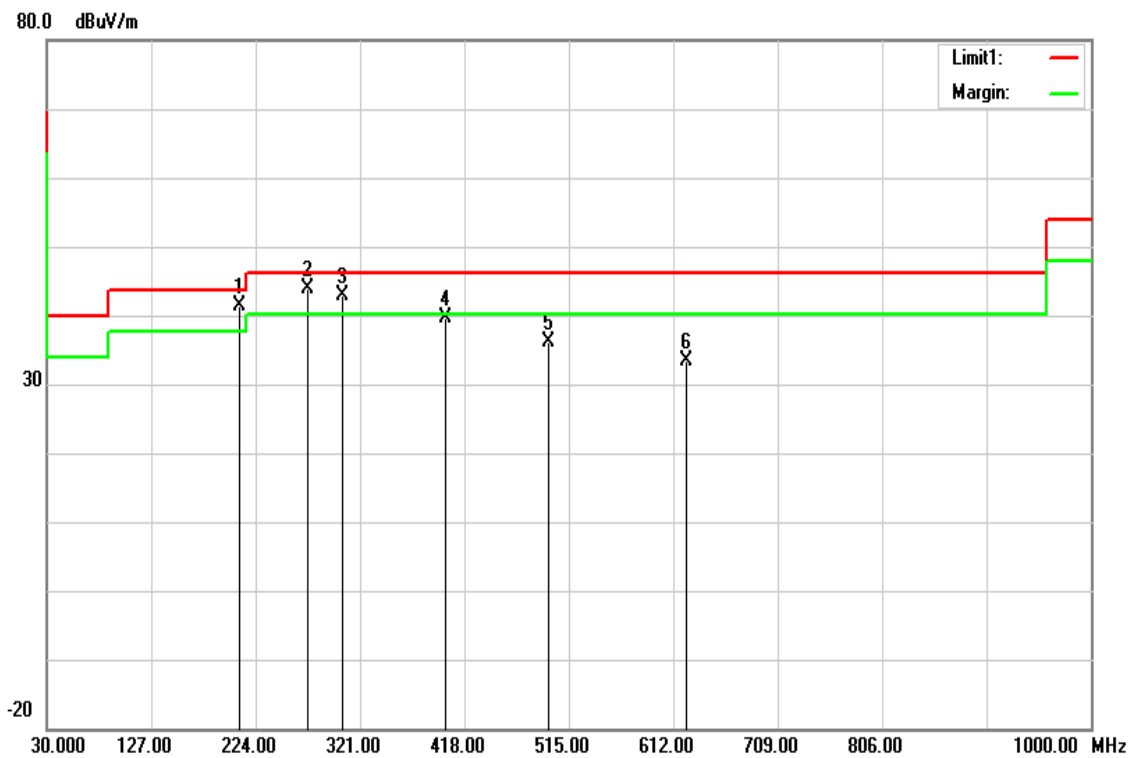



## 8.3 FREQUENCY STABILITY

### LIMIT

According to §15.225(e) and RSS-210, B.6, The frequency tolerance of the carrier signal shall be maintained within +/- 0.01% of the operating frequency over a temperature variation of -40 degrees to +75 degrees C at normal supply voltage, and for a variation in the primary supply voltage from 85% to 115% of the rated supply voltage at a temperature of 20 degrees C. For battery operated equipment, the equipment tests shall be performed using a new battery.

### Test Configuration

#### Temperature and Voltage Measurement (under normal and extreme test conditions)

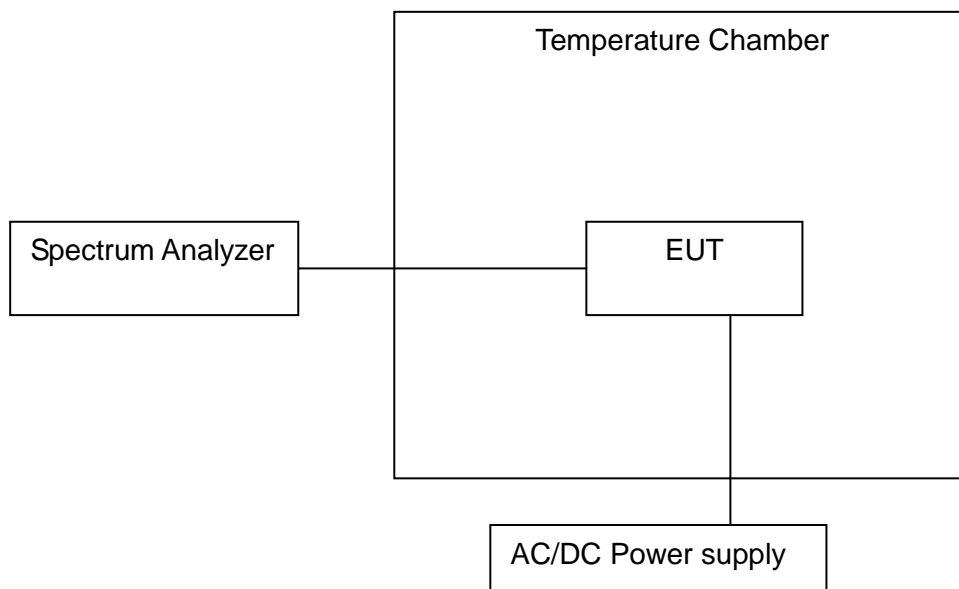

### TEST PROCEDURE

1. Turn the EUT off, and place it inside the environmental temperature chamber.
2. Set the temperature control on the chamber to the highest specified in the regulatory requirements for the type of device and allow the oscillator heater and the chamber temperature to stabilize.
3. Set the spectrum analyzer as RBW=1kHz, VBW = RBW, Span = 200kHz, Sweep = auto.
4. Turn the EUT on and record the operating frequency at startup and two, five, and ten minutes after the EUT is energized.
5. Switch off the EUT and Lower the chamber temperature by not more than 10 °C and allow the temperature inside the chamber to stabilize.
6. Mark the peak frequency and measure the frequency tolerance using frequency counter function.
7. Repeat step 4 through step 6 down to the lowest specified temperature.

Report No.: T181207W01-RP

## TEST RESULTS

*No non-compliance noted.*

## TEST DATA

Condition			Frequency Error (ppm)										Result
Temperature	Modulation Mode	Test Freq.	0 min	2 min	5 min	10 min	0 min	2 min	5 min	10 min	Limit (ppm)		
<b>Normal</b>													
T <sub>20°C</sub> V <sub>max</sub>	CW	13.56	13.560430	13.560430	13.560430	13.560430	31.71	31.71	31.71	31.71	100	Pass	
T <sub>20°C</sub> V <sub>min</sub>	CW	13.56	13.560430	13.560430	13.560430	13.560430	31.71	31.71	31.71	31.71		Pass	
<b>Extreme</b>													
T <sub>75°C</sub> V <sub>nom</sub>	CW	13.56	13.560430	13.560430	13.560430	13.560430	31.71	31.71	31.71	31.71	100	Pass	
T <sub>70°C</sub> V <sub>nom</sub>	CW	13.56	13.560430	13.560430	13.560430	13.560430	31.71	31.71	31.71	31.71		Pass	
T <sub>60°C</sub> V <sub>nom</sub>	CW	13.56	13.560430	13.560430	13.560430	13.560430	31.71	31.71	31.71	31.71		Pass	
T <sub>50°C</sub> V <sub>nom</sub>	CW	13.56	13.560430	13.560430	13.560430	13.560430	31.71	31.71	31.71	31.71		Pass	
T <sub>40°C</sub> V <sub>nom</sub>	CW	13.56	13.560430	13.560430	13.560430	13.560430	31.71	31.71	31.71	31.71		Pass	
T <sub>30°C</sub> V <sub>nom</sub>	CW	13.56	13.560430	13.560430	13.560430	13.560430	31.71	31.71	31.71	31.71		Pass	
T <sub>20°C</sub> V <sub>nom</sub>	CW	13.56	13.560430	13.560430	13.560430	13.560430	31.71	31.71	31.71	31.71		Pass	
T <sub>10°C</sub> V <sub>nom</sub>	CW	13.56	13.560430	13.560430	13.560430	13.560430	31.71	31.71	31.71	31.71		Pass	
T <sub>0°C</sub> V <sub>nom</sub>	CW	13.56	13.560430	13.560430	13.560430	13.560430	31.71	31.71	31.71	31.71		Pass	
T <sub>-10°C</sub> V <sub>nom</sub>	CW	13.56	13.560430	13.560430	13.560430	13.560430	31.71	31.71	31.71	31.71		Pass	
T <sub>-20°C</sub> V <sub>nom</sub>	CW	13.56	13.560430	13.560430	13.560430	13.560430	31.71	31.71	31.71	31.71		Pass	
T <sub>-30°C</sub> V <sub>nom</sub>	CW	13.56	13.560430	13.560430	13.560430	13.560430	31.71	31.71	31.71	31.71		Pass	
T <sub>-40°C</sub> V <sub>nom</sub>	CW	13.56	13.560430	13.560430	13.560430	13.560430	31.71	31.71	31.71	31.71	Pass		

Remark: V<sub>nom</sub>: 12  
V<sub>max</sub>: 13.2  
V<sub>min</sub>: 10.8

## 8.4 POWERLINE CONDUCTED EMISSIONS

### LIMIT

According to §15.207(a), for an intentional radiator that is designed to be connected to the public utility (AC) power line, the radio frequency voltage that is conducted back onto the AC power line on any frequency or frequencies within the band 150 kHz to 30 MHz shall not exceed the limits in the following table, as measured using a 50  $\mu$ H/50 ohms line impedance stabilization network (LISN). Compliance with the provisions of this paragraph shall be based on the measurement of the radio frequency voltage between each power line and ground at the power terminal. The lower limit applies at the boundary between the frequency ranges.

Frequency Range (MHz)	Limits (dB $\mu$ V)	
	Quasi-peak	Average
0.15 to 0.50	66 to 56*	56 to 46*
0.50 to 5	56	46
5 to 30	60	50

\* Decreases with the logarithm of the frequency.

### TEST PROCEDURE

1. The EUT was placed on a table, which is 0.8m above ground plane.
2. Maximum procedure was performed on the six highest emissions to ensure EUT compliance.
3. Repeat above procedures until all frequency measured were complete.

### TEST RESULTS

***Not applicable, because EUT not connect to AC Main Source direct.***

***- End of Test Report -***