

FCC Test Report (Part 22)

Report No.: RF190315C13

FCC ID: LHJ-BL28RW001

Test Model: BL28RW-001

Received Date: Mar. 15, 2019

Test Date: Mar. 29 ~ Apr. 08, 2019

Issued Date: Apr. 16, 2019

Applicant: Continental Automotive Systems

Address: 21440 West Lake Cook Road Deer Park, IL 60010 United States

Issued By: Bureau Veritas Consumer Products Services (H.K.) Ltd., Taoyuan Branch

Lab Address: No. 47-2, 14th Ling, Chia Pau Vil., Lin Kou Dist., New Taipei City, Taiwan (R.O.C.)

Test Location: No. 19, Hwa Ya 2nd Rd., Wen Hwa Vil., Kwei Shan Dist., Taoyuan City 33383, TAIWAN (R.O.C.)

FCC Registration / 788550 / TW0003

Designation Number:



This report is for your exclusive use. Any copying or replication of this report to or for any other person or entity, or use of our name or trademark, is permitted only with our prior written permission. This report sets forth our findings solely with respect to the test samples identified herein. The results set forth in this report are not indicative or representative of the quality or characteristics of the lot from which a test sample was taken or any similar or identical product specifically and expressly noted. Our report includes all of the tests requested by you and the results thereof based upon the information that you provided to us. You have 60 days from date of issuance of this report to notify us of any material error or omission caused by our negligence, provided, however, that such notice shall be in writing and shall specifically address the issue you wish to raise. A failure to raise such issue within the prescribed time shall constitute your unqualified acceptance of the completeness of this report, the tests conducted and the correctness of the report contents. Unless specific mention, the uncertainty of measurement has been explicitly taken into account to declare the compliance or non-compliance to the specification. The report must not be used by the client to claim product certification, approval, or endorsement by TAF or any government agencies

Table of Contents

Release Control Record	4
1 Certificate of Conformity	5
2 Summary of Test Results	6
2.1 Measurement Uncertainty.....	6
2.2 Test Site and Instruments.....	7
3 General Information	8
3.1 General Description of EUT.....	8
3.2 Configuration of System under Test.....	9
3.2.1 Description of Support Units.....	9
3.3 Test Mode Applicability and Tested Channel Detail.....	10
3.4 EUT Operating Conditions.....	14
3.5 General Description of Applied Standards.....	14
4 Test Types and Results	15
4.1 Output Power Measurement.....	15
4.1.1 Limits of Output Power Measurement.....	15
4.1.2 Test Procedures.....	15
4.1.3 Test Setup.....	16
4.1.4 Test Results.....	17
4.2 Modulation Characteristics Measurement.....	36
4.2.1 Limits of Modulation Characteristics.....	36
4.2.2 Test Procedure.....	36
4.2.3 Test Setup.....	36
4.2.4 Test Results.....	37
4.3 Frequency Stability Measurement.....	40
4.3.1 Limits of Frequency Stability Measurement.....	40
4.3.2 Test Procedure.....	40
4.3.3 Test Setup.....	40
4.3.4 Test Results.....	41
4.4 Occupied Bandwidth Measurement.....	48
4.4.1 Test Procedure.....	48
4.4.2 Test Setup.....	48
4.4.3 Test Result.....	49
4.5 Band Edge Measurement.....	57
4.5.1 Limits of Band Edge Measurement.....	57
4.5.2 Test Setup.....	57
4.5.3 Test Procedures.....	57
4.5.4 Test Results.....	58
4.6 Peak to Average Ratio.....	64
4.6.1 Limits of Peak to Average Ratio Measurement.....	64
4.6.2 Test Setup.....	64
4.6.3 Test Procedures.....	64
4.6.4 Test Results.....	65
4.7 Conducted Spurious Emissions.....	69
4.7.1 Limits of Conducted Spurious Emissions Measurement.....	69
4.7.2 Test Setup.....	69
4.7.3 Test Procedure.....	69
4.7.4 Test Results.....	70
4.8 Radiated Emission Measurement.....	100
4.8.1 Limits of Radiated Emission Measurement.....	100
4.8.2 Test Procedure.....	100
4.8.3 Deviation from Test Standard.....	100
4.8.4 Test Setup.....	101
4.8.5 Test Results.....	102

5	Pictures of Test Arrangements.....	122
	Appendix – Information on the Testing Laboratories	123

Release Control Record

Issue No.	Description	Date Issued
RF190315C13	Original release	Apr. 16, 2019

1 Certificate of Conformity

Product: BL28RW-001 Module

Brand: Continental

Test Model: BL28RW-001

Sample Status: Engineering sample

Applicant: Continental Automotive Systems

Test Date: Mar. 29 ~ Apr. 08, 2019

Standards: FCC Part 22, Subpart H

The above equipment has been tested by **Bureau Veritas Consumer Products Services (H.K.) Ltd., Taoyuan Branch**, and found compliance with the requirement of the above standards. The test record, data evaluation & Equipment Under Test (EUT) configurations represented herein are true and accurate accounts of the measurements of the sample's RF characteristics under the conditions specified in this report.

Prepared by : Pettie Chen , **Date:** Apr. 16, 2019
Pettie Chen / Senior Specialist

Approved by : Bruce Chen , **Date:** Apr. 16, 2019
Bruce Chen / Project Engineer

2 Summary of Test Results

Applied Standard: FCC Part 22 & Part 2			
FCC Clause	Test Item	Result	Remarks
2.1046 22.913 (a)	Effective radiated power	Pass	Meet the requirement of limit.
2.1047	Modulation Characteristics	Pass	Meet the requirement
22.913 (d)	Peak To Average Ratio	Pass	Meet the requirement of limit.
2.1055 22.355	Frequency Stability	Pass	Meet the requirement of limit.
2.1049	Occupied Bandwidth	Pass	Meet the requirement of limit.
22.917	Band Edge Measurements	Pass	Meet the requirement of limit.
2.1051 22.917	Conducted Spurious Emissions	Pass	Meet the requirement of limit.
2.1053 22.917	Radiated Spurious Emissions	Pass	Meet the requirement of limit. Minimum passing margin is -38.1dB at 65.89MHz.

Note: Determining compliance based on the results of the compliance measurement, not taking into account measurement instrumentation uncertainty.

2.1 Measurement Uncertainty

Where relevant, the following measurement uncertainty levels have been estimated for tests performed on the EUT as specified in CISPR 16-4-2:

Measurement	Frequency	Expanded Uncertainty (k=2) (\pm)
Radiated Emissions up to 1 GHz	9kHz ~ 30MHz	3.04 dB
	30MHz ~ 200MHz	3.59 dB
	200MHz ~ 1000MHz	3.60 dB
Radiated Emissions above 1 GHz	1GHz ~ 18GHz	2.29 dB
	18GHz ~ 40GHz	2.29 dB

2.2 Test Site and Instruments

Description & Manufacturer	Model No.	Serial No.	Cal. Date	Cal. Due
Test Receiver KEYSIGHT	N9038A	MY55420137	Apr. 11, 2018	Apr. 10, 2019
Spectrum Analyzer ROHDE & SCHWARZ	FSP40	100269	May 29, 2018	May 28, 2019
BILOG Antenna SCHWARZBECK	VULB9168	9168-160	Nov. 21, 2018	Nov. 20, 2019
HORN Antenna SCHWARZBECK	BBHA 9120 D	9120D-1169	Nov. 25, 2018	Nov. 24, 2019
HORN Antenna SCHWARZBECK	BBHA 9170	BBHA9170241	Nov. 25, 2018	Nov. 24, 2019
Loop Antenna TESEQ	HLA 6121	45745	Jun. 14, 2018	Jun. 13, 2019
Preamplifier Agilent (Below 1GHz)	8447D	2944A10638	Aug. 08, 2018	Aug. 07, 2019
Preamplifier Agilent (Above 1GHz)	8449B	3008A02367	Feb. 19, 2019	Feb. 18, 2020
RF signal cable HUBER+SUHNER&EMCI	SUCOFLEX 104 & EMC104-SM-SM80 00	CABLE-CH9-02 (248780+171006)	Jan. 19, 2019	Jan. 18, 2020
RF signal cable HUBER+SUHNER	SUCOFLEX 104	CABLE-CH9-(250795/4)	Aug. 08, 2018	Aug. 07, 2019
RF signal cable Woken	8D-FB	Cable-CH9-01	Jul. 31, 2018	Jul. 30, 2019
Software BV ADT	ADT_Radiated_ V7.6.15.9.5	NA	NA	NA
Antenna Tower EMCO	2070/2080	512.835.4684	NA	NA
Turn Table EMCO	2087-2.03	NA	NA	NA
Antenna Tower & Turn BV ADT	AT100	AT93021705	NA	NA
Turn Table BV ADT	TT100	TT93021705	NA	NA
Turn Table Controller BV ADT	SC100	SC93021705	NA	NA
Boresight Antenna Fixture	FBA-01	FBA-SIP01	NA	NA
Pre-amplifier (18GHz-40GHz) EMC	EMC184045B	980175	Nov. 14, 2018	Nov. 13, 2019
WIT Standard Temperature And Humidity Chamber	TH-4S-C	W981030	Jun. 04, 2018	Jun. 03, 2019
JFW 20dB attenuation	50HF-020-SMA	NA	NA	NA

- Note: 1. The calibration interval of the above test instruments is 12 months and the calibrations are traceable to NML/ROC and NIST/USA.
 2. The test was performed in HwaYa Chamber 9.
 3. The FCC Designation Number is TW0003. The number will be varied with the Lab location and scope as attached.
 4. The IC Site Registration No. is 7450F-9.

3 General Information

3.1 General Description of EUT

Product	BL28RW-001 Module			
Brand	Continental			
Test Model	BL28RW-001			
Sample Status	Engineering sample			
Power Supply Rating	3.6 Vdc (Power supply)			
Modulation Type	GSM, GPRS: GMSK EDGE: 8PSK WCDMA: BPSK, QPSK HSDPA: BPSK HSUPA: QPSK LTE: QPSK, 16QAM, 64QAM			
Operating Frequency	GSM/GPRS/EDGE	824.2~848.8MHz		
	WCDMA Band 5	826.4~846.6MHz		
	LTE Band 5 (Channel Bandwidth 1.4MHz)	824.7~848.3MHz		
	LTE Band 5 (Channel Bandwidth 3MHz)	825.5~847.5MHz		
	LTE Band 5 (Channel Bandwidth 5MHz)	826.5~846.5MHz		
	LTE Band 5 (Channel Bandwidth 10MHz)	829.0~844.0MHz		
Max. ERP Power	GSM	2041.738mW (33.1dBm)		
	WCDMA Band 5	398.107mW (26.0dBm)		
		QPSK	16QAM	64QAM
	LTE Band 5 (Channel Bandwidth 1.4MHz)	181.970mW (22.6dBm)	144.544mW (21.6dBm)	128.825mW (21.1dBm)
	LTE Band 5 (Channel Bandwidth 3MHz)	194.984mW (22.9dBm)	154.881mW (21.9dBm)	141.254mW (21.5dBm)
	LTE Band 5 (Channel Bandwidth 5MHz)	229.087mW (23.6dBm)	134.896mW (21.3dBm)	123.027mW (20.9dBm)
	LTE Band 5 (Channel Bandwidth 10MHz)	194.984mW (22.9dBm)	131.826mW (21.2dBm)	125.892mW (21.0dBm)
Emission Designator	GSM/GPRS	260KGXW		
	EDGE	250KG7W		
	WCDMA Band 5	4M16F9W		
		QPSK	16QAM	64QAM
	LTE Band 5 (Channel Bandwidth 1.4MHz)	1M09G7D	1M09D7W	1M09D7W
	LTE Band 5 (Channel Bandwidth 3MHz)	2M70G7D	2M70D7W	2M70D7W
	LTE Band 5 (Channel Bandwidth 5MHz)	4M49G7D	4M49D7W	4M49D7W
	LTE Band 5 (Channel Bandwidth 10MHz)	8M97G7D	8M97D7W	8M96D7W
Antenna Type	Dipole antenna with 2dBi gain			
Antenna Connector	SMA Male			
Accessory Device	NA			
Cable Supplied	NA			

3.2 Configuration of System under Test

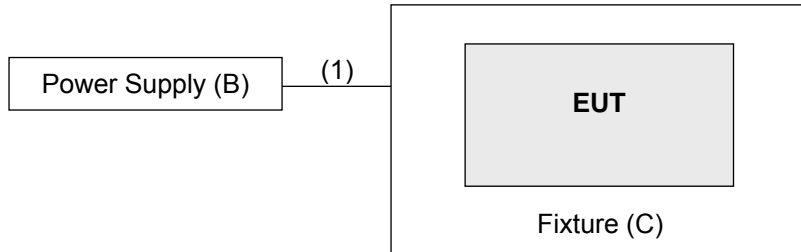

Remote site

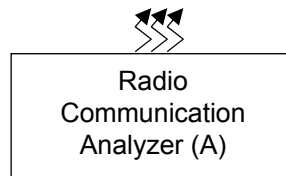

3.2.1 Description of Support Units

The EUT has been tested as an independent unit together with other necessary accessories or support units. The following support units or accessories were used to form a representative test configuration during the tests.

ID	Product	Brand	Model No.	Serial No.	FCC ID	Remarks
A.	Radio Communication Analyzer	Anritsu	MT8860C	1702001	NA	-
B.	DC power supply	Keysight	U8002A	MY56330015	NA	-
C.	Fixture	NA	NA	NA	NA	Provided by manufacturer

Note:

1. All power cords of the above support units are non-shielded (1.8m).
2. Item A acted as a communication partner to transfer data.

ID	Descriptions	Qty.	Length (m)	Shielding (Yes/No)	Cores (Qty.)	Remarks
1.	Power cable	1	2	N	0	-

3.3 Test Mode Applicability and Tested Channel Detail

Pre-Scan has been conducted to determine the worst-case mode from all possible combinations between available modulations, data rates, XYZ axis and antenna ports. The worst case was found when positioned on Z-plane. Following channel(s) was (were) selected for the final test as listed below.

GSM Mode

EUT Configure Mode	Test Item	Available Channel	Tested Channel	Mode
-	ERP	128 to 251	128(824.2MHz), 189(836.4MHz), 251(848.8MHz)	GSM
-	Modulation Characteristics	128 to 251	128(824.2MHz)	GSM, GPRS, EDGE
-	Frequency Stability	128 to 251	128(824.2MHz), 251(848.8MHz)	GSM, EDGE
-	Occupied Bandwidth	128 to 251	128(824.2MHz), 189(836.4MHz), 251(848.8MHz)	GSM, GPRS, EDGE
-	Band Edge	128 to 251	128(824.2MHz), 251(848.8MHz)	GSM, GPRS, EDGE
-	Peak To Average Ratio	128 to 251	128(824.2MHz), 189(836.4MHz), 251(848.8MHz)	GSM, GPRS, EDGE
-	Conducted Emission	128 to 251	128(824.2MHz), 189(836.4MHz), 251(848.8MHz)	GSM, GPRS, EDGE
-	Radiated Emission Below 1GHz	128 to 251	128(824.2MHz)	GSM
-	Radiated Emission Above 1GHz	128 to 251	128(824.2MHz), 189(836.4MHz), 251(848.8MHz)	GSM

Note: For radiated emission below 1GHz, low, mid and high channels were pre-tested E.R.P. in chamber. Low channel was found to be the worst case and therefore had been chosen for all final tests.

WCDMA Band 5

EUT Configure Mode	Test Item	Available Channel	Tested Channel	Mode
-	ERP	4132 to 4233	4132 (826.4MHz), 4182 (836.4MHz), 4233 (846.6MHz)	WCDMA
-	Modulation Characteristics	4132 to 4233	4182 (836.4MHz)	WCDMA, HSDPA, HSUPA
-	Frequency Stability	4132 to 4233	4132 (826.4MHz), 4233 (846.6MHz)	WCDMA
-	Occupied Bandwidth	4132 to 4233	4132 (826.4MHz), 4182 (836.4MHz), 4233 (846.6MHz)	WCDMA, HSDPA, HSUPA
-	Band Edge	4132 to 4233	4132 (826.4MHz), 4233 (846.6MHz)	WCDMA, HSDPA, HSUPA
-	Peak To Average Ratio	4132 to 4233	4132 (826.4MHz), 4182 (836.4MHz), 4233 (846.6MHz)	WCDMA, HSDPA, HSUPA
-	Conducted Emission	4132 to 4233	4132 (826.4MHz), 4182 (836.4MHz), 4233 (846.6MHz)	WCDMA, HSDPA, HSUPA
-	Radiated Emission Below 1GHz	4132 to 4233	4132 (826.4MHz)	WCDMA
-	Radiated Emission Above 1GHz	4132 to 4233	4132 (826.4MHz), 4182 (836.4MHz), 4233 (846.6MHz)	WCDMA

Note: For radiated emission below 1GHz, low, mid and high channels were pre-tested E.R.P. in chamber. Low channel was found to be the worst case and therefore had been chosen for all final tests.

LTE Band 5

EUT Configure Mode	Test item	Available channel	Tested channel	Channel Bandwidth	Modulation	Mode
-	ERP	20407 to 20643	20407(824.7MHz), 20525(836.5MHz), 20643(848.3MHz)	1.4MHz	QPSK / 16QAM / 64QAM	1 RB / 0 RB Offset
		20415 to 20635	20415(825.5MHz), 20525(836.5MHz), 20635(847.5MHz)	3MHz	QPSK / 16QAM / 64QAM	1 RB / 0 RB Offset
		20425 to 20625	20425(826.5MHz), 20525(836.5MHz), 20625(846.5MHz)	5MHz	QPSK / 16QAM / 64QAM	1 RB / 0 RB Offset
		20450 to 20600	20450(829.0MHz), 20525(836.5MHz), 20600(844.0MHz)	10MHz	QPSK / 16QAM / 64QAM	1 RB / 0 RB Offset
-	Modulation characteristics	20450 to 20600	20525(836.5MHz)	10MHz	QPSK / 16QAM / 64QAM	50 RB / 0 RB Offset
-	Frequency Stability	20407 to 20643	20407(824.7MHz), 20643(848.3MHz)	1.4MHz	QPSK	1 RB / 0 RB Offset
		20415 to 20635	20415(825.5MHz), 20635(847.5MHz)	3MHz	QPSK	1 RB / 0 RB Offset
		20425 to 20625	20425(826.5MHz), 20625(846.5MHz)	5MHz	QPSK	1 RB / 0 RB Offset
		20450 to 20600	20450(829.0MHz), 20600(844.0MHz)	10MHz	QPSK	1 RB / 0 RB Offset
-	Occupied Bandwidth	20407 to 20643	20407(824.7MHz), 20525(836.5MHz), 20643(848.3MHz)	1.4MHz	QPSK / 16QAM / 64QAM	6 RB / 0RB Offset
		20415 to 20635	20415(825.5MHz), 20525(836.5MHz), 20635(847.5MHz)	3MHz	QPSK / 16QAM / 64QAM	15 RB / 0RB Offset
		20425 to 20625	20425(826.5MHz), 20525(836.5MHz), 20625(846.5MHz)	5MHz	QPSK / 16QAM / 64QAM	25RB / 0RB Offset
		20450 to 20600	20450(829.0MHz), 20525(836.5MHz), 20600(844.0MHz)	10MHz	QPSK / 16QAM / 64QAM	50RB / 0RB Offset
-	Band Edge	20407 to 20643	20407(824.7MHz), 20643(848.3MHz)	1.4MHz	QPSK	1 RB / 0 RB Offset 1 RB / 5 RB Offset 6 RB / 0 RB Offset
		20415 to 20635	20415(825.5MHz), 20635(847.5MHz)	3MHz	QPSK	1 RB / 0 RB Offset 1 RB / 14 RB Offset 15 RB / 0 RB Offset
		20425 to 20625	20425(826.5MHz), 20625(846.5MHz)	5MHz	QPSK	1 RB / 0 RB Offset 1 RB / 24 RB Offset 25 RB / 0 RB Offset
		20450 to 20600	20450(829.0MHz), 20600(844.0MHz)	10MHz	QPSK	1 RB / 0 RB Offset 1 RB / 49 RB Offset 50 RB / 0 RB Offset

EUT Configure Mode	Test item	Available channel	Tested channel	Channel Bandwidth	Modulation	Mode
-	Peak to Average Ratio	20407 to 20643	20407(824.7MHz), 20525(836.5MHz), 20643(848.3MHz)	1.4MHz	QPSK / 16QAM / 64QAM	1 RB / 0 RB Offset
		20415 to 20635	20415(825.5MHz), 20525(836.5MHz), 20635(847.5MHz)	3MHz	QPSK / 16QAM / 64QAM	1 RB / 0 RB Offset
		20425 to 20625	20425(826.5MHz), 20525(836.5MHz), 20625(846.5MHz)	5MHz	QPSK / 16QAM / 64QAM	1 RB / 0 RB Offset
		20450 to 20600	20450(829.0MHz), 20525(836.5MHz), 20600(844.0MHz)	10MHz	QPSK / 16QAM / 64QAM	1 RB / 0 RB Offset
-	Conducted Emission	20407 to 20643	20407(824.7MHz), 20525(836.5MHz), 20643(848.3MHz)	1.4MHz	QPSK	1 RB / 0 RB Offset
		20415 to 20635	20415(825.5MHz), 20525(836.5MHz), 20635(847.5MHz)	3MHz	QPSK	1 RB / 0 RB Offset
		20425 to 20625	20425(826.5MHz), 20525(836.5MHz), 20625(846.5MHz)	5MHz	QPSK	1 RB / 0 RB Offset
		20450 to 20600	20450(829.0MHz), 20525(836.5MHz), 20600(844.0MHz)	10MHz	QPSK	1 RB / 0 RB Offset
-	Radiated Emission Below 1GHz	20407 to 20643	20407(824.7MHz)	1.4MHz	QPSK	1 RB / 0 RB Offset
		20425 to 20625	20425(826.5MHz)	5MHz	QPSK	1 RB / 0 RB Offset
		20450 to 20600	20450(829.0MHz)	10MHz	QPSK	1 RB / 0 RB Offset
-	Radiated Emission Above 1GHz	20407 to 20643	20407(824.7MHz), 20525(836.5MHz), 20643(848.3MHz)	1.4MHz	QPSK	1 RB / 0 RB Offset
		20425 to 20625	20425(826.5MHz), 20525(836.5MHz), 20625(846.5MHz)	5MHz	QPSK	1 RB / 0 RB Offset
		20450 to 20600	20450(829.0MHz), 20525(836.5MHz), 20600(844.0MHz)	10MHz	QPSK	1 RB / 0 RB Offset

Note:

1. For radiated emission below 1GHz, low, mid and high channels were pre-tested in chamber with 1.4MHz mode. Low channel was found to be the worst case and therefore had been chosen for all final tests.
2. For radiated emission above 1GHz, according to 3GPP 36.521 Section 6.6.3.1.4, choose the lowest, 5MHz & highest channel bandwidth for final test.
3. The conducted output power for QPSK, 16QAM and 64QAM, measured value of QPSK is higher than 16QAM and 64QAM mode. Therefore, only Modulation characteristics, occupied bandwidth and Peak to average ratio items had been tested under QPSK, 16QAM and 64QAM modes, the other test items were performed under QPSK mode only.

Test Condition:

Test Item	Environmental Conditions	Input Power (system)	Tested By
ERP	25deg. C, 70%RH	120Vac, 60Hz	Han Wu
Modulation Characteristics	24deg. C, 64%RH	120Vac, 60Hz	James Yang
Frequency Stability	24deg. C, 64%RH	120Vac, 60Hz	James Yang
Occupied Bandwidth	24deg. C, 64%RH	120Vac, 60Hz	James Yang
Band Edge	24deg. C, 64%RH	120Vac, 60Hz	James Yang
Peak To Average Ratio	24deg. C, 64%RH	120Vac, 60Hz	James Yang
Conducted Emission	24deg. C, 64%RH	120Vac, 60Hz	James Yang
Radiated Emission	25deg. C, 70%RH 22deg. C, 68%RH	120Vac, 60Hz	Noah Chang Greg Lin

3.4 EUT Operating Conditions

The EUT makes a call to the communication simulator. The communication simulator station system controlled a EUT to export maximum output power under transmission mode and specific channel frequency

3.5 General Description of Applied Standards

The EUT is a RF Product. According to the specifications of the manufacturer, it must comply with the requirements of the following standards:

FCC 47 CFR Part 2

FCC 47 CFR Part 22

KDB 971168 D01 Power Meas License Digital Systems v03r01

ANSI/TIA/EIA-603-E 2016

ANSI 63.26-2015

All test items have been performed and recorded as per the above standards.

4 Test Types and Results

4.1 Output Power Measurement

4.1.1 Limits of Output Power Measurement

Mobile / Portable station are limited to 7 watts e.r.p.

4.1.2 Test Procedures

EIRP / ERP Measurement:

- a. All measurements were done at low, middle and high operational frequency range. RBW and VBW is 1MHz for GSM, 5MHz for WCDMA mode, 10MHz for LTE mode.
- b. Substitution method is used for E.I.R.P measurement. In the semi-anechoic chamber, EUT placed on the 0.8m(below or equal 1GHz) and/or 1.5m(above 1GHz) height of Turn Table, rotated the table around 360 degrees to search the maximum radiation power and receiver antenna shall be rotated vertical and horizontal polarization and moved height from 1m to 4m to find the maximum polar radiated power. The "Read Value" is the spectrum reading the maximum power value.
- c. The substitution horn antenna is substituted for EUT at the same position and signals generator export the CW signal to the substitution antenna via a TX cable. Rotated the Turn Table and moved receiving antenna to find the maximum radiation power. Adjust output power level of S.G to get a Value of spectrum reading equal to "Read Value" of step b. Record the power level of S.G
- d. EIRP = Output power level of S.G – TX cable loss + Antenna gain of substitution horn. E.R.P power can be calculated form E.I.R.P power by subtracting the gain of dipole, E.R.P power = E.I.R.P power - 2.15dBi.

Where:

$$\text{ERP/EIRP} = P_{\text{Meas}} + G_T - L_C$$

P_{Meas} : Measure transmitter output power.

G_T : Gain of the transmitting antenna.

L_C : signal attenuation in the connecting cable between the transmitter and antenna.

Conducted Power Measurement:

The EUT was set up for the maximum power with GSM, WCDMA, LTE link data modulation and link up with simulator. Set the EUT to transmit under low, middle and high channel and record the power level shown on simulator.

4.1.3 Test Setup

EIRP / ERP Measurement:

For radiated emission 30MHz to 1GHz

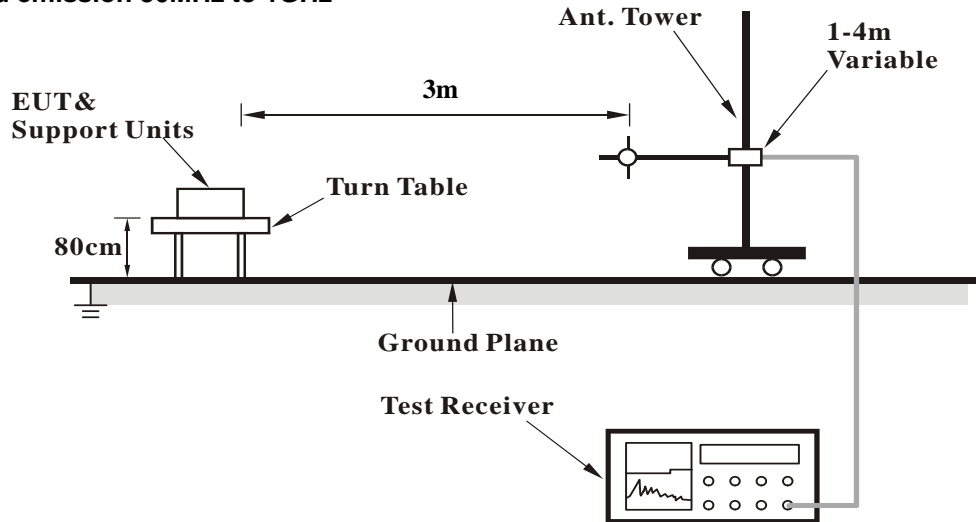

For radiated emission above 1GHz

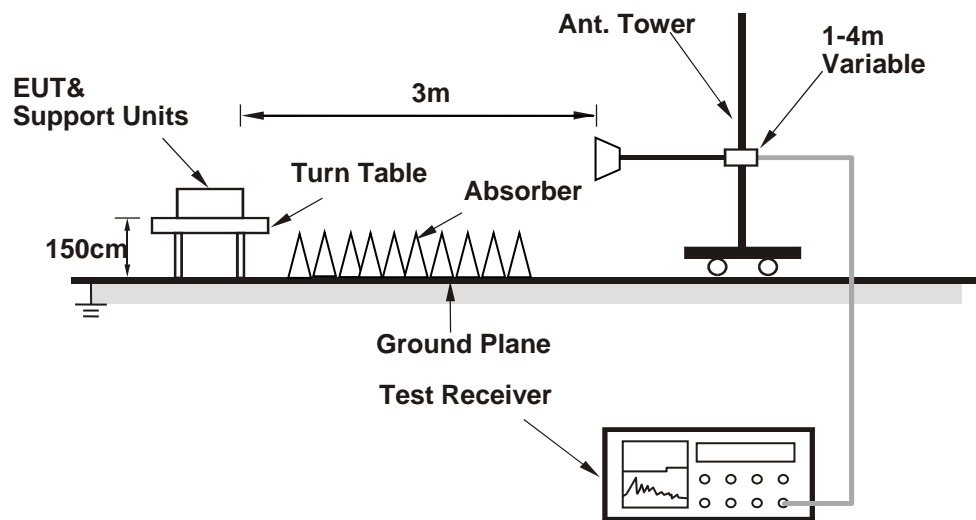

For the actual test configuration, please refer to the attached file (Test Setup Photo).

Conducted Power Measurement:



For the actual test configuration, please refer to the attached file (Test Setup Photo).

4.1.4 Test Results

Conducted Output Power (dBm)

Band	GSM850		
Channel	128	189	251
Frequency (MHz)	824.2	836.4	848.8
GSM	33.00	33.19	32.85
GPRS 1Tx Slot	32.24	32.28	32.13
GPRS 2Tx Slot	31.42	31.58	31.29
GPRS 3Tx Slot	29.89	30.09	29.85
GPRS 4Tx Slot	26.88	27.05	26.72
DTM 9 (GPRS)	31.39	31.49	31.12
DTM 11 (GPRS)	29.85	29.92	29.77
EDGE 1Tx Slot (MCS9)	26.91	27.10	26.78
EDGE 2Tx Slot (MCS9)	25.42	25.55	25.24
EDGE 3Tx Slot (MCS9)	23.88	24.09	23.64
EDGE 4Tx Slot (MCS9)	21.66	21.77	21.56
DTM 9 (EDGE)	25.26	25.06	24.95
DTM 11 (EDGE)	23.57	23.76	23.48

Band	WCDMA V		
TX Channel	4132	4182	4233
Rx Channel	4357	4407	4458
Frequency (MHz)	826.4	836.4	846.6
RMC 12.2K	24.26	24.22	24.24
HSDPA Subtest-1	23.40	23.33	23.35
HSDPA Subtest-2	23.34	23.29	23.30
HSDPA Subtest-3	22.89	22.84	22.85
HSDPA Subtest-4	22.78	22.71	22.75
HSUPA Subtest-1	23.38	23.31	23.29
HSUPA Subtest-2	21.33	21.26	21.28
HSUPA Subtest-3	22.29	22.18	22.23
HSUPA Subtest-4	21.19	21.12	21.15
HSUPA Subtest-5	23.11	23.04	23.08

LTE Band 5							
BW	MCS Index	RB Size	RB Offset	Low	Mid	High	3GPP MPR (dB)
		Channel		20407	20525	20643	
		Frequency (MHz)		824.7	836.5	848.3	
1.4M	QPSK	1	0	24.33	24.10	24.19	0
		1	2	24.31	24.11	24.20	0
		1	5	24.28	24.12	24.22	0
		3	0	24.11	24.05	24.08	0
		3	1	24.16	24.06	24.06	0
		3	3	24.13	24.03	24.08	0
		6	0	24.00	23.97	24.01	1
	16QAM	1	0	23.30	23.15	23.11	1
		1	2	23.25	23.11	23.16	1
		1	5	23.22	23.14	23.14	1
		3	0	23.11	23.02	23.00	1
		3	1	23.05	23.08	23.03	1
		3	3	23.08	23.06	23.00	1
		6	0	22.94	22.92	22.86	2
	64QAM	1	0	23.15	23.11	23.12	1
		1	2	23.11	23.05	23.11	1
		1	5	23.14	23.03	23.06	1
		3	0	23.02	23.03	23.02	1
		3	1	23.03	23.02	22.96	1
		3	3	23.06	22.99	23.02	1
		6	0	22.95	22.91	22.88	2

LTE Band 5							
BW	MCS Index	RB Size	RB Offset	Low	Mid	High	3GPP MPR (dB)
		Channel		20415	20525	20635	
		Frequency (MHz)		825.5	836.5	847.5	
3M	QPSK	1	0	24.35	24.41	24.49	0
		1	7	24.33	24.33	24.44	0
		1	14	24.29	24.36	24.43	0
		8	0	24.18	24.25	24.30	1
		8	3	24.16	24.20	24.33	1
		8	7	24.15	24.22	24.28	1
		15	0	24.07	24.12	24.18	1
	16QAM	1	0	23.52	23.16	23.33	1
		1	7	23.44	23.08	23.29	1
		1	14	23.48	23.11	23.26	1
		8	0	23.32	23.06	23.08	2
		8	3	23.29	23.12	23.11	2
		8	7	23.28	23.11	23.06	2
		15	0	23.19	23.04	23.05	2
	64QAM	1	0	23.39	23.11	23.26	1
		1	7	23.33	23.00	23.18	1
		1	14	23.28	23.06	23.15	1
		8	0	23.12	23.01	23.05	2
		8	3	23.06	23.02	23.08	2
		8	7	23.09	23.02	23.06	2
		15	0	22.97	22.84	22.87	2

LTE Band 5							
BW	MCS Index	RB Size	RB Offset	Low	Mid	High	3GPP MPR (dB)
		Channel		20425	20525	20625	
		Frequency (MHz)		826.5	836.5	846.5	
5M	QPSK	1	0	24.05	24.26	24.43	0
		1	12	24.01	24.22	24.40	0
		1	24	24.01	24.21	24.38	0
		12	0	23.88	24.02	24.22	1
		12	6	23.84	24.05	24.15	1
		12	13	23.85	24.08	24.11	1
		25	0	23.66	23.88	23.99	1
	16QAM	1	0	23.28	23.26	23.37	1
		1	12	23.22	23.22	23.33	1
		1	24	23.25	23.23	23.32	1
		12	0	23.08	23.03	23.12	2
		12	6	23.03	23.06	23.11	2
		12	13	23.06	22.98	23.14	2
		25	0	22.87	22.82	22.92	2
	64QAM	1	0	23.16	23.21	23.25	1
		1	12	23.11	23.15	23.18	1
		1	24	23.12	23.19	23.11	1
		12	0	22.96	22.99	23.01	2
		12	6	22.95	22.96	23.03	2
		12	13	22.92	23.02	23.04	2
		25	0	22.76	22.78	22.85	2

LTE Band 5							
BW	MCS Index	RB Size	RB Offset	Low	Mid	High	3GPP MPR (dB)
		Channel		20450	20525	20600	
		Frequency (MHz)		829	836.5	844	
10M	QPSK	1	0	24.41	24.28	24.39	0
		1	24	24.38	24.22	24.33	0
		1	49	24.32	24.21	24.28	0
		25	0	24.21	24.11	24.13	1
		25	12	24.15	24.19	24.16	1
		25	25	24.15	24.11	24.08	1
		50	0	24.03	23.99	23.95	1
	16QAM	1	0	23.31	23.28	23.26	1
		1	24	23.28	23.21	23.18	1
		1	49	23.22	23.21	23.15	1
		25	0	23.06	23.01	23.02	2
		25	12	23.02	23.03	23.02	2
		25	25	23.03	23.02	22.98	2
		50	0	22.85	22.82	22.79	2
	64QAM	1	0	23.18	23.11	23.12	1
		1	24	23.11	23.02	23.06	1
		1	49	23.16	23.05	23.08	1
		25	0	22.87	22.82	22.84	2
		25	12	22.86	22.79	22.80	2
		25	25	22.86	22.77	22.77	2
		50	0	22.61	22.58	22.55	2

ERP Power

GSM Mode

Mode		TX channel 128					
Antenna Polarity & Test Distance: Horizontal at 3 M							
No.	Freq. (MHz)	Reading (dBm)	S.G Power Value (dBm)	Correction Factor (dB)	ERP (dBm)	Limit (dBm)	Margin (dB)
1	824.20	-2.2	25.4	3.9	29.3	38.5	-9.2
Antenna Polarity & Test Distance: Vertical at 3 M							
No.	Freq. (MHz)	Reading (dBm)	S.G Power Value (dBm)	Correction Factor (dB)	ERP (dBm)	Limit (dBm)	Margin (dB)
1	824.20	0.9	29.2	3.9	33.1	38.5	-5.4

Mode		TX channel 189					
Antenna Polarity & Test Distance: Horizontal at 3 M							
No.	Freq. (MHz)	Reading (dBm)	S.G Power Value (dBm)	Correction Factor (dB)	ERP (dBm)	Limit (dBm)	Margin (dB)
1	836.40	-2.1	25.3	3.8	29.1	38.5	-9.4
Antenna Polarity & Test Distance: Vertical at 3 M							
No.	Freq. (MHz)	Reading (dBm)	S.G Power Value (dBm)	Correction Factor (dB)	ERP (dBm)	Limit (dBm)	Margin (dB)
1	836.40	0.9	29.0	3.8	32.8	38.5	-5.7

Mode		TX channel 251					
Antenna Polarity & Test Distance: Horizontal at 3 M							
No.	Freq. (MHz)	Reading (dBm)	S.G Power Value (dBm)	Correction Factor (dB)	ERP (dBm)	Limit (dBm)	Margin (dB)
1	848.80	-2.0	25.7	3.4	29.1	38.5	-9.4
Antenna Polarity & Test Distance: Vertical at 3 M							
No.	Freq. (MHz)	Reading (dBm)	S.G Power Value (dBm)	Correction Factor (dB)	ERP (dBm)	Limit (dBm)	Margin (dB)
1	848.80	1.3	29.4	3.4	32.8	38.5	-5.7

Note: ERP (dBm) = S.G Power Value (dBm) + Correction Factor (dB).

WCDMA Band 5

Mode		TX channel 4132					
Antenna Polarity & Test Distance: Horizontal at 3 M							
No.	Freq. (MHz)	Reading (dBm)	S.G Power Value (dBm)	Correction Factor (dB)	ERP (dBm)	Limit (dBm)	Margin (dB)
1	826.40	-9.3	18.3	3.9	22.2	38.5	-16.3
Antenna Polarity & Test Distance: Vertical at 3 M							
No.	Freq. (MHz)	Reading (dBm)	S.G Power Value (dBm)	Correction Factor (dB)	ERP (dBm)	Limit (dBm)	Margin (dB)
1	826.40	-6.2	22.1	3.9	26.0	38.5	-12.5

Mode		TX channel 4182					
Antenna Polarity & Test Distance: Horizontal at 3 M							
No.	Freq. (MHz)	Reading (dBm)	S.G Power Value (dBm)	Correction Factor (dB)	ERP (dBm)	Limit (dBm)	Margin (dB)
1	836.40	-9.2	18.2	3.8	22.0	38.5	-16.5
Antenna Polarity & Test Distance: Vertical at 3 M							
No.	Freq. (MHz)	Reading (dBm)	S.G Power Value (dBm)	Correction Factor (dB)	ERP (dBm)	Limit (dBm)	Margin (dB)
1	836.40	-5.9	22.2	3.8	26.0	38.5	-12.5

Mode		TX channel 4233					
Antenna Polarity & Test Distance: Horizontal at 3 M							
No.	Freq. (MHz)	Reading (dBm)	S.G Power Value (dBm)	Correction Factor (dB)	ERP (dBm)	Limit (dBm)	Margin (dB)
1	846.60	-8.8	18.8	3.4	22.2	38.5	-16.3
Antenna Polarity & Test Distance: Vertical at 3 M							
No.	Freq. (MHz)	Reading (dBm)	S.G Power Value (dBm)	Correction Factor (dB)	ERP (dBm)	Limit (dBm)	Margin (dB)
1	846.60	-5.7	22.5	3.4	25.9	38.5	-12.6

Note: ERP (dBm) = S.G Power Value (dBm) + Correction Factor (dB).

Modulation Type: QPSK

LTE Band 5, Channel Bandwidth: 1.4MHz

Mode		TX channel 20407					
Antenna Polarity & Test Distance: Horizontal at 3 M							
No.	Freq. (MHz)	Reading (dBm)	S.G Power Value (dBm)	Correction Factor (dB)	ERP (dBm)	Limit (dBm)	Margin (dB)
1	824.70	-10.7	16.9	3.9	20.8	38.5	-17.7
Antenna Polarity & Test Distance: Vertical at 3 M							
No.	Freq. (MHz)	Reading (dBm)	S.G Power Value (dBm)	Correction Factor (dB)	ERP (dBm)	Limit (dBm)	Margin (dB)
1	824.70	-9.6	18.7	3.9	22.6	38.5	-15.9

Mode		TX channel 20525					
Antenna Polarity & Test Distance: Horizontal at 3 M							
No.	Freq. (MHz)	Reading (dBm)	S.G Power Value (dBm)	Correction Factor (dB)	ERP (dBm)	Limit (dBm)	Margin (dB)
1	836.50	-10.4	17.1	3.8	20.9	38.5	-17.6
Antenna Polarity & Test Distance: Vertical at 3 M							
No.	Freq. (MHz)	Reading (dBm)	S.G Power Value (dBm)	Correction Factor (dB)	ERP (dBm)	Limit (dBm)	Margin (dB)
1	836.50	-9.5	18.6	3.8	22.4	38.5	-16.1

Mode		TX channel 20643					
Antenna Polarity & Test Distance: Horizontal at 3 M							
No.	Freq. (MHz)	Reading (dBm)	S.G Power Value (dBm)	Correction Factor (dB)	ERP (dBm)	Limit (dBm)	Margin (dB)
1	848.30	-10.6	17.1	3.4	20.5	38.5	-18.0
Antenna Polarity & Test Distance: Vertical at 3 M							
No.	Freq. (MHz)	Reading (dBm)	S.G Power Value (dBm)	Correction Factor (dB)	ERP (dBm)	Limit (dBm)	Margin (dB)
1	848.30	-9.2	18.9	3.4	22.3	38.5	-16.2

Note: ERP (dBm) = S.G Power Value (dBm) + Correction Factor (dB).

LTE Band 5, Channel Bandwidth: 3MHz

Mode		TX channel 20415					
Antenna Polarity & Test Distance: Horizontal at 3 M							
No.	Freq. (MHz)	Reading (dBm)	S.G Power Value (dBm)	Correction Factor (dB)	ERP (dBm)	Limit (dBm)	Margin (dB)
1	825.50	-10.2	17.4	3.9	21.3	38.5	-17.2
Antenna Polarity & Test Distance: Vertical at 3 M							
No.	Freq. (MHz)	Reading (dBm)	S.G Power Value (dBm)	Correction Factor (dB)	ERP (dBm)	Limit (dBm)	Margin (dB)
1	825.50	-9.4	19.0	3.9	22.9	38.5	-15.6

Mode		TX channel 20525					
Antenna Polarity & Test Distance: Horizontal at 3 M							
No.	Freq. (MHz)	Reading (dBm)	S.G Power Value (dBm)	Correction Factor (dB)	ERP (dBm)	Limit (dBm)	Margin (dB)
1	836.50	-10.4	17.1	3.8	20.9	38.5	-17.6
Antenna Polarity & Test Distance: Vertical at 3 M							
No.	Freq. (MHz)	Reading (dBm)	S.G Power Value (dBm)	Correction Factor (dB)	ERP (dBm)	Limit (dBm)	Margin (dB)
1	836.50	-9.5	18.6	3.8	22.4	38.5	-16.1

Mode		TX channel 20635					
Antenna Polarity & Test Distance: Horizontal at 3 M							
No.	Freq. (MHz)	Reading (dBm)	S.G Power Value (dBm)	Correction Factor (dB)	ERP (dBm)	Limit (dBm)	Margin (dB)
1	847.50	-9.9	17.7	3.4	21.1	38.5	-17.4
Antenna Polarity & Test Distance: Vertical at 3 M							
No.	Freq. (MHz)	Reading (dBm)	S.G Power Value (dBm)	Correction Factor (dB)	ERP (dBm)	Limit (dBm)	Margin (dB)
1	847.50	-9.3	18.9	3.4	22.3	38.5	-16.2

Note: ERP (dBm) = S.G Power Value (dBm) + Correction Factor (dB).

LTE Band 5, Channel Bandwidth: 5MHz

Mode		TX channel 20425					
Antenna Polarity & Test Distance: Horizontal at 3 M							
No.	Freq. (MHz)	Reading (dBm)	S.G Power Value (dBm)	Correction Factor (dB)	ERP (dBm)	Limit (dBm)	Margin (dB)
1	826.50	-9.9	17.7	3.9	21.6	38.5	-16.9
Antenna Polarity & Test Distance: Vertical at 3 M							
No.	Freq. (MHz)	Reading (dBm)	S.G Power Value (dBm)	Correction Factor (dB)	ERP (dBm)	Limit (dBm)	Margin (dB)
1	826.50	-8.6	19.7	3.9	23.6	38.5	-14.9

Mode		TX channel 20525					
Antenna Polarity & Test Distance: Horizontal at 3 M							
No.	Freq. (MHz)	Reading (dBm)	S.G Power Value (dBm)	Correction Factor (dB)	ERP (dBm)	Limit (dBm)	Margin (dB)
1	836.50	-10.4	17.1	3.8	20.9	38.5	-17.6
Antenna Polarity & Test Distance: Vertical at 3 M							
No.	Freq. (MHz)	Reading (dBm)	S.G Power Value (dBm)	Correction Factor (dB)	ERP (dBm)	Limit (dBm)	Margin (dB)
1	836.50	-9.2	18.8	3.8	22.6	38.5	-15.9

Mode		TX channel 20625					
Antenna Polarity & Test Distance: Horizontal at 3 M							
No.	Freq. (MHz)	Reading (dBm)	S.G Power Value (dBm)	Correction Factor (dB)	ERP (dBm)	Limit (dBm)	Margin (dB)
1	846.50	-10.4	17.2	3.4	20.6	38.5	-17.9
Antenna Polarity & Test Distance: Vertical at 3 M							
No.	Freq. (MHz)	Reading (dBm)	S.G Power Value (dBm)	Correction Factor (dB)	ERP (dBm)	Limit (dBm)	Margin (dB)
1	846.50	-9.4	18.8	3.4	22.2	38.5	-16.3

Note: ERP (dBm) = S.G Power Value (dBm) + Correction Factor (dB).

LTE Band 5, Channel Bandwidth: 10MHz

Mode		TX channel 20450					
Antenna Polarity & Test Distance: Horizontal at 3 M							
No.	Freq. (MHz)	Reading (dBm)	S.G Power Value (dBm)	Correction Factor (dB)	ERP (dBm)	Limit (dBm)	Margin (dB)
1	829.00	-10.2	17.5	3.9	21.4	38.5	-17.1
Antenna Polarity & Test Distance: Vertical at 3 M							
No.	Freq. (MHz)	Reading (dBm)	S.G Power Value (dBm)	Correction Factor (dB)	ERP (dBm)	Limit (dBm)	Margin (dB)
1	829.00	-9.5	18.7	3.9	22.6	38.5	-15.9

Mode		TX channel 20525					
Antenna Polarity & Test Distance: Horizontal at 3 M							
No.	Freq. (MHz)	Reading (dBm)	S.G Power Value (dBm)	Correction Factor (dB)	ERP (dBm)	Limit (dBm)	Margin (dB)
1	836.50	-10.4	17.1	3.8	20.9	38.5	-17.6
Antenna Polarity & Test Distance: Vertical at 3 M							
No.	Freq. (MHz)	Reading (dBm)	S.G Power Value (dBm)	Correction Factor (dB)	ERP (dBm)	Limit (dBm)	Margin (dB)
1	836.50	-9.4	18.7	3.8	22.5	38.5	-16.0

Mode		TX channel 20600					
Antenna Polarity & Test Distance: Horizontal at 3 M							
No.	Freq. (MHz)	Reading (dBm)	S.G Power Value (dBm)	Correction Factor (dB)	ERP (dBm)	Limit (dBm)	Margin (dB)
1	844.00	-10.4	17.2	3.7	20.9	38.5	-17.6
Antenna Polarity & Test Distance: Vertical at 3 M							
No.	Freq. (MHz)	Reading (dBm)	S.G Power Value (dBm)	Correction Factor (dB)	ERP (dBm)	Limit (dBm)	Margin (dB)
1	844.00	-9.2	19.2	3.7	22.9	38.5	-15.6

Note: ERP (dBm) = S.G Power Value (dBm) + Correction Factor (dB).

Modulation Type: 16QAM

LTE Band 5, Channel Bandwidth: 1.4MHz

Mode		TX channel 20407					
Antenna Polarity & Test Distance: Horizontal at 3 M							
No.	Freq. (MHz)	Reading (dBm)	S.G Power Value (dBm)	Correction Factor (dB)	ERP (dBm)	Limit (dBm)	Margin (dB)
1	824.70	-11.6	16.0	3.9	19.9	38.5	-18.6
Antenna Polarity & Test Distance: Vertical at 3 M							
No.	Freq. (MHz)	Reading (dBm)	S.G Power Value (dBm)	Correction Factor (dB)	ERP (dBm)	Limit (dBm)	Margin (dB)
1	824.70	-10.6	17.7	3.9	21.6	38.5	-16.9

Mode		TX channel 20525					
Antenna Polarity & Test Distance: Horizontal at 3 M							
No.	Freq. (MHz)	Reading (dBm)	S.G Power Value (dBm)	Correction Factor (dB)	ERP (dBm)	Limit (dBm)	Margin (dB)
1	836.50	-11.4	16.1	3.8	19.9	38.5	-18.6
Antenna Polarity & Test Distance: Vertical at 3 M							
No.	Freq. (MHz)	Reading (dBm)	S.G Power Value (dBm)	Correction Factor (dB)	ERP (dBm)	Limit (dBm)	Margin (dB)
1	836.50	-10.5	17.6	3.8	21.4	38.5	-17.1

Mode		TX channel 20643					
Antenna Polarity & Test Distance: Horizontal at 3 M							
No.	Freq. (MHz)	Reading (dBm)	S.G Power Value (dBm)	Correction Factor (dB)	ERP (dBm)	Limit (dBm)	Margin (dB)
1	848.30	-11.4	16.3	3.4	19.7	38.5	-18.8
Antenna Polarity & Test Distance: Vertical at 3 M							
No.	Freq. (MHz)	Reading (dBm)	S.G Power Value (dBm)	Correction Factor (dB)	ERP (dBm)	Limit (dBm)	Margin (dB)
1	848.30	-10.9	17.2	3.4	20.6	38.5	-17.9

Note: ERP (dBm) = S.G Power Value (dBm) + Correction Factor (dB).

LTE Band 5, Channel Bandwidth: 3MHz

Mode		TX channel 20415					
Antenna Polarity & Test Distance: Horizontal at 3 M							
No.	Freq. (MHz)	Reading (dBm)	S.G Power Value (dBm)	Correction Factor (dB)	ERP (dBm)	Limit (dBm)	Margin (dB)
1	825.50	-11.6	16.0	3.9	19.9	38.5	-18.6
Antenna Polarity & Test Distance: Vertical at 3 M							
No.	Freq. (MHz)	Reading (dBm)	S.G Power Value (dBm)	Correction Factor (dB)	ERP (dBm)	Limit (dBm)	Margin (dB)
1	825.50	-10.4	18.0	3.9	21.9	38.5	-16.6

Mode		TX channel 20525					
Antenna Polarity & Test Distance: Horizontal at 3 M							
No.	Freq. (MHz)	Reading (dBm)	S.G Power Value (dBm)	Correction Factor (dB)	ERP (dBm)	Limit (dBm)	Margin (dB)
1	836.50	-11.8	15.7	3.8	19.5	38.5	-19.0
Antenna Polarity & Test Distance: Vertical at 3 M							
No.	Freq. (MHz)	Reading (dBm)	S.G Power Value (dBm)	Correction Factor (dB)	ERP (dBm)	Limit (dBm)	Margin (dB)
1	836.50	-10.2	17.9	3.8	21.7	38.5	-16.8

Mode		TX channel 20635					
Antenna Polarity & Test Distance: Horizontal at 3 M							
No.	Freq. (MHz)	Reading (dBm)	S.G Power Value (dBm)	Correction Factor (dB)	ERP (dBm)	Limit (dBm)	Margin (dB)
1	847.50	-11.6	16.0	3.4	19.4	38.5	-19.1
Antenna Polarity & Test Distance: Vertical at 3 M							
No.	Freq. (MHz)	Reading (dBm)	S.G Power Value (dBm)	Correction Factor (dB)	ERP (dBm)	Limit (dBm)	Margin (dB)
1	847.50	-10.8	17.4	3.4	20.8	38.5	-17.7

Note: ERP (dBm) = S.G Power Value (dBm) + Correction Factor (dB).

LTE Band 5, Channel Bandwidth: 5MHz

Mode		TX channel 20425					
Antenna Polarity & Test Distance: Horizontal at 3 M							
No.	Freq. (MHz)	Reading (dBm)	S.G Power Value (dBm)	Correction Factor (dB)	ERP (dBm)	Limit (dBm)	Margin (dB)
1	826.50	-11.9	15.7	3.9	19.6	38.5	-18.9
Antenna Polarity & Test Distance: Vertical at 3 M							
No.	Freq. (MHz)	Reading (dBm)	S.G Power Value (dBm)	Correction Factor (dB)	ERP (dBm)	Limit (dBm)	Margin (dB)
1	826.50	-11.1	17.2	3.9	21.1	38.5	-17.4

Mode		TX channel 20525					
Antenna Polarity & Test Distance: Horizontal at 3 M							
No.	Freq. (MHz)	Reading (dBm)	S.G Power Value (dBm)	Correction Factor (dB)	ERP (dBm)	Limit (dBm)	Margin (dB)
1	836.50	-12.1	15.3	3.8	19.1	38.5	-19.4
Antenna Polarity & Test Distance: Vertical at 3 M							
No.	Freq. (MHz)	Reading (dBm)	S.G Power Value (dBm)	Correction Factor (dB)	ERP (dBm)	Limit (dBm)	Margin (dB)
1	836.50	-11.2	16.9	3.8	20.7	38.5	-17.8

Mode		TX channel 20625					
Antenna Polarity & Test Distance: Horizontal at 3 M							
No.	Freq. (MHz)	Reading (dBm)	S.G Power Value (dBm)	Correction Factor (dB)	ERP (dBm)	Limit (dBm)	Margin (dB)
1	846.50	-11.5	16.1	3.4	19.5	38.5	-19.0
Antenna Polarity & Test Distance: Vertical at 3 M							
No.	Freq. (MHz)	Reading (dBm)	S.G Power Value (dBm)	Correction Factor (dB)	ERP (dBm)	Limit (dBm)	Margin (dB)
1	846.50	-10.3	17.9	3.4	21.3	38.5	-17.2

Note: ERP (dBm) = S.G Power Value (dBm) + Correction Factor (dB).

LTE Band 5, Channel Bandwidth: 10MHz

Mode		TX channel 20450					
Antenna Polarity & Test Distance: Horizontal at 3 M							
No.	Freq. (MHz)	Reading (dBm)	S.G Power Value (dBm)	Correction Factor (dB)	ERP (dBm)	Limit (dBm)	Margin (dB)
1	829.00	-12.2	15.5	3.9	19.4	38.5	-19.1
Antenna Polarity & Test Distance: Vertical at 3 M							
No.	Freq. (MHz)	Reading (dBm)	S.G Power Value (dBm)	Correction Factor (dB)	ERP (dBm)	Limit (dBm)	Margin (dB)
1	829.00	-11.3	16.9	3.9	20.8	38.5	-17.7

Mode		TX channel 20525					
Antenna Polarity & Test Distance: Horizontal at 3 M							
No.	Freq. (MHz)	Reading (dBm)	S.G Power Value (dBm)	Correction Factor (dB)	ERP (dBm)	Limit (dBm)	Margin (dB)
1	836.50	-11.8	15.7	3.8	19.5	38.5	-19.0
Antenna Polarity & Test Distance: Vertical at 3 M							
No.	Freq. (MHz)	Reading (dBm)	S.G Power Value (dBm)	Correction Factor (dB)	ERP (dBm)	Limit (dBm)	Margin (dB)
1	836.50	-10.7	17.4	3.8	21.2	38.5	-17.3

Mode		TX channel 20600					
Antenna Polarity & Test Distance: Horizontal at 3 M							
No.	Freq. (MHz)	Reading (dBm)	S.G Power Value (dBm)	Correction Factor (dB)	ERP (dBm)	Limit (dBm)	Margin (dB)
1	844.00	-12.1	15.4	3.7	19.1	38.5	-19.4
Antenna Polarity & Test Distance: Vertical at 3 M							
No.	Freq. (MHz)	Reading (dBm)	S.G Power Value (dBm)	Correction Factor (dB)	ERP (dBm)	Limit (dBm)	Margin (dB)
1	844.00	-11.0	17.4	3.7	21.1	38.5	-17.4

Note: ERP (dBm) = S.G Power Value (dBm) + Correction Factor (dB).

Modulation Type: 64QAM

LTE Band 5, Channel Bandwidth: 1.4MHz

Mode		TX channel 20407					
Antenna Polarity & Test Distance: Horizontal at 3 M							
No.	Freq. (MHz)	Reading (dBm)	S.G Power Value (dBm)	Correction Factor (dB)	ERP (dBm)	Limit (dBm)	Margin (dB)
1	824.70	-12.0	15.6	3.9	19.5	38.5	-19.0
Antenna Polarity & Test Distance: Vertical at 3 M							
No.	Freq. (MHz)	Reading (dBm)	S.G Power Value (dBm)	Correction Factor (dB)	ERP (dBm)	Limit (dBm)	Margin (dB)
1	824.70	-11.1	17.2	3.9	21.1	38.5	-17.4

Mode		TX channel 20525					
Antenna Polarity & Test Distance: Horizontal at 3 M							
No.	Freq. (MHz)	Reading (dBm)	S.G Power Value (dBm)	Correction Factor (dB)	ERP (dBm)	Limit (dBm)	Margin (dB)
1	836.50	-11.6	15.8	3.8	19.6	38.5	-18.9
Antenna Polarity & Test Distance: Vertical at 3 M							
No.	Freq. (MHz)	Reading (dBm)	S.G Power Value (dBm)	Correction Factor (dB)	ERP (dBm)	Limit (dBm)	Margin (dB)
1	836.50	-10.9	17.2	3.8	21.0	38.5	-17.5

Mode		TX channel 20643					
Antenna Polarity & Test Distance: Horizontal at 3 M							
No.	Freq. (MHz)	Reading (dBm)	S.G Power Value (dBm)	Correction Factor (dB)	ERP (dBm)	Limit (dBm)	Margin (dB)
1	848.30	-11.9	15.8	3.4	19.2	38.5	-19.3
Antenna Polarity & Test Distance: Vertical at 3 M							
No.	Freq. (MHz)	Reading (dBm)	S.G Power Value (dBm)	Correction Factor (dB)	ERP (dBm)	Limit (dBm)	Margin (dB)
1	848.30	-11.2	16.9	3.4	20.3	38.5	-18.2

Note: ERP (dBm) = S.G Power Value (dBm) + Correction Factor (dB).

LTE Band 5, Channel Bandwidth: 3MHz

Mode		TX channel 20415					
Antenna Polarity & Test Distance: Horizontal at 3 M							
No.	Freq. (MHz)	Reading (dBm)	S.G Power Value (dBm)	Correction Factor (dB)	ERP (dBm)	Limit (dBm)	Margin (dB)
1	825.50	-12.1	15.5	3.9	19.4	38.5	-19.1
Antenna Polarity & Test Distance: Vertical at 3 M							
No.	Freq. (MHz)	Reading (dBm)	S.G Power Value (dBm)	Correction Factor (dB)	ERP (dBm)	Limit (dBm)	Margin (dB)
1	825.50	-10.8	17.6	3.9	21.5	38.5	-17.0

Mode		TX channel 20525					
Antenna Polarity & Test Distance: Horizontal at 3 M							
No.	Freq. (MHz)	Reading (dBm)	S.G Power Value (dBm)	Correction Factor (dB)	ERP (dBm)	Limit (dBm)	Margin (dB)
1	836.50	-12.1	15.3	3.8	19.1	38.5	-19.4
Antenna Polarity & Test Distance: Vertical at 3 M							
No.	Freq. (MHz)	Reading (dBm)	S.G Power Value (dBm)	Correction Factor (dB)	ERP (dBm)	Limit (dBm)	Margin (dB)
1	836.50	-10.5	17.6	3.8	21.4	38.5	-17.1

Mode		TX channel 20635					
Antenna Polarity & Test Distance: Horizontal at 3 M							
No.	Freq. (MHz)	Reading (dBm)	S.G Power Value (dBm)	Correction Factor (dB)	ERP (dBm)	Limit (dBm)	Margin (dB)
1	847.50	-11.8	15.8	3.4	19.2	38.5	-19.3
Antenna Polarity & Test Distance: Vertical at 3 M							
No.	Freq. (MHz)	Reading (dBm)	S.G Power Value (dBm)	Correction Factor (dB)	ERP (dBm)	Limit (dBm)	Margin (dB)
1	847.50	-11.2	17.0	3.4	20.4	38.5	-18.1

Note: ERP (dBm) = S.G Power Value (dBm) + Correction Factor (dB).

LTE Band 5, Channel Bandwidth: 5MHz

Mode		TX channel 20425					
Antenna Polarity & Test Distance: Horizontal at 3 M							
No.	Freq. (MHz)	Reading (dBm)	S.G Power Value (dBm)	Correction Factor (dB)	ERP (dBm)	Limit (dBm)	Margin (dB)
1	826.50	-12.4	15.2	3.9	19.1	38.5	-19.4
Antenna Polarity & Test Distance: Vertical at 3 M							
No.	Freq. (MHz)	Reading (dBm)	S.G Power Value (dBm)	Correction Factor (dB)	ERP (dBm)	Limit (dBm)	Margin (dB)
1	826.50	-11.4	16.9	3.9	20.8	38.5	-17.7

Mode		TX channel 20525					
Antenna Polarity & Test Distance: Horizontal at 3 M							
No.	Freq. (MHz)	Reading (dBm)	S.G Power Value (dBm)	Correction Factor (dB)	ERP (dBm)	Limit (dBm)	Margin (dB)
1	836.50	-12.4	15.0	3.8	18.8	38.5	-19.7
Antenna Polarity & Test Distance: Vertical at 3 M							
No.	Freq. (MHz)	Reading (dBm)	S.G Power Value (dBm)	Correction Factor (dB)	ERP (dBm)	Limit (dBm)	Margin (dB)
1	836.50	-11.5	16.6	3.8	20.4	38.5	-18.1

Mode		TX channel 20625					
Antenna Polarity & Test Distance: Horizontal at 3 M							
No.	Freq. (MHz)	Reading (dBm)	S.G Power Value (dBm)	Correction Factor (dB)	ERP (dBm)	Limit (dBm)	Margin (dB)
1	846.50	-11.8	15.8	3.4	19.2	38.5	-19.3
Antenna Polarity & Test Distance: Vertical at 3 M							
No.	Freq. (MHz)	Reading (dBm)	S.G Power Value (dBm)	Correction Factor (dB)	ERP (dBm)	Limit (dBm)	Margin (dB)
1	846.50	-10.7	17.5	3.4	20.9	38.5	-17.6

Note: ERP (dBm) = S.G Power Value (dBm) + Correction Factor (dB).

LTE Band 5, Channel Bandwidth: 10MHz

Mode		TX channel 20450					
Antenna Polarity & Test Distance: Horizontal at 3 M							
No.	Freq. (MHz)	Reading (dBm)	S.G Power Value (dBm)	Correction Factor (dB)	ERP (dBm)	Limit (dBm)	Margin (dB)
1	829.00	-12.6	15.1	3.9	19.0	38.5	-19.5
Antenna Polarity & Test Distance: Vertical at 3 M							
No.	Freq. (MHz)	Reading (dBm)	S.G Power Value (dBm)	Correction Factor (dB)	ERP (dBm)	Limit (dBm)	Margin (dB)
1	829.00	-11.8	16.5	3.9	20.4	38.5	-18.1

Mode		TX channel 20525					
Antenna Polarity & Test Distance: Horizontal at 3 M							
No.	Freq. (MHz)	Reading (dBm)	S.G Power Value (dBm)	Correction Factor (dB)	ERP (dBm)	Limit (dBm)	Margin (dB)
1	836.50	-12.2	15.2	3.8	19.0	38.5	-19.5
Antenna Polarity & Test Distance: Vertical at 3 M							
No.	Freq. (MHz)	Reading (dBm)	S.G Power Value (dBm)	Correction Factor (dB)	ERP (dBm)	Limit (dBm)	Margin (dB)
1	836.50	-10.9	17.2	3.8	21.0	38.5	-17.5

Mode		TX channel 20600					
Antenna Polarity & Test Distance: Horizontal at 3 M							
No.	Freq. (MHz)	Reading (dBm)	S.G Power Value (dBm)	Correction Factor (dB)	ERP (dBm)	Limit (dBm)	Margin (dB)
1	844.00	-12.4	15.1	3.7	18.8	38.5	-19.7
Antenna Polarity & Test Distance: Vertical at 3 M							
No.	Freq. (MHz)	Reading (dBm)	S.G Power Value (dBm)	Correction Factor (dB)	ERP (dBm)	Limit (dBm)	Margin (dB)
1	844.00	-11.2	17.2	3.7	20.9	38.5	-17.6

Note: ERP (dBm) = S.G Power Value (dBm) + Correction Factor (dB).

4.2 Modulation Characteristics Measurement

4.2.1 Limits of Modulation Characteristics

N/A

4.2.2 Test Procedure

Connect the EUT to Communication Simulator via the antenna connector, The frequency band is set as EUT supported Modulation and Channels, the EUT output is matched with 50 ohm load, the waveform quality and constellation of the EUT was tested.

4.2.3 Test Setup



4.2.4 Test Results

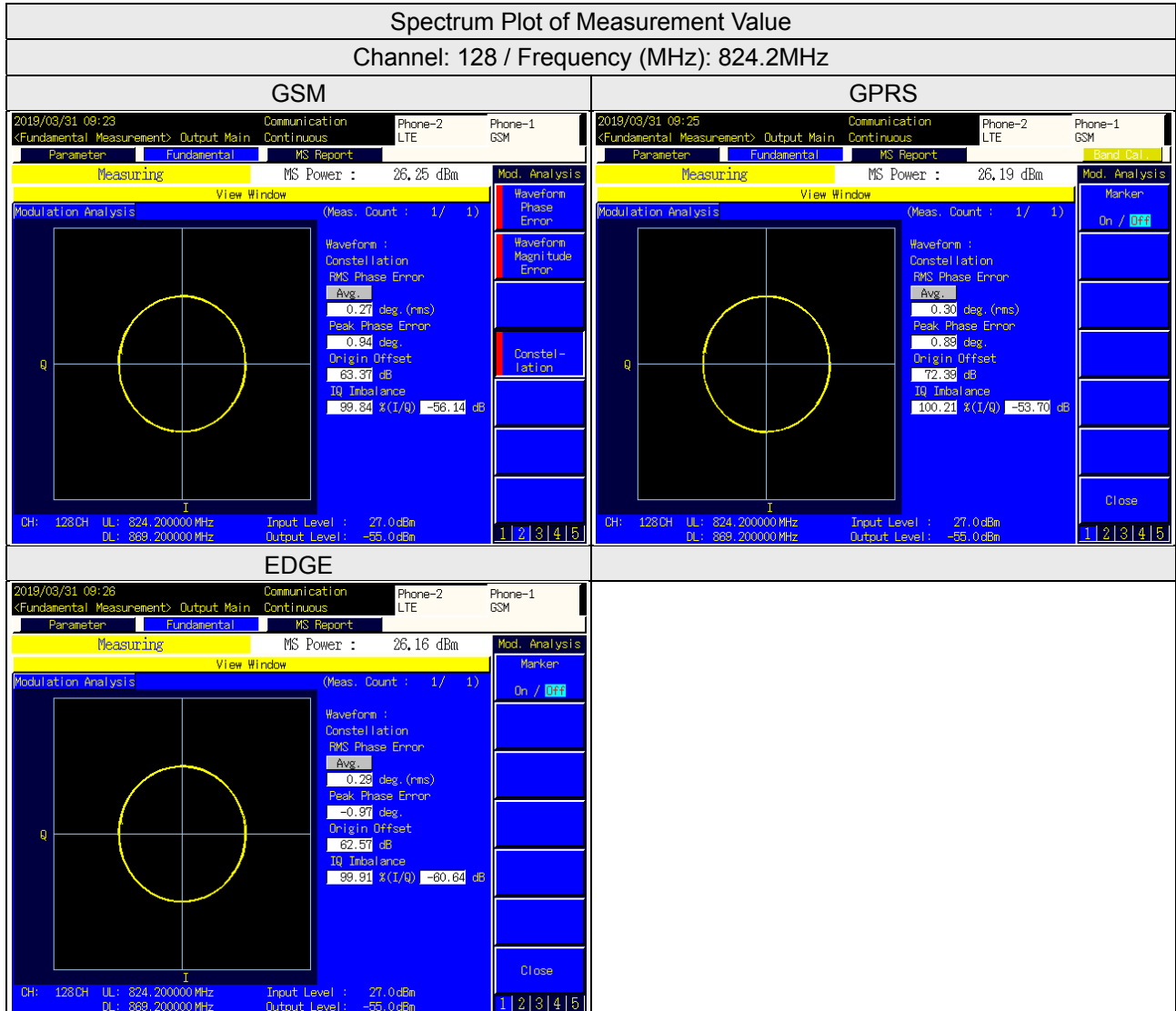

WCDMA Band 5

Spectrum Plot of Measurement Value

Channel: 4182 / Frequency (MHz): 836.4MHz

WCDMA

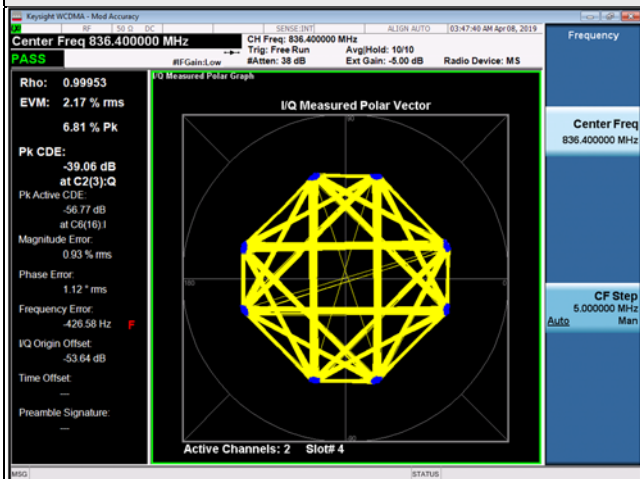

HSDPA

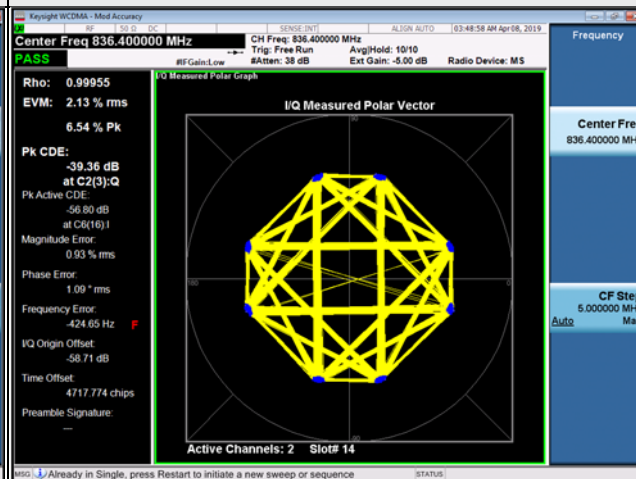

HSUPA

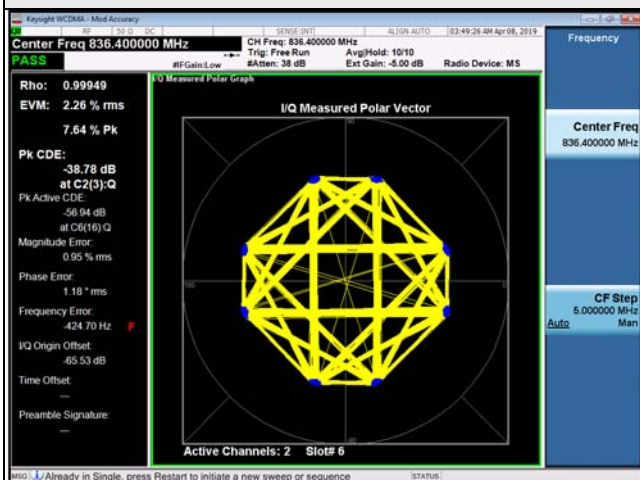

LTE Band 5

Spectrum Plot of Measurement Value

Channel: 20525 / Frequency (MHz): 836.5MHz

QPSK

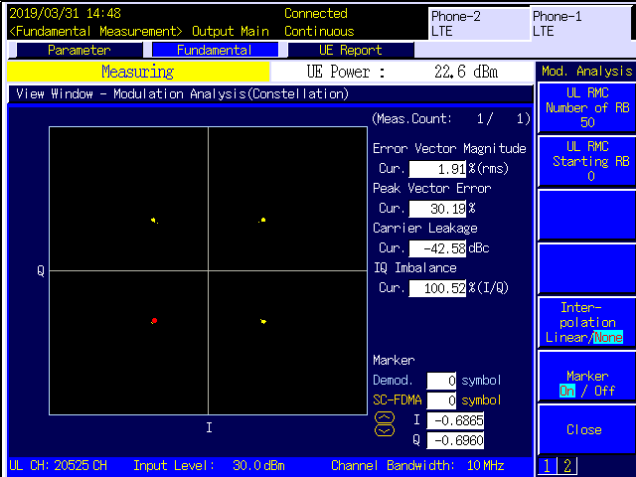

16QAM

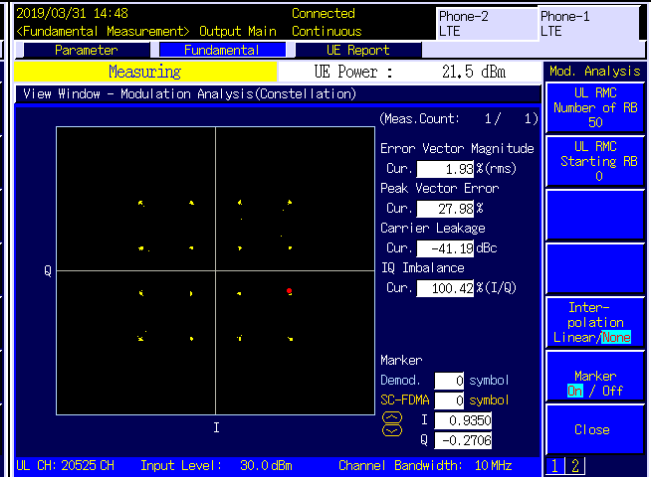

64QAM

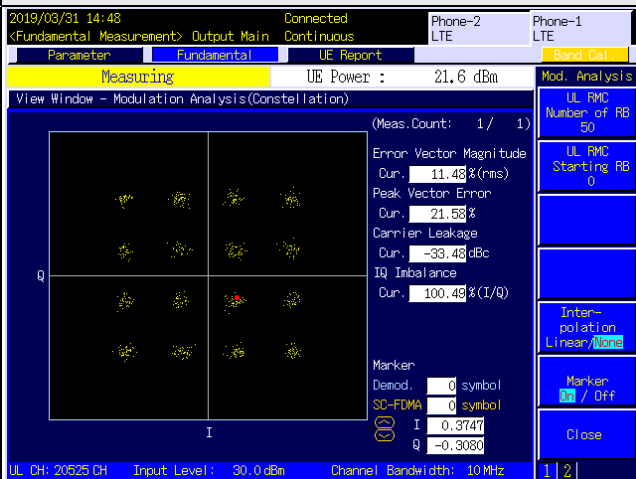

4.3 Frequency Stability Measurement

4.3.1 Limits of Frequency Stability Measurement

1.5 ppm is for base and fixed station. 2.5 ppm is for mobile station.

4.3.2 Test Procedure

- Device is placed at the oven room. The oven room could control the temperatures and humidity. Power warm up is at least 15 min and power applied should perform before recording frequency error.
- EUT is connected the external power supply to control the DC input power. The test voltage range is from minimum to maximum working voltage. Each step shall be record the frequency error rate.
- The temperature range step is 10 degrees in this test items. All temperature levels shall be hold the ± 0.5 °C during the measurement testing. The each temperature step shall be at least 0.5 hours, consider the EUT could be test under the stability condition.

Note: The frequency error was recorded frequency error from the communication simulator.

4.3.3 Test Setup

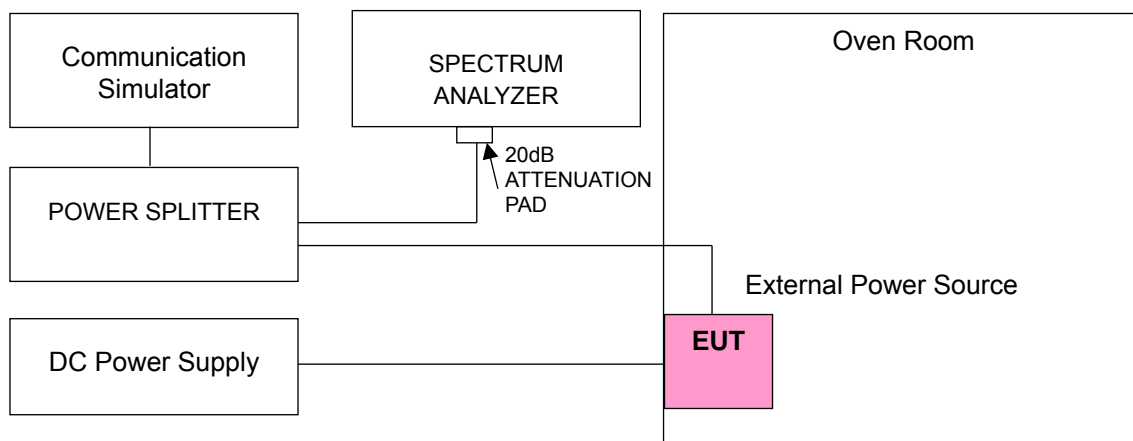

4.3.4 Test Results

Frequency Error vs. Voltage

Voltage (Volts)	GSM 850			
	Low Channel		High Channel	
	Frequency (MHz)	Frequency Error (ppm)	Frequency (MHz)	Frequency Error (ppm)
3.8	824.200002	0.002	848.800002	0.003
3.6	824.200001	0.002	848.800004	0.004
4.35	824.200003	0.004	848.800002	0.002

Note: The applicant defined the normal working voltage is from 3.6Vdc to 4.35Vdc.

Frequency Error vs. Temperature

Temp. (°C)	GSM 850			
	Low Channel		High Channel	
	Frequency (MHz)	Frequency Error (ppm)	Frequency (MHz)	Frequency Error (ppm)
-30	824.200000	0.000	848.800003	0.003
-20	824.200000	0.000	848.800002	0.002
-10	824.200001	0.001	848.800002	0.002
0	824.200004	0.004	848.800004	0.005
10	824.200002	0.002	848.800003	0.003
20	824.199999	-0.001	848.799999	-0.001
30	824.199998	-0.003	848.799996	-0.005
40	824.199998	-0.002	848.799998	-0.002
50	824.199997	-0.003	848.799998	-0.002
60	824.200000	0.000	848.799997	-0.003

Frequency Error vs. Voltage

Voltage (Volts)	EDGE 850			
	Low Channel		High Channel	
	Frequency (MHz)	Frequency Error (ppm)	Frequency (MHz)	Frequency Error (ppm)
3.8	824.200002	0.003	848.800003	0.004
3.6	824.200002	0.002	848.800003	0.004
4.35	824.200003	0.003	848.800003	0.004

Note: The applicant defined the normal working voltage is from 3.6Vdc to 4.35Vdc.

Frequency Error vs. Temperature

Temp. (°C)	EDGE 850			
	Low Channel		High Channel	
	Frequency (MHz)	Frequency Error (ppm)	Frequency (MHz)	Frequency Error (ppm)
-30	824.200000	0.000	848.800002	0.002
-20	824.200000	0.000	848.800001	0.002
-10	824.200001	0.001	848.800004	0.004
0	824.200001	0.002	848.800001	0.002
10	824.200001	0.002	848.800002	0.002
20	824.199997	-0.004	848.799997	-0.004
30	824.199996	-0.005	848.799998	-0.002
40	824.199999	-0.002	848.799999	-0.002
50	824.199999	-0.002	848.799997	-0.003
60	824.200000	0.000	848.799997	-0.003

Frequency Error vs. Voltage

Voltage (Volts)	WCDMA Band 5			
	Low Channel		High Channel	
	Frequency (MHz)	Frequency Error (ppm)	Frequency (MHz)	Frequency Error (ppm)
3.8	826.400002	0.002	846.600002	0.002
3.6	826.400003	0.003	846.600003	0.003
4.35	826.400002	0.003	846.600001	0.002

Note: The applicant defined the normal working voltage is from 3.6Vdc to 4.35Vdc.

Frequency Error vs. Temperature

Temp. (°C)	WCDMA Band 5			
	Low Channel		High Channel	
	Frequency (MHz)	Frequency Error (ppm)	Frequency (MHz)	Frequency Error (ppm)
-30	826.400000	0.000	846.600003	0.004
-20	826.400000	0.000	846.600001	0.001
-10	826.400001	0.002	846.600002	0.002
0	826.400002	0.002	846.600003	0.003
10	826.400001	0.002	846.600004	0.005
20	826.399997	-0.004	846.599997	-0.004
30	826.399998	-0.002	846.599998	-0.003
40	826.399998	-0.002	846.599997	-0.003
50	826.399998	-0.002	846.599997	-0.003
60	826.400000	0.000	846.599996	-0.004

Frequency Error vs. Voltage

Voltage (Volts)	LTE Band 5			
	Channel Bandwidth: 1.4 MHz			
	Low Channel		High Channel	
	Frequency (MHz)	Frequency Error (ppm)	Frequency (MHz)	Frequency Error (ppm)
3.8	824.700003	0.003	848.300001	0.001
3.6	824.700004	0.005	848.300002	0.002
4.35	824.700002	0.002	848.300002	0.002

Note: The applicant defined the normal working voltage is from 3.6Vdc to 4.35Vdc.

Frequency Error vs. Temperature

Temp. (°C)	LTE Band 5			
	Channel Bandwidth: 1.4 MHz			
	Low Channel		High Channel	
	Frequency (MHz)	Frequency Error (ppm)	Frequency (MHz)	Frequency Error (ppm)
-30	824.700000	0.000	848.300002	0.002
-20	824.700000	0.000	848.300003	0.003
-10	824.700002	0.002	848.300001	0.001
0	824.700002	0.003	848.300004	0.005
10	824.700004	0.004	848.300002	0.002
20	824.699997	-0.004	848.299997	-0.003
30	824.699998	-0.003	848.299998	-0.002
40	824.699998	-0.003	848.299997	-0.003
50	824.699997	-0.003	848.299999	-0.002
60	824.700000	0.000	848.299997	-0.003

Frequency Error vs. Voltage

Voltage (Volts)	LTE Band 5			
	Channel Bandwidth: 3 MHz			
	Low Channel		High Channel	
	Frequency (MHz)	Frequency Error (ppm)	Frequency (MHz)	Frequency Error (ppm)
3.8	825.500003	0.004	847.500002	0.002
3.6	825.500004	0.004	847.500003	0.004
4.35	825.500004	0.005	847.500002	0.003

Note: The applicant defined the normal working voltage is from 3.6Vdc to 4.35Vdc.

Frequency Error vs. Temperature

Temp. (°C)	LTE Band 5			
	Channel Bandwidth: 3 MHz			
	Low Channel		High Channel	
	Frequency (MHz)	Frequency Error (ppm)	Frequency (MHz)	Frequency Error (ppm)
-30	825.500000	0.000	847.500003	0.003
-20	825.500000	0.000	847.500001	0.001
-10	825.500003	0.004	847.500001	0.002
0	825.500004	0.005	847.500003	0.003
10	825.500003	0.003	847.500004	0.004
20	825.499998	-0.003	847.499997	-0.004
30	825.499998	-0.003	847.499996	-0.005
40	825.499999	-0.002	847.499998	-0.003
50	825.499997	-0.004	847.499998	-0.002
60	825.500000	0.000	847.499997	-0.004

Frequency Error vs. Voltage

Voltage (Volts)	LTE Band 5			
	Channel Bandwidth: 5 MHz			
	Low Channel		High Channel	
	Frequency (MHz)	Frequency Error (ppm)	Frequency (MHz)	Frequency Error (ppm)
3.8	826.500003	0.003	846.500002	0.002
3.6	826.500003	0.003	846.500001	0.002
4.35	826.500001	0.001	846.500002	0.002

Note: The applicant defined the normal working voltage is from 3.6Vdc to 4.35Vdc.

Frequency Error vs. Temperature

Temp. (°C)	LTE Band 5			
	Channel Bandwidth: 5 MHz			
	Low Channel		High Channel	
	Frequency (MHz)	Frequency Error (ppm)	Frequency (MHz)	Frequency Error (ppm)
-30	826.500000	0.000	846.500003	0.003
-20	826.500000	0.000	846.500002	0.002
-10	826.500001	0.001	846.500002	0.002
0	826.500002	0.003	846.500003	0.004
10	826.500003	0.003	846.500002	0.002
20	826.499997	-0.004	846.499998	-0.003
30	826.499997	-0.004	846.499998	-0.002
40	826.499996	-0.005	846.499998	-0.003
50	826.499998	-0.002	846.499998	-0.002
60	826.500000	0.000	846.499997	-0.004

Frequency Error vs. Voltage

Voltage (Volts)	LTE Band 5			
	Channel Bandwidth: 10 MHz			
	Low Channel		High Channel	
	Frequency (MHz)	Frequency Error (ppm)	Frequency (MHz)	Frequency Error (ppm)
3.8	829.000001	0.001	844.000003	0.003
3.6	829.000002	0.003	844.000003	0.004
4.35	829.000002	0.002	844.000002	0.002

Note: The applicant defined the normal working voltage is from 3.6Vdc to 4.35Vdc.

Frequency Error vs. Temperature

Temp. (°C)	LTE Band 5			
	Channel Bandwidth: 10 MHz			
	Low Channel		High Channel	
	Frequency (MHz)	Frequency Error (ppm)	Frequency (MHz)	Frequency Error (ppm)
-30	829.000000	0.000	844.000002	0.002
-20	829.000000	0.000	844.000004	0.005
-10	829.000002	0.002	844.000003	0.003
0	829.000001	0.002	844.000002	0.002
10	829.000004	0.005	844.000002	0.002
20	828.999997	-0.004	843.999997	-0.004
30	828.999996	-0.005	843.999998	-0.002
40	828.999997	-0.004	843.999999	-0.001
50	828.999997	-0.004	843.999999	-0.001
60	829.000000	0.000	843.999997	-0.004

4.4 Occupied Bandwidth Measurement

4.4.1 Test Procedure

The EUT makes a call to the communication simulator. All measurements were done at low, middle and high operational frequency range. The communication simulator station system controlled a EUT to export maximum output power under transmission mode and specific channel frequency. Use OBW measurement function of Spectrum analyzer to measure 99 % occupied bandwidth.

4.4.2 Test Setup

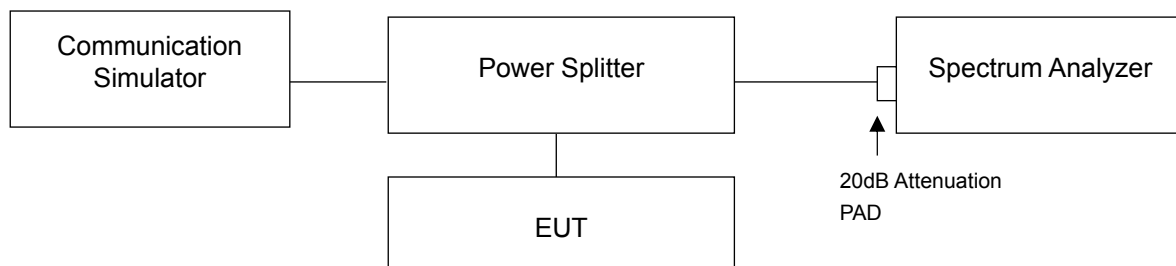

4.4.3 Test Result

Occupied Bandwidth GSM

Channel	Frequency (MHz)	99% Occupied Bandwidth (kHz)		
		GSM	GPRS	EDGE
128	824.2	260.00	250.00	250.00
189	836.4	250.00	250.00	250.00
251	848.8	260.00	250.00	250.00

Spectrum Plot of Worst Value

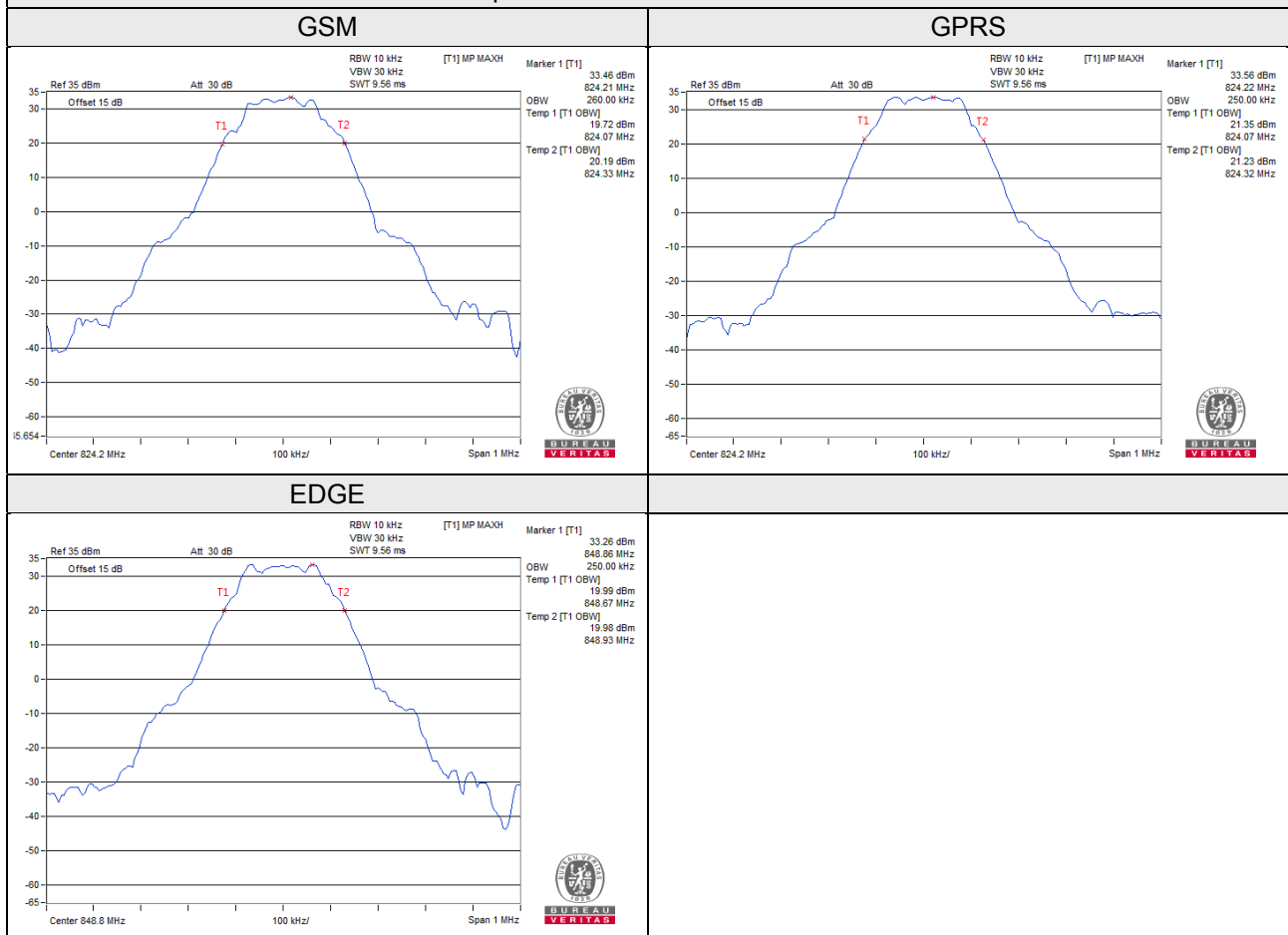

WCDMA Band 5

Channel	Frequency (MHz)	99% Occupied Bandwidth (MHz)		
		WCDMA	HSDPA	HSUPA
4132	826.4	4.13	4.13	4.13
4182	836.4	4.15	4.15	4.16
4233	846.6	4.15	4.15	4.13

Spectrum Plot of Worst Value

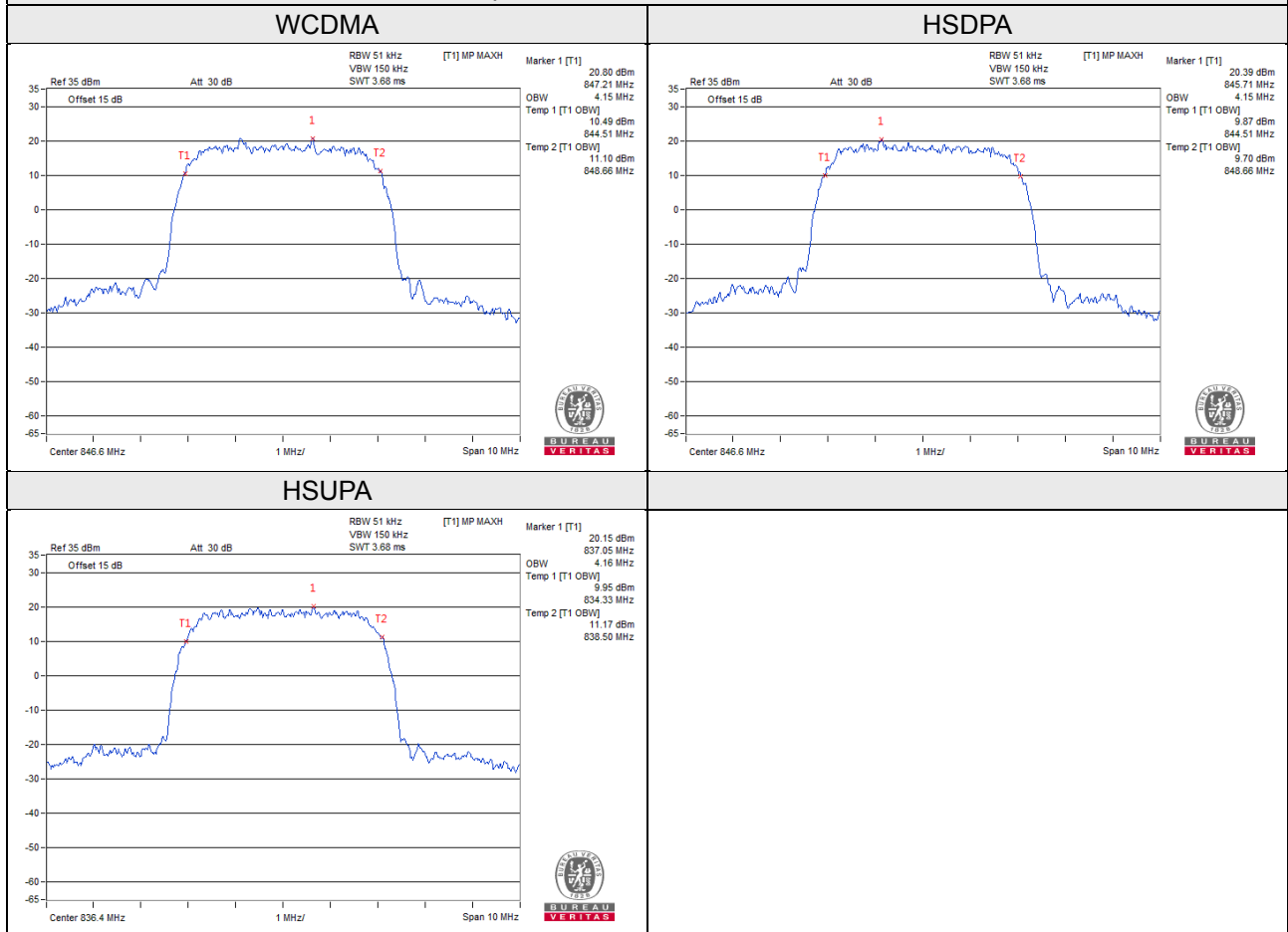

LTE Band 5

LTE Band 5, Channel Bandwidth 1.4MHz				
Channel	Frequency (MHz)	99% Occupied Bandwidth (MHz)		
		QPSK	16QAM	64QAM
20407	824.7	1.09	1.09	1.09
20525	836.5	1.09	1.09	1.09
20643	848.3	1.09	1.09	1.09
LTE Band 5, Channel Bandwidth 3MHz				
Channel	Frequency (MHz)	99% Occupied Bandwidth (MHz)		
		QPSK	16QAM	64QAM
20415	825.5	2.70	2.69	2.70
20525	836.5	2.70	2.70	2.70
20635	847.5	2.70	2.70	2.70
LTE Band 5, Channel Bandwidth 5MHz				
Channel	Frequency (MHz)	99% Occupied Bandwidth (MHz)		
		QPSK	16QAM	64QAM
20425	826.5	4.48	4.49	4.48
20525	836.5	4.49	4.49	4.49
20625	846.5	4.49	4.49	4.49
LTE Band 5, Channel Bandwidth 10MHz				
Channel	Frequency (MHz)	99% Occupied Bandwidth (MHz)		
		QPSK	16QAM	64QAM
20450	829.0	8.93	8.93	8.93
20525	836.5	8.97	8.97	8.96
20600	844.0	8.93	8.93	8.92

Spectrum Plot of Worst Value

1.4MHz / 64QAM

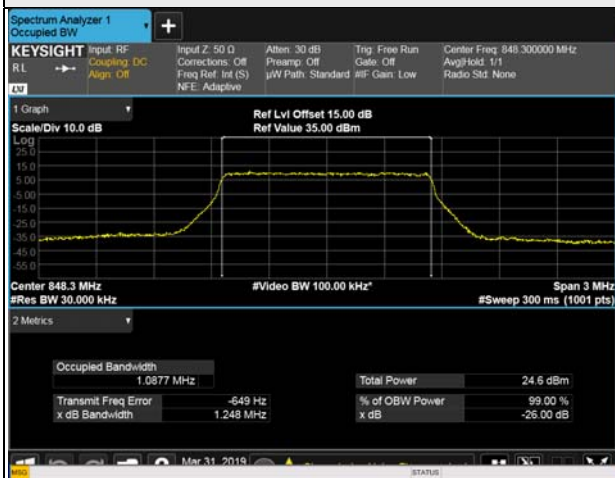

3MHz / QPSK



5MHz / 16QAM



10MHz / 16QAM



26dB Bandwidth
GSM

Channel	Frequency (MHz)	26dB Bandwidth (kHz)		
		GSM	GPRS	EDGE
128	824.2	316.28	313.423	317.30
189	836.4	304.75	314.175	314.04
251	848.8	314.79	319.961	310.98

Spectrum Plot of Worst Value

GSM

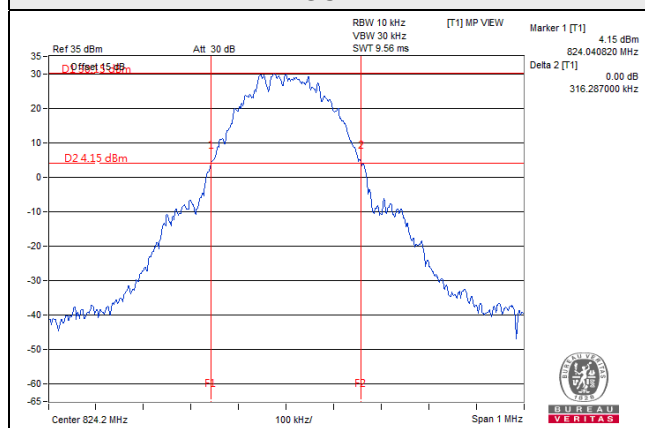

GPRS

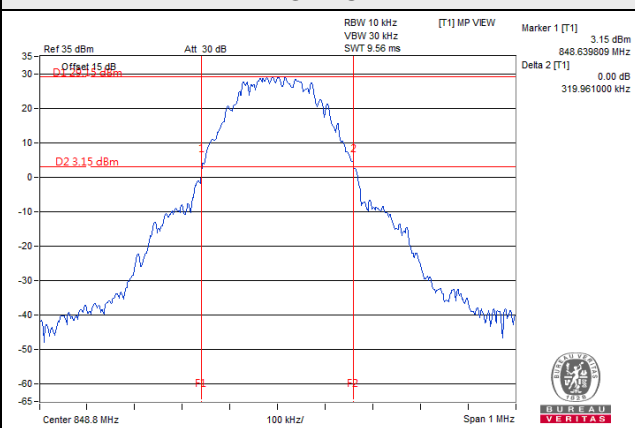

EDGE

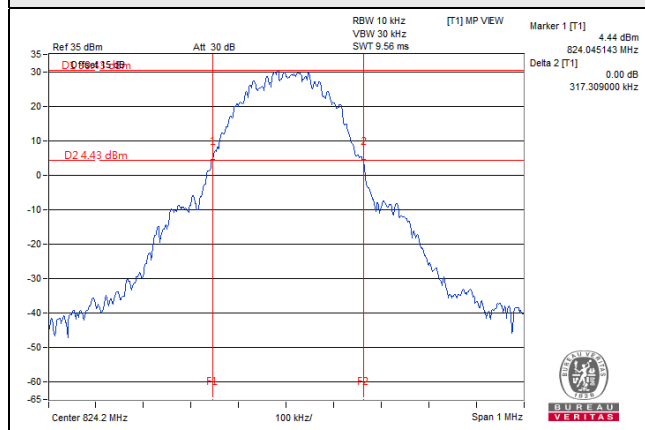

WCDMA Band 5

Channel	Frequency (MHz)	26dB Bandwidth (MHz)		
		WCDMA	HSDPA	HSUPA
4132	826.4	4.68	4.70	4.68
4182	836.4	4.66	4.71	4.70
4233	846.6	4.69	4.69	4.68

Spectrum Plot of Worst Value

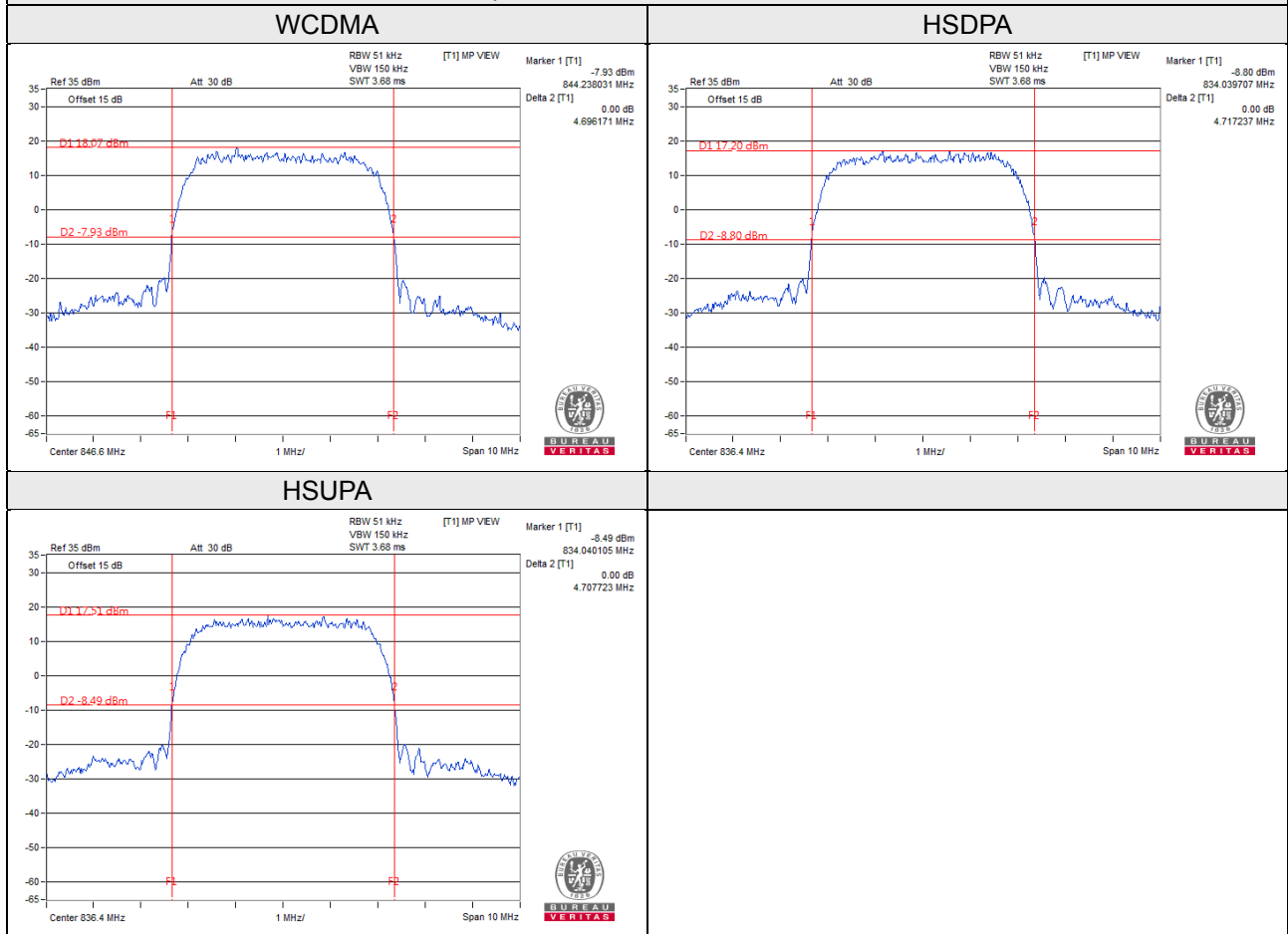

LTE Band 5

LTE Band 5, Channel Bandwidth 1.4MHz				
Channel	Frequency (MHz)	26dB Bandwidth (MHz)		
		QPSK	16QAM	64QAM
20407	824.7	1.24	1.25	1.25
20525	836.5	1.24	1.25	1.26
20643	848.3	1.24	1.24	1.25
LTE Band 5, Channel Bandwidth 3MHz				
Channel	Frequency (MHz)	26dB Bandwidth (MHz)		
		QPSK	16QAM	64QAM
20415	825.5	2.91	2.92	2.92
20525	836.5	2.92	2.93	2.92
20635	847.5	2.91	2.92	2.90
LTE Band 5, Channel Bandwidth 5MHz				
Channel	Frequency (MHz)	26dB Bandwidth (MHz)		
		QPSK	16QAM	64QAM
20425	826.5	4.81	4.79	4.80
20525	836.5	4.81	4.81	4.82
20625	846.5	4.81	4.82	4.81
LTE Band 5, Channel Bandwidth 10MHz				
Channel	Frequency (MHz)	26dB Bandwidth (MHz)		
		QPSK	16QAM	64QAM
20450	829.0	9.48	9.49	9.50
20525	836.5	9.53	9.53	9.53
20600	844.0	9.49	9.50	9.49

Spectrum Plot of Worst Value

1.4MHz / 64QAM



3MHz / 16QAM

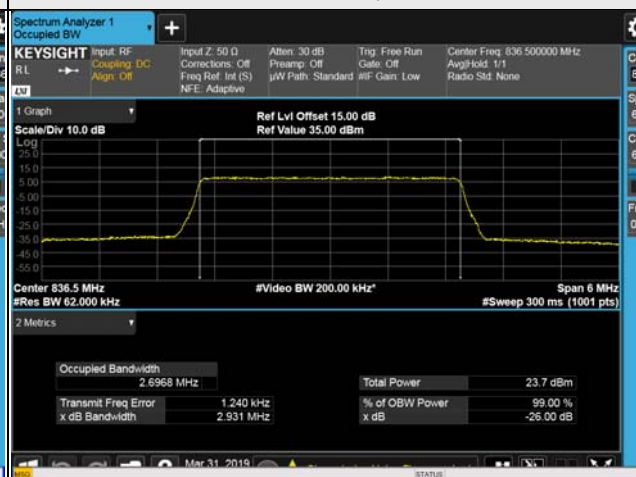

5MHz / 64QAM



10MHz / 64QAM



4.5 Band Edge Measurement

4.5.1 Limits of Band Edge Measurement

Power of any emission outside of the authorized operating frequency ranges must be attenuated below the transmitting power (P) by a factor of at least $43 + 10 \log(P)$ dB. In the 1 MHz bands immediately outside and adjacent to the frequency block a resolution bandwidth of at least one percent of the emission bandwidth of the fundamental emission of the transmitter may be employed.

4.5.2 Test Setup

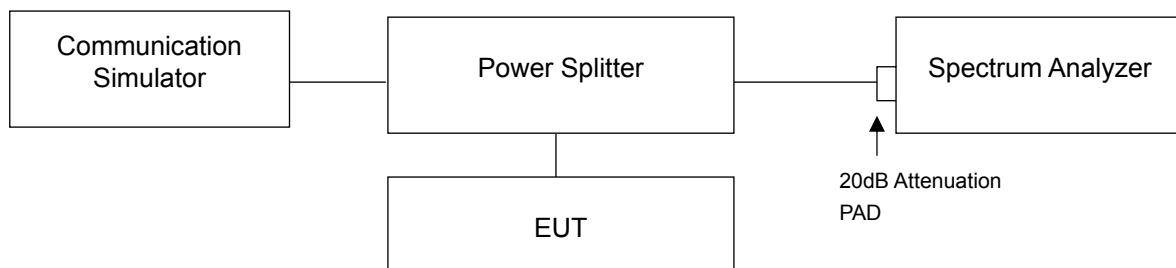

4.5.3 Test Procedures

- a. All measurements were done at low and high operational frequency range.
- b. The center frequency of spectrum is the band edge frequency and span is 1.5MHz. RB of the spectrum is 10kHz and VB of the spectrum is 30kHz (GSM / GPRS / EDGE).
- c. The center frequency of spectrum is the band edge frequency and span is 10MHz. RB of the spectrum is 51kHz and VB of the spectrum is 150kHz (WCDMA / HSDPA / HSUPA).
- d. The center frequency of spectrum is the band edge frequency and span is 1MHz. RB of the spectrum is 15kHz and VB of the spectrum is 51kHz (LTE Channel Bandwidth 1.4MHz).
- e. The center frequency of spectrum is the band edge frequency and span is 1MHz. RB of the spectrum is 30kHz and VB of the spectrum is 100kHz (LTE Channel Bandwidth 3MHz).
- f. The center frequency of spectrum is the band edge frequency and span is 1MHz. RB of the spectrum is 62kHz and VB of the spectrum is 200kHz (LTE Channel Bandwidth 5MHz).
- g. The center frequency of spectrum is the band edge frequency and span is 1MHz. RB of the spectrum is 100kHz and VB of the spectrum is 300kHz (LTE Channel Bandwidth 10MHz).
- h. The center frequency of spectrum is the band edge frequency and span is 1MHz. RB of the spectrum is 150kHz and VB of the spectrum is 470kHz (LTE Channel Bandwidth 15MHz).
- i. Record the max trace plot into the test report.

4.5.4 Test Results

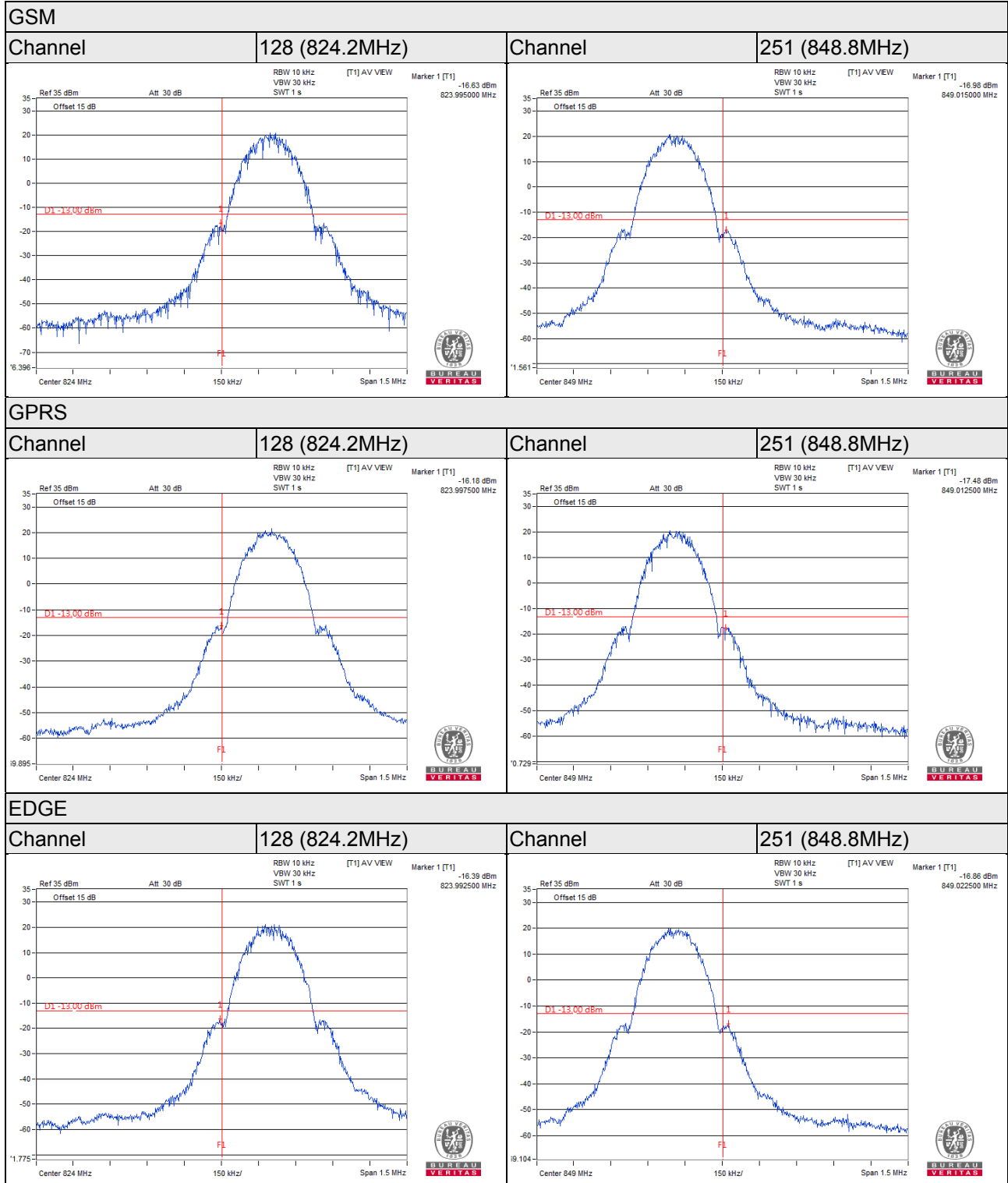

WCDMA

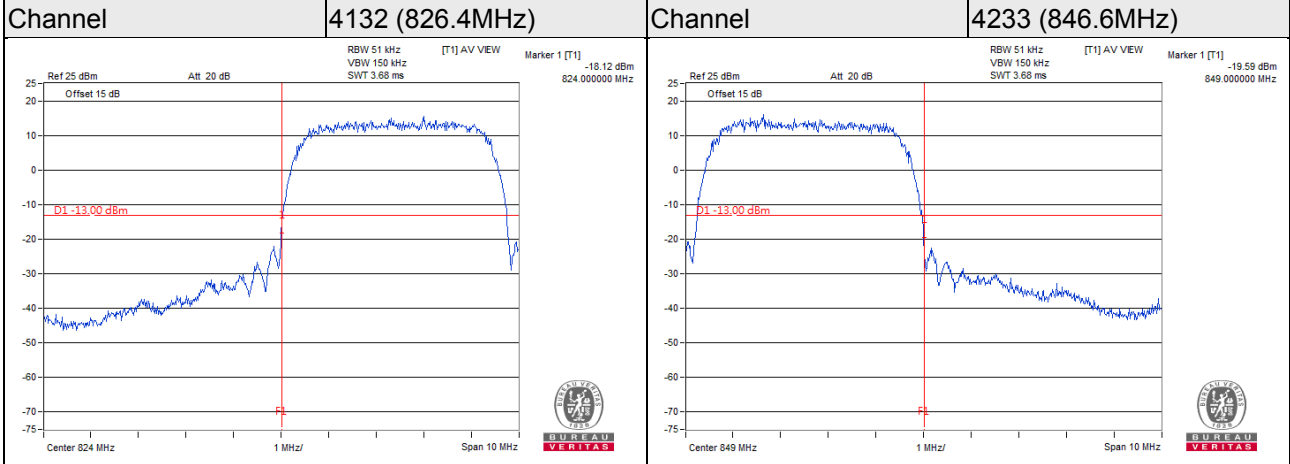

HSDPA

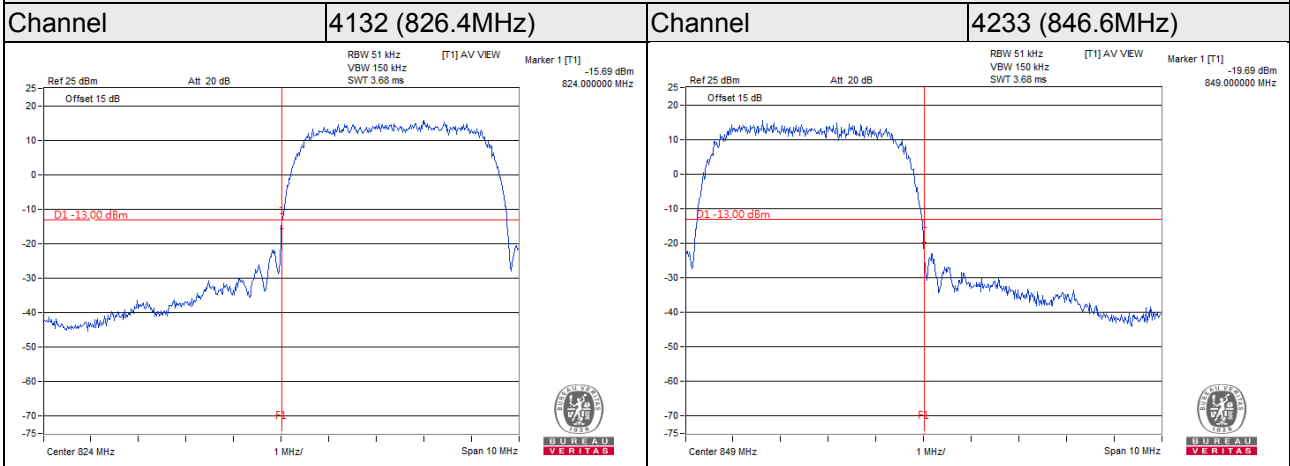

HSUPA

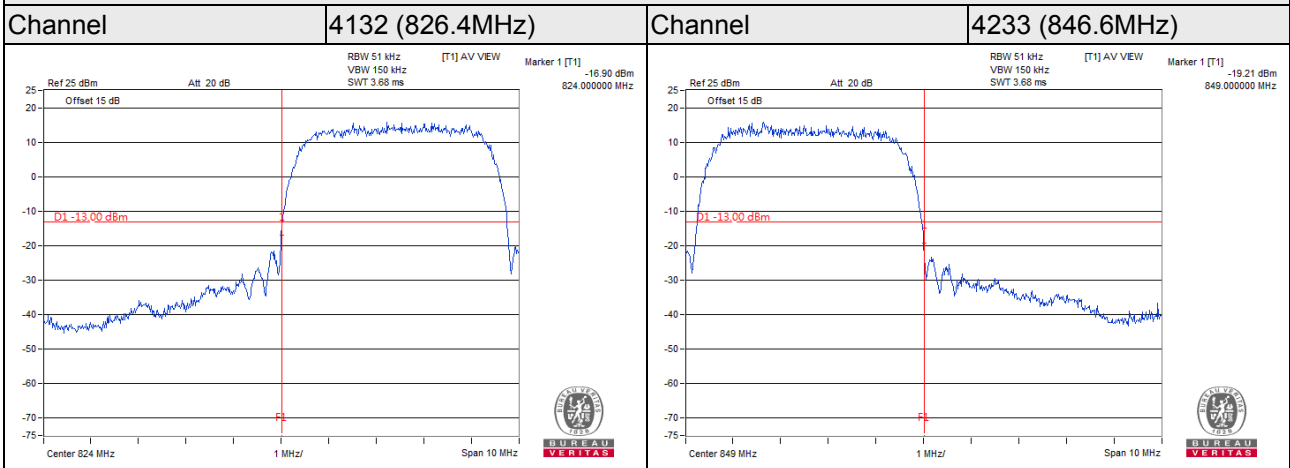

LTE Band 5, Channel Bandwidth 1.4MHz

Channel 20407
(824.7MHz)

QPSK

1 RB / 0 RB Offset

Channel 20643
(848.3MHz)

QPSK

1 RB / 5 RB Offset

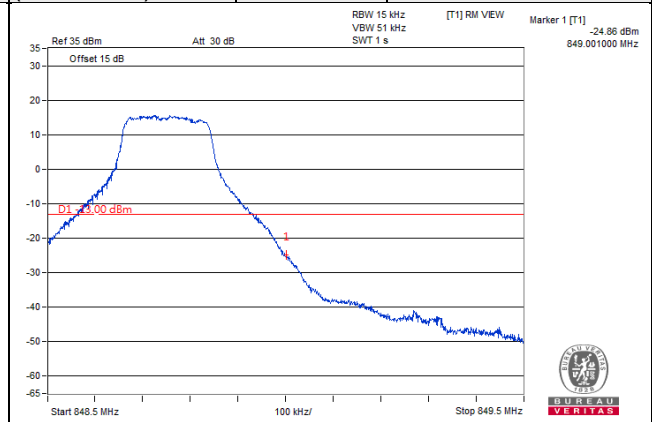
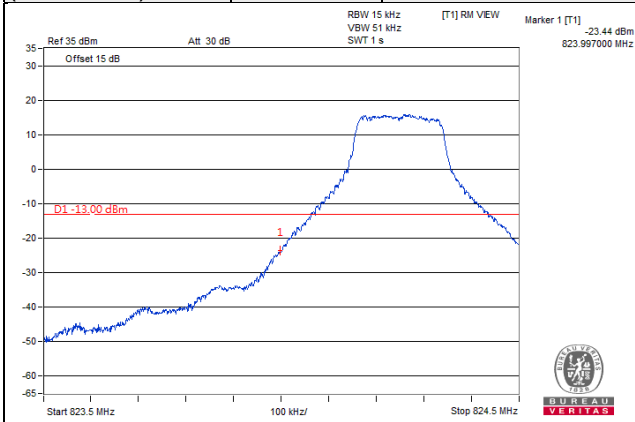

Channel 20407
(824.7MHz)

QPSK

6 RB / 0 RB Offset

Channel 20643
(848.3MHz)

QPSK

6 RB / 0 RB Offset

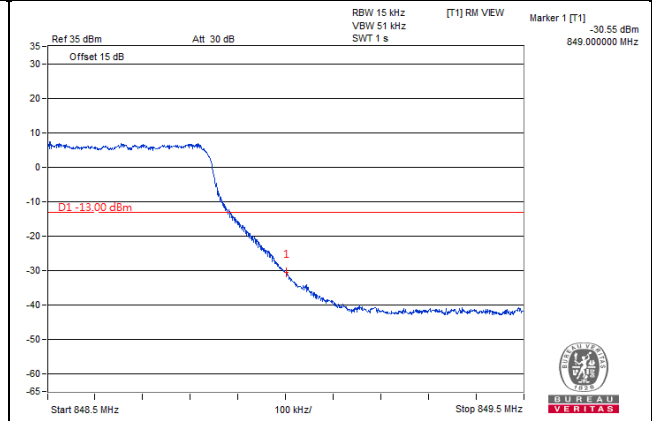
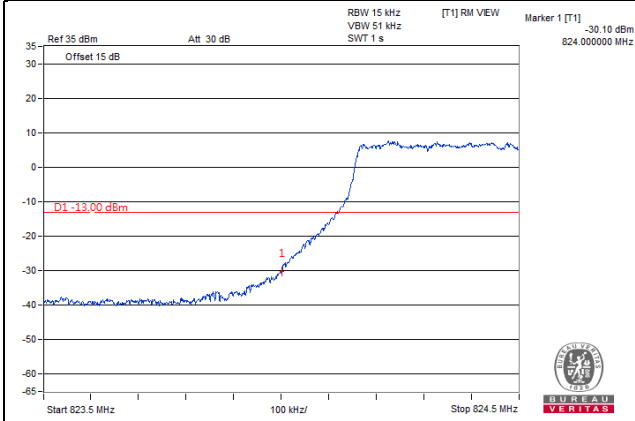

LTE Band 5, Channel Bandwidth 3MHz

Channel 20415
(825.5MHz)

QPSK

1 RB / 0 RB Offset

Channel 20635
(847.5MHz)

QPSK

1 RB / 14 RB Offset

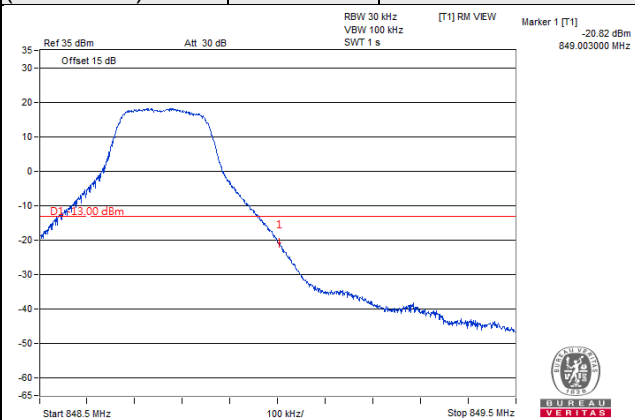
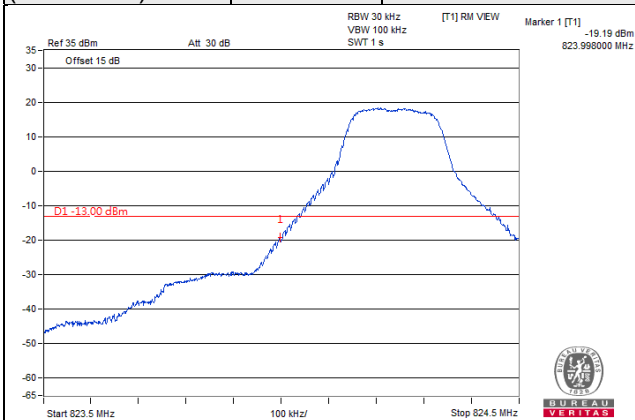

Channel 20415
(825.5MHz)

QPSK

15 RB / 0 RB Offset

Channel 20635
(847.5MHz)

QPSK

15 RB / 0 RB Offset

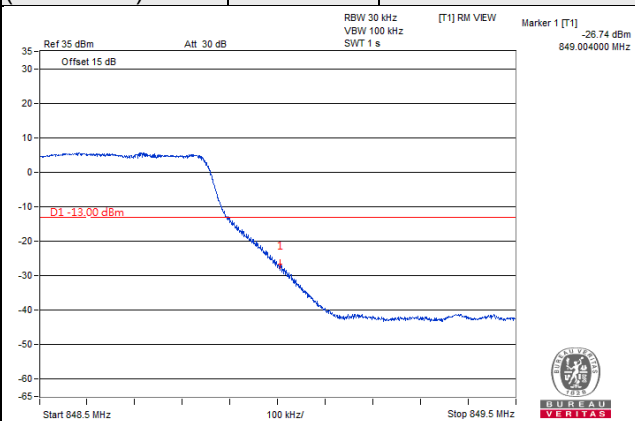
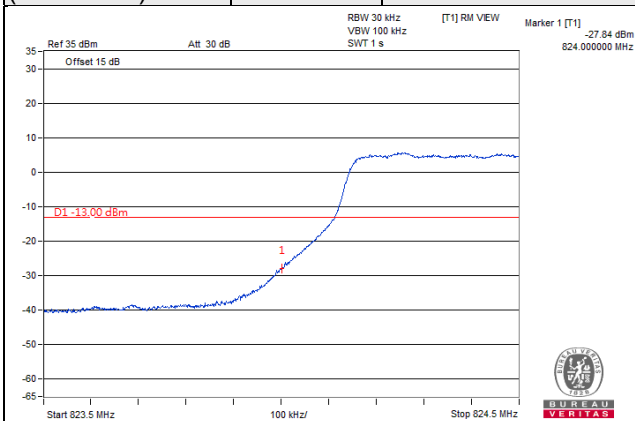

LTE Band 5, Channel Bandwidth 5MHz

Channel 20425
(826.5MHz)

QPSK

1 RB / 0 RB Offset

Channel 20625
(846.5MHz)

QPSK

1 RB / 24 RB Offset

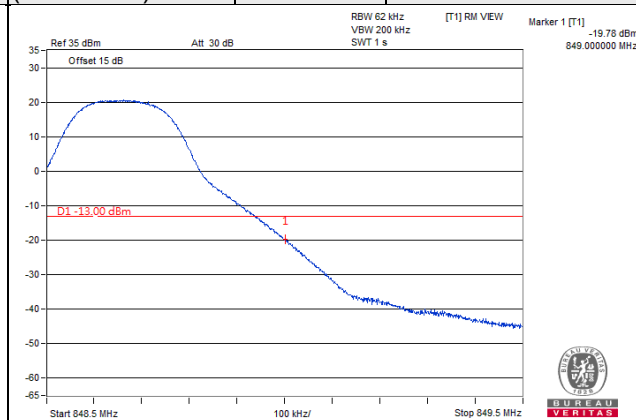
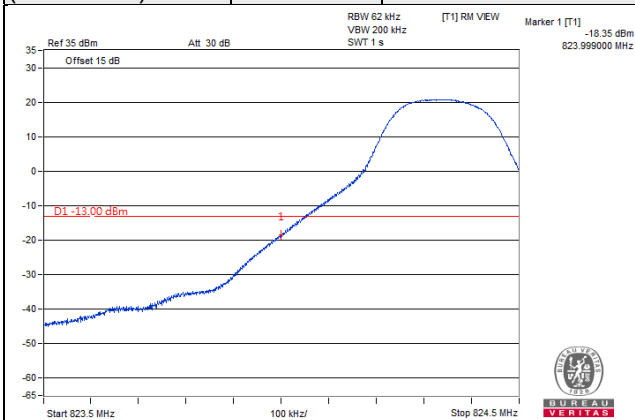

Channel 20425
(826.5MHz)

QPSK

25 RB / 0 RB Offset

Channel 20625
(846.5MHz)

QPSK

25 RB / 0 RB Offset

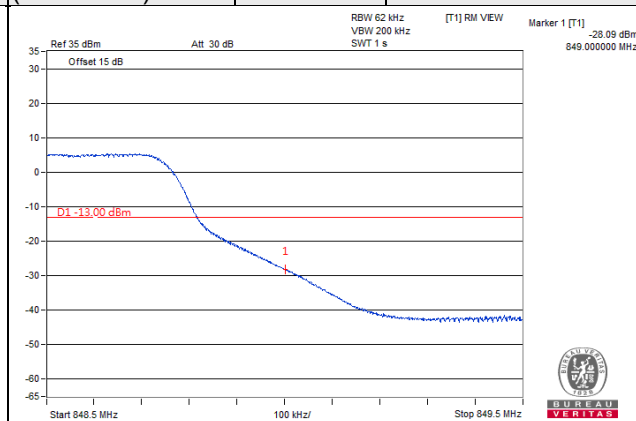
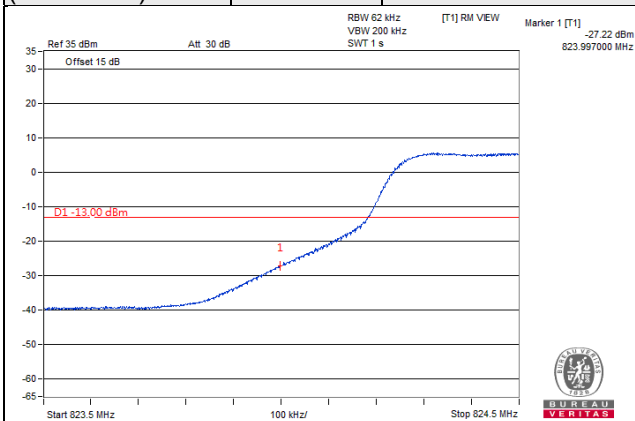

LTE Band 5, Channel Bandwidth 10MHz

Channel 20450 (829.0MHz)	QPSK	1 RB / 0 RB Offset	Channel 20600 (844.0MHz)	QPSK	1 RB / 49 RB Offset
-----------------------------	------	--------------------	-----------------------------	------	---------------------

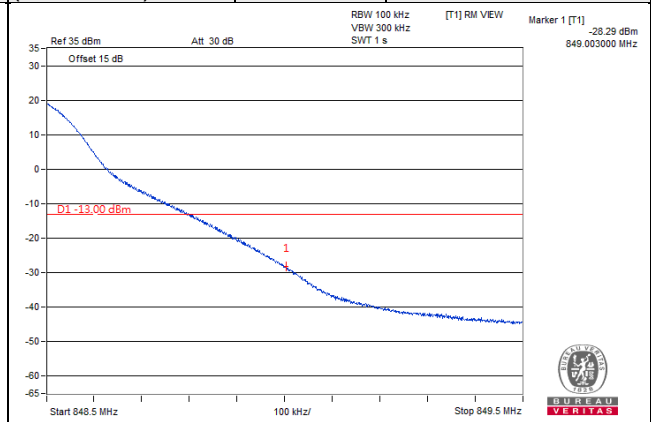
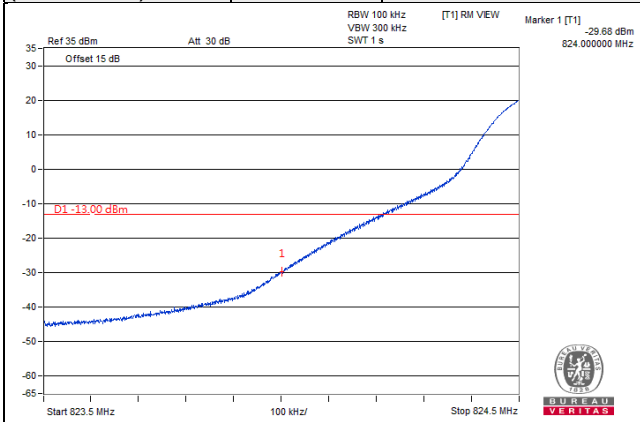

Channel 20450 (829.0MHz)	QPSK	50 RB / 0 RB Offset	Channel 20600 (844.0MHz)	QPSK	50 RB / 0 RB Offset
-----------------------------	------	---------------------	-----------------------------	------	---------------------

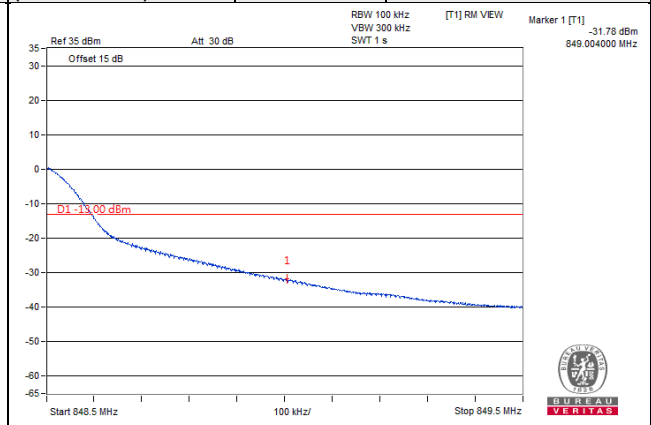
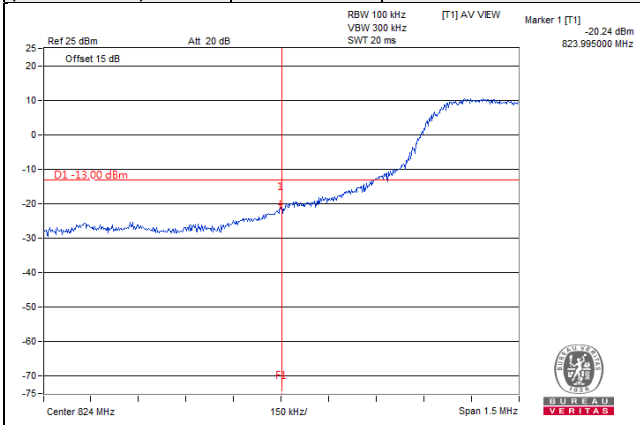

4.6 Peak to Average Ratio

4.6.1 Limits of Peak to Average Ratio Measurement

In measuring transmissions in this band using an average power technique, the peak to-average ratio (PAR) of the transmission may not exceed 13 dB

4.6.2 Test Setup

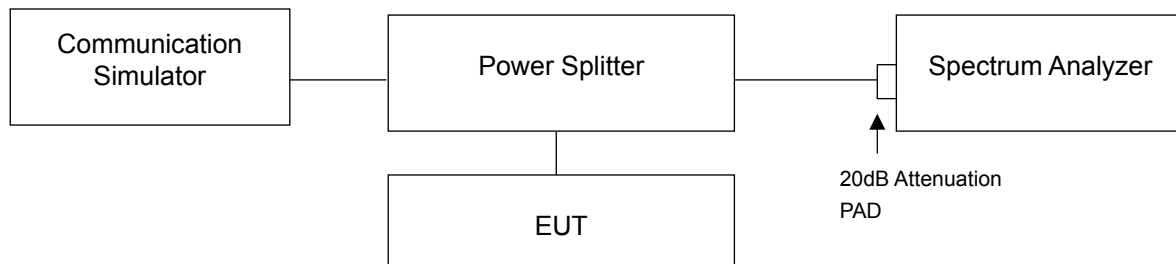

4.6.3 Test Procedures

- Set resolution/measurement bandwidth \geq signal's occupied bandwidth;
- Set the number of counts to a value that stabilizes the measured CCDF curve;
- Record the maximum PAPR level associated with a probability of 0.1%.

4.6.4 Test Results

GSM

Channel	Frequency (MHz)	Peak To Average Ratio (dB)		
		GSM	GPRS	EDGE
128	824.2	2.71	2.71	2.71
189	836.4	2.72	2.72	2.72
251	848.8	2.71	2.72	2.71

Spectrum Plot of Worst Value

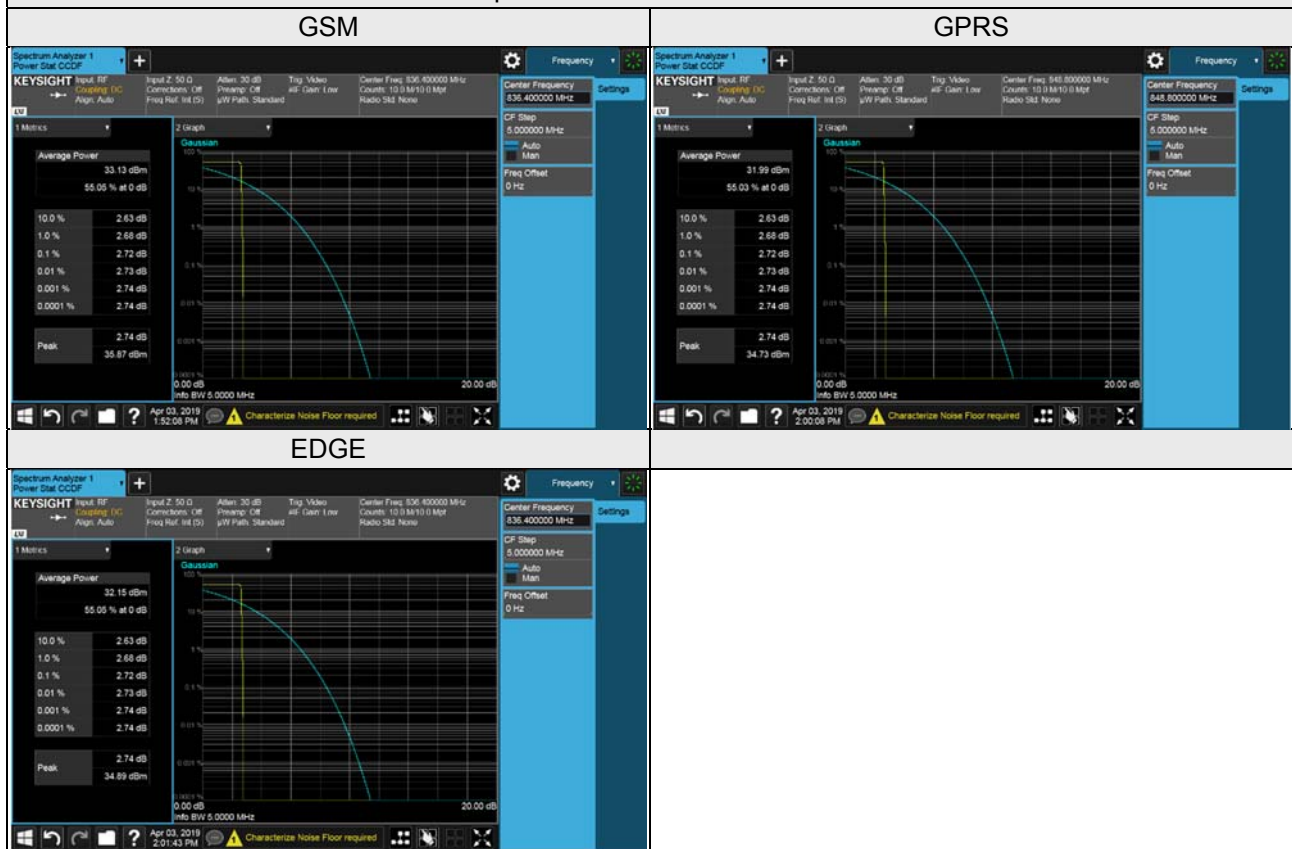

WCDMA Band 5

Channel	Frequency (MHz)	Peak To Average Ratio (dB)		
		WCDMA	HSDPA	HSUPA
4132	826.4	3.03	3.03	3.02
4182	836.4	2.94	2.95	2.95
4233	846.6	3.01	3.02	3.02

Spectrum Plot of Worst Value

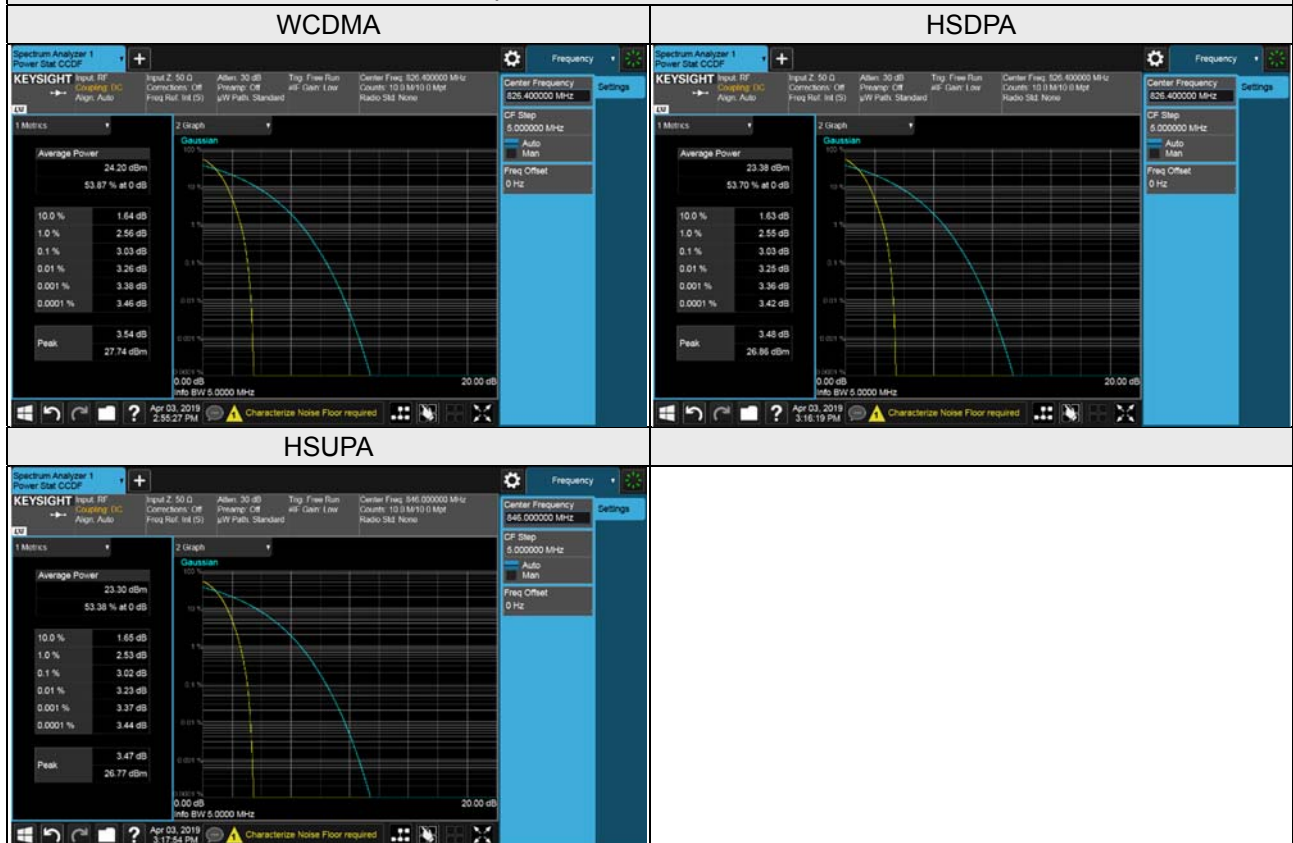

LTE Band 5

LTE Band 5, Channel Bandwidth 1.4MHz				
Channel	Frequency (MHz)	Peak To Average Ratio (dB)		
		QPSK	16QAM	64QAM
20407	824.7	4.52	5.33	5.42
20525	836.5	4.52	5.34	5.39
20643	848.3	4.50	5.46	5.38
LTE Band 5, Channel Bandwidth 3MHz				
Channel	Frequency (MHz)	Peak To Average Ratio (dB)		
		QPSK	16QAM	64QAM
20415	825.5	4.54	5.32	5.44
20525	836.5	4.54	5.38	5.47
20635	847.5	4.49	5.36	5.52
LTE Band 5, Channel Bandwidth 5MHz				
Channel	Frequency (MHz)	Peak To Average Ratio (dB)		
		QPSK	16QAM	64QAM
20425	826.5	4.51	5.30	5.40
20525	836.5	4.48	5.30	5.43
20625	846.5	4.44	5.32	5.39
LTE Band 5, Channel Bandwidth 10MHz				
Channel	Frequency (MHz)	Peak To Average Ratio (dB)		
		QPSK	16QAM	64QAM
20450	829.0	4.48	5.27	5.43
20525	836.5	4.53	5.26	5.54
20600	844.0	4.48	5.35	5.41

Spectrum Plot of Worst Value

1.4MHz / 16QAM

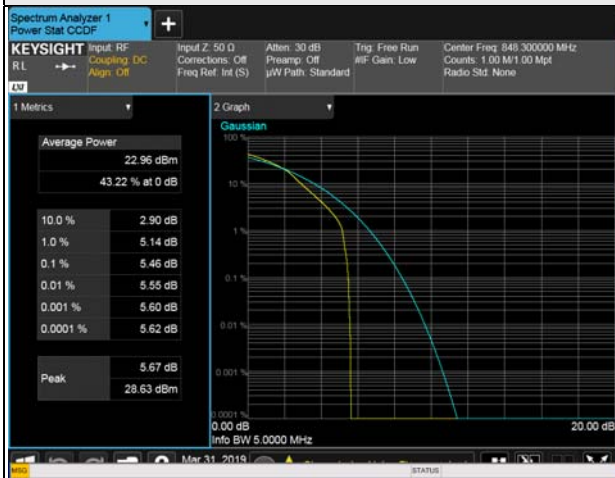

3MHz / 64QAM

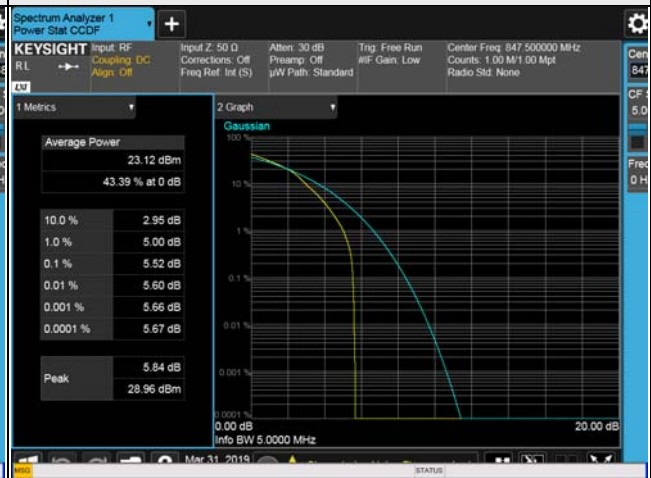

5MHz / 64QAM

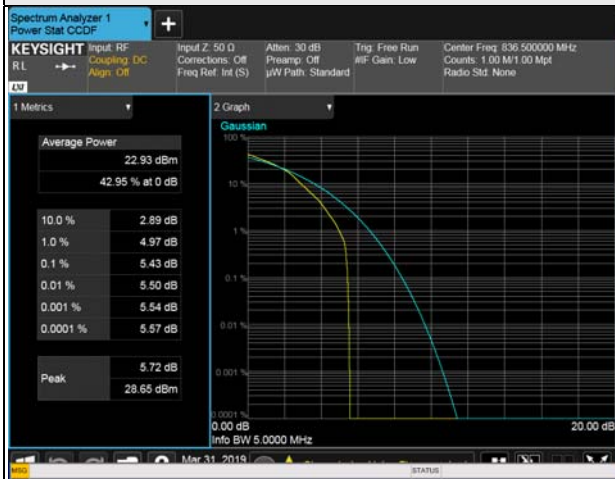

10MHz / 64QAM



4.7 Conducted Spurious Emissions

4.7.1 Limits of Conducted Spurious Emissions Measurement

The power of any emission outside of the authorized operating frequency ranges must be attenuated below the transmitting power (P) by a factor of at least $43 + 10 \log(P)$ dB. The emission limit equal to -13dBm .

4.7.2 Test Setup

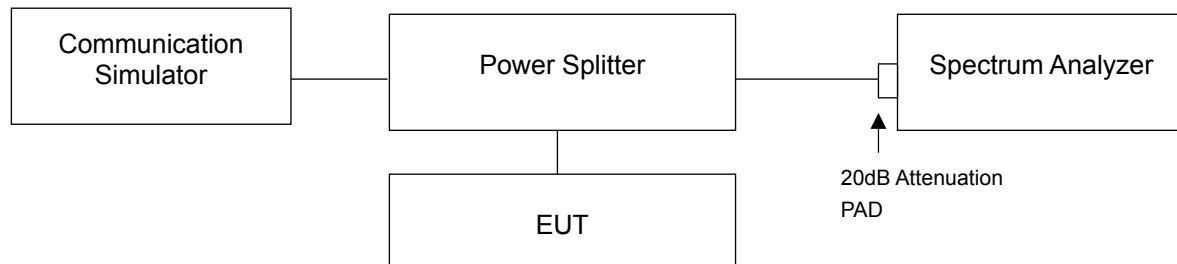

4.7.3 Test Procedure

- The EUT makes a phone call to the communication simulator. All measurements were done at low, middle and high operational frequency range.
- Measuring frequency range is from 9 kHz to 1GHz. 20dB attenuation pad is connected with spectrum. RBW=300kHz and VBW=1MHz is used for conducted emission measurement.
- Measuring frequency range is from 1GHz to 26.5GHz or 27GHz. 20dB attenuation pad is connected with spectrum. RBW=1MHz and VBW=3MHz is used for conducted emission measurement.

4.7.4 Test Results

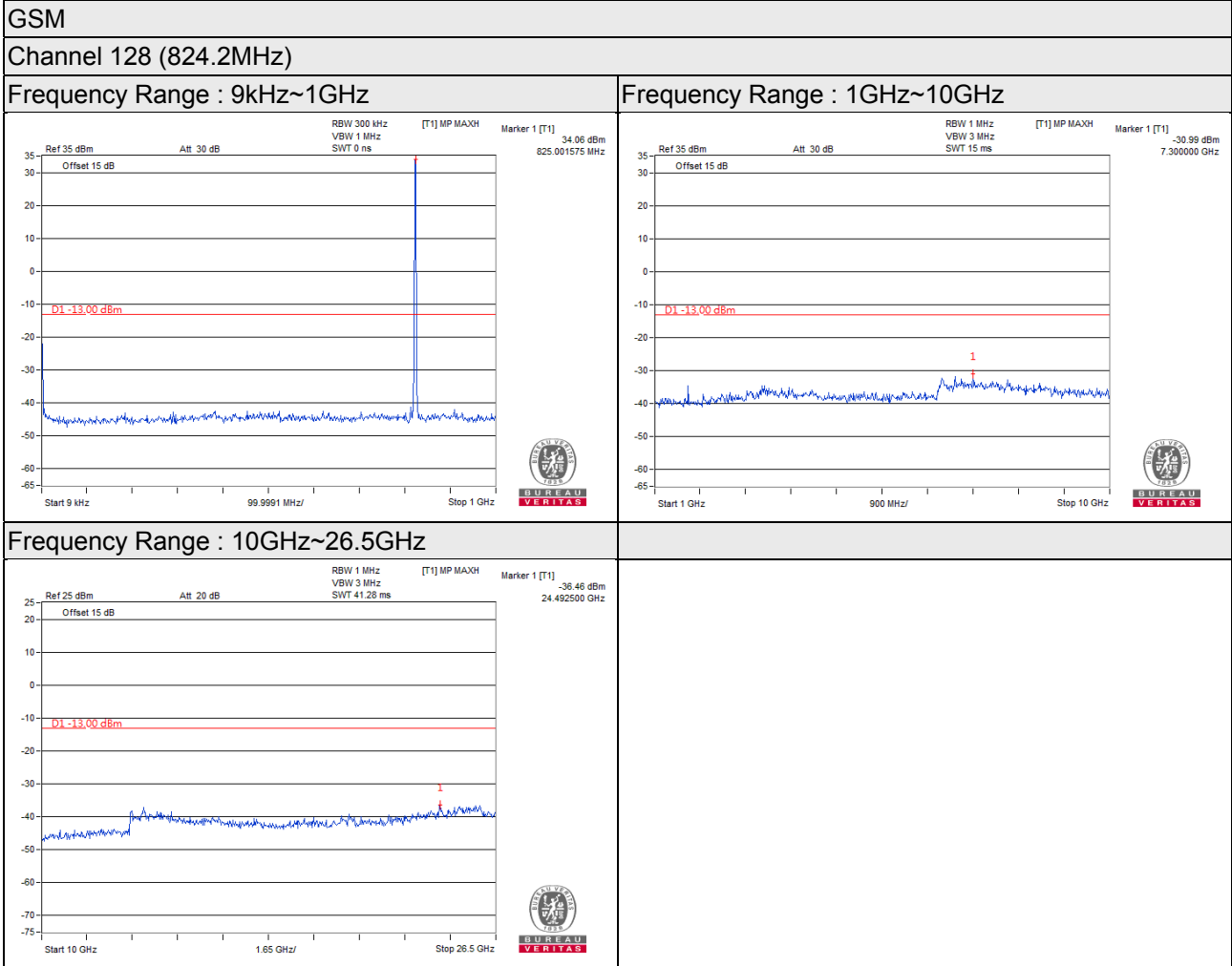

*The 9kHz signal over the limit is from Spectrum.

Channel 189 (836.4MHz)

Frequency Range : 9kHz~1GHz

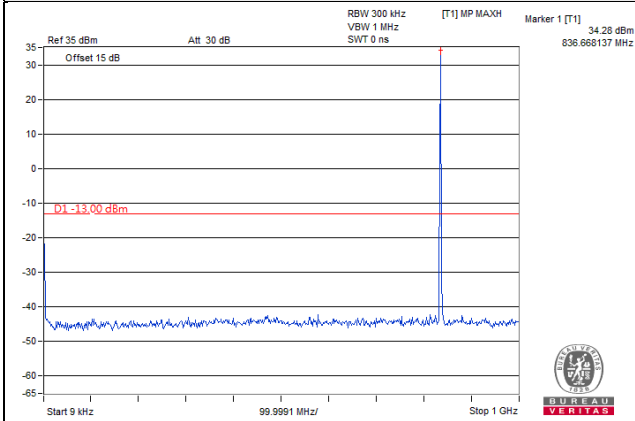

Frequency Range : 1GHz~10GHz

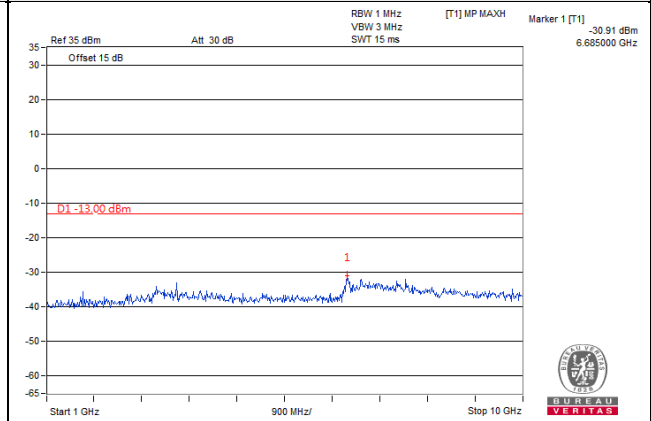

Frequency Range : 10GHz~26.5GHz

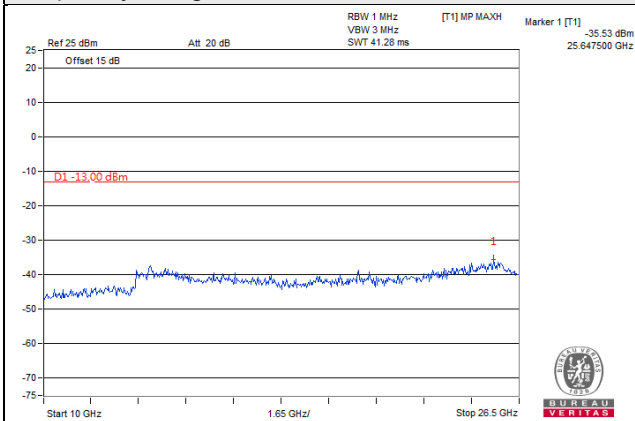

*The 9kHz signal over the limit is from Spectrum.

Channel 251 (848.8MHz)

Frequency Range : 9kHz~1GHz

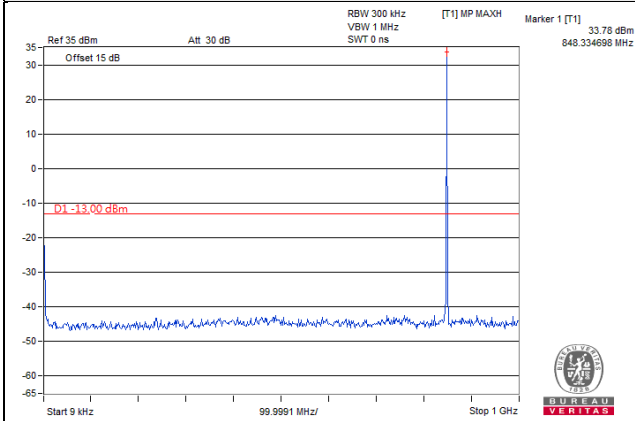

Frequency Range : 1GHz~10GHz

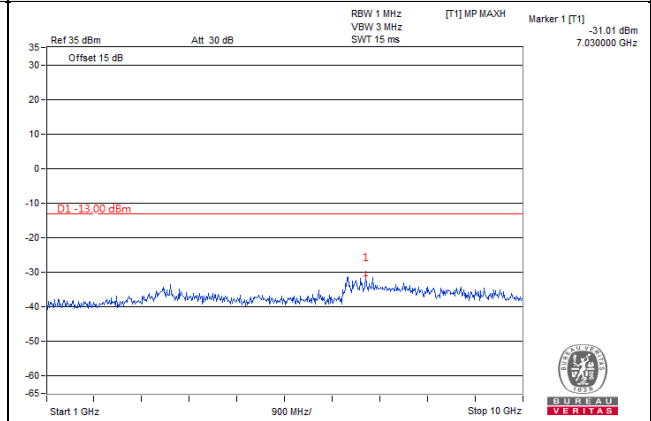

Frequency Range : 10GHz~26.5GHz

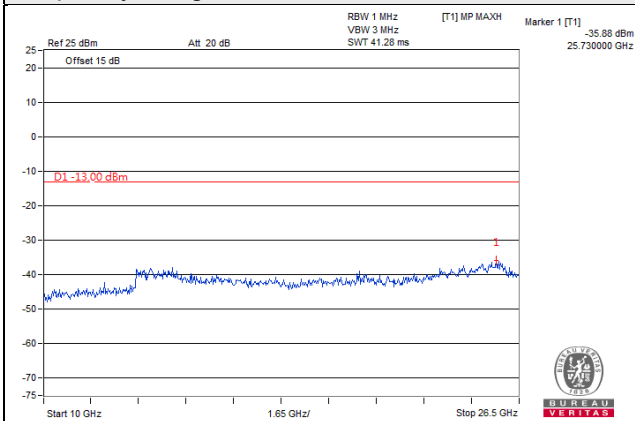

*The 9kHz signal over the limit is from Spectrum.

GPRS

Channel 128 (824.2MHz)

Frequency Range : 9kHz~1GHz

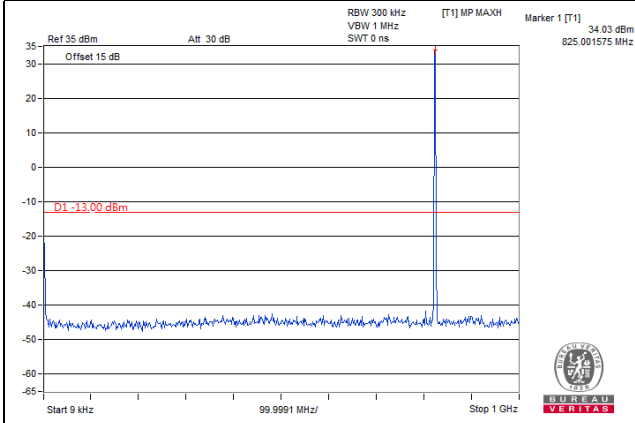

Frequency Range : 1GHz~10GHz

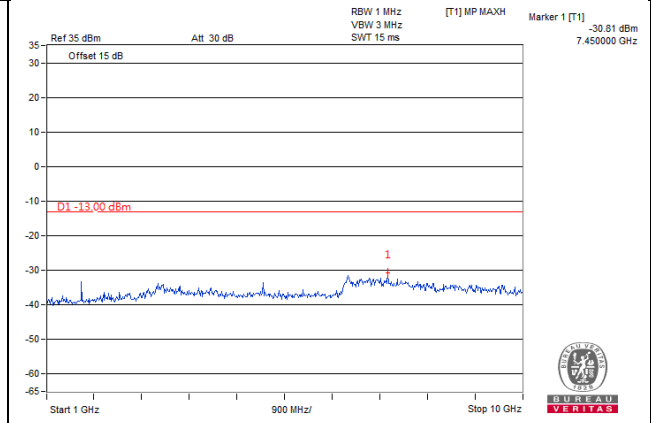

Frequency Range : 10GHz~26.5GHz

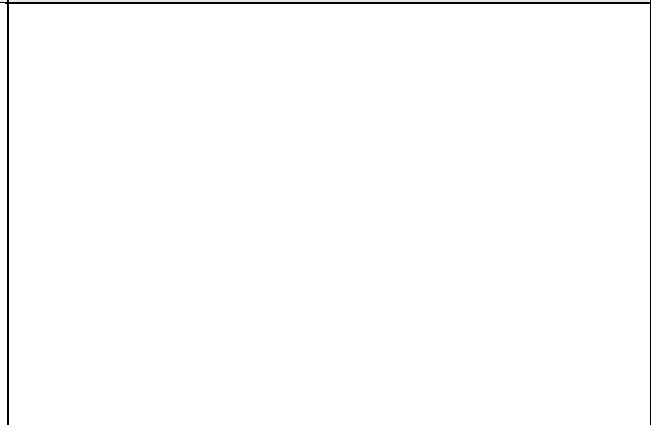
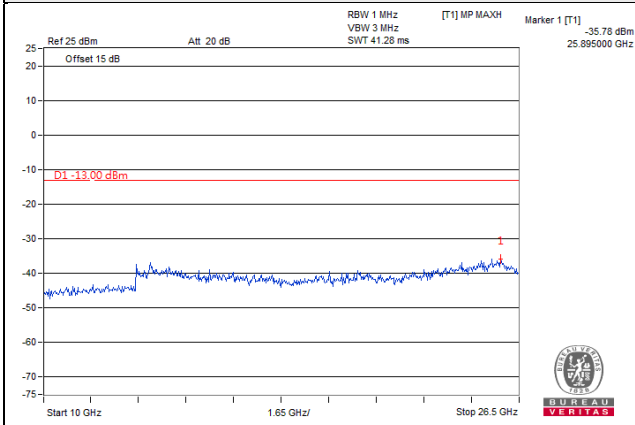

*The 9kHz signal over the limit is from Spectrum.

Channel 189 (836.4MHz)

Frequency Range : 9kHz~1GHz

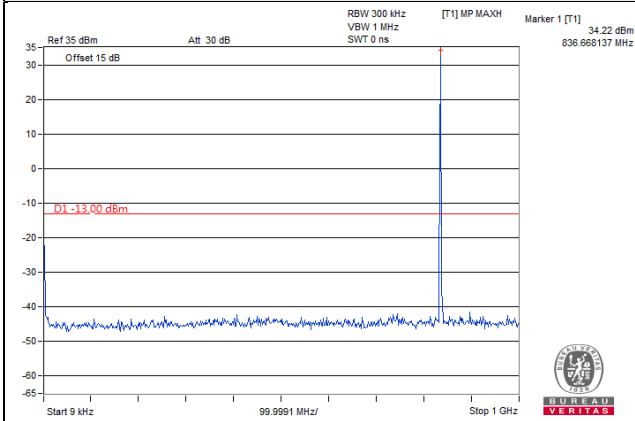

Frequency Range : 1GHz~10GHz

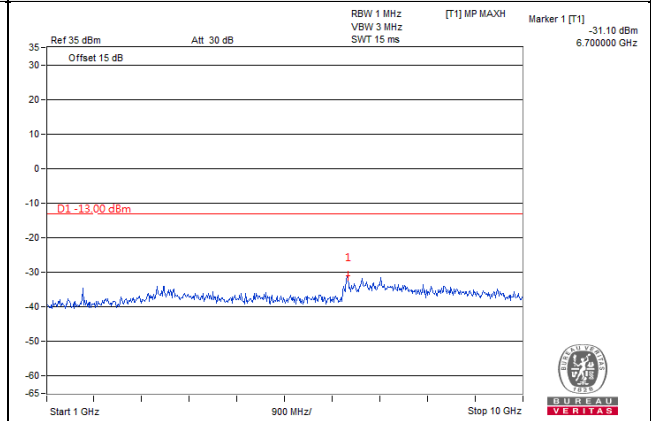

Frequency Range : 10GHz~26.5GHz

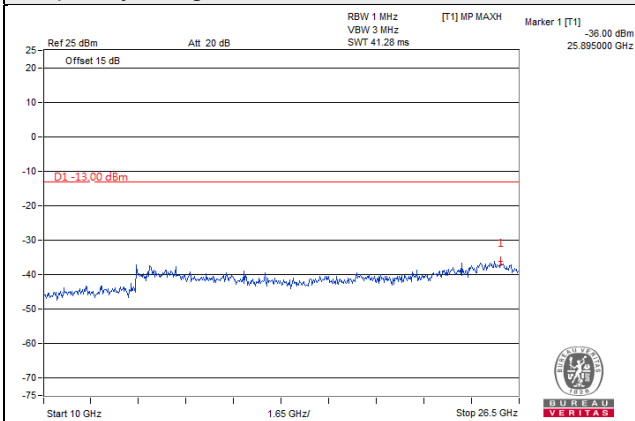

*The 9kHz signal over the limit is from Spectrum.

Channel 251 (848.8MHz)

Frequency Range : 9kHz~1GHz

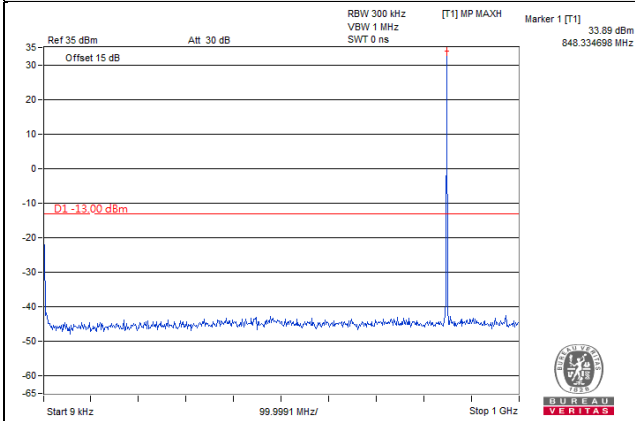

Frequency Range : 1GHz~10GHz

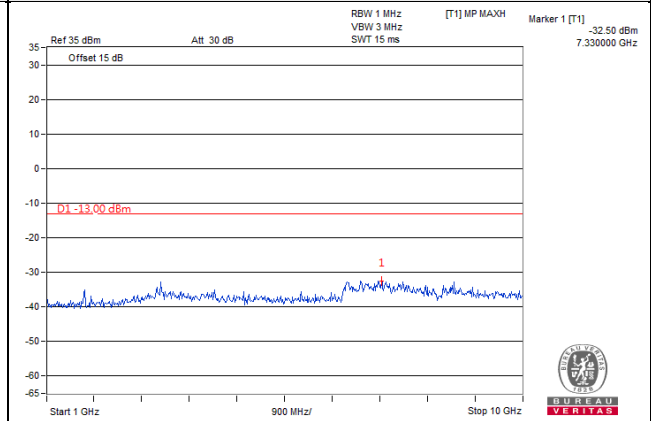

Frequency Range : 10GHz~26.5GHz

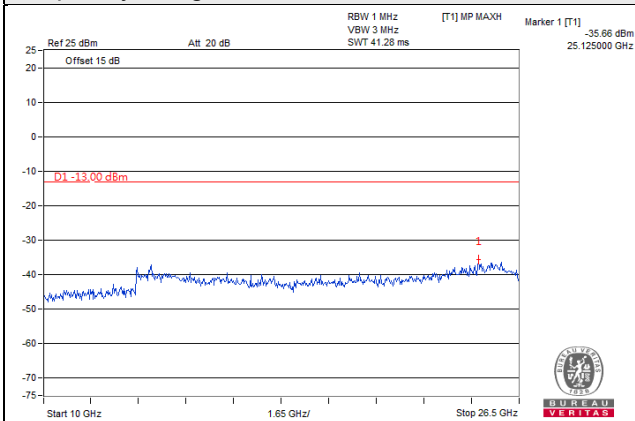

*The 9kHz signal over the limit is from Spectrum.

EDGE

Channel 128 (824.2MHz)

Frequency Range : 9kHz~1GHz

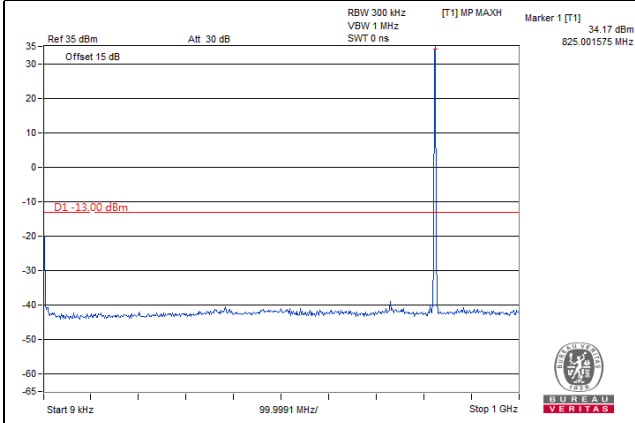

Frequency Range : 1GHz~10GHz

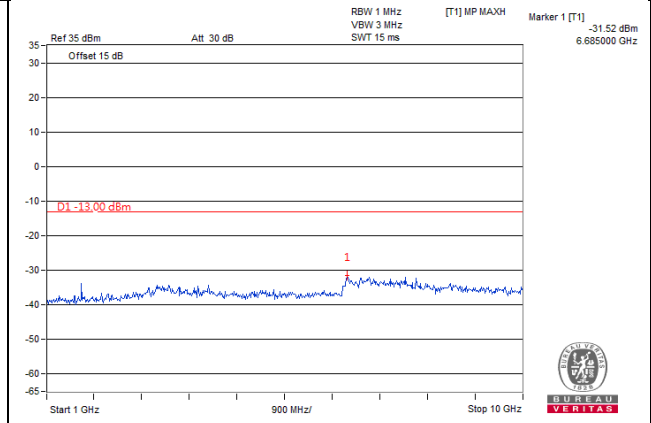

Frequency Range : 10GHz~26.5GHz

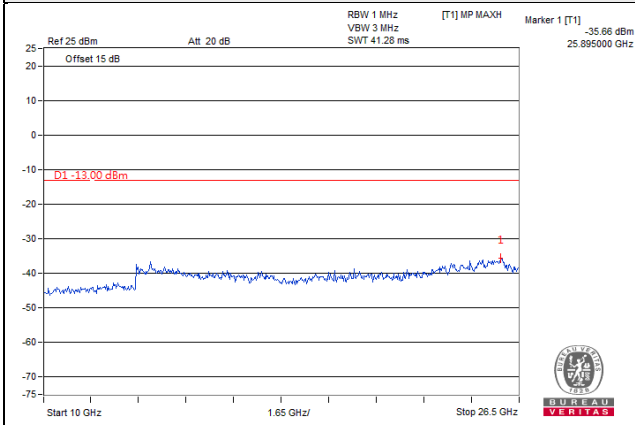

*The 9kHz signal over the limit is from Spectrum.

Channel 189 (836.4MHz)

Frequency Range : 9kHz~1GHz

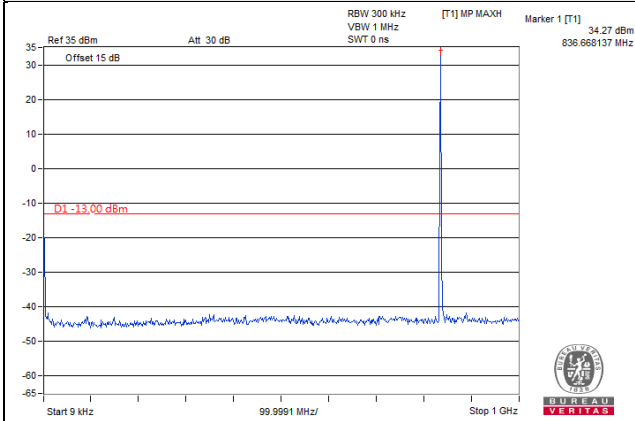

Frequency Range : 1GHz~10GHz

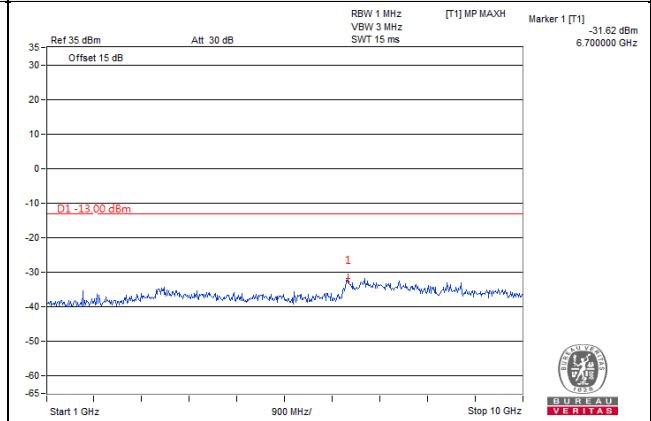

Frequency Range : 10GHz~26.5GHz

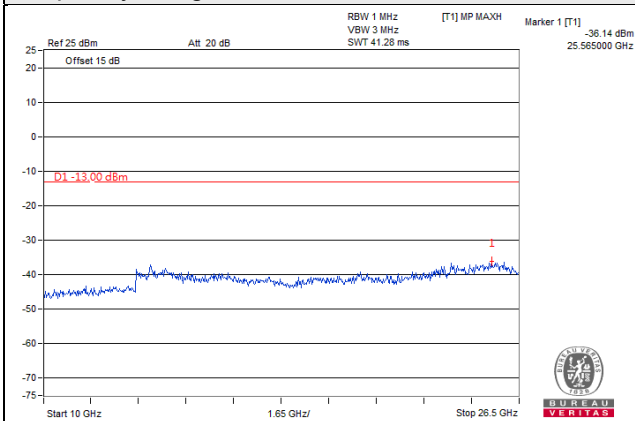

*The 9kHz signal over the limit is from Spectrum.

Channel 251 (848.8MHz)

Frequency Range : 9kHz~1GHz

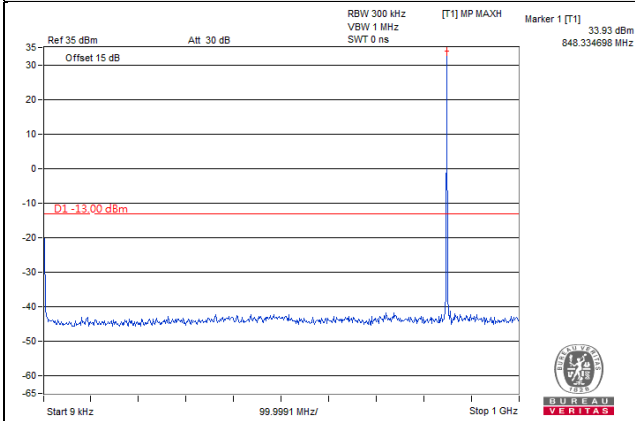

Frequency Range : 1GHz~10GHz

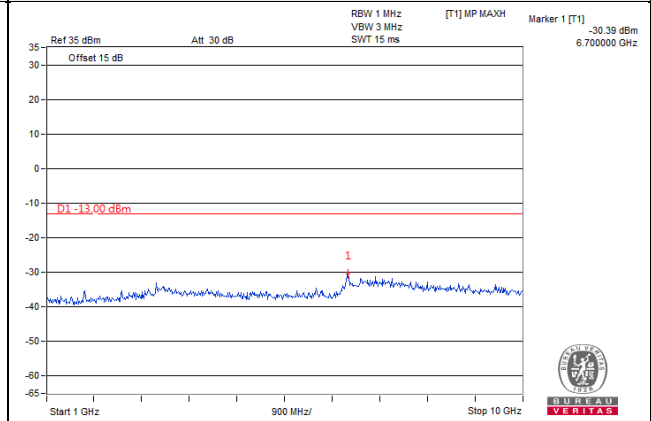

Frequency Range : 10GHz~26.5GHz

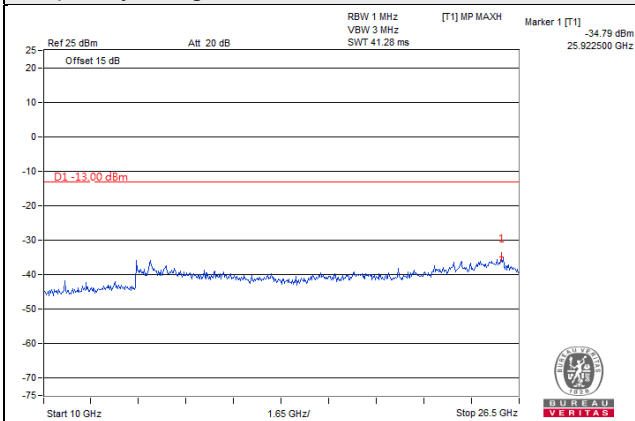

*The 9kHz signal over the limit is from Spectrum.

WCDMA

Channel 4132 (826.4MHz)

Frequency Range : 9kHz~1GHz

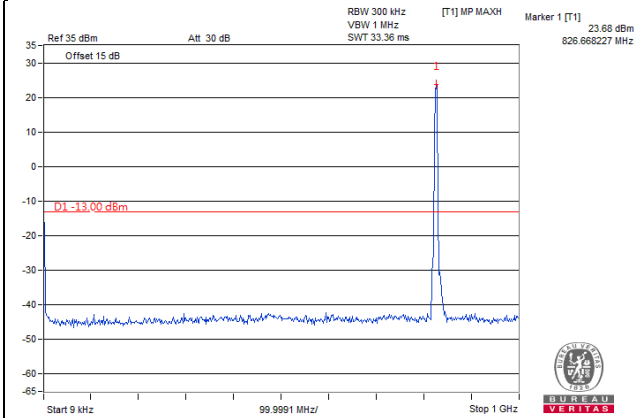

Frequency Range : 1GHz~10GHz

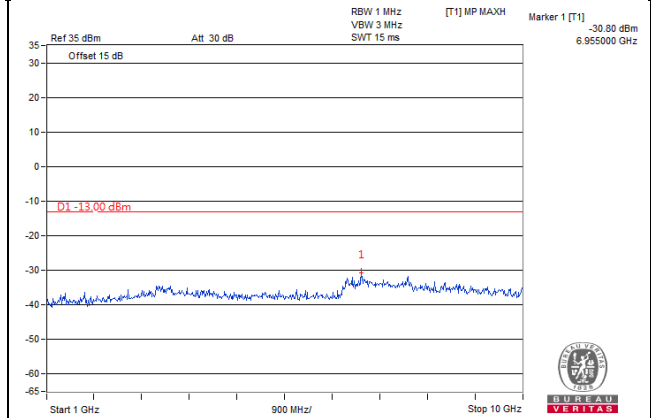

Frequency Range : 10GHz~26.5GHz

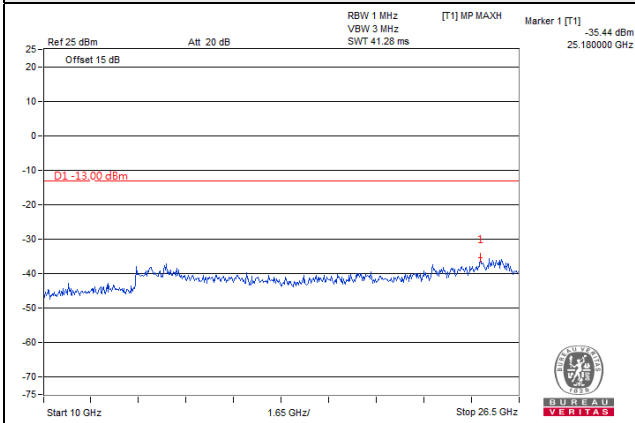

*The 9kHz signal over the limit is from Spectrum.

Channel 4182 (836.4MHz)

Frequency Range : 9kHz~1GHz

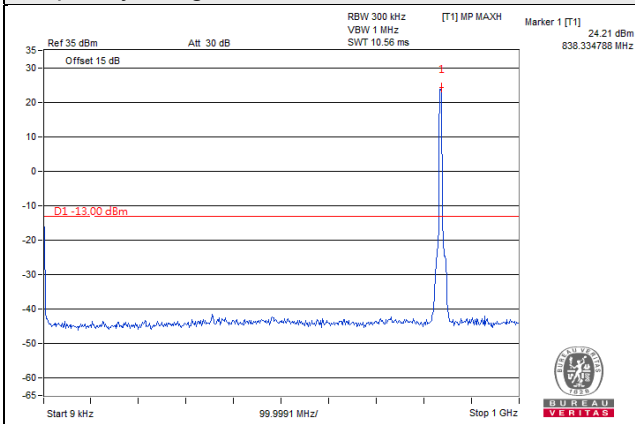

Frequency Range : 1GHz~10GHz

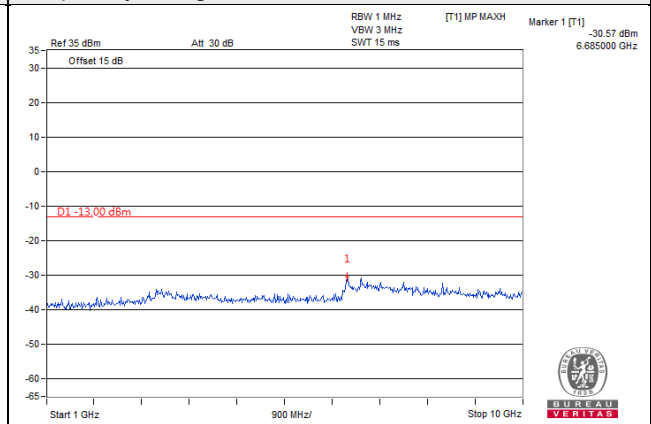

Frequency Range : 10GHz~26.5GHz

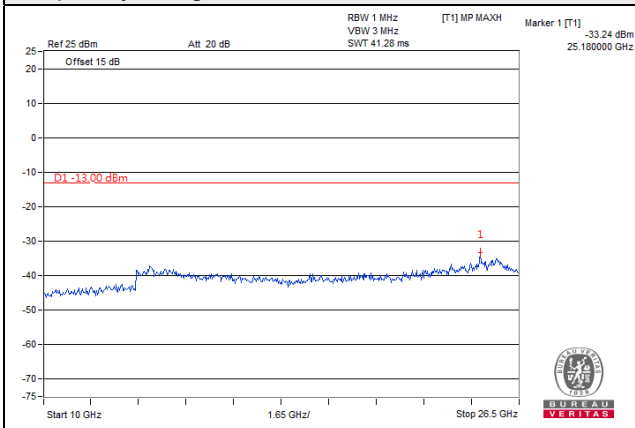

*The 9kHz signal over the limit is from Spectrum.

Channel 4233 (846.6MHz)

Frequency Range : 9kHz~1GHz

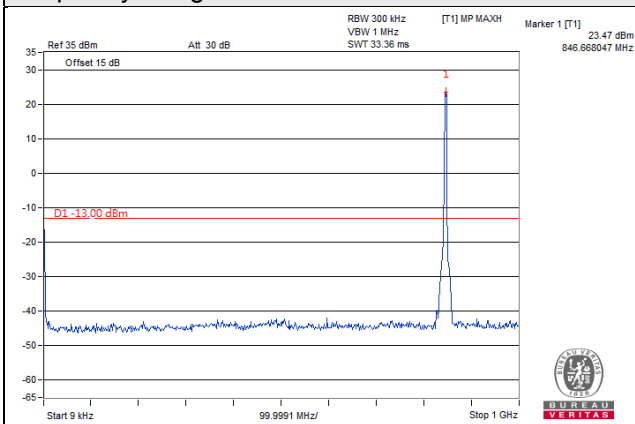

Frequency Range : 1GHz~10GHz

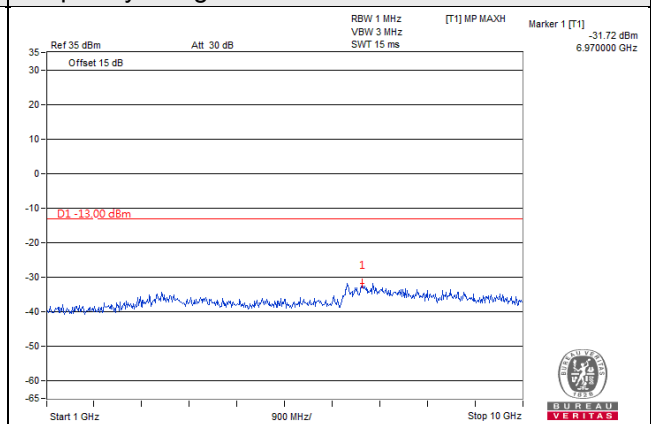

Frequency Range : 10GHz~26.5GHz

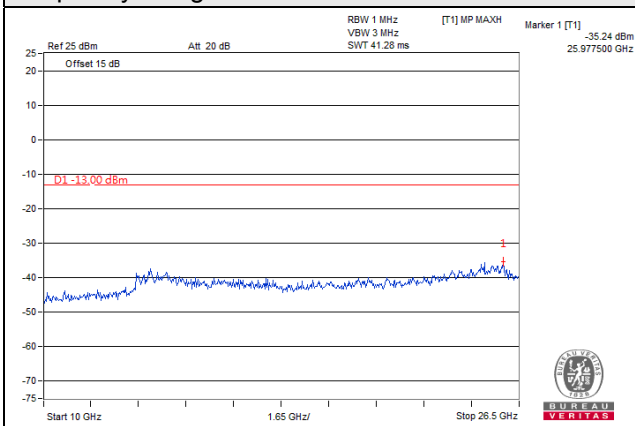

*The 9kHz signal over the limit is from Spectrum.

HSDPA

Channel 4132 (826.4MHz)

Frequency Range : 9kHz~1GHz

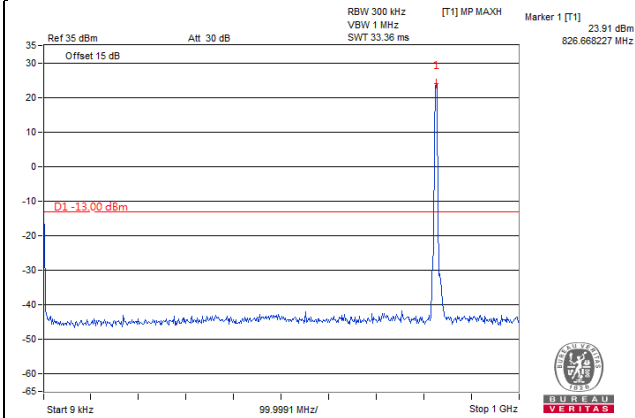

Frequency Range : 1GHz~10GHz

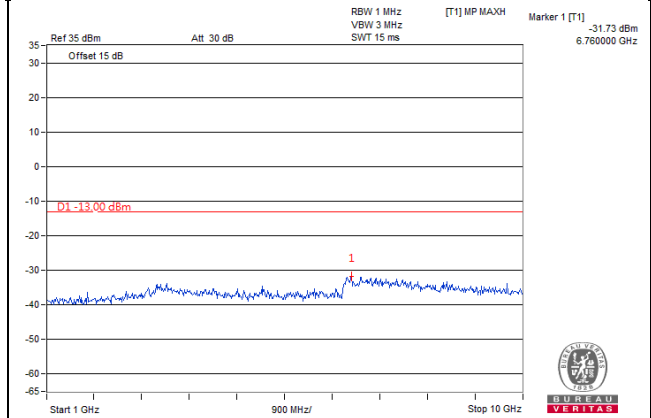

Frequency Range : 10GHz~26.5GHz

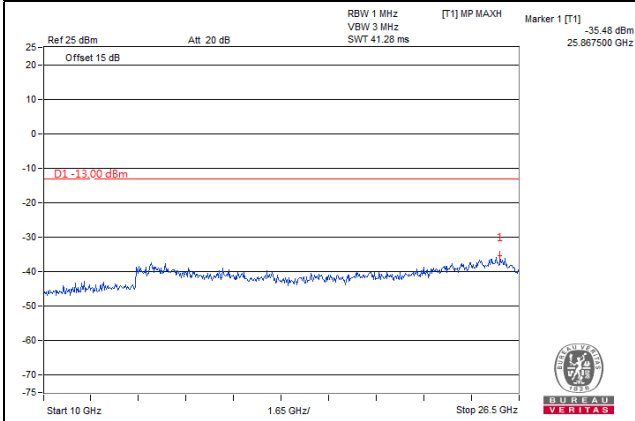

*The 9kHz signal over the limit is from Spectrum.

Channel 4182 (836.4MHz)

Frequency Range : 9kHz~1GHz

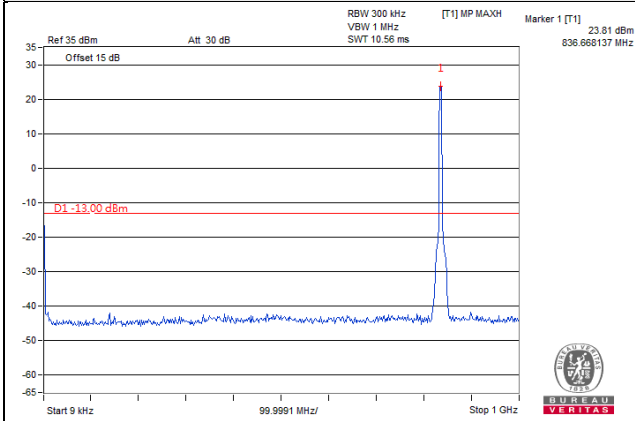

Frequency Range : 1GHz~10GHz

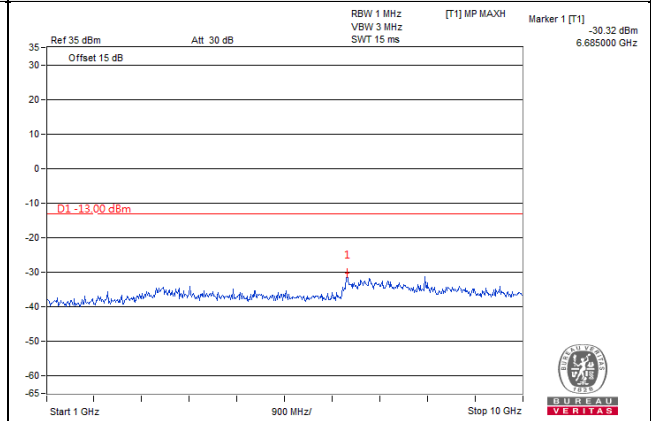

Frequency Range : 10GHz~26.5GHz

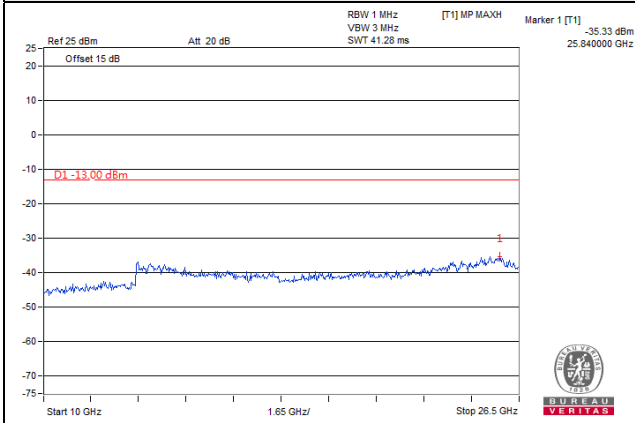

*The 9kHz signal over the limit is from Spectrum.

Channel 4233 (846.6MHz)

Frequency Range : 9kHz~1GHz

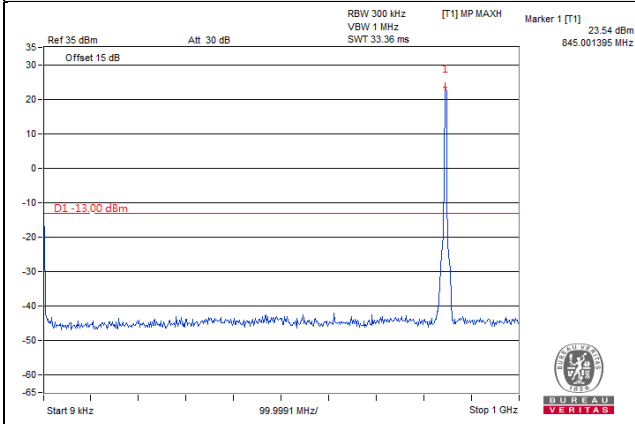

Frequency Range : 1GHz~10GHz

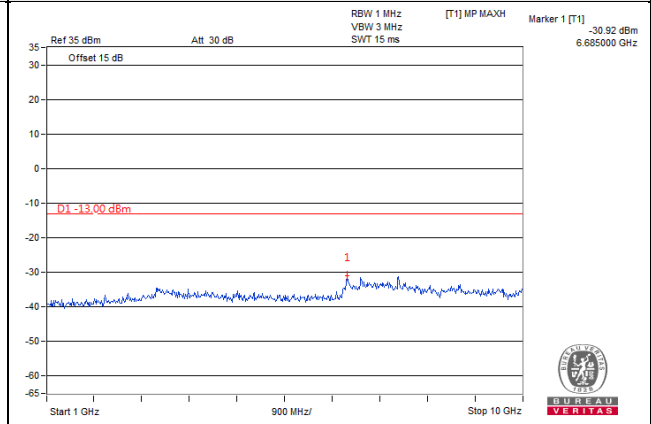

Frequency Range : 10GHz~26.5GHz

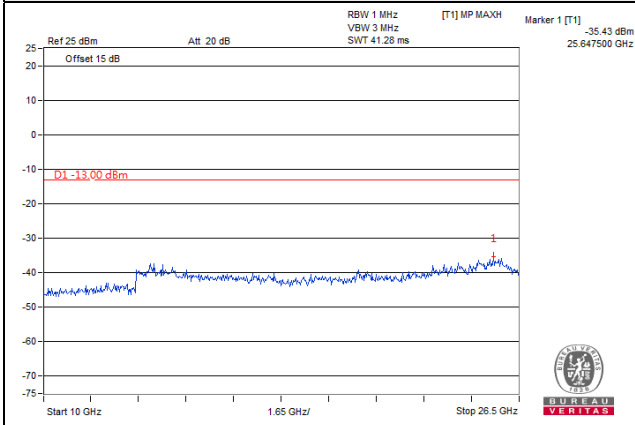

*The 9kHz signal over the limit is from Spectrum.

HSUPA

Channel 4132 (826.4MHz)

Frequency Range : 9kHz~1GHz

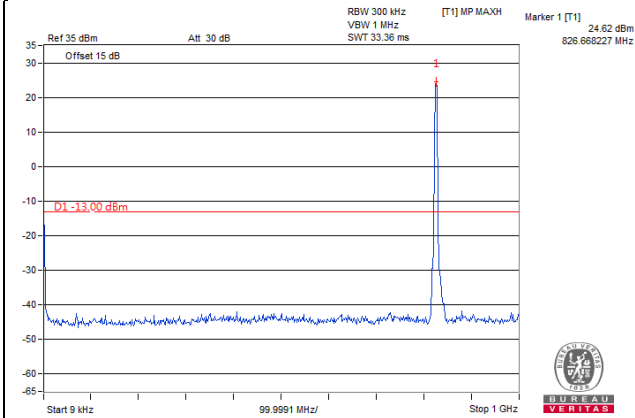

Frequency Range : 1GHz~10GHz

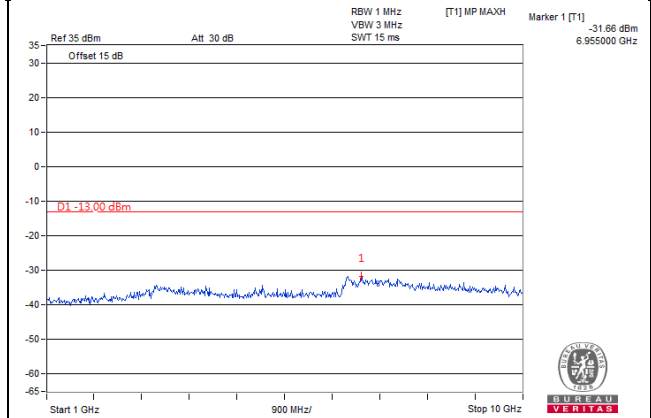

Frequency Range : 10GHz~26.5GHz

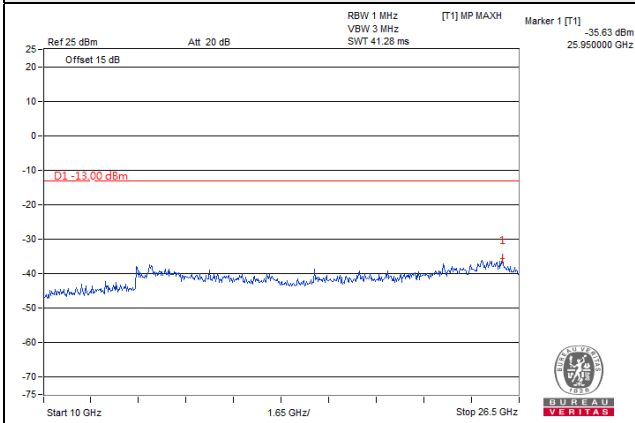

*The 9kHz signal over the limit is from Spectrum.

Channel 4182 (836.4MHz)

Frequency Range : 9kHz~1GHz

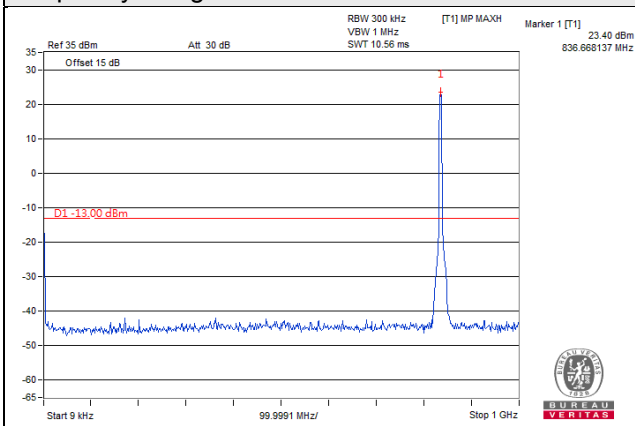

Frequency Range : 1GHz~10GHz

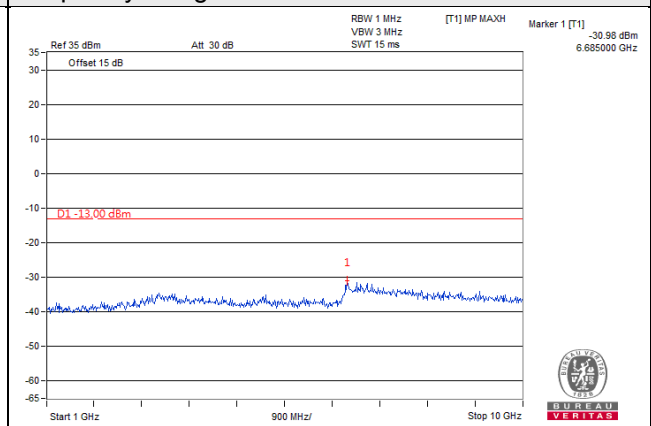

Frequency Range : 10GHz~26.5GHz

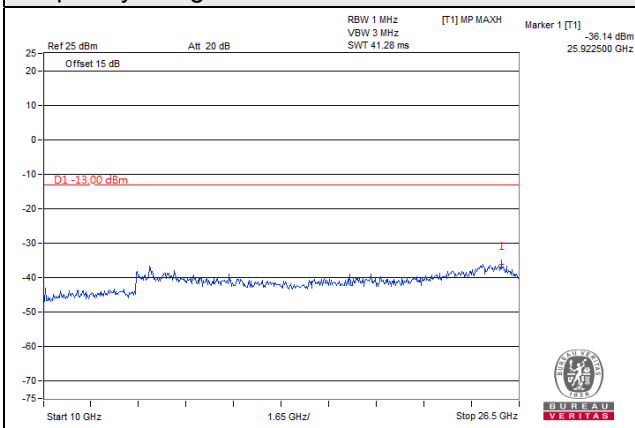

*The 9kHz signal over the limit is from Spectrum.

Channel 4233 (846.6MHz)

Frequency Range : 9kHz~1GHz

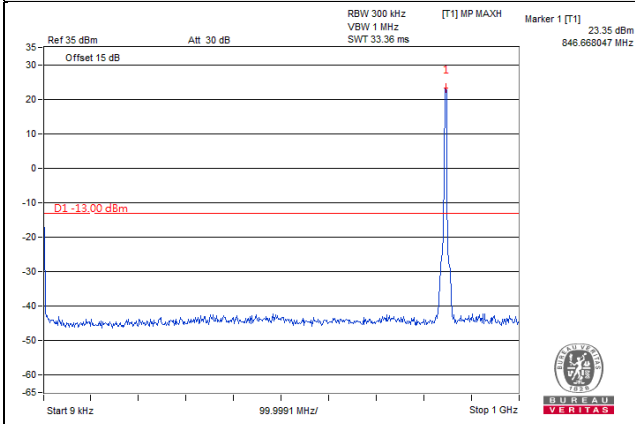

Frequency Range : 1GHz~10GHz

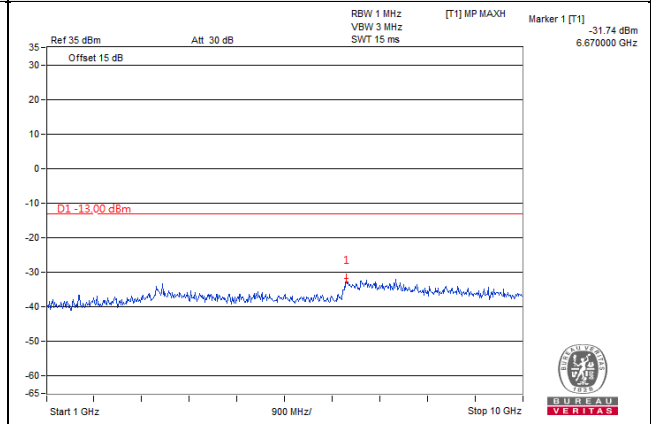

Frequency Range : 10GHz~26.5GHz

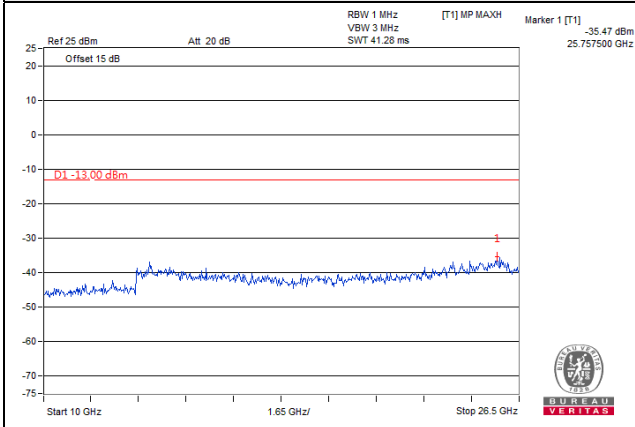

*The 9kHz signal over the limit is from Spectrum.

LTE Band 5, Channel Bandwidth 1.4MHz

Channel 20407 (824.7MHz)

Frequency Range : 9kHz~1GHz

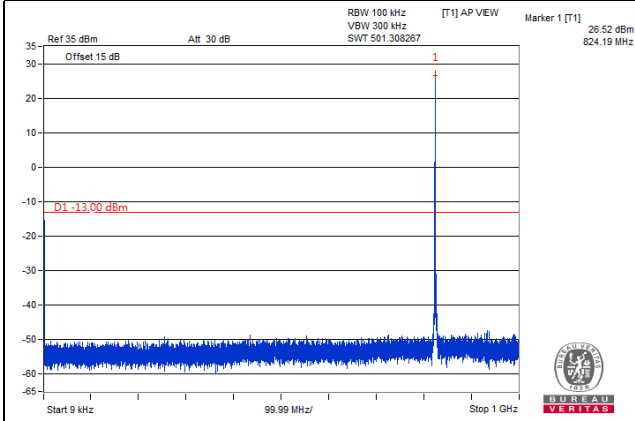

Frequency Range : 1GHz~10GHz

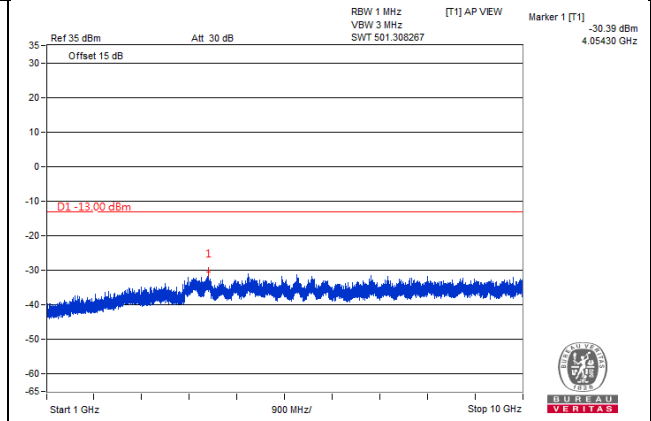

Frequency Range : 10GHz~27GHz

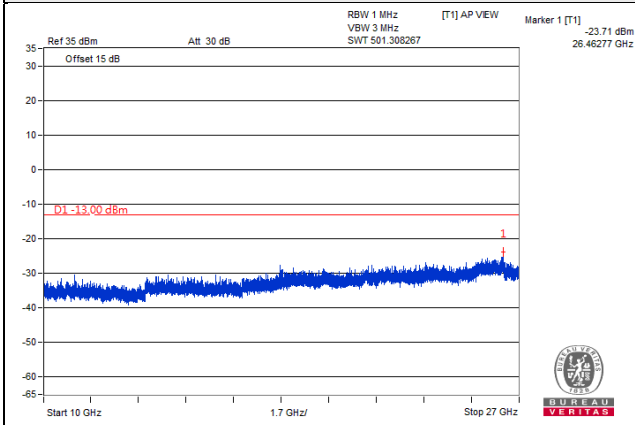

*The 9kHz signal over the limit is from Spectrum.

Channel 20525 (836.5MHz)

Frequency Range : 9kHz~1GHz

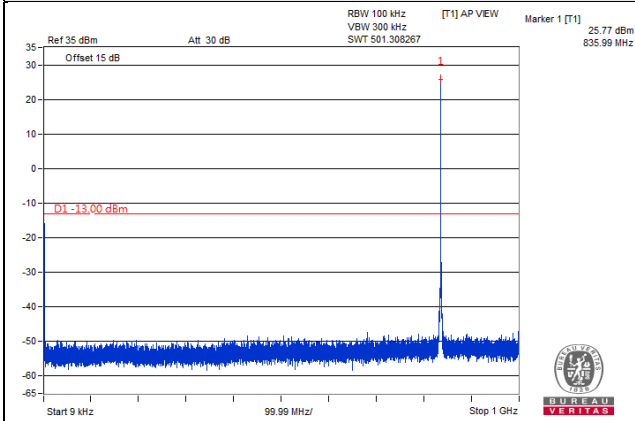

Frequency Range : 1GHz~10GHz

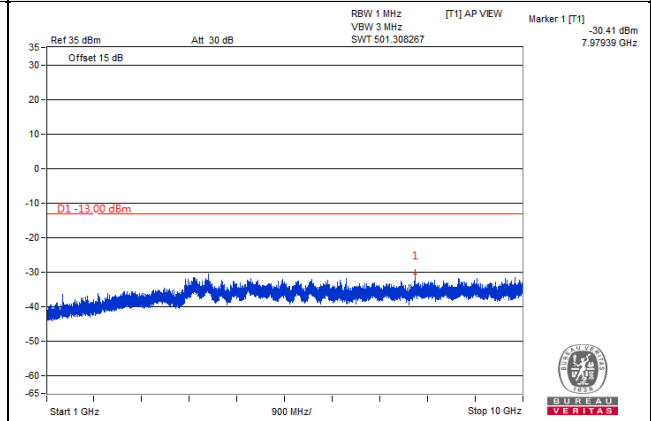

Frequency Range : 10GHz~27GHz

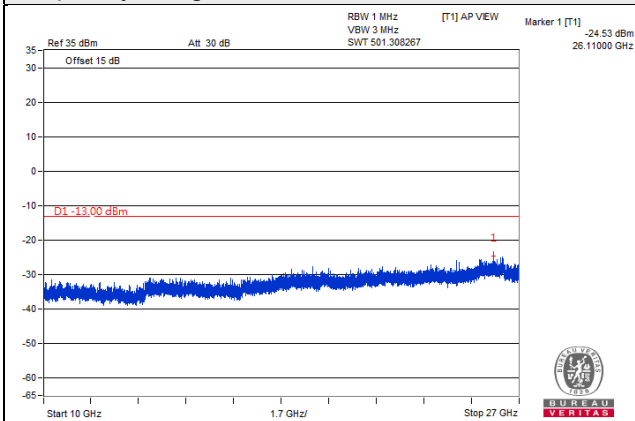

*The 9kHz signal over the limit is from Spectrum.

Channel 20643 (848.3MHz)

Frequency Range : 9kHz~1GHz

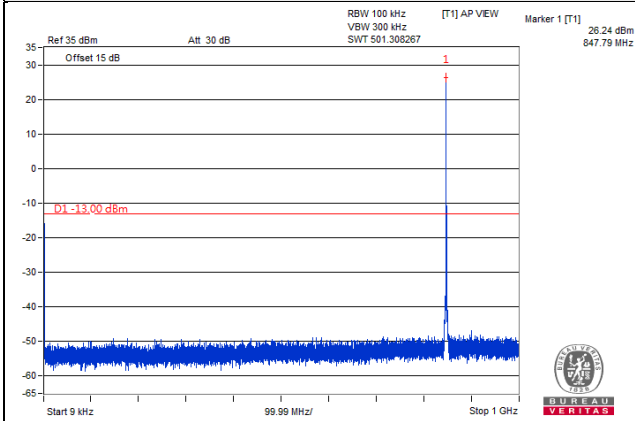

Frequency Range : 1GHz~10GHz

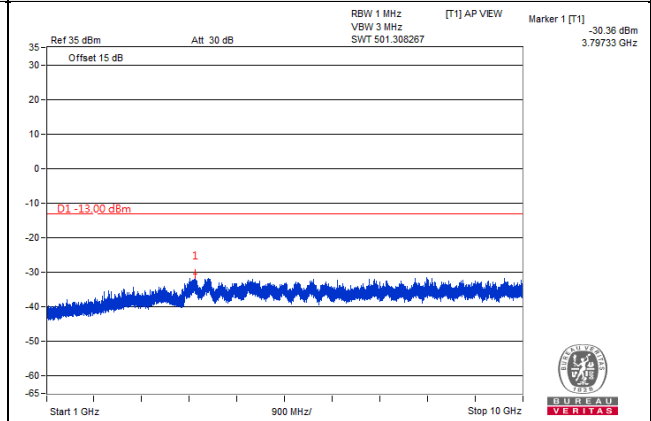

Frequency Range : 10GHz~27GHz

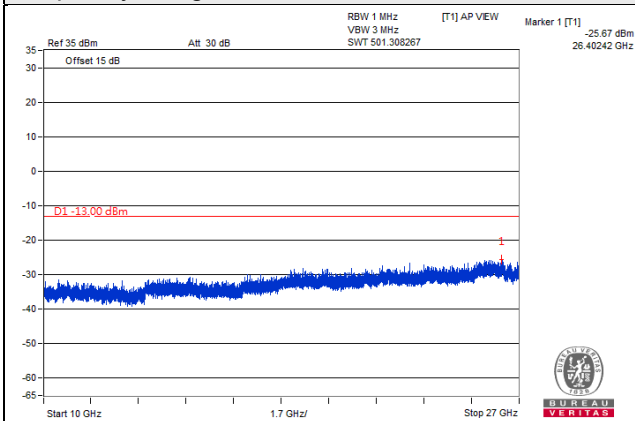

*The 9kHz signal over the limit is from Spectrum.

LTE Band 5, Channel Bandwidth 3MHz

Channel 20415 (825.5MHz)

Frequency Range : 9kHz~1GHz

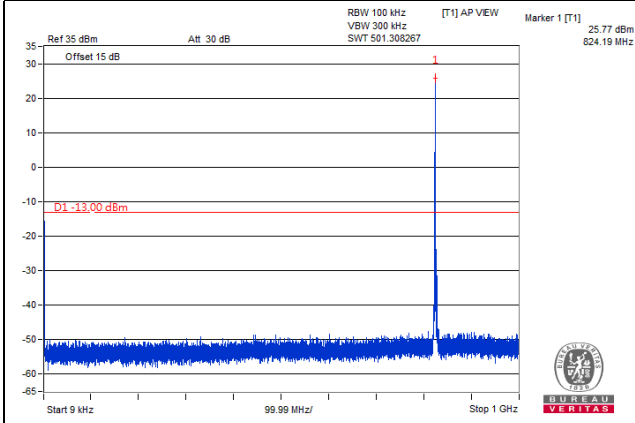

Frequency Range : 1GHz~10GHz

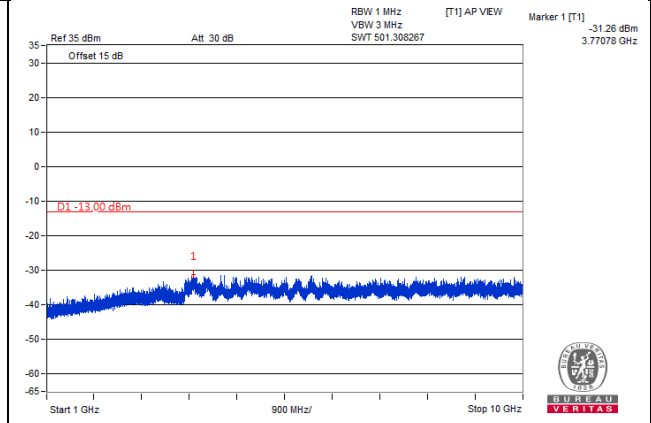

Frequency Range : 10GHz~27GHz

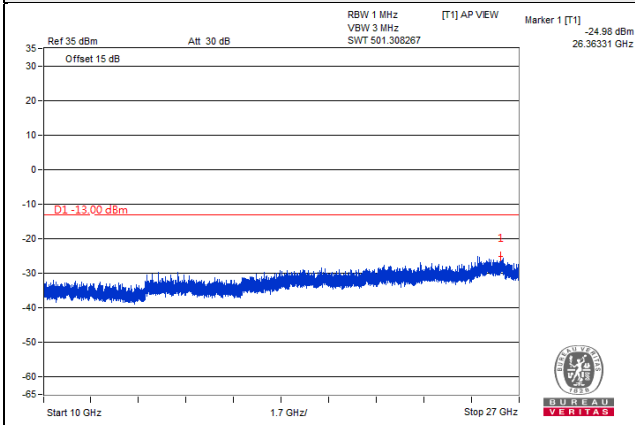

*The 9kHz signal over the limit is from Spectrum.

Channel 20525 (836.5MHz)

Frequency Range : 9kHz~1GHz

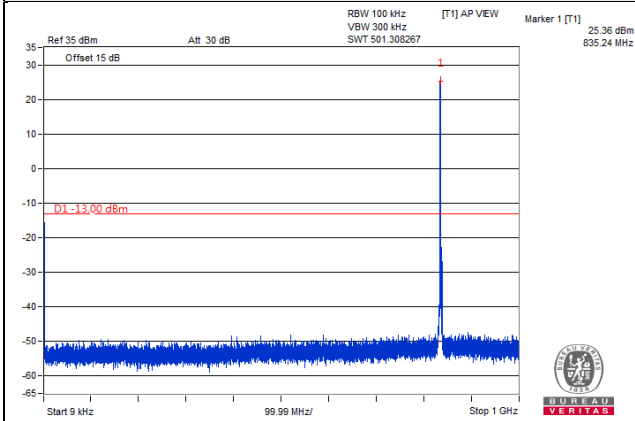

Frequency Range : 1GHz~10GHz

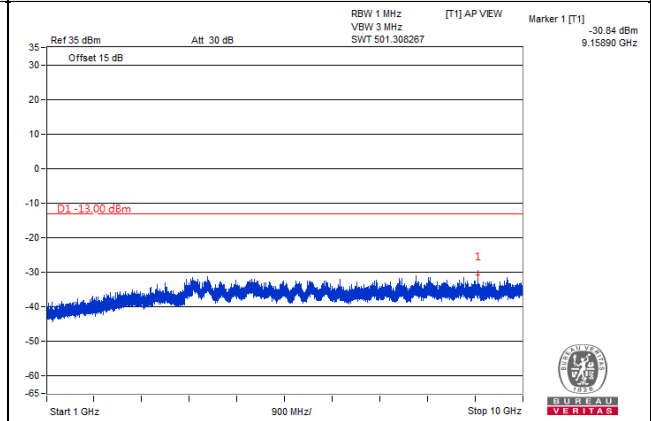

Frequency Range : 10GHz~27GHz

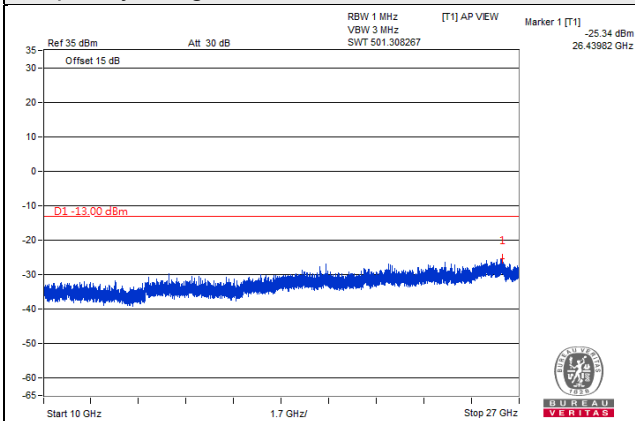

*The 9kHz signal over the limit is from Spectrum.

Channel 20635 (847.5MHz)

Frequency Range : 9kHz~1GHz

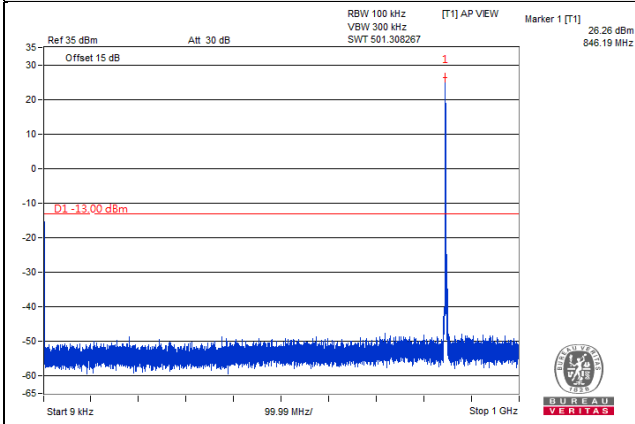

Frequency Range : 1GHz~10GHz

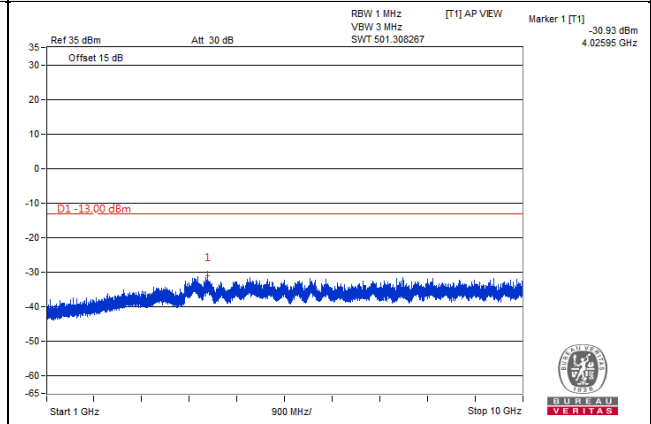

Frequency Range : 10GHz~27GHz

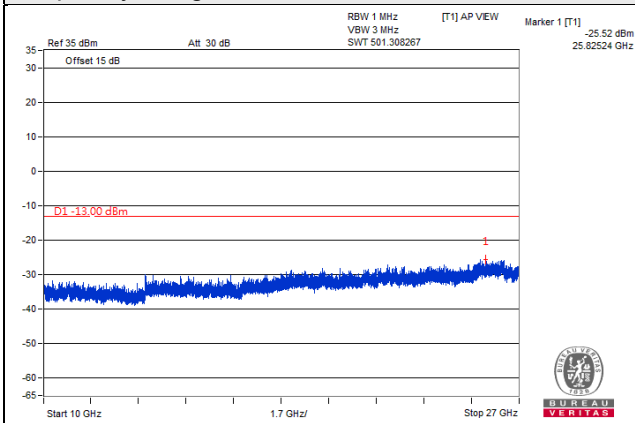

*The 9kHz signal over the limit is from Spectrum.

LTE Band 5, Channel Bandwidth 5MHz

Channel 20425 (826.5MHz)

Frequency Range : 9kHz~1GHz

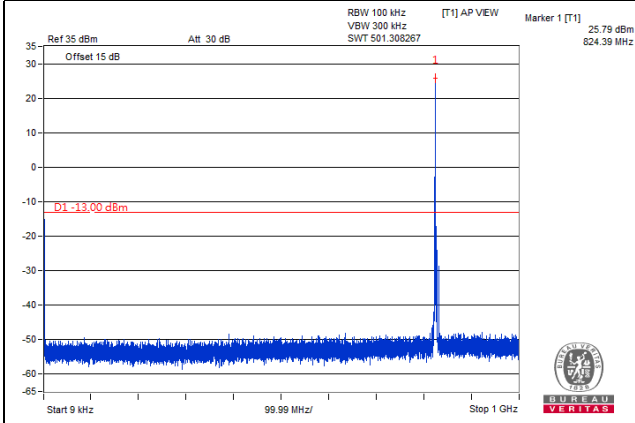

Frequency Range : 1GHz~10GHz

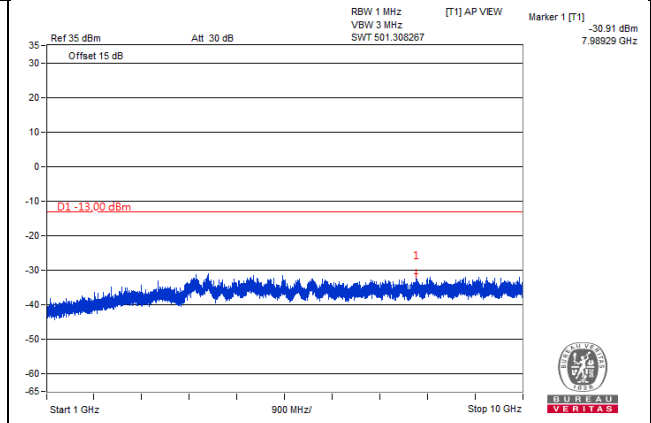

Frequency Range : 10GHz~27GHz

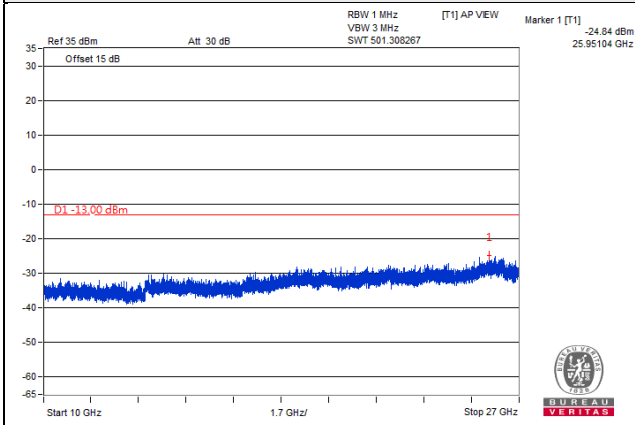

*The 9kHz signal over the limit is from Spectrum.

Channel 20525 (836.5MHz)

Frequency Range : 9kHz~1GHz

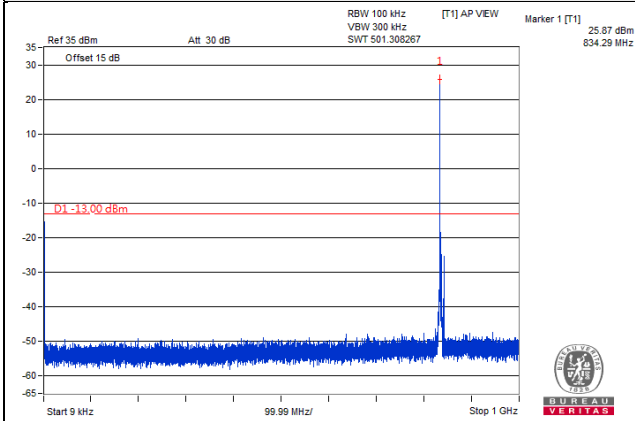

Frequency Range : 1GHz~10GHz

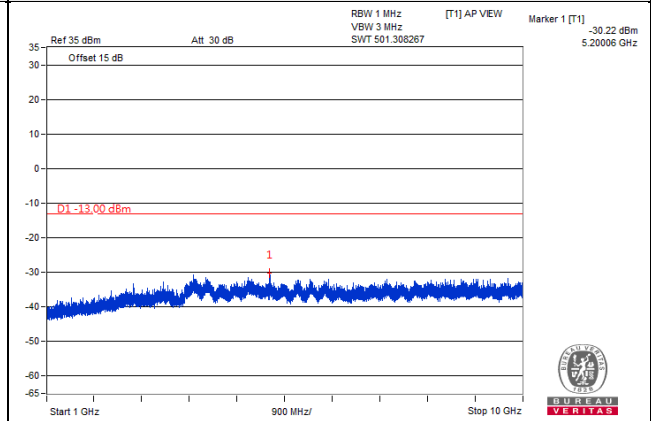

Frequency Range : 10GHz~27GHz

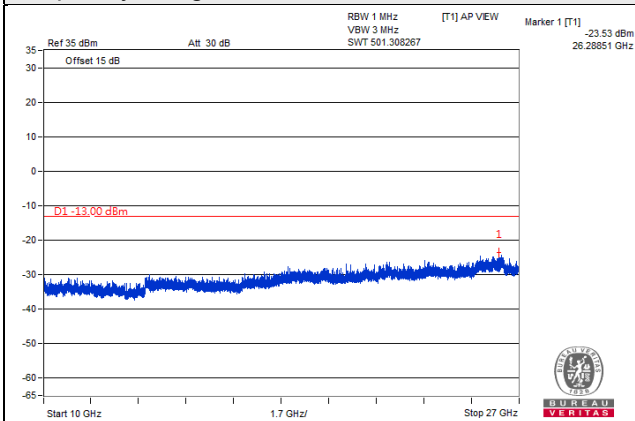

*The 9kHz signal over the limit is from Spectrum.

Channel 20625 (846.5MHz)

Frequency Range : 9kHz~1GHz

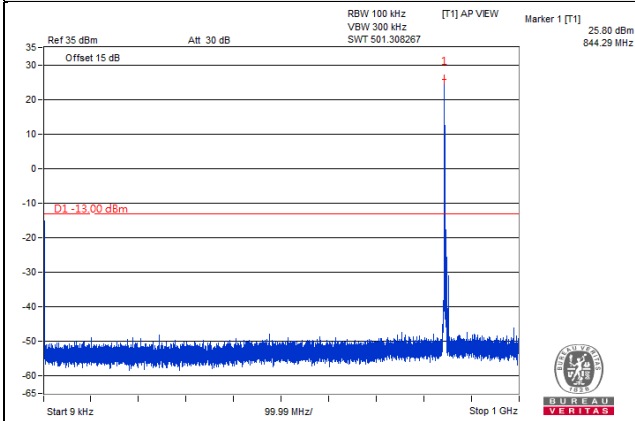

Frequency Range : 1GHz~10GHz

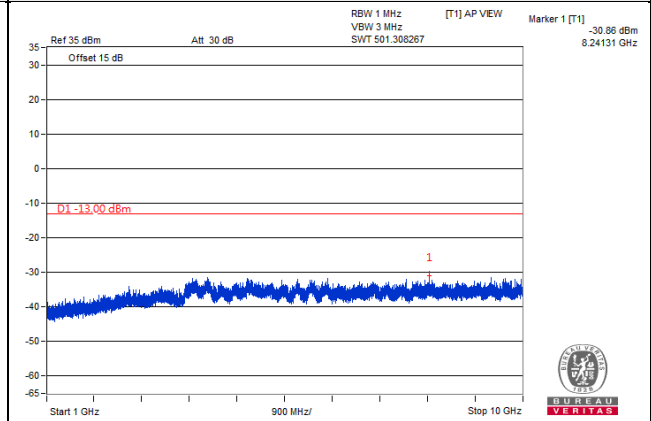

Frequency Range : 10GHz~27GHz

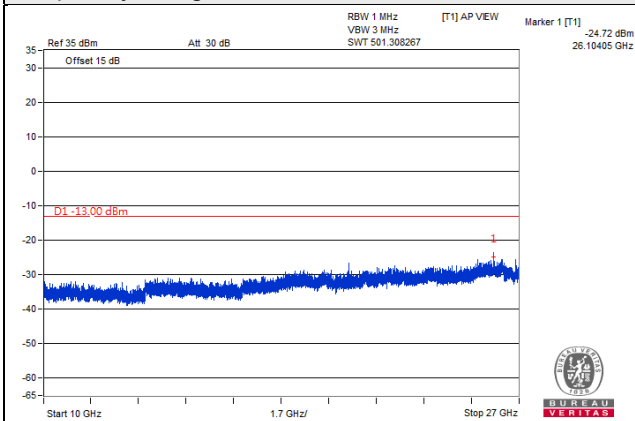

*The 9kHz signal over the limit is from Spectrum.

LTE Band 5, Channel Bandwidth 10MHz

Channel 20450 (829.0MHz)

Frequency Range : 9kHz~1GHz

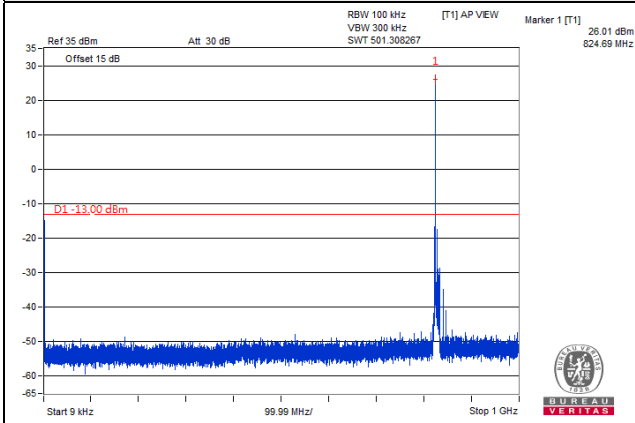

Frequency Range : 1GHz~10GHz

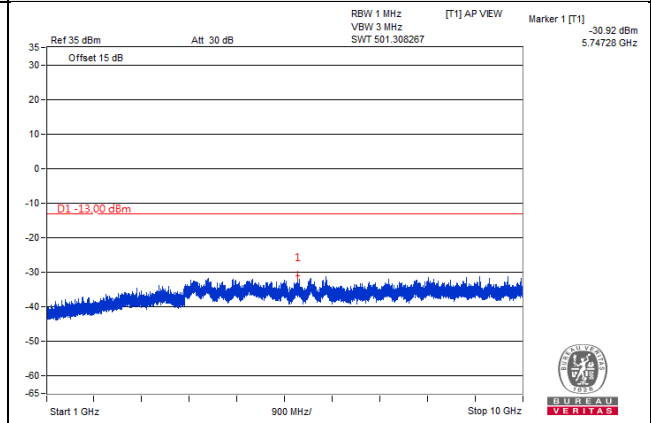

Frequency Range : 10GHz~27GHz

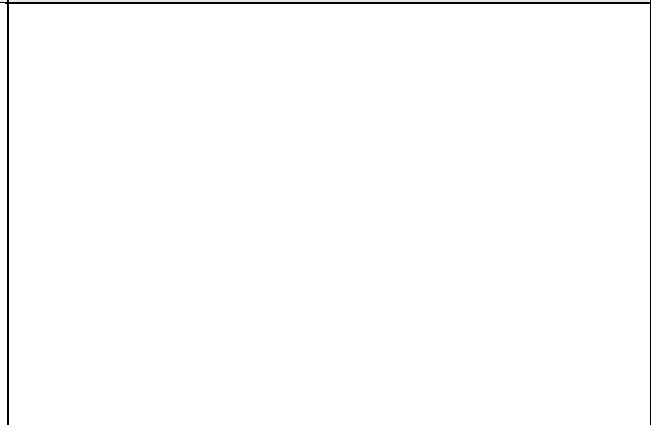
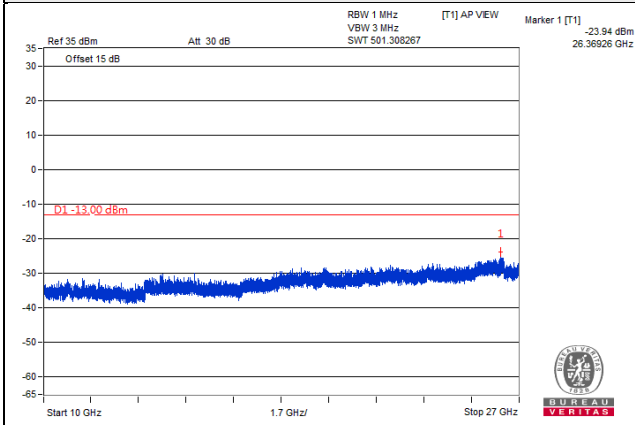

*The 9kHz signal over the limit is from Spectrum.

Channel 20525 (836.5MHz)

Frequency Range : 9kHz~1GHz

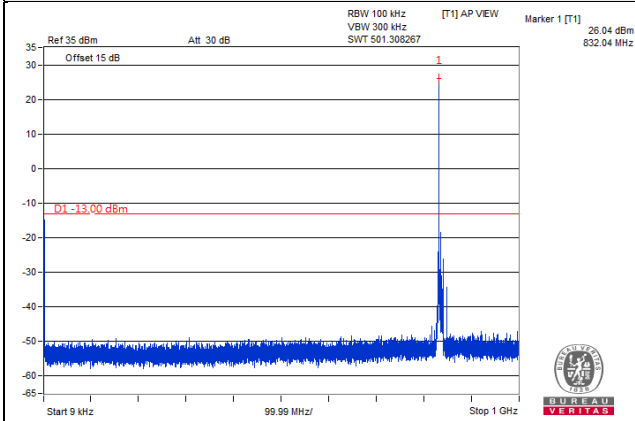

Frequency Range : 1GHz~10GHz

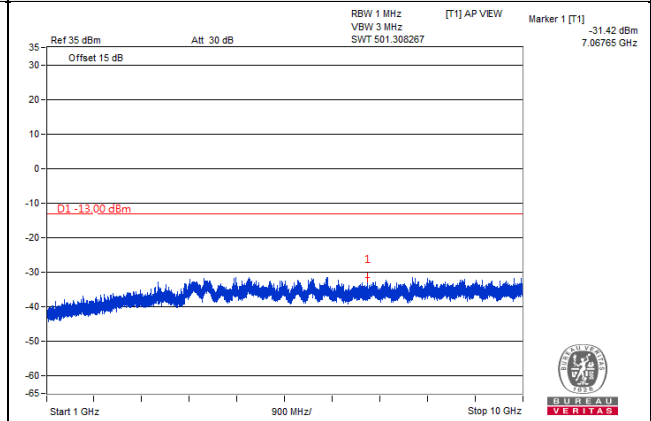

Frequency Range : 10GHz~27GHz

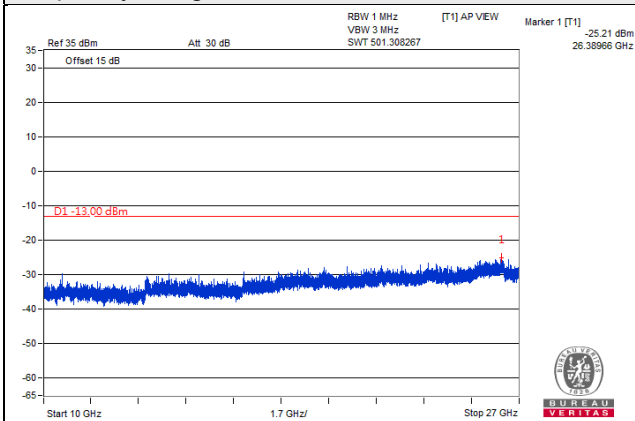

*The 9kHz signal over the limit is from Spectrum.

Channel 20600 (844.0MHz)

Frequency Range : 9kHz~1GHz

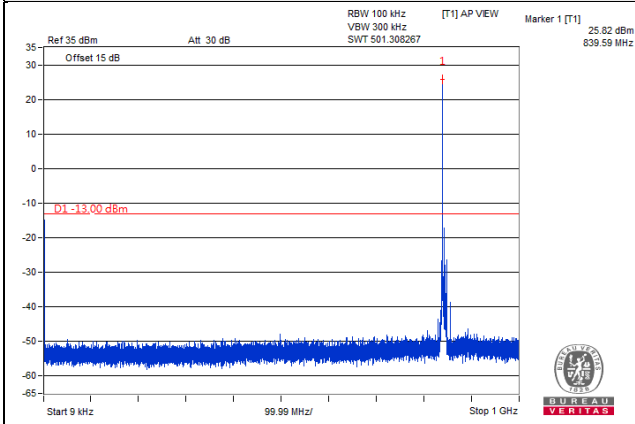

Frequency Range : 1GHz~10GHz

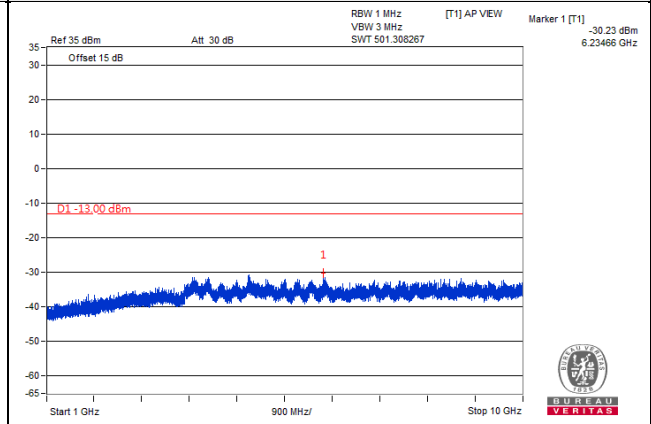

Frequency Range : 10GHz~27GHz

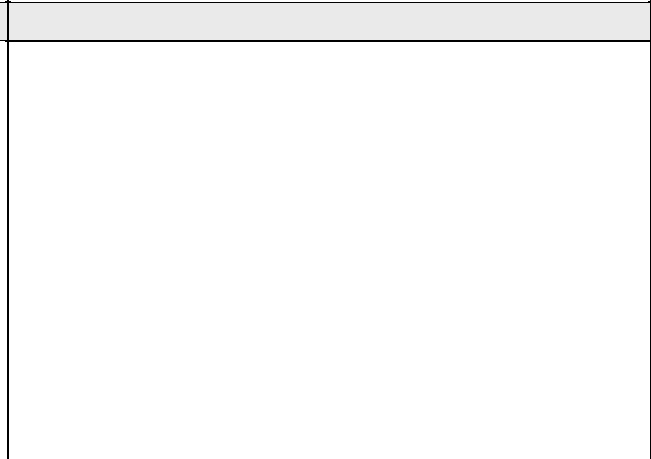
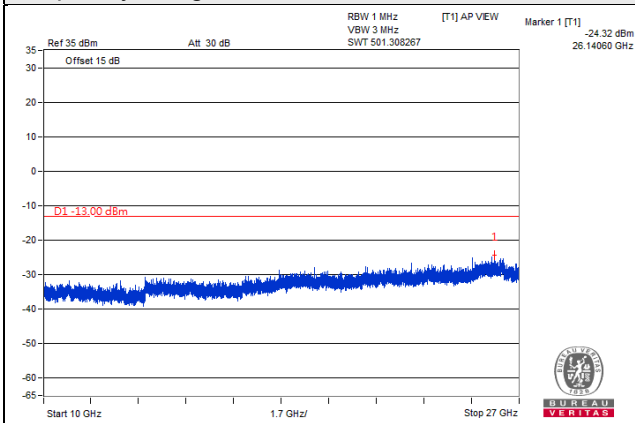

*The 9kHz signal over the limit is from Spectrum.

4.8 Radiated Emission Measurement

4.8.1 Limits of Radiated Emission Measurement

The power of any emission outside of the authorized operating frequency ranges must be attenuated below the transmitting power (P) by a factor of at least $43 + 10 \log(P)$ dB. The emission limit equal to -13dBm .

4.8.2 Test Procedure

- a. Substitution method is used for E.I.R.P measurement. In the semi-anechoic chamber, EUT placed on the 0.8m height of Turn Table, rotated the table around 360 degrees to search the maximum radiation power and receiver antenna shall be rotated vertical and horizontal polarization and moved height from 1m to 4m to find the maximum polar radiated power. The "Read Value" is the spectrum reading the maximum power value.
- b. The substitution horn antenna is substituted for EUT at the same position and signals generator export the CW signal to the substitution antenna via a TX cable. Rotated the Turn Table and moved receiving antenna to find the maximum radiation power. Adjust output power level of S.G to get a Value of spectrum reading equal to "Read Value" of step a. Record the power level of S.G
- c. $\text{EIRP} = \text{Output power level of S.G} - \text{TX cable loss} + \text{Antenna gain of substitution horn}$.
- d. E.R.P power can be calculated form E.I.R.P power by subtracting the gain of dipole, $\text{E.R.P power} = \text{E.I.R.P power} - 2.15\text{dBi}$.

NOTE: The resolution bandwidth and video bandwidth of test receiver/spectrum analyzer is 1MHz/3MHz.

4.8.3 Deviation from Test Standard

No deviation.

4.8.4 Test Setup

For radiated emission 30MHz to 1GHz

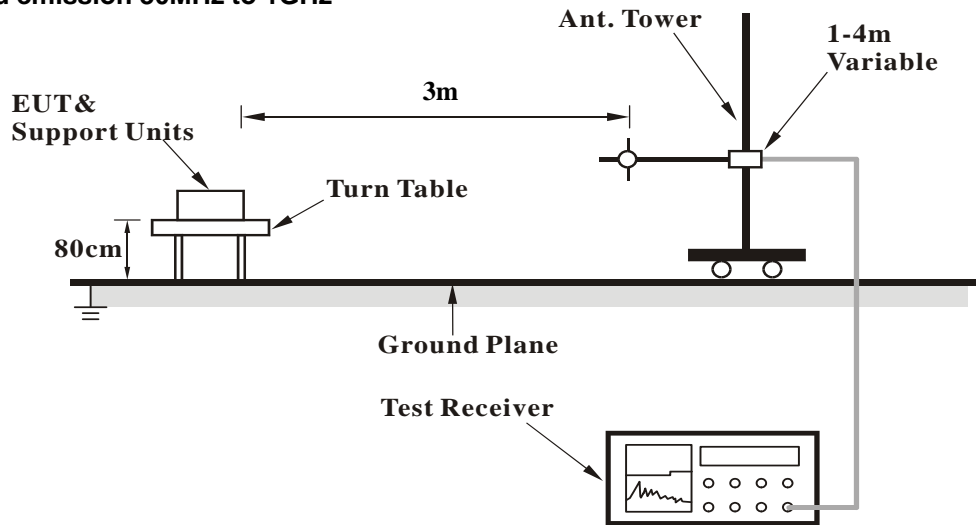

For radiated emission above 1GHz

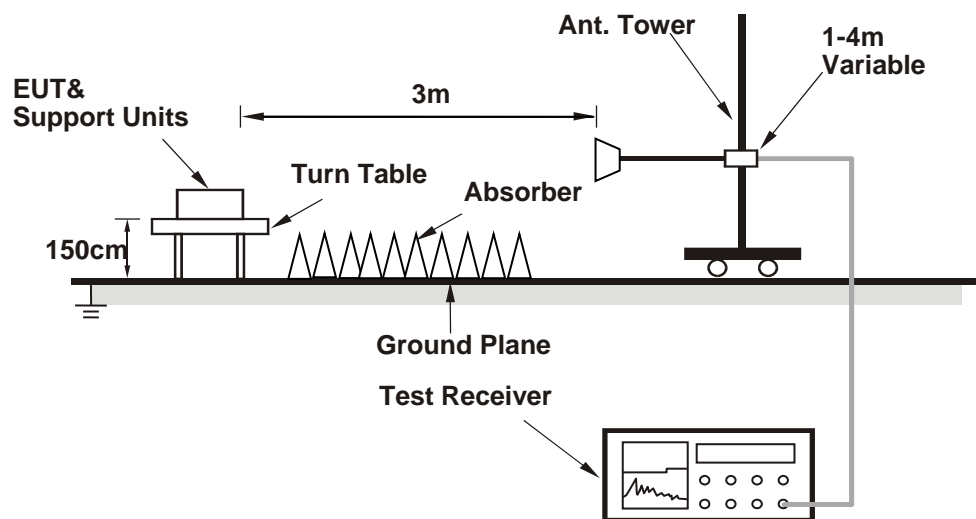

For the actual test configuration, please refer to the attached file (Test Setup Photo).

4.8.5 Test Results

Below 1GHz
GSM Mode

Mode	TX channel 128 (824.2MHz)	Frequency Range	Below 1000 MHz
Environmental Conditions	22deg. C, 66%RH	Input Power	120Vac, 60Hz
Tested By	Han Wu		

Antenna Polarity & Test Distance: Horizontal at 3 M							
No.	Freq. (MHz)	Reading (dBm)	S.G Power Value (dBm)	Correction Factor (dB)	ERP (dBm)	Limit (dBm)	Margin (dB)
1	35.82	-54.1	-36.8	-15.9	-52.7	-13.0	-39.7
2	66.86	-52.0	-59.5	-1.5	-61.0	-13.0	-48.0
3	153.19	-60.6	-64.1	-2.9	-67.0	-13.0	-54.0
4	172.59	-54.2	-60.7	-2.9	-63.6	-13.0	-50.6
5	251.16	-61.6	-68.5	-1.4	-69.9	-13.0	-56.9
6	393.75	-61.8	-67.9	3.3	-64.6	-13.0	-51.6

Remarks:

1. ERP (dBm) = S.G Value (dBm) + Correction Factor (dB).
2. Correction Factor (dB) = Substitution Antenna Gain (dB) + Cable Loss (dB).

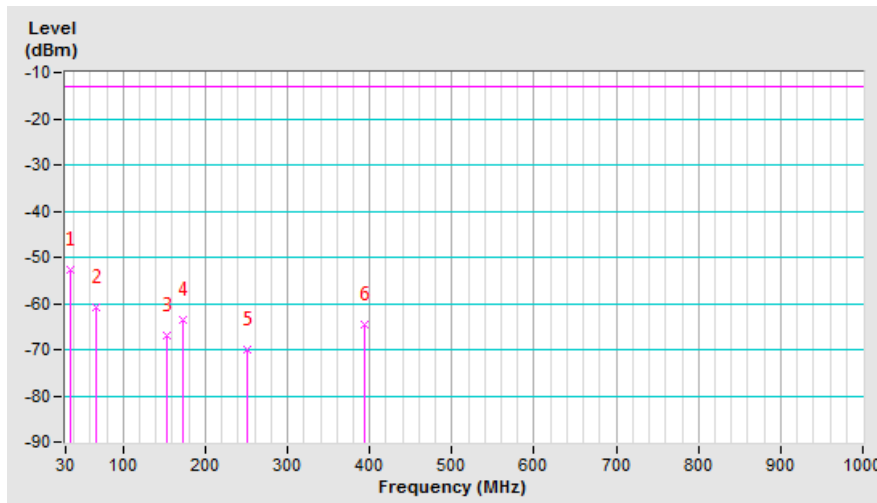

Mode	TX channel 128 (824.2MHz)	Frequency Range	Below 1000 MHz
Environmental Conditions	22deg. C, 66%RH	Input Power	120Vac, 60Hz
Tested By	Han Wu		

Antenna Polarity & Test Distance: Vertical at 3 M							
No.	Freq. (MHz)	Reading (dBm)	S.G Power Value (dBm)	Correction Factor (dB)	ERP (dBm)	Limit (dBm)	Margin (dB)
1	35.82	-48.0	-44.0	-15.9	-59.9	-13.0	-46.9
2	66.86	-43.5	-51.4	-1.5	-52.9	-13.0	-39.9
3	136.70	-60.6	-62.8	-3.2	-66.0	-13.0	-53.0
4	209.45	-58.5	-61.7	-2.0	-63.7	-13.0	-50.7
5	278.32	-63.5	-60.8	-1.6	-62.4	-13.0	-49.4
6	439.34	-61.1	-66.7	3.5	-63.2	-13.0	-50.2

Remarks:

1. ERP (dBm) = S.G Value (dBm) + Correction Factor (dB).
2. Correction Factor (dB) = Substitution Antenna Gain (dB) + Cable Loss (dB).

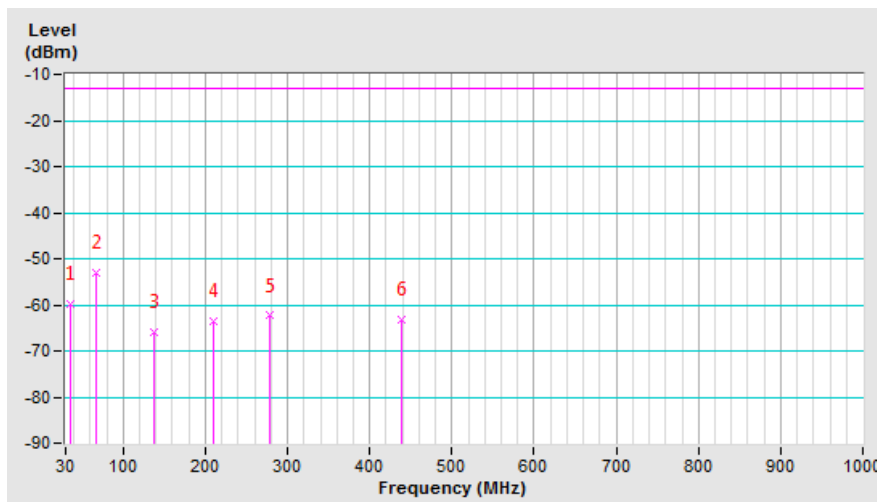

WCDMA Band 5

Mode	TX channel 4132 (826.4MHz)	Frequency Range	Below 1000 MHz
Environmental Conditions	22deg. C, 66%RH	Input Power	120Vac, 60Hz
Tested By	Han Wu		

Antenna Polarity & Test Distance: Horizontal at 3 M							
No.	Freq. (MHz)	Reading (dBm)	S.G Power Value (dBm)	Correction Factor (dB)	ERP (dBm)	Limit (dBm)	Margin (dB)
1	49.40	-54.4	-48.6	-8.3	-56.9	-13.0	-43.9
2	137.67	-56.3	-61.4	-3.2	-64.6	-13.0	-51.6
3	154.16	-57.8	-61.3	-2.9	-64.2	-13.0	-51.2
4	208.48	-56.5	-65.0	-2.0	-67.0	-13.0	-54.0
5	306.45	-56.5	-66.8	3.9	-62.9	-13.0	-49.9
6	383.08	-59.6	-66.4	3.5	-62.9	-13.0	-49.9

Remarks:

- ERP (dBm) = S.G Value (dBm) + Correction Factor (dB).
- Correction Factor (dB) = Substitution Antenna Gain (dB) + Cable Loss (dB).

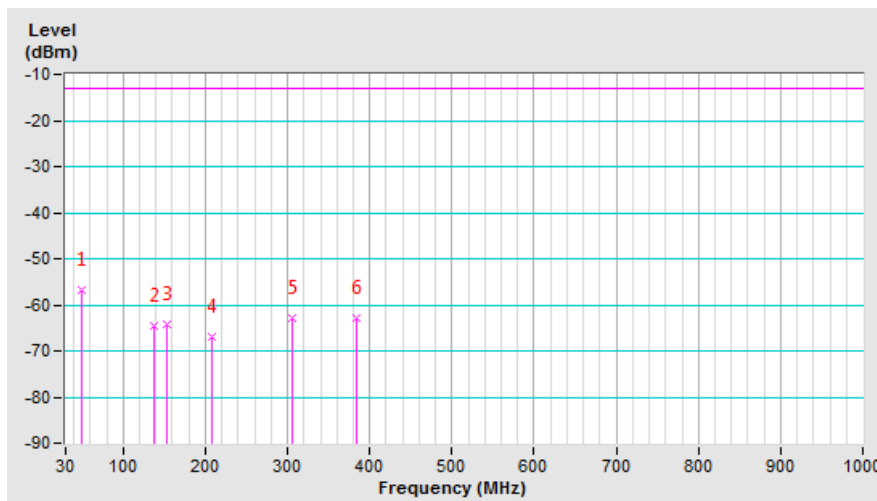

Mode	TX channel 4132 (826.4MHz)	Frequency Range	Below 1000 MHz
Environmental Conditions	22deg. C, 66%RH	Input Power	120Vac, 60Hz
Tested By	Han Wu		

Antenna Polarity & Test Distance: Vertical at 3 M							
No.	Freq. (MHz)	Reading (dBm)	S.G Power Value (dBm)	Correction Factor (dB)	ERP (dBm)	Limit (dBm)	Margin (dB)
1	66.86	-48.9	-56.7	-1.5	-58.2	-13.0	-45.2
2	137.67	-58.4	-60.5	-3.2	-63.7	-13.0	-50.7
3	194.90	-58.5	-59.1	-2.6	-61.7	-13.0	-48.7
4	279.29	-61.6	-58.9	-1.6	-60.5	-13.0	-47.5
5	370.47	-59.6	-66.0	3.9	-62.1	-13.0	-49.1
6	501.42	-59.6	-65.7	3.8	-61.9	-13.0	-48.9

Remarks:

- ERP (dBm) = S.G Value (dBm) + Correction Factor (dB).
- Correction Factor (dB) = Substitution Antenna Gain (dB) + Cable Loss (dB).

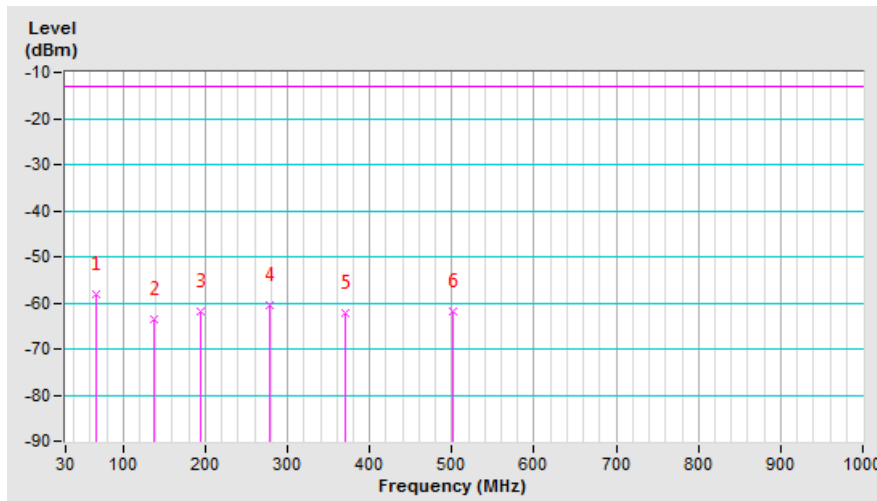

LTE Band 5, Channel Bandwidth: 1.4MHz

Mode	TX channel 20407 (824.7MHz)	Frequency Range	Below 1000 MHz
Environmental Conditions	22deg. C, 66%RH	Input Power	120Vac, 60Hz
Tested By	Han Wu		

Antenna Polarity & Test Distance: Horizontal at 3 M							
No.	Freq. (MHz)	Reading (dBm)	S.G Power Value (dBm)	Correction Factor (dB)	ERP (dBm)	Limit (dBm)	Margin (dB)
1	65.89	-50.4	-57.7	-1.9	-59.6	-13.0	-46.6
2	138.64	-56.6	-61.6	-3.2	-64.8	-13.0	-51.8
3	153.19	-58.1	-61.5	-2.9	-64.4	-13.0	-51.4
4	207.51	-52.8	-61.2	-2.0	-63.2	-13.0	-50.2
5	296.75	-60.0	-63.1	-1.8	-64.9	-13.0	-51.9
6	431.58	-58.8	-64.8	3.5	-61.3	-13.0	-48.3

Remarks:

- ERP (dBm) = S.G Value (dBm) + Correction Factor (dB).
- Correction Factor (dB) = Substitution Antenna Gain (dB) + Cable Loss (dB).

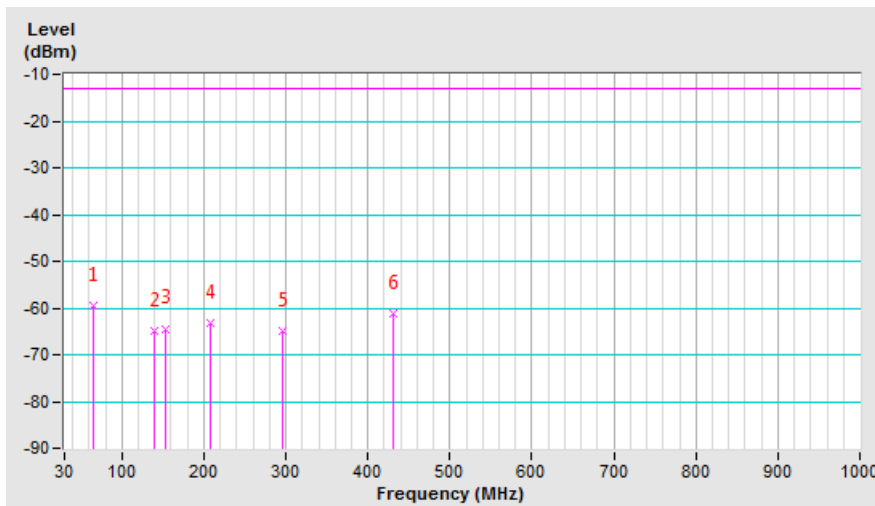

Mode	TX channel 20407 (824.7MHz)	Frequency Range	Below 1000 MHz
Environmental Conditions	22deg. C, 66%RH	Input Power	120Vac, 60Hz
Tested By	Han Wu		

Antenna Polarity & Test Distance: Vertical at 3 M							
No.	Freq. (MHz)	Reading (dBm)	S.G Power Value (dBm)	Correction Factor (dB)	ERP (dBm)	Limit (dBm)	Margin (dB)
1	30.00	-41.5	-34.2	-19.4	-53.6	-13.0	-40.6
2	66.86	-42.4	-50.3	-1.5	-51.8	-13.0	-38.8
3	136.70	-56.9	-59.0	-3.2	-62.2	-13.0	-49.2
4	199.75	-58.6	-59.5	-2.4	-61.9	-13.0	-48.9
5	277.35	-61.0	-58.3	-1.6	-59.9	-13.0	-46.9
6	384.05	-60.1	-66.1	3.5	-62.6	-13.0	-49.6

Remarks:

1. ERP (dBm) = S.G Value (dBm) + Correction Factor (dB).
2. Correction Factor (dB) = Substitution Antenna Gain (dB) + Cable Loss (dB).

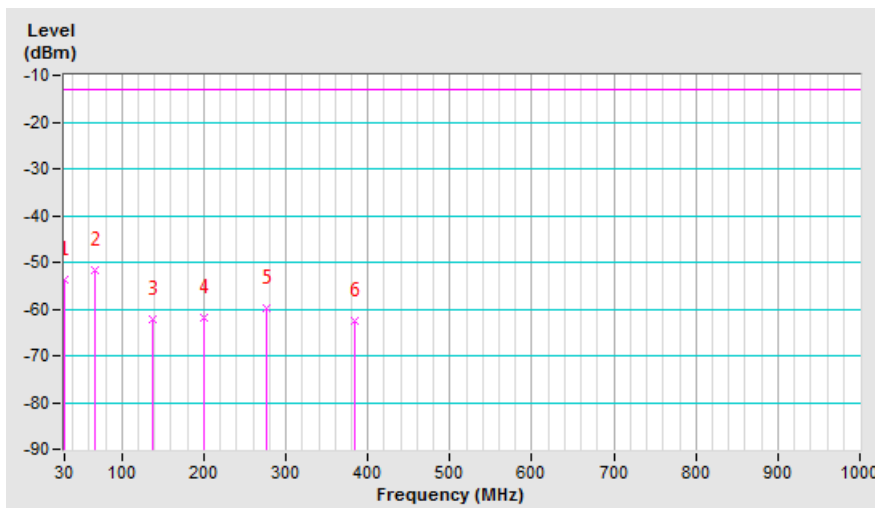

LTE Band 5, Channel Bandwidth: 5MHz

Mode	TX channel 20425 (826.5MHz)	Frequency Range	Below 1000 MHz
Environmental Conditions	22deg. C, 66%RH	Input Power	120Vac, 60Hz
Tested By	Han Wu		

Antenna Polarity & Test Distance: Horizontal at 3 M

No.	Freq. (MHz)	Reading (dBm)	S.G Power Value (dBm)	Correction Factor (dB)	ERP (dBm)	Limit (dBm)	Margin (dB)
1	66.86	-51.0	-58.5	-1.5	-60.0	-13.0	-47.0
2	109.54	-47.0	-54.6	-2.5	-57.1	-13.0	-44.1
3	153.19	-57.6	-61.1	-2.9	-64.0	-13.0	-51.0
4	208.48	-53.0	-61.5	-2.0	-63.5	-13.0	-50.5
5	297.72	-59.1	-62.3	-1.7	-64.0	-13.0	-51.0
6	392.78	-59.9	-65.8	3.3	-62.5	-13.0	-49.5

Remarks:

- ERP (dBm) = S.G Value (dBm) + Correction Factor (dB).
- Correction Factor (dB) = Substitution Antenna Gain (dB) + Cable Loss (dB).

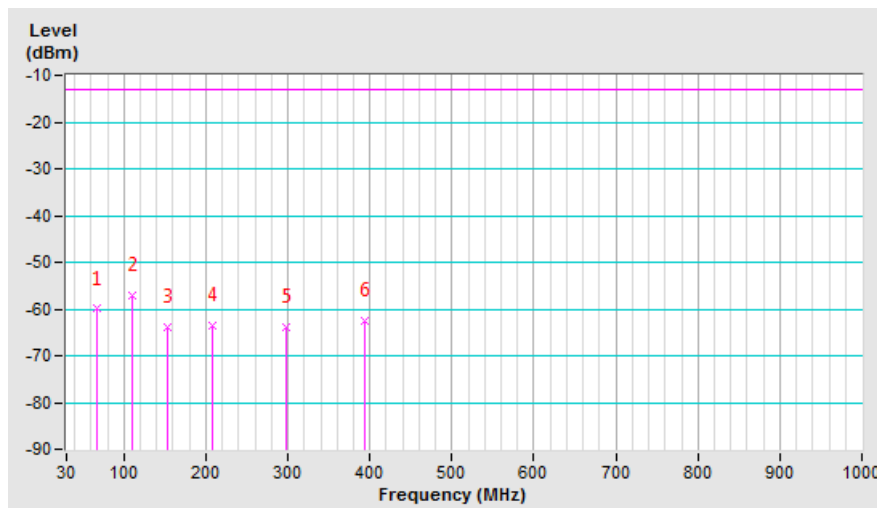

Mode	TX channel 20425 (826.5MHz)	Frequency Range	Below 1000 MHz
Environmental Conditions	22deg. C, 66%RH	Input Power	120Vac, 60Hz
Tested By	Han Wu		

Antenna Polarity & Test Distance: Vertical at 3 M							
No.	Freq. (MHz)	Reading (dBm)	S.G Power Value (dBm)	Correction Factor (dB)	ERP (dBm)	Limit (dBm)	Margin (dB)
1	41.64	-49.1	-45.8	-12.3	-58.1	-13.0	-45.1
2	65.89	-43.7	-49.2	-1.9	-51.1	-13.0	-38.1
3	136.70	-59.7	-59.7	-3.2	-62.9	-13.0	-49.9
4	207.51	-59.1	-59.9	-2.0	-61.9	-13.0	-48.9
5	248.25	-55.6	-54.6	-1.5	-56.1	-13.0	-43.1
6	279.29	-62.9	-58.0	-1.6	-59.6	-13.0	-46.6

Remarks:

- ERP (dBm) = S.G Value (dBm) + Correction Factor (dB).
- Correction Factor (dB) = Substitution Antenna Gain (dB) + Cable Loss (dB).

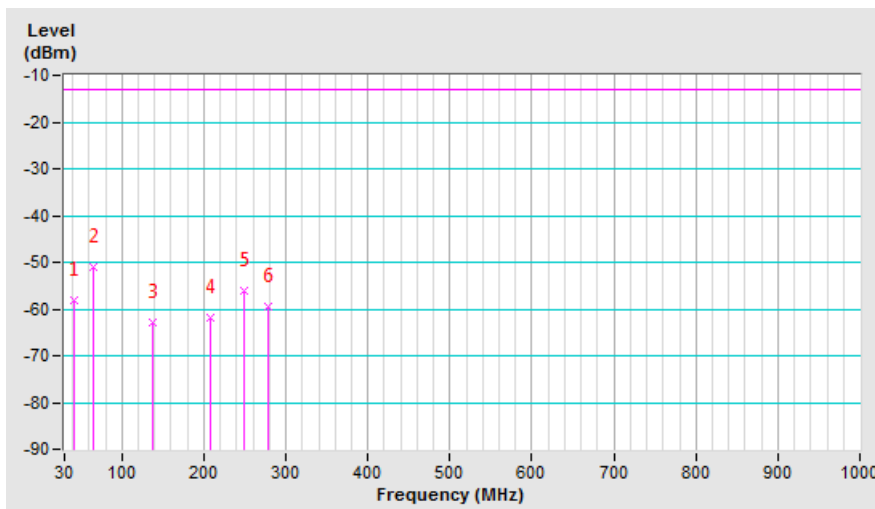

LTE Band 5, Channel Bandwidth: 10MHz

Mode	TX channel 20450 (829.0MHz)	Frequency Range	Below 1000 MHz
Environmental Conditions	22deg. C, 66%RH	Input Power	120Vac, 60Hz
Tested By	Han Wu		

Antenna Polarity & Test Distance: Horizontal at 3 M							
No.	Freq. (MHz)	Reading (dBm)	S.G Power Value (dBm)	Correction Factor (dB)	ERP (dBm)	Limit (dBm)	Margin (dB)
1	65.89	-49.0	-56.3	-1.9	-58.2	-13.0	-45.2
2	138.64	-56.9	-61.9	-3.2	-65.1	-13.0	-52.1
3	153.19	-57.1	-60.6	-2.9	-63.5	-13.0	-50.5
4	187.14	-56.4	-64.0	-2.7	-66.7	-13.0	-53.7
5	208.48	-56.4	-64.9	-2.0	-66.9	-13.0	-53.9
6	297.72	-60.4	-63.5	-1.7	-65.2	-13.0	-52.2

Remarks:

- ERP (dBm) = S.G Value (dBm) + Correction Factor (dB).
- Correction Factor (dB) = Substitution Antenna Gain (dB) + Cable Loss (dB).

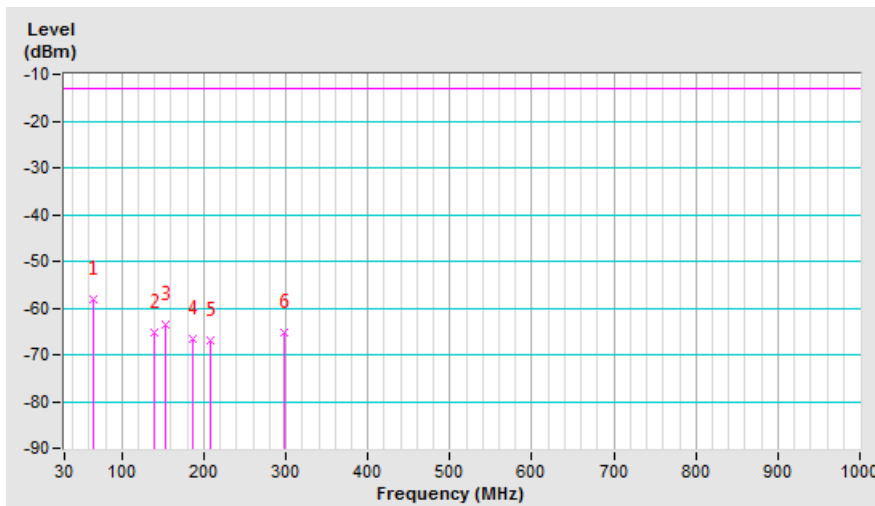

Mode	TX channel 20450 (829.0MHz)	Frequency Range	Below 1000 MHz
Environmental Conditions	22deg. C, 66%RH	Input Power	120Vac, 60Hz
Tested By	Han Wu		

Antenna Polarity & Test Distance: Vertical at 3 M							
No.	Freq. (MHz)	Reading (dBm)	S.G Power Value (dBm)	Correction Factor (dB)	ERP (dBm)	Limit (dBm)	Margin (dB)
1	65.89	-42.7	-50.3	-1.9	-52.2	-13.0	-39.2
2	134.76	-49.0	-51.5	-3.2	-54.7	-13.0	-41.7
3	204.60	-57.0	-59.0	-2.0	-61.0	-13.0	-48.0
4	275.41	-61.0	-58.4	-1.6	-60.0	-13.0	-47.0
5	334.58	-60.1	-66.9	4.0	-62.9	-13.0	-49.9
6	436.43	-60.2	-66.0	3.6	-62.4	-13.0	-49.4

Remarks:

1. ERP (dBm) = S.G Value (dBm) + Correction Factor (dB).
2. Correction Factor (dB) = Substitution Antenna Gain (dB) + Cable Loss (dB).

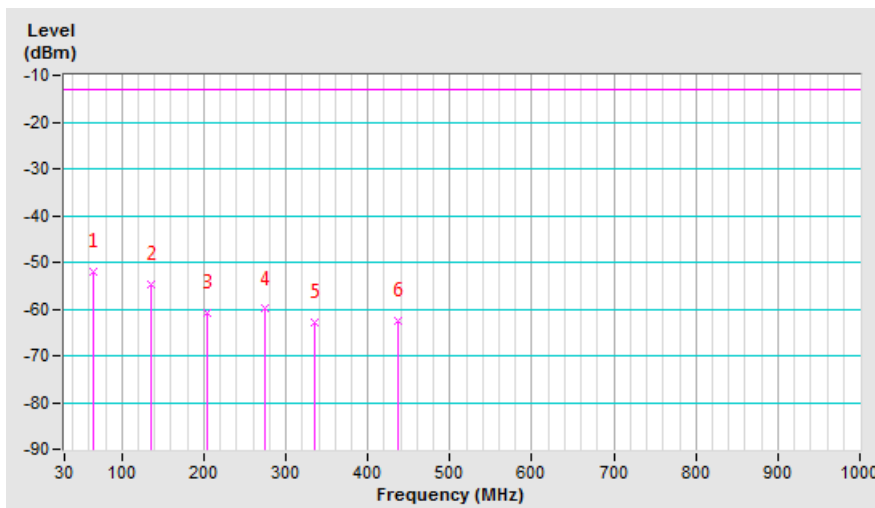

Above 1GHz
GSM Mode

Mode	TX channel 128 (824.2MHz)	Frequency Range	1GHz ~ 10GHz
Environmental Conditions	22deg. C, 68%RH	Input Power	120Vac, 60Hz
Tested By	Greg Lin		

Antenna Polarity & Test Distance: Horizontal at 3 M							
No.	Freq. (MHz)	Reading (dBm)	S.G Power Value (dBm)	Correction Factor (dB)	ERP (dBm)	Limit (dBm)	Margin (dB)
1	1648.40	-54.4	-46.7	0.9	-45.8	-13.0	-32.8
Antenna Polarity & Test Distance: Vertical at 3 M							
No.	Freq. (MHz)	Reading (dBm)	S.G Power Value (dBm)	Correction Factor (dB)	ERP (dBm)	Limit (dBm)	Margin (dB)
1	1648.40	-52.0	-44.6	0.9	-43.7	-13.0	-30.7

Remarks:

1. ERP (dBm) = S.G Value (dBm) + Correction Factor (dB).
2. Correction Factor (dB) = Substitution Antenna Gain (dB) + Cable Loss (dB).

Mode	TX channel 189 (836.4MHz)	Frequency Range	1GHz ~ 10GHz
Environmental Conditions	22deg. C, 68%RH	Input Power	120Vac, 60Hz
Tested By	Greg Lin		

Antenna Polarity & Test Distance: Horizontal at 3 M							
No.	Freq. (MHz)	Reading (dBm)	S.G Power Value (dBm)	Correction Factor (dB)	ERP (dBm)	Limit (dBm)	Margin (dB)
1	1672.80	-54.0	-46.4	0.8	-45.6	-13.0	-32.6
Antenna Polarity & Test Distance: Vertical at 3 M							
No.	Freq. (MHz)	Reading (dBm)	S.G Power Value (dBm)	Correction Factor (dB)	ERP (dBm)	Limit (dBm)	Margin (dB)
1	1672.80	-51.8	-44.4	0.8	-43.6	-13.0	-30.6

Remarks:

1. ERP (dBm) = S.G Value (dBm) + Correction Factor (dB).
2. Correction Factor (dB) = Substitution Antenna Gain (dB) + Cable Loss (dB).

Mode	TX channel 251 (848.8MHz)	Frequency Range	1GHz ~ 10GHz
Environmental Conditions	22deg. C, 68%RH	Input Power	120Vac, 60Hz
Tested By	Greg Lin		

Antenna Polarity & Test Distance: Horizontal at 3 M							
No.	Freq. (MHz)	Reading (dBm)	S.G Power Value (dBm)	Correction Factor (dB)	ERP (dBm)	Limit (dBm)	Margin (dB)
1	1697.60	-53.5	-45.9	0.7	-45.2	-13.0	-32.2
Antenna Polarity & Test Distance: Vertical at 3 M							
No.	Freq. (MHz)	Reading (dBm)	S.G Power Value (dBm)	Correction Factor (dB)	ERP (dBm)	Limit (dBm)	Margin (dB)
1	1697.60	-51.2	-43.9	0.7	-43.2	-13.0	-30.2

Remarks:

1. ERP (dBm) = S.G Value (dBm) + Correction Factor (dB).
2. Correction Factor (dB) = Substitution Antenna Gain (dB) + Cable Loss (dB).

WCDMA Band 5

Mode	TX channel 4132 (826.4MHz)	Frequency Range	1GHz ~ 10GHz
Environmental Conditions	22deg. C, 68%RH	Input Power	120Vac, 60Hz
Tested By	Greg Lin		

Antenna Polarity & Test Distance: Horizontal at 3 M							
No.	Freq. (MHz)	Reading (dBm)	S.G Power Value (dBm)	Correction Factor (dB)	ERP (dBm)	Limit (dBm)	Margin (dB)
1	1652.80	-60.5	-52.8	0.9	-51.9	-13.0	-38.9
Antenna Polarity & Test Distance: Vertical at 3 M							
No.	Freq. (MHz)	Reading (dBm)	S.G Power Value (dBm)	Correction Factor (dB)	ERP (dBm)	Limit (dBm)	Margin (dB)
1	1652.80	-58.0	-50.8	0.9	-49.9	-13.0	-36.9

Remarks:

1. ERP (dBm) = S.G Value (dBm) + Correction Factor (dB).
2. Correction Factor (dB) = Substitution Antenna Gain (dB) + Cable Loss (dB).

Mode	TX channel 4182 (836.4MHz)	Frequency Range	1GHz ~ 10GHz
Environmental Conditions	22deg. C, 68%RH	Input Power	120Vac, 60Hz
Tested By	Greg Lin		

Antenna Polarity & Test Distance: Horizontal at 3 M							
No.	Freq. (MHz)	Reading (dBm)	S.G Power Value (dBm)	Correction Factor (dB)	ERP (dBm)	Limit (dBm)	Margin (dB)
1	1672.80	-60.2	-52.6	0.8	-51.8	-13.0	-38.8
Antenna Polarity & Test Distance: Vertical at 3 M							
No.	Freq. (MHz)	Reading (dBm)	S.G Power Value (dBm)	Correction Factor (dB)	ERP (dBm)	Limit (dBm)	Margin (dB)
1	1672.80	-57.8	-50.4	0.8	-49.6	-13.0	-36.6

Remarks:

1. ERP (dBm) = S.G Value (dBm) + Correction Factor (dB).
2. Correction Factor (dB) = Substitution Antenna Gain (dB) + Cable Loss (dB).

Mode	TX channel 4233 (846.6MHz)	Frequency Range	1GHz ~ 10GHz
Environmental Conditions	22deg. C, 68%RH	Input Power	120Vac, 60Hz
Tested By	Greg Lin		

Antenna Polarity & Test Distance: Horizontal at 3 M							
No.	Freq. (MHz)	Reading (dBm)	S.G Power Value (dBm)	Correction Factor (dB)	ERP (dBm)	Limit (dBm)	Margin (dB)
1	1693.20	-60.8	-53.2	0.7	-52.5	-13.0	-39.5
Antenna Polarity & Test Distance: Vertical at 3 M							
No.	Freq. (MHz)	Reading (dBm)	S.G Power Value (dBm)	Correction Factor (dB)	ERP (dBm)	Limit (dBm)	Margin (dB)
1	1693.20	-58.2	-50.9	0.7	-50.2	-13.0	-37.2

Remarks:

1. $ERP (dBm) = S.G \text{ Value (dBm)} + \text{Correction Factor (dB)}$.
2. $\text{Correction Factor (dB)} = \text{Substitution Antenna Gain (dB)} + \text{Cable Loss (dB)}$.

LTE Band 5, Channel Bandwidth: 1.4MHz

Mode	TX channel 20407 (824.7MHz)	Frequency Range	1GHz ~ 10GHz
Environmental Conditions	22deg. C, 68%RH	Input Power	120Vac, 60Hz
Tested By	Greg Lin		

Antenna Polarity & Test Distance: Horizontal at 3 M

No.	Freq. (MHz)	Reading (dBm)	S.G Power Value (dBm)	Correction Factor (dB)	ERP (dBm)	Limit (dBm)	Margin (dB)
1	1649.40	-58.6	-50.9	0.9	-50.0	-13.0	-37.0

Antenna Polarity & Test Distance: Vertical at 3 M

No.	Freq. (MHz)	Reading (dBm)	S.G Power Value (dBm)	Correction Factor (dB)	ERP (dBm)	Limit (dBm)	Margin (dB)
1	1649.40	-56.2	-49.0	0.9	-48.1	-13.0	-35.1

Remarks:

1. ERP (dBm) = S.G Value (dBm) + Correction Factor (dB).
2. Correction Factor (dB) = Substitution Antenna Gain (dB) + Cable Loss (dB).

Mode	TX channel 20525 (836.5MHz)	Frequency Range	1GHz ~ 10GHz
Environmental Conditions	22deg. C, 68%RH	Input Power	120Vac, 60Hz
Tested By	Greg Lin		

Antenna Polarity & Test Distance: Horizontal at 3 M

No.	Freq. (MHz)	Reading (dBm)	S.G Power Value (dBm)	Correction Factor (dB)	ERP (dBm)	Limit (dBm)	Margin (dB)
1	1673.00	-59.5	-51.8	0.8	-51.0	-13.0	-38.0

Antenna Polarity & Test Distance: Vertical at 3 M

No.	Freq. (MHz)	Reading (dBm)	S.G Power Value (dBm)	Correction Factor (dB)	ERP (dBm)	Limit (dBm)	Margin (dB)
1	1673.00	-56.2	-48.9	0.8	-48.1	-13.0	-35.1

Remarks:

1. ERP (dBm) = S.G Value (dBm) + Correction Factor (dB).
2. Correction Factor (dB) = Substitution Antenna Gain (dB) + Cable Loss (dB).

Mode	TX channel 20643 (848.3MHz)	Frequency Range	1GHz ~ 10GHz
Environmental Conditions	22deg. C, 68%RH	Input Power	120Vac, 60Hz
Tested By	Greg Lin		

Antenna Polarity & Test Distance: Horizontal at 3 M							
No.	Freq. (MHz)	Reading (dBm)	S.G Power Value (dBm)	Correction Factor (dB)	ERP (dBm)	Limit (dBm)	Margin (dB)
1	1696.60	-59.2	-53.3	-0.4	-53.7	-13.0	-40.7
Antenna Polarity & Test Distance: Vertical at 3 M							
No.	Freq. (MHz)	Reading (dBm)	S.G Power Value (dBm)	Correction Factor (dB)	ERP (dBm)	Limit (dBm)	Margin (dB)
1	1696.60	-56.5	-52.1	-0.4	-52.5	-13.0	-39.5

Remarks:

1. ERP (dBm) = S.G Value (dBm) + Correction Factor (dB).
2. Correction Factor (dB) = Substitution Antenna Gain (dB) + Cable Loss (dB).

LTE Band 5, Channel Bandwidth: 5MHz

Mode	TX channel 20425 (826.5MHz)	Frequency Range	1GHz ~ 10GHz
Environmental Conditions	22deg. C, 68%RH	Input Power	120Vac, 60Hz
Tested By	Greg Lin		

Antenna Polarity & Test Distance: Horizontal at 3 M

No.	Freq. (MHz)	Reading (dBm)	S.G Power Value (dBm)	Correction Factor (dB)	ERP (dBm)	Limit (dBm)	Margin (dB)
1	1653.00	-58.9	-51.1	0.9	-50.2	-13.0	-37.2

Antenna Polarity & Test Distance: Vertical at 3 M

No.	Freq. (MHz)	Reading (dBm)	S.G Power Value (dBm)	Correction Factor (dB)	ERP (dBm)	Limit (dBm)	Margin (dB)
1	1653.00	-56.2	-49.0	0.9	-48.1	-13.0	-35.1

Remarks:

1. ERP (dBm) = S.G Value (dBm) + Correction Factor (dB).
2. Correction Factor (dB) = Substitution Antenna Gain (dB) + Cable Loss (dB).

Mode	TX channel 20525 (836.5MHz)	Frequency Range	1GHz ~ 10GHz
Environmental Conditions	22deg. C, 68%RH	Input Power	120Vac, 60Hz
Tested By	Greg Lin		

Antenna Polarity & Test Distance: Horizontal at 3 M

No.	Freq. (MHz)	Reading (dBm)	S.G Power Value (dBm)	Correction Factor (dB)	ERP (dBm)	Limit (dBm)	Margin (dB)
1	1673.00	-59.3	-51.7	0.8	-50.9	-13.0	-37.9

Antenna Polarity & Test Distance: Vertical at 3 M

No.	Freq. (MHz)	Reading (dBm)	S.G Power Value (dBm)	Correction Factor (dB)	ERP (dBm)	Limit (dBm)	Margin (dB)
1	1673.00	-56.2	-48.9	0.8	-48.1	-13.0	-35.1

Remarks:

1. ERP (dBm) = S.G Value (dBm) + Correction Factor (dB).
2. Correction Factor (dB) = Substitution Antenna Gain (dB) + Cable Loss (dB).

Mode	TX channel 20625 (846.5MHz)	Frequency Range	1GHz ~ 10GHz
Environmental Conditions	22deg. C, 68%RH	Input Power	120Vac, 60Hz
Tested By	Greg Lin		

Antenna Polarity & Test Distance: Horizontal at 3 M							
No.	Freq. (MHz)	Reading (dBm)	S.G Power Value (dBm)	Correction Factor (dB)	ERP (dBm)	Limit (dBm)	Margin (dB)
1	1693.00	-58.5	-50.9	0.7	-50.2	-13.0	-37.2
Antenna Polarity & Test Distance: Vertical at 3 M							
No.	Freq. (MHz)	Reading (dBm)	S.G Power Value (dBm)	Correction Factor (dB)	ERP (dBm)	Limit (dBm)	Margin (dB)
1	1693.00	-55.9	-48.6	0.7	-47.9	-13.0	-34.9

Remarks:

1. ERP (dBm) = S.G Value (dBm) + Correction Factor (dB).
2. Correction Factor (dB) = Substitution Antenna Gain (dB) + Cable Loss (dB).

LTE Band 5, Channel Bandwidth: 10MHz

Mode	TX channel 20450 (829.0MHz)	Frequency Range	1GHz ~ 10GHz
Environmental Conditions	22deg. C, 68%RH	Input Power	120Vac, 60Hz
Tested By	Greg Lin		

Antenna Polarity & Test Distance: Horizontal at 3 M

No.	Freq. (MHz)	Reading (dBm)	S.G Power Value (dBm)	Correction Factor (dB)	ERP (dBm)	Limit (dBm)	Margin (dB)
1	1658.00	-59.0	-51.4	0.9	-50.5	-13.0	-37.5

Antenna Polarity & Test Distance: Vertical at 3 M

No.	Freq. (MHz)	Reading (dBm)	S.G Power Value (dBm)	Correction Factor (dB)	ERP (dBm)	Limit (dBm)	Margin (dB)
1	1658.00	-56.9	-49.7	0.9	-48.8	-13.0	-35.8

Remarks:

1. ERP (dBm) = S.G Value (dBm) + Correction Factor (dB).
2. Correction Factor (dB) = Substitution Antenna Gain (dB) + Cable Loss (dB).

Mode	TX channel 20525 (836.5MHz)	Frequency Range	1GHz ~ 10GHz
Environmental Conditions	22deg. C, 68%RH	Input Power	120Vac, 60Hz
Tested By	Greg Lin		

Antenna Polarity & Test Distance: Horizontal at 3 M

No.	Freq. (MHz)	Reading (dBm)	S.G Power Value (dBm)	Correction Factor (dB)	ERP (dBm)	Limit (dBm)	Margin (dB)
1	1673.00	-58.5	-50.9	0.8	-50.1	-13.0	-37.1

Antenna Polarity & Test Distance: Vertical at 3 M

No.	Freq. (MHz)	Reading (dBm)	S.G Power Value (dBm)	Correction Factor (dB)	ERP (dBm)	Limit (dBm)	Margin (dB)
1	1673.00	-56.6	-49.3	0.8	-48.5	-13.0	-35.5

Remarks:

1. ERP (dBm) = S.G Value (dBm) + Correction Factor (dB).
2. Correction Factor (dB) = Substitution Antenna Gain (dB) + Cable Loss (dB).

Mode	TX channel 20600 (844.0MHz)	Frequency Range	1GHz ~ 10GHz
Environmental Conditions	22deg. C, 68%RH	Input Power	120Vac, 60Hz
Tested By	Greg Lin		

Antenna Polarity & Test Distance: Horizontal at 3 M							
No.	Freq. (MHz)	Reading (dBm)	S.G Power Value (dBm)	Correction Factor (dB)	ERP (dBm)	Limit (dBm)	Margin (dB)
1	1688.00	-59.1	-51.4	0.7	-50.7	-13.0	-37.7
Antenna Polarity & Test Distance: Vertical at 3 M							
No.	Freq. (MHz)	Reading (dBm)	S.G Power Value (dBm)	Correction Factor (dB)	ERP (dBm)	Limit (dBm)	Margin (dB)
1	1688.00	-59.1	-51.4	0.7	-50.7	-13.0	-37.7

Remarks:

1. $ERP (dBm) = S.G \text{ Value (dBm)} + \text{Correction Factor (dB)}$.
2. $\text{Correction Factor (dB)} = \text{Substitution Antenna Gain (dB)} + \text{Cable Loss (dB)}$.

5 Pictures of Test Arrangements

Please refer to the attached file (Test Setup Photo).

Appendix – Information of the Testing Laboratories

We, Bureau Veritas Consumer Products Services (H.K.) Ltd., Taoyuan Branch, were founded in 1988 to provide our best service in EMC, Radio, Telecom and Safety consultation. Our laboratories are FCC recognized accredited test firms and accredited and approved according to ISO/IEC 17025.

If you have any comments, please feel free to contact us at the following:

Lin Kou EMC/RF Lab

Tel: 886-2-26052180

Fax: 886-2-26051924

Hsin Chu EMC/RF/Telecom Lab

Tel: 886-3-6668565

Fax: 886-3-6668323

Hwa Ya EMC/RF/Safety Lab

Tel: 886-3-3183232

Fax: 886-3-3270892

Email: service.adt@tw.bureauveritas.com

Web Site: www.bureauveritas-adt.com

The address and road map of all our labs can be found in our web site also.

--- END ---