

FCC TEST REPORT (PART 24)

Applicant:	Continental Automotive Systems, Inc.
Address:	21440 W Lake Cook Rd., Deer Park, IL 60010, USA

Manufacturer or Supplier:	Continental Automotive Systems, Inc.
Address:	21440 W Lake Cook Rd., Deer Park, IL 60010, USA
Product:	BL28RW-RD1
Brand Name:	Continental
Model Name:	BL28RW-RD1
FCC ID:	LHJ-BL28RWRD1
Date of tests:	Jun. 16, 2021 ~ Jul. 06, 2021

The tests have been carried out according to the requirements of the following standard:

- FCC PART 24, Subpart E**
 FCC PART 2
 ANSI/TIA/EIA-603-D
 ANSI/TIA/EIA-603-E
 ANSI C63.26-2015

CONCLUSION: The submitted sample was found to COMPLY with the test requirement

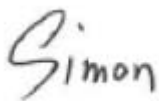
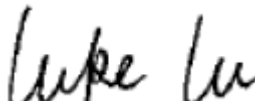
Prepared by Simon Wang Engineer / Mobile Department	Approved by Luke Lu Manager / Mobile Department
 Date: Jul. 07, 2021	 Date: Jul. 07, 2021

This report is governed by, and incorporates by reference, CPS Conditions of Service as posted at the date of issuance of this report at <http://www.bureauveritas.com/home/about-us/our-business/cps/about-us/terms-conditions> and is intended for your exclusive use. Any copying or replication of this report to or for any other person or entity, or use of our name or trademark, is permitted only with our prior written permission. This report sets forth our findings solely with respect to the test samples identified herein. The results set forth in this report are not indicative or representative of the quality or characteristics of the lot from which a test sample was taken or any similar or identical product unless specifically and expressly noted. Our report includes all of the tests requested by you and the results thereof based upon the information that you provided to us. Measurement uncertainty is only provided upon request for accredited tests. You have 60 days from date of issuance of this report to notify us of any material error or omission caused by our negligence or if you require measurement uncertainty; provided, however, that such notice shall be in writing and shall specifically address the issue you wish to raise. A failure to raise such issue within the prescribed time shall constitute your unqualified acceptance of the completeness of this report, the tests conducted and the correctness of the report contents.



TABLE OF CONTENTS

RELEASE CONTROL RECORD	4
1 SUMMARY OF TEST RESULTS	5
1.1 MEASUREMENT UNCERTAINTY	5
1.2 TEST SITE AND INSTRUMENTS	6
2 GENERAL INFORMATION	7
2.1 GENERAL DESCRIPTION OF EUT	7
2.2 CONFIGURATION OF SYSTEM UNDER TEST	11
2.3 DESCRIPTION OF SUPPORT UNITS	12
2.4 TEST ITEM AND TEST CONFIGURATION.....	12
2.5 EUT OPERATING CONDITIONS	15
2.6 GENERAL DESCRIPTION OF APPLIED STANDARDS	15
3 TEST TYPES AND RESULTS	16
3.1 OUTPUT POWER MEASUREMENT	16
3.1.1 LIMITS OF OUTPUT POWER MEASUREMENT	16
3.1.2 TEST PROCEDURES.....	16
3.1.3 TEST SETUP	17
3.1.4 TEST RESULTS.....	17
3.2 FREQUENCY STABILITY MEASUREMENT	25
3.2.1 LIMITS OF FREQUENCY STABILITY MEASUREMENT	25
3.2.2 TEST PROCEDURE	25
3.2.3 TEST SETUP	25
3.2.4 TEST RESULTS.....	26
3.3 OCCUPIED BANDWIDTH MEASUREMENT	35
3.3.1 TEST PROCEDURES.....	35
3.3.2 TEST SETUP	35
3.3.3 TEST RESULTS.....	36
3.4 BAND EDGE MEASUREMENTC	44
3.4.1 LIMITS OF BAND EDGE MEASUREMENT	44
3.4.2 TEST SETUP	44
3.4.3 TEST PROCEDURES.....	45
3.4.4. TEST RESULTS.....	46
3.5 CONDUCTED SPURIOUS EMISSIONS.....	59
3.5.1 LIMITS OF CONDUCTED SPURIOUS EMISSIONS MEASUREMENT	59
3.5.2 TEST PROCEDURE	59
3.5.3 TEST SETUP	59
3.5.4 TEST RESULTS.....	60
3.6 RADIATED EMISSION MEASUREMENT	69
3.6.1 LIMITS OF RADIATED EMISSION MEASUREMENT	69
3.6.2 TEST PROCEDURES.....	69
3.6.3 DEVIATION FROM TEST STANDARD.....	69



**BUREAU
VERITAS**

Test Report No.: W7L-P20210616-2RF05

3.6.4 TEST SETUP	70
3.6.5 TEST RESULTS	71
3.7 PEAK TO AVERAGE RATIO	107
3.7.1 LIMITS OF PEAK TO AVERAGE RATIO MEASUREMENT	107
3.7.2 TEST SETUP	107
3.7.3 TEST PROCEDURES	107
3.7.4 TEST RESULTS	108
4 INFORMATION ON THE TESTING LABORATORIES	123
5 APPENDIX A – MODIFICATIONS RECORDERS FOR ENGINEERING CHANGES TO THE EUT BY THE LAB	123



Test Report No.: W7L-P20210616-2RF05

RELEASE CONTROL RECORD

ISSUE NO.	REASON FOR CHANGE	DATE ISSUED
W7L-P20210616-2RF05	Original release	Jul. 07, 2021

1 SUMMARY OF TEST RESULTS

The EUT has been tested according to the following specifications:

APPLIED STANDARD: FCC Part 24 & Part 2		
STANDARD SECTION	1.1.1.1.1 TEST TYPE	RESULT
2.1046 24.232	Equivalent Isotropic Radiated Power	Compliance
2.1055 24.235	Frequency Stability	Compliance
2.1049 24.238(b)	Occupied Bandwidth	Compliance
24.232(d)	Peak to average ratio	Compliance
24.238(b)	Band Edge Measurements	Compliance
2.1051 24.238	Conducted Spurious Emissions	Compliance
2.1053 24.238	Radiated Spurious Emissions	Compliance

1.1 MEASUREMENT UNCERTAINTY

Where relevant, the following measurement uncertainty levels have been estimated for tests performed on the EUT as specified in CISPR 16-4-2:

MEASUREMENT	UNCERTAINTY
Frequency Stability	$\pm 76.97\text{Hz}$
Radiated emissions & Radiated Power (30MHz~1GMHz)	$\pm 4.98\text{dB}$
Radiated emissions & Radiated Power (1GMHz ~6GMHz)	$\pm 4.70\text{dB}$
Radiated emissions (6GMHz ~18GMHz)	$\pm 4.60\text{dB}$
Radiated emissions (18GMHz ~40GMHz)	$\pm 4.12\text{dB}$
Conducted emissions	$\pm 4.01\text{dB}$
Occupied Channel Bandwidth	$\pm 43.58\text{KHz}$
Conducted Output power	$\pm 2.06\text{dB}$
Band Edge Measurements	$\pm 4.70\text{dB}$
Peak to average ratio	$\pm 0.76\text{dB}$

This uncertainty represents an expanded uncertainty expressed at approximately the 95% confidence level using a coverage factor of $k=2$.



1.2 TEST SITE AND INSTRUMENTS

Equipment	Manufacturer	Model No.	Serial No.	Last Cal.	Next Cal.
MXE EMI Receiver	KEYSIGHT	N9038A-544	MY54450026	Apr. 22,21	Apr. 21,22
EXA Signal Analyzer	KEYSIGHT	N9010A-544	MY54510355	Jun. 03,21	Jun. 02,22
Bilog Antenna 2	ETS-LINDGREN	3143B	00161965	Mar. 05,21	Mar. 04,22
Horn Antenna 1	ETS-LINDGREN	3117	00168728	Aug. 21,20	Aug. 20,21
Horn Antenna 2	ETS-LINDGREN	3117	00168692	Apr. 02,21	Apr. 01,22
Horn Antenna (18GHz-40GHz)	N/A	QWH-SL-18-40-K-SG/QMS-00361	15433	Aug. 26, 20	Aug. 25, 21
Radio Communication Analyzer	ANRITSU	MT8820C	6201465426	Feb. 25,21	Feb. 24,22
Signal Pre-Amplifier	EMSI	EMC 9135	980249	Jun. 02,21	Jun. 01,22
Signal Pre-Amplifier	EMSI	EMC 012645B	980257	Jun. 03,21	Jun. 02,22
Signal Pre-Amplifier	EMSI	EMC 184045B	980259	Apr. 22,21	Apr. 21,22
3m Semi-anechoic Chamber	ETS-LINDGREN	9m*6m*6m	Euroshieldpn-CT0001143-1216	May. 19,20	May. 18,23
Test Software	E3	V 9.160323	N/A	N/A	N/A
Test Software	ADT	ADT_Radiated_V 7.6.15.9.2	N/A	N/A	N/A
10dB Attenuator	JFW/USA	50HF-010-SMA	1505	Jun. 03,21	Jun. 02,22
Power Meter	Anritsu	ML2495A	1506002	Apr. 07,21	Apr. 06,22
Power Sensor	Anritsu	MA2411B	1339352	May. 07,21	May. 06,22
Temperature Chamber	ESPEC	SH-242	93000855	Jun. 02,21	Jun. 01,22
MXG Analog Microwave Signal Generator	KEYSIGHT	N5183A	MY50143024	Mar. 05,21	Mar. 04,22
Power Divider	MCLI/USA	PS2-15	24880	N/A	N/A

- NOTE:**
1. The calibration interval of the above test instruments is 12 months or 24 months and the calibrations are traceable to CEPREI/CHINA, GRGT/CHINA and NIM/CHINA.
 2. The test was performed in 3m Semi-anechoic Chamber and RF Oven Room.
 3. The horn antenna is used only for the measurement of emission frequency above 1GHz if tested.
 4. The FCC Site Registration No. is 525120; The Designation No. is CN1171.



2 GENERAL INFORMATION

2.1 GENERAL DESCRIPTION OF EUT

PRODUCT	BL28RW-RD1	
BRAND NAME	Continental	
MODEL NAME	BL28RW-RD1	
NOMINAL VOLTAGE	EUT 4.0V	
MODULATION TYPE	GSM/GPRS: GMSK EDGE: 8PSK WCDMA: BPSK,QPSK LTE Band 2: QPSK, 16QAM	
FREQUENCY RANGE	GSM/GPRS, EDGE	1850.2MHz ~ 1909.8MHz
	WCDMA	1852.4MHz ~ 1907.6MHz
	LTE Band 2 Channel Bandwidth: 1.4MHz	1850.7MHz ~ 1909.3MHz
	LTE Band 2 Channel Bandwidth: 3MHz	1851.5MHz ~ 1908.5MHz
	LTE Band 2 Channel Bandwidth: 5MHz	1852.5MHz ~ 1907.5MHz
	LTE Band 2 Channel Bandwidth: 10MHz	1855.0MHz ~ 1905.0MHz
	LTE Band 2 Channel Bandwidth: 15MHz	1857.5MHz ~ 1902.5MHz
	LTE Band 2 Channel Bandwidth: 20MHz	1860.0MHz ~ 1900.0MHz



MAX. EIRP POWER	GSM/GPRS	1380.38mW
	EDGE	558.47mW
	WCDMA	285.76mW
	LTE Band 2 Channel Bandwidth: 1.4MHz	230.14mW
	LTE Band 2 Channel Bandwidth: 3MHz	290.40mW
	LTE Band 2 Channel Bandwidth: 5MHz	289.73mW
	LTE Band 2 Channel Bandwidth: 10MHz	289.07mW
	LTE Band 2 Channel Bandwidth: 15MHz	292.42mW
	LTE Band 2 Channel Bandwidth: 20MHz	233.35mW



**BUREAU
VERITAS**

Test Report No.: W7L-P20210616-2RF05

EMISSION DESIGNATOR	GSM/GPRS	240KGXW
	EDGE	240KG7W
	WCDMA	4M15F9W
	LTE Band 2 Channel Bandwidth: 1.4MHz	QPSK: 1M09G7D 16QAM: 1M09W7D
	LTE Band 2 Channel Bandwidth: 3MHz	QPSK: 2M69G7D 16QAM: 2M69W7D
	LTE Band 2 Channel Bandwidth: 5MHz	QPSK: 4M49G7D 16QAM: 4M49W7D
	LTE Band 2 Channel Bandwidth: 10MHz	QPSK: 8M95G7D 16QAM: 8M95W7D
	LTE Band 2 Channel Bandwidth: 15MHz	QPSK: 13M42G7D 16QAM: 13M45W7D
	LTE Band 2 Channel Bandwidth: 20MHz	QPSK: 17M92G7D 16QAM: 17M90W7D
	ANTENNA TYPE	Dipole Antenna with 1.52dBi gain
HW VERSION	P4.0	
SW VERSION	MODEM9x28_64.01.15	
I/O PORTS	Refer to user's manual	
CABLE SUPPLIED	N/A	
EXTREME TEMPERATURE	-30-75 °C	
EXTREME VOLTAGE	EUT 3.8V - EUT 4.2V	



NOTE:

1. For a more detailed features description, please refer to the manufacturer's specifications or the user's manual.
2. The EUT incorporates a SISO function. Physically, the EUT provides one completed transmitter and one receiver.

MODULATION MODE	TX FUNCTION
GSM/GPRS/EDGE	1TX/1RX
WCDMA	1TX/1RX
LTE	1TX/1RX

3. For the test results, the EUT had been tested with all conditions. But only the worst case was shown in test report.



2.2 CONFIGURATION OF SYSTEM UNDER TEST

FOR RADIATION EMISSION TEST

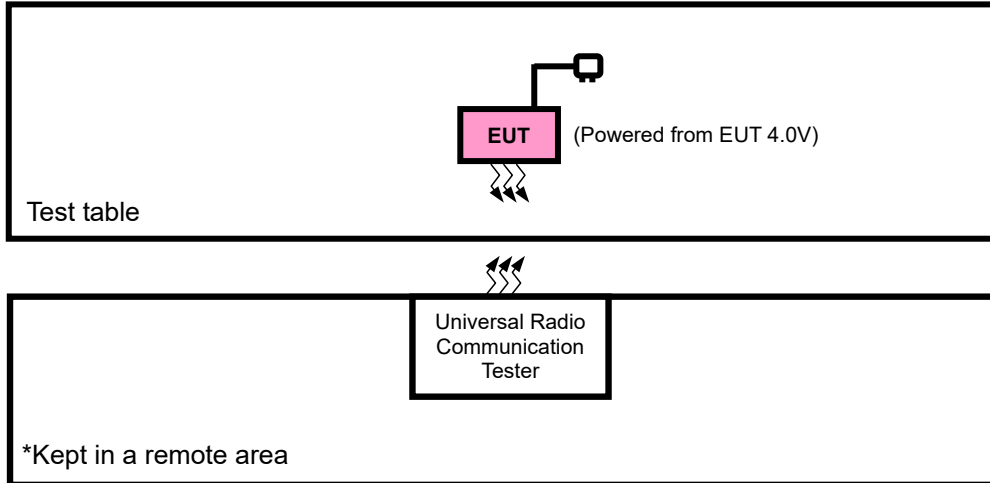



2.3 DESCRIPTION OF SUPPORT UNITS

The EUT has been tested as an independent unit together with other necessary accessories or support units. The following support units or accessories were used to form a representative test configuration during the tests.

NO.	PRODUCT	BRAND	MODEL NO.	SERIAL NO.	FCC ID
1	DC source	Kikusui/JP	PMX18-5A	0000001	N/A

NO.	SIGNAL CABLE DESCRIPTION OF THE ABOVE SUPPORT UNITS
1	DC Line: Unshielded, Detachable 1.0m

2.4 TEST ITEM AND TEST CONFIGURATION

Pre-Scan has been conducted to determine the worst-case mode from all possible combinations between available modulations, data rates, XYZ axis and antenna ports. The worst case in EIRP and radiated emission was found when positioned on X-plane for GSM/EDGE/ LTE. Following channel(s) was (were) selected for the final test as listed below:

EUT CONFIGURE MODE	1.1.1.1.1.2DESCRIPTION
A	EUT + DC Source with GSM or WCDMA or LTE link

GSM MODE

EUT CONFIGURE MODE	TEST ITEM	AVAILABLE CHANNEL	TESTED CHANNEL	MODE
B	EIRP	512 to 810	512, 661, 810	GSM, EDGE
B	FREQUENCY STABILITY	512 to 810	512, 810	GSM, EDGE
B	OCCUPIED BANDWIDTH	512 to 810	512, 661, 810	GSM, EDGE
B	PEAK TO AVERAGE RATIO	512 to 810	512, 661, 810	GSM, EDGE
B	BAND EDGE	512 to 810	512, 810	GSM, EDGE
B	CONDCUDED EMISSION	512 to 810	512, 661, 810	GSM, EDGE
A	RADIATED EMISSION	512 to 810	512, 661, 810	GSM, EDGE



WCDMA

EUT CONFIGURE MODE	TEST ITEM	AVAILABLE CHANNEL	TESTED CHANNEL	MODE
B	EIRP	9262 to 9538	9262, 9400, 9538	WCDMA
B	FREQUENCY STABILITY	9262 to 9538	9262, 9538	WCDMA
B	OCCUPIED BANDWIDTH	9262 to 9538	9262, 9400, 9538	WCDMA
B	PEAK TO AVERAGE RATIO	9262 to 9538	9262, 9400, 9538	WCDMA
B	BAND EDGE	9262 to 9538	9262, 9538	WCDMA
B	CONDCUDED EMISSION	9262 to 9538	9262, 9400, 9538	WCDMA
A	RADIATED EMISSION	9262 to 9538	9262, 9400, 9538	WCDMA

LTE BAND 2

EUT CONFIGURE MODE	TEST ITEM	AVAILABLE CHANNEL	TESTED CHANNEL	CHANNEL BANDWIDTH	MODULATION	MODE
B	EIRP	18607 to 19193	18607, 18900, 19193	1.4MHz	QPSK,16QAM	1 RB / 0 RB Offset
		18615 to 19185	18615, 18900, 19185	3MHz	QPSK,16QAM	1 RB / 0 RB Offset
		18625 to 19175	18625, 18900, 19175	5MHz	QPSK,16QAM	1 RB / 0 RB Offset
		18650 to 19150	18650, 18900, 19150	10MHz	QPSK,16QAM	1 RB / 0 RB Offset
		18675 to 19125	18675, 18900, 19125	15MHz	QPSK,16QAM	1 RB / 0 RB Offset
		18700 to 19100	18700, 18900, 19100	20MHz	QPSK,16QAM	1 RB / 0 RB Offset
B	FREQUENCY STABILITY	18607 to 19193	18607, 19193	1.4MHz	QPSK	1 RB / 0 RB Offset
		18615 to 19185	18615, 19185	3MHz	QPSK	1 RB / 0 RB Offset
		18625 to 19175	18625, 19175	5MHz	QPSK	1 RB / 0 RB Offset
		18650 to 19150	18650, 19150	10MHz	QPSK	1 RB / 0 RB Offset
		18675 to 19125	18675, 19125	15MHz	QPSK	1 RB / 0 RB Offset
		18700 to 19100	18700, 19100	20MHz	QPSK	1 RB / 0 RB Offset
B	OCCUPIED BANDWIDTH	18607 to 19193	18607, 18900, 19193	1.4MHz	QPSK,16QAM	6 RB / 0 RB Offset
		18615 to 19185	18615, 18900, 19185	3MHz	QPSK,16QAM	15 RB / 0 RB Offset
		18625 to 19175	18625, 18900, 19175	5MHz	QPSK,16QAM	25 RB / 0 RB Offset
		18650 to 19150	18650, 18900, 19150	10MHz	QPSK,16QAM	50 RB / 0 RB Offset
		18675 to 19125	18675, 18900, 19125	15MHz	QPSK,16QAM	75 RB / 0 RB Offset
		18700 to 19100	18700, 18900, 19100	20MHz	QPSK,16QAM	100 RB / 0 RB Offset
B	PEAK TO AVERAGE RATIO	18607 to 19193	18607, 18900, 19193	1.4MHz	QPSK,16QAM	1 RB / 0 RB Offset
		18615 to 19185	18615, 18900, 19185	3MHz	QPSK,16QAM	1 RB / 0 RB Offset
		18625 to 19175	18625, 18900, 19175	5MHz	QPSK,16QAM	1 RB / 0 RB Offset
		18650 to 19150	18650, 18900, 19150	10MHz	QPSK,16QAM	1 RB / 0 RB Offset
		18675 to 19125	18675, 18900, 19125	15MHz	QPSK,16QAM	1 RB / 0 RB Offset
		18700 to 19100	18700, 18900, 19100	20MHz	QPSK,16QAM	1 RB / 0 RB Offset

B	BAND EDGE	18607 to 19193	18607	1.4MHz	QPSK,16QAM	1 RB / 0 RB Offset		
			19193	1.4MHz	QPSK,16QAM	6 RB / 0 RB Offset		
		18615 to 19185	18615	3MHz	QPSK,16QAM	1 RB / 5 RB Offset		
			19185	3MHz	QPSK,16QAM	6 RB / 0 RB Offset		
		18625 to 19175	18625	5MHz	QPSK,16QAM	1 RB / 0 RB Offset		
			19175	5MHz	QPSK,16QAM	15 RB / 0 RB Offset		
		18650 to 19150	18650	10MHz	QPSK,16QAM	1 RB / 14 RB Offset		
			19150	10MHz	QPSK,16QAM	15 RB / 0 RB Offset		
		18675 to 19125	18675	15MHz	QPSK,16QAM	1 RB / 0 RB Offset		
			19125	15MHz	QPSK,16QAM	25 RB / 0 RB Offset		
		18700 to 19100	18700	20MHz	QPSK,16QAM	1 RB / 24 RB Offset		
			19100	20MHz	QPSK,16QAM	25 RB / 0 RB Offset		
		B	CONDCUDED EMISSION	18607 to 19193	18607, 18900, 19193	1.4MHz	QPSK	1 RB / 0 RB Offset
				18615 to 19185	18615, 18900, 19185	3MHz	QPSK	1 RB / 0 RB Offset
				18625 to 19175	18625, 18900, 19175	5MHz	QPSK	1 RB / 0 RB Offset
				18650 to 19150	18650, 18900, 19150	10MHz	QPSK	1 RB / 0 RB Offset
				18675 to 19125	18675, 18900, 19125	15MHz	QPSK	1 RB / 0 RB Offset
				18700 to 19100	18700, 18900, 19100	20MHz	QPSK	1 RB / 0 RB Offset
A	RADIATED EMISSION	18607 to 19193	18900	1.4MHz	QPSK	1 RB / 0 RB Offset		
		18615 to 19185	18900	3MHz	QPSK	1 RB / 0 RB Offset		
		18625 to 19175	18900	5MHz	QPSK	1 RB / 0 RB Offset		
		18650 to 19150	18607, 18900, 19193	10MHz	QPSK	1 RB / 0 RB Offset		
		18675 to 19125	18900	15MHz	QPSK	1 RB / 0 RB Offset		
		18700 to 19100	18900	20MHz	QPSK	1 RB / 0 RB Offset		

TEST CONDITION:

TEST ITEM	ENVIRONMENTAL CONDITIONS	INPUT POWER	TESTED BY
EIRP	25deg. C, 57%RH	EUT 4.0V	Jace Hu
FREQUENCY STABILITY	23deg. C, 61%RH	EUT 4.0V	James Fu
OCCUPIED BANDWIDTH	23deg. C, 61%RH	EUT 4.0V	James Fu
PEAK TO AVERAGE RATIO	23deg. C, 61%RH	EUT 4.0V	James Fu
BAND EDGE	23deg. C, 61%RH	EUT 4.0V	James Fu
CONDCUDED EMISSION	23deg. C, 61%RH	EUT 4.0V	James Fu
RADIATED EMISSION	23deg. C, 70%RH	EUT 4.0V	Jace Hu



Test Report No.: W7L-P20210616-2RF05

2.5 EUT OPERATING CONDITIONS

The EUT makes a call to the communication simulator. The communication simulator station system controlled a EUT to export maximum output power under transmission mode and specific channel frequency

2.6 GENERAL DESCRIPTION OF APPLIED STANDARDS

The EUT is a RF product. According to the specifications of the manufacturer, it must comply with the requirements of the following standards:

FCC 47 CFR Part 2

FCC 47 CFR Part 24

KDB 971168 D01 Power Meas License Digital Systems v03r01

ANSI/TIA/EIA-603-D

ANSI/TIA/EIA-603-E

ANSI C63.26-2015

NOTE: All test items have been performed and recorded as per the above standards.

3 TEST TYPES AND RESULTS

3.1 OUTPUT POWER MEASUREMENT

3.1.1 LIMITS OF OUTPUT POWER MEASUREMENT

Mobile and portable stations are limited to 2 watts EIRP.

3.1.2 TEST PROCEDURES

EIRP MEASUREMENT:

Per KDB 971168 D01 Power Meas License Digital Systems v03r01 or subclause 5.2.5.5 of ANSI C63.26-2015, the relevant equation for determining the ERP or EIRP from the conducted RF output power measured using the guidance provided above is:

$$\text{ERP or EIRP} = P_{\text{Meas}} + G_{\text{T}} - L_{\text{C}}$$

Where:

ERP or EIRP = effective radiated power or equivalent isotropically radiated power, respectively

(expressed in the same units as P_{Meas} , typically dBW or dBm);

P_{Meas} = measured transmitter output power or PSD, in dBm or dBW;

G_{T} = gain of the transmitting antenna, in dBd (ERP) or dBi (EIRP);

L_{C} = signal attenuation in the connecting cable between the transmitter and antenna, in dB.

CONDUCTED POWER MEASUREMENT:

The EUT was set up for the maximum power with WCDMA link data modulation and link up with simulator. Set the EUT to transmit under low, middle and high channel and record the power level shown on simulator.

3.1.3 TEST SETUP

EIRP / ERP Measurement:

CONDUCTED POWER MEASUREMENT:

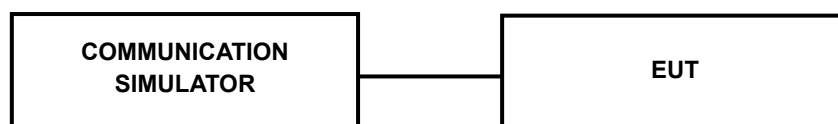

3.1.4 TEST RESULTS

CONDUCTED OUTPUT POWER (dBm)

Band	GSM1900			Max. Tune-up Power
	512	661	810	
Channel	1850.2	1880	1909.8	
Frequency				
GSM (GMSK, 1Tx-slot)	29.90	29.88	29.70	30.5
GPRS (GMSK, 1Tx-slot)	29.88	29.85	29.67	30.5
GPRS (GMSK, 2Tx-slot)	28.86	28.88	28.77	29.5
GPRS (GMSK, 3Tx-slot)	27.04	27.08	27.07	28.0
GPRS (GMSK, 4Tx-slot)	24.70	24.77	24.66	25.5
EDGE (8PSK, 1Tx-slot)	25.90	25.95	25.92	27.5
EDGE (8PSK, 2Tx-slot)	25.07	25.20	25.08	26.5
EDGE (8PSK, 3Tx-slot)	23.33	23.54	23.40	25.0
EDGE (8PSK, 4Tx-slot)	22.13	22.18	22.06	23.5

Band	WCDMA II			Max. Tune-up Power
	9262	9400	9538	
Channel	1852.4	1880	1907.6	
Frequency				
RMC 12.2K	23.04	23.01	23.01	24.5
HSDPA Subtest-1	22.15	22.11	22.07	23.5
HSDPA Subtest-2	22.08	22.06	22.09	23.5
HSDPA Subtest-3	21.63	21.59	21.54	23.0
HSDPA Subtest-4	21.54	21.54	21.53	23.0
HSUPA Subtest-1	22.15	22.10	22.15	23.5
HSUPA Subtest-2	20.21	20.19	20.16	21.5
HSUPA Subtest-3	21.27	21.20	21.21	22.5
HSUPA Subtest-4	20.17	20.20	20.13	21.5
HSUPA Subtest-5	22.18	22.11	22.12	23.5



**BUREAU
VERITAS**

Test Report No.: W7L-P20210616-2RF05

LTE BAND 2

Band/BW	Modulation	RB Size	RB Offset	Low CH 18607	Mid CH 18900	High CH 19193	MPR
				Frequency 1850.7 MHz	Frequency 1880 MHz	Frequency 1909.3 MHz	
2/ 1.4	QPSK	1	0	23.07	23.09	22.97	0
		1	2	23.06	23.05	22.99	0
		1	5	23.02	22.99	22.91	0
		3	0	23.03	23.03	23.06	0
		3	1	23.12	23.10	22.94	0
		3	3	22.90	22.89	22.89	0
		6	0	22.04	21.97	21.95	1
	16QAM	1	0	22.08	22.09	21.99	1
		1	2	22.09	22.03	22.05	1
		1	5	21.91	21.93	21.92	1
		3	0	22.10	22.04	22.04	1
		3	1	21.90	22.02	21.90	1
		3	3	21.91	21.88	21.89	1
		6	0	20.97	20.98	20.85	2

Band/BW	Modulation	RB Size	RB Offset	Low CH 18615	Mid CH 18900	High CH 19185	MPR
				Frequency 1851.5 MHz	Frequency 1880 MHz	Frequency 1908.5 MHz	
2/ 3	QPSK	1	0	23.09	23.11	22.96	0
		1	7	23.02	23.06	22.99	0
		1	14	22.98	22.99	22.91	0
		8	0	22.02	22.06	22.06	1
		8	3	22.05	22.10	21.96	1
		8	7	21.87	21.96	21.93	1
		15	0	22.01	21.98	21.89	1
	16QAM	1	0	22.05	22.15	22.02	1
		1	7	22.06	22.06	22.03	1
		1	14	21.94	21.93	21.92	1
		8	0	21.06	21.05	21.04	2
		8	3	20.95	20.97	20.93	2
		8	7	20.93	20.86	20.85	2
		15	0	20.97	20.92	20.88	2



Test Report No.: W7L-P20210616-2RF05

Band/BW	Modulation	RB Size	RB Offset	Low CH 18625	Mid CH 18900	High CH 19175	MPR
				Frequency 1852.5 MHz	Frequency 1880 MHz	Frequency 1907.5 MHz	
2/ 5	QPSK	1	0	23.10	23.06	22.97	0
		1	12	23.07	23.03	22.99	0
		1	24	22.99	22.98	22.95	0
		12	0	22.05	22.06	22.03	1
		12	6	22.05	22.11	21.97	1
		12	13	21.91	21.92	21.94	1
		25	0	21.99	22.01	21.92	1
	16QAM	1	0	22.06	22.11	22.02	1
		1	12	22.03	22.09	22.02	1
		1	24	21.94	21.93	21.91	1
		12	0	21.06	21.03	21.01	2
		12	6	20.92	21.01	20.89	2
		12	13	20.88	20.88	20.88	2
		25	0	20.97	20.93	20.85	2

Band/BW	Modulation	RB Size	RB Offset	Low CH 18650	Mid CH 18900	High CH 19150	MPR
				Frequency 1855 MHz	Frequency 1880 MHz	Frequency 1905 MHz	
2/ 10	QPSK	1	0	23.10	23.06	22.97	0
		1	24	23.07	23.03	22.99	0
		1	49	22.99	22.98	22.95	0
		25	0	22.05	22.06	22.03	1
		25	12	22.05	22.11	21.97	1
		25	25	21.91	21.92	21.94	1
		50	0	21.99	22.01	21.92	1
	16QAM	1	0	22.06	22.11	22.02	1
		1	24	22.03	22.09	22.02	1
		1	49	21.94	21.93	21.91	1
		25	0	21.06	21.03	21.01	2
		25	12	20.92	21.01	20.89	2
		25	25	20.88	20.88	20.88	2
		50	0	20.97	20.93	20.85	2



BUREAU
VERITAS

Test Report No.: W7L-P20210616-2RF05

Band/BW	Modulation	RB Size	RB Offset	Low CH 18675	Mid CH 18900	High CH 19125	MPR
				Frequency 1857.5 MHz	Frequency 1880 MHz	Frequency 1902.5 MHz	
2/ 15	QPSK	1	0	23.14	23.09	22.94	0
		1	37	23.05	23.08	22.95	0
		1	74	23.02	23.05	22.92	0
		36	0	22.03	22.06	22.07	1
		36	19	22.12	22.10	21.97	1
		36	39	21.87	21.90	21.93	1
		75	0	22.04	21.99	21.94	1
	16QAM	1	0	22.10	22.15	21.98	1
		1	37	22.07	22.06	22.05	1
		1	74	21.90	21.99	21.90	1
		36	0	21.12	21.01	21.08	2
		36	19	20.90	20.99	20.90	2
		36	39	20.92	20.87	20.88	2
		75	0	21.02	20.95	20.82	2

Band/BW	Modulation	RB Size	RB Offset	Low CH 18700	Mid CH 18900	High CH 19100	MPR
				Frequency 1860 MHz	Frequency 1880 MHz	Frequency 1900 MHz	
2/ 20	QPSK	1	0	23.15	23.13	23.02	0
		1	50	23.09	23.11	23.01	0
		1	99	23.04	23.06	22.96	0
		50	0	22.09	22.11	22.08	1
		50	25	22.13	22.12	22.02	1
		50	50	21.95	21.97	21.95	1
		100	0	22.05	22.03	21.97	1
	16QAM	1	0	22.13	22.16	22.04	1
		1	50	22.11	22.11	22.07	1
		1	99	21.96	22.01	21.93	1
		50	0	21.14	21.09	21.09	2
		50	25	20.98	21.03	20.95	2
		50	50	20.95	20.93	20.90	2
		100	0	21.03	21.00	20.90	2



EIRP POWER (dBm)

GSM

Channel	Frequency (MHz)	Conducted Power (dBm)	G _{T-Lc} (dB)	EIRP (dBm)	EIRP (mW)	Limit (W)
512	1850.2	29.9	1.52	31.42	1386.76	2
661	1880.0	29.88	1.52	31.4	1380.38	2
810	1909.8	29.7	1.52	31.22	1324.34	2

REMARKS: ERP Output Power (dBm) = EIRP (dBm) -2.15(dB).

EDGE

Channel	Frequency (MHz)	Conducted Power (dBm)	G _{T-Lc} (dB)	EIRP (dBm)	EIRP (mW)	Limit (W)
512	1850.2	25.90	1.52	27.42	552.08	2
661	1880.0	25.95	1.52	27.47	558.47	2
810	1909.8	25.92	1.52	27.44	554.63	2

REMARKS: ERP Output Power (dBm) = EIRP (dBm) -2.15(dB).

WCDMA

Channel	Frequency (MHz)	Conducted Power (dBm)	G _{T-Lc} (dB)	EIRP (dBm)	EIRP (mW)	Limit (W)
9662	1852.4	23.04	1.52	24.56	285.76	2
9800	1880	23.01	1.52	24.53	283.79	2
9938	1907.6	23.01	1.52	24.53	283.79	2



LTE BAND 2

CHANNEL BANDWIDTH: 1.4MHz QPSK

Channel	Frequency (MHz)	Conducted Power (dBm)	G _{T-Lc} (dB)	EIRP (dBm)	EIRP (mW)	Limit (W)
18607	1850.7	23.12	1.52	24.64	291.07	2
18900	1880.0	23.1	1.52	24.62	289.73	2
19193	1908.3	23.06	1.52	24.58	287.08	2

CHANNEL BANDWIDTH: 1.4MHz 16QAM

Channel	Frequency (MHz)	Conducted Power (dBm)	G _{T-Lc} (dB)	EIRP (dBm)	EIRP (mW)	Limit (W)
18607	1850.7	22.10	1.52	23.62	230.14	2
18900	1880.0	22.09	1.52	23.61	229.61	2
19193	1908.3	22.05	1.52	23.57	227.51	2

CHANNEL BANDWIDTH: 3MHz QPSK

Channel	Frequency (MHz)	Conducted Power (dBm)	G _{T-Lc} (dB)	EIRP (dBm)	EIRP (mW)	Limit (W)
18615	1851.5	23.09	1.52	24.61	289.07	2
18900	1880.0	23.11	1.52	24.63	290.40	2
19185	1908.5	22.99	1.52	24.51	282.49	2

CHANNEL BANDWIDTH: 3MHz 16QAM

Channel	Frequency (MHz)	Conducted Power (dBm)	G _{T-Lc} (dB)	EIRP (dBm)	EIRP (mW)	Limit (W)
18615	1851.5	22.06	1.52	23.58	228.03	2
18900	1880.0	22.15	1.52	23.67	232.81	2
19185	1908.5	22.03	1.52	23.55	226.46	2



CHANNEL BANDWIDTH: 5MHz QPSK

Channel	Frequency (MHz)	Conducted Power (dBm)	G _T -L _c (dB)	EIRP (dBm)	EIRP (mW)	Limit (W)
18625	1852.5	23.10	1.52	24.62	289.73	2
18900	1880.0	23.06	1.52	24.58	287.08	2
19175	1907.5	22.99	1.52	24.51	282.49	2

CHANNEL BANDWIDTH: 5MHz 16QAM

Channel	Frequency (MHz)	Conducted Power (dBm)	G _T -L _c (dB)	EIRP (dBm)	EIRP (mW)	Limit (W)
18625	1852.5	22.06	1.52	23.58	228.03	2
18900	1880.0	22.11	1.52	23.63	230.67	2
19175	1907.5	22.02	1.52	23.54	225.94	2

CHANNEL BANDWIDTH: 10MHz QPSK

Channel	Frequency (MHz)	Conducted Power (dBm)	G _T -L _c (dB)	EIRP (dBm)	EIRP (mW)	Limit (W)
18650	1855.0	23.07	1.52	24.59	287.74	2
18900	1880.0	23.09	1.52	24.61	289.07	2
19150	1905.0	23.00	1.52	24.52	283.14	2

CHANNEL BANDWIDTH: 10MHz 16QAM

Channel	Frequency (MHz)	Conducted Power (dBm)	G _T -L _c (dB)	EIRP (dBm)	EIRP (mW)	Limit (W)
18650	1855.0	22.08	1.52	23.60	229.09	2
18900	1880.0	22.08	1.52	23.60	229.09	2
19150	1905.0	22.05	1.52	23.57	227.51	2



CHANNEL BANDWIDTH: 15MHz QPSK

Channel	Frequency (MHz)	Conducted Power (dBm)	G _{T-Lc} (dB)	EIRP (dBm)	EIRP (mW)	Limit (W)
18675	1857.5	23.14	1.52	24.66	292.42	2
18900	1880.0	23.09	1.52	24.61	289.07	2
19125	1902.5	22.95	1.52	24.47	279.90	2

CHANNEL BANDWIDTH: 15MHz 16QAM

Channel	Frequency (MHz)	Conducted Power (dBm)	G _{T-Lc} (dB)	EIRP (dBm)	EIRP (mW)	Limit (W)
18675	1857.5	22.10	1.52	23.62	230.14	2
18900	1880.0	22.15	1.52	23.67	232.81	2
19125	1902.5	22.05	1.52	23.57	227.51	2

CHANNEL BANDWIDTH: 20MHz QPSK

Channel	Frequency (MHz)	Conducted Power (dBm)	G _{T-Lc} (dB)	EIRP (dBm)	EIRP (mW)	Limit (W)
18700	1860	22.10	1.52	23.62	230.14	2
18900	1880	22.15	1.52	23.67	232.81	2
19100	1900	22.05	1.52	23.57	227.51	2

CHANNEL BANDWIDTH: 20MHz 16QAM

Channel	Frequency (MHz)	Conducted Power (dBm)	G _{T-Lc} (dB)	EIRP (dBm)	EIRP (mW)	Limit (W)
18700	1860	22.13	1.52	23.65	231.74	2
18900	1880	22.16	1.52	23.68	233.35	2
19100	1900	22.07	1.52	23.59	228.56	2

REMARKS: ERP Output Power (dBm) = EIRP (dBm) -2.15(dB).



3.2 FREQUENCY STABILITY MEASUREMENT

3.2.1 LIMITS OF FREQUENCY STABILITY MEASUREMENT

The frequency stability shall be sufficient to ensure that the fundamental emission stays within the authorized frequency block.

3.2.2 TEST PROCEDURE

- a. Device is placed at the oven room. The oven room could control the temperatures and humidity. Power warm up is at least 15 min and power applied should perform before recording frequency error.
- b. EUT is connected the external power supply to control the DC input power. The test voltage range is from minimum to maximum working voltage. Each step shall be record the frequency error rate.
- c. The temperature range step is 10 degrees in this test items. All temperature levels shall be hold the $\pm 0.5^{\circ}\text{C}$ during the measurement testing. The each temperature step shall be at least 0.5 hours, consider the EUT could be test under the stability condition.

NOTE: The frequency error was recorded frequency error from the communication simulator.

3.2.3 TEST SETUP

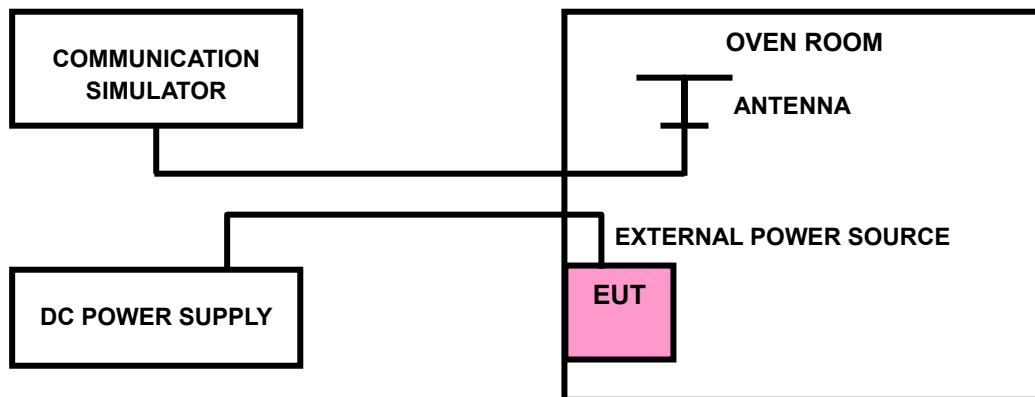



3.2.4 TEST RESULTS

GSM 1900

FREQUENCY ERROR VS. VOLTAGE

VOLTAGE (Volts)	FREQUENCY ERROR (ppm)		LIMIT (ppm)
	Low Channel	High Channel	
V _{nor}	0.0009	0.0009	2.5
V _{min}	-0.0009	-0.0011	2.5
V _{max}	0.0008	0.0008	2.5

NOTE: The applicant defined the normal working voltage of the battery is from V_{min} to V_{max}.

FREQUENCY ERROR vs. TEMPERATURE.

TEMP. (°C)	FREQUENCY ERROR (ppm)		LIMIT (ppm)
	Low Channel	High Channel	
-30	-0.0053	-0.0051	2.5
-20	-0.0048	-0.0046	2.5
-10	-0.0037	-0.0035	2.5
0	-0.0035	-0.0033	2.5
10	-0.0024	-0.0022	2.5
20	-0.0018	-0.0016	2.5
30	-0.0017	-0.0015	2.5
40	-0.0008	-0.0006	2.5
50	-0.0001	0.0001	2.5
60	-0.0001	0.0001	2.5



EDGE 1900

FREQUENCY ERROR VS. VOLTAGE

VOLTAGE (Volts)	FREQUENCY ERROR (ppm)		LIMIT (ppm)
	Low Channel	High Channel	
V _{nor}	0.0009	0.0011	2.5
V _{min}	-0.0014	-0.0013	2.5
V _{max}	0.0009	0.0009	2.5

NOTE: The applicant defined the normal working voltage of the battery is from V_{min} to V_{max}.

FREQUENCY ERROR vs. TEMPERATURE.

TEMP. (°C)	FREQUENCY ERROR (ppm)		LIMIT (ppm)
	Low Channel	High Channel	
-30	-0.0053	-0.0049	2.5
-20	-0.0048	-0.0045	2.5
-10	-0.0038	-0.0035	2.5
0	-0.0033	-0.0031	2.5
10	-0.0021	-0.0019	2.5
20	-0.0017	-0.0016	2.5
30	-0.0015	-0.0014	2.5
40	-0.0009	-0.0008	2.5
50	-0.0002	-0.0001	2.5
60	-0.0001	-0.0001	2.5



WCDMA BAND II

FREQUENCY ERROR VS. VOLTAGE

VOLTAGE (Volts)	FREQUENCY ERROR (ppm)		LIMIT (ppm)
	Low Channel	High Channel	
V _{nor}	0.0005	0.0008	2.5
V _{min}	0.0016	0.0025	2.5
V _{max}	0.0037	0.0046	2.5

NOTE: The applicant defined the normal working voltage of the battery is from V_{min} to V_{max}.

FREQUENCY ERROR vs. TEMPERATURE.

TEMP. (°C)	FREQUENCY ERROR (ppm)		LIMIT (ppm)
	Low Channel	High Channel	
-30	-0.0037	-0.0032	2.5
-20	-0.0021	-0.0019	2.5
-10	-0.0026	-0.0020	2.5
0	-0.0016	-0.0014	2.5
10	-0.0005	-0.0003	2.5
20	0.0011	0.0018	2.5
30	0.0021	0.0022	2.5
40	0.0032	0.0052	2.5
50	0.0047	0.0069	2.5
60	0.0058	0.0063	2.5



LTE BAND 2

FREQUENCY ERROR VS. VOLTAGE

VOLTAGE (Volts)	1.4MHz		LIMIT (ppm)
	FREQUENCY ERROR (ppm)		
	Low Channel	High Channel	
V _{nor}	0.0021	0.0024	2.5
V _{min}	-0.0031	-0.003	2.5
V _{max}	0.0021	0.0021	2.5

NOTE: The applicant defined the normal working voltage of the battery is from V_{min} to V_{max}.

FREQUENCY ERROR vs. TEMPERATURE.

TEMP. (°C)	1.4MHz		LIMIT (ppm)
	FREQUENCY ERROR (ppm)		
	Low Channel	High Channel	
-30	-0.0114	-0.0113	2.5
-20	-0.0113	-0.0104	2.5
-10	-0.0086	-0.0079	2.5
0	-0.0077	-0.0072	2.5
10	-0.0053	-0.0049	2.5
20	-0.0044	-0.004	2.5
30	-0.0042	-0.0031	2.5
40	-0.0017	-0.0019	2.5
50	-0.0004	-0.0003	2.5

FREQUENCY ERROR VS. VOLTAGE

VOLTAGE (Volts)	3MHz		LIMIT (ppm)
	FREQUENCY ERROR (ppm)		
	Low Channel	High Channel	
V _{nor}	0.0021	0.0021	2.5
V _{min}	-0.0021	-0.0025	2.5
V _{max}	0.0019	0.0017	2.5

NOTE: The applicant defined the normal working voltage of the battery is from V_{min} to V_{max}.

FREQUENCY ERROR vs. TEMPERATURE.

TEMP. (°C)	3MHz		LIMIT (ppm)
	FREQUENCY ERROR (ppm)		
	Low Channel	High Channel	
-30	-0.0114	-0.0116	2.5
-20	-0.0108	-0.0108	2.5
-10	-0.0085	-0.0079	2.5
0	-0.0074	-0.0073	2.5
10	-0.0049	-0.0048	2.5
20	-0.0041	-0.0041	2.5
30	-0.0041	-0.0039	2.5
40	-0.0022	-0.0019	2.5
50	-0.0002	-0.0004	2.5

FREQUENCY ERROR VS. VOLTAGE

VOLTAGE (Volts)	5MHz		LIMIT (ppm)
	FREQUENCY ERROR (ppm)		
	Low Channel	High Channel	
V _{nor}	0.0021	0.0024	2.5
V _{min}	-0.0023	-0.003	2.5
V _{max}	0.0022	0.0021	2.5

NOTE: The applicant defined the normal working voltage of the battery is from V_{min} to V_{max}.

FREQUENCY ERROR vs. TEMPERATURE.

TEMP. (°C)	5MHz		LIMIT (ppm)
	FREQUENCY ERROR (ppm)		
	Low Channel	High Channel	
-30	-0.0113	-0.0112	2.5
-20	-0.0108	-0.0105	2.5
-10	-0.0085	-0.0082	2.5
0	-0.0075	-0.0073	2.5
10	-0.0051	-0.0051	2.5
20	-0.0043	-0.0041	2.5
30	-0.0041	-0.0034	2.5
40	-0.0022	-0.0016	2.5
50	-0.0003	-0.0002	2.5



FREQUENCY ERROR VS. VOLTAGE

VOLTAGE (Volts)	10MHz		LIMIT (ppm)
	FREQUENCY ERROR (ppm)		
	Low Channel	High Channel	
V _{nor}	0.0026	0.0024	2.5
V _{min}	-0.0031	-0.0031	2.5
V _{max}	0.0026	0.0023	2.5

NOTE: The applicant defined the normal working voltage of the battery is from V_{min} to V_{max}.

FREQUENCY ERROR vs. TEMPERATURE.

TEMP. (°C)	10MHz		LIMIT (ppm)
	FREQUENCY ERROR (ppm)		
	Low Channel	High Channel	
-30	-0.0117	-0.012	2.5
-20	-0.0098	-0.0098	2.5
-10	-0.0082	-0.0083	2.5
0	-0.0073	-0.0075	2.5
10	-0.0049	-0.0054	2.5
20	-0.0042	-0.0037	2.5
30	-0.0032	-0.0032	2.5
40	-0.002	-0.0019	2.5
50	-0.0002	-0.0004	2.5

FREQUENCY ERROR VS. VOLTAGE

VOLTAGE (Volts)	15MHz		LIMIT (ppm)
	FREQUENCY ERROR (ppm)		
	Low Channel	High Channel	
V _{nor}	0.0024	0.0024	2.5
V _{min}	-0.0031	-0.003	2.5
V _{max}	0.0025	0.0024	2.5

NOTE: The applicant defined the normal working voltage of the battery is from V_{min} to V_{max}.

FREQUENCY ERROR vs. TEMPERATURE.

TEMP. (°C)	15MHz		LIMIT (ppm)
	FREQUENCY ERROR (ppm)		
	Low Channel	High Channel	
-30	-0.0121	-0.0117	2.5
-20	-0.0112	-0.0104	2.5
-10	-0.0084	-0.0079	2.5
0	-0.0076	-0.0075	2.5
10	-0.0052	-0.0047	2.5
20	-0.0043	-0.0041	2.5
30	-0.0032	-0.0033	2.5
40	-0.0019	-0.0016	2.5
50	-0.0003	-0.0005	2.5

FREQUENCY ERROR VS. VOLTAGE

VOLTAGE (Volts)	20MHz		LIMIT (ppm)
	FREQUENCY ERROR (ppm)		
	Low Channel	High Channel	
V _{nor}	0.0025	0.0025	2.5
V _{min}	-0.0031	-0.003	2.5
V _{max}	0.0024	0.0025	2.5

NOTE: The applicant defined the normal working voltage of the battery is from V_{min} to V_{max}.

FREQUENCY ERROR vs. TEMPERATURE.

TEMP. (°C)	20MHz		LIMIT (ppm)
	FREQUENCY ERROR (ppm)		
	Low Channel	High Channel	
-30	-0.012	-0.0114	2.5
-20	-0.0109	-0.0109	2.5
-10	-0.0084	-0.008	2.5
0	-0.0075	-0.0076	2.5
10	-0.0049	-0.0047	2.5
20	-0.0039	-0.0044	2.5
30	-0.0029	-0.0029	2.5
40	-0.0022	-0.0021	2.5
50	-0.0005	-0.0005	2.5



3.3 OCCUPIED BANDWIDTH MEASUREMENT

3.3.1 TEST PROCEDURES

The EUT makes a call to the communication simulator. All measurements were done at low, middle and high operational frequency range. The communication simulator station system controlled a EUT to export maximum output power under transmission mode and specific channel frequency. Use OBW measurement function of Spectrum analyzer to measure 99 % occupied bandwidth.

3.3.2 TEST SETUP

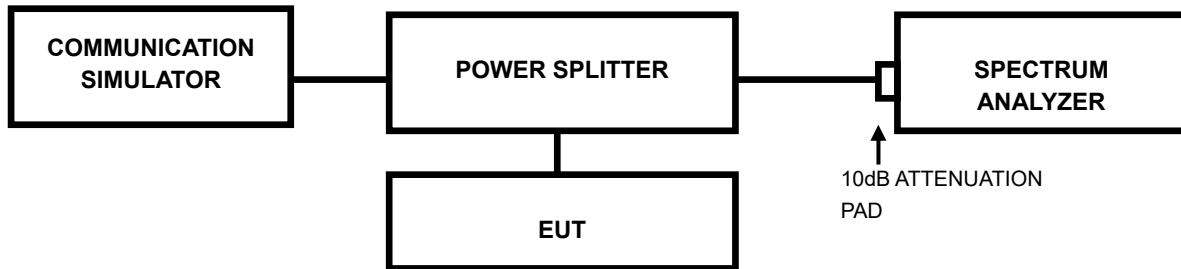



**BUREAU
VERITAS**

Test Report No.: W7L-P20210616-2RF05

3.3.3 TEST RESULTS

Channel	Frequency (MHz)	99% Occupied bandwidth (kHz)		Channel	Frequency (MHz)	99% Occupied bandwidth (kHz)
		GSM	EDGE			WCAMA
512	1850.2	240.00	240.00	9262	1852.4	4.120
661	1880.0	240.00	240.00	9400	1880.0	4.140
810	1909.8	240.00	240.00	9538	1907.6	4.150

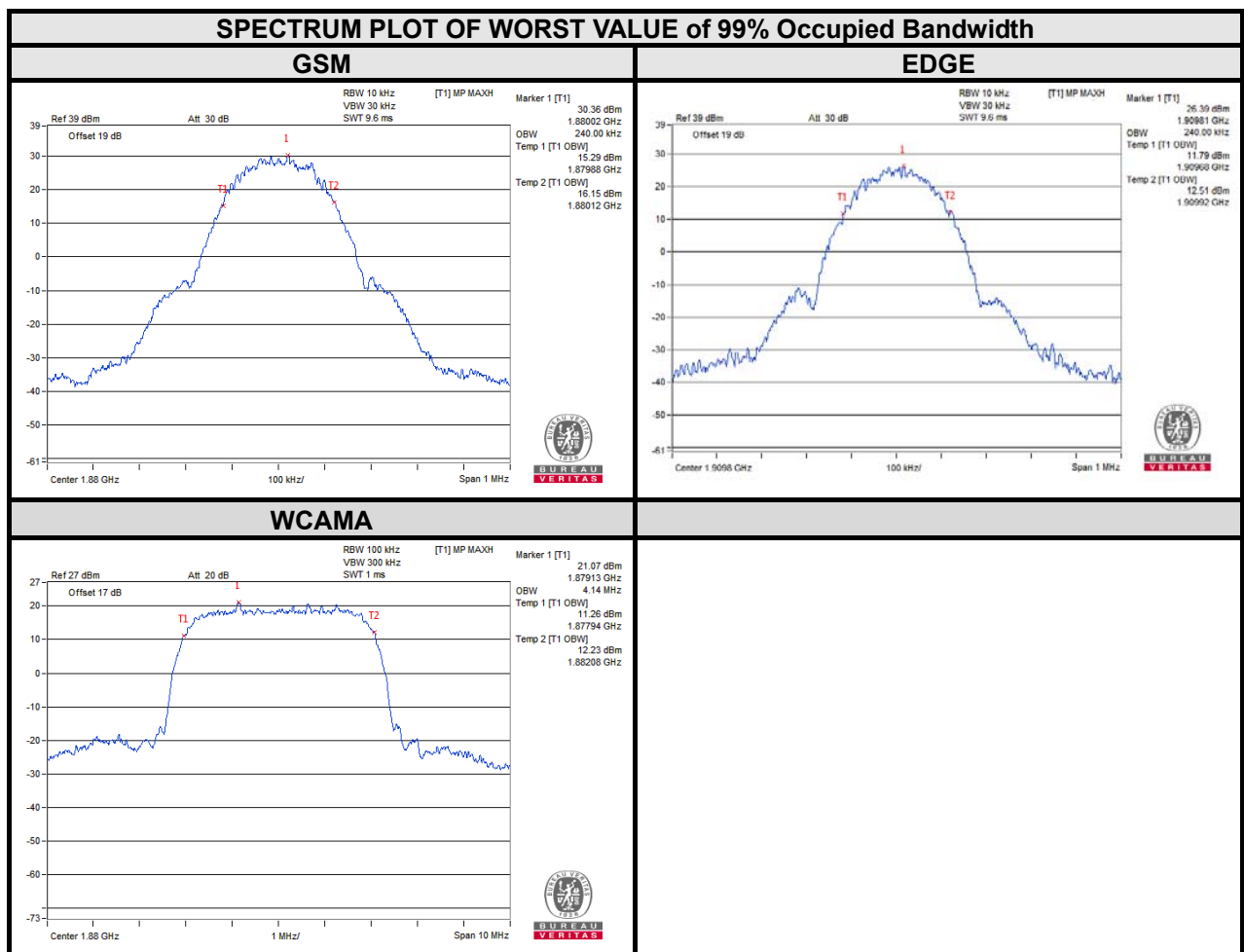



**BUREAU
VERITAS**

Test Report No.: W7L-P20210616-2RF05

Channel	Frequency (MHz)	26dB bandwidth (MHz)		Channel	Frequency (MHz)	26dB bandwidth (MHz)
		GSM	EDGE			
512	1850.2	311.40	314.30	9262	1852.4	4.713
661	1880.0	318.60	306.00	9400	1880.0	4.735
810	1909.8	313.00	311.70	9538	1907.6	4.707

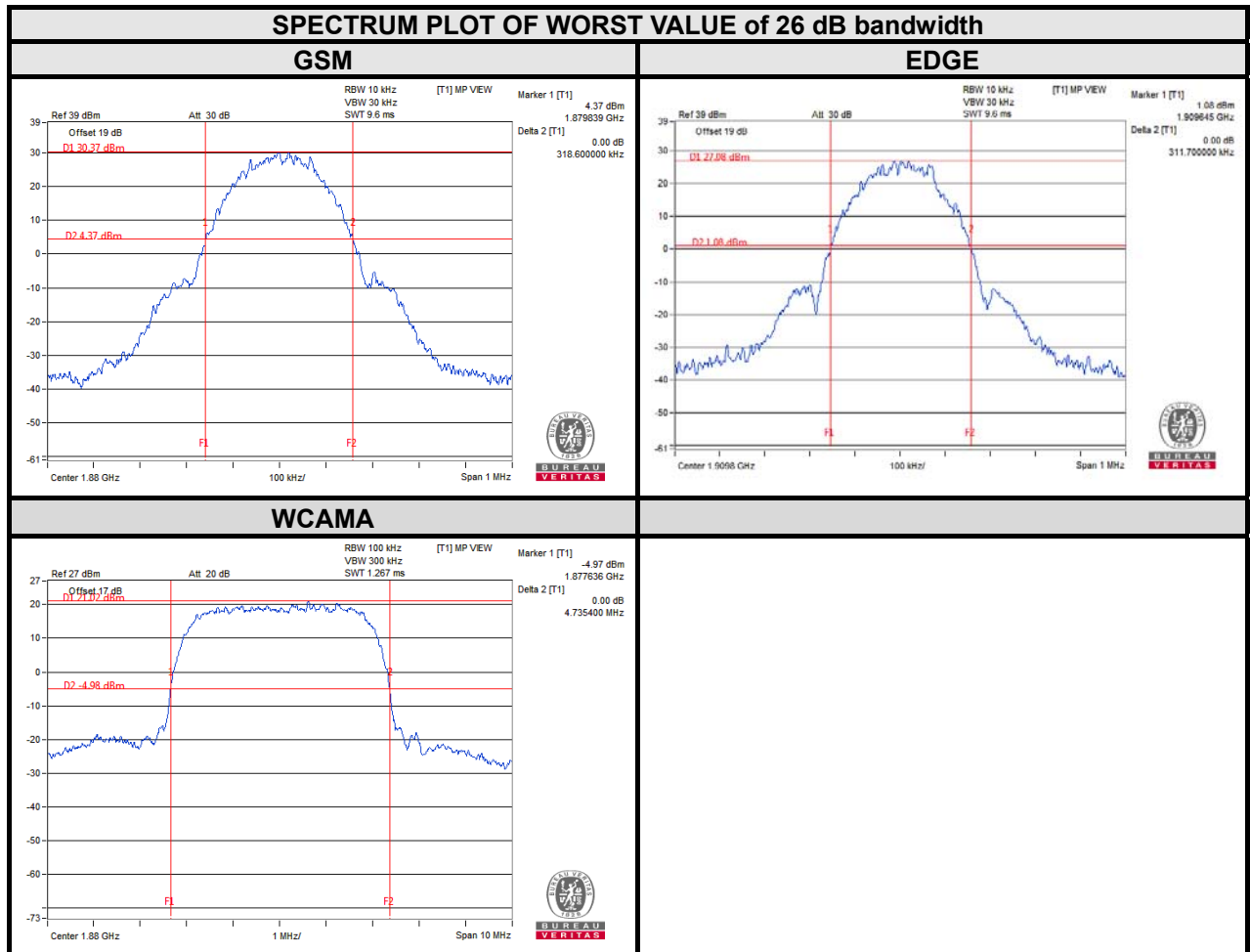



LTE BAND 2

LTE band 2					
CHANNEL BANDWIDTH: 1.4MHz					
CHANNEL	Frequency (MHz)	99% OCCUPIED Bandwidth (MHz)		26 dB bandwidth (MHz)	
		QPSK	16QAM	QPSK	16QAM
18607	1850.7	1.09	1.09	1.28	1.27
18900	1880	1.09	1.09	1.25	1.30
19193	1909.3	1.09	1.09	1.27	1.27

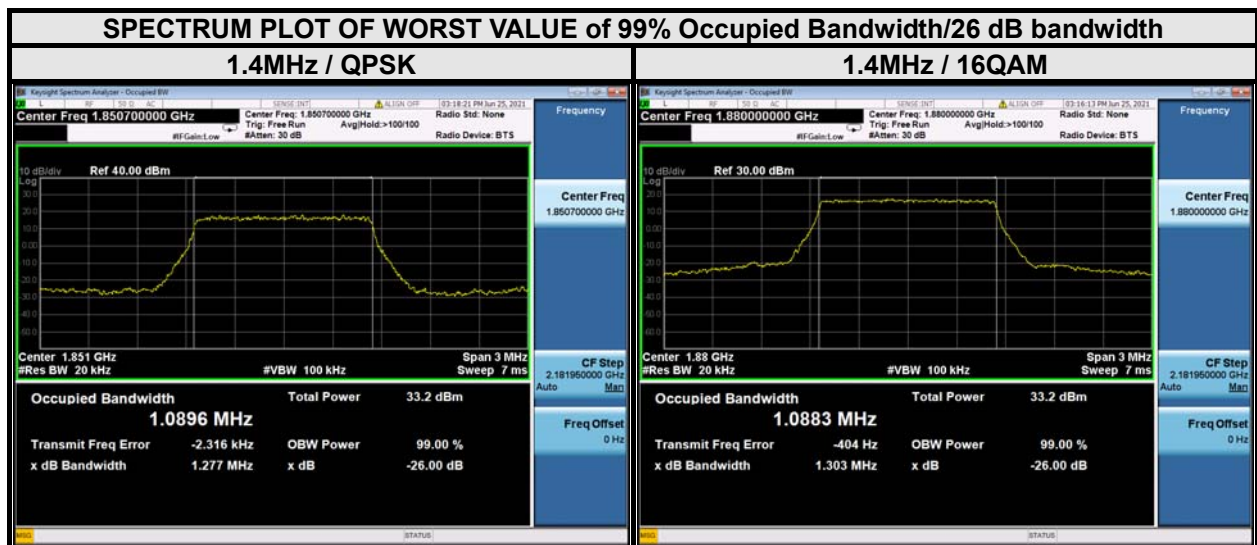



**BUREAU
VERITAS**

Test Report No.: W7L-P20210616-2RF05

CHANNEL BANDWIDTH: 3MHz					
CHANNEL	Frequency (MHz)	99% OCCUPIED Bandwidth (MHz)		26 dB bandwidth (MHz)	
		QPSK	16QAM	QPSK	16QAM
18615	1851.5	2.69	2.69	2.95	2.93
18900	1880	2.69	2.69	2.96	2.94
19185	1908.5	2.68	2.69	2.92	2.95

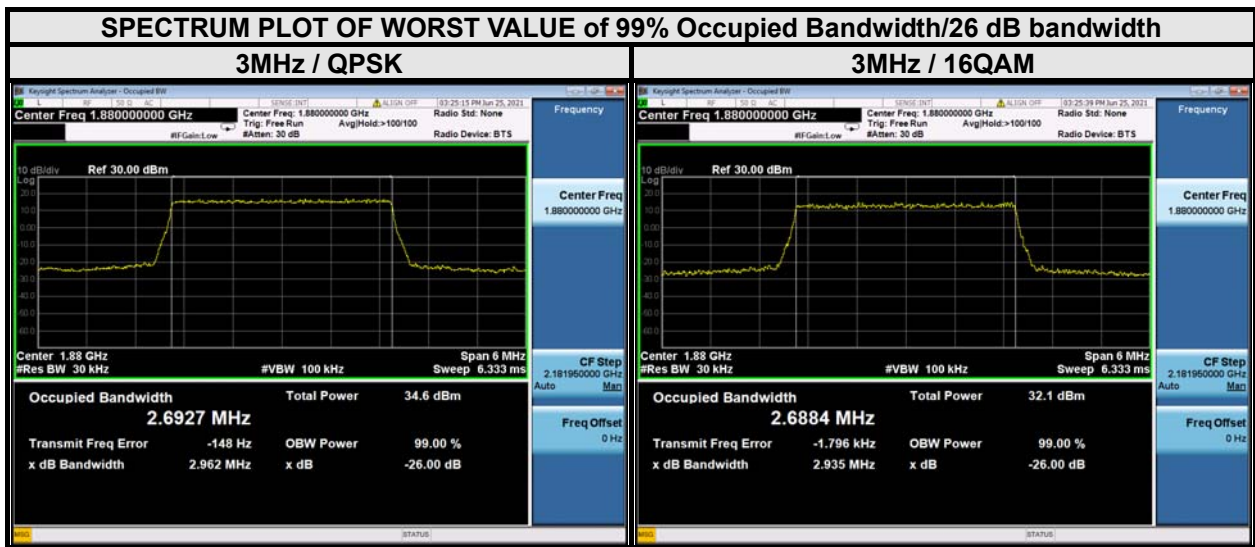



**BUREAU
VERITAS**

Test Report No.: W7L-P20210616-2RF05

CHANNEL BANDWIDTH: 5MHz					
CHANNEL	Frequency (MHz)	99% OCCUPIED Bandwidth (MHz)		26 dB bandwidth (MHz)	
		QPSK	16QAM	QPSK	16QAM
18625	1852.5	4.47	4.48	4.91	4.93
18900	1880	4.49	4.49	4.94	4.93
19175	1907.5	4.47	4.48	4.84	4.92

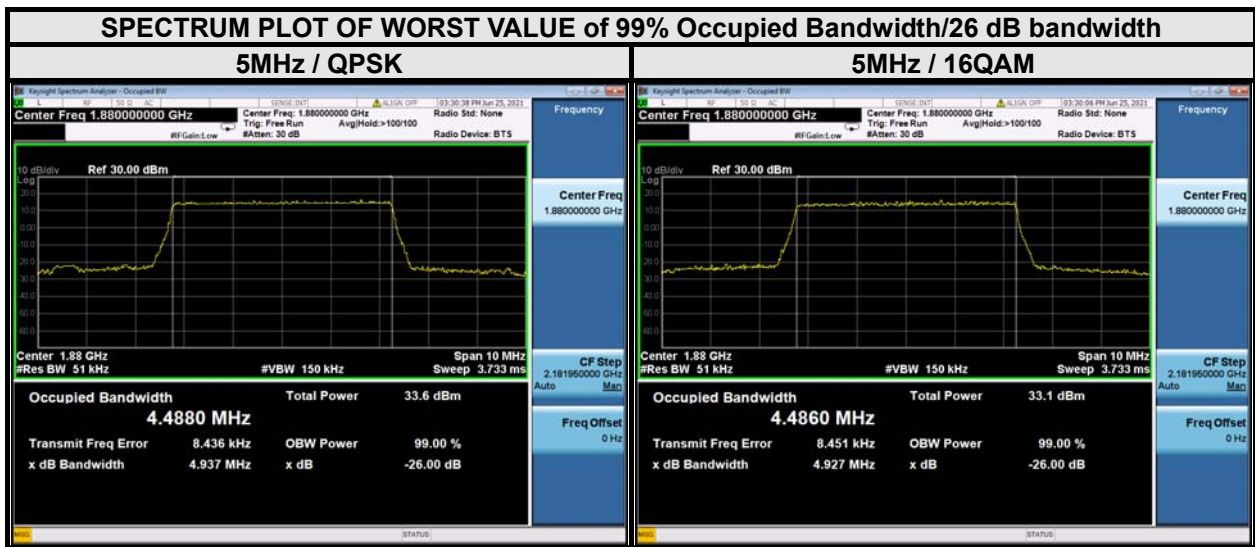



**BUREAU
VERITAS**

Test Report No.: W7L-P20210616-2RF05

CHANNEL BANDWIDTH: 10MHz					
CHANNEL	Frequency (MHz)	99% OCCUPIED Bandwidth (MHz)		26 dB bandwidth (MHz)	
		QPSK	16QAM	QPSK	16QAM
18650	1855	8.92	8.93	9.75	9.68
18900	1880	8.95	8.93	9.69	9.69
19150	1905	8.94	8.95	9.73	9.67

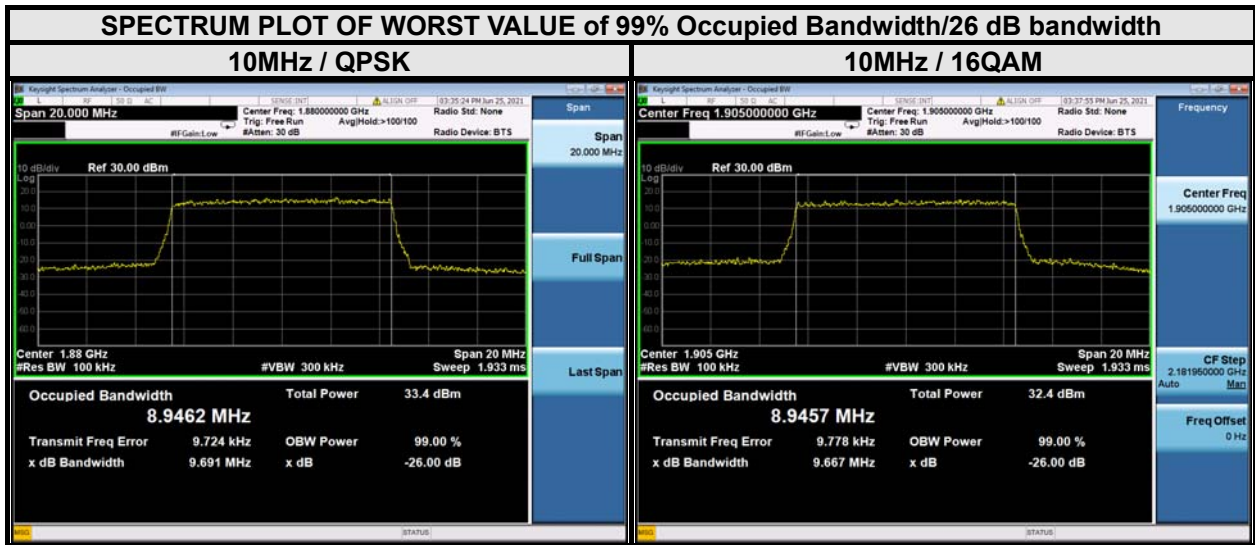



**BUREAU
VERITAS**

Test Report No.: W7L-P20210616-2RF05

CHANNEL BANDWIDTH: 15MHz					
CHANNEL	Frequency (MHz)	99% OCCUPIED Bandwidth (MHz)		26 dB bandwidth (MHz)	
		QPSK	16QAM	QPSK	16QAM
18675	1857.5	13.36	13.39	14.37	14.41
18900	1880	13.39	13.43	14.41	14.41
19125	1902.5	13.42	13.45	14.53	14.48

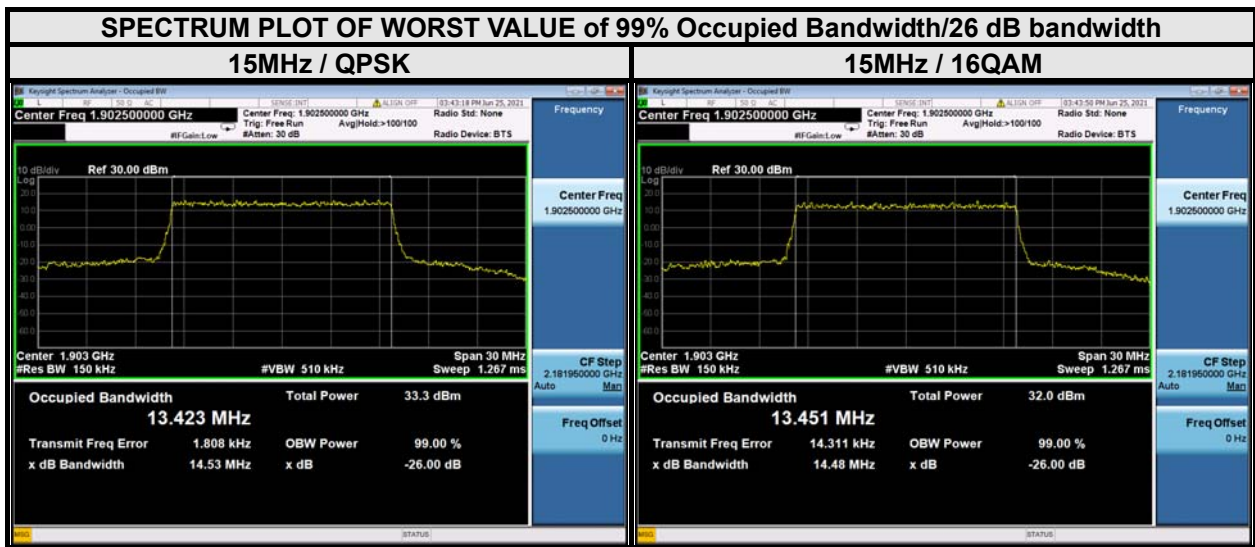



**BUREAU
VERITAS**

Test Report No.: W7L-P20210616-2RF05

CHANNEL BANDWIDTH: 20MHz					
CHANNEL	Frequency (MHz)	99% OCCUPIED Bandwidth (MHz)		26 dB bandwidth (MHz)	
		QPSK	16QAM	QPSK	16QAM
18700	1860	17.80	17.77	18.92	19.07
18900	1880	17.83	17.81	19.06	18.99
19100	1900	17.92	17.90	19.11	19.34

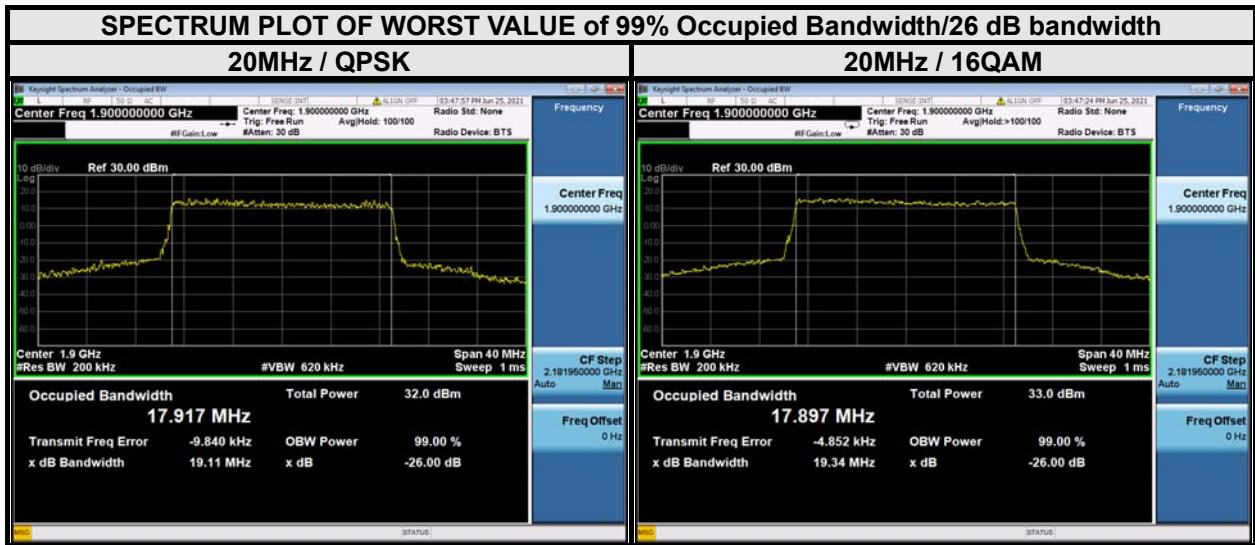



3.4 BAND EDGE MEASUREMENTC

3.4.1 LIMITS OF BAND EDGE MEASUREMENT

Power of any emission outside of the authorized operating frequency ranges must be attenuated below the transmitting power (P) by a factor of at least $43 + 10 \log(P)$ dB. In the 1 MHz bands immediately outside and adjacent to the frequency block a resolution bandwidth of at least one percent of the emission bandwidth of the fundamental emission of the transmitter may be employed.

3.4.2 TEST SETUP

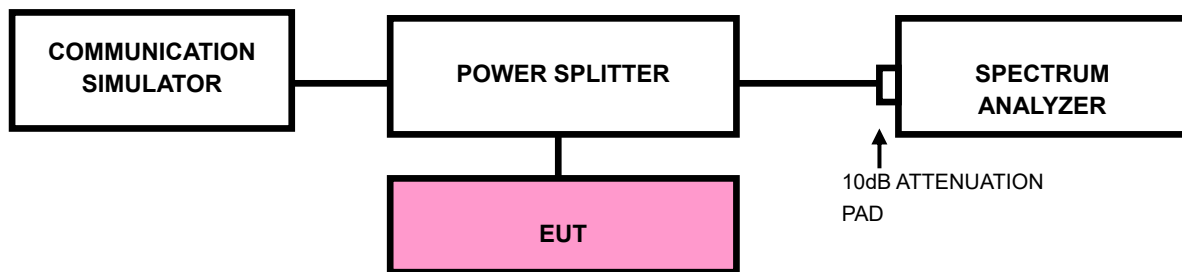

3.4.3 TEST PROCEDURES

- a. All measurements were done at low and high operational frequency range.
- b. The center frequency of spectrum is the band edge frequency and span is 1.5 MHz. RBW of the spectrum is 10kHz and VBW of the spectrum is 30kHz (GSM/GPRS/EDGE).
- c. The center frequency of spectrum is the band edge frequency and span is 10MHz. RBW of the spectrum is 100kHz and VBW of the spectrum is 300kHz (WCDMA).
- d. The center frequency of spectrum is the band edge frequency and span is 1~5 MHz. RBW of the spectrum is 20kHz and VBW of the spectrum is 100 kHz. (LTE bandwidth 1.4MHz)
- e. The center frequency of spectrum is the band edge frequency and span is 1~5 MHz. RBW of the spectrum is 30kHz and VBW of the spectrum is 100kHz. (LTE bandwidth 3MHz)
- f. The center frequency of spectrum is the band edge frequency and span is 1~5 MHz. RBW of the spectrum is 50kHz and VBW of the spectrum is 200kHz. (LTE bandwidth 5MHz)
- g. The center frequency of spectrum is the band edge frequency and span is 1~5 MHz. RBW of the spectrum is 100kHz and VBW of the spectrum is 300kHz. (LTE bandwidth 10MHz)
- h. The center frequency of spectrum is the band edge frequency and span is 1~5 MHz. RBW of the spectrum is 200kHz and VBW of the spectrum is 1MHz. (LTE bandwidth 15MHz)
- i. The center frequency of spectrum is the band edge frequency and span is 1~5 MHz. RBW of the spectrum is 200kHz and VBW of the spectrum is 1MHz. (LTE bandwidth 20MHz)
- j. Record the max trace plot into the test report.



BUREAU VERITAS

Test Report No.: W7L-P20210616-2RF05

3.4.4. TEST RESULTS

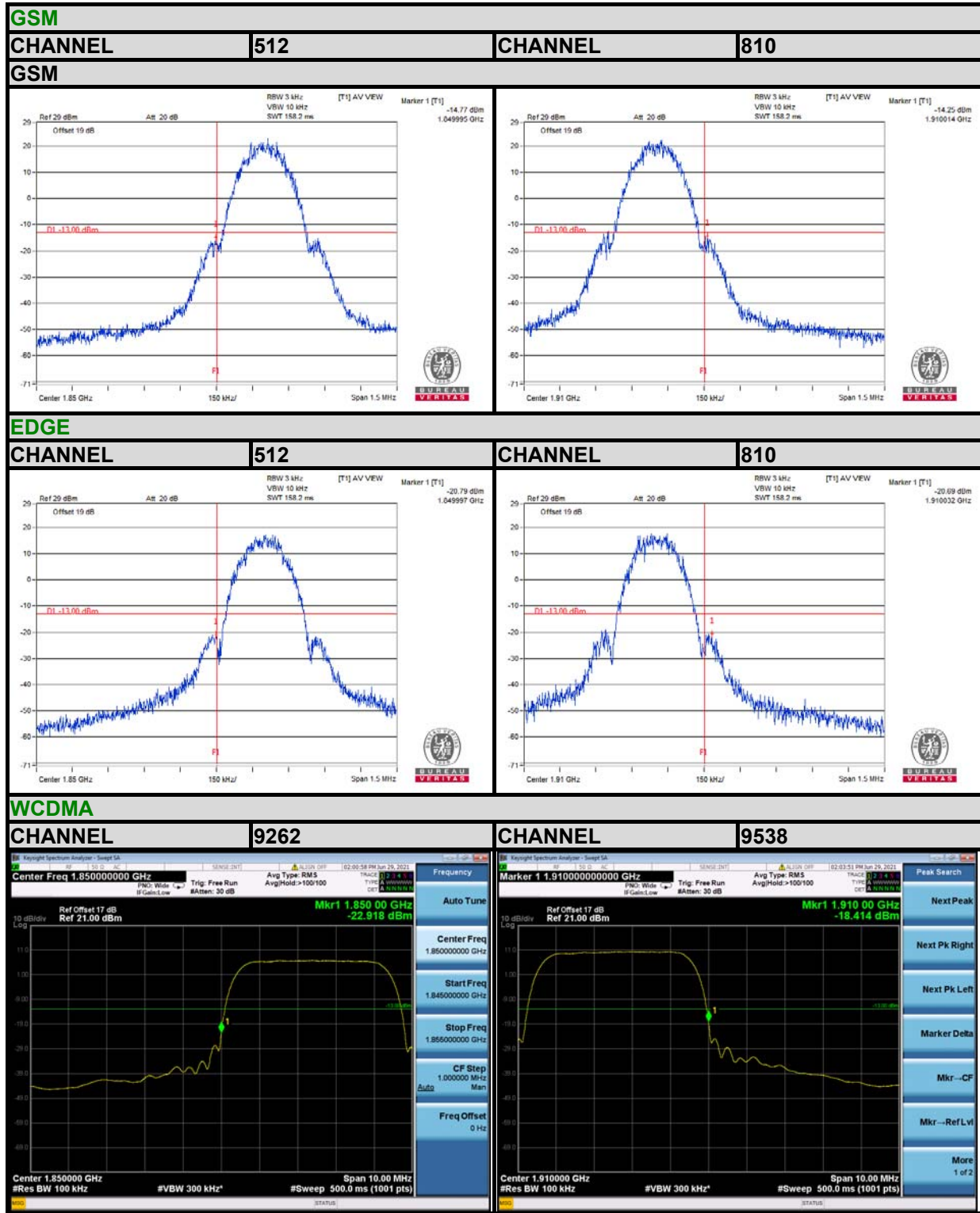



BUREAU VERITAS

Test Report No.: W7L-P20210616-2RF05

LTE BAND 2





**BUREAU
VERITAS**

Test Report No.: W7L-P20210616-2RF05

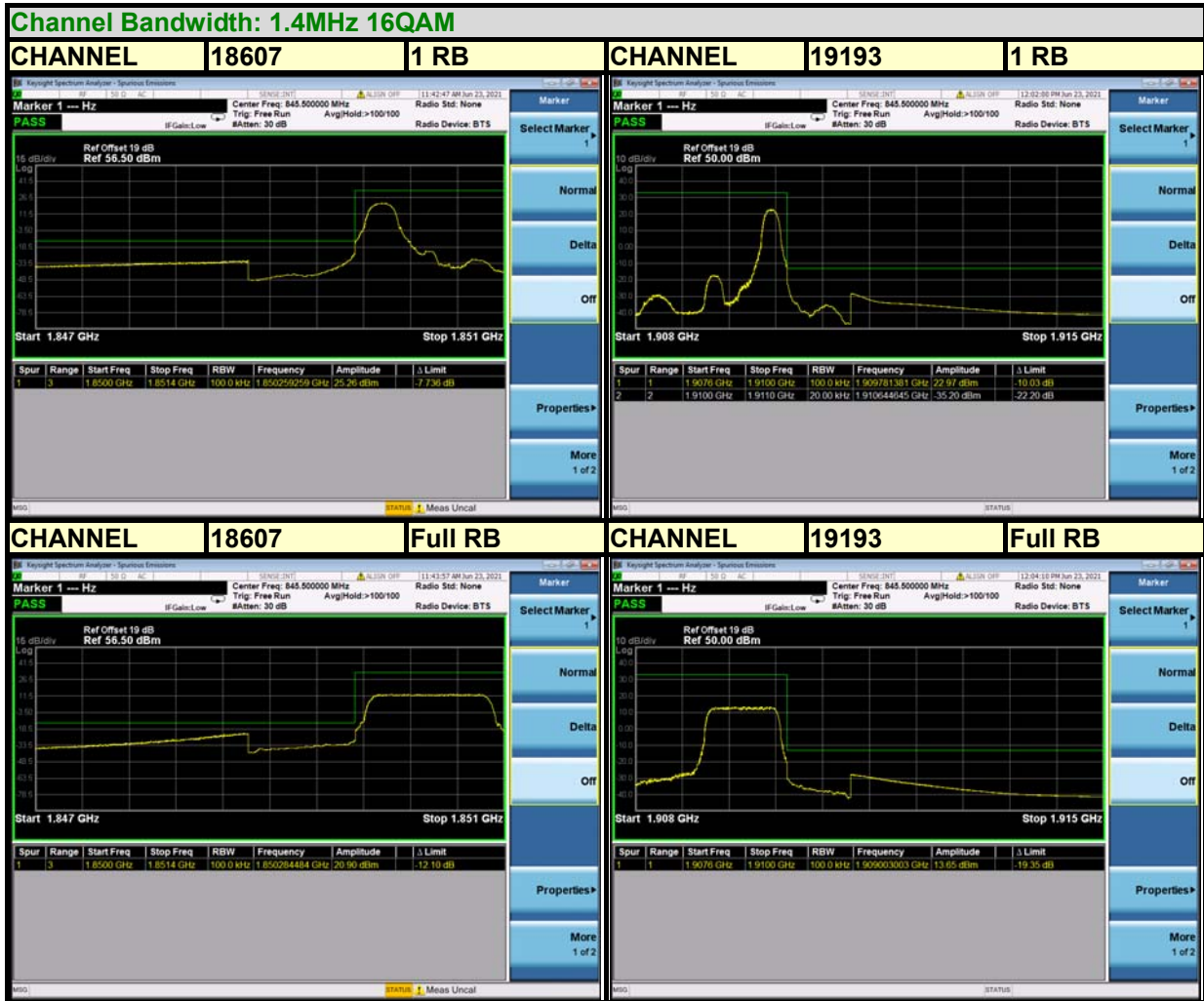



BUREAU VERITAS

Test Report No.: W7L-P20210616-2RF05

LTE BAND 2





**BUREAU
VERITAS**

Test Report No.: W7L-P20210616-2RF05

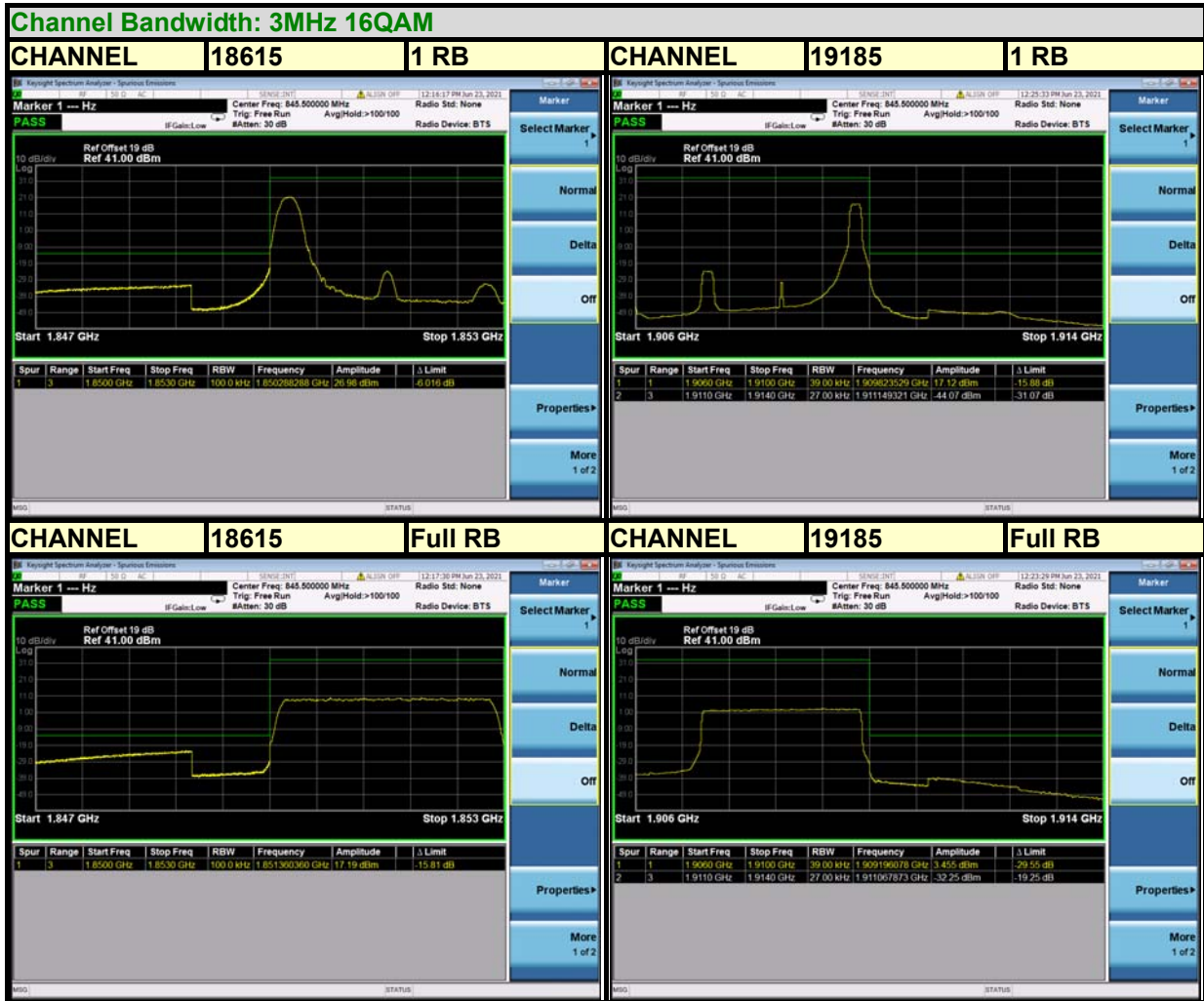



BUREAU VERITAS

Test Report No.: W7L-P20210616-2RF05

LTE BAND 2





BUREAU VERITAS

Test Report No.: W7L-P20210616-2RF05

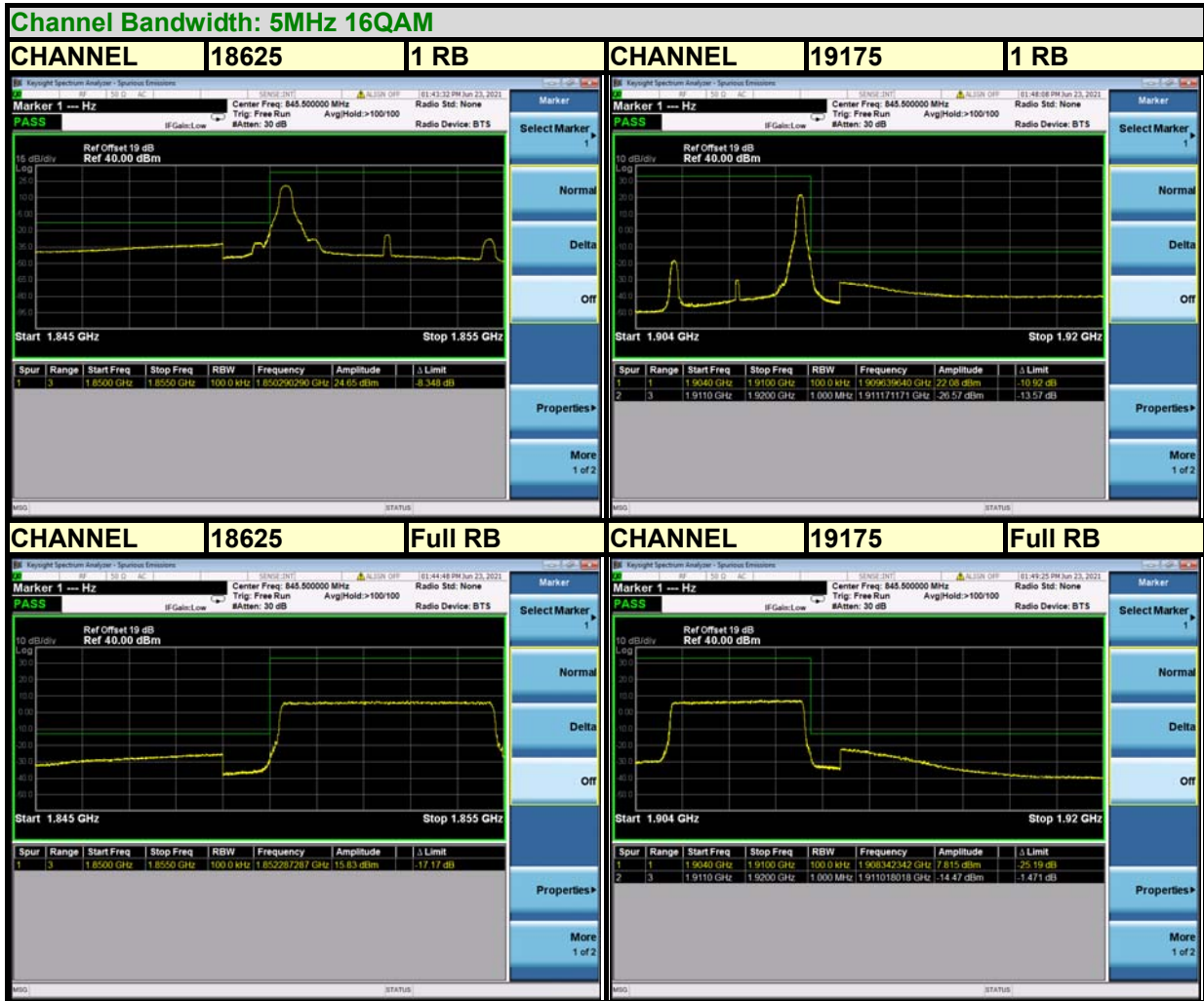



BUREAU VERITAS

Test Report No.: W7L-P20210616-2RF05

LTE BAND 2

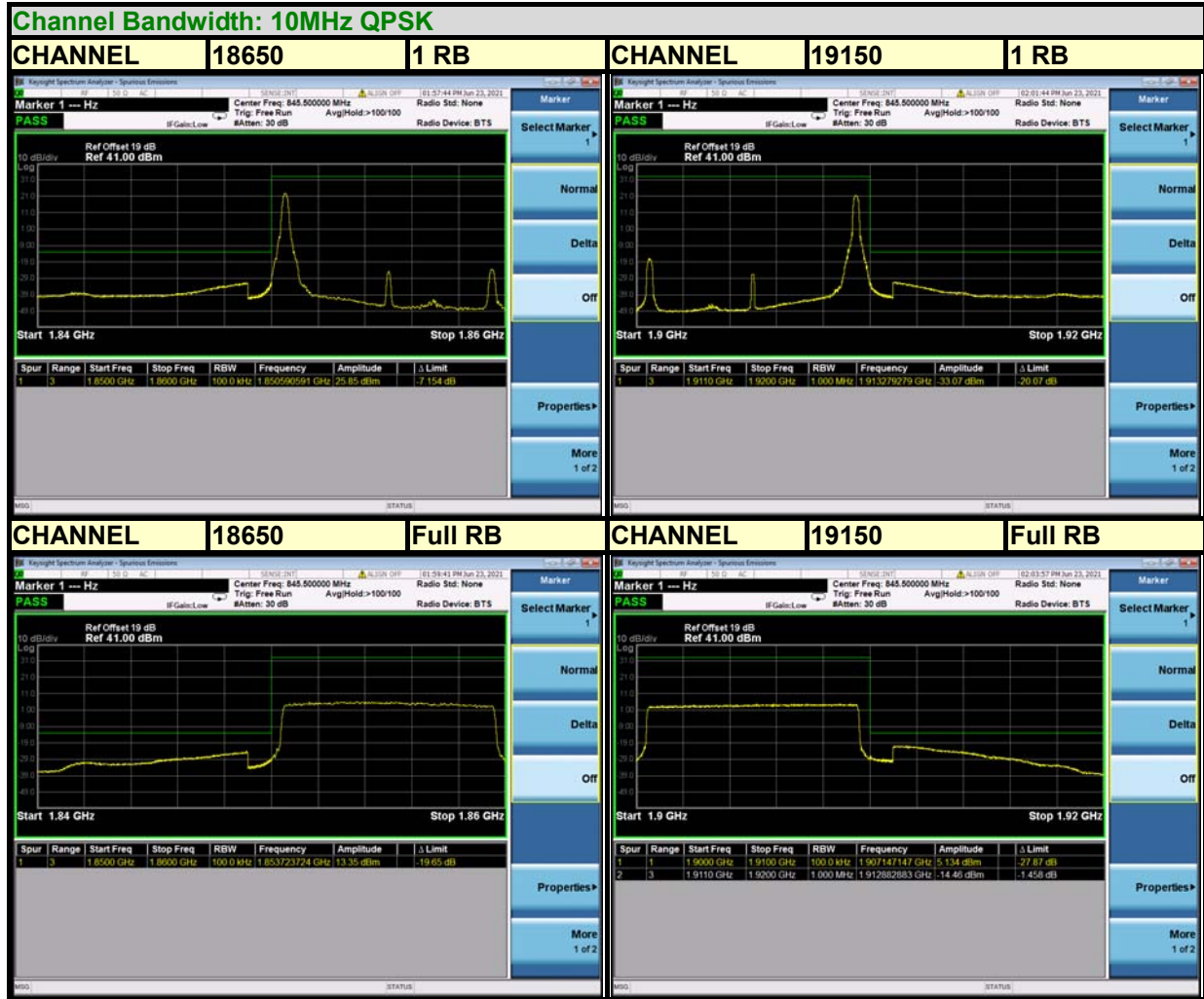



BUREAU VERITAS

Test Report No.: W7L-P20210616-2RF05

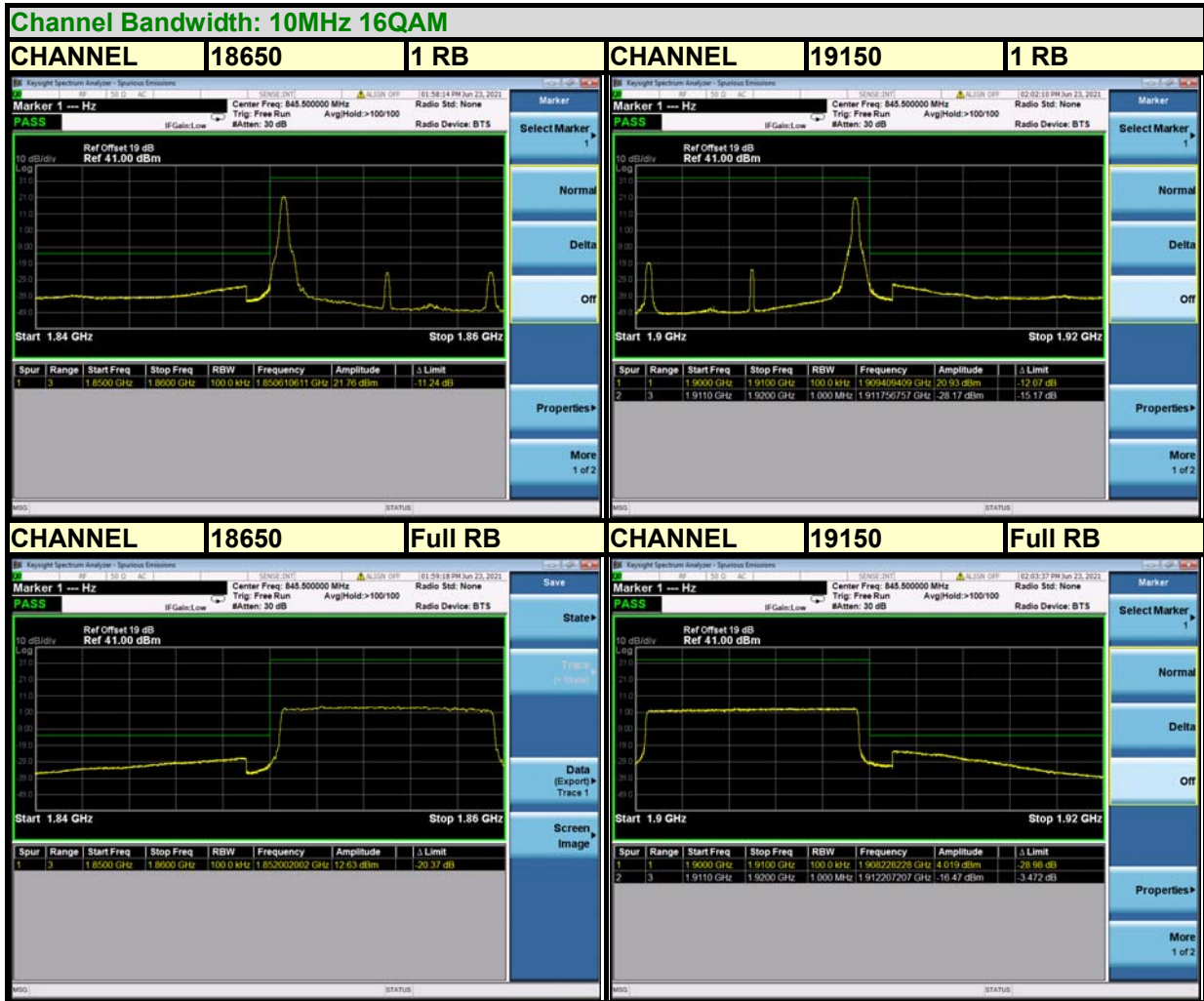



BUREAU VERITAS

Test Report No.: W7L-P20210616-2RF05

LTE BAND 2

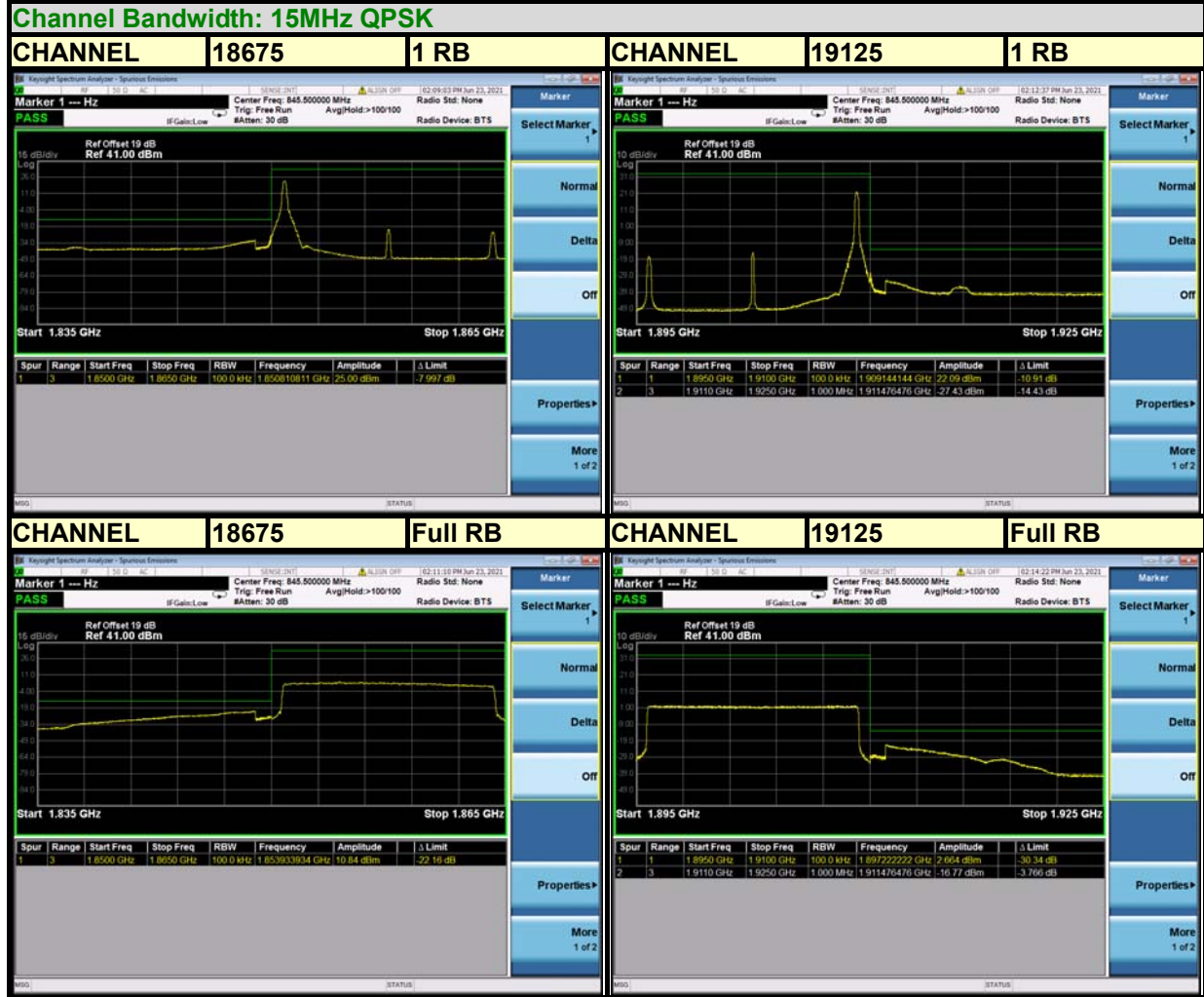



BUREAU
VERITAS

Test Report No.: W7L-P20210616-2RF05





BUREAU VERITAS

Test Report No.: W7L-P20210616-2RF05

LTE BAND 2

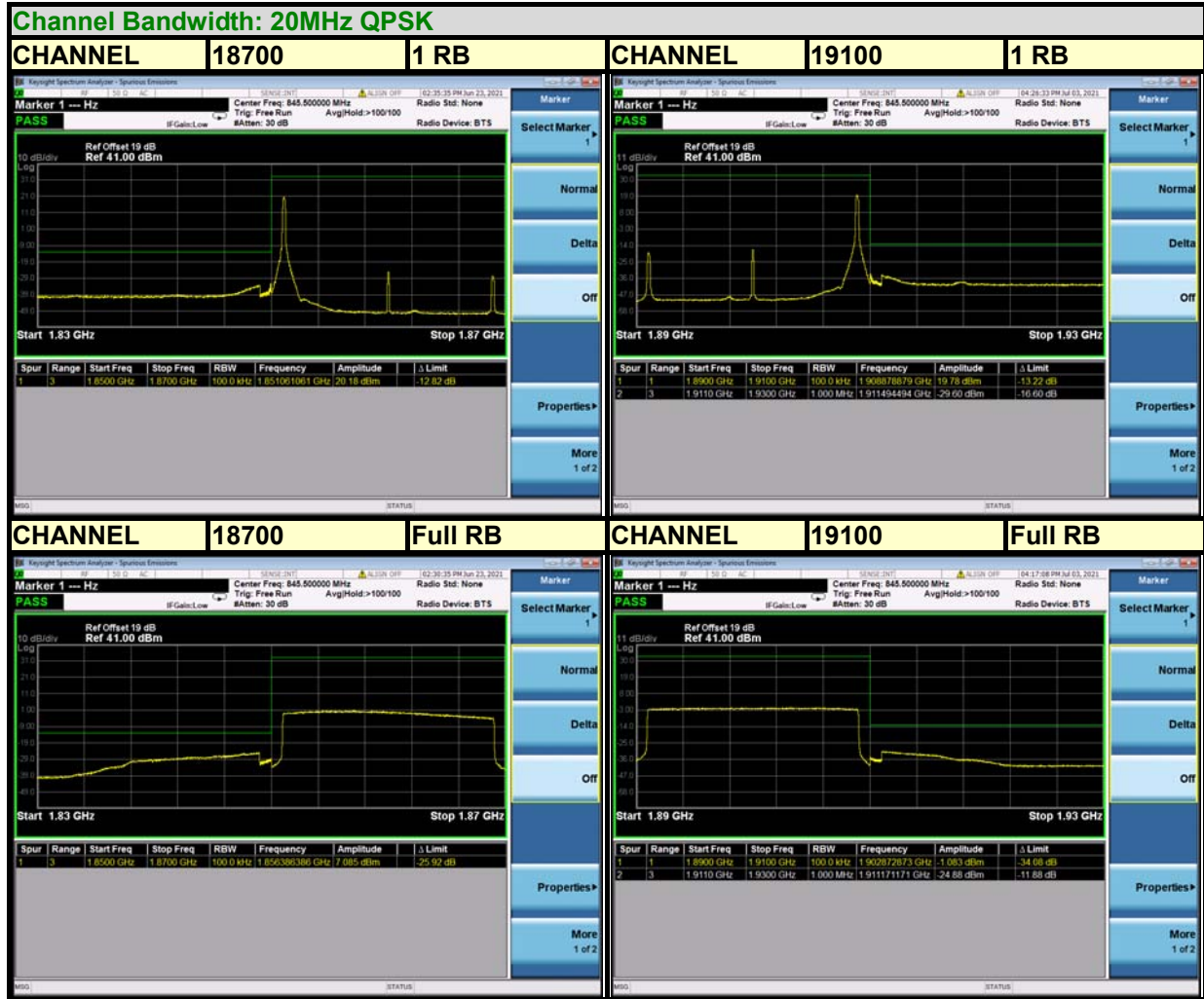



BUREAU VERITAS

Test Report No.: W7L-P20210616-2RF05





3.5 CONDUCTED SPURIOUS EMISSIONS

3.5.1 LIMITS OF CONDUCTED SPURIOUS EMISSIONS MEASUREMENT

The power of any emission outside of the authorized operating frequency ranges must be attenuated below the transmitting power (P) by a factor of at least $43 + 10 \log(P)$ dB. The emission limit equal to -13dBm .

3.5.2 TEST PROCEDURE

- a. The EUT makes a phone call to the communication simulator. All measurements were done at low, middle and high operational frequency range.
- b. Measuring frequency range is from 30 MHz to 19.1GHz. 10dB attenuation pad is connected with spectrum. RBW=1MHz and VBW=3MHz is used for conducted emission measurement.

3.5.3 TEST SETUP

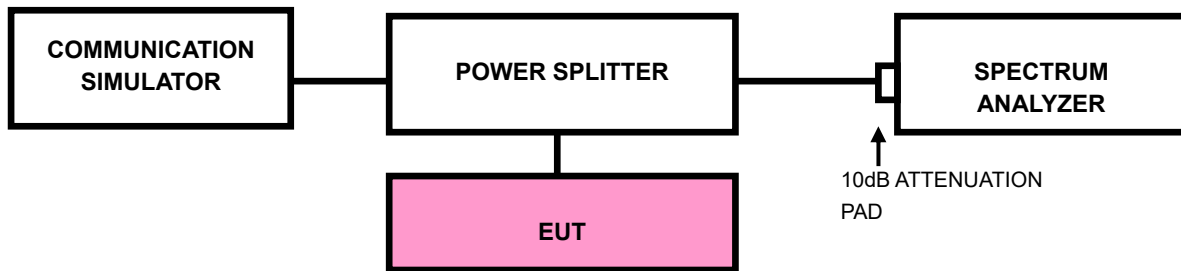



BUREAU VERITAS

Test Report No.: W7L-P20210616-2RF05

3.5.4 TEST RESULTS

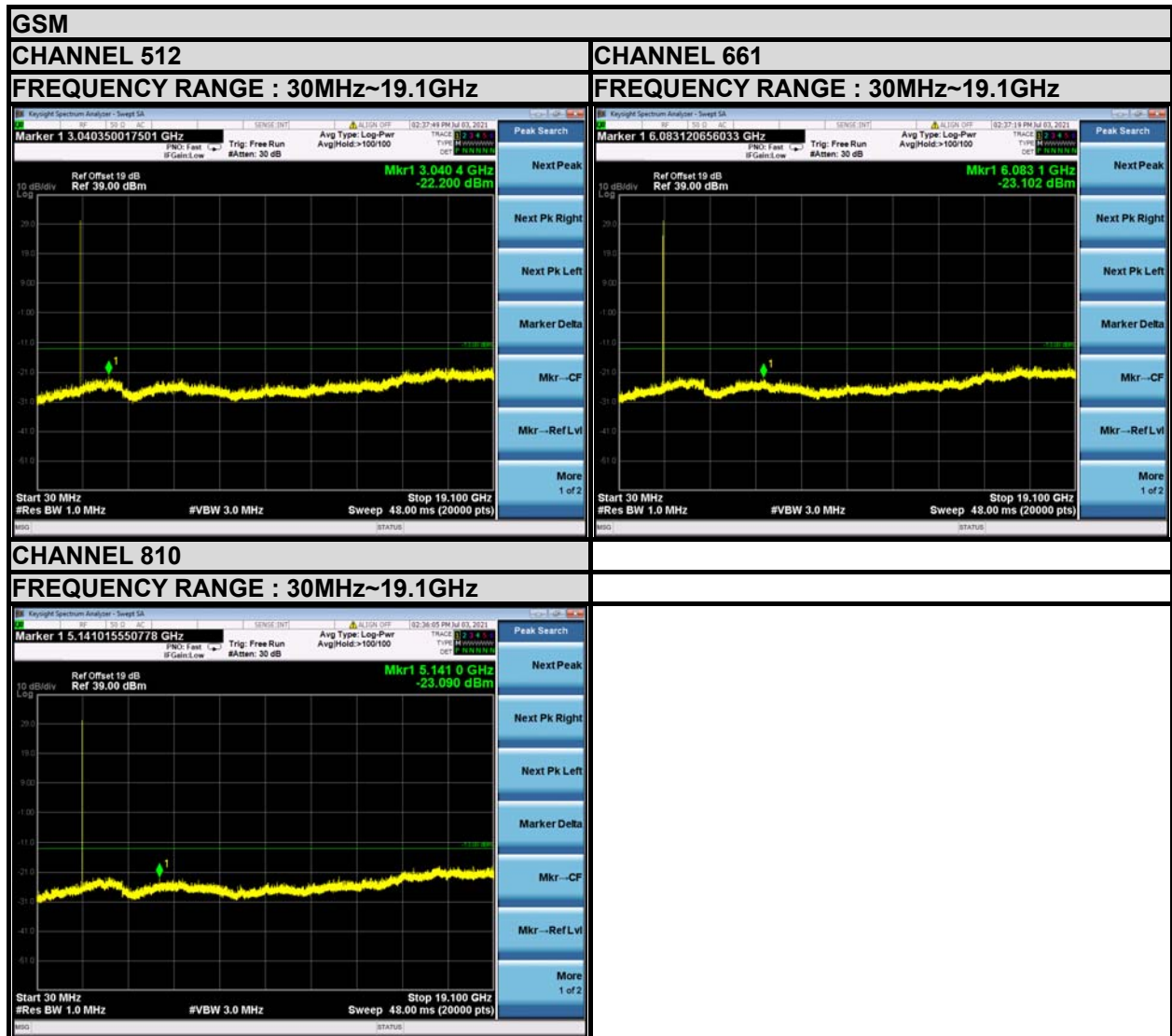



BUREAU VERITAS

Test Report No.: W7L-P20210616-2RF05

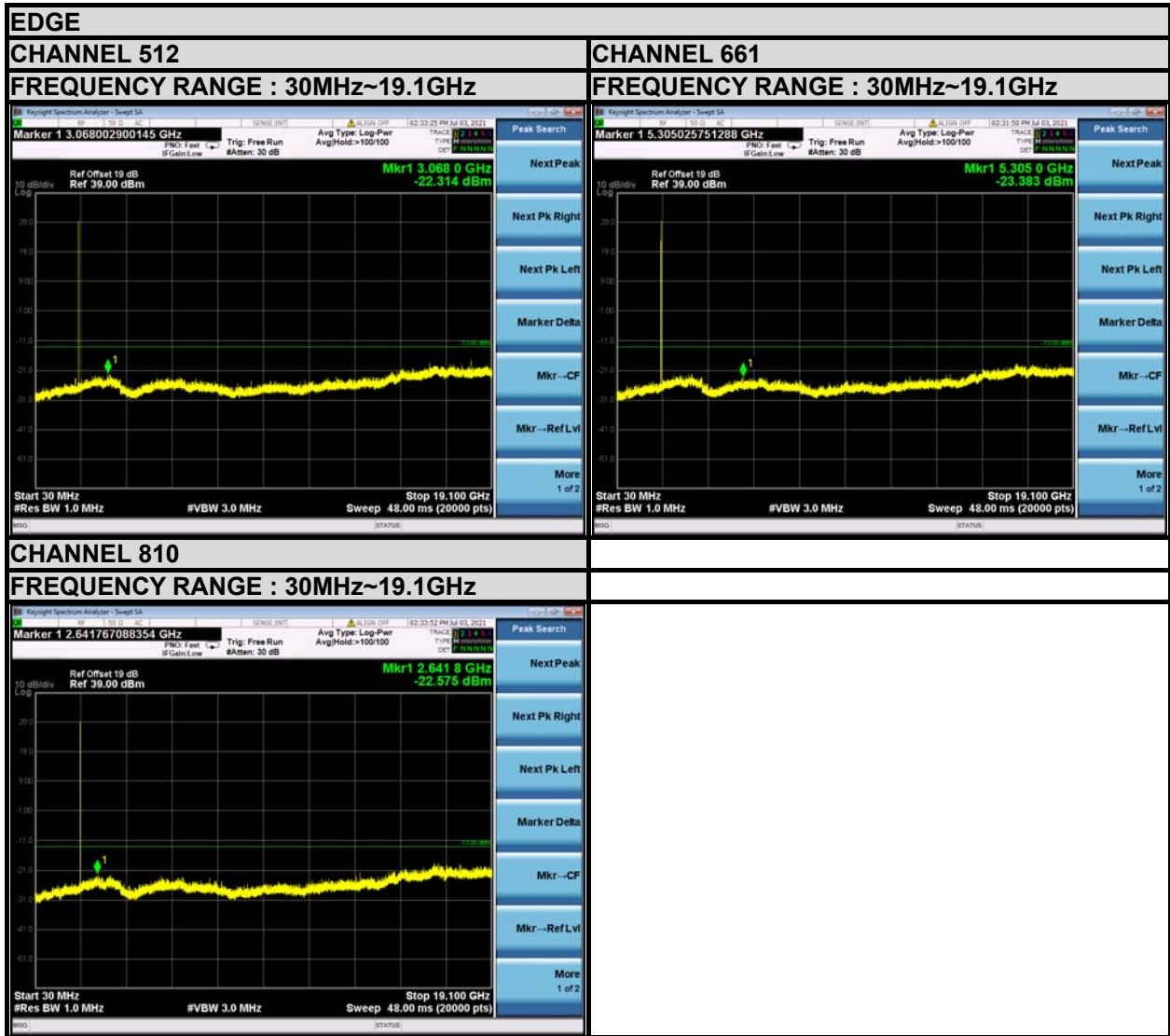



BUREAU VERITAS

Test Report No.: W7L-P20210616-2RF05

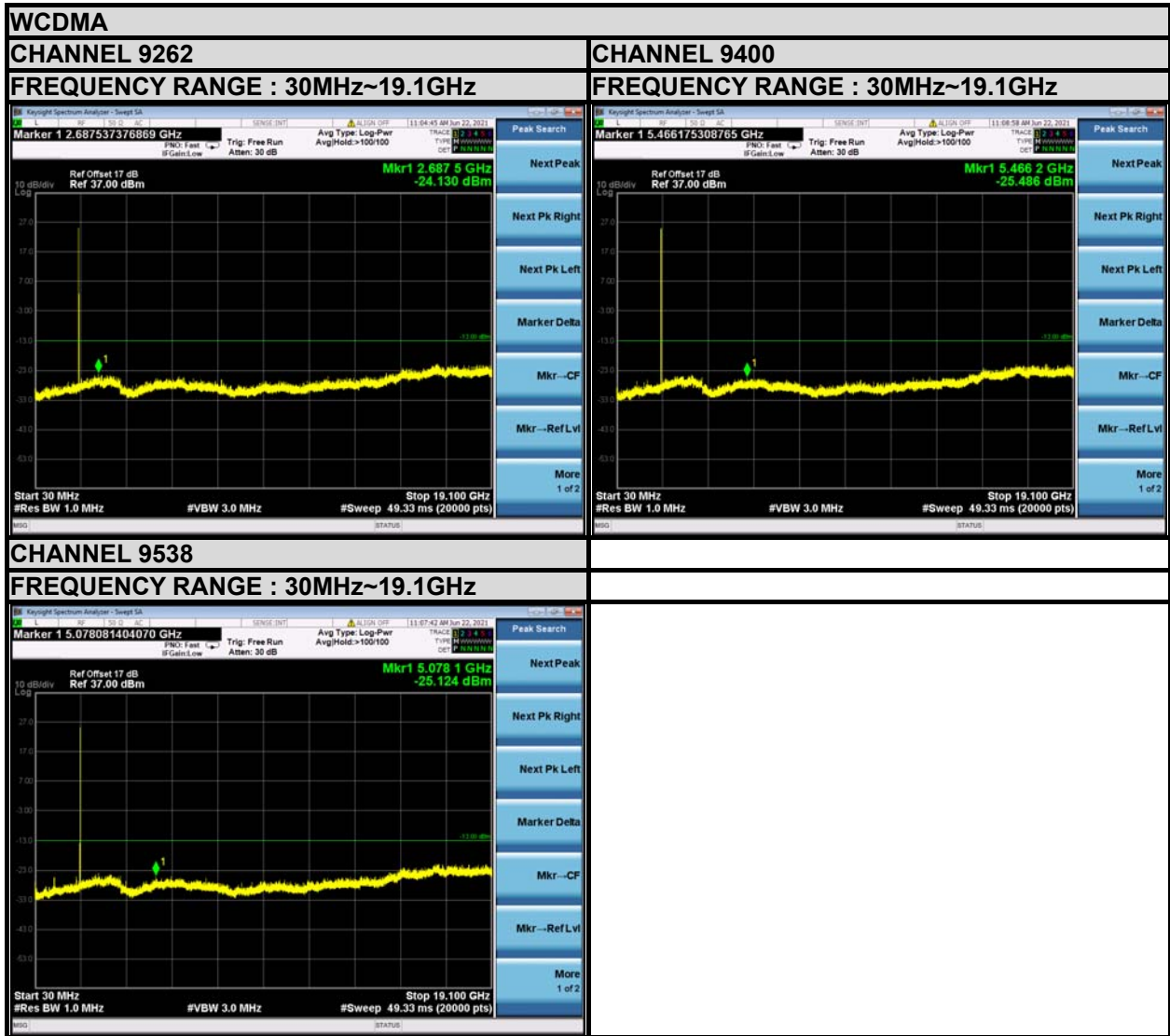



BUREAU VERITAS

Test Report No.: W7L-P20210616-2RF05

LTE BAND 2

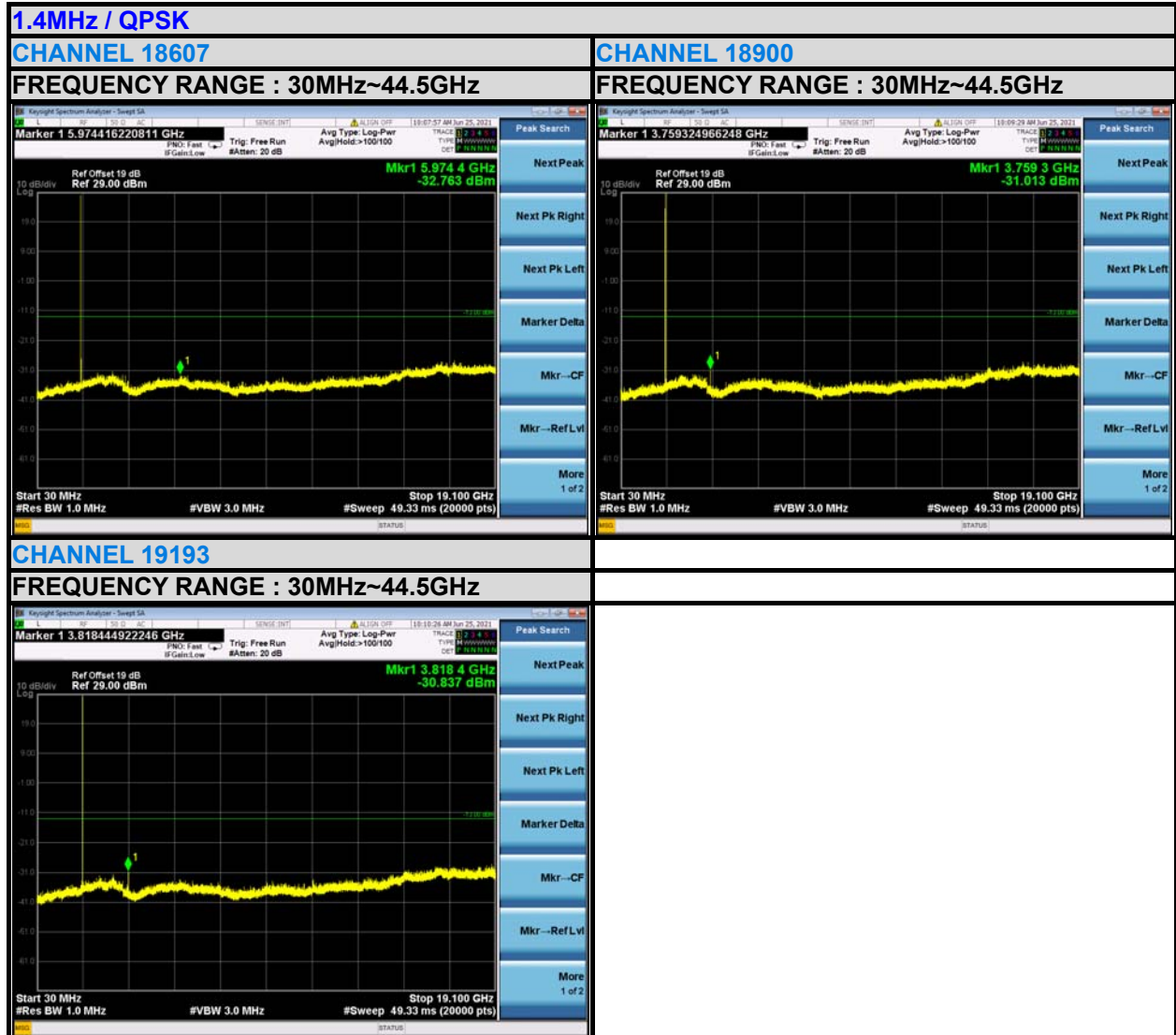



BUREAU VERITAS

Test Report No.: W7L-P20210616-2RF05

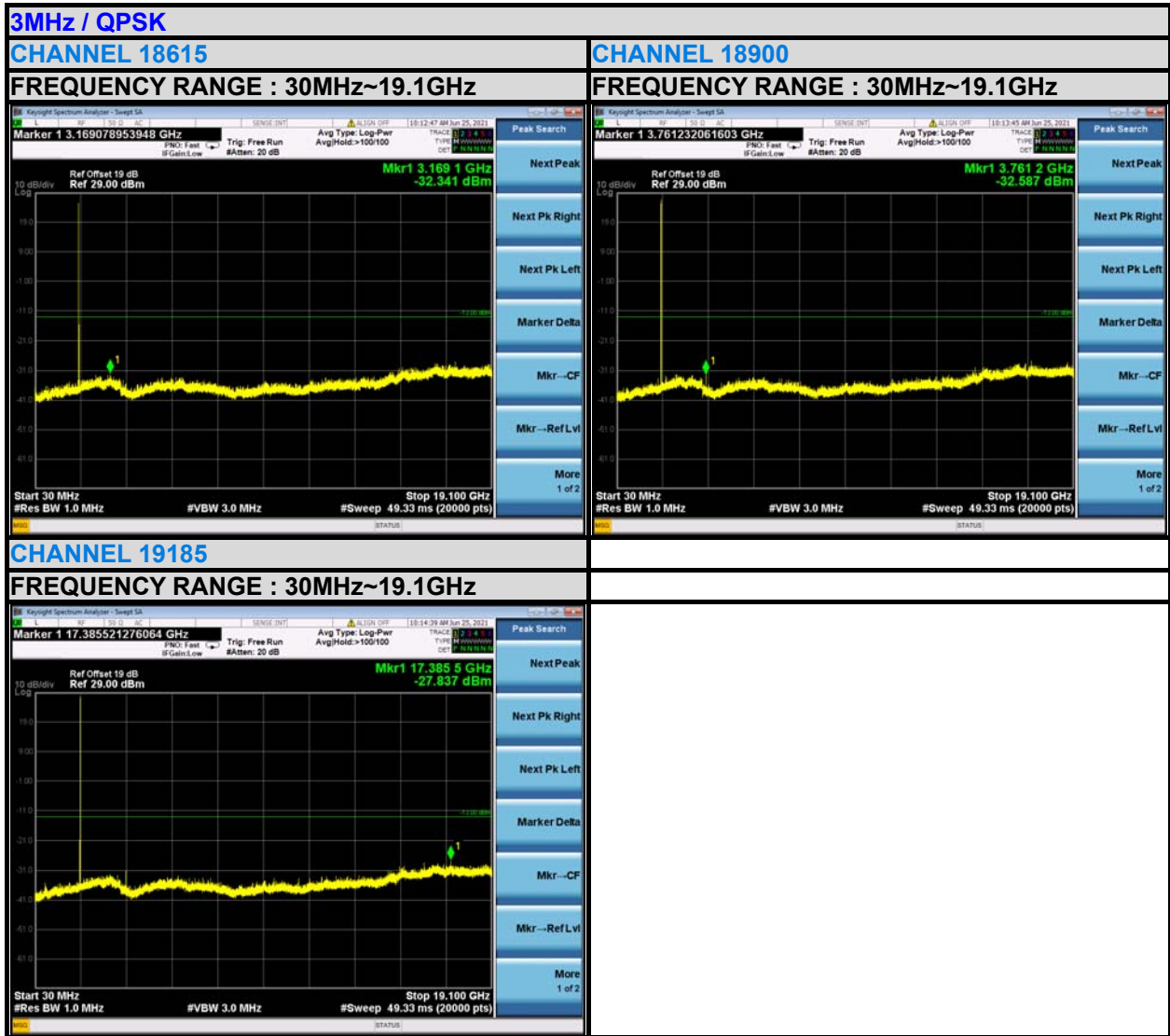



BUREAU VERITAS

Test Report No.: W7L-P20210616-2RF05

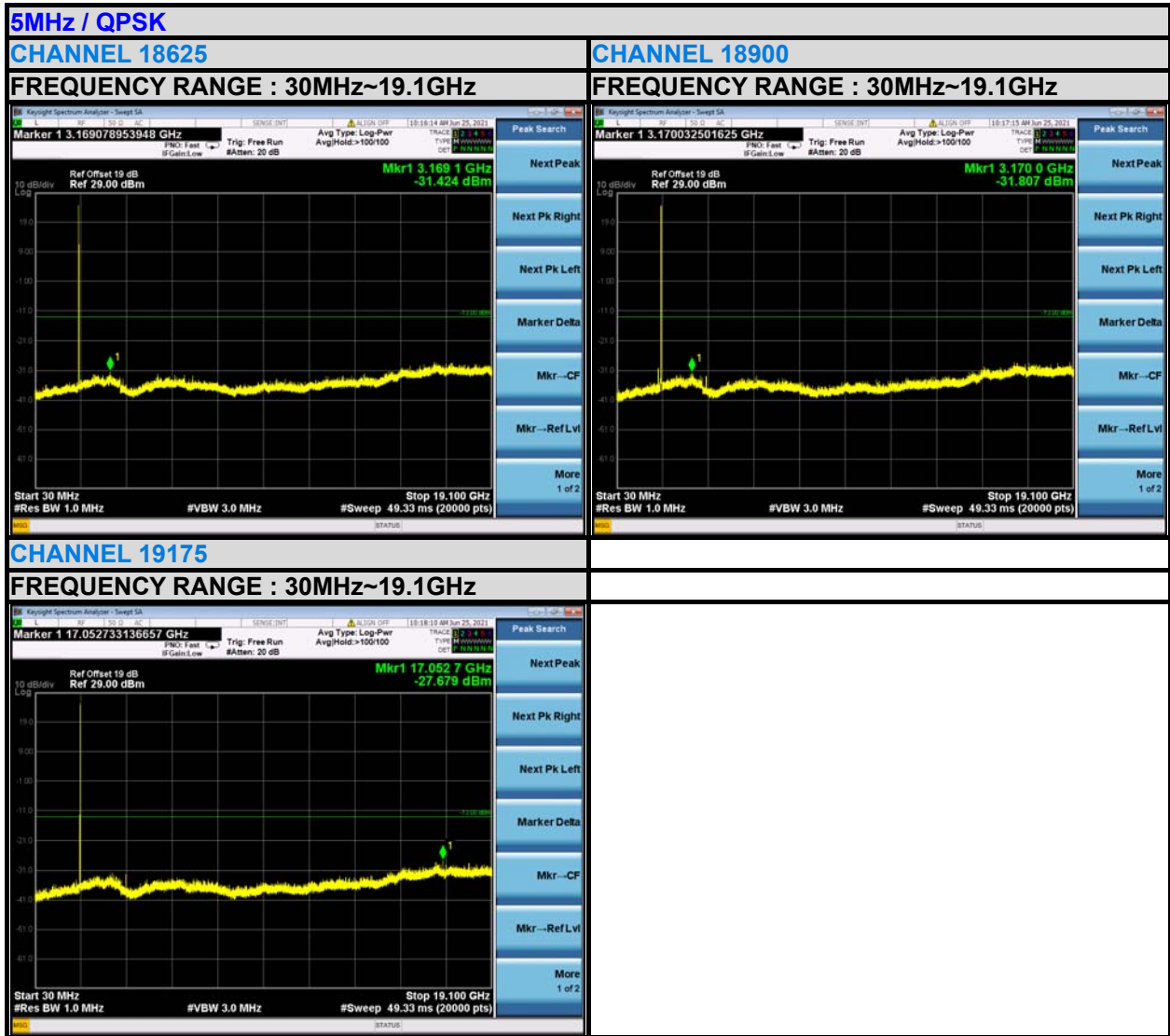



BUREAU VERITAS

Test Report No.: W7L-P20210616-2RF05

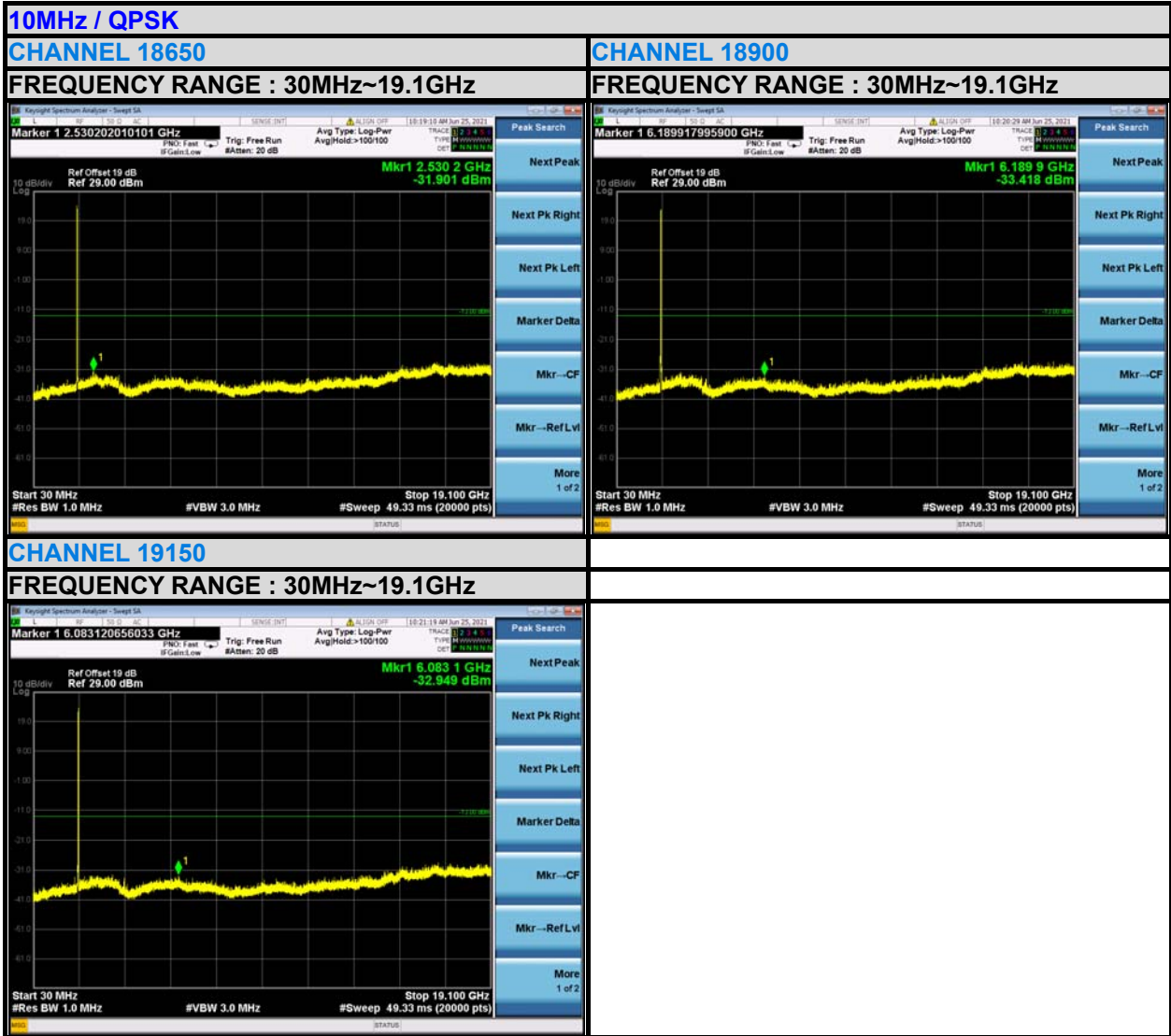



BUREAU VERITAS

Test Report No.: W7L-P20210616-2RF05





BUREAU VERITAS

Test Report No.: W7L-P20210616-2RF05

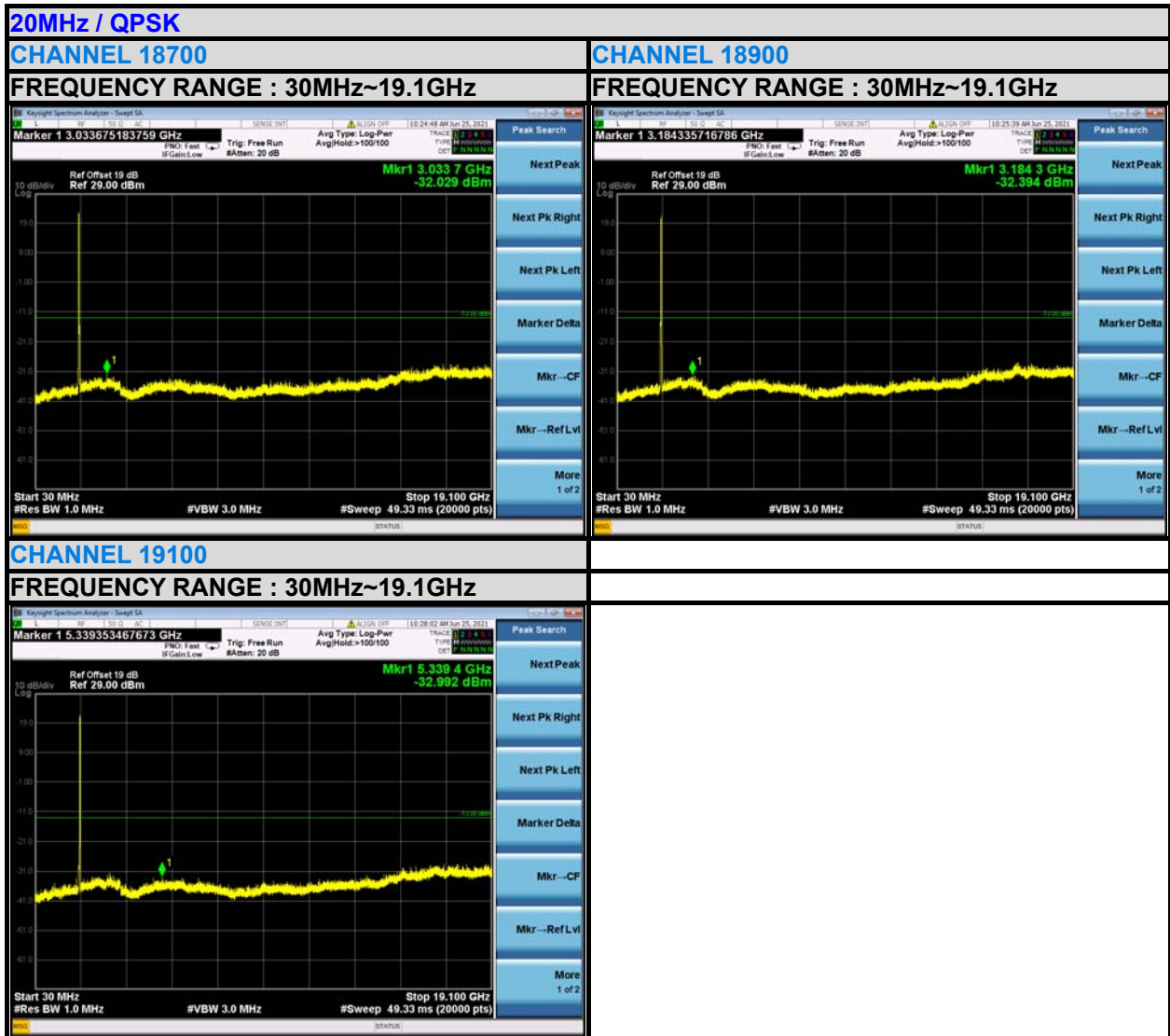



3.6 RADIATED EMISSION MEASUREMENT

3.6.1 LIMITS OF RADIATED EMISSION MEASUREMENT

The power of any emission outside of the authorized operating frequency ranges must be attenuated below the transmitting power (P) by a factor of at least $43 + 10 \log(P)$ dB. The emission limit equal to -13dBm .

3.6.2 TEST PROCEDURES

- a. Substitution method is used for E.I.R.P measurement. In the semi-anechoic chamber, EUT placed on the 0.8m height of Turn Table, rotated the table around 360 degrees to search the maximum radiation power and receiver antenna shall be rotated vertical and horizontal polarization and moved height from 1m to 4m to find the maximum polar radiated power. The “Read Value” is the spectrum reading the maximum power value.
- b. The substitution horn antenna is substituted for EUT at the same position and signals generator export the CW signal to the substitution antenna via a TX cable. Rotated the Turn Table and moved receiving antenna to find the maximum radiation power. Adjust output power level of S.G to get a Value of spectrum reading equal to “Read Value “ of step a. Record the power level of S.G
- c. $\text{EIRP} = \text{Output power level of S.G} - \text{TX cable loss} + \text{Antenna gain of substitution horn}$.

NOTE: The resolution bandwidth and video bandwidth of test receiver/spectrum analyzer is 1MHz/3MHz.

3.6.3 DEVIATION FROM TEST STANDARD

No deviation

3.6.4 TEST SETUP

< Frequency Range 30MHz~1GHz >

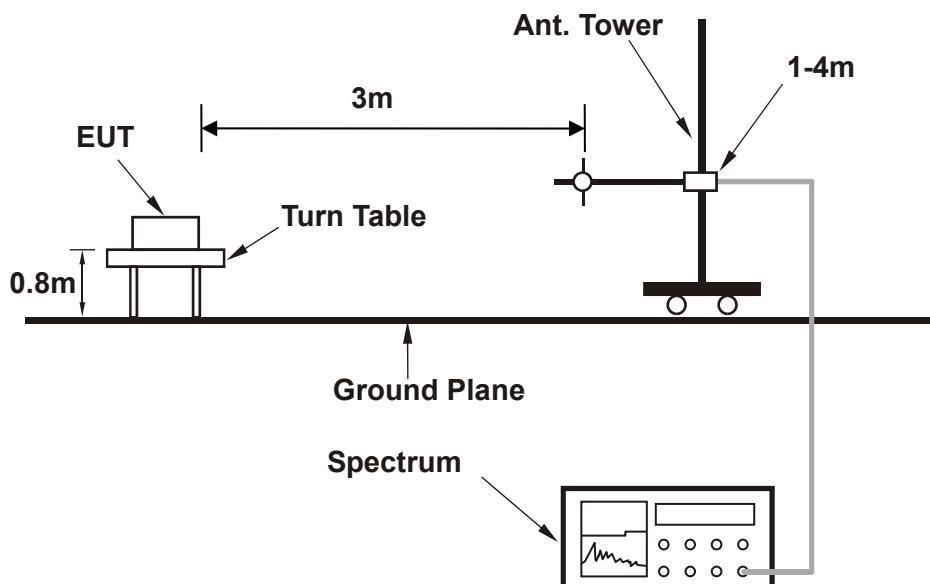

< Frequency Range above 1GHz >

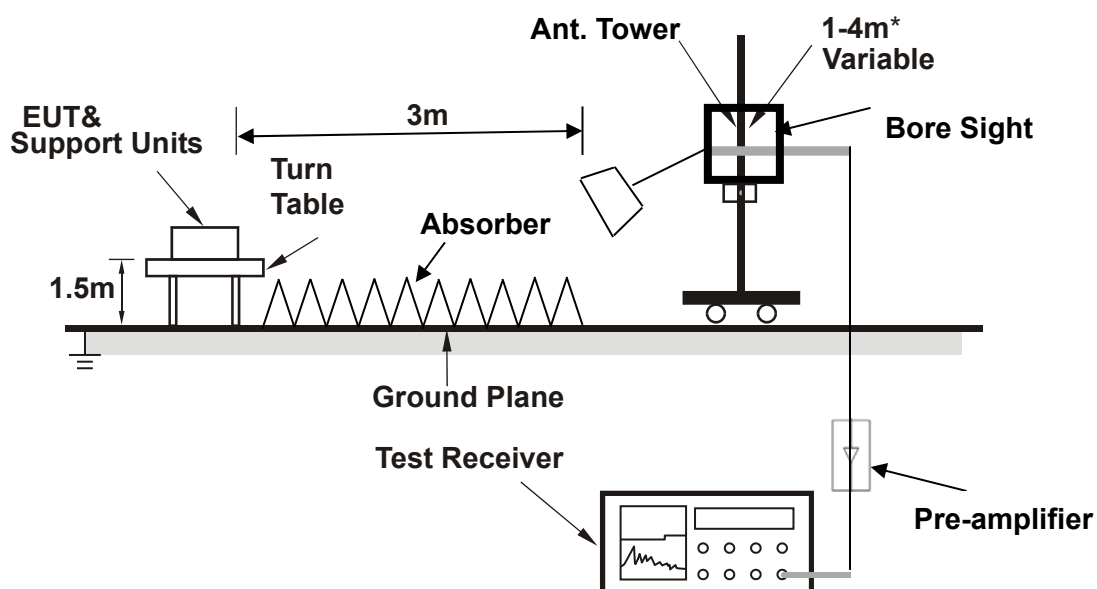

Note: Above 1G is a directional antenna

Depends on the EUT height and the antenna 3dB beamwidth both, refer to section 7.3 of CISPR 16-2-3.

For the actual test configuration, please refer to the attached file (Test Setup Photo).



**BUREAU
VERITAS**

Test Report No.: W7L-P20210616-2RF05

3.6.5 TEST RESULTS

BELOW 1GHz WORST-CASE DATA

30 MHz – 1GHz data:

LTE Band 2

CHANNEL BANDWIDTH: 15MHz / QPSK

MODE	TX channel 18675	FREQUENCY RANGE	Below 1000MHz
ENVIRONMENTAL CONDITIONS	23deg. C, 70%RH	INPUT POWER	EUT 4.0V
TESTED BY	Jace Hu		
ANTENNA POLARITY & TEST DISTANCE: HORIZONTAL AT 3 M			

	Freq	Level	Read Level	Limit Line	Over Limit	Factor	Remark	Pol/Phase
	MHz	dBm/m	dBm	dBm/m	dB	dB/m		
1	30.970	-42.49	-62.90	-13.00	-29.49	20.41	Peak	Horizontal
2	67.830	-33.16	-40.33	-13.00	-20.16	7.17	Peak	Horizontal
3	169.680	-36.14	-46.45	-13.00	-23.14	10.31	Peak	Horizontal
4 PP	250.190	-28.95	-42.45	-13.00	-15.95	13.50	Peak	Horizontal
5	323.910	-35.45	-49.82	-13.00	-22.45	14.37	Peak	Horizontal
6	503.360	-44.34	-63.56	-13.00	-31.34	19.22	Peak	Horizontal

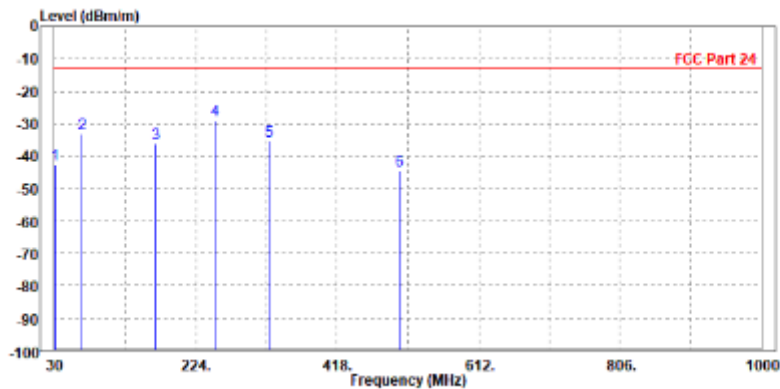



**BUREAU
VERITAS**

Test Report No.: W7L-P20210616-2RF05

MODE	TX channel 18675	FREQUENCY RANGE	Below 1000MHz
ENVIRONMENTAL CONDITIONS	23deg. C, 70%RH	INPUT POWER	EUT 4.0V
TESTED BY	Jace Hu		
ANTENNA POLARITY & TEST DISTANCE: VERTICAL AT 3 M			

	Freq	Level	Read Level	Limit Line	Over Limit	Factor	Remark	Pol/Phase
	MHz	dBm/m	dBm	dBm/m	dB	dB/m		
1	30.970	-30.22	-49.99	-13.00	-17.22	19.77	Peak	Vertical
2	67.830	-24.59	-32.49	-13.00	-11.59	7.90	Peak	Vertical
3	124.090	-41.49	-49.43	-13.00	-28.49	7.94	Peak	Vertical
4	168.710	-40.78	-51.76	-13.00	-27.78	10.98	Peak	Vertical
5	240.490	-37.88	-51.24	-13.00	-24.88	13.36	Peak	Vertical
6	400.540	-40.12	-57.33	-13.00	-27.12	17.21	Peak	Vertical

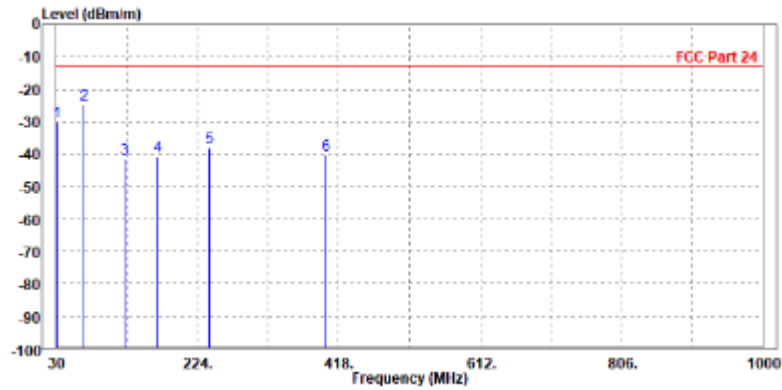



**BUREAU
VERITAS**

Test Report No.: W7L-P20210616-2RF05

ABOVE 1GHz DATA

Note: For higher frequency, the emission is too low to be detected.

WORST-CASE DATA

GSM 1900:

CH 512

MODE	TX channel 512	FREQUENCY RANGE	Above 1000MHz
ENVIRONMENTAL CONDITIONS	23deg. C, 70%RH	INPUT POWER	EUT 4.0V
TESTED BY	Jace Hu		
ANTENNA POLARITY & TEST DISTANCE: HORIZONTAL AT 3 M			

	Freq	Level	Read Level	Limit Line	Over Limit	Factor	Remark	Pol/Phase
	MHz	dBm/m	dBm	dBm/m	dB	dB/m		
1	PP 3698.000	-47.81	-56.59	-13.00	-34.81	8.78	Peak	Horizontal
2	5550.600	-50.15	-60.34	-13.00	-37.15	10.19	Peak	Horizontal

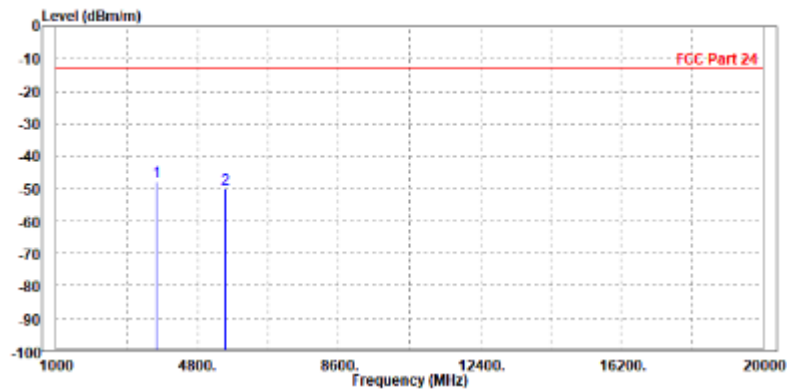



**BUREAU
VERITAS**

Test Report No.: W7L-P20210616-2RF05

MODE	TX channel 512	FREQUENCY RANGE	Above 1000MHz
ENVIRONMENTAL CONDITIONS	23deg. C, 70%RH	INPUT POWER	EUT 4.0V
TESTED BY	Jace Hu		
ANTENNA POLARITY & TEST DISTANCE: VERTICAL AT 3 M			

	Freq	Level	Read Level	Limit Line	Over Limit	Factor	Remark	Pol/Phase
	MHz	dBm/m	dBm	dBm/m	dB	dB/m		
1	PP 3698.000	-47.42	-56.67	-13.00	-34.42	9.25	Peak	Vertical
2	5550.600	-50.30	-60.20	-13.00	-37.30	9.90	Peak	Vertical

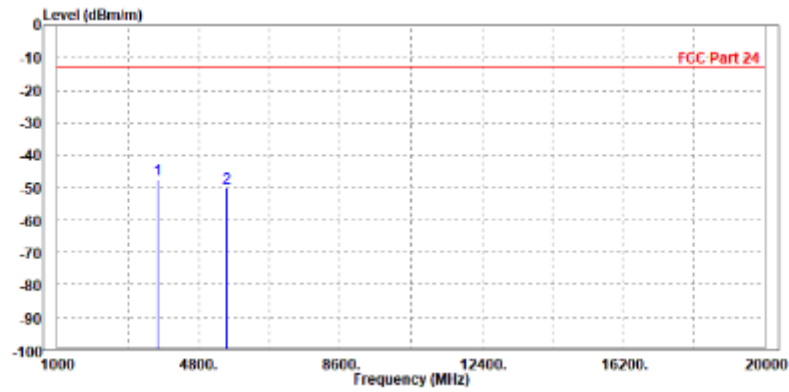



**BUREAU
VERITAS**

Test Report No.: W7L-P20210616-2RF05

CH 661

MODE	TX channel 661	FREQUENCY RANGE	Above 1000MHz
ENVIRONMENTAL CONDITIONS	23deg. C, 70%RH	INPUT POWER	EUT 4.0V
TESTED BY	Jace Hu		
ANTENNA POLARITY & TEST DISTANCE: HORIZONTAL AT 3 M			

	Freq	Level	Read Level	Limit Line	Over Limit	Factor	Remark	Pol/Phase
	MHz	dBm/m	dBm	dBm/m	dB	dB/m		
1	3755.000	-49.62	-58.47	-13.00	-36.62	8.85	Peak	Horizontal
2 PP	5636.000	-46.95	-57.42	-13.00	-33.95	10.47	Peak	Horizontal

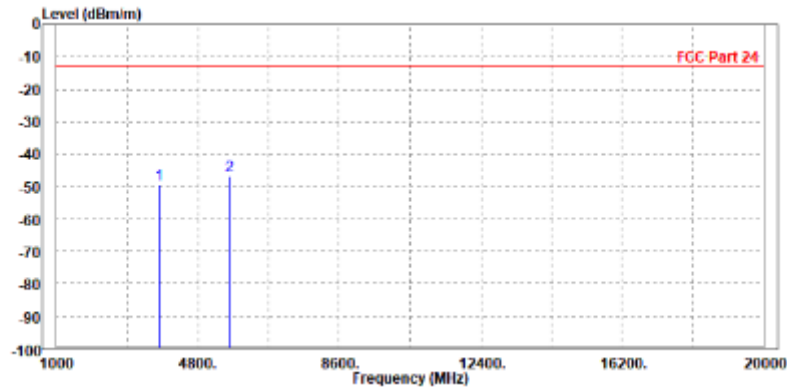



**BUREAU
VERITAS**

Test Report No.: W7L-P20210616-2RF05

MODE	TX channel 661	FREQUENCY RANGE	Above 1000MHz
ENVIRONMENTAL CONDITIONS	23deg. C, 70%RH	INPUT POWER	EUT 4.0V
TESTED BY	Jace Hu		
ANTENNA POLARITY & TEST DISTANCE: VERTICAL AT 3 M			

		Read	Limit	Over			
Freq	Level	Level	Line	Limit	Factor	Remark	Pol/Phase
MHz	dBm/m	dBm	dBm/m	dB	dB/m		
1 PP 3755.000	-48.10	-57.37	-13.00	-35.10	9.27	Peak	Vertical
2 5640.000	-49.42	-59.67	-13.00	-36.42	10.25	Peak	Vertical

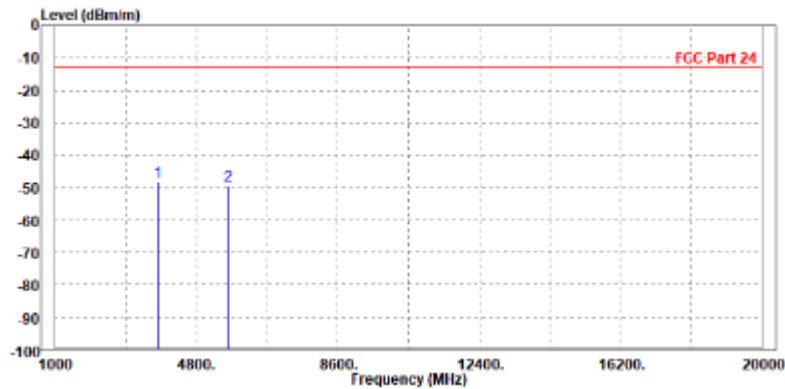



**BUREAU
VERITAS**

Test Report No.: W7L-P20210616-2RF05

CH 810

MODE	TX channel 810	FREQUENCY RANGE	Above 1000MHz
ENVIRONMENTAL CONDITIONS	23deg. C, 70%RH	INPUT POWER	EUT 4.0V
TESTED BY	Jace Hu		
ANTENNA POLARITY & TEST DISTANCE: HORIZONTAL AT 3 M			

	Freq	Level	Read Level	Limit Line	Over Limit	Factor	Remark	Pol/Phase
	MHz	dBm/m	dBm	dBm/m	dB	dB/m		
1	3812.000	-49.07	-57.98	-13.00	-36.07	8.91	Peak	Horizontal
2 PP	5729.400	-46.93	-57.71	-13.00	-33.93	10.78	Peak	Horizontal

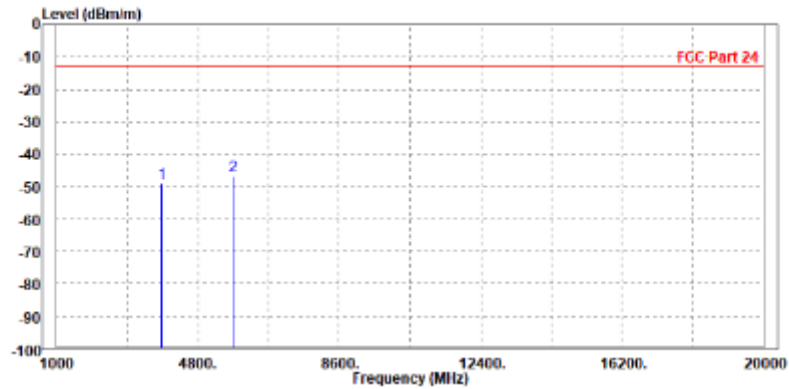



**BUREAU
VERITAS**

Test Report No.: W7L-P20210616-2RF05

MODE	TX channel 810	FREQUENCY RANGE	Above 1000MHz
ENVIRONMENTAL CONDITIONS	23deg. C, 70%RH	INPUT POWER	EUT 4.0V
TESTED BY	Jace Hu		
ANTENNA POLARITY & TEST DISTANCE: VERTICAL AT 3 M			

	Freq	Level	Read Level	Limit Line	Over Limit	Factor	Remark	Pol/Phase
	MHz	dBm/m	dBm	dBm/m	dB	dB/m		
1	3812.000	-48.81	-58.10	-13.00	-35.81	9.29	Peak	Vertical
2 PP	5729.400	-47.36	-57.95	-13.00	-34.36	10.59	Peak	Vertical

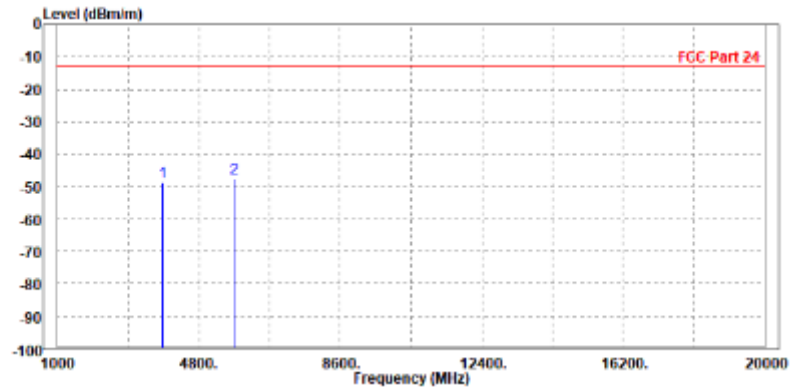



Test Report No.: W7L-P20210616-2RF05

EDGE 1900:

CH 512

MODE	TX channel 512	FREQUENCY RANGE	Above 1000MHz
ENVIRONMENTAL CONDITIONS	23deg. C, 70%RH	INPUT POWER	EUT 4.0V
TESTED BY	Jace Hu		
ANTENNA POLARITY & TEST DISTANCE: HORIZONTAL AT 3 M			

	Freq	Level	Read Level	Limit Line	Over Limit	Factor	Remark	Pol/Phase
	MHz	dBm/m	dBm	dBm/m	dB	dB/m		
1	PP 3698.000	-48.58	-57.36	-13.00	-35.58	8.78	Peak	Horizontal
2	5550.600	-50.17	-60.36	-13.00	-37.17	10.19	Peak	Horizontal

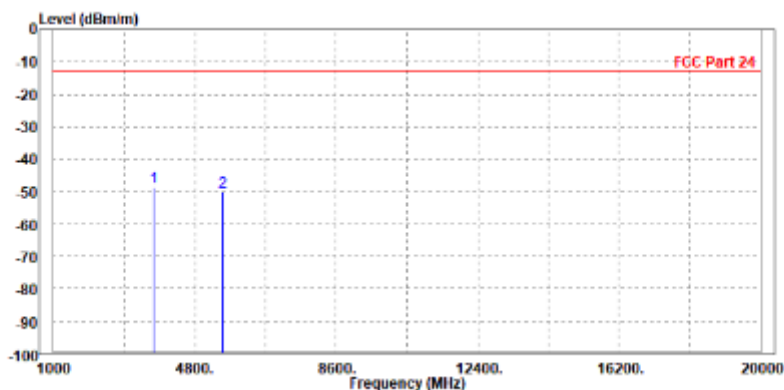



**BUREAU
VERITAS**

Test Report No.: W7L-P20210616-2RF05

MODE	TX channel 512	FREQUENCY RANGE	Above 1000MHz
ENVIRONMENTAL CONDITIONS	23deg. C, 70%RH	INPUT POWER	EUT 4.0V
TESTED BY	Jace Hu		
ANTENNA POLARITY & TEST DISTANCE: VERTICAL AT 3 M			

		Read	Limit	Over			
Freq	Level	Level	Line	Limit	Factor	Remark	Pol/Phase
MHz	dBm/m	dBm	dBm/m	dB	dB/m		
1 PP 3698.000	-48.09	-57.34	-13.00	-35.09	9.25	Peak	Vertical
2 5558.600	-50.26	-60.16	-13.00	-37.26	9.90	Peak	Vertical

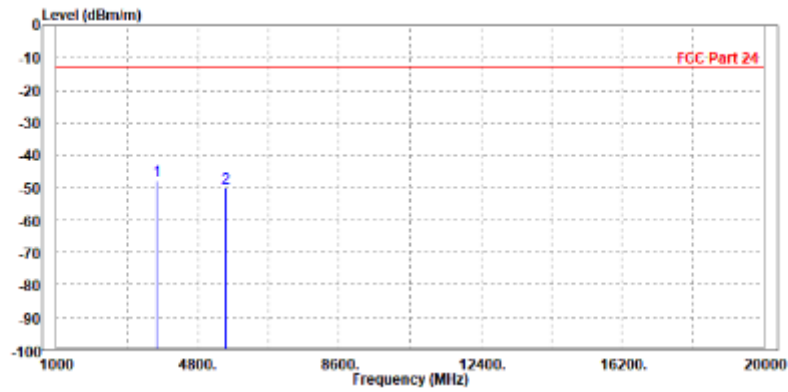



**BUREAU
VERITAS**

Test Report No.: W7L-P20210616-2RF05

CH 661

MODE	TX channel 661	FREQUENCY RANGE	Above 1000MHz
ENVIRONMENTAL CONDITIONS	23deg. C, 70%RH	INPUT POWER	EUT 4.0V
TESTED BY	Jace Hu		
ANTENNA POLARITY & TEST DISTANCE: HORIZONTAL AT 3 M			

	Freq	Level	Read Level	Limit Line	Over Limit	Factor	Remark	Pol/Phase
	MHz	dBm/m	dBm	dBm/m	dB	dB/m		
1	3755.000	-48.49	-57.34	-13.00	-35.49	8.85	Peak	Horizontal
2	PP 5636.000	-47.01	-57.48	-13.00	-34.01	10.47	Peak	Horizontal

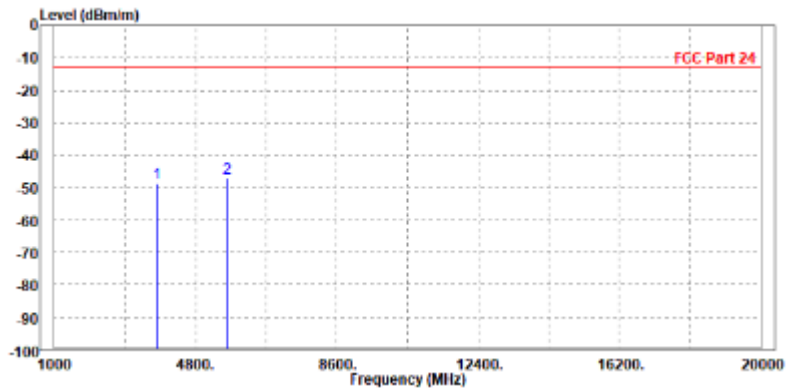



**BUREAU
VERITAS**

Test Report No.: W7L-P20210616-2RF05

MODE	TX channel 661	FREQUENCY RANGE	Above 1000MHz
ENVIRONMENTAL CONDITIONS	23deg. C, 70%RH	INPUT POWER	EUT 4.0V
TESTED BY	Jace Hu		
ANTENNA POLARITY & TEST DISTANCE: VERTICAL AT 3 M			

	Freq	Level	Read Level	Limit Line	Over Limit	Factor	Remark	Pol/Phase
	MHz	dBm/m	dBm	dBm/m	dB	dB/m		
1	3755.000	-49.66	-58.93	-13.00	-36.66	9.27	Peak	Vertical
2 PP	5640.000	-48.65	-58.90	-13.00	-35.65	10.25	Peak	Vertical

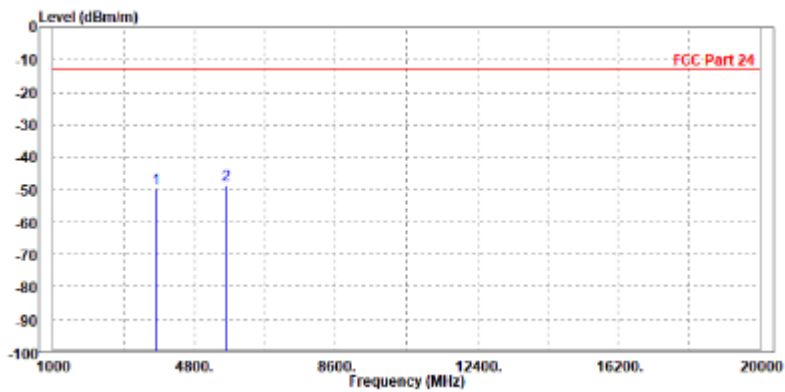



CH 810

MODE	TX channel 810	FREQUENCY RANGE	Above 1000MHz
ENVIRONMENTAL CONDITIONS	23deg. C, 70%RH	INPUT POWER	EUT 4.0V
TESTED BY	Jace Hu		
ANTENNA POLARITY & TEST DISTANCE: HORIZONTAL AT 3 M			

	Freq	Level	Read Level	Limit Line	Over Limit	Factor	Remark	Pol/Phase
	MHz	dBm/m	dBm	dBm/m	dB	dB/m		
1	3812.000	-48.19	-57.10	-13.00	-35.19	8.91	Peak	Horizontal
2 PP	5729.400	-46.99	-57.77	-13.00	-33.99	10.78	Peak	Horizontal

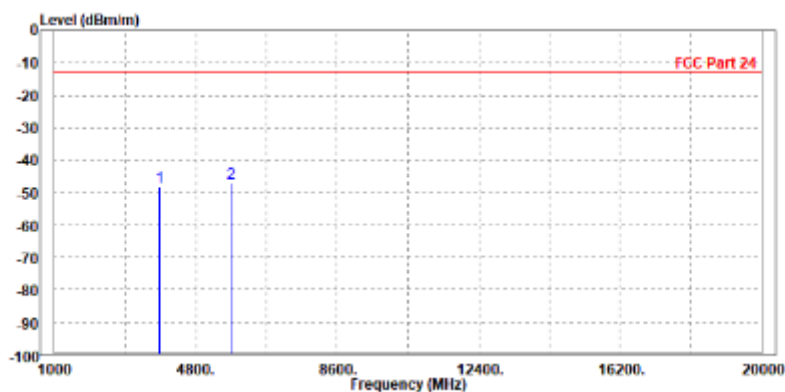



BUREAU VERITAS

Test Report No.: W7L-P20210616-2RF05

MODE	TX channel 810	FREQUENCY RANGE	Above 1000MHz
ENVIRONMENTAL CONDITIONS	23deg. C, 70%RH	INPUT POWER	EUT 4.0V
TESTED BY	Jace Hu		
ANTENNA POLARITY & TEST DISTANCE: VERTICAL AT 3 M			

	Freq	Level	Read Level	Limit Line	Over Limit	Factor	Remark	Pol/Phase
	MHz	dBm/m	dBm	dBm/m	dB	dB/m		
1	3812.000	-48.92	-58.21	-13.00	-35.92	9.29	Peak	Vertical
2 PP	5729.400	-46.75	-57.34	-13.00	-33.75	10.59	Peak	Vertical

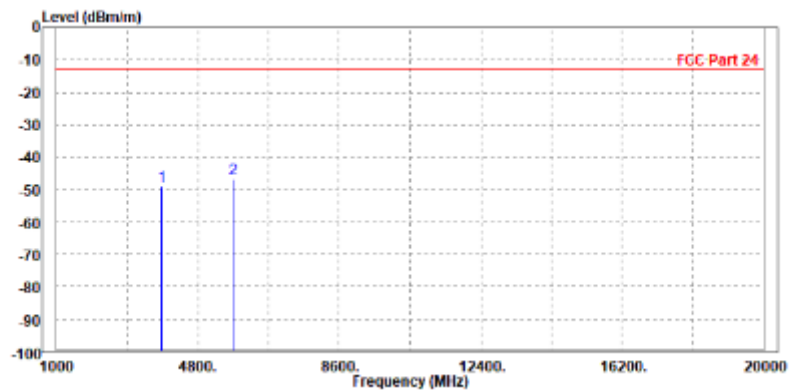



BUREAU VERITAS

Test Report No.: W7L-P20210616-2RF05

WCDMA Band II

CH 9262

MODE	TX channel 9262	FREQUENCY RANGE	Above 1000MHz
ENVIRONMENTAL CONDITIONS	23deg. C, 70%RH	INPUT POWER	EUT 4.0V
TESTED BY	Jace Hu		
ANTENNA POLARITY & TEST DISTANCE: HORIZONTAL AT 3 M			

	Read	Limit	Over			
Freq	Level	Level	Line	Limit	Factor	Remark
MHz	dBm/m	dBm	dBm/m	dB	dB/m	
1 PP 3698.000	-42.27	-51.05	-13.00	-29.27	8.78	Peak Horizontal
2 5557.200	-49.89	-60.10	-13.00	-36.89	10.21	Peak Horizontal

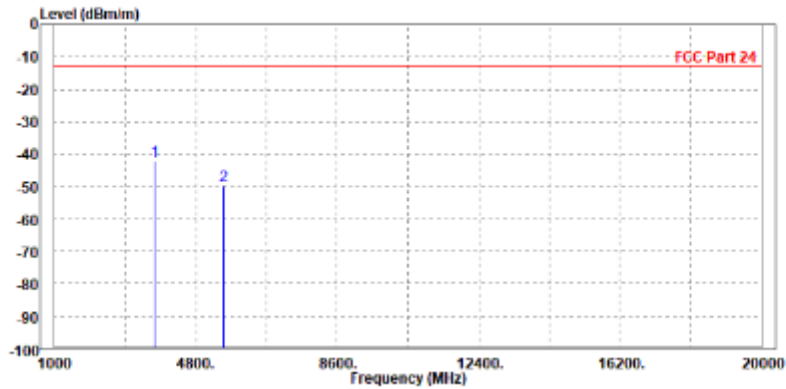



**BUREAU
VERITAS**

Test Report No.: W7L-P20210616-2RF05

MODE	TX channel 9262	FREQUENCY RANGE	Above 1000MHz
ENVIRONMENTAL CONDITIONS	23deg. C, 70%RH	INPUT POWER	EUT 4.0V
TESTED BY	Jace Hu		
ANTENNA POLARITY & TEST DISTANCE: VERTICAL AT 3 M			

	Read	Limit	Over			
Freq	Level	Level	Line	Limit	Factor	Remark
MHz	dBm/m	dBm	dBm/m	dB	dB/m	
1 PP 3698.000	-46.18	-55.43	-13.00	-33.18	9.25	Peak Vertical
2 5557.200	-49.14	-59.07	-13.00	-36.14	9.93	Peak Vertical

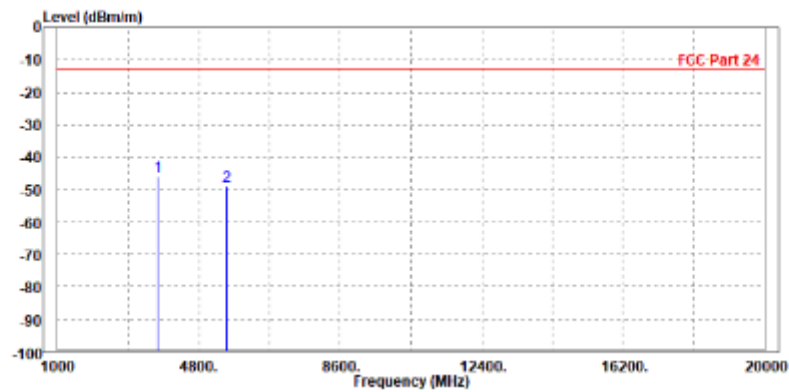



Test Report No.: W7L-P20210616-2RF05

CH 9400

MODE	TX channel 9400	FREQUENCY RANGE	Above 1000MHz
ENVIRONMENTAL CONDITIONS	23deg. C, 70%RH	INPUT POWER	EUT 4.0V
TESTED BY	Jace Hu		
ANTENNA POLARITY & TEST DISTANCE: HORIZONTAL AT 3 M			

	Read	Limit	Over				
Freq	Level	Level	Line	Limit	Factor	Remark	Pol/Phase
MHz	dBm/m	dBm	dBm/m	dB	dB/m		
1 PP 3755.000	-42.09	-50.94	-13.00	-29.09	8.85	Peak	Horizontal
2 5640.000	-47.69	-58.17	-13.00	-34.69	10.48	Peak	Horizontal

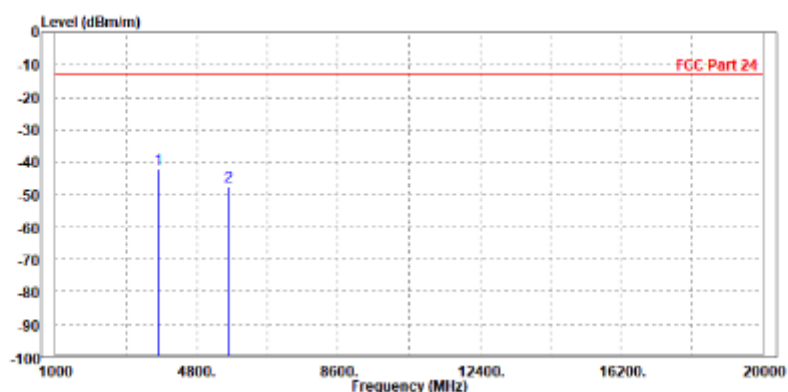



**BUREAU
VERITAS**

Test Report No.: W7L-P20210616-2RF05

MODE	TX channel 9400	FREQUENCY RANGE	Above 1000MHz
ENVIRONMENTAL CONDITIONS	23deg. C, 70%RH	INPUT POWER	EUT 4.0V
TESTED BY	Jace Hu		
ANTENNA POLARITY & TEST DISTANCE: VERTICAL AT 3 M			

	Freq	Level	Read Level	Limit Line	Over Limit	Factor	Remark	Pol/Phase
	MHz	dBm/m	dBm	dBm/m	dB	dB/m		
1	PP 3755.000	-46.32	-55.59	-13.00	-33.32	9.27	Peak	Vertical
2	5640.000	-49.66	-59.91	-13.00	-36.66	10.25	Peak	Vertical

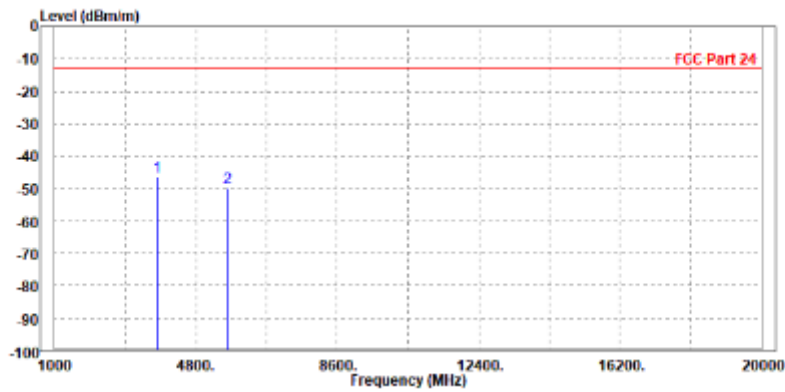



Test Report No.: W7L-P20210616-2RF05

CH 9538

MODE	TX channel 9538	FREQUENCY RANGE	Above 1000MHz
ENVIRONMENTAL CONDITIONS	23deg. C, 70%RH	INPUT POWER	EUT 4.0V
TESTED BY	Jace Hu		
ANTENNA POLARITY & TEST DISTANCE: HORIZONTAL AT 3 M			

	Freq	Level	Read Level	Limit Line	Over Limit	Factor	Remark	Pol/Phase
	MHz	dBm/m	dBm	dBm/m	dB	dB/m		
1 PP	3812.800	-41.54	-50.45	-13.00	-28.54	8.91	Peak	Horizontal
2	5722.800	-47.29	-58.05	-13.00	-34.29	10.76	Peak	Horizontal

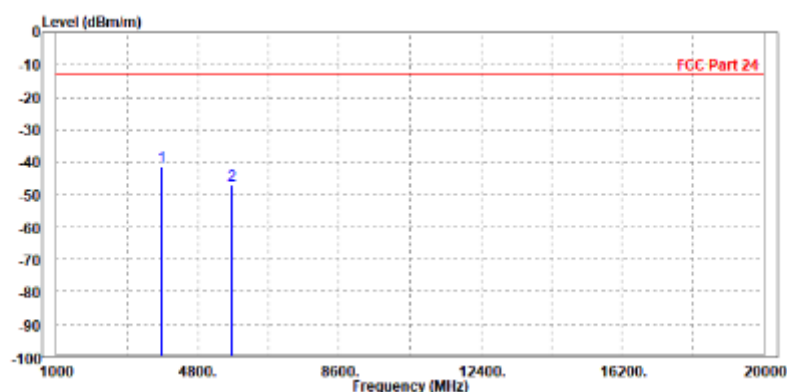



**BUREAU
VERITAS**

Test Report No.: W7L-P20210616-2RF05

MODE	TX channel 9538	FREQUENCY RANGE	Above 1000MHz
ENVIRONMENTAL CONDITIONS	23deg. C, 70%RH	INPUT POWER	EUT 4.0V
TESTED BY	Jace Hu		
ANTENNA POLARITY & TEST DISTANCE: VERTICAL AT 3 M			

	Freq	Level	Read Level	Limit Line	Over Limit	Factor	Remark	Pol/Phase
	MHz	dBm/m	dBm	dBm/m	dB	dB/m		
1	PP 3812.000	-44.43	-53.72	-13.00	-31.43	9.29	Peak	Vertical
2	5722.800	-46.05	-56.62	-13.00	-33.05	10.57	Peak	Vertical

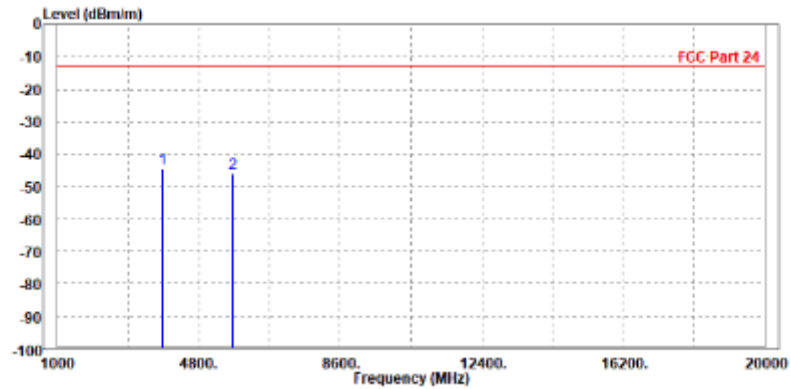



Test Report No.: W7L-P20210616-2RF05

LTE Band 2

CHANNEL BANDWIDTH: 1.4MHz / QPSK

CH18607

MODE	TX channel 18900	FREQUENCY RANGE	Above 1000MHz
ENVIRONMENTAL CONDITIONS	23deg. C, 70%RH	INPUT POWER	EUT 4.0V
TESTED BY	Jace Hu		
ANTENNA POLARITY & TEST DISTANCE: HORIZONTAL AT 3 M			

	Freq	Level	Read Level	Limit Line	Over Limit	Factor	Remark	Pol/Phase
	MHz	dBm/m	dBm	dBm/m	dB	dB/m		
1	PP 3755.000	-39.03	-47.88	-13.00	-26.03	8.85	Peak	Horizontal
2	5640.000	-48.18	-58.66	-13.00	-35.18	10.48	Peak	Horizontal

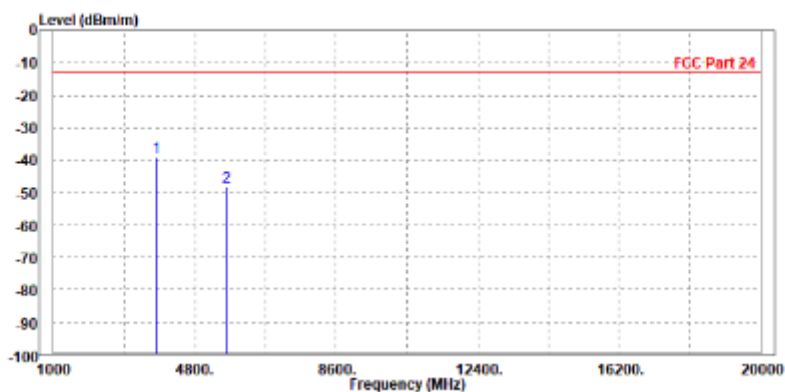



**BUREAU
VERITAS**

Test Report No.: W7L-P20210616-2RF05

MODE	TX channel 18900	FREQUENCY RANGE	Above 1000MHz
ENVIRONMENTAL CONDITIONS	23deg. C, 70%RH	INPUT POWER	EUT 4.0V
TESTED BY	Jace Hu		
ANTENNA POLARITY & TEST DISTANCE: VERTICAL AT 3 M			

	Freq	Level	Read Level	Limit Line	Over Limit	Factor	Remark	Pol/Phase
	MHz	dBm/m	dBm	dBm/m	dB	dB/m		
1	PP 3755.000	-44.24	-53.51	-13.00	-31.24	9.27	Peak	Vertical
2	5640.000	-48.53	-58.78	-13.00	-35.53	10.25	Peak	Vertical

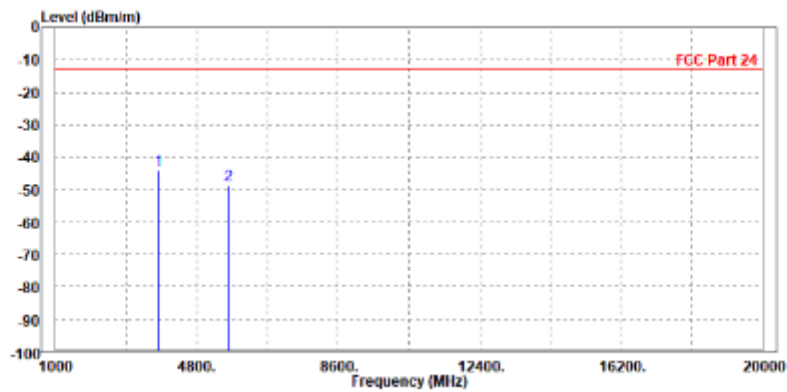



**BUREAU
VERITAS**

Test Report No.: W7L-P20210616-2RF05

CHANNEL BANDWIDTH: 3MHz / QPSK

MODE	TX channel 18900	FREQUENCY RANGE	Above 1000MHz
ENVIRONMENTAL CONDITIONS	23deg. C, 70%RH	INPUT POWER	EUT 4.0V
TESTED BY	Jace Hu		
ANTENNA POLARITY & TEST DISTANCE: HORIZONTAL AT 3 M			

	Read	Limit	Over			
Freq	Level	Level	Line	Limit	Factor	Remark
MHz	dBm/m	dBm	dBm/m	dB	dB/m	Pol/Phase
1 PP 3755.000	-42.91	-51.76	-13.00	-29.91	8.85	Peak Horizontal
2 5640.000	-49.01	-59.49	-13.00	-36.01	10.48	Peak Horizontal

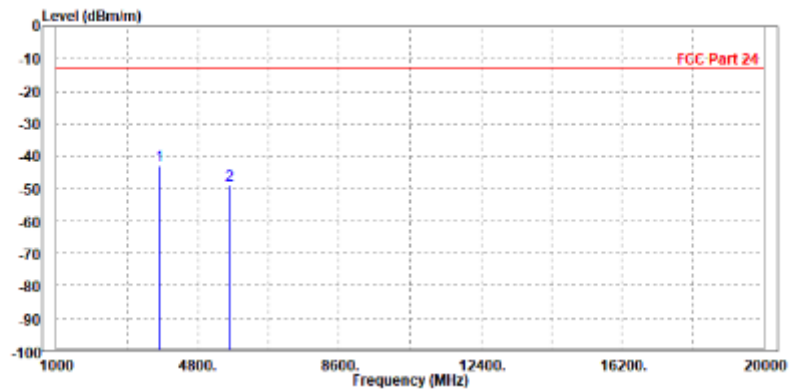



**BUREAU
VERITAS**

Test Report No.: W7L-P20210616-2RF05

MODE	TX channel 18900	FREQUENCY RANGE	Above 1000MHz
ENVIRONMENTAL CONDITIONS	23deg. C, 70%RH	INPUT POWER	EUT 4.0V
TESTED BY	Jace Hu		
ANTENNA POLARITY & TEST DISTANCE: VERTICAL AT 3 M			

	Freq	Level	Read Level	Limit Line	Over Limit	Factor	Remark	Pol/Phase
	MHz	dBm/m	dBm	dBm/m	dB	dB/m		
1	PP 3755.000	-45.34	-54.61	-13.00	-32.34	9.27	Peak	Vertical
2	5640.000	-47.97	-58.22	-13.00	-34.97	10.25	Peak	Vertical

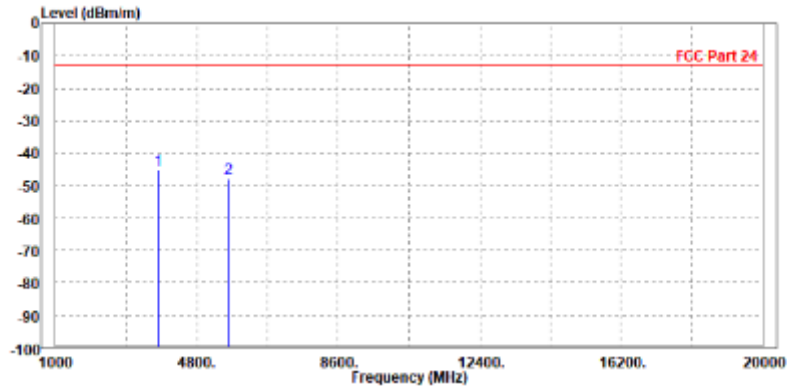



BUREAU VERITAS

Test Report No.: W7L-P20210616-2RF05

CHANNEL BANDWIDTH: 5MHz / QPSK

MODE	TX channel 18900	FREQUENCY RANGE	Above 1000MHz
ENVIRONMENTAL CONDITIONS	23deg. C, 70%RH	INPUT POWER	EUT 4.0V
TESTED BY	Jace Hu		
ANTENNA POLARITY & TEST DISTANCE: HORIZONTAL AT 3 M			

	Freq	Level	Read Level	Limit Line	Over Limit	Factor	Remark	Pol/Phase
	MHz	dBm/m	dBm	dBm/m	dB	dB/m		
1	PP 3755.000	-44.53	-53.38	-13.00	-31.53	8.85	Peak	Horizontal
2	5640.000	-48.35	-58.83	-13.00	-35.35	10.48	Peak	Horizontal

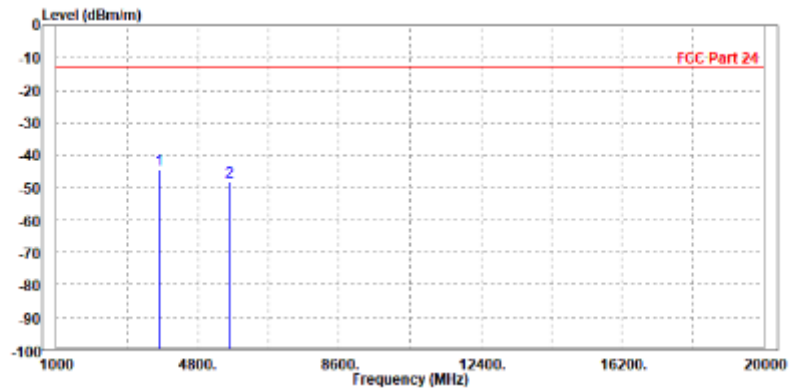



**BUREAU
VERITAS**

Test Report No.: W7L-P20210616-2RF05

MODE	TX channel 18900	FREQUENCY RANGE	Above 1000MHz
ENVIRONMENTAL CONDITIONS	23deg. C, 70%RH	INPUT POWER	EUT 4.0V
TESTED BY	Jace Hu		
ANTENNA POLARITY & TEST DISTANCE: VERTICAL AT 3 M			

		Read	Limit	Over			
	Freq	Level	Level	Line	Limit	Factor	Remark
	MHz	dBm/m	dBm	dBm/m	dB	dB/m	
1	PP 3755.000	-46.61	-55.88	-13.00	-33.61	9.27	Peak Vertical
2	5640.000	-49.32	-59.57	-13.00	-36.32	10.25	Peak Vertical

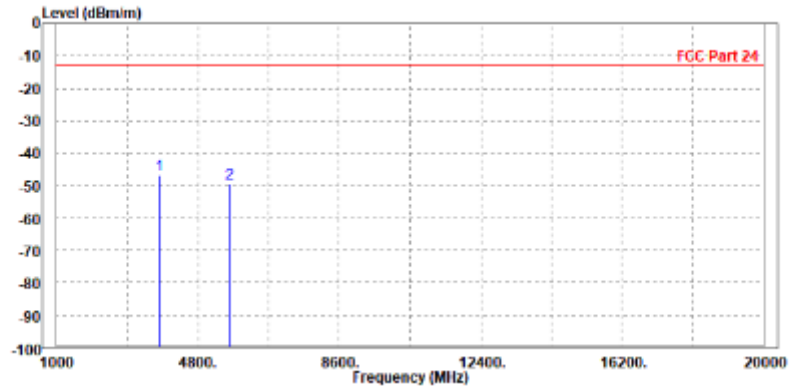



BUREAU VERITAS

Test Report No.: W7L-P20210616-2RF05

CHANNEL BANDWIDTH: 10MHz / QPSK

CH18900

MODE	TX channel 18900	FREQUENCY RANGE	Above 1000MHz
ENVIRONMENTAL CONDITIONS	23deg. C, 70%RH	INPUT POWER	EUT 4.0V
TESTED BY	Jace Hu		
ANTENNA POLARITY & TEST DISTANCE: HORIZONTAL AT 3 M			

	Freq	Level	Read Level	Limit Line	Over Limit	Factor	Remark	Pol/Phase
	MHz	dBm/m	dBm	dBm/m	dB	dB/m		
1	PP 3755.000	-38.54	-47.39	-13.00	-25.54	8.85	Peak	Horizontal
2	5640.000	-48.50	-58.98	-13.00	-35.50	10.48	Peak	Horizontal

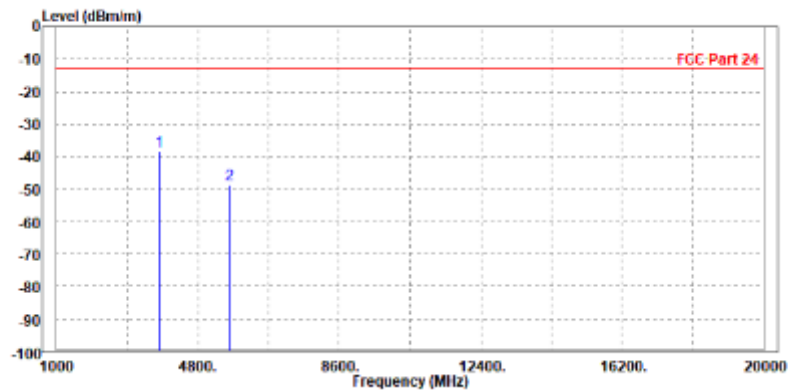



**BUREAU
VERITAS**

Test Report No.: W7L-P20210616-2RF05

MODE	TX channel 18900	FREQUENCY RANGE	Above 1000MHz
ENVIRONMENTAL CONDITIONS	23deg. C, 70%RH	INPUT POWER	EUT 4.0V
TESTED BY	Jace Hu		
ANTENNA POLARITY & TEST DISTANCE: VERTICAL AT 3 M			

	Freq	Level	Read Level	Limit Line	Over Limit	Factor	Remark	Pol/Phase
	MHz	dBm/m	dBm	dBm/m	dB	dB/m		
1	PP 3755.000	-40.63	-49.90	-13.00	-27.63	9.27	Peak	Vertical
2	5640.000	-49.01	-59.26	-13.00	-36.01	10.25	Peak	Vertical

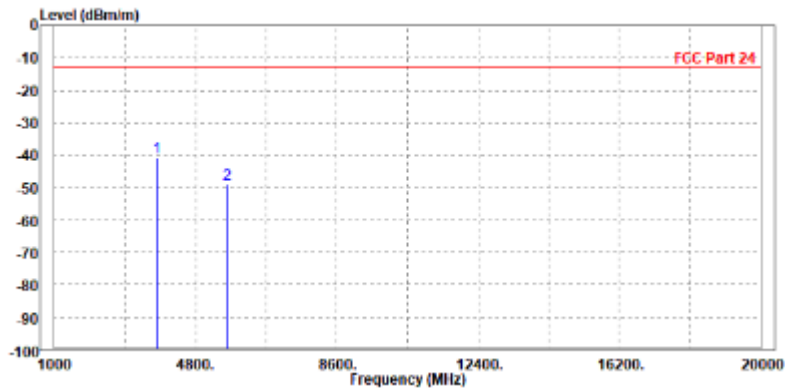



BUREAU VERITAS

Test Report No.: W7L-P20210616-2RF05

CHANNEL BANDWIDTH: 15MHz / QPSK

CH18675

MODE	TX channel 18675	FREQUENCY RANGE	Above 1000MHz
ENVIRONMENTAL CONDITIONS	23deg. C, 70%RH	INPUT POWER	EUT 4.0V
TESTED BY	Jace Hu		
ANTENNA POLARITY & TEST DISTANCE: HORIZONTAL AT 3 M			

	Freq	Level	Read Level	Limit Line	Over Limit	Factor	Remark	Pol/Phase
	MHz	dBm/m	dBm	dBm/m	dB	dB/m		
1	3717.000	-48.33	-57.14	-13.00	-35.33	8.81	Peak	Horizontal
2 PP	5572.500	-47.96	-58.22	-13.00	-34.96	10.26	Peak	Horizontal

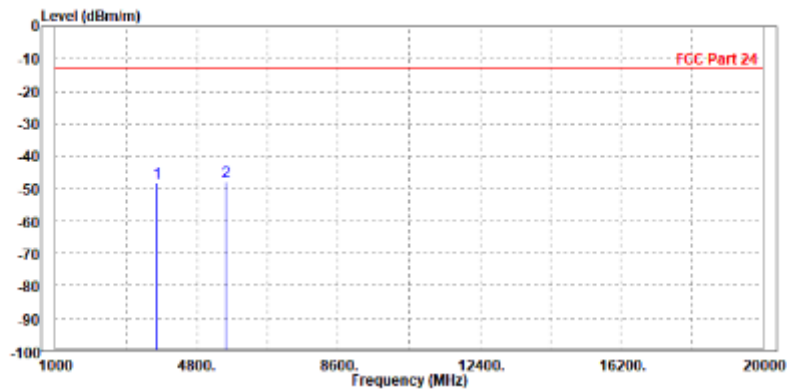



Test Report No.: W7L-P20210616-2RF05

MODE	TX channel 18675	FREQUENCY RANGE	Above 1000MHz
ENVIRONMENTAL CONDITIONS	23deg. C, 70%RH	INPUT POWER	EUT 4.0V
TESTED BY	Jace Hu		
ANTENNA POLARITY & TEST DISTANCE: VERTICAL AT 3 M			

	Freq	Level	Read Level	Limit Line	Over Limit	Factor	Remark	Pol/Phase
	MHz	dBm/m	dBm	dBm/m	dB	dB/m		
1	PP 3717.000	-47.70	-56.96	-13.00	-34.70	9.26	Peak	Vertical
2	5572.500	-47.76	-57.75	-13.00	-34.76	9.99	Peak	Vertical

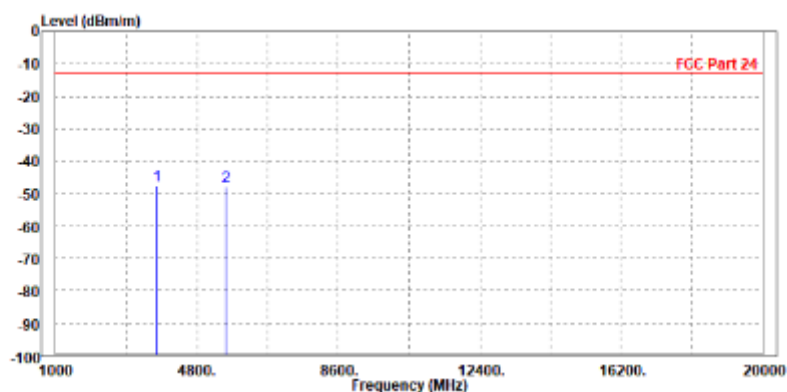



**BUREAU
VERITAS**

Test Report No.: W7L-P20210616-2RF05

CH18900

MODE	TX channel 18900	FREQUENCY RANGE	Above 1000MHz
ENVIRONMENTAL CONDITIONS	23deg. C, 70%RH	INPUT POWER	EUT 4.0V
TESTED BY	Jace Hu		
ANTENNA POLARITY & TEST DISTANCE: HORIZONTAL AT 3 M			

	Freq	Level	Read Level	Limit Line	Over Limit	Factor	Remark	Pol/Phase
	MHz	dBm/m	dBm	dBm/m	dB	dB/m		
1	PP 3755.000	-38.46	-47.31	-13.00	-25.46	8.85	Peak	Horizontal
2	5640.000	-48.94	-59.42	-13.00	-35.94	10.48	Peak	Horizontal

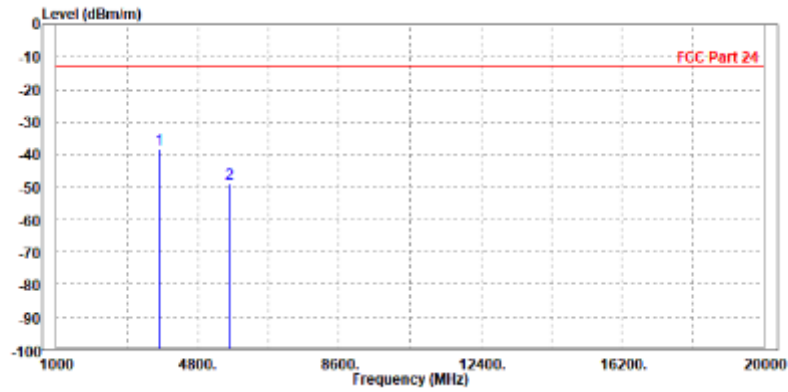



**BUREAU
VERITAS**

Test Report No.: W7L-P20210616-2RF05

MODE	TX channel 18900	FREQUENCY RANGE	Above 1000MHz
ENVIRONMENTAL CONDITIONS	23deg. C, 70%RH	INPUT POWER	EUT 4.0V
TESTED BY	Jace Hu		
ANTENNA POLARITY & TEST DISTANCE: VERTICAL AT 3 M			

	Freq	Level	Read Level	Limit Line	Over Limit	Factor	Remark	Pol/Phase
	MHz	dBm/m	dBm	dBm/m	dB	dB/m		
1	PP 3755.000	-48.48	-49.75	-13.00	-27.48	9.27	Peak	Vertical
2	5640.000	-48.71	-58.96	-13.00	-35.71	10.25	Peak	Vertical

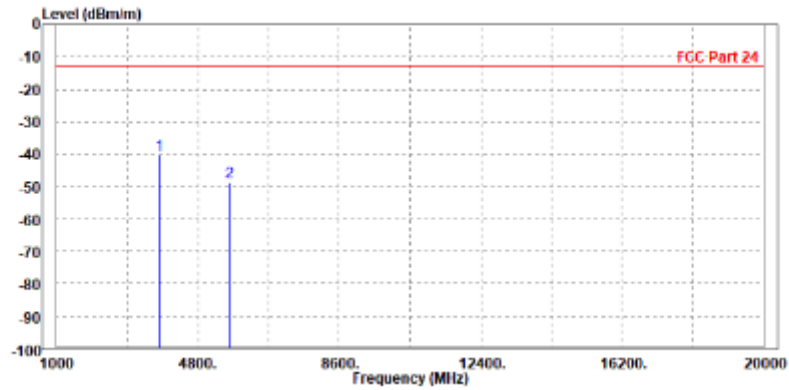



**BUREAU
VERITAS**

Test Report No.: W7L-P20210616-2RF05

CH19125

MODE	TX channel 19125	FREQUENCY RANGE	Above 1000MHz
ENVIRONMENTAL CONDITIONS	23deg. C, 70%RH	INPUT POWER	EUT 4.0V
TESTED BY	Jace Hu		
ANTENNA POLARITY & TEST DISTANCE: HORIZONTAL AT 3 M			

	Freq	Level	Read Level	Limit Line	Over Limit	Factor	Remark	Pol/Phase
	MHz	dBm/m	dBm	dBm/m	dB	dB/m		
1	3885.000	-48.19	-57.09	-13.00	-35.19	8.90	Peak	Horizontal
2 PP	5707.500	-46.80	-57.51	-13.00	-33.80	10.71	Peak	Horizontal

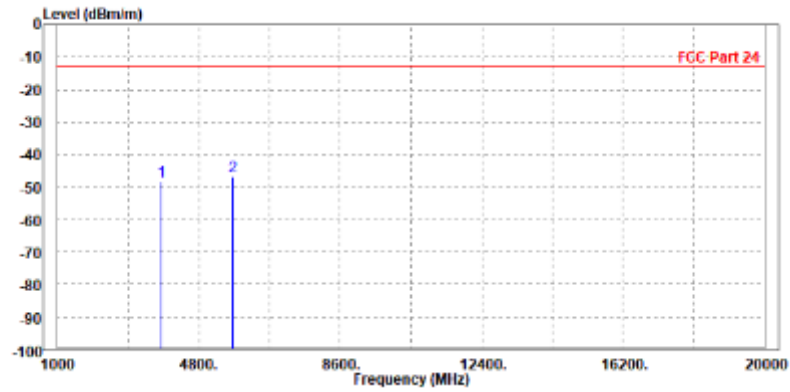



BUREAU VERITAS

Test Report No.: W7L-P20210616-2RF05

MODE	TX channel 19125	FREQUENCY RANGE	Above 1000MHz
ENVIRONMENTAL CONDITIONS	23deg. C, 70%RH	INPUT POWER	EUT 4.0V
TESTED BY	Jace Hu		
ANTENNA POLARITY & TEST DISTANCE: VERTICAL AT 3 M			

	Freq	Level	Read Level	Limit Line	Over Limit	Factor	Remark	Pol/Phase
	MHz	dBm/m	dBm	dBm/m	dB	dB/m		
1	3812.000	-47.24	-56.53	-13.00	-34.24	9.29	Peak	Vertical
2	PP 5707.500	-47.22	-57.73	-13.00	-34.22	10.51	Peak	Vertical

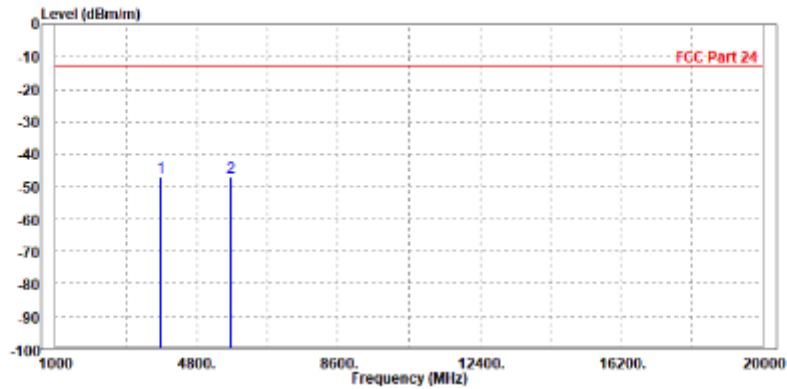



**BUREAU
VERITAS**

Test Report No.: W7L-P20210616-2RF05

CHANNEL BANDWIDTH: 20MHz / QPSK

MODE	TX channel 18900	FREQUENCY RANGE	Above 1000MHz
ENVIRONMENTAL CONDITIONS	23deg. C, 70%RH	INPUT POWER	EUT 4.0V
TESTED BY	Jace Hu		
ANTENNA POLARITY & TEST DISTANCE: HORIZONTAL AT 3 M			

	Freq	Level	Read Level	Limit Line	Over Limit	Factor	Remark	Pol/Phase
	MHz	dBm/m	dBm	dBm/m	dB	dB/m		
1	3755.000	-49.13	-57.98	-13.00	-36.13	8.85	Peak	Horizontal
2	5640.000	-47.96	-58.44	-13.00	-34.96	10.48	Peak	Horizontal

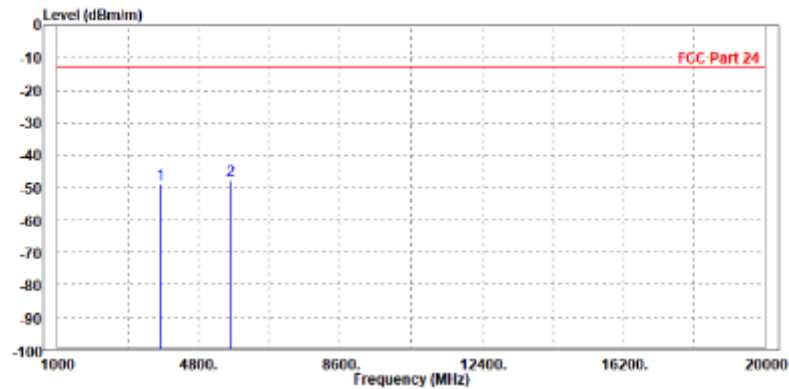



**BUREAU
VERITAS**

Test Report No.: W7L-P20210616-2RF05

MODE	TX channel 18900	FREQUENCY RANGE	Above 1000MHz
ENVIRONMENTAL CONDITIONS	23deg. C, 70%RH	INPUT POWER	EUT 4.0V
TESTED BY	Jace Hu		
ANTENNA POLARITY & TEST DISTANCE: VERTICAL AT 3 M			

	Freq	Level	Read Level	Limit Line	Over Limit	Factor	Remark	Pol/Phase
	MHz	dBm/m	dBm	dBm/m	dB	dB/m		
1 PP	3755.000	-48.39	-57.66	-13.00	-35.39	9.27	Peak	Vertical
2	5640.000	-48.75	-59.00	-13.00	-35.75	10.25	Peak	Vertical

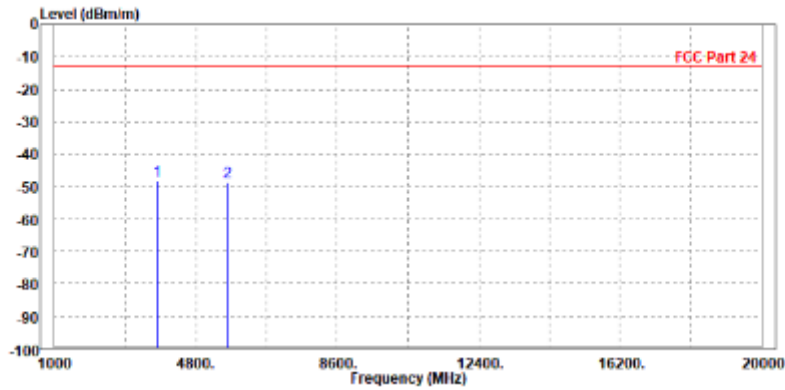

3.7 PEAK TO AVERAGE RATIO

3.7.1 LIMITS OF PEAK TO AVERAGE RATIO MEASUREMENT

In measuring transmissions in this band using an average power technique, the peak to-average ratio (PAR) of the transmission may not exceed 13 dB

3.7.2 TEST SETUP

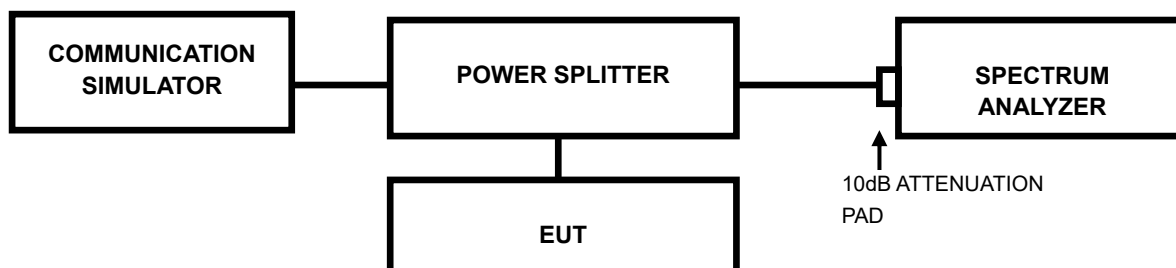

3.7.3 TEST PROCEDURES

1. Set resolution/measurement bandwidth \geq signal's occupied bandwidth;
2. Set the number of counts to a value that stabilizes the measured CCDF curve;
3. Record the maximum PAPR level associated with a probability of 0.1%.



3.7.4 TEST RESULTS

GSM

CHANNEL	FREQUENCY (MHz)	PEAK TO AVERAGE RATIO (dB)
512	1850.2	3.20

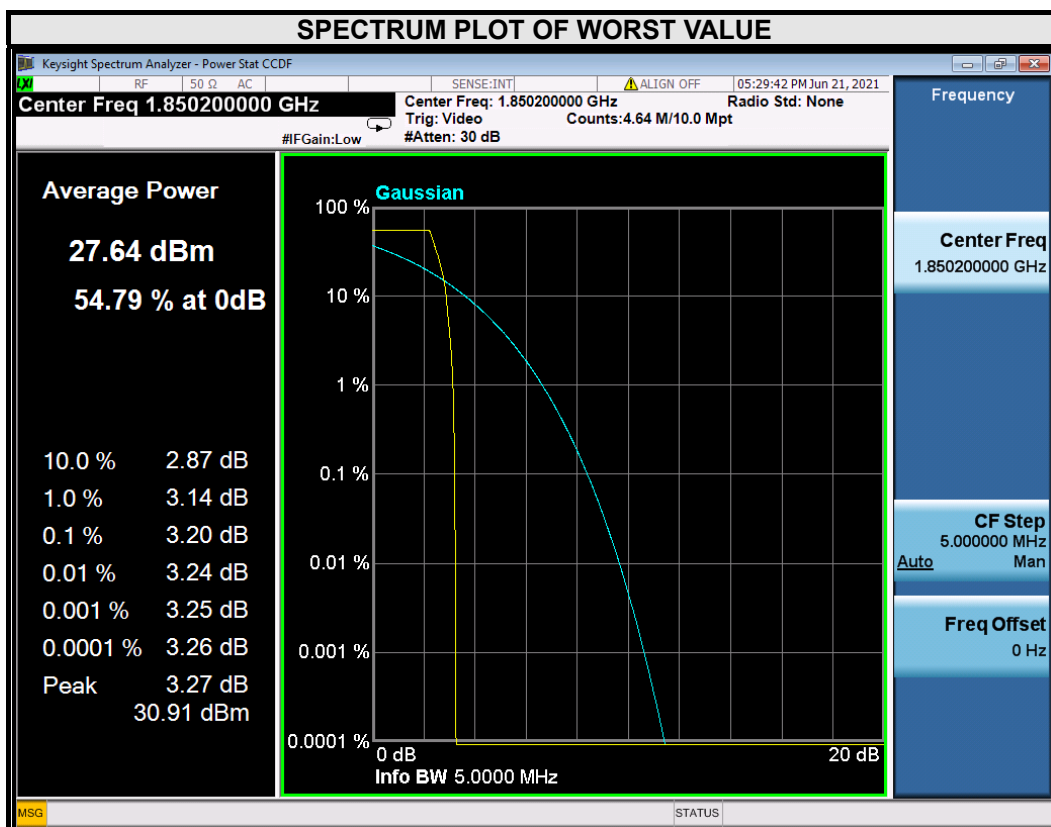



Test Report No.: W7L-P20210616-2RF05

CHANNEL	FREQUENCY (MHz)	PEAK TO AVERAGE RATIO (dB)
661	1880	3.11

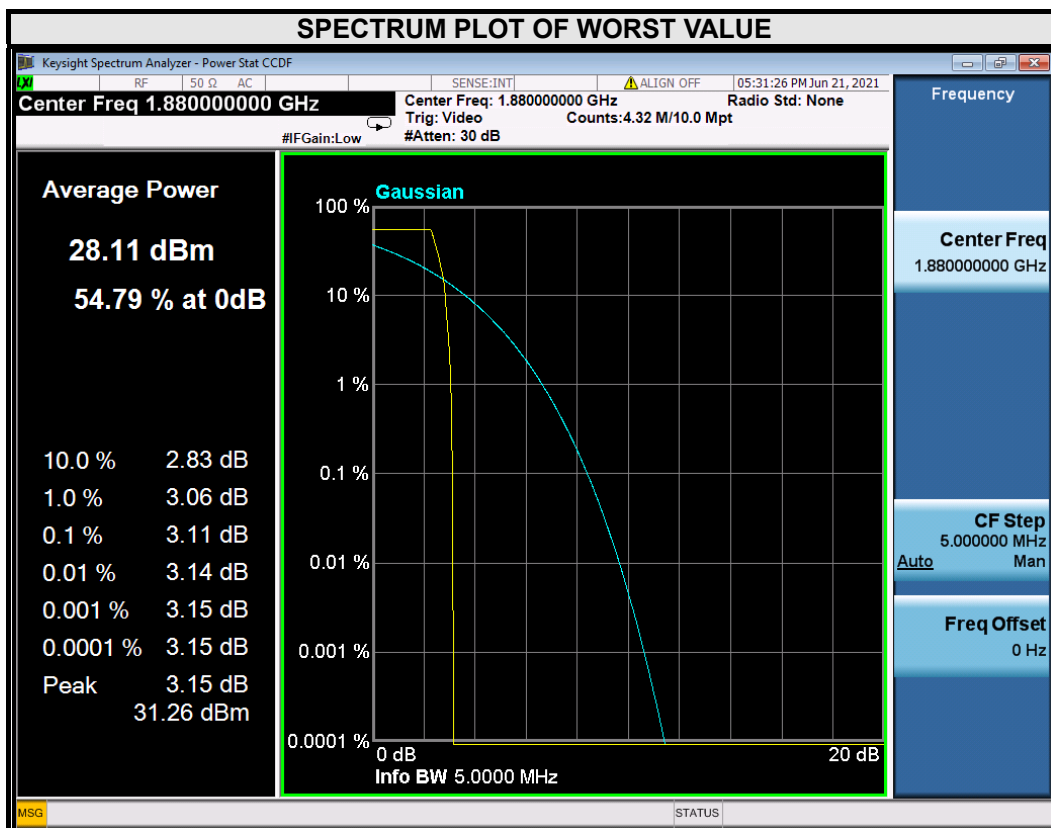



Test Report No.: W7L-P20210616-2RF05

CHANNEL	FREQUENCY (MHz)	PEAK TO AVERAGE RATIO (dB)
810	1909.8	2.87

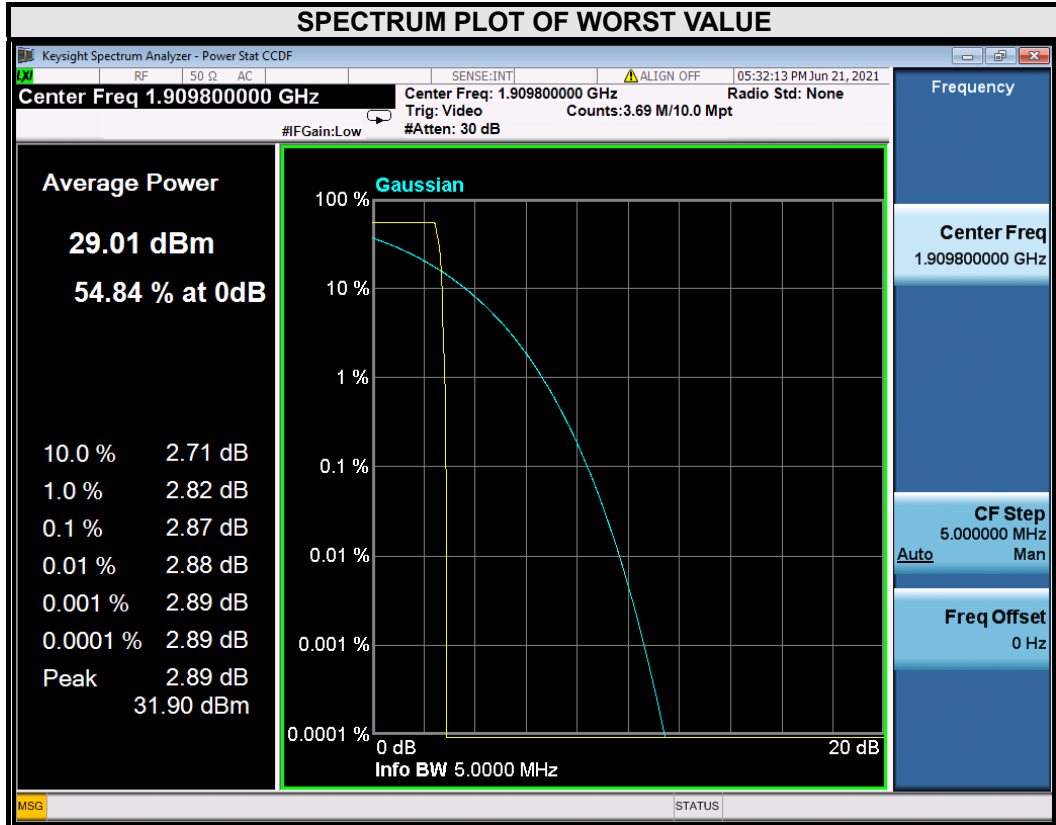



EDGE

CHANNEL	FREQUENCY (MHz)	PEAK TO AVERAGE RATIO (dB)
512	1850.2	6.02

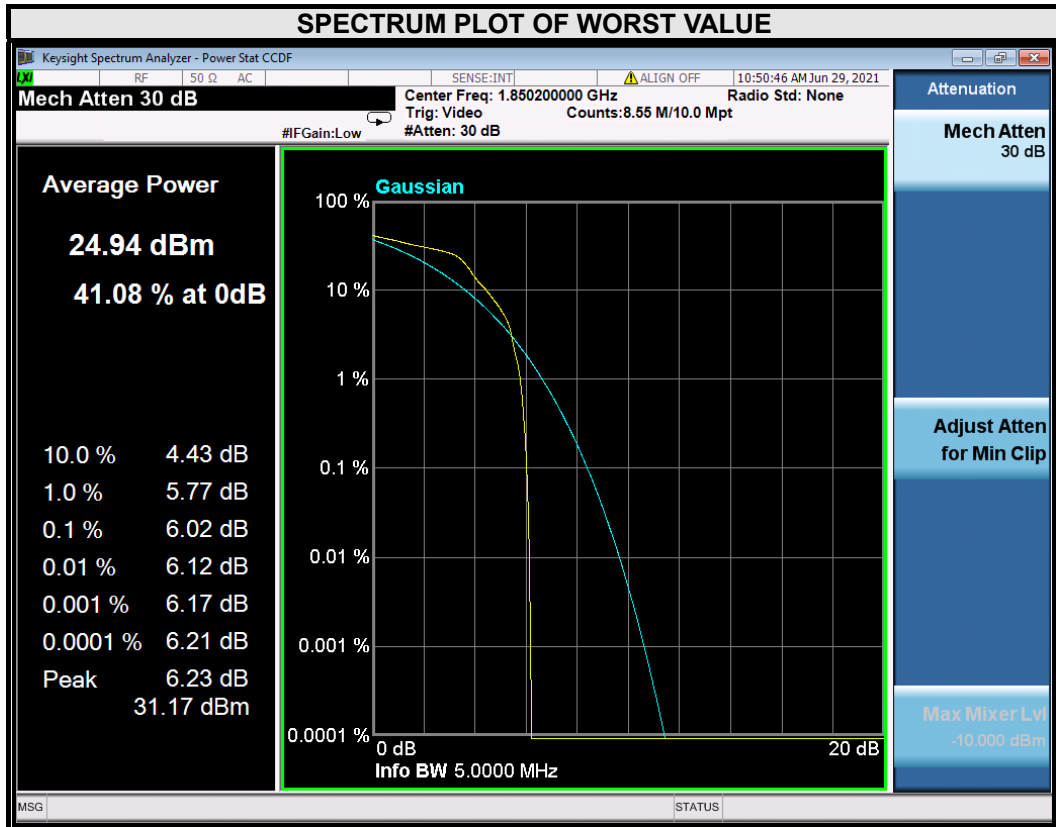



Test Report No.: W7L-P20210616-2RF05

CHANNEL	FREQUENCY (MHz)	PEAK TO AVERAGE RATIO (dB)
661	1880	6.01

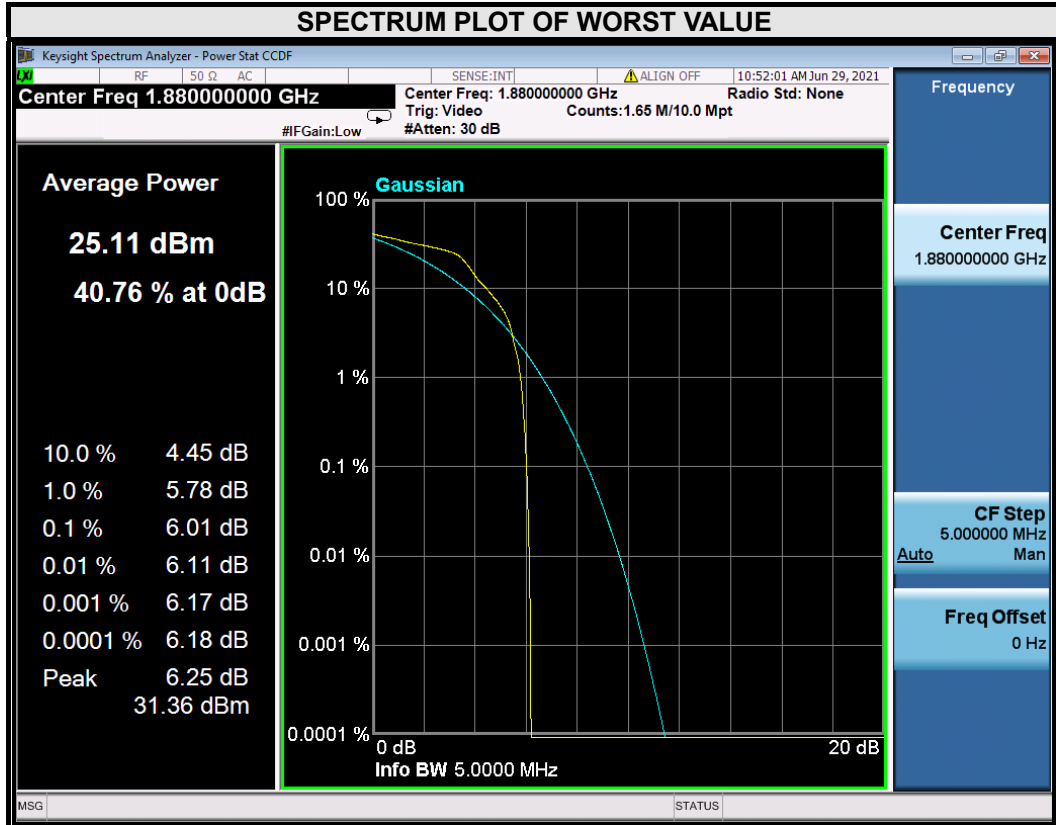



Test Report No.: W7L-P20210616-2RF05

CHANNEL	FREQUENCY (MHz)	PEAK TO AVERAGE RATIO (dB)
810	1909.8	5.92

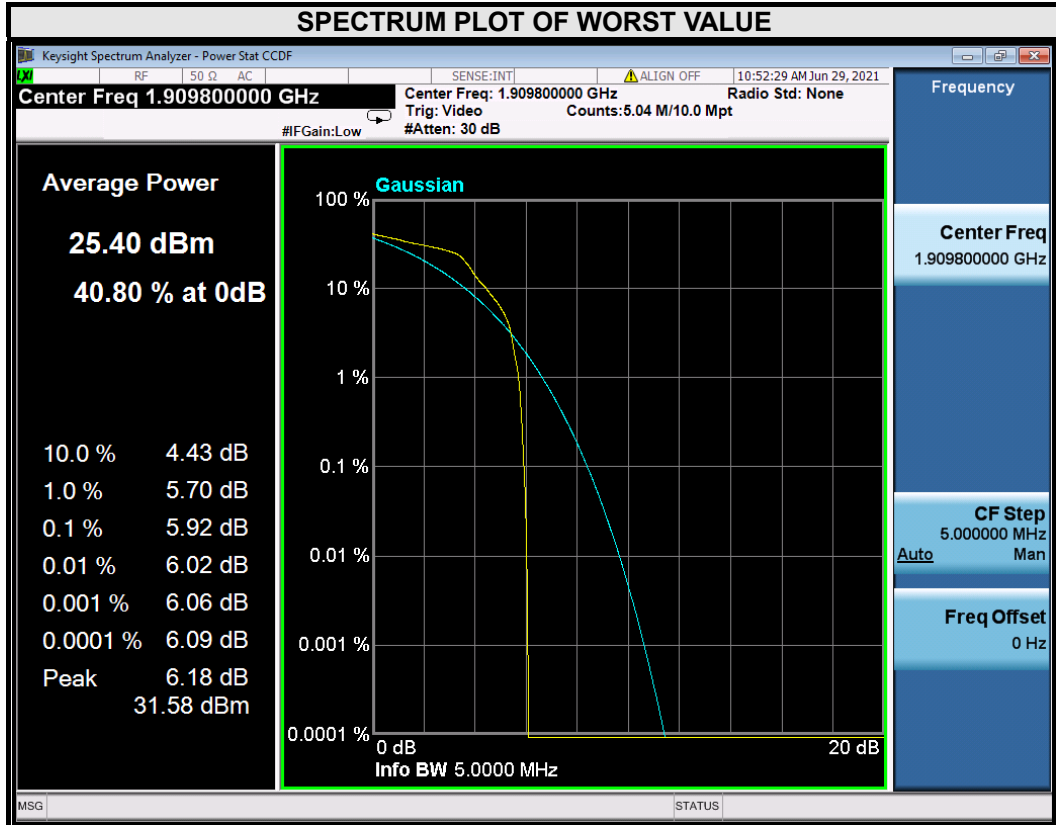

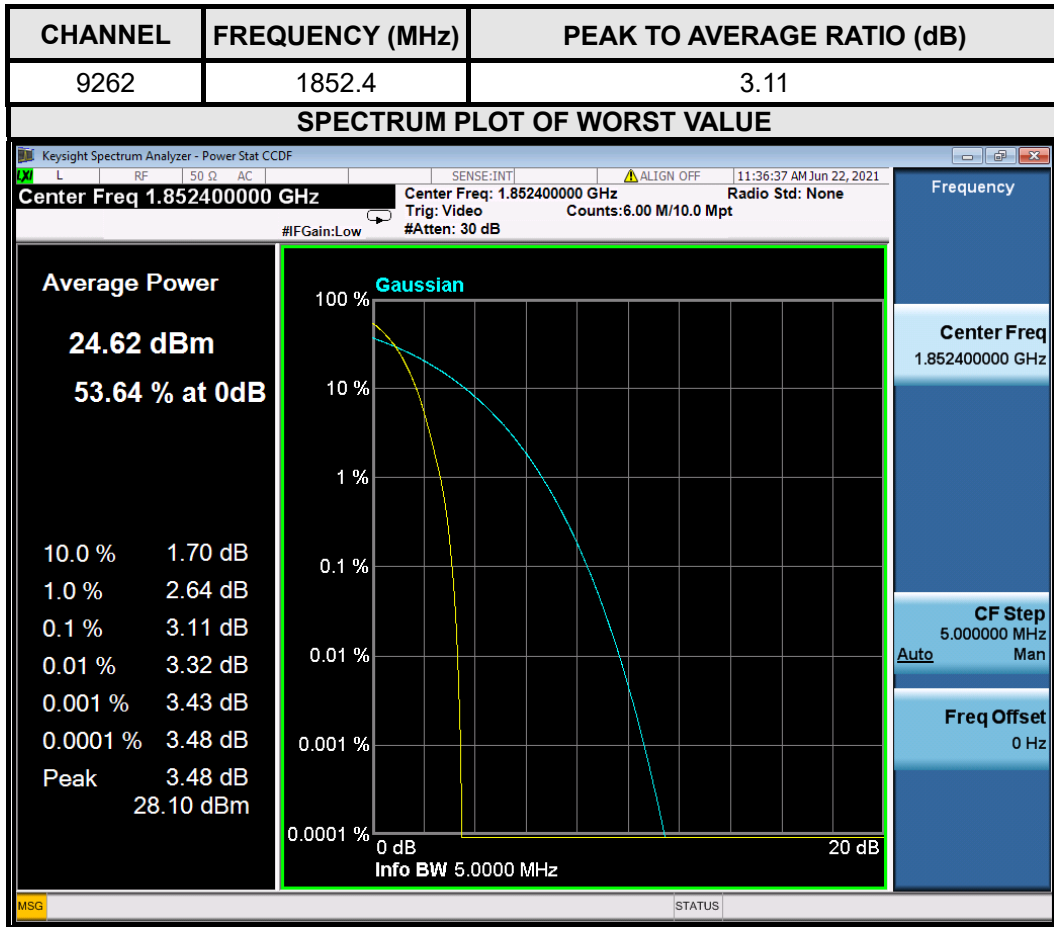



BUREAU VERITAS

Test Report No.: W7L-P20210616-2RF05

CHANNEL	FREQUENCY (MHz)	PEAK TO AVERAGE RATIO (dB)
9400	1880.0	2.98

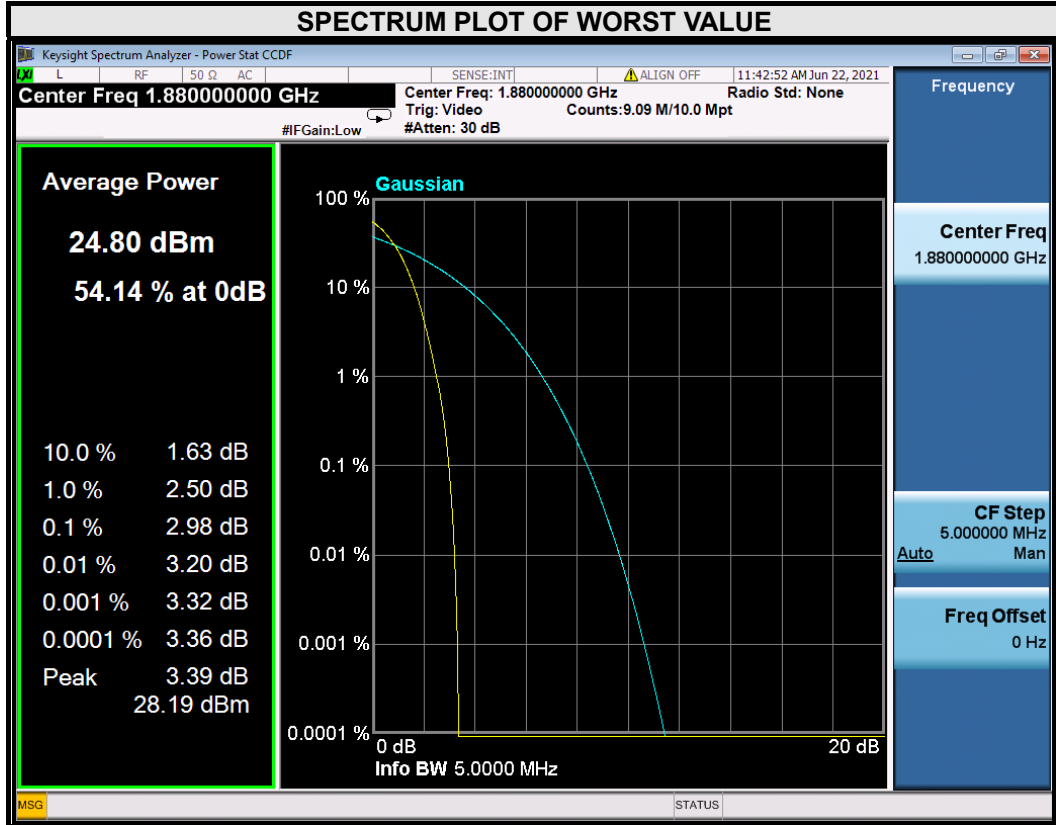



Test Report No.: W7L-P20210616-2RF05

CHANNEL	FREQUENCY (MHz)	PEAK TO AVERAGE RATIO (dB)
9538	1907.6	3.03

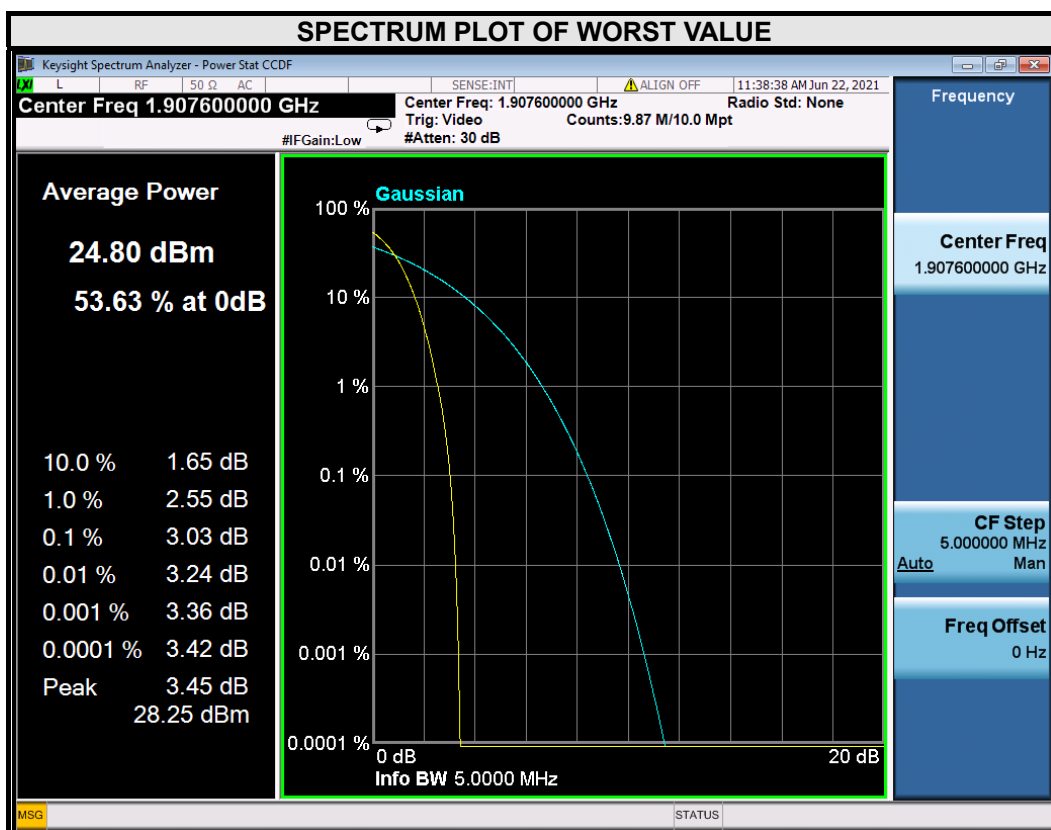



LTE BAND 2

CHANNEL BANDWIDTH: 1.4MHz			
CHANNEL	Frequency (MHz)	PEAK TO AVERAGE RATIO (dB)	
		QPSK	16QAM
18607	1850.7	4.75	5.56
18900	1880	5.30	5.98
19193	1909.3	5.28	6.15

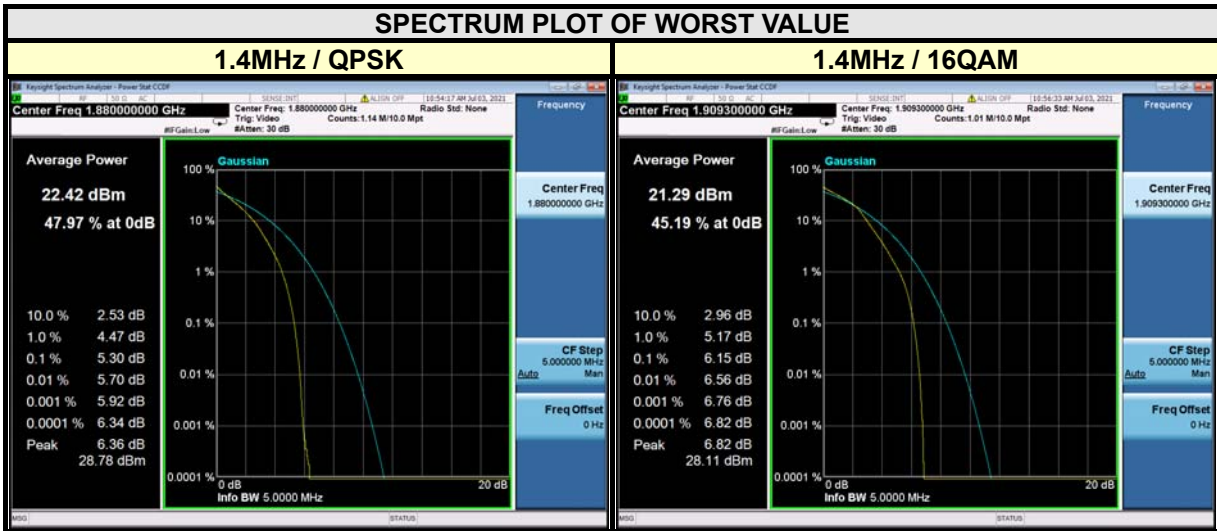



**BUREAU
VERITAS**

Test Report No.: W7L-P20210616-2RF05

CHANNEL BANDWIDTH: 3MHz			
CHANNEL	Frequency (MHz)	PEAK TO AVERAGE RATIO (dB)	
		QPSK	16QAM
18615	1851.5	4.80	5.61
18900	1880	5.33	6.03
19185	1908.5	5.40	6.22





**BUREAU
VERITAS**

Test Report No.: W7L-P20210616-2RF05

CHANNEL BANDWIDTH: 5MHz			
CHANNEL	Frequency (MHz)	PEAK TO AVERAGE RATIO (dB)	
		QPSK	16QAM
18625	1852.5	4.89	5.67
18900	1880	5.28	6.02
19175	1907.5	5.39	6.21

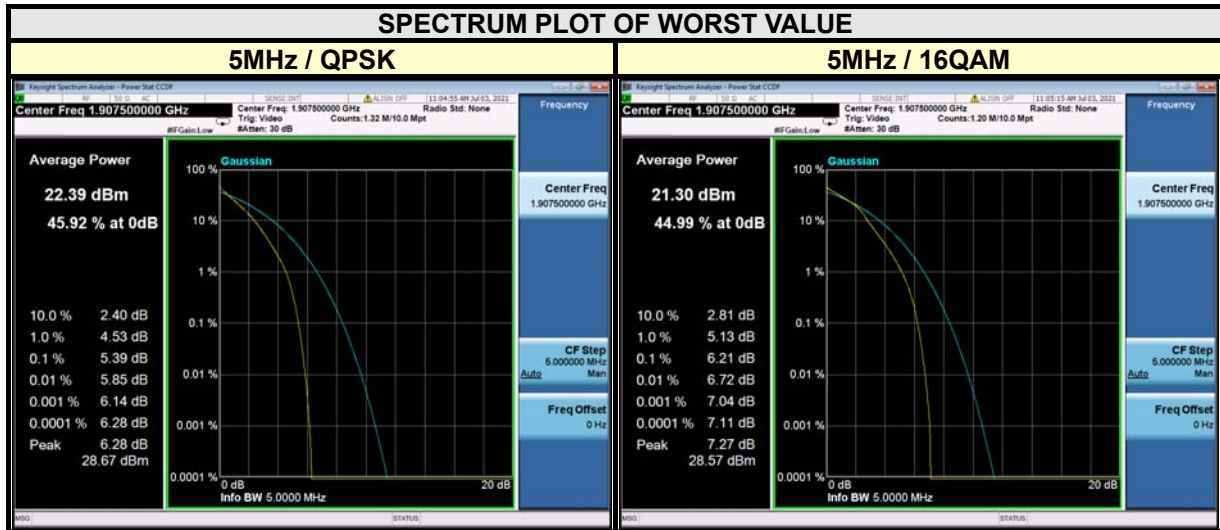



**BUREAU
VERITAS**

Test Report No.: W7L-P20210616-2RF05

CHANNEL BANDWIDTH: 10MHz			
CHANNEL	Frequency (MHz)	PEAK TO AVERAGE RATIO (dB)	
		QPSK	16QAM
18650	1855	4.74	5.54
18900	1880	5.22	6.06
19150	1905	5.35	6.21

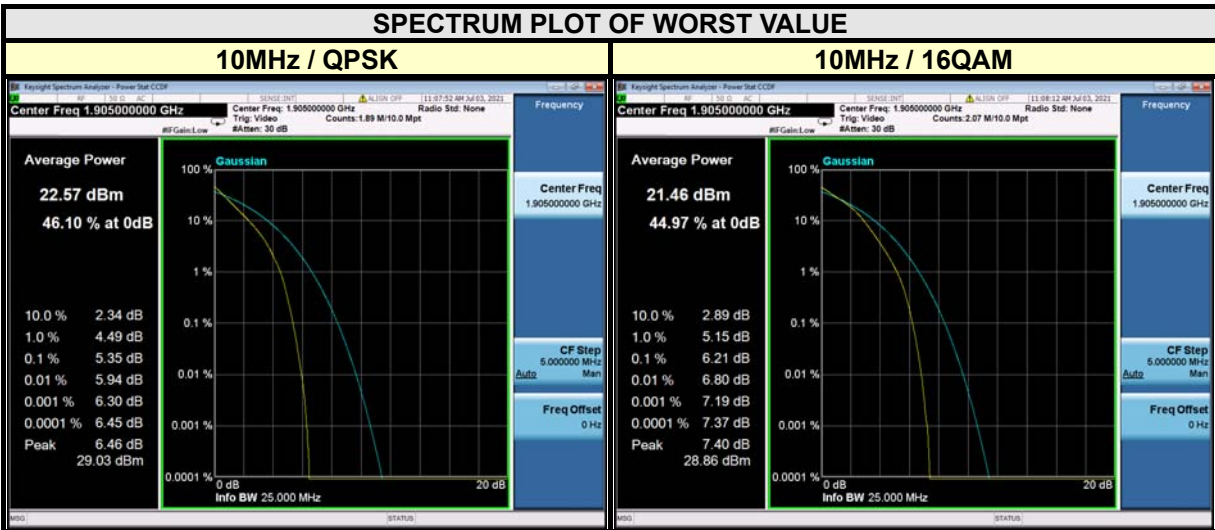



**BUREAU
VERITAS**

Test Report No.: W7L-P20210616-2RF05

CHANNEL BANDWIDTH: 15MHz			
CHANNEL	Frequency (MHz)	PEAK TO AVERAGE RATIO (dB)	
		QPSK	16QAM
18675	1857.5	5.09	5.72
18900	1880	5.34	6.02
19125	1902.5	5.52	6.25

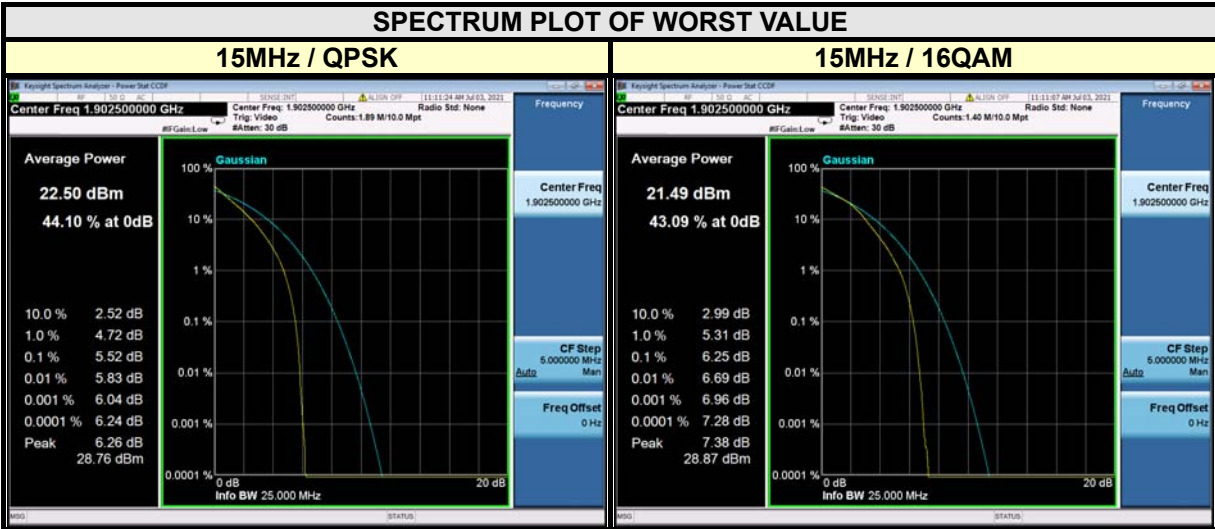



**BUREAU
VERITAS**

Test Report No.: W7L-P20210616-2RF05

CHANNEL BANDWIDTH: 20MHz			
CHANNEL	Frequency (MHz)	PEAK TO AVERAGE RATIO (dB)	
		QPSK	16QAM
18700	1860	5.02	5.78
18900	1880	5.09	5.94
19100	1900	5.37	6.16

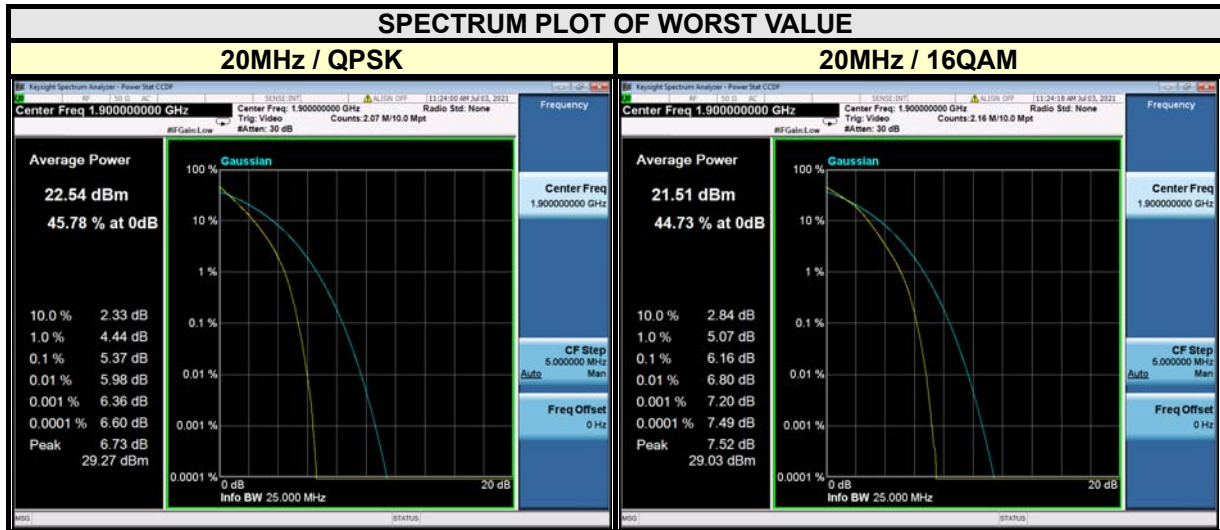



BUREAU
VERITAS

Test Report No.: W7L-P20210616-2RF05

4 INFORMATION ON THE TESTING LABORATORIES

We, BV 7LAYERS COMMUNICATIONS TECHNOLOGY (SHENZHEN) CO. LTD., were founded in 2015 to provide our best service in EMC, Radio, Telecom and Safety consultation. Our laboratories are accredited and approved according to ISO/IEC 17025.

If you have any comments, please feel free to contact us at the following:

Shenzhen EMC/RF Lab:

Tel: +86-755-88696566

Fax: +86-755-88696577

Email: customerservice.sw@bureauveritas.com

Web Site: www.adt.com.tw

The address and road map of all our labs can be found in our web site also.

5 APPENDIX A – MODIFICATIONS RECORDERS FOR ENGINEERING CHANGES TO THE EUT BY THE LAB

No any modifications are made to the EUT by the lab during the test.

---END---