

Report on the Radio Testing
For
Renishaw Plc
on
RMP40QE
Report no. TRA-046251-47-00B
2 April 2020

RF916 10.0



Report Number: TRA-046251-47-00B
Issue: B

REPORT ON THE RADIO TESTING OF A
Renishaw Plc
RMP40QE
WITH RESPECT TO SPECIFICATION
FCC 47CFR 15.247

TEST DATE: 21st November 2019 - 20th December 2019

Written by:

S Garwell, D Moncayola,
Radio Test Engineer

Approved by:

J Charters
Lab Manager

Date: 2 April 2020

Disclaimers:

- [1] THIS DOCUMENT MAY BE REPRODUCED ONLY IN ITS ENTIRETY AND WITHOUT CHANGE
- [2] THE RESULTS CONTAINED IN THIS DOCUMENT RELATE ONLY TO THE ITEM(S) TESTED

1 Revision Record

<i>Issue Number</i>	<i>Issue Date</i>	<i>Revision History</i>
A	29 January 2020	Original
B	2 April 2020	Typographical Corrections

2 Summary

TEST REPORT NUMBER: TRA-046251-47-00B

WORKS ORDER NUMBER: TRA-046254-00

PURPOSE OF TEST: USA: Testing of radio frequency equipment per the relevant authorization procedure of chapter 47 of CFR (code of federal regulations) Part 2, subpart J..

TEST SPECIFICATION(S): 47CFR15.247

EQUIPMENT UNDER TEST (EUT): RMP40QE

EQUIPMENT VARIANTS: RMP40MQE, RLP40QE, RLP40HQE

FCC IDENTIFIER: KQGRMP40QE

EUT SERIAL NUMBER: 1PUF52 Conducted
1PRQ12 Radiated

MANUFACTURER/AGENT: Renishaw Plc

ADDRESS: New Mills
Wotton Under Edge
Gloucestershire
GL12 8JR
United Kingdom

CLIENT CONTACT: Rich Warren
☎ 01453 523240
✉ richard.warren@renishaw.com

TEST DATE: 21st November 2019 - 20th December 2019

TESTED BY: S Garwell, D Moncayola
Element

2.1 Test Summary

Test Method and Description		Requirement Clause 47CFR15	Applicable to this equipment	Result / Note
Radiated spurious emissions (restricted bands of operation and cabinet radiation)		15.205	<input checked="" type="checkbox"/>	Pass Note 4
AC power line conducted emissions		15.207	<input type="checkbox"/>	Note 1
Carrier frequency separation		15.247(a)(1)	<input checked="" type="checkbox"/>	Pass Note 2
Number of hopping channels		15.247(a)(1) (i), (ii) and (iii)	<input checked="" type="checkbox"/>	Pass Note 2
Average time of occupancy		15.247(a)(1) (i), (ii) and (iii)	<input checked="" type="checkbox"/>	Pass Note 2
Maximum peak conducted output power		15.247 (a)(1), (b)(1) and (b)(2)	<input checked="" type="checkbox"/>	Pass Note 2
Conducted carrier power	Peak	15.247(b)(3)	<input type="checkbox"/>	Pass Note 3
	Max.		<input checked="" type="checkbox"/>	
Power spectral density, conducted		15.247(e)	<input checked="" type="checkbox"/>	Pass Note 3
20dB emission bandwidth		15.247(a)(1) (i) and (ii)	<input checked="" type="checkbox"/>	Pass Note 2
Occupied bandwidth		15.247(a)(2)	<input checked="" type="checkbox"/>	Pass Note 3
Out-of-band emissions		15.247(d)	<input checked="" type="checkbox"/>	Pass Note 4

Notes:

- 1 Not applicable EUT is battery powered
- 2 Applicable for Mode 1 and Mode 2 – FHSS Operation
- 3 Applicable for Mode 2 – DTS operation
- 4 Applicable for Mode 1 and Mode 2 (both FHSS and DTS Operation) EUT uses same modulation techniques for both FHSS and DTS operation

The results contained in this report relate only to the items tested, in the condition at time of test, and were obtained in the period between the date of initial receipt of samples and the date of issue of the report.

The apparatus was set up and exercised using the configurations, modes of operation and arrangements defined in this report only. Any modifications made are identified in Section 8 of this report.

Particular operating modes, apparatus monitoring methods and performance criteria required by the standards tested to have been performed except where identified in Section 5.2 of this test report (Deviations from Test Standards).

3 Contents

1	Revision Record	3
2	Summary	4
2.1	Test Summary	5
3	Contents	6
4	Introduction	8
5	Test Specifications	9
5.1	Normative References	9
5.2	Deviations from Test Standards	9
6	Glossary of Terms	10
7	Equipment Under Test	11
7.1	EUT Identification	11
7.2	Equipment Variants	11
7.3	System Equipment	11
7.4	EUT Mode of Operation	11
7.4.1	Transmission	11
7.5	EUT Radio Parameters	12
7.5.1	General	12
7.6	EUT Description	12
8	Modifications	13
9	EUT Test Setup	13
9.1	Block Diagram	13
9.2	General Set-up Photograph	14
9.3	Measurement software	14
10	General Technical Parameters	15
10.1	Normal Conditions	15
11	Radiated emissions	16
11.1	Definitions	16
11.2	Test Parameters	16
11.3	Test Limit	16
11.4	Test Method	17
11.5	Test Set-up Photographs	18
11.6	Test Equipment	18
11.7	Test Results – RMP40QE	19
11.8	Test Results – RMP40MQE	32
11.9	Test Results – RLP40QE	40
12	Carrier frequency separation	48
12.1	Definition	48
12.2	Test Parameters	48
12.3	Test Limit	48
12.4	Test Method	49
12.5	Test Equipment	49
12.6	Test Results	49
13	Number of hopping frequencies	51
13.1	Definition	51
13.2	Test Parameters	51
13.3	Test Limit	51
13.4	Test Method	52
13.5	Test Equipment	52
13.6	Test Results	52
14	Average channel occupancy	54
14.1	Definition	54
14.2	Test Parameters	54
14.3	Test Limit	54
14.4	Test Method	55
14.5	Test Equipment	55
14.6	Test Results	56
15	Maximum peak conducted output power	58
15.1	Definition	58
15.2	Test Parameters	58
15.3	Test Limit	59
15.4	Test Method	59
15.5	Test Equipment	59
15.6	Test Results	60
16	Power spectral density	62
16.1	Definition	62
16.2	Test Parameters	62

16.3	Test Limit	62
16.4	Test Method.....	63
16.5	Test Equipment	63
16.6	Test Results.....	64
17	Occupied Bandwidth.....	65
17.1	Definition.....	65
17.2	Test Parameters	65
17.3	Test Limit	65
17.4	Test Method.....	66
17.5	Test Equipment	66
17.6	Test Results.....	67
18	Out-of-band and conducted spurious emissions.....	70
18.1	Definition.....	70
18.2	Test Parameters	70
18.3	Test Limits	70
18.4	Test Method.....	71
18.5	Test Equipment	71
18.6	Test Results.....	72
19	Measurement Uncertainty.....	76
20	RF Exposure.....	77

4 Introduction

This report TRA-046251-47-00B presents the results of the Radio testing on a Renishaw Plc, RMP40QE to specification 47CFR15 Radio Frequency Devices.

The testing was carried out for Renishaw Plc by Element, at the address detailed below.

<input type="checkbox"/>	Element Hull Unit E South Orbital Trading Park Hedon Road Hull HU9 1NJ UK	<input checked="" type="checkbox"/>	Element Skelmersdale Unit 1 Pendle Place Skemersdale West Lancashire WN8 9PN UK
--------------------------	---	-------------------------------------	---

This report details the configuration of the equipment, the test methods used and any relevant modifications where appropriate.

All test and measurement equipment under the control of the laboratory and requiring calibration is subject to an established programme and procedures to control and maintain measurement standards. The quality management system meets the principles of ISO 9001, and has quality control procedures for monitoring the validity of tests undertaken. Records and sufficient detail are retained to establish an audit trail of calibration records relating to its test results for a defined period. Under control of the established calibration programme, key quantities or values of the test & measurement instrumentation are within specification and comply with the relevant traceable internationally recognised and appropriate standard specifications, which are UKAS calibrated as such where these properties have a significant effect on results. Participation in inter-laboratory comparisons and proficiency testing ensures satisfactory correlation of results conform to Elements own procedures, as well as statistical techniques for analysis of test data providing the appropriate confidence in measurements.

Throughout this report EUT denotes equipment under test.

FCC Site Listing:

Element is accredited for the above sites under the US-EU MRA, Designation number UK0009.

IC Registration Number(s):

Element Hull	3483A
Element North West	3930B

The test site requirements of ANSI C63.4-2014 are met up to 1GHz.

The test site SVSWR requirements of CISPR 16-1-4:2010 are met over the frequency range 1 GHz to 18 GHz.

5 Test Specifications

5.1 Normative References

- FCC 47 CFR Ch. I – Part 15 – Radio Frequency Devices.
- ANSI C63.10-2013 – American National Standard of Procedures for Compliance Testing of Unlicensed Wireless Devices.
- ANSI C63.4-2014 – American National Standard for Methods of Measurement of Radio-Noise Emissions from Low-Voltage Electrical and Electronic Equipment in the Range of 9 kHz to 40 GHz.

5.2 Deviations from Test Standards

There were no deviations from the test standard.

6 Glossary of Terms

§	denotes a section reference from the standard, not this document
AC	Alternating Current
ANSI	American National Standards Institute
BW	bandwidth
C	Celsius
CFR	Code of Federal Regulations
CW	Continuous Wave
dB	decibel
dBm	dB relative to 1 milliwatt
DC	Direct Current
DSSS	Direct Sequence Spread Spectrum
EIRP	Equivalent Isotropically Radiated Power
ERP	Effective Radiated Power
EUT	Equipment Under Test
FCC	Federal Communications Commission
FHSS	Frequency Hopping Spread Spectrum
Hz	hertz
IC	Industry Canada
ITU	International Telecommunication Union
LBT	Listen Before Talk
m	metre
max	maximum
MIMO	Multiple Input and Multiple Output
min	minimum
MRA	Mutual Recognition Agreement
N/A	Not Applicable
PCB	Printed Circuit Board
PDF	Portable Document Format
Pt-mpt	Point-to-multipoint
Pt-pt	Point-to-point
RF	Radio Frequency
RH	Relative Humidity
RMS	Root Mean Square
Rx	receiver
s	second
SVSWR	Site Voltage Standing Wave Ratio
Tx	transmitter
UKAS	United Kingdom Accreditation Service
V	volt
W	watt
Ω	ohm

7 Equipment Under Test

7.1 EUT Identification

- Name: RMP40QE
- Serial Number: 1PUF52 Conducted
1PRQ12 Radiated
- Model Number: RMP40MQE
- Serial number: 25MK49 (Radiated sample)
- Model Number: RLP40QE
- Serial number: 25KT65 (Radiated sample)

7.2 Equipment Variants

- RMP40QE
- RMP40MQE
- RLP40QE and RLP40HQE

7.3 System Equipment

Equipment listed below forms part of the overall test setup and is required for equipment functionality and/or monitoring during testing. The compliance levels achieved in this report relate only to the EUT and not items given in the following list.

Not Applicable – No support/monitoring equipment required.

7.4 EUT Mode of Operation

7.4.1 Transmission

The mode of operation for Tx tests was as follows.

The EUT contains selections for test menus for Mode 1 or Mode 2 and selection of normal operation.

These test menus allow the unit to be set to top, middle or bottom frequencies or hopping across all frequencies in either Mode 1 or Mode 2.

7.5 EUT Radio Parameters

7.5.1 General

Frequency of operation:	2400 MHz-2483.5 MHz
Modulation type(s):	Mode 1: 1 MBps Binary GFSK Frequency Hopping Mode 2: 2 MBps Binary GFSK Frequency Hopping Mode 2: 2 MBps Binary GFSK DSSS
Occupied channel bandwidth(s):	Mode 1: 1 MHz Mode 2: 2 MHz
Channel spacing:	Mode 1: 1 MHz Mode 2: 2 MHz
Declared output power(s):	Mode 1: 0dBm Mode 2: +4dBm
Nominal Supply Voltage:	3.0 Vdc
Antenna Type and Gain:	Slot type. -0.82dBi

7.6 EUT Description

The EUT is a measuring probe, using the 2400 MHz - 2483.5 MHz frequency band, and uses frequency hopping.

Mode 1 uses FHSS operating over 79 channels.

Mode 2 uses DTS and FHSS over 39 channels. DTS mode is used during setup and FHSS mode in probe operation.

8 Modifications

No modifications were performed during this assessment.

9 EUT Test Setup

9.1 Block Diagram

The following diagram shows basic EUT interconnections with cable type and cable lengths

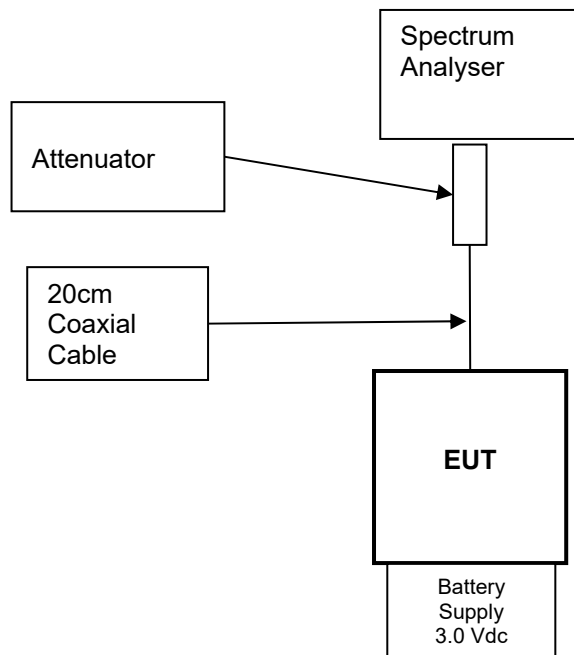

identified:

9.2 General Set-up Photograph

The following photograph shows basic EUT set-up:

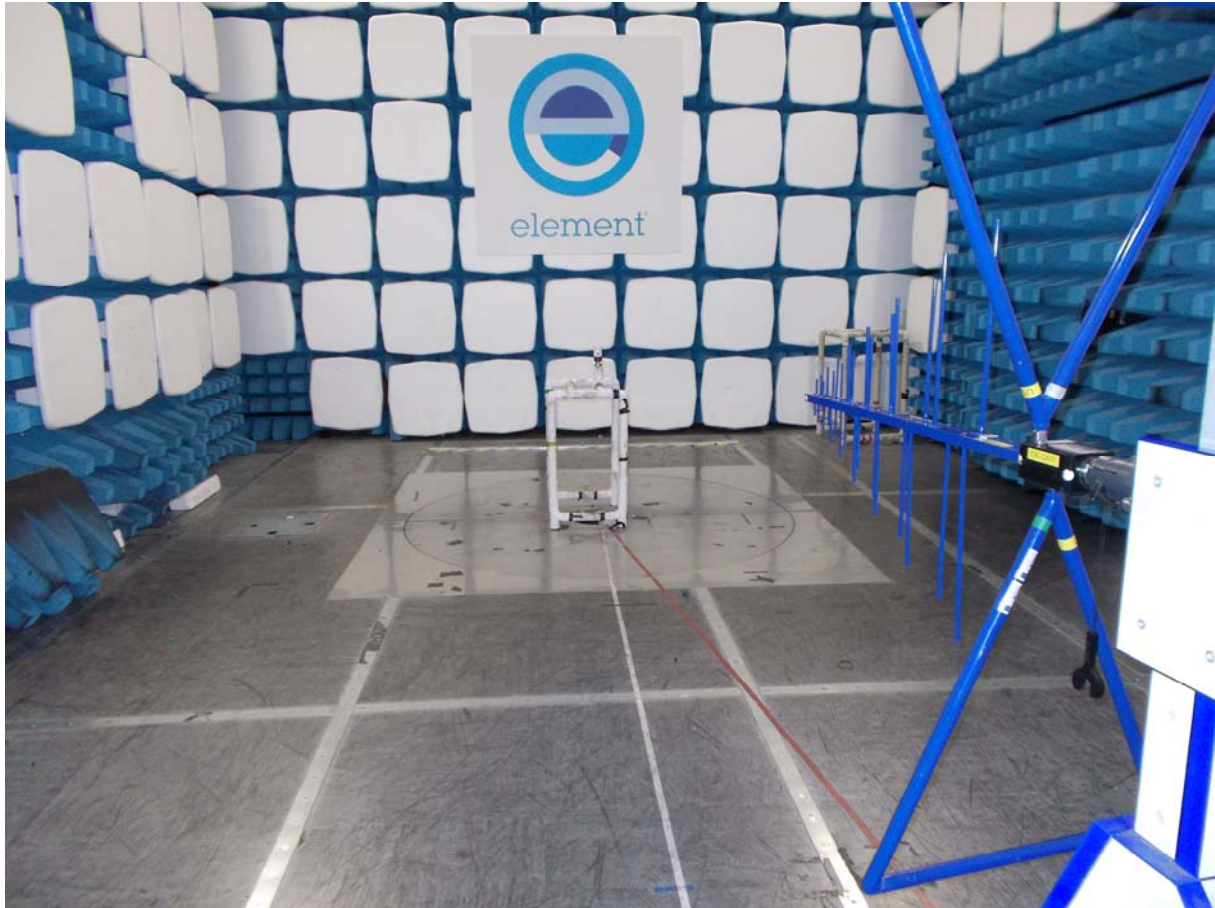

9.3 Measurement software

Where applicable, the following software was used to perform measurements contained within this report.

Element Emissions R5 (See Note)
Element Transmitter Bench Test (See Note)
ETS Lindgren EMPower V1.0.4.2

Note:

The version of the Element software used is recorded in the results sheets contained within this report.

10 General Technical Parameters

10.1 Normal Conditions

The E U T was tested under the normal environmental conditions of the test laboratory, except where otherwise stated. The normal power source applied was approx. 3 Vdc from alkaline batteries

Varying Test Conditions

There are no specific frequency stability requirements for the type of device. The results contained in this report demonstrate that the occupied bandwidth is contained within the authorised band and the manufacturer has declared sufficient frequency stability (refer to section 7.4).

Variation of supply voltage is required to ensure stability of the declared output power. During carrier power testing the following variations were made:

	Category	Nominal	Variation
<input type="checkbox"/>	Mains	110 V ac +/-2 %	85 % and 115 %
<input checked="" type="checkbox"/>	Battery	New battery	N/A

11 Radiated emissions

11.1 Definitions

Spurious emissions

Emissions on a frequency or frequencies, which are outside the necessary bandwidth and the level of which may be reduced without affecting the corresponding transmission of information. Spurious emissions include harmonic emissions, parasitic emissions, intermodulation products and frequency conversion products, but exclude out-of-band emissions.

Restricted bands

A frequency band in which intentional radiators are permitted to radiate only spurious emissions but not fundamental signals.

11.2 Test Parameters

Test Location:	Element Skelmersdale
Test Chamber:	Chamber 3
Test Standard and Clause:	ANSI C63.10-2013, Clause 6.5 and 6.6
EUT Channels Measured:	Low / Mid / High
EUT Channel Bandwidths:	1 MHz / 2 MHz
Deviations From Standard:	None
Measurement BW:	30 MHz to 1 GHz: 120 kHz; Above 1 GHz: 1 MHz
Measurement Detector:	Up to 1 GHz: quasi-peak; Above 1 GHz: RMS average and Peak

Environmental Conditions (Normal Environment)

Temperature: 23 °C	+15 °C to +35 °C (as declared)
Humidity: 39 % RH	20 % RH to 75 % RH (as declared)
Supply: 3 V dc	

11.3 Test Limit

Unwanted emissions that fall within the restricted frequency bands shall comply with the limits specified:

General Field Strength Limits for License-Exempt Transmitters at Frequencies above 30 MHz

<i>Frequency (MHz)</i>	<i>Field Strength (μV/m at 3 m)</i>
30 to 88	100
88 to 216	150
216 to 960	200
Above 960	500

11.4 Test Method

With the EUT setup as per section 9 of this report and connected as per Figure i, the emissions from the EUT were measured on a spectrum analyzer / EMI receiver.

Radiated electromagnetic emissions from the EUT are checked first by preview scans. Preview scans for all spectrum and modulation characteristics are checked, using a peak detector and where applicable worst-case determined for function, operation, orientation, etc. for both vertical and horizontal polarisations. Pre-scan plots are shown with a peak detector and 100 kHz RBW.

If the EUT connects to auxiliary equipment and is table or floor standing, the configurations prescribed in ANSI C63.10 are followed. Alternatively, a layout closest to normal use (as declared by the provider) is employed, (see EUT setup photographs for more detail).

Emissions between 30 MHz and 1 GHz are measured using calibrated broadband antennas. Emissions above 1 GHz are characterized using standard gain horn antennas. Pre-amplifiers and filters are used where required. Care is taken to ensure that test receiver resolution bandwidth, video bandwidth and detector type(s) meet the regulatory requirements.

For both horizontal and vertical polarizations, the EUT is then rotated through 360 degrees in azimuth until the highest emission is detected. At the previously determined azimuth the test antenna is raised and lowered from 1 to 4 m in height until a maximum emission level is detected, this maximum value is recorded.

Power values measured on the test receiver / analyzer are converted to field strength, FS, in dB μ V/m at the regulatory distance, using:

$$FS = PR + CL + AF - PA + DC - CF$$

Where,

- PR is the power recorded on the receiver / spectrum analyzer in dB μ V;
- CL is the cable loss in dB;
- AF is the test antenna factor in dB/m;
- PA is the pre-amplifier gain in dB (where used);
- DC is the duty correction factor in dB (where used, e.g. harmonics of pulsed fundamental);
- CF is the distance factor in dB (where measurement distance different to limit distance);

This field strength value is then compared with the regulatory limit.

Figure i Test Setup

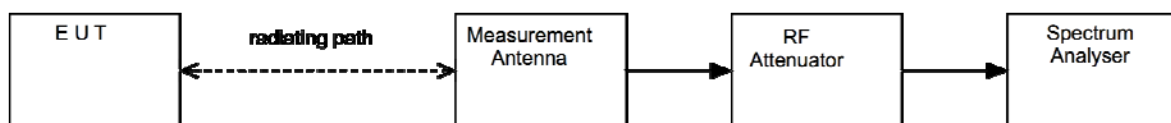

11.5 Test Set-up Photographs

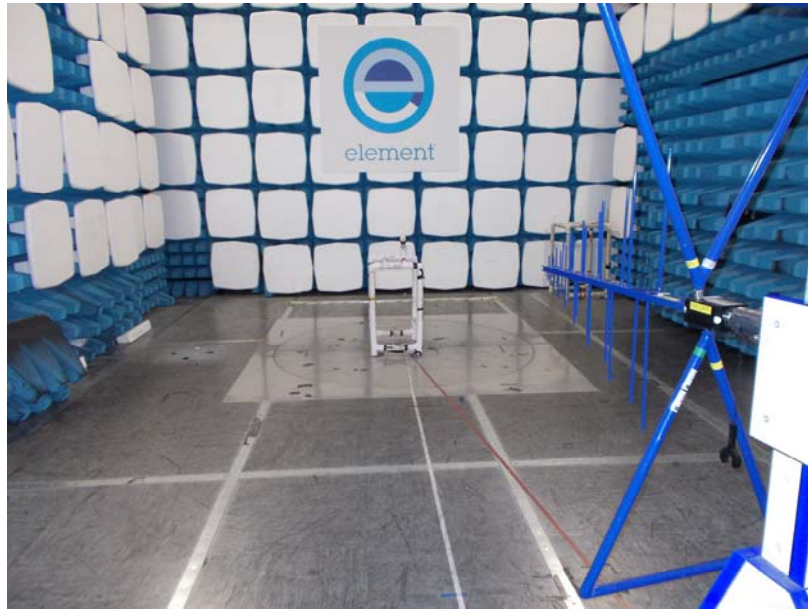

11.6 Test Equipment

<i>Equipment Description</i>	<i>Manufacturer</i>	<i>Equipment Type</i>	<i>Element No</i>	<i>Due For Calibration</i>
Spectrum Analyser	R&S	FSU26	REF909	2020-06-21
Bilog	Chase	CBL611/A	U573	2021-09-19
Log Periodic Ant	Chase	UPA6108	L203	2020-06-11
PreAmp	Watkins Johnson	6201-69	U372	2020-02-25
8449B	Agilent	Pre Amp	L572	2020-10-15
1-18GHz Horn	EMCO	3115	L139	2021-07-16

11.7 Test Results – RMP40QE

Duty cycle correction Mode 1

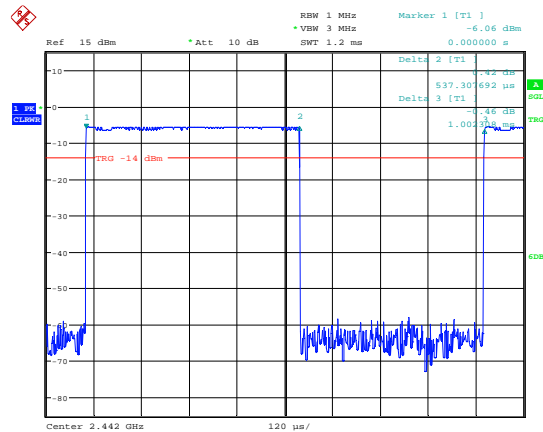

Date: 1.JAN.2003 01:04:39

$$\text{Duty Cycle Correction} = 20 \log (1/D) = 20 \log (T/T_{on}) = 5.2$$

Where D is the duty cycle = T_{on}/T

Duty cycle correction Mode 2

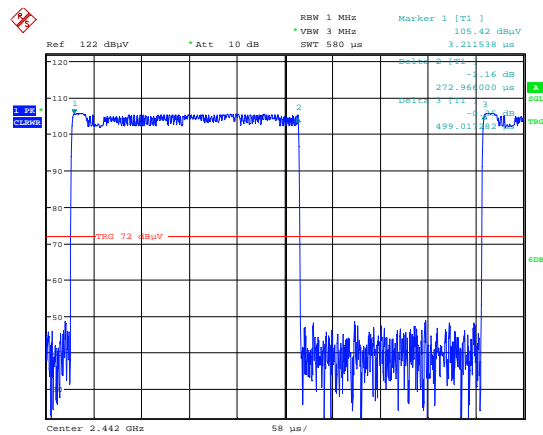

Date: 1.JAN.2003 04:46:32

$$\text{Duty Cycle Correction} = 20 \log (1/D) = 20 \log (T/T_{on}) = 5.2$$

Where D is the duty cycle = T_{on}/T

2403 MHz – 1 Mbps

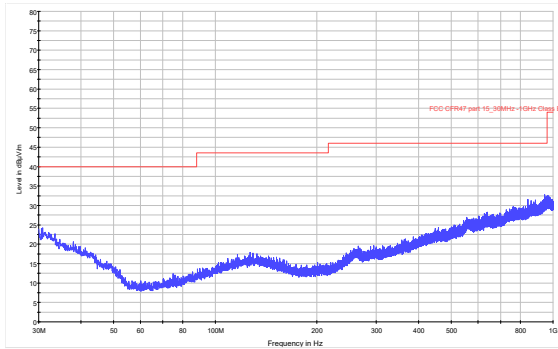

30 MHz to 1 GHz

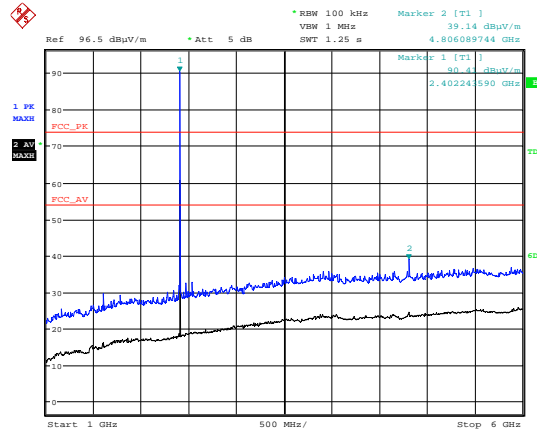

Date: 6.DEC.2019 17:05:56

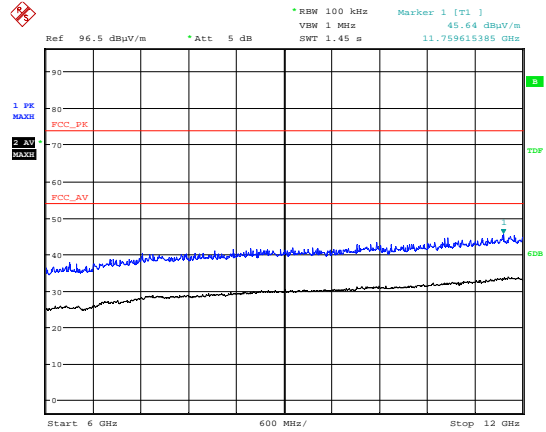

Date: 6.DEC.2019 17:05:03

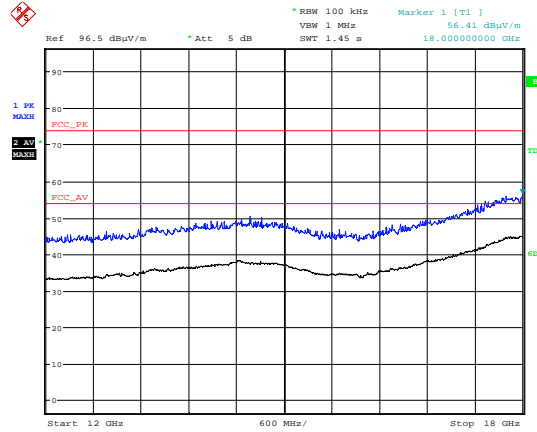

Date: 6.DEC.2019 17:04:19

6 GHz to 12 GHz

12 GHz to 18 GHz

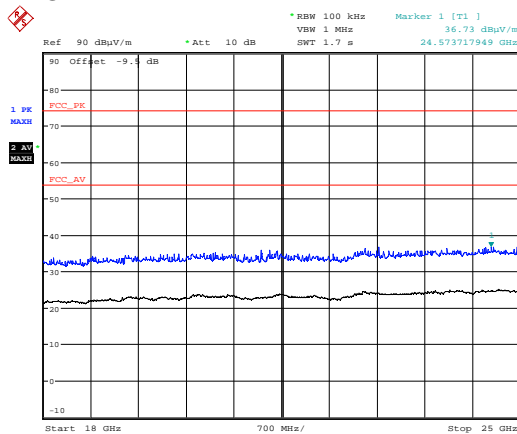

Date: 9.DEC.2019 11:11:12

18 GHz to 25 GHz

High Power; Channel: 2403 MHz										
Detector	Freq. (MHz)	Measure d Emission (dBμV/m)	Cable Loss (dB)	Antenna Factor (dB/m)	Pre-amp Gain (dB)	Duty Cycle Correction (dB)	Extrap'n Factor (dB)	Field Strength (dBμV/m)	Field Strength (μV/m)	Limit (μV/m)
Pk	4806.00	47.60	4.30	32.80	35.45	0.00	0.00	49.25	290.07	5000
Av	4806.00	38.10	4.30	32.80	35.45	5.50	0.00	45.25	183.02	500

Note: 7209 MHz is not in a restricted band. 20 dB below the carrier limit apply.

2442 MHz – 1 Mbps

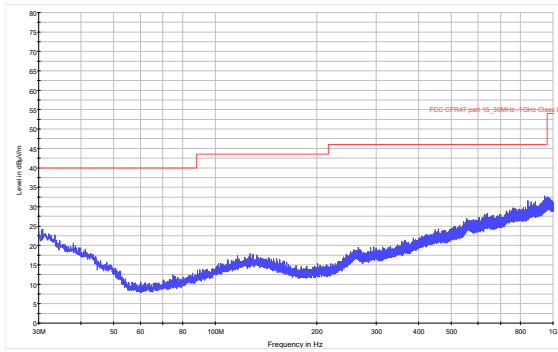

30 MHz to 1 GHz

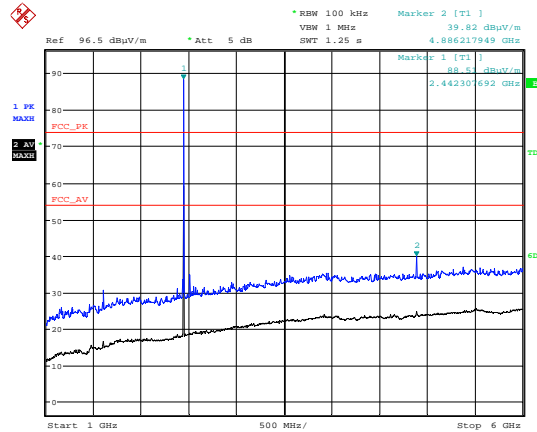

Date: 6.DEC.2019 17:27:39

1 GHz to 6 GHz

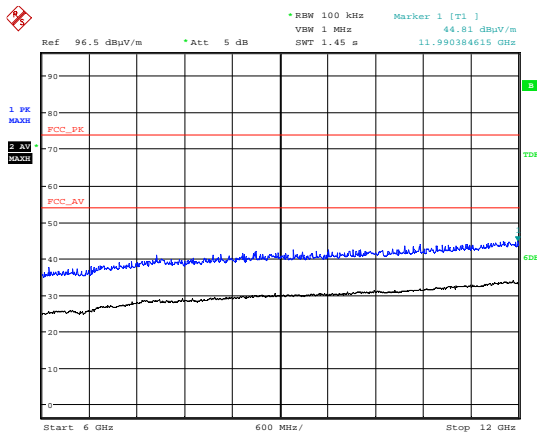

Date: 6.DEC.2019 17:28:35

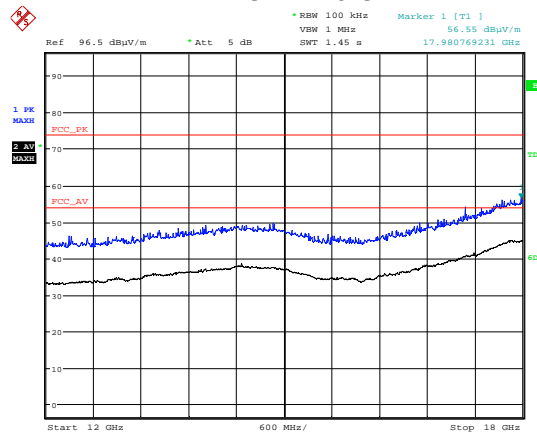

Date: 6.DEC.2019 17:29:27

6 GHz to 12 GHz

12 GHz to 18 GHz

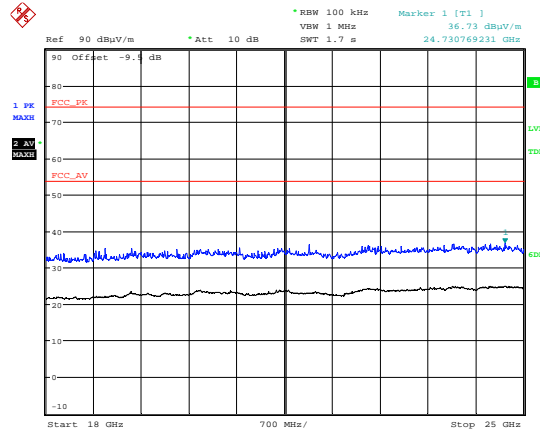

Date: 9.DEC.2019 11:15:38

18 GHz to 25 GHz

High Power; Channel: 2442 MHz										
Detector	Freq. (MHz)	Measure d Emission (dBμV/m)	Cable Loss (dB)	Antenna Factor (dB/m)	Pre-amp Gain (dB)	Duty Cycle Correction (dB)	Extrap'n Factor (dB)	Field Strength (dBμV/m)	Field Strength (μV/m)	Limit (μV/m)
Pk	4884.00	48.57	4.30	32.90	35.45	0.00	0.00	50.32	328.10	5000
Av	4884.00	37.29	4.30	32.90	35.45	5.50	0.00	44.54	168.66	500
Pk	7326.00	46.94	5.30	36.50	35.68	0.00	0.00	53.06	449.78	5000
Av	7326.00	33.77	5.30	36.50	35.68	5.50	0.00	45.39	185.99	500

2481 MHz – 1 Mbps

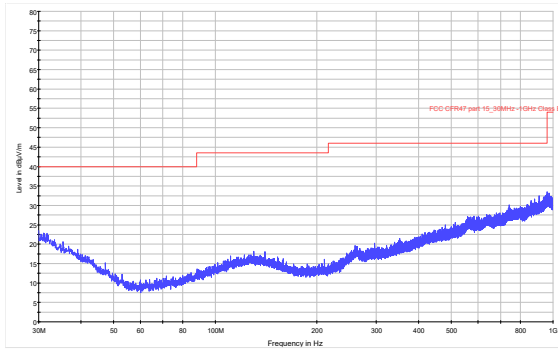

30 MHz to 1 GHz

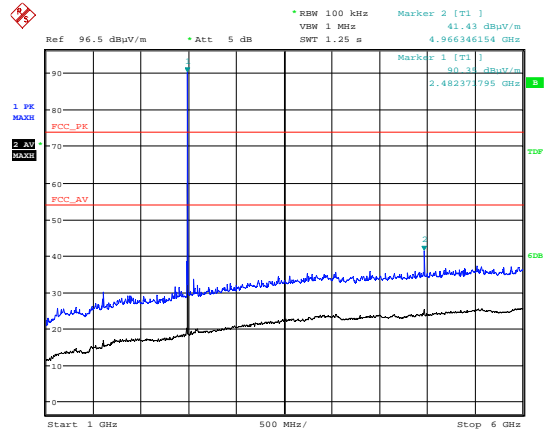

Date: 6.DEC.2019 17:58:37

1 GHz to 6 GHz

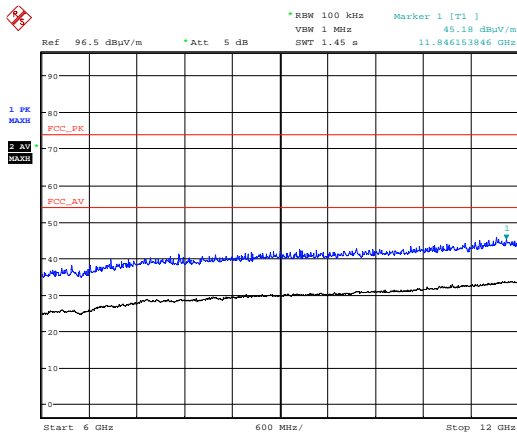

Date: 6.DEC.2019 17:57:11

6 GHz to 12 GHz

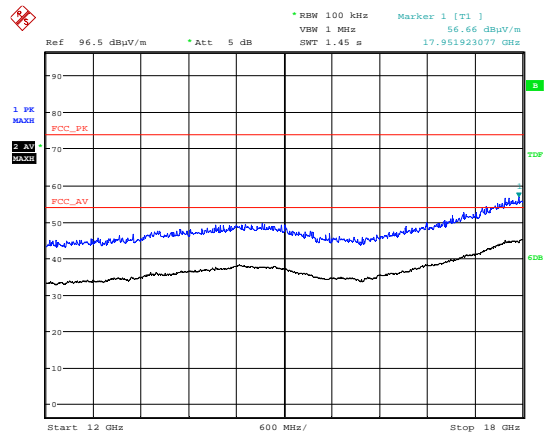

Date: 6.DEC.2019 17:55:51

12 GHz to 18 GHz

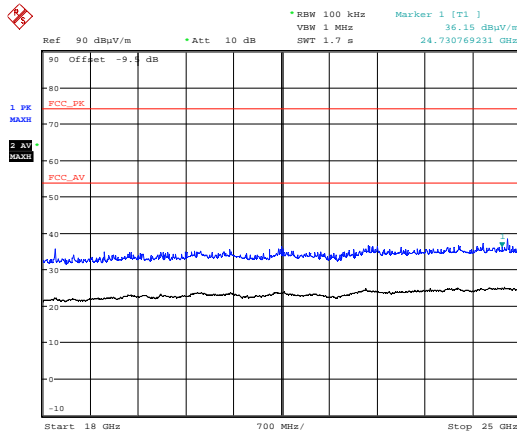

Date: 9.DEC.2019 11:17:12

18 GHz to 25 GHz

High Power; Channel: 2481 MHz										
Detector	Freq. (MHz)	Measure d Emission (dBμV/m)	Cable Loss (dB)	Antenna Factor (dB/m)	Pre-amp Gain (dB)	Duty Cycle Correction (dB)	Extrap'n Factor (dB)	Field Strength (dBμV/m)	Field Strength (μV/m)	Limit (μV/m)
Pk	4962.00	48.79	4.30	33.10	35.44	0.00	0.00	50.75	344.75	5000
Av	4962.00	39.03	4.30	33.10	35.44	5.50	0.00	46.49	211.11	500
Pk	7443.00	45.70	5.40	36.60	35.70	0.00	0.00	52.00	398.11	5000
Av	7443.00	32.34	5.40	36.60	35.70	5.50	0.00	44.14	161.06	500

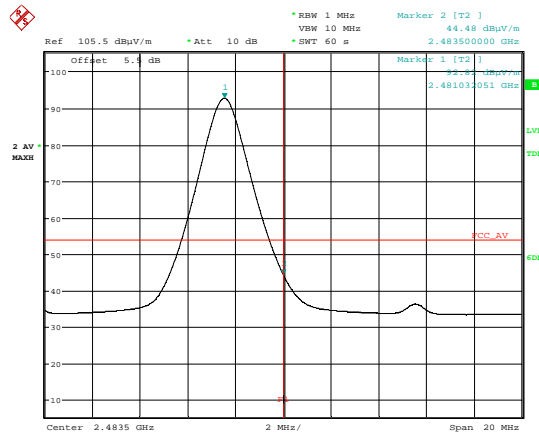
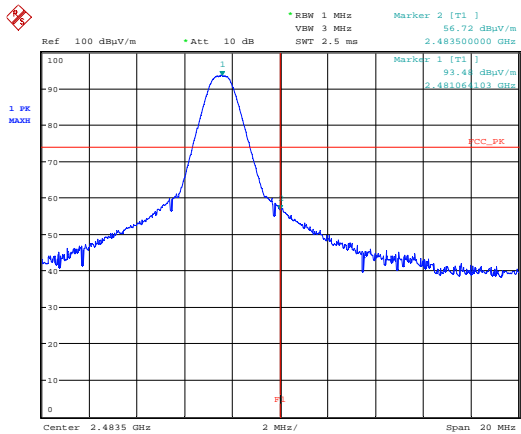

Date: 9.DEC.2019 09:03:08

Date: 9.DEC.2019 09:01:57

2481 MHz Upper Band Edge Plot – Peak

2481 MHz Upper Band Edge Plot – Average

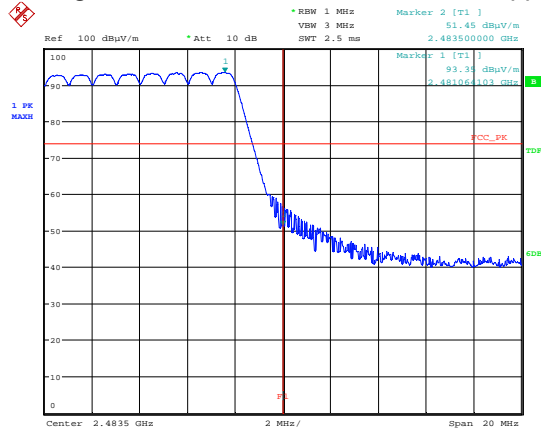

Date: 9.DEC.2019 09:11:37

2481 MHz Upper Band Edge Hopping Plot – Peak

2404 MHz – 2 Mbps

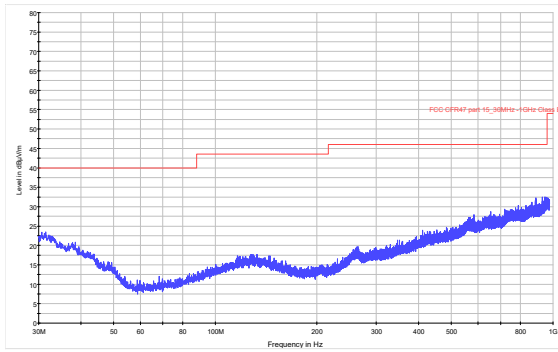

30 MHz to 1 GHz

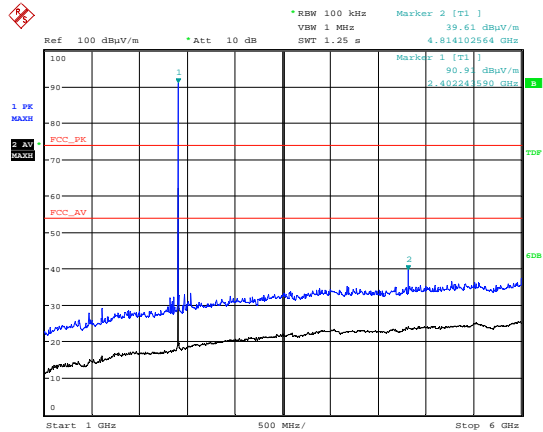

Date: 6.DEC.2019 18:50:59

1 GHz to 6 GHz

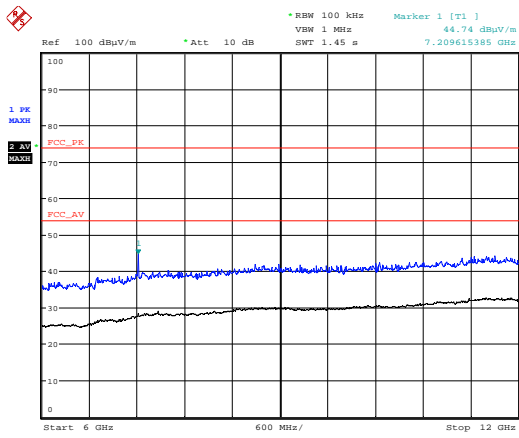

Date: 6.DEC.2019 18:52:12

6 GHz to 12 GHz

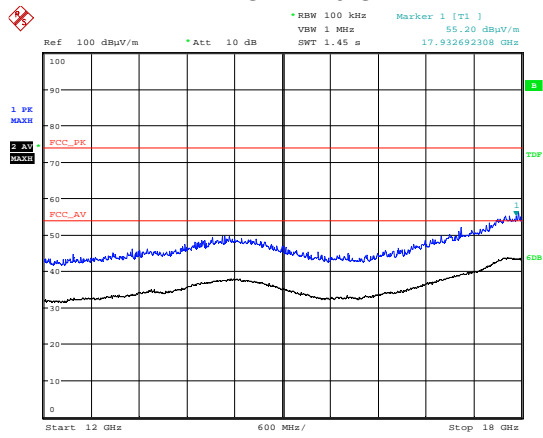

Date: 6.DEC.2019 18:53:19

12 GHz to 18 GHz

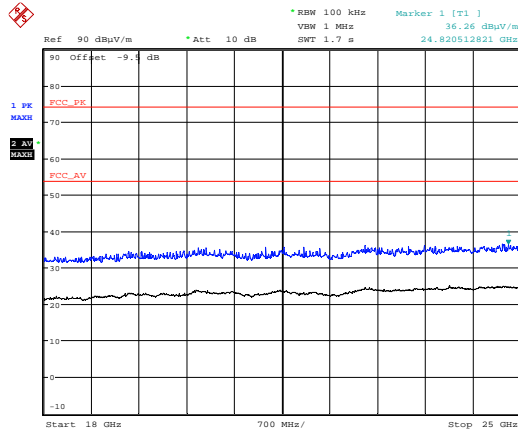

Date: 9.DEC.2019 11:05:07

18 GHz to 25 GHz

High Power; Channel: 2404 MHz										
Detector	Freq. (MHz)	Measure d Emission (dBμV/m)	Cable Loss (dB)	Antenna Factor (dB/m)	Pre-amp Gain (dB)	Duty Cycle Correction (dB)	Extrap'n Factor (dB)	Field Strength (dBμV/m)	Field Strength (μV/m)	Limit (μV/m)
Pk	4806.00	47.53	4.30	32.80	35.45	0.00	0.00	49.18	287.74	5000
Av	4806.00	36.20	4.30	32.80	35.45	5.50	0.00	43.35	147.06	500

Note: 7212 MHz is not in a restricted band. 20 dB below the carrier limit apply.

2442 MHz – 2 Mbps

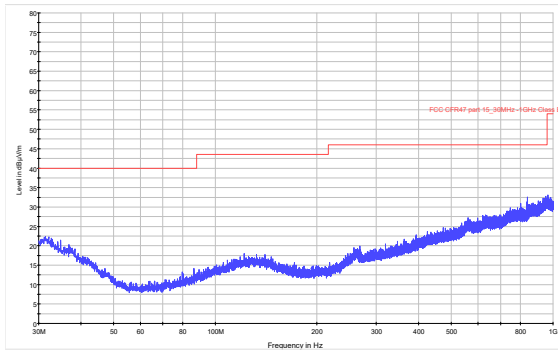

30 MHz to 1 GHz

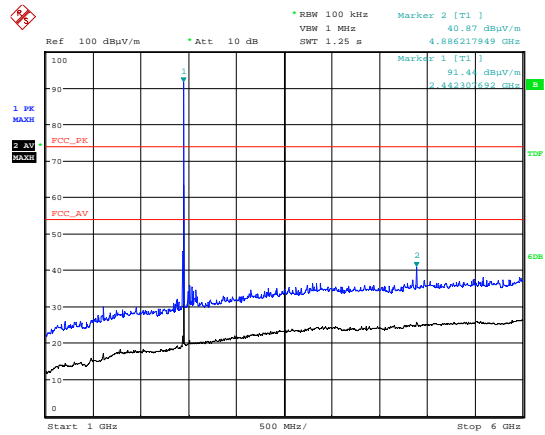

Date: 6.DEC.2019 19:09:52

1 GHz to 6 GHz

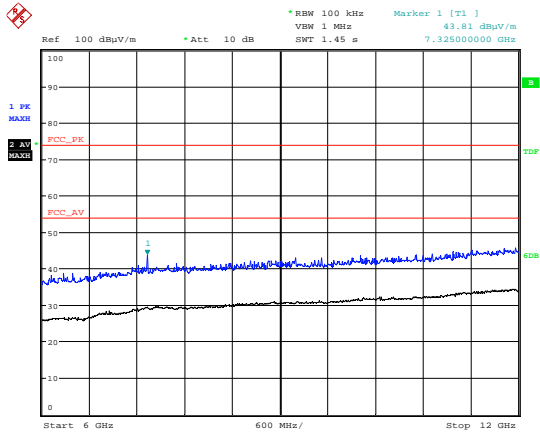

Date: 6.DEC.2019 19:10:37

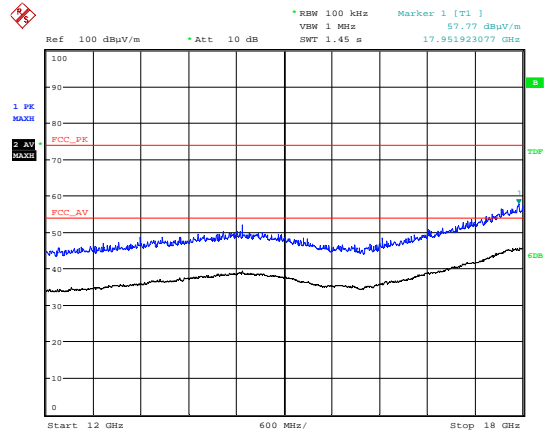

Date: 6.DEC.2019 19:11:39

6 GHz to 12 GHz

12 GHz to 18 GHz

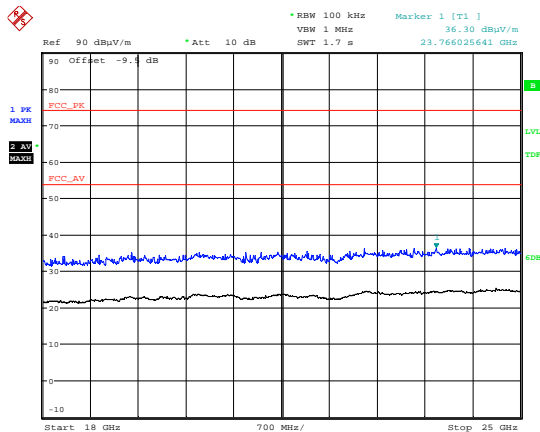

Date: 9.DEC.2019 11:04:27

18 GHz to 25 GHz

High Power; Channel: 2442 MHz										
Detector	Freq. (MHz)	Measured Emission (dBμV/m)	Cable Loss (dB)	Antenna Factor (dB/m)	Pre-amp Gain (dB)	Duty Cycle Correction (dB)	Extrap'n Factor (dB)	Field Strength (dBμV/m)	Field Strength (μV/m)	Limit (μV/m)
Pk	4884.00	48.42	4.30	32.90	35.45	0.00	0.00	50.17	322.48	5000
Av	4884.00	37.32	4.30	32.90	35.45	5.50	0.00	44.57	169.24	500
Pk	7326.00	47.59	5.30	36.50	35.68	0.00	0.00	53.71	484.73	5000
Av	7326.00	34.15	5.30	36.50	35.68	5.50	0.00	45.77	194.31	500

2480 MHz – 2 Mbps

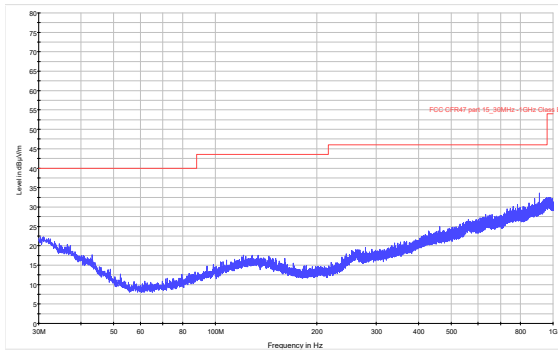

30 MHz to 1 GHz

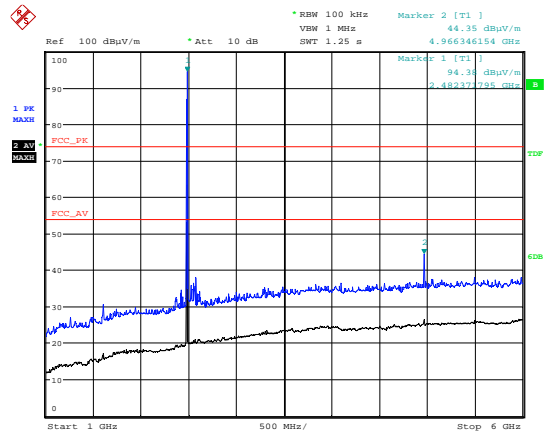

Date: 9.DEC.2019 08:26:04

1 GHz to 6 GHz

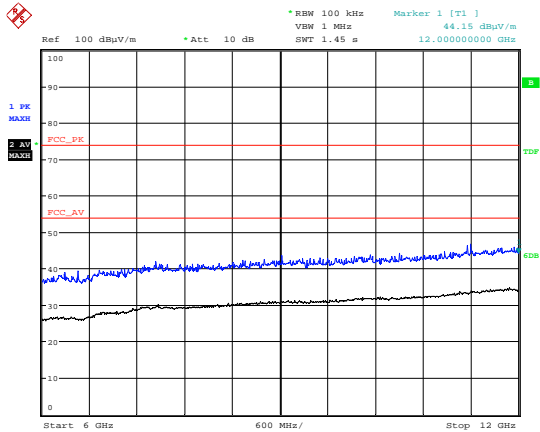

Date: 9.DEC.2019 08:24:51

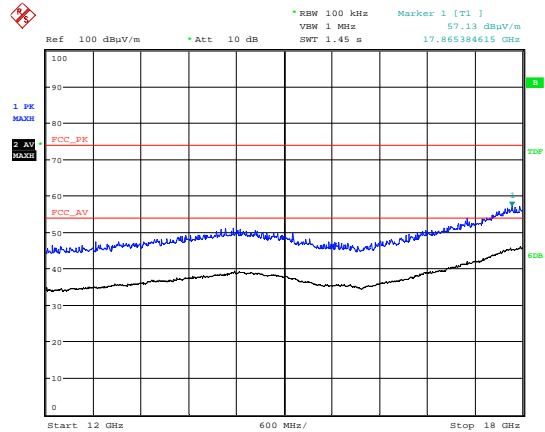

Date: 9.DEC.2019 08:23:43

6 GHz to 12 GHz

12 GHz to 18 GHz

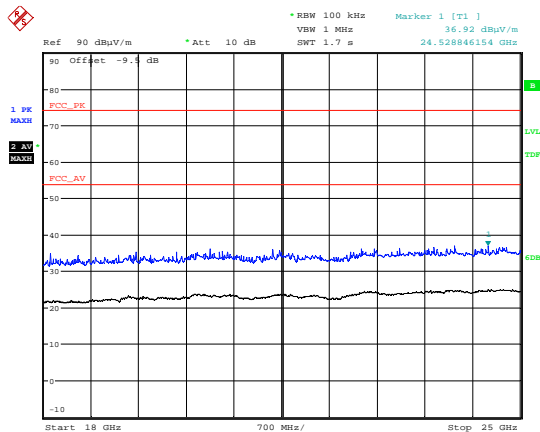

Date: 9.DEC.2019 11:07:38

18 GHz to 25 GHz

High Power; Channel: 2480 MHz										
Detector	Freq. (MHz)	Measure d Emission (dBμV/m)	Cable Loss (dB)	Antenna Factor (dB/m)	Pre-amp Gain (dB)	Duty Cycle Correction (dB)	Extrap'n Factor (dB)	Field Strength (dBμV/m)	Field Strength (μV/m)	Limit (μV/m)
Pk	4962.00	49.12	4.30	33.10	35.44	0.00	0.00	51.08	358.10	5000
Av	4962.00	38.83	4.30	33.10	35.44	5.50	0.00	46.29	206.30	500
Pk	7443.00	47.73	5.40	36.60	35.70	0.00	0.00	54.03	502.92	5000
Av	7443.00	32.98	5.40	36.60	35.70	5.50	0.00	44.78	173.38	500

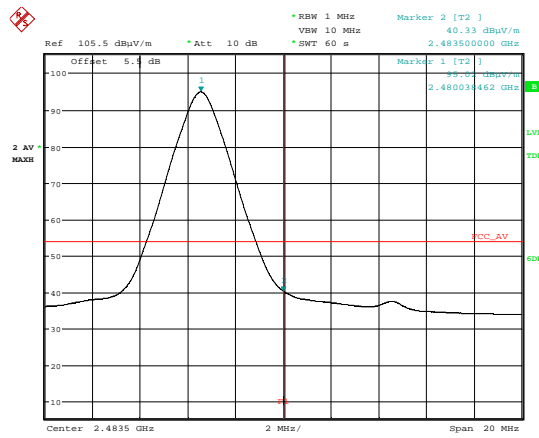
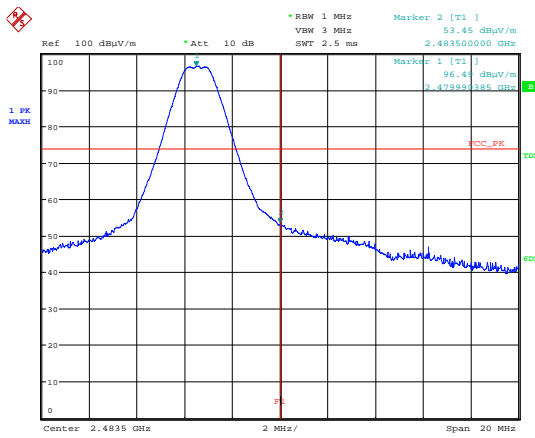

Date: 9.DEC.2019 08:42:33

Date: 9.DEC.2019 08:44:34

2480 MHz Upper Band Edge Plot – Peak

2480 MHz Upper Band Edge Plot - Average

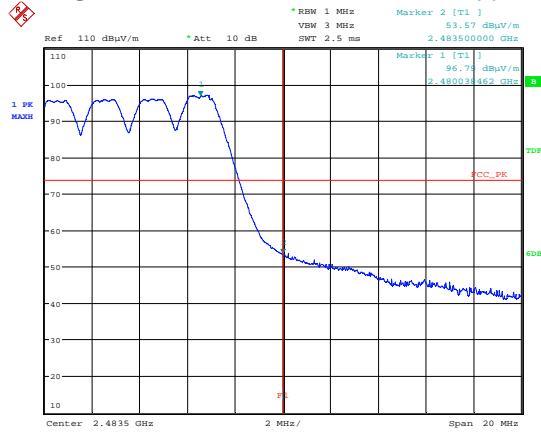

Date: 9.DEC.2019 09:20:40

2480 MHz Upper Band Edge Hopping Plot – Peak

11.8 Test Results – RMP40MQE

2403 MHz – 1 Mbps

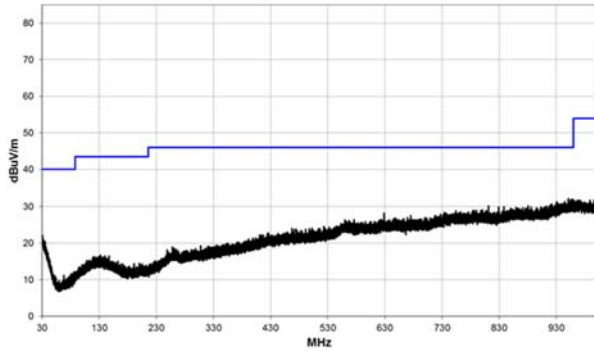

30 MHz to 1 GHz

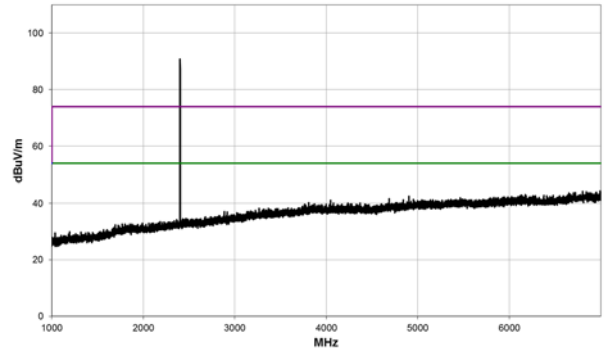

1 GHz to 7 GHz

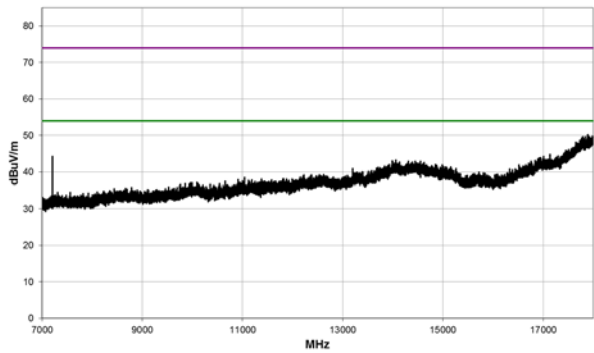

7 GHz to 18 GHz

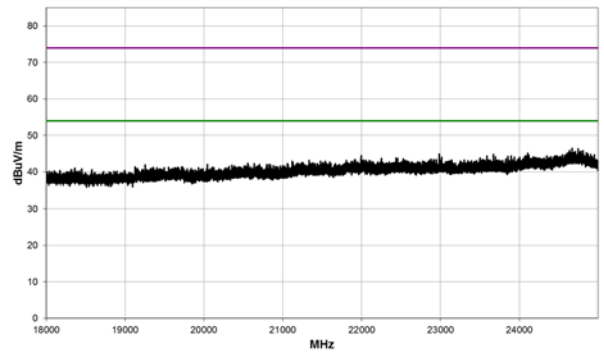

18 GHz to 25 GHz

Freq (MHz)	Amplitude (dBuV)	Preamp (dB)	Antenna Height (meters)	Transducer (dB)	Cable (dB)	External Attenuation (dB)	Polarity/Transducer Type	Detector	Distance Adjustment (dB)	Adjusted (dBuV/m)	Spec. Limit (dBuV/m)	Compared to Spec. (dB)	Comments
No significant emissions within 20 dB to the limit													Pass

Note: 7209 MHz is not in a restricted band. 20 dB below the carrier limit apply.

2442 MHz – 1 Mbps

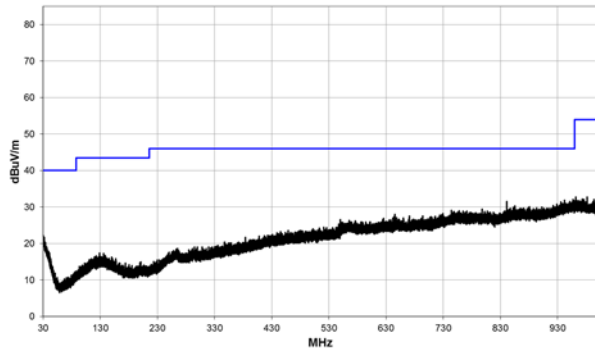

30 MHz to 1 GHz

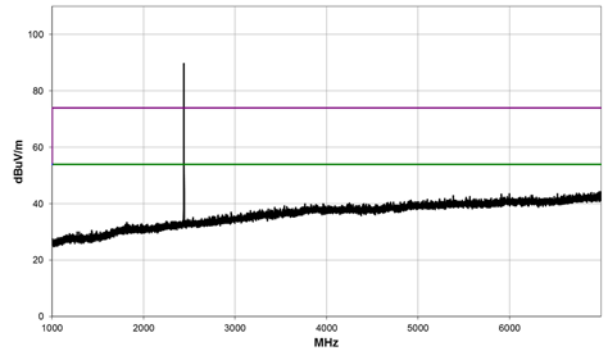

1 GHz to 7 GHz

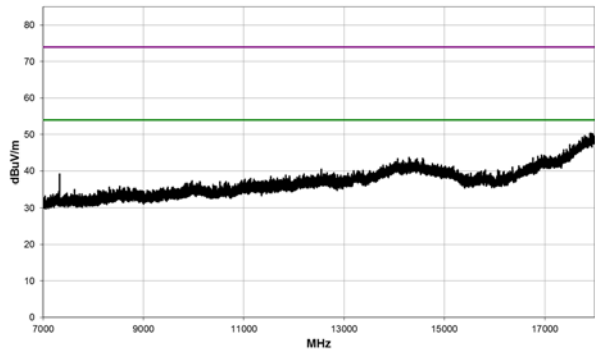

7 GHz to 18 GHz

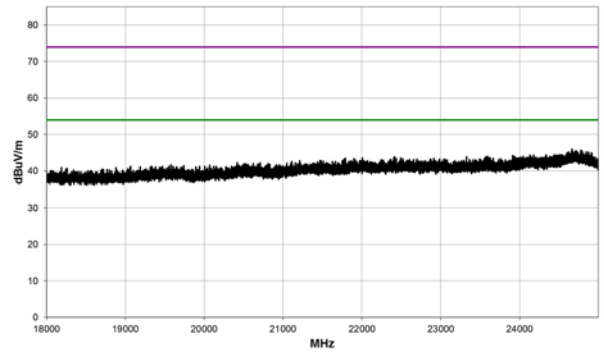

18 GHz to 25 GHz

Freq (MHz)	Amplitude (dBuV)	Factor (dB)	Antenna Height (meters)	Azimuth (degrees)	Duty Cycle Correction Factor (dB)	External Attenuation (dB)	Polarity/Transducer Type	Detector	Distance Adjustment (dB)	Adjusted (dBuV/m)	Spec. Limit (dBuV/m)	Compared to Spec. (dB)	Comments
7325.925	33.5	7.9	1.45	58.1	5.4	0.0	Horz	AV	-9.5	37.3	54.0	-16.7	Pass
7325.883	32.7	7.9	1.53	168.0	5.4	0.0	Vert	AV	-9.5	36.5	54.0	-17.5	Pass
7325.683	50.0	7.9	1.45	58.1		0.0	Horz	PK	-9.5	48.4	74.0	-25.6	Pass
7325.742	48.7	7.9	1.53	168.0		0.0	Vert	PK	-9.5	47.1	74.0	-26.9	Pass

2481 MHz – 1 Mbps

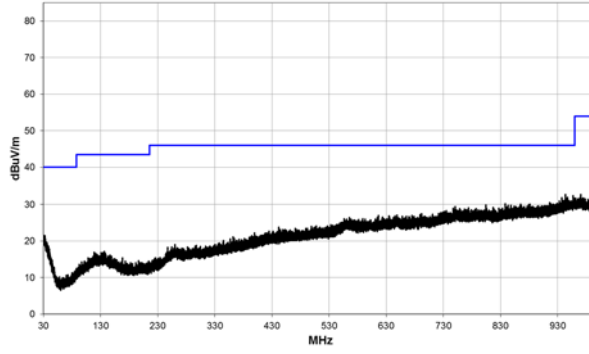

30 MHz to 1 GHz

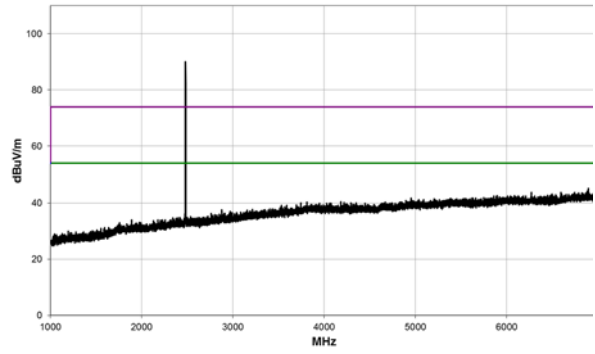

1 GHz to 7 GHz

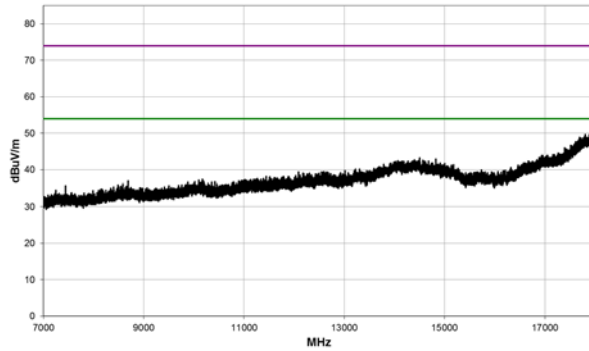

7 GHz to 18 GHz

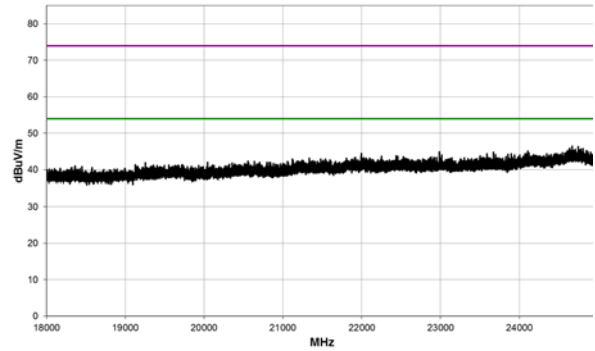

18 GHz to 25 GHz

Freq (MHz)	Amplitude (dBuV)	Factor (dB)	Antenna Height (meters)	Azimuth (degrees)	Duty Cycle Correction Factor (dB)	External Attenuation (dB)	Polarity/Transducer Type	Detector	Distance Adjustment (dB)	Adjusted (dBuV/m)	Spec. Limit (dBuV/m)	Compared to Spec. (dB)	Comments
7442.783	31.8	8.0	1.5	54.9	5.4	0.0	Horz	AV	-9.5	35.7	54.0	-18.3	Pass
7442.883	31.6	8.0	1.68	172.0	5.4	0.0	Vert	AV	-9.5	35.5	54.0	-18.5	Pass
7443.717	47.4	8.0	1.5	54.9		0.0	Horz	PK	-9.5	45.9	74.0	-28.1	Pass
7443.117	46.9	8.0	1.68	172.0		0.0	Vert	PK	-9.5	45.4	74.0	-28.6	Pass

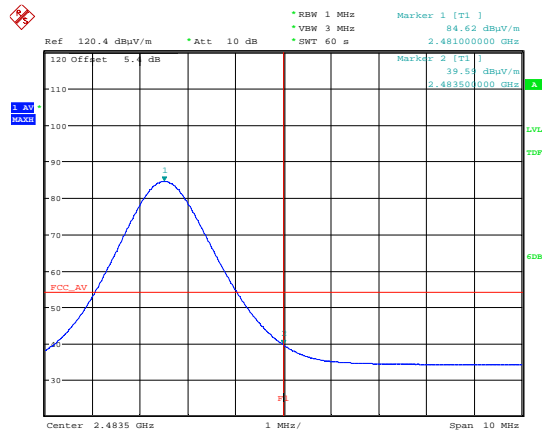
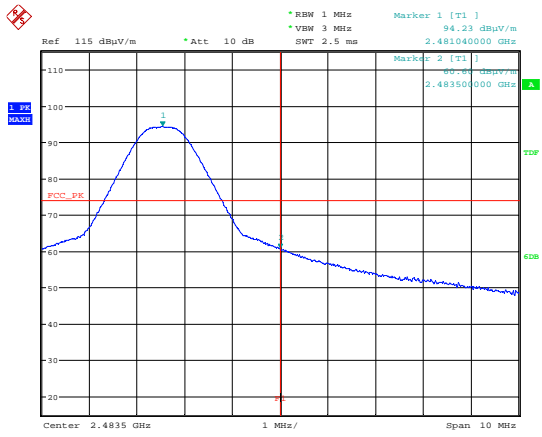

Date: 20.DEC.2019 13:22:49

Date: 20.DEC.2019 13:24:21

2481 MHz Upper Band Edge Plot – Peak

2481 MHz Upper Band Edge Plot - Average

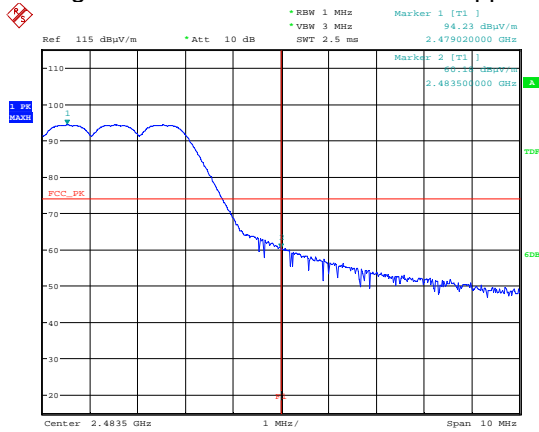

Date: 20.DEC.2019 13:38:28

2481 MHz Upper Band Edge Hopping Plot – Peak

RMP40MQE - 2404 MHz – 2 Mbps

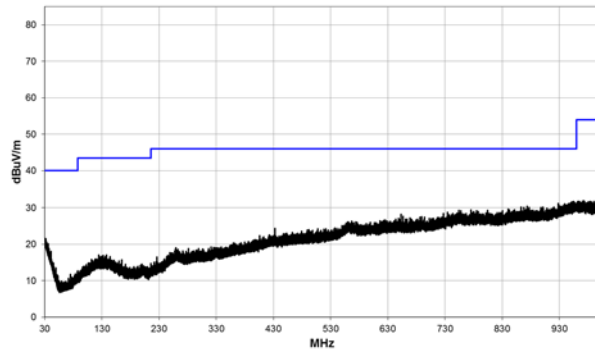

30 MHz to 1 GHz

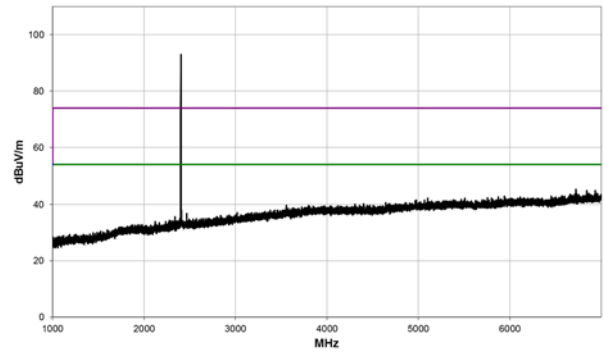

1 GHz to 7 GHz

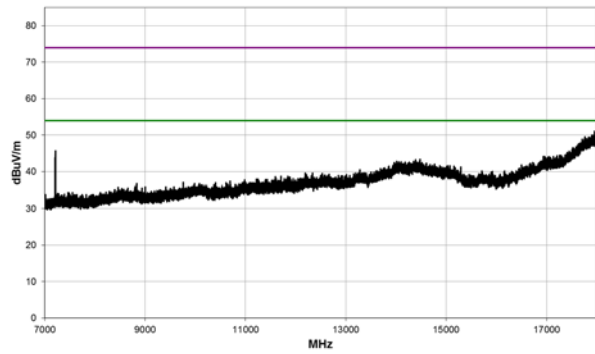

7 GHz to 18 GHz

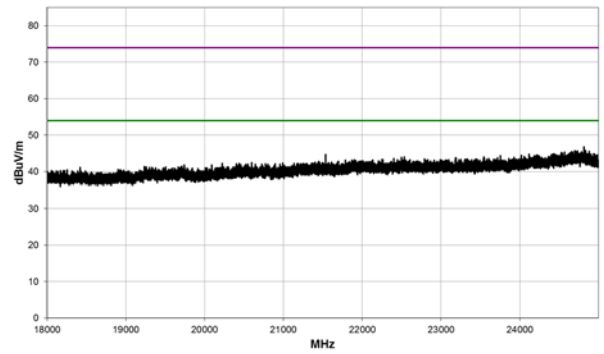

18 GHz to 25 GHz

Freq (MHz)	Amplitude (dBuV)	Preamp (dB)	Antenna Height (meters)	Transducer (dB)	Cable (dB)	External Attenuation (dB)	Polarity/ Transducer Type	Detector	Distance Adjustment (dB)	Adjusted (dBuV/m)	Spec. Limit (dBuV/m)	Compared to Spec. (dB)	Comments
No significant emissions within 20 dB to the limit												Pass	

Note: 7212 MHz is not in a restricted band. 20 dB below the carrier limit apply.

2442 MHz – 2 Mbps

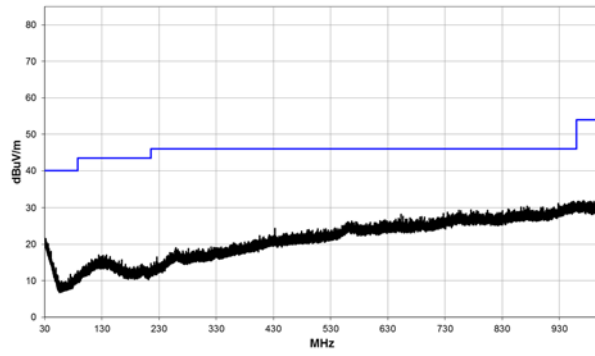

30 MHz to 1 GHz

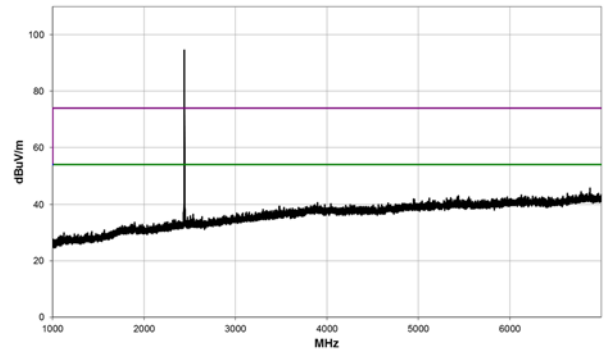

1 GHz to 7 GHz

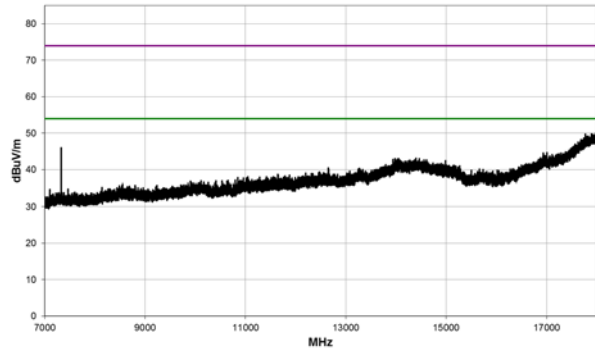

7 GHz to 18 GHz

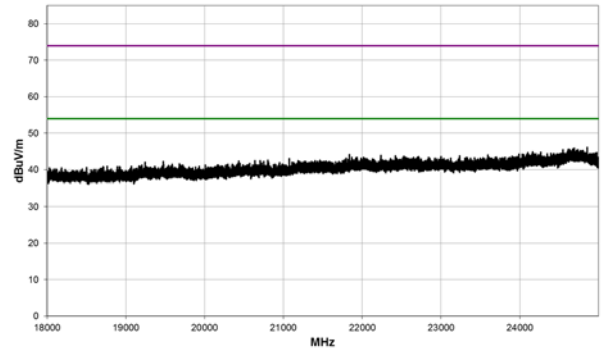

18 GHz to 25 GHz

Freq (MHz)	Amplitude (dBuV)	Factor (dB)	Antenna Height (meters)	Azimuth (degrees)	Duty Cycle Correction Factor (dB)	External Attenuation (dB)	Polarity/Transducer Type	Detector	Distance Adjustment (dB)	Adjusted (dBuV/m)	Spec. Limit (dBuV/m)	Compared to Spec. (dB)	Comments
7325.100	35.7	7.9	1.5	212.1	5.4	0.0	Horz	AV	-9.5	39.5	54.0	-14.5	Pass
7325.142	37.9	7.9	1.75	185.9	5.4	0.0	Vert	AV	-9.5	41.7	54.0	-12.3	Pass
7325.017	56.1	7.9	1.75	185.9		0.0	Vert	PK	-9.5	54.5	74.0	-19.5	Pass
7326.025	53.6	7.9	1.5	212.1		0.0	Horz	PK	-9.5	52.0	74.0	-22.0	Pass

2480 MHz – 2 Mbps

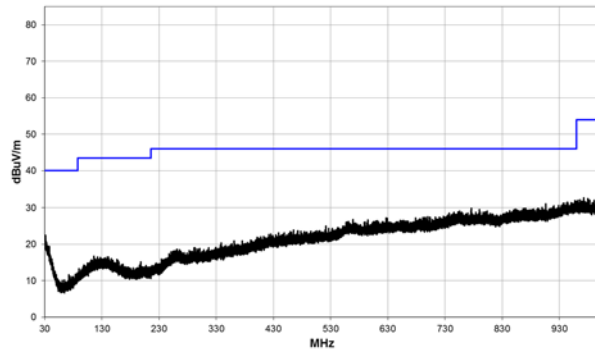

30 MHz to 1 GHz

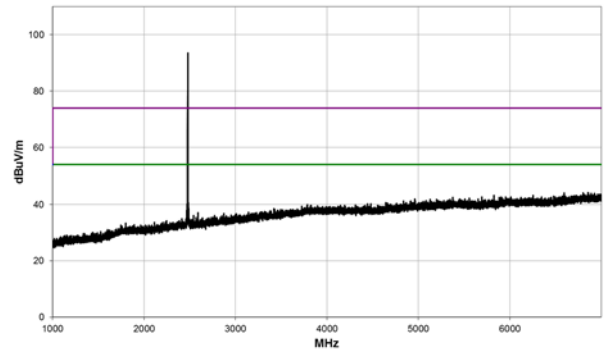

1 GHz to 7 GHz

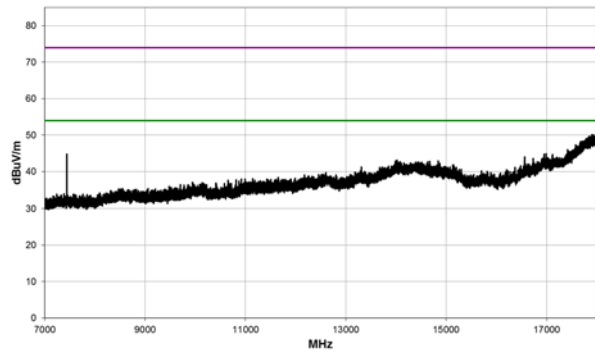

7 GHz to 18 GHz

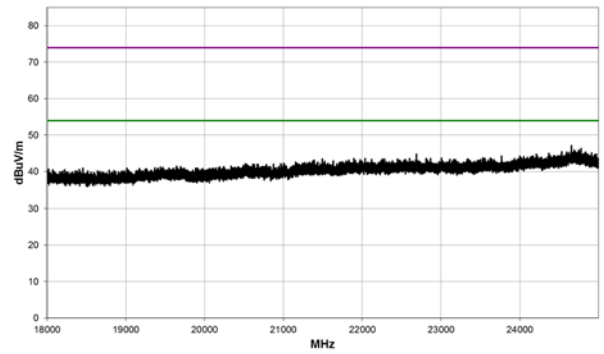

18 GHz to 25 GHz

Freq (MHz)	Amplitude (dBuV)	Factor (dB)	Antenna Height (meters)	Azimuth (degrees)	Duty Cycle Correction Factor (dB)	External Attenuation (dB)	Polarity/Transducer Type	Detector	Distance Adjustment (dB)	Adjusted (dBuV/m)	Spec. Limit (dBuV/m)	Compared to Spec. (dB)	Comments
7439.158	34.6	8.0	1.59	187.1	5.4	0.0	Vert	AV	-9.5	30.5	54.0	-23.5	Pass
7439.117	33.2	8.0	1.47	214.9	5.4	0.0	Horz	AV	-9.5	29.1	54.0	-24.9	Pass
7439.075	51.9	8.0	1.59	187.1		0.0	Vert	PK	-9.5	50.4	74.0	-23.6	Pass
7439.050	49.9	8.0	1.47	214.9		0.0	Horz	PK	-9.5	48.4	74.0	-25.6	Pass

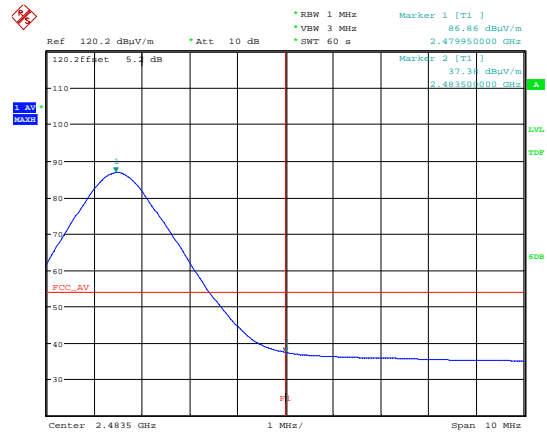
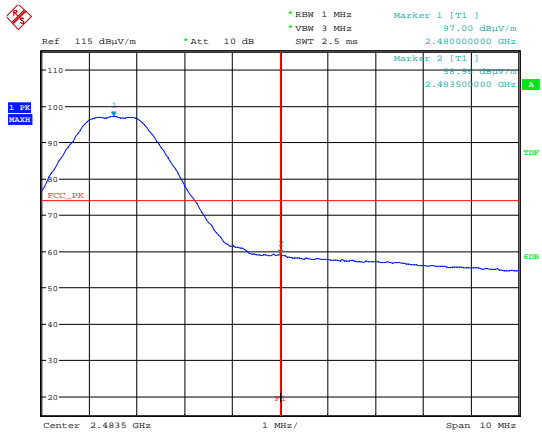

Date: 20.DEC.2019 12:04:41

Date: 20.DEC.2019 12:03:24

2480 MHz Upper Band Edge Plot – Peak

2480 MHz Upper Band Edge Plot - Average

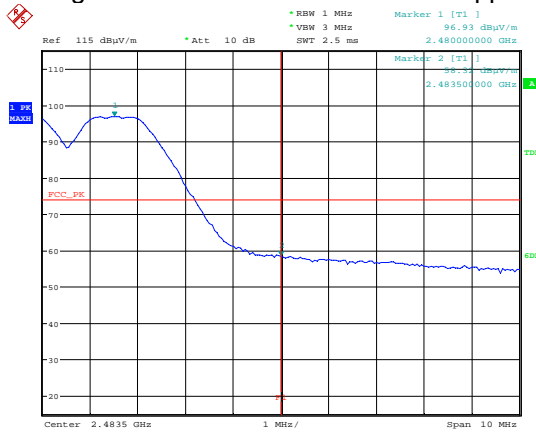

Date: 20.DEC.2019 12:08:25

2480 MHz Upper Band Edge Hopping Plot – Peak

11.9 Test Results – RLP40QE

2403 MHz – 1 Mbps

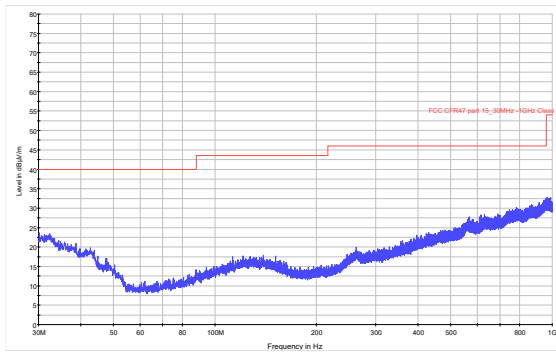

30 MHz to 1 GHz

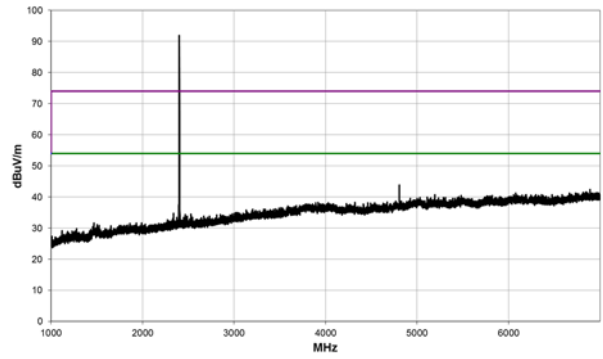

1 GHz to 7 GHz

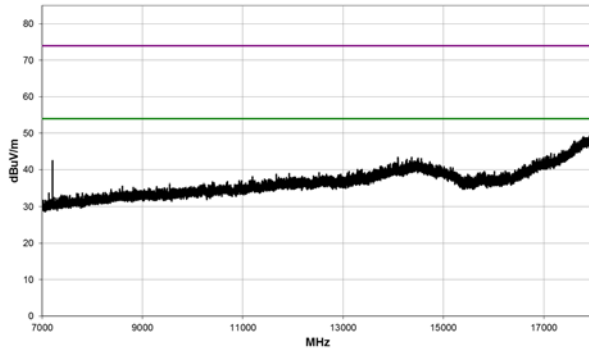

7 GHz to 18 GHz

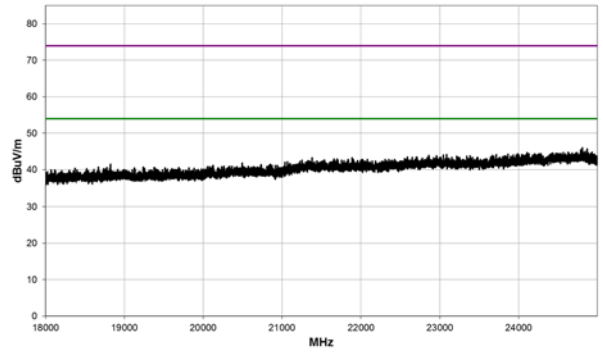

18 GHz to 25 GHz

Freq (MHz)	Amplitude (dBuV)	Factor (dB)	Antenna Height (meters)	Azimuth (degrees)	Duty Cycle Correction Factor (dB)	External Attenuation (dB)	Polarity/Transducer Type	Detector	Distance Adjustment (dB)	Adjusted (dBuV/m)	Spec. Limit (dBuV/m)	Compared to Spec. (dB)	Comments
4805.992	38.7	3.0	1.7	136.9	5.5	0.0	Vert	AV	0.0	47.2	54.0	-6.8	Pass
4805.992	34.1	3.0	3.17	236.8	5.5	0.0	Horz	AV	0.0	42.6	54.0	-11.4	Pass
4805.900	48.4	3.0	1.7	136.9		0.0	Vert	PK	0.0	51.4	74.0	-22.6	Pass
4806.308	46.2	3.0	3.17	236.8		0.0	Horz	PK	0.0	49.2	74.0	-24.8	Pass

Note: 7209 MHz is not in a restricted band. 20 dB below the carrier limit apply.

2442 MHz – 1 Mbps

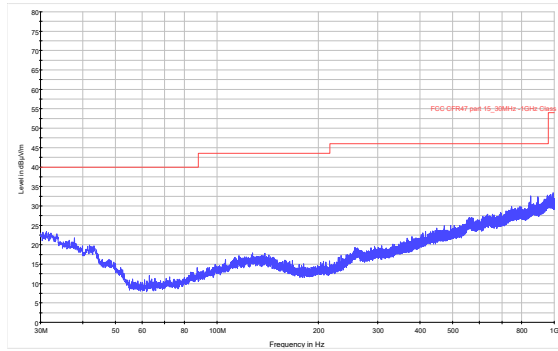

30 MHz to 1 GHz

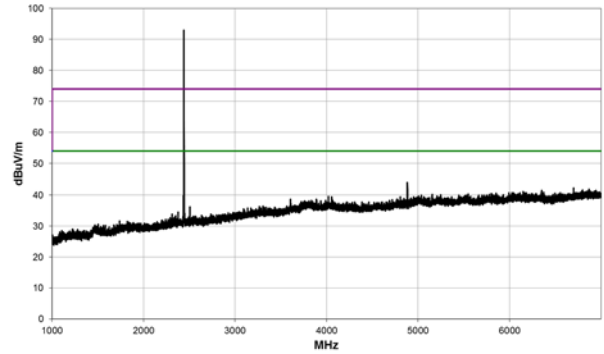

1 GHz to 7 GHz

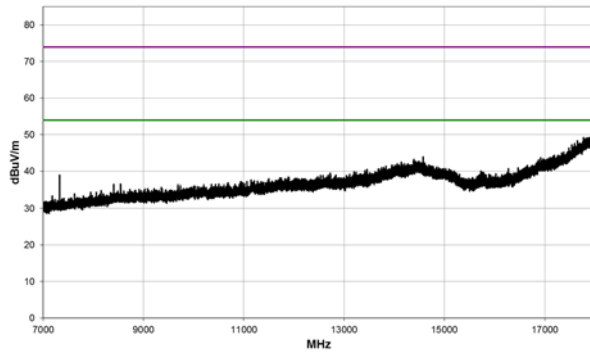

7 GHz to 18 GHz

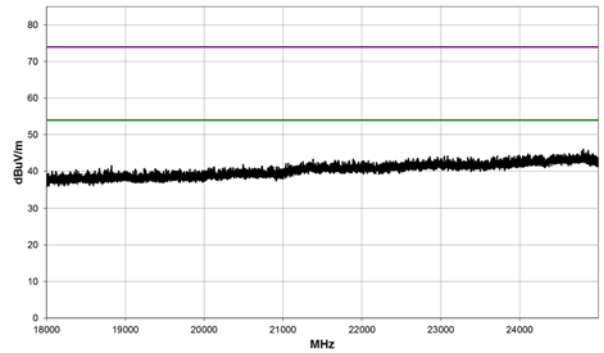

18 GHz to 25 GHz

Freq (MHz)	Amplitude (dBuV)	Factor (dB)	Antenna Height (meters)	Azimuth (degrees)	Duty Cycle Correction Factor (dB)	External Attenuation (dB)	Polarity/Transducer Type	Detector	Distance Adjustment (dB)	Adjusted (dBuV/m)	Spec. Limit (dBuV/m)	Compared to Spec. (dB)	Comments
4884.125	38.7	3.2	1.77	140.2	5.5	0.0	Vert	AV	0.0	47.4	54.0	-6.6	Pass
4884.167	32.5	3.2	3.41	156.2	5.5	0.0	Horz	AV	0.0	41.2	54.0	-12.8	Pass
4883.933	48.7	3.2	1.77	140.2		0.0	Vert	PK	0.0	51.9	74.0	-22.1	Pass
4883.475	45.1	3.2	3.41	156.2		0.0	Horz	PK	0.0	48.3	74.0	-25.7	Pass
7326.058	33.8	7.9	1.36	7.1	5.5	0.0	Horz	AV	-9.5	37.7	54.0	-16.3	Pass
7326.142	38.1	7.9	1.91	150.1	5.5	0.0	Vert	AV	-9.5	42.0	54.0	-12.0	Pass
7325.842	48.1	7.9	1.91	150.1		0.0	Vert	PK	-9.5	46.5	74.0	-27.5	Pass
7326.367	45.2	7.9	1.36	7.1		0.0	Horz	PK	-9.5	43.6	74.0	-30.4	Pass

2481 MHz – 1 Mbps

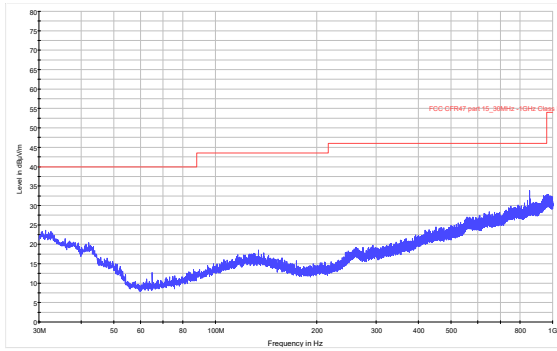

30 MHz to 1 GHz

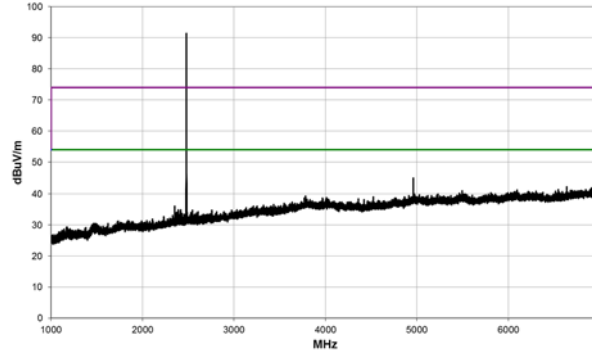

1 GHz to 7 GHz

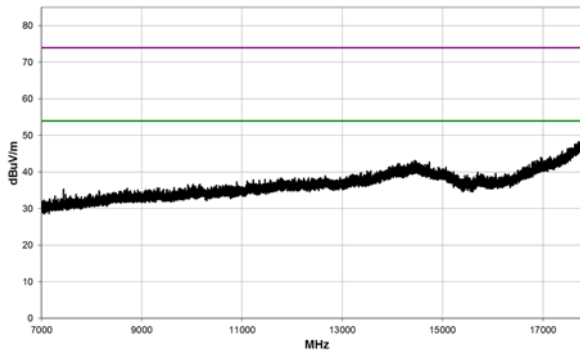

7 GHz to 18 GHz

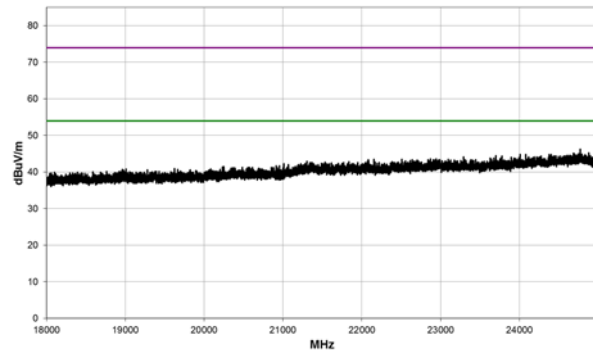

18 GHz to 25 GHz

Freq (MHz)	Amplitude (dBuV)	Factor (dB)	Antenna Height (meters)	Azimuth (degrees)	Duty Cycle Correction Factor (dB)	External Attenuation (dB)	Polarity/Transducer Type	Detector	Distance Adjustment (dB)	Adjusted (dBuV/m)	Spec. Limit (dBuV/m)	Compared to Spec. (dB)	Comments
4962.092	38.7	3.5	1.83	136.9	5.5	0.0	Vert	AV	0.0	47.7	54.0	-6.3	Pass
4962.192	33.6	3.5	1.6	69.0	5.5	0.0	Horz	AV	0.0	42.6	54.0	-11.4	Pass
4961.708	49.0	3.4	1.83	136.9		0.0	Vert	PK	0.0	52.4	74.0	-21.6	Pass
4962.308	45.9	3.5	1.6	69.0		0.0	Horz	PK	0.0	49.4	74.0	-24.6	Pass
7443.108	35.3	8.0	1.6	156.9	5.5	0.0	Vert	AV	-9.5	39.3	54.0	-14.7	Pass
7442.900	32.3	8.0	1.6	242.9	5.5	0.0	Horz	AV	-9.5	36.3	54.0	-17.7	Pass
7443.442	47.0	8.0	1.6	156.9		0.0	Vert	PK	-9.5	45.5	74.0	-28.5	Pass
7442.958	43.6	8.0	1.6	242.9		0.0	Horz	PK	-9.5	42.1	74.0	-31.9	Pass

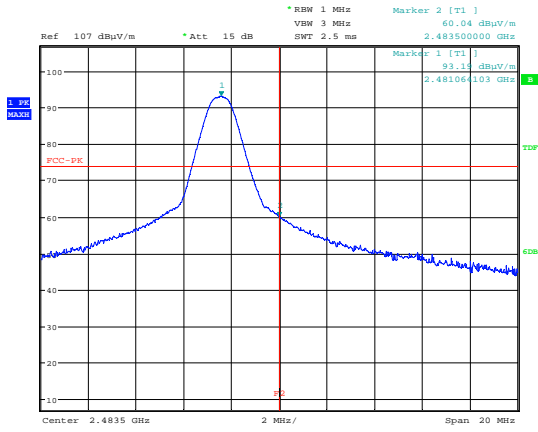

Date: 11.DEC.2019 11:17:18

2481 MHz Upper Band Edge Plot – Peak

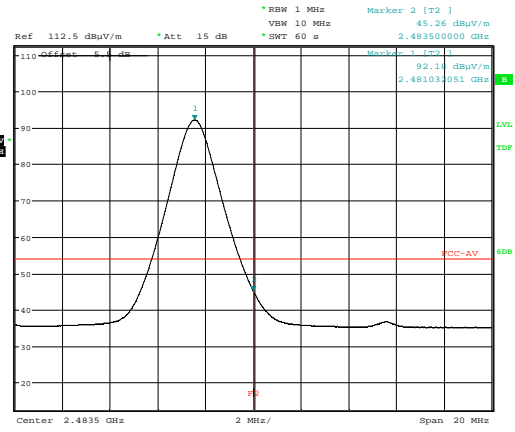

Date: 11.DEC.2019 11:25:05

2481 MHz Upper Band Edge Plot - Average

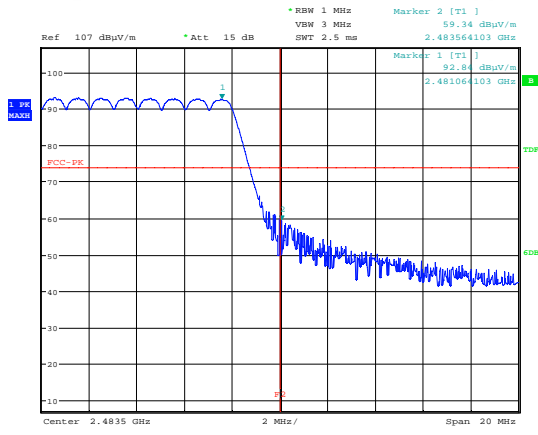

Date: 11.DEC.2019 11:22:09

2481 MHz Upper Band Edge Hopping Plot – Peak

RLP40QE - 2404 MHz – 2 Mbps

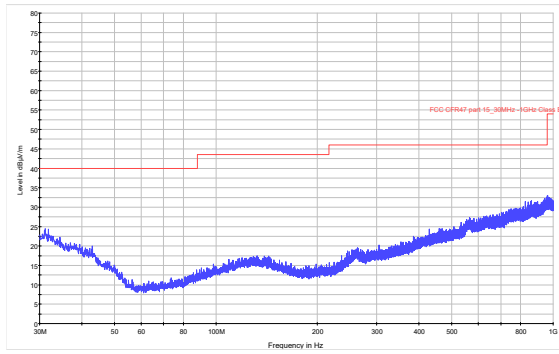

30 MHz to 1 GHz

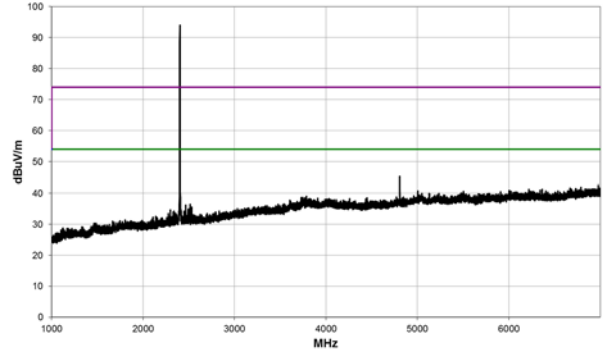

1 GHz to 7 GHz

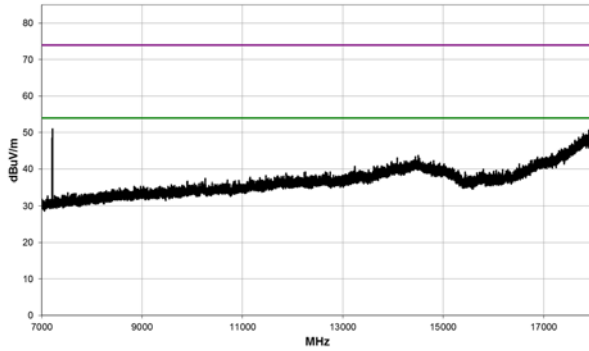

7 GHz to 18 GHz

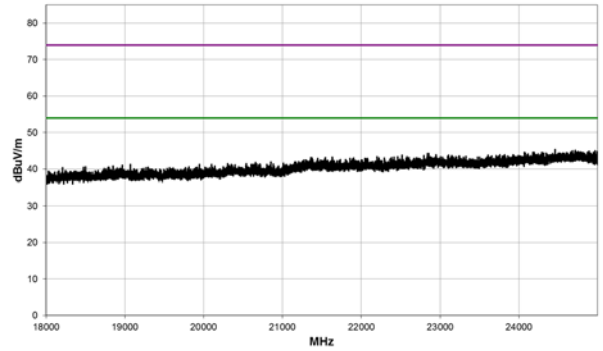

18 GHz to 25 GHz

Freq (MHz)	Amplitude (dBuV)	Factor (dB)	Antenna Height (meters)	Azimuth (degrees)	Duty Cycle Correction Factor (dB)	External Attenuation (dB)	Polarity/Transducer Type	Detector	Distance Adjustment (dB)	Adjusted (dBuV/m)	Spec. Limit (dBuV/m)	Compared to Spec. (dB)	Comments
4807.992	37.0	3.0	1.6	138.8	5.5	0.0	Vert	AV	0.0	45.5	54.0	-8.5	Pass
4807.992	32.6	3.0	1.6	304.1	5.5	0.0	Horz	AV	0.0	41.1	54.0	-12.9	Pass
4808.050	48.7	3.0	1.6	138.8		0.0	Vert	PK	0.0	51.7	74.0	-22.3	Pass
4808.250	46.0	3.0	1.6	304.1		0.0	Horz	PK	0.0	49.0	74.0	-25.0	Pass

Note: 7212 MHz is not in a restricted band. 20 dB below the carrier limit apply.

2442 MHz – 2 Mbps

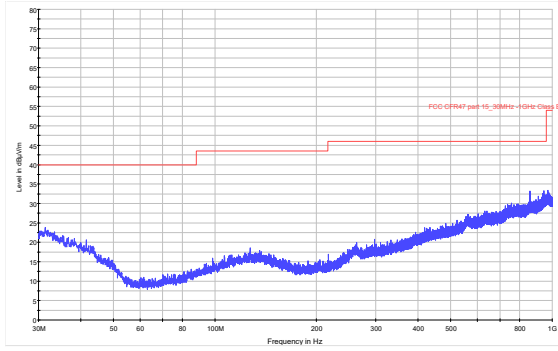

30 MHz to 1 GHz

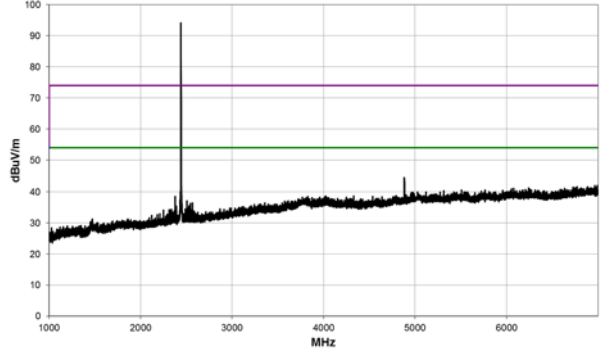

1 GHz to 7 GHz

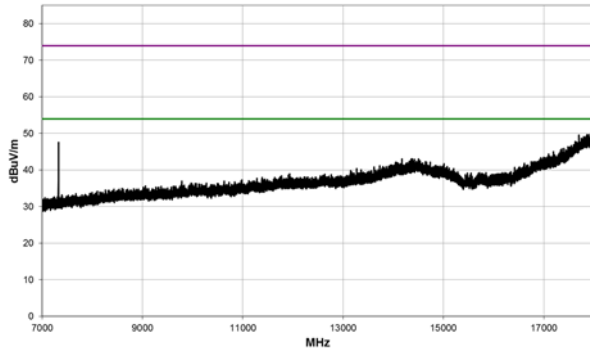

7 GHz to 18 GHz

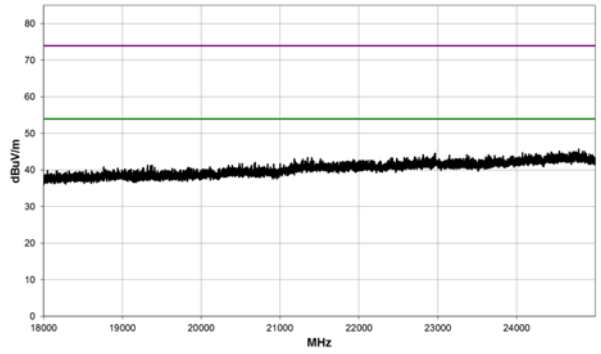

18 GHz to 25 GHz

Freq (MHz)	Amplitude (dBuV)	Factor (dB)	Antenna Height (meters)	Azimuth (degrees)	Duty Cycle Correction Factor (dB)	External Attenuation (dB)	Polarity/Transducer Type	Detector	Distance Adjustment (dB)	Adjusted (dBuV/m)	Spec. Limit (dBuV/m)	Compared to Spec. (dB)	Comments
4884.067	32.4	3.2	2.41	205.8	5.5	0.0	Horz	AV	0.0	41.1	54.0	-12.9	Pass
4884.125	37.6	3.2	1.73	218.8	5.5	0.0	Vert	AV	0.0	46.3	54.0	-7.7	Pass
4883.950	49.0	3.2	1.73	218.8		0.0	Vert	PK	0.0	52.2	74.0	-21.8	Pass
4884.025	45.5	3.2	2.41	205.8		0.0	Horz	PK	0.0	48.7	74.0	-25.3	Pass
7326.783	42.0	7.9	1.98	145.9	5.5	0.0	Vert	AV	-9.5	45.9	54.0	-8.1	Pass
7326.875	34.8	7.9	1.6	39.0	5.5	0.0	Horz	AV	-9.5	38.7	54.0	-15.3	Pass
7325.983	52.9	7.9	1.98	145.9		0.0	Vert	PK	-9.5	51.3	74.0	-22.7	Pass
7326.583	46.7	7.9	1.6	39.0		0.0	Horz	PK	-9.5	45.1	74.0	-28.9	Pass

2480 MHz – 2 Mbps

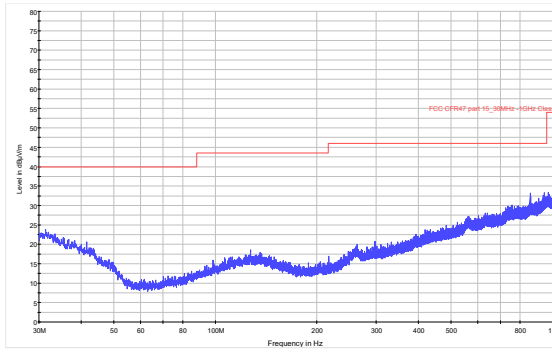

30 MHz to 1 GHz

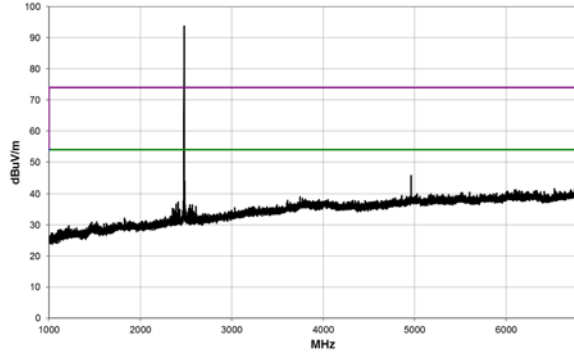

1 GHz to 7 GHz

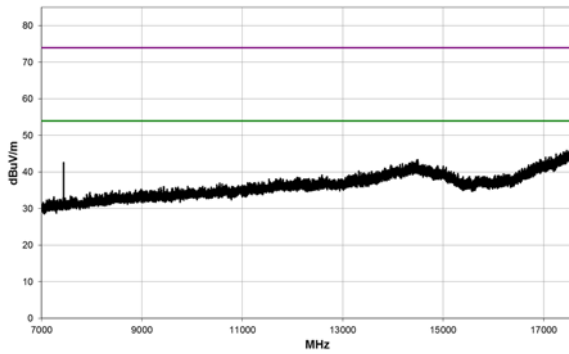

7 GHz to 18 GHz

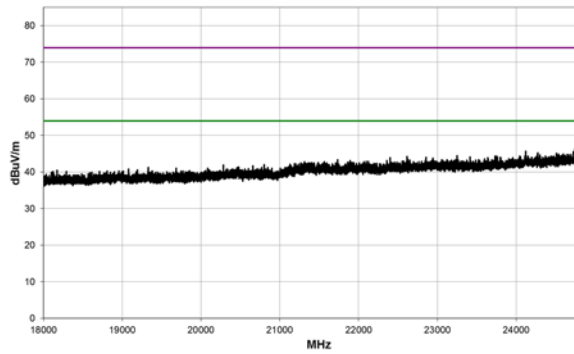

18 GHz to 25 GHz

Freq (MHz)	Amplitude (dBuV)	Factor (dB)	Antenna Height (meters)	Azimuth (degrees)	Duty Cycle Correction Factor (dB)	External Attenuation (dB)	Polarity/Transducer Type	Detector	Distance Adjustment (dB)	Adjusted (dBuV/m)	Spec. Limit (dBuV/m)	Compared to Spec. (dB)	Comments
4959.992	38.5	3.4	1.97	149.9	5.5	0.0	Vert	AV	0.0	47.4	54.0	-6.6	Pass
4962.442	32.8	3.5	1.6	38.9	5.5	0.0	Horz	AV	0.0	41.8	54.0	-12.2	Pass
4960.017	48.8	3.4	1.97	149.9		0.0	Vert	PK	0.0	52.2	74.0	-21.8	Pass
4959.217	46.2	3.4	1.6	38.9		0.0	Horz	PK	0.0	49.6	74.0	-24.4	Pass
7440.84	38.30	8.00	1.90	171.80	5.50	0.00	Vert	AV	-9.50	42.30	54.00	-11.70	Pass
7440.95	32.90	8.00	1.60	20.00	5.50	0.00	Horz	AV	-9.50	36.90	54.00	-17.10	Pass
7441.23	49.80	8.00	1.90	171.80		0.00	Vert	PK	-9.50	48.30	74.00	-25.70	Pass
7439.18	45.60	8.00	1.60	20.00		0.00	Horz	PK	-9.50	44.10	74.00	-29.90	Pass

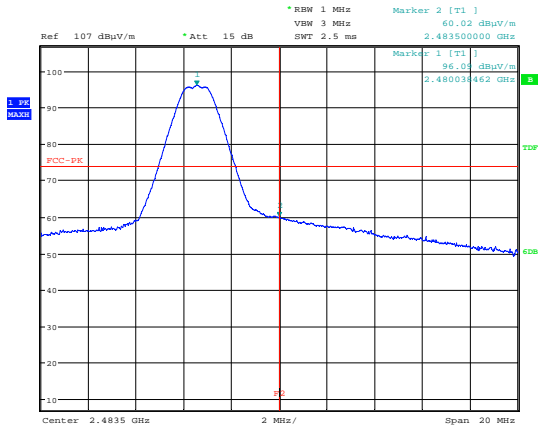

Date: 11.DEC.2019 11:34:41

2480 MHz Upper Band Edge Plot – Peak

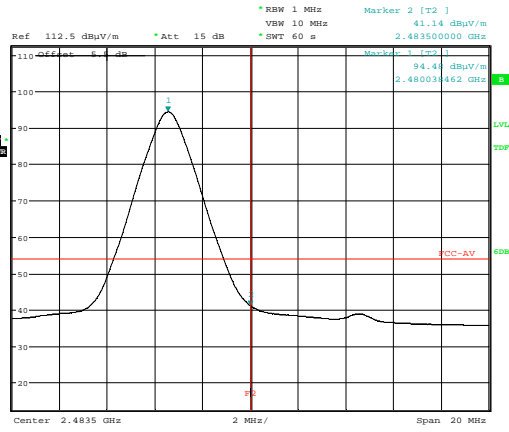

Date: 11.DEC.2019 11:33:05

2480 MHz Upper Band Edge Plot - Average

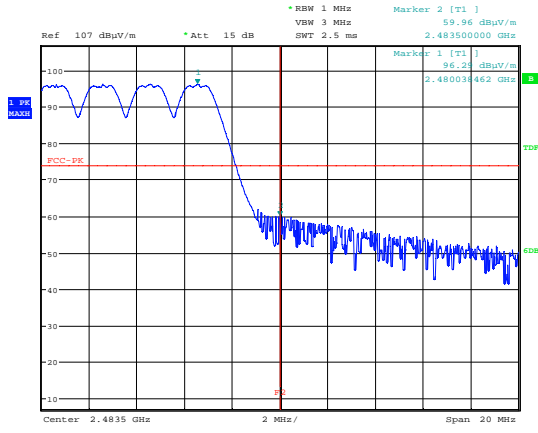

Date: 11.DEC.2019 11:36:20

2480 MHz Upper Band Edge Hopping Plot – Peak

12 Carrier frequency separation

12.1 Definition

The carrier frequency separation is the frequency separation between two adjacent hopping frequencies.

12.2 Test Parameters

Test Location:	Element Skelmersdale
Test Chamber:	Radio Laboratory
Test Standard and Clause:	ANSI C63.10-2013, Clause 7.8.2
EUT Channels / Frequencies Measured:	Mode 1: 2403 MHz to 2481 MHz Mode 2: 2404 MHz to 2480 MHz
EUT 20dB Bandwidth:	Mode 1: 937.5 kHz Mode 2: 1.818 MHz
EUT Test Modulations:	Internal pattern generation – hopping enabled
Deviations From Standard:	None
Measurement BW:	100 kHz
Measurement Detector:	Peak

Environmental Conditions (Normal Environment)

Temperature: 23x °C	+15 °C to +35 °C (as declared)
Humidity: 29 % RH	20 % RH to 75 % RH (as declared)
Supply: 3.0 Vdc	

12.3 Test Limit

Frequency hopping systems shall have hopping channel carrier frequencies separated by a minimum of 25 kHz or the -20 dB bandwidth of the hopping channel, whichever is greater. Alternatively, frequency hopping systems operating in the band 2400 to 2483.5 MHz may have hopping channel carrier frequencies that are separated by 25 kHz or two-thirds of the -20 dB bandwidth of the hopping channel, whichever is greater, provided that the systems operate with an output power no greater than 0.125 W.

12.4 Test Method

With the EUT setup as per section 9 of this report and connected as per Figure iii, the emissions of the EUT were measured on a spectrum analyser.

The measurements were performed with EUT set at its maximum duty. All modulation schemes, data rates and power settings were used to observe the worst-case configuration in each nominal bandwidth.

Figure iii Test Setup

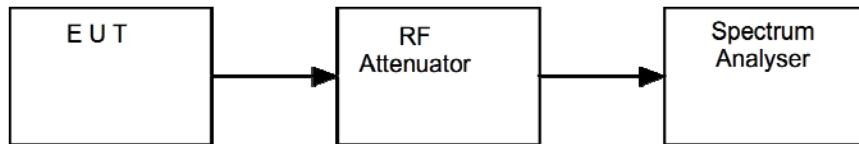

12.5 Test Equipment

Equipment Type	Manufacturer	Equipment Description	Element No	Due For Calibration
FSU26	R&S	Spectrum Analyser	U405	2020-10-21

12.6 Test Results

Mode 1: 1MBps				
Data Rate	$F1_c$ (MHz)	$F2_c$ (MHz)	Channel Separation, $F2_c - F1_c$ (kHz)	Result
1 MBps	2441.028205	2442.028205	1000	PASS

Mode 2: 2MBps				
Data Rate	$F1_c$ (MHz)	$F2_c$ (MHz)	Channel Separation, $F2_c - F1_c$ (MHz)	Result
2 MBps	2440.028205	2442.028205	2000	PASS

Mode 1:

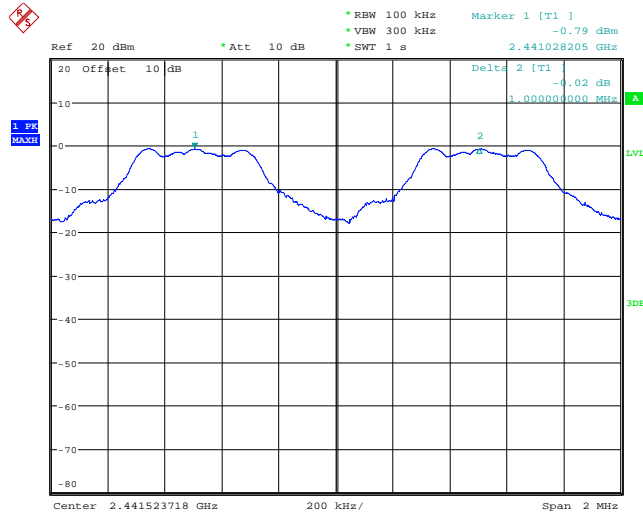

Date: 16.DEC.2019 13:49:56

Mode 2:

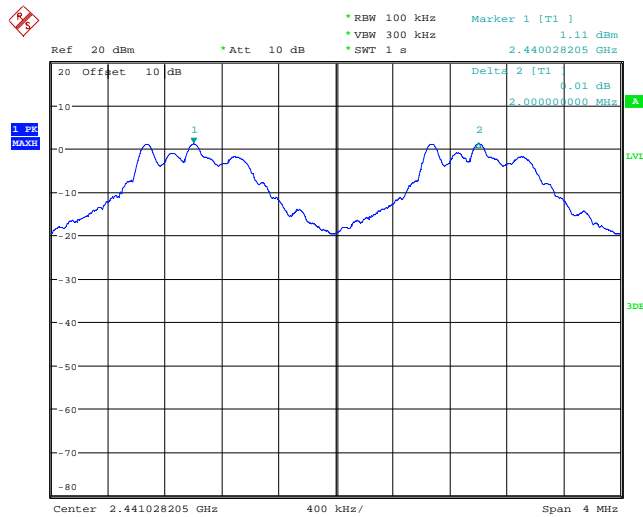

Date: 16.DEC.2019 13:52:20

13 Number of hopping frequencies

13.1 Definition

The total number of hopping frequencies (the centre frequencies defined within the hopping sequence of a FHSS equipment) which are randomly sequenced in order to spread the transmission.

13.2 Test Parameters

Test Location:	Element Skelmersdale
Test Chamber:	Radio Laboratory
Test Standard and Clause:	ANSI C63.10-2013, Clause 7.8.3
EUT Channels / Frequencies Measured:	2403 MHz – 2481 MHz 2405 MHz – 2480 MHz
EUT 20dB Bandwidth:	Mode 1: 937.5 kHz Mode 2: 1.818 MHz
EUT Test Modulations:	Internal pattern generation – hopping enabled
Deviations From Standard:	None
Measurement Detector:	Peak

Environmental Conditions (Normal Environment)

Temperature: 23 °C	+15 °C to +35 °C (as declared)
Humidity: 29 % RH	20 % RH to 75 % RH (as declared)
Supply: 3.0 V dc	

13.3 Test Limit

- For frequency hopping systems in the band 902 to 928 MHz: if the -20 dB bandwidth of the hopping channel is less than 250 kHz, the system shall use at least 50 hopping channels; If the -20 dB bandwidth of the hopping channel is 250 kHz or greater, the system shall use at least 25 hopping channels;
- Frequency hopping systems operating in the band 2400 to 2483.5 MHz shall use at least 15 hopping channels;
- Frequency hopping systems operating in the band 5725 to 5850 MHz shall use at least 75 hopping channels.

13.4 Test Method

With the EUT setup as per section 9 of this report and connected as per Figure iv, the emissions of the EUT were measured on a spectrum analyser.

The measurements were performed with EUT set at its maximum duty. All modulation schemes, data rates and power settings were used to observe the worst-case configuration in each nominal bandwidth.

Figure iv Test Setup

<

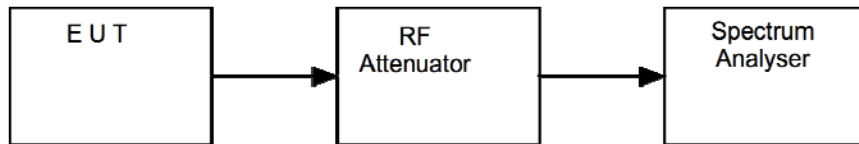

13.5 Test Equipment

Equipment Type	Manufacturer	Equipment Description	Element No	Due For Calibration
FSU26	R&S	Spectrum Analyser	U405	2020-10-21

13.6 Test Results

<i>Data Rate</i>	<i>Lowest channel, F_{CL} (MHz)</i>	<i>Highest channel, F_{CH} (MHz)</i>	<i>Number of channels observed</i>	<i>Result</i>
1 Mbps	2403.0 MHz	2481.0 MHz	79	PASS
2 Mbps	2404.0 MHz	2480.0 MHz	39	PASS

Mode 1:

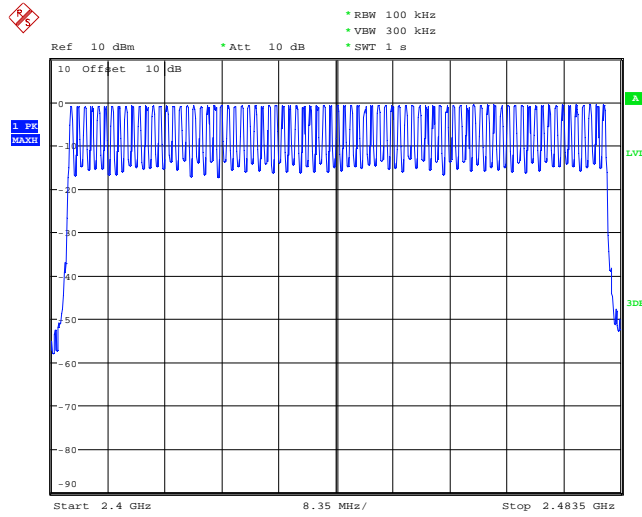

Date: 16.DEC.2019 14:14:22

Mode 2:

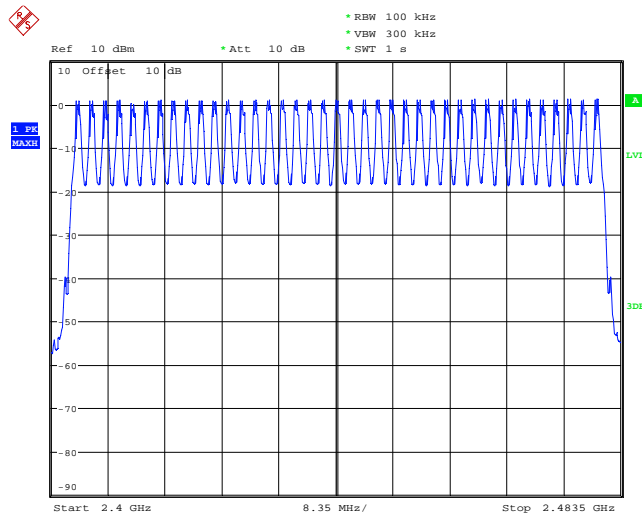

Date: 16.DEC.2019 14:17:20

14 Average channel occupancy

14.1 Definition

The channel occupancy is the total of the transmitter 'on' times, during an observation period, on a particular hopping frequency.

14.2 Test Parameters

Test Location:	Element Skelmersdale
Test Chamber:	Radio Laboratory
Test Standard and Clause:	ANSI C63.10-2013, Clause 7.8.4
Frequencies Measured:	2442.0 MHz
EUT 20dB bandwidth:	Mode 1:937.5 kHz Mode 2:1818.910 kHz
EUT Number of hopping channels:	Mode 1: 79 Mode 2: 39
EUT Test Modulations:	Internal pattern generation – hopping enabled
Deviations From Standard:	None
Measurement BW:	100 kHz
Measurement Detector:	Peak

Environmental Conditions (Normal Environment)

Temperature: 22 °C	+15 °C to +35 °C (as declared)
Humidity: 30 % RH	20 % RH to 75 % RH (as declared)
Supply: 3.0 Vdc	

14.3 Test Limit

- For frequency hopping systems in the band 902 to 928 MHz: if the -20 dB bandwidth of the hopping channel is less than 250 kHz, the average time of occupancy on any channel shall not be greater than 0.4 seconds within a 20 second period;
If the -20 dB bandwidth of the hopping channel is 250 kHz or greater, the average time of occupancy on any channel shall not be greater than 0.4 seconds within a 10 second period;
- Frequency hopping systems operating in the band 2400 to 2483.5 MHz: The average time of occupancy on any channel shall not be greater than 0.4 seconds within a period of 0.4 seconds, multiplied by the number of hopping channels employed;
- Frequency hopping systems operating in the band 5725 to 5850 MHz: The average time of occupancy on any frequency shall not be greater than 0.4 seconds within a 30 second period.

14.4 Test Method

With the EUT setup as per section 9 of this report and connected as per Figure v, the emissions of the EUT were measured on a spectrum analyser.

The measurements were performed with EUT set at its maximum duty. A number of hops were observed to confirm consistency of the dwell time / observe the worst case. All modulation schemes, data rates and power settings were used to observe the worst-case configuration.

Figure v Test Setup

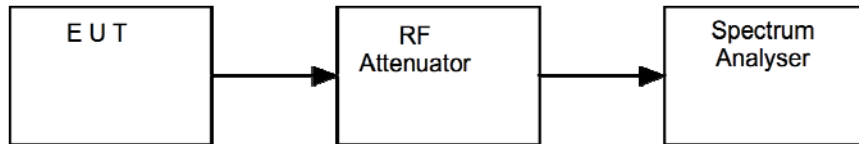

14.5 Test Equipment

Equipment Type	Manufacturer	Equipment Description	Element No	Due For Calibration
FSU26	R&S	Spectrum Analyser	U405	2020-10-21
SMBV100A	R&S	Signal Generator	U677	2020-05-07
AA18-10H	Atlantic Microwave	Attenuator	U634	Cal using U405 and U677

14.6 Test Results

Mode 1: 1MBps					
Data Rate	Individual occupancy time (ms)	Observation period (s)	Number of hops observed	Average time of occupancy (s)	Result
1Mbps	0.1957	31.6	400	0.07828	PASS

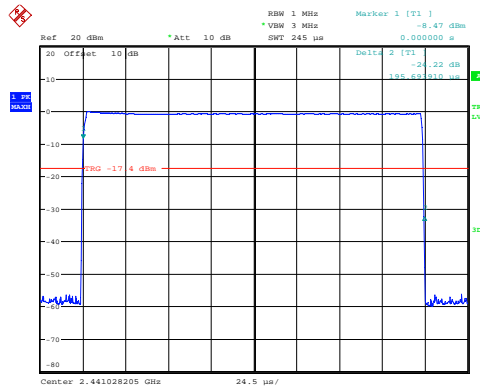

Date: 16.DEC.2019 14:05:32

TX On

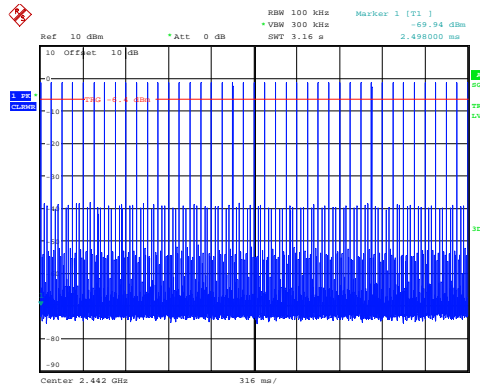

Date: 23.DEC.2019 12:28:47

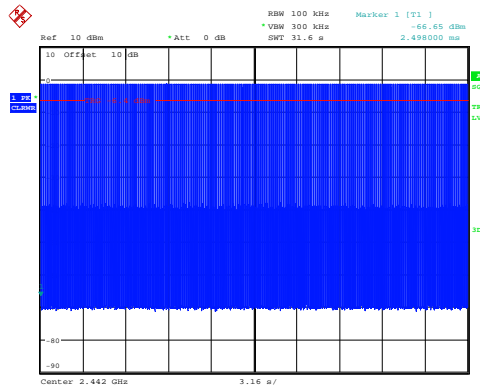

Date: 23.DEC.2019 12:28:23

Number of Transmissions in measurement period

Number of transmissions in a 3.16 second period = 40
 Number of transmissions in a 31.6 second period = 40 * 10 = 400

Mode 2: 2MBps					
Data Rate	Individual occupancy time (ms)	Observation period (s)	Number of hops observed	Average time of occupancy (s)	Result
2Mbps	0.1061666	15.6	810	0.085994946	PASS

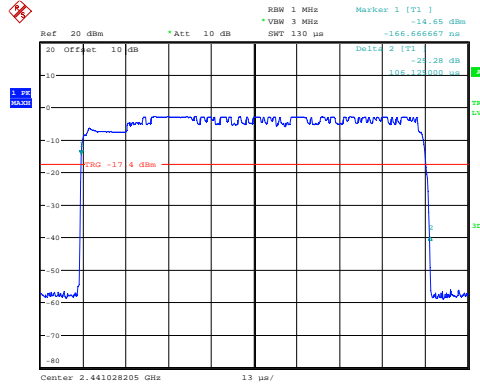

Date: 16.DEC.2019 14:01:03

TX On

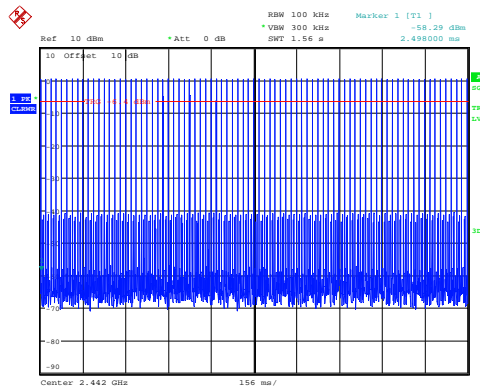

Date: 23.DEC.2019 12:32:49

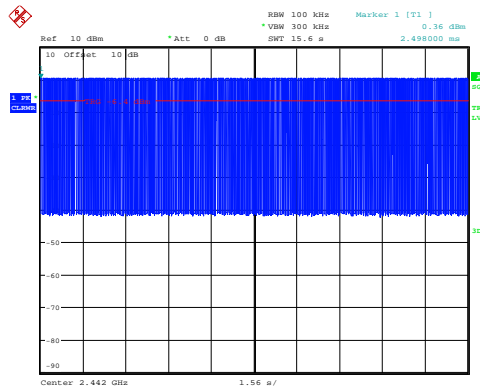

Date: 23.DEC.2019 12:32:22

Number of Transmissions in measurement period

Number of transmissions in a 1.56 second period = 81
 Number of transmissions in a 15.6 second period = 81 * 10 = 810

15 Maximum peak conducted output power

15.1 Definition

The maximum peak conducted output power is defined as the maximum power level measured with a peak detector using a filter with width and shape of which is sufficient to accept the signal bandwidth.

The maximum conducted output power is defined as the total transmit power delivered to all antennas and antenna elements averaged across all symbols in the signaling alphabet when the transmitter is operating at its maximum power control level.

15.2 Test Parameters

Test Location:	Element Skelmersdale
Test Chamber:	Radio Laboratory
Test Standard and Clause:	ANSI C63.10-2013, Clause 7.8.5
Frequencies Measured:	Mode 1: 2403 MHz / 2442 MHz / 2481 MHz – hopping disabled. Mode 2: 2404 MHz / 2442 MHz / 2480 MHz – hopping disabled / DTS
EUT Channel Bandwidths:	Mode 1: 1 MHz Mode 2: 2 MHz
Deviations From Standard:	None
Measurement BW:	Mode 1: 1 MHz Mode 2: 2 MHz
Spectrum Analyzer Video BW:	Mode 1: 3 MHz Mode 2: 5 MHz
Measurement Detector:	Peak
Voltage Extreme Environment Test Range:	Battery Power = new battery.

Environmental Conditions (Normal Environment)

Temperature: 23 °C	+15 °C to +35 °C (as declared)
Humidity: 29 % RH	20 % RH to 75 % RH (as declared)

15.3 Test Limit

- For frequency hopping systems operating in the band 902 to 928 MHz, the maximum peak conducted output power shall not exceed 1 W, and the e.i.r.p. shall not exceed 4 W, if the hopset uses 50 or more hopping channels; the maximum peak conducted output power shall not exceed 0.25 W, and the e.i.r.p. shall not exceed 1 W, if the hopset uses less than 50 hopping channels.
- For frequency hopping systems operating in the band 2400 to 2483.5 MHz and employing at least 75 hopping channels, the maximum peak conducted output power shall not exceed 1 W; for all other frequency hopping systems in the band, the maximum peak conducted output power shall not exceed 0.125 W. The e.i.r.p. shall not exceed 4 W.
- For frequency hopping systems operating in the band 5725 to 5850 MHz, the maximum peak conducted output power shall not exceed 1 W. The e.i.r.p. shall not exceed 4 W.
- Point-to-point systems in the bands 2400-2483.5 MHz and 5725 to 5850 MHz are permitted to have an e.i.r.p. higher than 4 W provided that the higher e.i.r.p. is achieved by employing higher gain directional antennas and not higher transmitter output powers.
- For systems employing digital modulation techniques operating in the bands 902 to 928 MHz, 2400 to 2483.5 MHz and 5725 to 5850 MHz, the maximum peak conducted output power shall not exceed 1 W.

15.4 Test Method

With the EUT setup as per section 9 of this report and connected as per Figure vi, the resolution bandwidth of the spectrum analyser was increased above the EUT occupied bandwidth and the peak emission data noted.

The measurements were performed with EUT set at its maximum duty. All modulation schemes, data rates and power settings were used to observe the worst-case configuration in each bandwidth.

Figure vi Test Setup

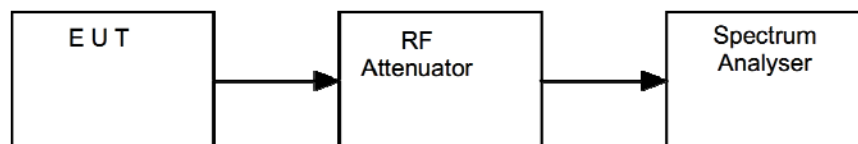

15.5 Test Equipment

Equipment Type	Manufacturer	Equipment Description	Element No	Due For Calibration
FSU26	R&S	Spectrum Analyser	U405	2020-10-21
SMBV100A	R&S	Signal Generator	U677	2020-05-07
AA18-10H	Atlantic Microwave	Attenuator	U634	Cal using U405 and U677

15.6 Test Results

Mode 1: 1 Mbps							
Channel Frequency (MHz)	Analyzer Level (dBm)	Cable loss (dB)	Maximum Peak Conducted Output power (dBm)	Maximum peak conducted output power (W)	Antenna gain (dBi)	E.I.R.P. (W)	Result
2402	-10.53	10.2	-0.33	0.0009	-0.82	0.00077	PASS
2442	-10.53	10.2	-0.33	0.0009	-0.82	0.00077	PASS
2481	-10.38	10.2	-0.18	0.0010	-0.82	0.00079	PASS

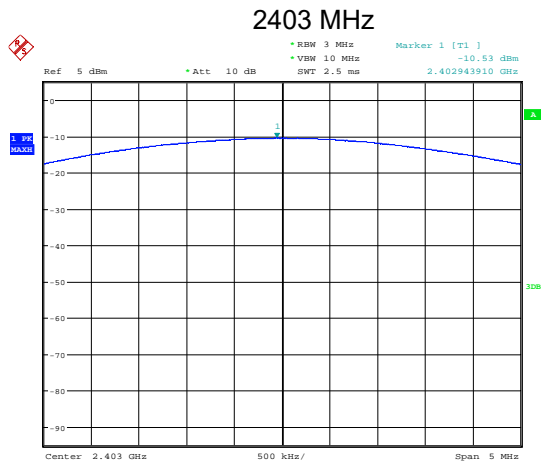

Date: 16.DEC.2019 12:39:09

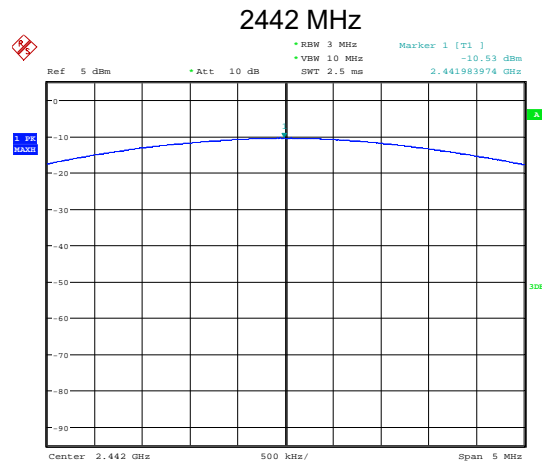

Date: 16.DEC.2019 12:39:55

2481 MHz

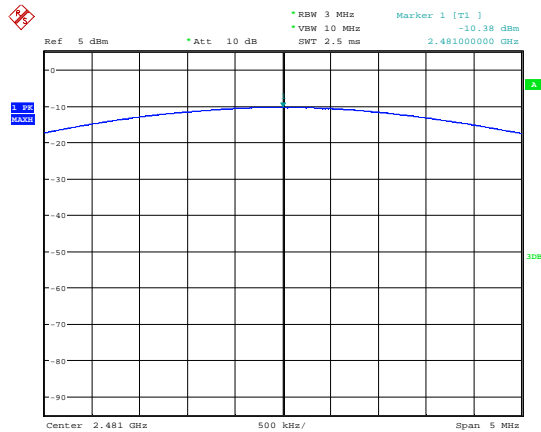

Date: 16.DEC.2019 12:40:17

Mode 2: 2 Mbps							
Channel Frequency (MHz)	Analyzer Level (dBm)	Cable loss (dB)	Maximum Peak Conducted Output power (dBm)	Maximum peak conducted output power (W)	Antenna gain (dBi)	E.I.R.P. (W)	Result
2404.00	-8.53	10.2	1.67	0.0015	-0.82	0.0012	PASS
2442.00	-8.61	10.2	1.59	0.0014	-0.82	0.0012	PASS
2480.00	-8.30	10.2	1.90	0.0015	-0.82	0.0013	PASS

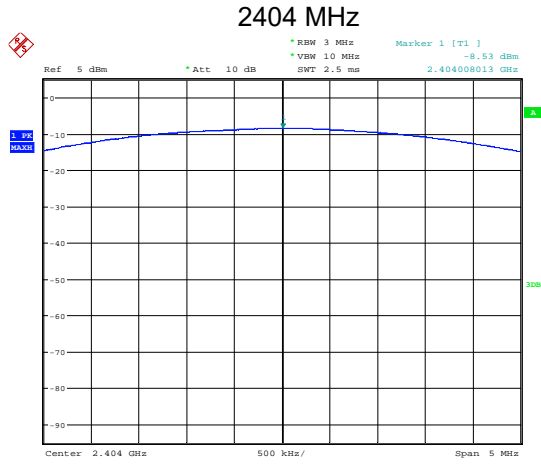

Date: 16.DEC.2019 12:33:51

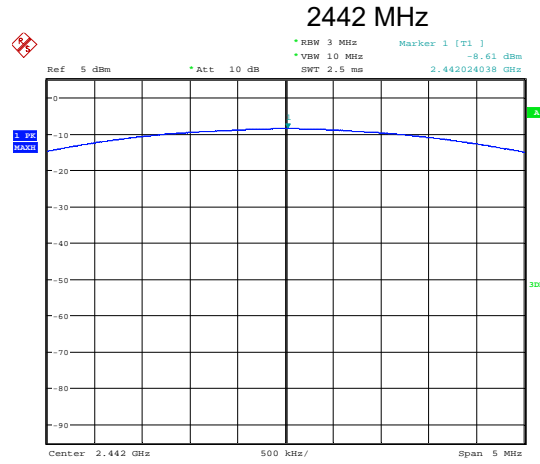

Date: 16.DEC.2019 12:34:08

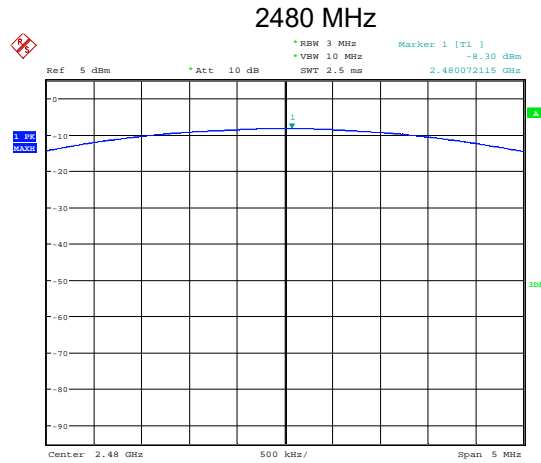

Date: 16.DEC.2019 12:33:27

16 Power spectral density

16.1 Definition

The power per unit bandwidth.

16.2 Test Parameters

Test Location:	Element Skelmersdale
Test Chamber:	Radio Laboratory
Test Standard and Clause:	ANSI C63.10-2013, Clause 11.10
EUT Channels / Frequencies Measured:	2404 MHz / 2442 MHz / 2480 MHz
EUT Channel Bandwidths:	2 MHz
Deviations From Standard:	None
Measurement BW:	30 kHz
Spectrum Analyzer Video BW: (requirement at least 3x RBW)	100 kHz
Measurement Span: (requirement 1.5 times Channel BW)	3 MHz
Measurement Detector:	Peak

Environmental Conditions (Normal Environment)

Temperature: 22 °C	+15 °C to +35 °C (as declared)
Humidity: 32 % RH	20 % RH to 75 % RH (as declared)

16.3 Test Limit

The transmitter power spectral density conducted from the transmitter to the antenna shall not be greater than 8 dBm in any 3 kHz band during any time interval of continuous transmission.

16.4 Test Method

With the EUT setup as per section 9 of this report and connected as per Figure vi, the peak emission of the EUT was measured on a spectrum analyser, with path losses taken into account.

The measurements were performed with EUT set at its maximum duty. All modulation schemes, data rates and power settings were used to observe the worst case configuration in each bandwidth.

Figure vi Test Setup

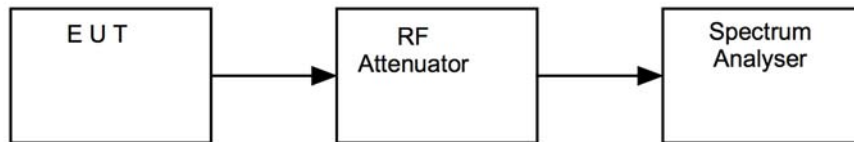

16.5 Test Equipment

Equipment Type	Manufacturer	Equipment Description	Element No	Due For Calibration
E4440A	Agilent	Spectrum Analyser	REF837	2020-07-16
AA18-03H	Atlantec	10dB SMA Attenuator	U634	Cal in Use

16.6 Test Results

Mode 2: 2 Mbps				
Channel Frequency (MHz)	Analyzer Level (dBm)	Cable loss (dB)	Power (dBm)	Result
2404	-1.85	N/A	-1.85	PASS
2442	-1.66	N/A	-1.66	PASS
2480	-1.43	N/A	-1.43	PASS

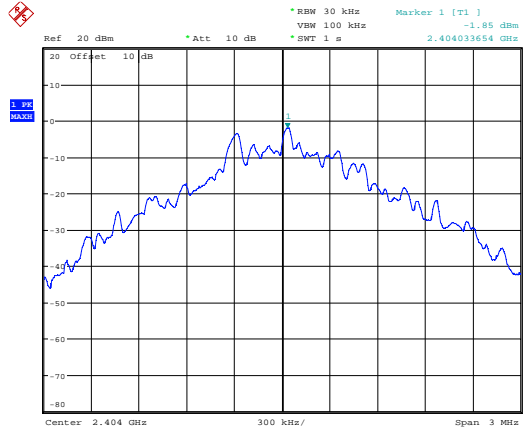

Date: 16.DEC.2019 20:54:21

2404 MHz

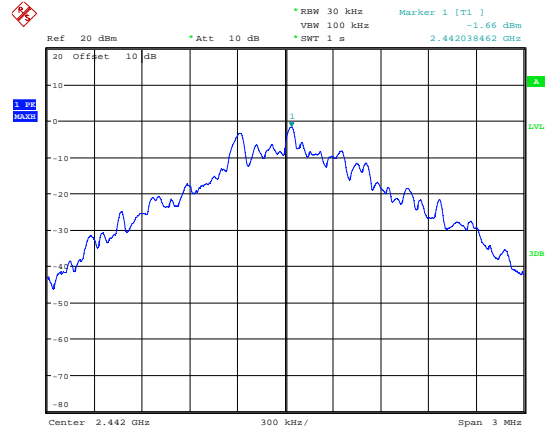

Date: 16.DEC.2019 20:54:40

2442 MHz

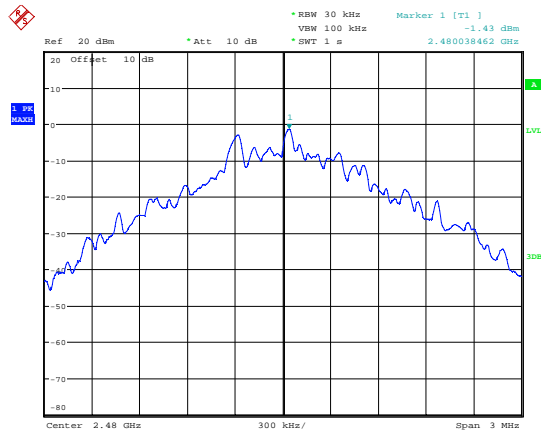

Date: 16.DEC.2019 20:53:55

2480 MHz

17 Occupied Bandwidth

17.1 Definition

The emission bandwidth (x dB) is defined as the frequency range between two points, one above and one below the carrier frequency, at which the spectral density of the emission is attenuated x dB below the maximum in-band spectral density of the modulated signal.

17.2 Test Parameters

Test Location:	Element Skelmersdale
Test Chamber:	Radio Laboratory
Test Standard and Clause:	ANSI C63.10-2013, Clause 11.8
Frequencies Measured:	Mode 1: 2403 MHz / 2442 MHz / 2481 MHz – hopping stopped. Mode 2: 2404 MHz / 2442 MHz / 2480 MHz – hopping stopped / DTS
EUT Channel Bandwidths:	Mode 1: 1 MHz Mode 2: 2 MHz
EUT Test Modulations:	Mode 1: 1MBps Binary GFSK Mode 2: 1MBps Binary GFSK
Deviations From Standard:	None
Measurement BW:	30 kHz / 100 kHz
Spectrum Analyzer Video BW:	100 kHz / 300 kHz
Measurement Span: (requirement 2 to 5 times OBW)	3 MHz / 5 MHz
Measurement Detector:	Peak

Environmental Conditions (Normal Environment)

Temperature: 23 °C	+15 °C to +35 °C (as declared)
Humidity: 29 % RH	20 % RH to 75 % RH (as declared)
Supply: 3.0 Vdc	

17.3 Test Limit

- For frequency hopping systems in the band 902 to 928 MHz: The maximum allowed -20 dB bandwidth of the hopping channel is 500 kHz.
- Frequency hopping systems operating in the band 5725 to 5850 MHz: The maximum -20 dB bandwidth of the hopping channel shall be 1 MHz
- For DTS The minimum -6 dB bandwidth shall be at least 500 kHz.

17.4 Test Method

With the EUT setup as per section 9 of this report and connected as per Figure vii, the bandwidth of the EUT was measured on a spectrum analyser.

The measurements were performed with EUT set at its maximum duty. All modulation schemes, data rates and power settings were used to observe the worst-case configuration in each bandwidth.

Figure vii Test Setup

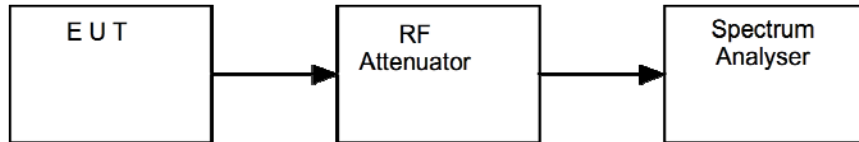

17.5 Test Equipment

Equipment Type	Manufacturer	Equipment Description	Element No	Due For Calibration
FSU26	R&S	Spectrum Analyser	U405	2020-10-21
AA18-03H	Atlantec	10dB SMA Attenuator	U634	Cal in Use

17.6 Test Results

Mode 1: 1 Mbps 20 dB Bandwidth				
Channel Frequency (MHz)	F_L (MHz)	F_H (MHz)	20dB Bandwidth (kHz)	Result
2403.0	2402.572115	2403.456731	884.616	PASS
2442.0	2441.576923	2442.456731	879.808	PASS
2481.0	2480.557692	2481.456731	899.039	PASS

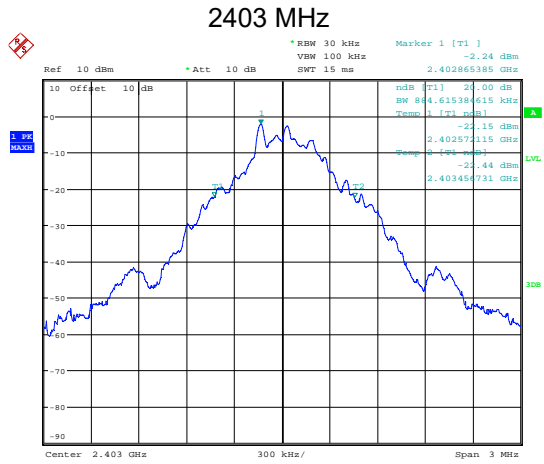

Date: 16.DEC.2019 12:03:00

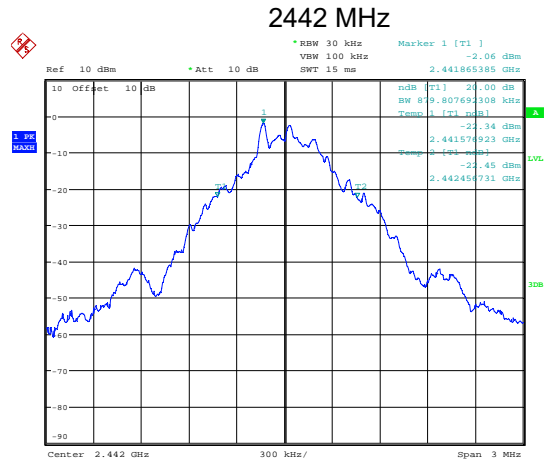

Date: 16.DEC.2019 12:04:06

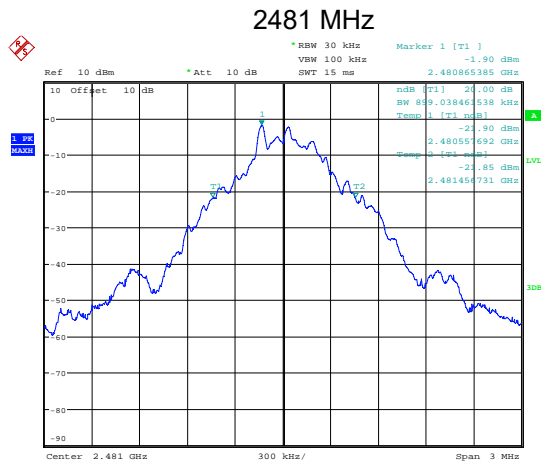

Date: 16.DEC.2019 12:05:45

Mode 2: 2Mbps 20 dB Bandwidth				
Channel Frequency (MHz)	F_L (MHz)	F_H (MHz)	20dB Bandwidth (kHz)	Result
2404.0	2403.334936	2404.673077	1338.141	PASS
2442.0	2441.334936	2442.673077	1338.141	PASS
2480.0	2479.334936	2480.673077	1338.141	PASS

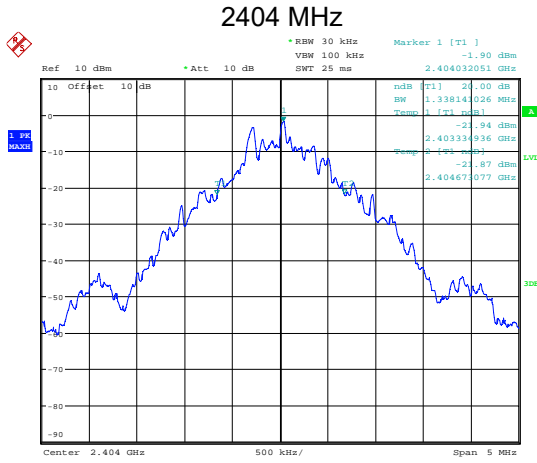

Date: 16.DEC.2019 12:24:19

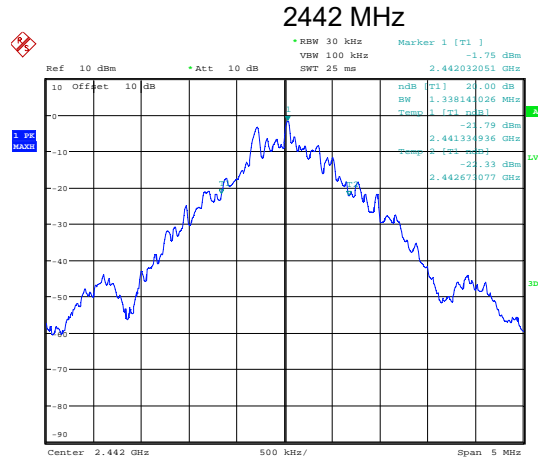

Date: 16.DEC.2019 12:25:08

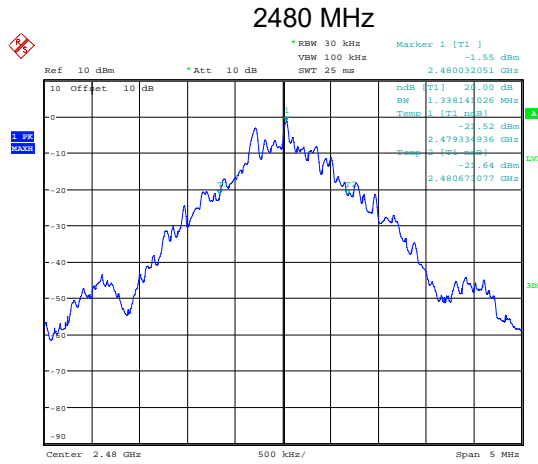

Date: 16.DEC.2019 12:23:31

Mode 2: 2 Mbps 6 dB DTS bandwidth				
Channel Frequency (MHz)	F_L (MHz)	F_H (MHz)	6dB Bandwidth (kHz)	Result
2404.0	2403.620192	2404.437500	817.308	PASS
2442.0	2441.620192	2442.437500	817.308	PASS
2480.0	2479.625000	2440.437500	812.500	PASS

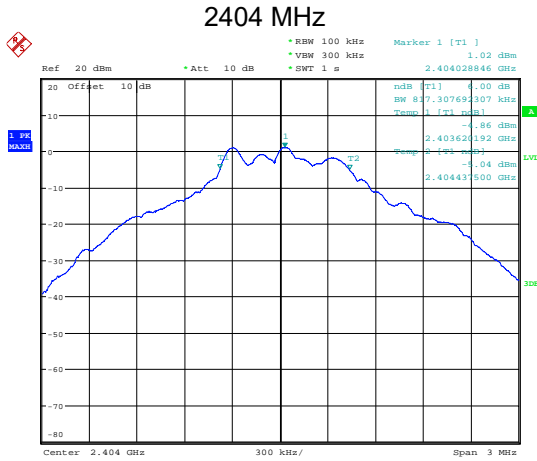

Date: 16.DEC.2019 20:37:02

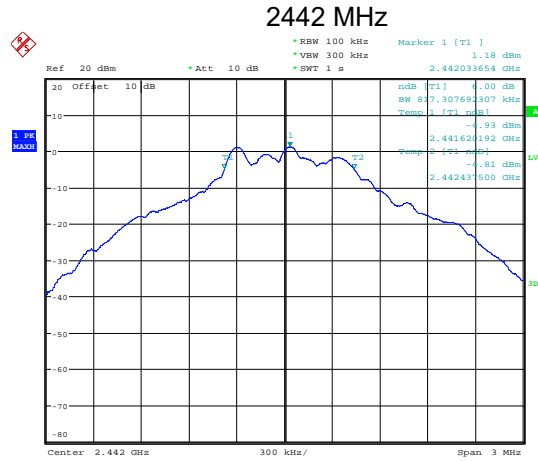

Date: 16.DEC.2019 20:37:28

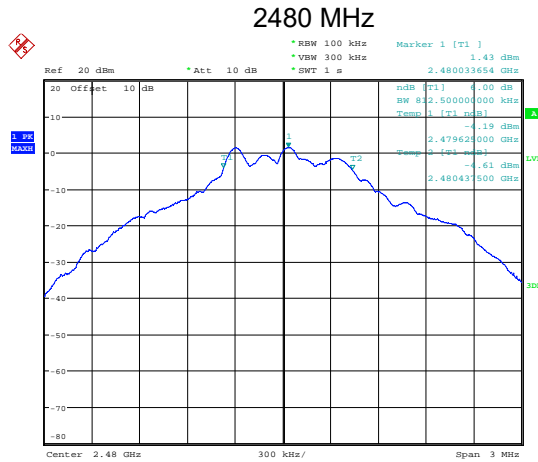

Date: 16.DEC.2019 20:37:50

18 Out-of-band and conducted spurious emissions

18.1 Definition

Out-of-band emission.

Emission on a frequency or frequencies immediately outside the necessary bandwidth that results from the modulation process but excluding spurious emissions.

Spurious emission.

Emission on a frequency or frequencies that are outside the necessary bandwidth and the level of which may be reduced without affecting the corresponding transmission of information. Spurious emissions include harmonic emissions, parasitic emissions, intermodulation products, and frequency conversion products, but exclude out-of-band emissions.

18.2 Test Parameters

Test Location:	Element Skelmersdale
Test Chamber:	Radio Laboratory
Test Standard and Clause:	ANSI C63.10-2013, Clause 7.8.8 ANSI C63.10-2013, Clause 11.11
Frequencies Measured:	Mode 1: 2403 MHz/2442 MHz/2481 MHz Mode 2: 2404 MHz/2442 MHz/2480 MHz
EUT Channel Bandwidths:	Mode 1: 1 MHz Mode 2: 2 MHz
Deviations From Standard:	None
Measurement BW:	100 kHz
Spectrum Analyzer Video BW: (requirement at least 3x RBW)	300 kHz
Measurement Detector:	Peak
Measurement Range:	9 kHz to 25 GHz

Environmental Conditions (Normal Environment)

Temperature: 23°C	+15 °C to +35 °C (as declared)
Humidity: 32 % RH	20 % RH to 75 % RH (as declared)
Supply: 3.0 Vdc	

18.3 Test Limits

In any 100 kHz bandwidth outside the frequency band in which the spread spectrum or digitally modulated device is operating, the RF power that is produced shall be at least 20 dB below that in the 100 kHz bandwidth within the band that contains the highest level of the desired power, based on either an RF conducted or a radiated measurement, provided that the transmitter demonstrates compliance with the peak conducted power limits. If the transmitter complies with the conducted power limits based on the use of root-mean-square averaging over a time interval, the attenuation required shall be 30 dB instead of 20 dB. Attenuation below the general field strength limits specified in FCC 47CFR15.209(a) / RSS-Gen is not required.

18.4 Test Method

With the EUT setup as per section 9 of this report and connected as per Figure viii, the emissions from the EUT were measured on a spectrum analyser.

The measurements were performed with EUT set at its maximum duty. All modulation schemes, data rates and power settings were used to observe the worst case configuration in each bandwidth.

Figure viii Test Setup

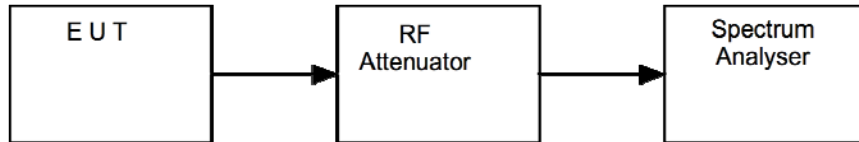

18.5 Test Equipment

Equipment Type	Manufacturer	Equipment Description	Element No	Due For Calibration
FSU26	R&S	Spectrum Analyser	U405	2020-10-21
SMBV100A	R&S	Signal Generator	U677	2020-05-07
AA18-10H	Atlantic Microwave	Attenuator	U634	Cal using U405 and U677

18.6 Test Results

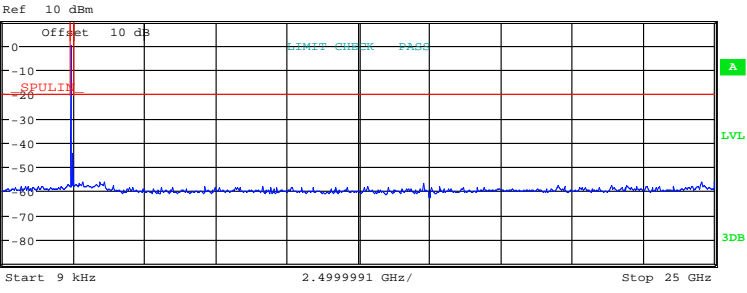
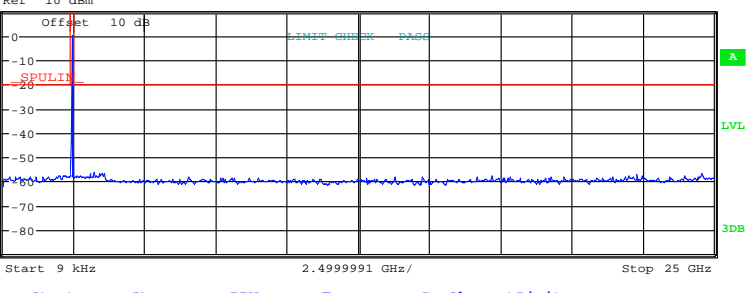
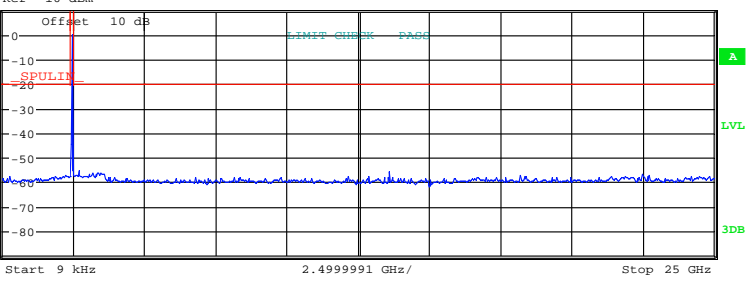
Mode 1: 1Mbps GFSK																																																																				
<p>2403 MHz</p>	 <table border="1"> <thead> <tr> <th>Start [Hz]</th> <th>Stop [Hz]</th> <th>RBW [Hz]</th> <th>Freq [Hz]</th> <th>PwrAbs [dBm]</th> <th>ΔLimit [dB]</th> </tr> </thead> <tbody> <tr><td>9.000 k</td><td>150.000 k</td><td>1.00 k</td><td>11.033654 k</td><td>-60.52</td><td>-40.27</td></tr> <tr><td>150.000 k</td><td>30.000 M</td><td>10.00 k</td><td>164.925000 k</td><td>-60.11</td><td>-39.86</td></tr> <tr><td>30.000 M</td><td>1.000 G</td><td>100.00 k</td><td>813.663000 M</td><td>-58.36</td><td>-38.11</td></tr> <tr><td>1.000 G</td><td>2.400 G</td><td>100.00 k</td><td>2.265460 G</td><td>-57.57</td><td>-37.32</td></tr> <tr><td>2.400 G</td><td>2.483 G</td><td>2.00 M</td><td>2.403023 G</td><td>-0.26</td><td>-20.26</td></tr> <tr><td>2.483 G</td><td>5.000 G</td><td>100.00 k</td><td>3.425174 G</td><td>-56.48</td><td>-36.23</td></tr> <tr><td>5.000 G</td><td>10.000 G</td><td>100.00 k</td><td>9.134500 G</td><td>-58.15</td><td>-37.90</td></tr> <tr><td>10.000 G</td><td>15.000 G</td><td>100.00 k</td><td>14.773500 G</td><td>-56.67</td><td>-36.42</td></tr> <tr><td>15.000 G</td><td>20.000 G</td><td>100.00 k</td><td>19.526000 G</td><td>-57.76</td><td>-37.51</td></tr> <tr><td>20.000 G</td><td>25.000 G</td><td>100.00 k</td><td>24.993500 G</td><td>-56.44</td><td>-36.19</td></tr> </tbody> </table>	Start [Hz]	Stop [Hz]	RBW [Hz]	Freq [Hz]	PwrAbs [dBm]	ΔLimit [dB]	9.000 k	150.000 k	1.00 k	11.033654 k	-60.52	-40.27	150.000 k	30.000 M	10.00 k	164.925000 k	-60.11	-39.86	30.000 M	1.000 G	100.00 k	813.663000 M	-58.36	-38.11	1.000 G	2.400 G	100.00 k	2.265460 G	-57.57	-37.32	2.400 G	2.483 G	2.00 M	2.403023 G	-0.26	-20.26	2.483 G	5.000 G	100.00 k	3.425174 G	-56.48	-36.23	5.000 G	10.000 G	100.00 k	9.134500 G	-58.15	-37.90	10.000 G	15.000 G	100.00 k	14.773500 G	-56.67	-36.42	15.000 G	20.000 G	100.00 k	19.526000 G	-57.76	-37.51	20.000 G	25.000 G	100.00 k	24.993500 G	-56.44	-36.19	<p>PASS</p>
Start [Hz]	Stop [Hz]	RBW [Hz]	Freq [Hz]	PwrAbs [dBm]	ΔLimit [dB]																																																															
9.000 k	150.000 k	1.00 k	11.033654 k	-60.52	-40.27																																																															
150.000 k	30.000 M	10.00 k	164.925000 k	-60.11	-39.86																																																															
30.000 M	1.000 G	100.00 k	813.663000 M	-58.36	-38.11																																																															
1.000 G	2.400 G	100.00 k	2.265460 G	-57.57	-37.32																																																															
2.400 G	2.483 G	2.00 M	2.403023 G	-0.26	-20.26																																																															
2.483 G	5.000 G	100.00 k	3.425174 G	-56.48	-36.23																																																															
5.000 G	10.000 G	100.00 k	9.134500 G	-58.15	-37.90																																																															
10.000 G	15.000 G	100.00 k	14.773500 G	-56.67	-36.42																																																															
15.000 G	20.000 G	100.00 k	19.526000 G	-57.76	-37.51																																																															
20.000 G	25.000 G	100.00 k	24.993500 G	-56.44	-36.19																																																															
<p>2442 MHz</p>	 <table border="1"> <thead> <tr> <th>Start [Hz]</th> <th>Stop [Hz]</th> <th>RBW [Hz]</th> <th>Freq [Hz]</th> <th>PwrAbs [dBm]</th> <th>ΔLimit [dB]</th> </tr> </thead> <tbody> <tr><td>9.000 k</td><td>150.000 k</td><td>1.00 k</td><td>9.451923 k</td><td>-61.87</td><td>-41.81</td></tr> <tr><td>150.000 k</td><td>30.000 M</td><td>10.00 k</td><td>164.925000 k</td><td>-62.46</td><td>-42.40</td></tr> <tr><td>30.000 M</td><td>1.000 G</td><td>100.00 k</td><td>617.949333 M</td><td>-58.24</td><td>-38.18</td></tr> <tr><td>1.000 G</td><td>2.400 G</td><td>100.00 k</td><td>1.964087 G</td><td>-57.67</td><td>-37.61</td></tr> <tr><td>2.400 G</td><td>2.483 G</td><td>2.00 M</td><td>2.442000 G</td><td>-0.09</td><td>-20.09</td></tr> <tr><td>2.483 G</td><td>5.000 G</td><td>100.00 k</td><td>3.193153 G</td><td>-56.65</td><td>-36.59</td></tr> <tr><td>5.000 G</td><td>10.000 G</td><td>100.00 k</td><td>6.542500 G</td><td>-58.41</td><td>-38.35</td></tr> <tr><td>10.000 G</td><td>15.000 G</td><td>100.00 k</td><td>13.801500 G</td><td>-58.09</td><td>-38.03</td></tr> <tr><td>15.000 G</td><td>20.000 G</td><td>100.00 k</td><td>17.171500 G</td><td>-57.88</td><td>-37.82</td></tr> <tr><td>20.000 G</td><td>25.000 G</td><td>100.00 k</td><td>24.578000 G</td><td>-56.88</td><td>-36.82</td></tr> </tbody> </table>	Start [Hz]	Stop [Hz]	RBW [Hz]	Freq [Hz]	PwrAbs [dBm]	ΔLimit [dB]	9.000 k	150.000 k	1.00 k	9.451923 k	-61.87	-41.81	150.000 k	30.000 M	10.00 k	164.925000 k	-62.46	-42.40	30.000 M	1.000 G	100.00 k	617.949333 M	-58.24	-38.18	1.000 G	2.400 G	100.00 k	1.964087 G	-57.67	-37.61	2.400 G	2.483 G	2.00 M	2.442000 G	-0.09	-20.09	2.483 G	5.000 G	100.00 k	3.193153 G	-56.65	-36.59	5.000 G	10.000 G	100.00 k	6.542500 G	-58.41	-38.35	10.000 G	15.000 G	100.00 k	13.801500 G	-58.09	-38.03	15.000 G	20.000 G	100.00 k	17.171500 G	-57.88	-37.82	20.000 G	25.000 G	100.00 k	24.578000 G	-56.88	-36.82	<p>PASS</p>
Start [Hz]	Stop [Hz]	RBW [Hz]	Freq [Hz]	PwrAbs [dBm]	ΔLimit [dB]																																																															
9.000 k	150.000 k	1.00 k	9.451923 k	-61.87	-41.81																																																															
150.000 k	30.000 M	10.00 k	164.925000 k	-62.46	-42.40																																																															
30.000 M	1.000 G	100.00 k	617.949333 M	-58.24	-38.18																																																															
1.000 G	2.400 G	100.00 k	1.964087 G	-57.67	-37.61																																																															
2.400 G	2.483 G	2.00 M	2.442000 G	-0.09	-20.09																																																															
2.483 G	5.000 G	100.00 k	3.193153 G	-56.65	-36.59																																																															
5.000 G	10.000 G	100.00 k	6.542500 G	-58.41	-38.35																																																															
10.000 G	15.000 G	100.00 k	13.801500 G	-58.09	-38.03																																																															
15.000 G	20.000 G	100.00 k	17.171500 G	-57.88	-37.82																																																															
20.000 G	25.000 G	100.00 k	24.578000 G	-56.88	-36.82																																																															
<p>2481 MHz</p>	 <table border="1"> <thead> <tr> <th>Start [Hz]</th> <th>Stop [Hz]</th> <th>RBW [Hz]</th> <th>Freq [Hz]</th> <th>PwrAbs [dBm]</th> <th>ΔLimit [dB]</th> </tr> </thead> <tbody> <tr><td>9.000 k</td><td>150.000 k</td><td>1.00 k</td><td>9.225962 k</td><td>-58.79</td><td>-38.73</td></tr> <tr><td>150.000 k</td><td>30.000 M</td><td>10.00 k</td><td>152.985000 k</td><td>-61.67</td><td>-41.61</td></tr> <tr><td>30.000 M</td><td>1.000 G</td><td>100.00 k</td><td>230.887000 M</td><td>-57.83</td><td>-37.77</td></tr> <tr><td>1.000 G</td><td>2.400 G</td><td>100.00 k</td><td>2.214827 G</td><td>-57.59</td><td>-37.53</td></tr> <tr><td>2.400 G</td><td>2.483 G</td><td>2.00 M</td><td>2.481012 G</td><td>0.05</td><td>-19.95</td></tr> <tr><td>2.483 G</td><td>5.000 G</td><td>100.00 k</td><td>2.666701 G</td><td>-55.51</td><td>-35.45</td></tr> <tr><td>5.000 G</td><td>10.000 G</td><td>100.00 k</td><td>8.112500 G</td><td>-58.13</td><td>-38.07</td></tr> <tr><td>10.000 G</td><td>15.000 G</td><td>100.00 k</td><td>13.583000 G</td><td>-56.00</td><td>-35.94</td></tr> <tr><td>15.000 G</td><td>20.000 G</td><td>100.00 k</td><td>18.177500 G</td><td>-57.40</td><td>-37.34</td></tr> <tr><td>20.000 G</td><td>25.000 G</td><td>100.00 k</td><td>22.488000 G</td><td>-57.03</td><td>-36.97</td></tr> </tbody> </table>	Start [Hz]	Stop [Hz]	RBW [Hz]	Freq [Hz]	PwrAbs [dBm]	ΔLimit [dB]	9.000 k	150.000 k	1.00 k	9.225962 k	-58.79	-38.73	150.000 k	30.000 M	10.00 k	152.985000 k	-61.67	-41.61	30.000 M	1.000 G	100.00 k	230.887000 M	-57.83	-37.77	1.000 G	2.400 G	100.00 k	2.214827 G	-57.59	-37.53	2.400 G	2.483 G	2.00 M	2.481012 G	0.05	-19.95	2.483 G	5.000 G	100.00 k	2.666701 G	-55.51	-35.45	5.000 G	10.000 G	100.00 k	8.112500 G	-58.13	-38.07	10.000 G	15.000 G	100.00 k	13.583000 G	-56.00	-35.94	15.000 G	20.000 G	100.00 k	18.177500 G	-57.40	-37.34	20.000 G	25.000 G	100.00 k	22.488000 G	-57.03	-36.97	<p>PASS</p>
Start [Hz]	Stop [Hz]	RBW [Hz]	Freq [Hz]	PwrAbs [dBm]	ΔLimit [dB]																																																															
9.000 k	150.000 k	1.00 k	9.225962 k	-58.79	-38.73																																																															
150.000 k	30.000 M	10.00 k	152.985000 k	-61.67	-41.61																																																															
30.000 M	1.000 G	100.00 k	230.887000 M	-57.83	-37.77																																																															
1.000 G	2.400 G	100.00 k	2.214827 G	-57.59	-37.53																																																															
2.400 G	2.483 G	2.00 M	2.481012 G	0.05	-19.95																																																															
2.483 G	5.000 G	100.00 k	2.666701 G	-55.51	-35.45																																																															
5.000 G	10.000 G	100.00 k	8.112500 G	-58.13	-38.07																																																															
10.000 G	15.000 G	100.00 k	13.583000 G	-56.00	-35.94																																																															
15.000 G	20.000 G	100.00 k	18.177500 G	-57.40	-37.34																																																															
20.000 G	25.000 G	100.00 k	22.488000 G	-57.03	-36.97																																																															

Band edge Mode 1:

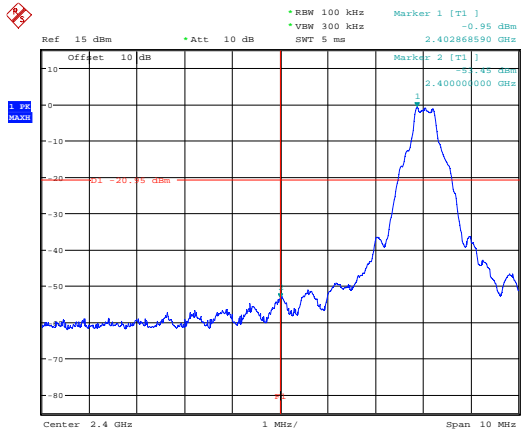

Date: 16.DEC.2019 12:50:25

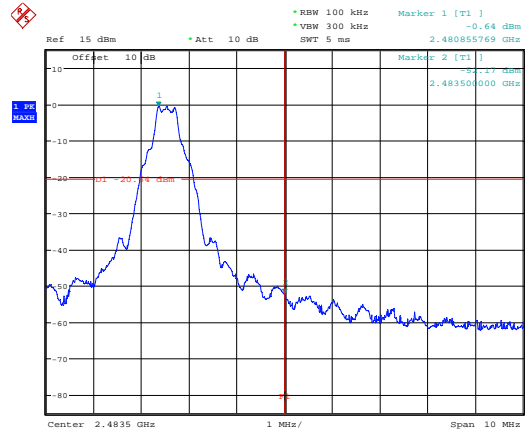

Date: 16.DEC.2019 12:52:49

Lower band edge single channel

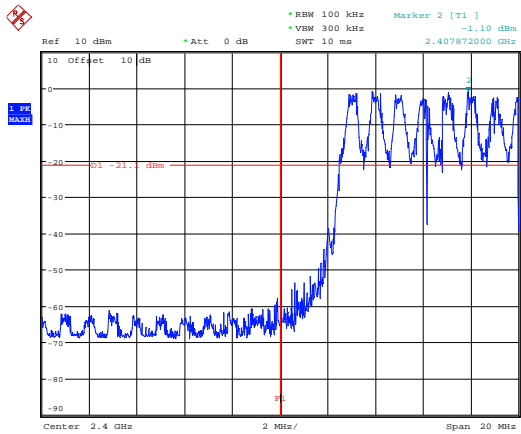

Date: 23.DEC.2019 16:14:49

Upper band edge single channel

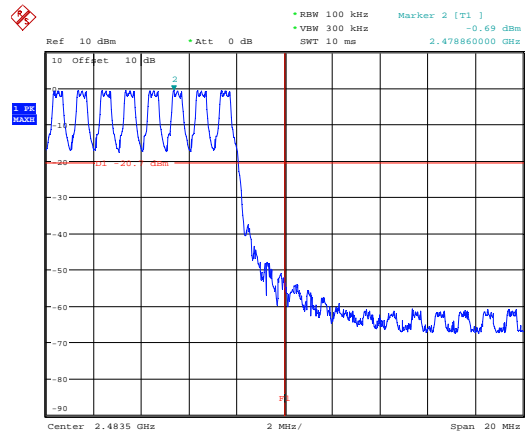

Date: 23.DEC.2019 16:39:04

Lower band edge hopping channel

Upper band edge hopping channel

Mode 2: 2MBps GFSK

Frequency (MHz)	SPUR	Plot	Result																																																																		
2404 MHz	SPUR	<table border="1"> <thead> <tr> <th>Start [Hz]</th> <th>Stop [Hz]</th> <th>RBW [Hz]</th> <th>Freq [Hz]</th> <th>PwrAbs [dBm]</th> <th>ΔLimit [dB]</th> </tr> </thead> <tbody> <tr><td>9.000 k</td><td>150.000 k</td><td>1.00 k</td><td>10.129808 k</td><td>-61.43</td><td>-43.13</td></tr> <tr><td>150.000 k</td><td>30.000 M</td><td>10.00 k</td><td>176.865000 k</td><td>-60.62</td><td>-42.32</td></tr> <tr><td>30.000 M</td><td>1.000 G</td><td>100.00 k</td><td>429.995667 M</td><td>-57.86</td><td>-39.56</td></tr> <tr><td>1.000 G</td><td>2.400 G</td><td>100.00 k</td><td>2.399907 G</td><td>-54.46</td><td>-36.16</td></tr> <tr><td>2.400 G</td><td>2.483 G</td><td>2.00 M</td><td>2.404033 G</td><td>1.72</td><td>-18.28</td></tr> <tr><td>2.483 G</td><td>5.000 G</td><td>100.00 k</td><td>3.033104 G</td><td>-56.19</td><td>-37.89</td></tr> <tr><td>5.000 G</td><td>10.000 G</td><td>100.00 k</td><td>7.148000 G</td><td>-57.13</td><td>-38.83</td></tr> <tr><td>10.000 G</td><td>15.000 G</td><td>100.00 k</td><td>14.704500 G</td><td>-57.54</td><td>-39.24</td></tr> <tr><td>15.000 G</td><td>20.000 G</td><td>100.00 k</td><td>17.907500 G</td><td>-57.52</td><td>-39.22</td></tr> <tr><td>20.000 G</td><td>25.000 G</td><td>100.00 k</td><td>24.271500 G</td><td>-56.87</td><td>-38.57</td></tr> </tbody> </table>	Start [Hz]	Stop [Hz]	RBW [Hz]	Freq [Hz]	PwrAbs [dBm]	ΔLimit [dB]	9.000 k	150.000 k	1.00 k	10.129808 k	-61.43	-43.13	150.000 k	30.000 M	10.00 k	176.865000 k	-60.62	-42.32	30.000 M	1.000 G	100.00 k	429.995667 M	-57.86	-39.56	1.000 G	2.400 G	100.00 k	2.399907 G	-54.46	-36.16	2.400 G	2.483 G	2.00 M	2.404033 G	1.72	-18.28	2.483 G	5.000 G	100.00 k	3.033104 G	-56.19	-37.89	5.000 G	10.000 G	100.00 k	7.148000 G	-57.13	-38.83	10.000 G	15.000 G	100.00 k	14.704500 G	-57.54	-39.24	15.000 G	20.000 G	100.00 k	17.907500 G	-57.52	-39.22	20.000 G	25.000 G	100.00 k	24.271500 G	-56.87	-38.57	PASS
Start [Hz]	Stop [Hz]	RBW [Hz]	Freq [Hz]	PwrAbs [dBm]	ΔLimit [dB]																																																																
9.000 k	150.000 k	1.00 k	10.129808 k	-61.43	-43.13																																																																
150.000 k	30.000 M	10.00 k	176.865000 k	-60.62	-42.32																																																																
30.000 M	1.000 G	100.00 k	429.995667 M	-57.86	-39.56																																																																
1.000 G	2.400 G	100.00 k	2.399907 G	-54.46	-36.16																																																																
2.400 G	2.483 G	2.00 M	2.404033 G	1.72	-18.28																																																																
2.483 G	5.000 G	100.00 k	3.033104 G	-56.19	-37.89																																																																
5.000 G	10.000 G	100.00 k	7.148000 G	-57.13	-38.83																																																																
10.000 G	15.000 G	100.00 k	14.704500 G	-57.54	-39.24																																																																
15.000 G	20.000 G	100.00 k	17.907500 G	-57.52	-39.22																																																																
20.000 G	25.000 G	100.00 k	24.271500 G	-56.87	-38.57																																																																
2442 MHz	SPUR	<table border="1"> <thead> <tr> <th>Start [Hz]</th> <th>Stop [Hz]</th> <th>RBW [Hz]</th> <th>Freq [Hz]</th> <th>PwrAbs [dBm]</th> <th>ΔLimit [dB]</th> </tr> </thead> <tbody> <tr><td>9.000 k</td><td>150.000 k</td><td>1.00 k</td><td>11.259615 k</td><td>-62.77</td><td>-44.49</td></tr> <tr><td>150.000 k</td><td>30.000 M</td><td>10.00 k</td><td>173.880000 k</td><td>-59.82</td><td>-41.54</td></tr> <tr><td>30.000 M</td><td>1.000 G</td><td>100.00 k</td><td>960.100667 M</td><td>-58.61</td><td>-40.33</td></tr> <tr><td>1.000 G</td><td>2.400 G</td><td>100.00 k</td><td>2.239093 G</td><td>-57.15</td><td>-38.87</td></tr> <tr><td>2.400 G</td><td>2.483 G</td><td>2.00 M</td><td>2.442000 G</td><td>1.89</td><td>-18.11</td></tr> <tr><td>2.483 G</td><td>5.000 G</td><td>100.00 k</td><td>3.598813 G</td><td>-55.88</td><td>-37.60</td></tr> <tr><td>5.000 G</td><td>10.000 G</td><td>100.00 k</td><td>9.178500 G</td><td>-58.26</td><td>-39.98</td></tr> <tr><td>10.000 G</td><td>15.000 G</td><td>100.00 k</td><td>14.974000 G</td><td>-57.37</td><td>-39.09</td></tr> <tr><td>15.000 G</td><td>20.000 G</td><td>100.00 k</td><td>19.687500 G</td><td>-58.11</td><td>-39.83</td></tr> <tr><td>20.000 G</td><td>25.000 G</td><td>100.00 k</td><td>21.042000 G</td><td>-57.28</td><td>-39.00</td></tr> </tbody> </table>	Start [Hz]	Stop [Hz]	RBW [Hz]	Freq [Hz]	PwrAbs [dBm]	ΔLimit [dB]	9.000 k	150.000 k	1.00 k	11.259615 k	-62.77	-44.49	150.000 k	30.000 M	10.00 k	173.880000 k	-59.82	-41.54	30.000 M	1.000 G	100.00 k	960.100667 M	-58.61	-40.33	1.000 G	2.400 G	100.00 k	2.239093 G	-57.15	-38.87	2.400 G	2.483 G	2.00 M	2.442000 G	1.89	-18.11	2.483 G	5.000 G	100.00 k	3.598813 G	-55.88	-37.60	5.000 G	10.000 G	100.00 k	9.178500 G	-58.26	-39.98	10.000 G	15.000 G	100.00 k	14.974000 G	-57.37	-39.09	15.000 G	20.000 G	100.00 k	19.687500 G	-58.11	-39.83	20.000 G	25.000 G	100.00 k	21.042000 G	-57.28	-39.00	PASS
Start [Hz]	Stop [Hz]	RBW [Hz]	Freq [Hz]	PwrAbs [dBm]	ΔLimit [dB]																																																																
9.000 k	150.000 k	1.00 k	11.259615 k	-62.77	-44.49																																																																
150.000 k	30.000 M	10.00 k	173.880000 k	-59.82	-41.54																																																																
30.000 M	1.000 G	100.00 k	960.100667 M	-58.61	-40.33																																																																
1.000 G	2.400 G	100.00 k	2.239093 G	-57.15	-38.87																																																																
2.400 G	2.483 G	2.00 M	2.442000 G	1.89	-18.11																																																																
2.483 G	5.000 G	100.00 k	3.598813 G	-55.88	-37.60																																																																
5.000 G	10.000 G	100.00 k	9.178500 G	-58.26	-39.98																																																																
10.000 G	15.000 G	100.00 k	14.974000 G	-57.37	-39.09																																																																
15.000 G	20.000 G	100.00 k	19.687500 G	-58.11	-39.83																																																																
20.000 G	25.000 G	100.00 k	21.042000 G	-57.28	-39.00																																																																
2480 MHz	SPUR	<table border="1"> <thead> <tr> <th>Start [Hz]</th> <th>Stop [Hz]</th> <th>RBW [Hz]</th> <th>Freq [Hz]</th> <th>PwrAbs [dBm]</th> <th>ΔLimit [dB]</th> </tr> </thead> <tbody> <tr><td>9.000 k</td><td>150.000 k</td><td>1.00 k</td><td>11.711538 k</td><td>-62.72</td><td>-44.82</td></tr> <tr><td>150.000 k</td><td>30.000 M</td><td>10.00 k</td><td>164.925000 k</td><td>-60.11</td><td>-42.21</td></tr> <tr><td>30.000 M</td><td>1.000 G</td><td>100.00 k</td><td>189.823667 M</td><td>-57.93</td><td>-40.03</td></tr> <tr><td>1.000 G</td><td>2.400 G</td><td>100.00 k</td><td>2.392347 G</td><td>-56.30</td><td>-38.40</td></tr> <tr><td>2.400 G</td><td>2.483 G</td><td>2.00 M</td><td>2.480051 G</td><td>2.11</td><td>-17.89</td></tr> <tr><td>2.483 G</td><td>5.000 G</td><td>100.00 k</td><td>2.484003 G</td><td>-54.18</td><td>-36.28</td></tr> <tr><td>5.000 G</td><td>10.000 G</td><td>100.00 k</td><td>9.382000 G</td><td>-57.64</td><td>-39.74</td></tr> <tr><td>10.000 G</td><td>15.000 G</td><td>100.00 k</td><td>13.623000 G</td><td>-58.06</td><td>-40.16</td></tr> <tr><td>15.000 G</td><td>20.000 G</td><td>100.00 k</td><td>18.066500 G</td><td>-58.28</td><td>-40.38</td></tr> <tr><td>20.000 G</td><td>25.000 G</td><td>100.00 k</td><td>24.809500 G</td><td>-56.29</td><td>-38.39</td></tr> </tbody> </table>	Start [Hz]	Stop [Hz]	RBW [Hz]	Freq [Hz]	PwrAbs [dBm]	ΔLimit [dB]	9.000 k	150.000 k	1.00 k	11.711538 k	-62.72	-44.82	150.000 k	30.000 M	10.00 k	164.925000 k	-60.11	-42.21	30.000 M	1.000 G	100.00 k	189.823667 M	-57.93	-40.03	1.000 G	2.400 G	100.00 k	2.392347 G	-56.30	-38.40	2.400 G	2.483 G	2.00 M	2.480051 G	2.11	-17.89	2.483 G	5.000 G	100.00 k	2.484003 G	-54.18	-36.28	5.000 G	10.000 G	100.00 k	9.382000 G	-57.64	-39.74	10.000 G	15.000 G	100.00 k	13.623000 G	-58.06	-40.16	15.000 G	20.000 G	100.00 k	18.066500 G	-58.28	-40.38	20.000 G	25.000 G	100.00 k	24.809500 G	-56.29	-38.39	PASS
Start [Hz]	Stop [Hz]	RBW [Hz]	Freq [Hz]	PwrAbs [dBm]	ΔLimit [dB]																																																																
9.000 k	150.000 k	1.00 k	11.711538 k	-62.72	-44.82																																																																
150.000 k	30.000 M	10.00 k	164.925000 k	-60.11	-42.21																																																																
30.000 M	1.000 G	100.00 k	189.823667 M	-57.93	-40.03																																																																
1.000 G	2.400 G	100.00 k	2.392347 G	-56.30	-38.40																																																																
2.400 G	2.483 G	2.00 M	2.480051 G	2.11	-17.89																																																																
2.483 G	5.000 G	100.00 k	2.484003 G	-54.18	-36.28																																																																
5.000 G	10.000 G	100.00 k	9.382000 G	-57.64	-39.74																																																																
10.000 G	15.000 G	100.00 k	13.623000 G	-58.06	-40.16																																																																
15.000 G	20.000 G	100.00 k	18.066500 G	-58.28	-40.38																																																																
20.000 G	25.000 G	100.00 k	24.809500 G	-56.29	-38.39																																																																

Band edge Mode 2:

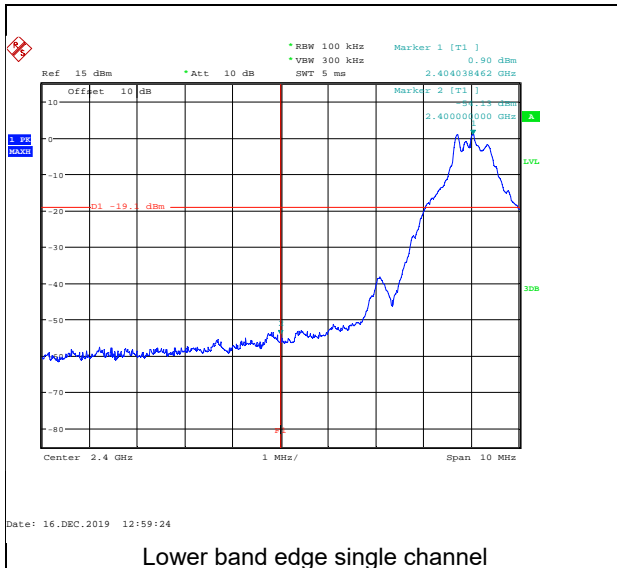

Lower band edge single channel

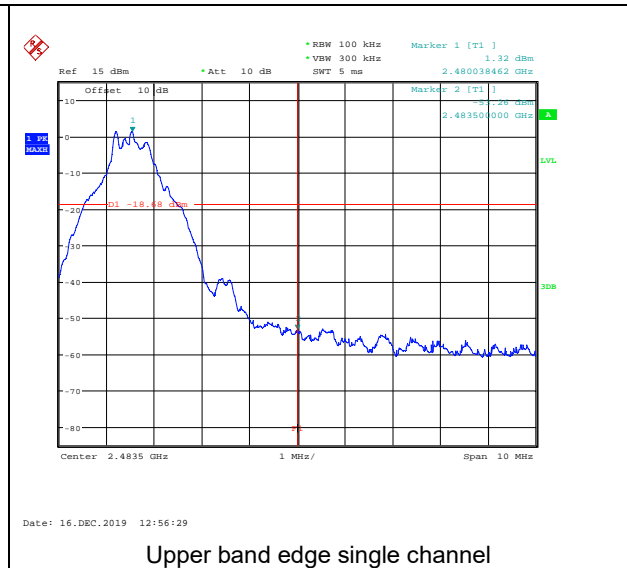

Upper band edge single channel

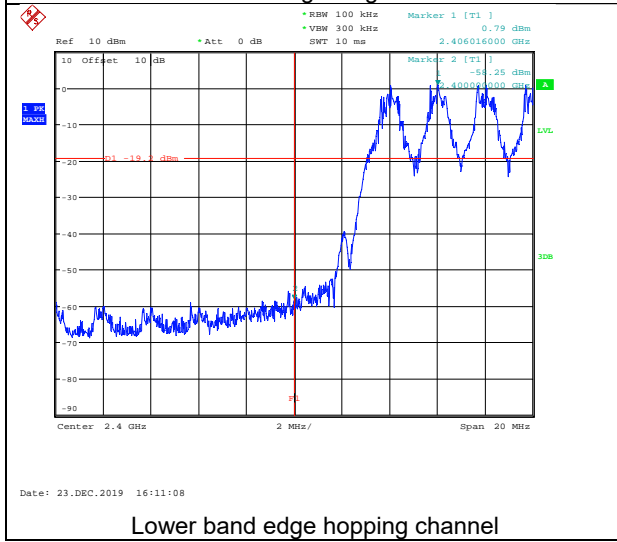

Lower band edge hopping channel

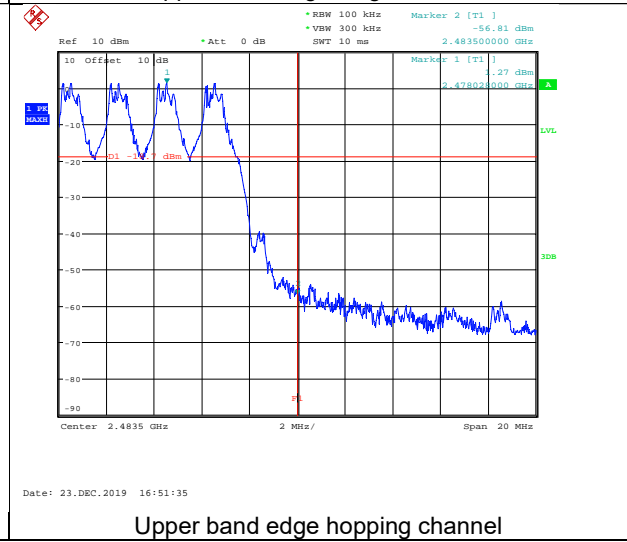

Upper band edge hopping channel

19 Measurement Uncertainty

Calculated Measurement Uncertainties

All statements of uncertainty are expanded standard uncertainty using a coverage factor of 1.96 to give a 95 % confidence:

[1] Radiated spurious emissions

Uncertainty in test result (30 MHz to 1 GHz) = **4.6 dB**

Uncertainty in test result (1 GHz to 18 GHz) = **4.7 dB**

[2] AC power line conducted emissions

Uncertainty in test result = **3.4 dB**

[3] Occupied bandwidth

Uncertainty in test result = **15.5 %**

[4] Conducted carrier power

Uncertainty in test result (Power Meter) = **1.08 dB**

[5] Conducted / radiated RF power out-of-band

Uncertainty in test result – up to 8.1 GHz = **3.31 dB**

Uncertainty in test result – 8.1 GHz to 15.3 GHz = **4.43 dB**

Uncertainty in test result (30 MHz to 1 GHz) = **4.75 dB**

Uncertainty in test result (1 GHz to 18 GHz) = **4.7 dB**

[6] Frequency separation

Uncertainty in test result (Spectrum Analyser) = **3.6 kHz**

[7] Accumulated channel occupancy time

Uncertainty in test result = **7.98 %**

[8] Radiated RF power out-of-band

Uncertainty in test result (30 MHz to 1 GHz) = **4.75 dB**

Uncertainty in test result (1 GHz to 18 GHz) = **4.46 dB**

[9] Power spectral density

Uncertainty in test result (Spectrum Analyser) = **3.11 dB**

[10] ERP / EIRP

Uncertainty in test result (Laboratory) = **4.71 dB**

Uncertainty in test result (Pershore OATS) = **4.26 dB**

20 RF Exposure

KDB 447498

Section 4.3 General SAR test reduction and exclusion guidance

For Standalone SAR exclusion consideration, when SAR Exclusion Threshold requirement in KDB 447498 is satisfied, standalone SAR evaluation for general population exposure conditions by measurement or numerical simulation is not required.

In the frequency range below 100 MHz to 6 GHz and test separation distance of 50mm, the SAR Test Exclusion Threshold for operation in the 2400 – 2483.5 MHz band will be determined as follows

SAR Exclusion Threshold (SARET)

SAR Exclusion Threshold = Step 1 + Step 2

Step 1

$$NT = [(MP/TSD^A) * \sqrt{f_{GHz}}]$$

NT = Numeric Threshold (3.0 for 1-g SAR and 7.5 for 10-g SAR)
 MP = Max Power of channel (mW) (inc tune up)
 TSD^A = Min Test separation Distance or 50mm (whichever is lower) = 50

We can transpose this formula to allow us to find the maximum power of a channel allowed and compare this to the measured maximum power.

$$= [(NT * TSD^A) / \sqrt{f_{GHz}}]$$

For Distances Greater than 50 mm Step 2 applies

Step 2

$$(TSD^B - 50mm) * 10\}$$

Where:

TSD^B = Min Test separation Distance (mm) = 50

Operating Frequency 2.402 GHz

$$\begin{aligned} \text{SARET} &= [(3.0 \times 50) / \sqrt{2.402}] + \{ (50 - 50) * 10 \} \\ \text{SARET} &= [150 / 1.55] + (0 * 10) \\ \text{SARET} &= 96.77\text{mW} \end{aligned}$$

Operating Frequency 2.442 GHz

$$\begin{aligned} \text{SARET} &= [(3.0 \times 50) / \sqrt{2.442}] + \{ (50 - 50) * 10 \} \\ \text{SARET} &= [150 / 1.56] + (0 * 10) \\ \text{SARET} &= 96.15\text{mW} \end{aligned}$$

Operating Frequency 2.481 GHz

$$\begin{aligned} \text{SARET} &= [(3.0 \times 50) / \sqrt{2.481}] + \{ (50 - 50) * 10 \} \\ \text{SARET} &= [150 / 1.57] + (0 * 10) \\ \text{SARET} &= 95.54\text{mW} \end{aligned}$$

Mode 1				
Evaluation Frequency	2402	2442	2481	MHz
SAR Exclusion Threshold	96.77	96.15	95.54	mW
Conducted Power	-0.33	-0.33	-0.18	dBm
Antenna Gain	-0.82	-0.82	-0.82	dBi
EIRP	0.77	0.77	0.79	mW
SAR Evaluation	Exempt			

Therefore standalone SAR evaluation for general population exposure conditions by measurement or numerical simulation is not required.

Operating Frequency 2.404 GHz

$$\begin{aligned} \text{SARET} &= [(3.0 \times 50) / \sqrt{2.404}] + \{ (50 - 50) * 10 \} \\ \text{SARET} &= [150 / 1.55] + (0 * 10) \\ \text{SARET} &= 96.77\text{mW} \end{aligned}$$

Operating Frequency 2.440 GHz

$$\begin{aligned} \text{SARET} &= [(3.0 \times 50) / \sqrt{2.44}] + \{ (50 - 50) * 10 \} \\ \text{SARET} &= [150 / 1.56] + (0 * 10) \\ \text{SARET} &= 96.15\text{mW} \end{aligned}$$

Operating Frequency 2.480 GHz

$$\begin{aligned} \text{SARET} &= [(3.0 \times 50) / \sqrt{2.48}] + \{ (50 - 50) * 10 \} \\ \text{SARET} &= [150 / 1.57] + (0 * 10) \\ \text{SARET} &= 95.54\text{mW} \end{aligned}$$

Mode 2				
Evaluation Frequency	2404	2440	2480	MHz
SAR Exclusion Threshold	96.77	96.15	95.54	Watts
Conduced Power	1.67	1.59	1.90	dBm
Antenna Gain	-0.82	-0.82	-0.82	dBi
EIRP	0.122	0.119	0.128	mW
SAR Evaluation	Exempt			

Therefore standalone SAR evaluation for general population exposure conditions by measurement or numerical simulation is not required.