



Willow Run (WR) Test Labs, Inc.
7117 Fieldcrest Dr.
Brighton, Michigan 48116 USA
Tel: (734) 252-9785
Fax: (734) 926-9785
e-mail: info@wrtest.com

Testing of

Electromagnetic Emissions

per

USA: CFR Title 47, Part 15.209 (Emissions)
Canada: ISED RSS-210/GEN (Emissions)

are herein reported for

Lear Corporation KOBJBG18A

Test Report No.: 20170420-RPTWAC0100054Br0

Copyright © 2017

Applicant/Provider:

Lear Corporation

21557 Telegraph Road Building 100, Southfield Michigan 48033 USA

Phone: +1 (248) 447-1357, Fax: +1 (248) 447-1683

Contact Person: Jason Summerford; jsummerford@lear.com

Data Recorded by:

Dr. Joseph Brunett, EMC-002790-NE

Reviewed by:

Dr. Joseph Brunett, EMC-002790-NE

Prepared by:

Dr. Joseph Brunett, EMC-002790-NE

Date of Issue:

April 20, 2017

Results of testing completed on (or before) April 17, 2017 are as follows.

Emissions: The transmitter intentional emissions **COMPLY** with the regulatory limit(s) by no less than 2.5 dB. Transmit chain spurious or harmonic emissions **COMPLY** by no less than 5.0 dB. Radiated spurious emissions associated with the receive chain of this device **COMPLY** the regulatory limit(s) by no less than 20 dB. Unintentional spurious emissions from digital circuitry **COMPLY** with radiated emission limit(s) by at least 20 dB.

Revision History

Rev. No.	Date	Details	Revised By
r0	April 20, 2017	Initial Release.	J. Brunett

Contents

Revision History	2
Table of Contents	2
1 Test Report Scope and Limitations	4
1.1 Laboratory Authorization	4
1.2 Report Retention	4
1.3 Subcontracted Testing	4
1.4 Limitation of Results	4
1.5 Copyright	4
1.6 Endorsements	4
1.7 Test Location	5
1.8 Traceability and Equipment Used	5
2 Test Specifications and Procedures	6
2.1 Test Specification and General Procedures	6
3 Configuration and Identification of the Equipment Under Test	7
3.1 Description and Declarations	7
3.1.1 EUT Configuration	7
3.1.2 Modes of Operation	7
3.1.3 Variants	7
3.1.4 Test Samples	8
3.1.5 Functional Exerciser	8
3.1.6 Modifications Made	8
3.1.7 Production Intent	8
3.1.8 Declared Exemptions and Additional Product Notes	8
4 Emissions	9
4.1 General Test Procedures	9
4.1.1 Radiated Test Setup and Procedures	9
4.1.2 Conducted Emissions Test Setup and Procedures	11
4.1.3 Power Supply Variation	11
4.1.4 Thermal Variation	11
4.2 Intentional Emissions	12
4.2.1 Fundamental Emission Pulsed Operation	12
4.2.2 Fundamental Emission Bandwidth	14
4.2.3 Fundamental Emission	15
4.3 Unintentional Emissions	16
4.3.1 Transmit Chain Spurious Emissions	16
4.3.2 Radiated Digital Spurious	17
5 Measurement Uncertainty	18

List of Tables

1	Test Site List.	5
2	Equipment List.	5
3	EUT Declarations.	7
4	Pulsed Emission Characteristics (Duty Cycle).	12
5	Intentional Emission Bandwidth.	14
6	Fundamental Radiated Emissions.	15
7	Transmit Chain Spurious Emissions.	16
8	Measurement Uncertainty.	18

List of Figures

1	Photos of EUT.	7
2	EUT Test Configuration Diagram.	8
3	Radiated Emissions Diagram of the EUT.	9
4	Radiated Emissions Test Setup Photograph(s).	10
5	Pulsed Emission Characteristics (Duty Cycle).	13
6	Intentional Emission Bandwidth.	14

1 Test Report Scope and Limitations

1.1 Laboratory Authorization

Test Facility description and attenuation characteristics are on file with the FCC Laboratory, Columbia, Maryland (FCC Reg. No: 688478) and with ISED Canada, Ottawa, ON (File Ref. No: IC8719A-1 and IC22227-1).

1.2 Report Retention

For equipment verified to comply with the regulations herein, the manufacturer is obliged to retain this report with the product records for the life of the product, and no less than ten years. A copy of this Report will remain on file with this laboratory until April 2027.

1.3 Subcontracted Testing

This report does not contain data produced under subcontract.

1.4 Limitation of Results

The test results contained in this report relate only to the item(s) tested. Any electrical or mechanical modification made to the test item subsequent to the test date shall invalidate the data presented in this report. Any electrical or mechanical modification made to the test item subsequent to this test date shall require reevaluation.

1.5 Copyright

This report shall not be reproduced, except in full, without the written approval of Willow Run (WR) Test Labs, Inc..

1.6 Endorsements

This report shall not be used to claim product endorsement by any accrediting, regulatory, or governmental agency.

1.7 Test Location

The EUT was fully tested by **Willow Run (WR) Test Labs, Inc.**, 7117 Fieldcrest Dr., Brighton, Michigan 48116 USA. Table 1 lists all sites employed herein. Specific test sites utilized are also listed in the test results sections of this report.

Table 1: Test Site List.

Description	Location	Quality Num.
OATS (3 meter)	8501 Beck Rd. Bldg 2227, Belleville MI 48111	OATSA

1.8 Traceability and Equipment Used

Pertinent test equipment used for measurements at this facility is listed in Table 2. The quality system employed at Willow Run (WR) Test Labs, Inc. has been established to ensure all equipment has a clearly identifiable classification, calibration expiry date, and that all calibrations are traceable to the SI through NIST, other recognized national laboratories, accepted fundamental or natural physical constants, ratio type of calibration, or by comparison to consensus standards.

Table 2: Equipment List.

Description	Manufacturer/Model	SN	Quality Num.	Last Cal By / Date Due
Spectrum Analyzer	Rohde & Schwarz / FSV30	101660	RSFSV30001	RS / May-2018
Spectrum Analyzer	Rohde & Schwarz / FSV4	101222	RSFSV4001	RS / Mar-2018
Shielded Loop Antenna	EMCO / 6502	9502-2926	EMCOLOOP1	Lib. Labs. / Aug-2017
Biconical	EMCO / 93110B	9802-3039	BICEMCO01	Lib. Labs / Aug-2017
Log Periodic Antenna	EMCO / 3146	9305-3614	LOGEMCO01	Lib. Labs / Aug-2017
Quad Ridge Horn	ETS Lind. / 3164-04	00066988	HRNQR316401	Lib. Labs / Aug-2017

2 Test Specifications and Procedures

2.1 Test Specification and General Procedures

The ultimate goal of Lear Corporation is to demonstrate that the Equipment Under Test (EUT) complies with the Rules and/or Directives below. Detailed in this report are the results of testing the Lear Corporation KOB-JBG18A for compliance to:

Country/Region	Rules or Directive	Referenced Section(s)
United States	Code of Federal Regulations	CFR Title 47, Part 15.209
Canada	ISED Canada	ISED RSS-210/GEN

It has been determined that the equipment under test is subject to the rules and directives above at the date of this testing. In conjunction with these rules and directives, the following specifications and procedures are followed herein to demonstrate compliance (in whole or in part) with these regulations.

ANSI C63.4:2014	"Methods of Measurement of Radio-Noise Emissions from Low-Voltage Electrical and Electronic Equipment in the Range of 9 kHz to 40 GHz"
ANSI C63.10:2013 (USA)	"American National Standard of Procedures for Compliance Testing of Unlicensed Wireless Devices"
IEEE Trans. EMC, Vol. 47, No. 3 August 2005	"Extrapolating Near-Field Emissions of Low-Frequency Loop Transmitters," J.D.Brunett, V.V.Liepa, D.L.Sengupta
ISED Canada	"The Measurement of Occupied Bandwidth"
ICES-003; Issue 6 (2016)	"Information Technology Equipment (ITE) Limits and methods of measurement"

3 Configuration and Identification of the Equipment Under Test

3.1 Description and Declarations

The equipment under test is an automotive transceiver. The EUT is approximately 9 x 13 x 2 cm in dimension, and is depicted in Figure 1. It is powered by 13.4 VDC vehicular power system. In use, this device is permanently affixed inside the body of a motor vehicle. Table 3 outlines provider declared EUT specifications.



Figure 1: Photos of EUT.

Table 3: EUT Declarations.

General Declarations			
Equipment Type:	Transceiver	Country of Origin:	Spain
Nominal Supply:	13.4 VDC	Oper. Temp Range:	-30°C to +60°C
Frequency Range:	0.125 MHz	Antenna Dimension:	10 cm
Antenna Type:	coil + metal loop	Antenna Gain:	Integral
Number of Channels:	1	Channel Spacing:	None
Alignment Range:	Not Declared	Type of Modulation:	ASK
United States			
FCC ID Number:	KOBBG18A	Classification:	DCD
Canada			
IC Number:	3521A-JBG18A	Classification:	Vehicle Device

3.1.1 EUT Configuration

The EUT is configured for testing as depicted in Figure 2.

3.1.2 Modes of Operation

The EUT operates as an LF transmitter with integral UHF receiver.

3.1.3 Variants

There are two variants of the EUT. Model "RFA PEPS 3" is a fully populated device with four (4) LF coil drivers (for Passive Entry and Passive Start actuation), UHF integral receiver, and associated digital components. Model "RFA PS 3" has only two LF coil drivers with for Passive Start only and non-used components are depopulated. Model RFA PEPS 3 is fully tested herein.

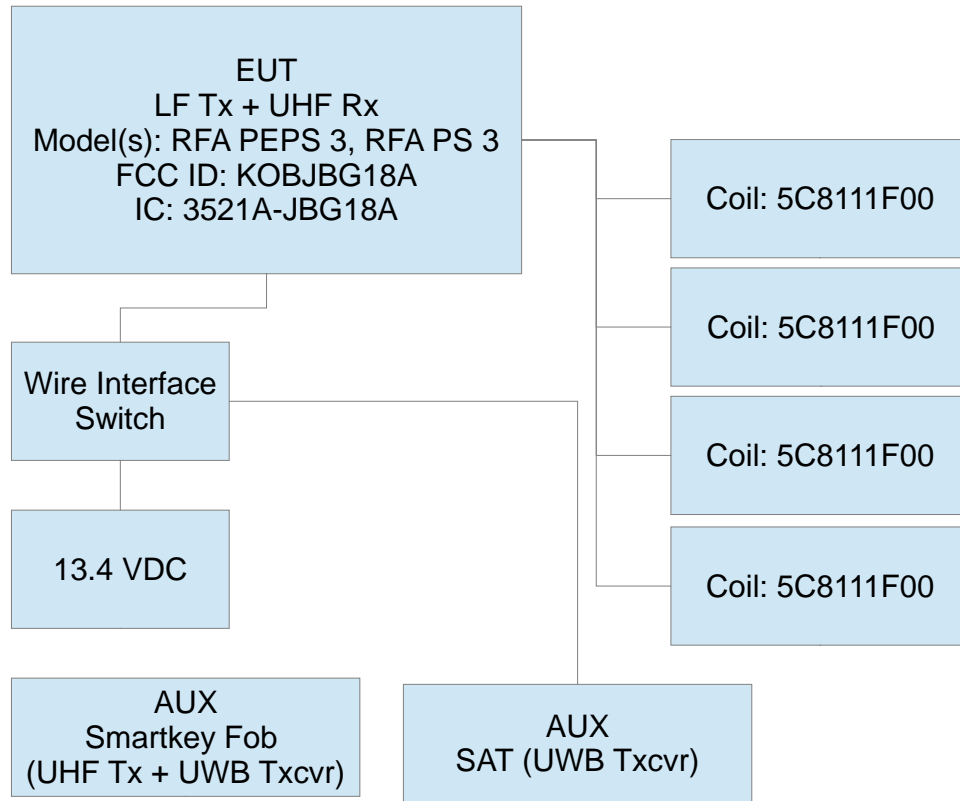

Figure 2: EUT Test Configuration Diagram.

3.1.4 Test Samples

Four samples in total were provided, two of each variant. Two normal operating samples paired with 315 MHz keyfob transmitters, and two samples software modified for CW LF transmission testing and photographs.

3.1.5 Functional Exerciser

EUT functionality was verified by observation of transmitted signal.

3.1.6 Modifications Made

There were no modifications made to the EUT by this laboratory.

3.1.7 Production Intent

The EUT appears to be a production ready sample.

3.1.8 Declared Exemptions and Additional Product Notes

The EUT is permanently installed in a transportation vehicle. As such, digital emissions are exempt from US and Canadian digital emissions regulations (per FCC 15.103(a) and IC correspondence on ICES-003).

4 Emissions

4.1 General Test Procedures

4.1.1 Radiated Test Setup and Procedures

Radiated electromagnetic emissions from the EUT are first pre-scanned in our shielded anechoic chamber or GTEM test cell. Spectrum and modulation characteristics of all emissions are recorded. Instrumentation, including spectrum analyzers and other test equipment as detailed in Section 1.7 are employed. After pre-scan, emission measurements are made on the test site of record. If the EUT connects to auxiliary equipment and is table or floor standing, the configurations prescribed in relevant test standards are followed. Alternatively, a layout closest to normal use (as declared by the provider) is employed if the resulting emissions appear to be worst-case in such a configuration. See Figure 3. All intentionally radiating elements that are not fixed-mounted in use are placed on the test table lying flat, on their side, and on their end (3-axes) and the resulting worst case emissions are recorded. If the EUT is fixed-mounted in use, measurements are made with the device oriented in the manner consistent with installation and then emissions are recorded.

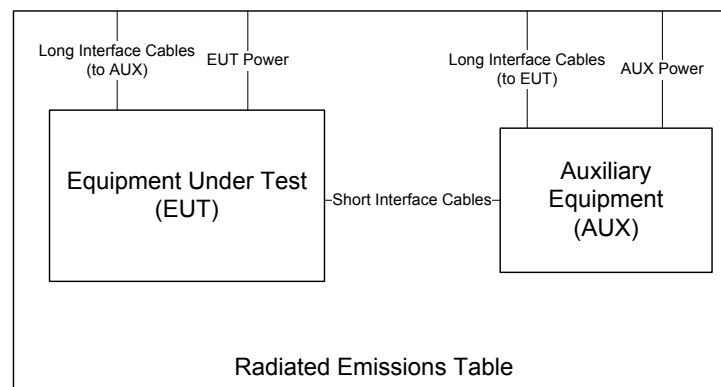

Figure 3: Radiated Emissions Diagram of the EUT.

If the EUT exhibits spurious emissions due to internal receiver circuitry, such emissions are measured with an appropriate carrier signal applied. For devices with intentional emissions below 30 MHz, a shielded loop antenna is used. It is placed at a 1 meter receive height. Emissions between 30 MHz and 1 GHz are measured using tuned dipoles and/or calibrated broadband antennas. For both horizontal and vertical polarizations, the test antenna is raised and lowered from 1 to 4 m in height until a maximum emission level is detected. The EUT is then rotated through 360° in azimuth until the highest emission is detected. The test antenna is then raised and lowered one last time from 1 to 4 m and the worst case value is recorded. Emissions above 1 GHz are characterized using standard gain horn or broadband ridge-horn antennas on our OATS with a 4 × 5 m rectangle of H-4 absorber placed over the ground screen covering the OATS ground screen. Care is taken to ensure that test receiver resolution and video bandwidths meet the regulatory requirements, and that the emission bandwidth of the EUT is not reduced. Photographs of the test setup employed are depicted in Figure 4.

Where regulations allow for direct measurement of field strength, power values (dBm) measured on the test receiver / analyzer are converted to dBμV/m at the regulatory distance, using

$$E_{dist} = 107 + P_R + K_A - K_G + K_E - C_F$$

where P_R is the power recorded on spectrum analyzer, in dBm, K_A is the test antenna factor in dB/m, K_G is the combined pre-amplifier gain and cable loss in dB, K_E is duty correction factor (when applicable) in dB, and C_F is a distance conversion (employed only if limits are specified at alternate distance) in dB. This field strength value is then compared with the regulatory limit. If effective isotropic radiated power (EIRP) is computed, it is computed as

$$EIRP(dBm) = E_{3m}(dB\mu V/m) - 95.2.$$

When presenting data at each frequency, the highest measured emission under all possible EUT orientations (3-axes) is reported.

When microwave measurements are made at a range different than the regulatory distance or made at close-range to improve receiver sensitivity, the reading is corrected back to the regulatory distance. This is done using a 20 dB/decade field behavior as dictated by the test procedures. When measurements are made in the near-field, the near-field/far-field boundary (N/F) is reported. It is computed as

$$N/F = 2D^2/\lambda$$

where D is the maximum dimension of the transmitter or receive antenna, and λ is the wavelength at the measurement frequency. Typically for high frequency measurements the receive antenna is connected to test receiver / analyzer through an external mixer. In this case, cable loss, IF amplifier gain, and mixer conversion losses are corrected for in the data table, or directly in the spectrum analyzer.

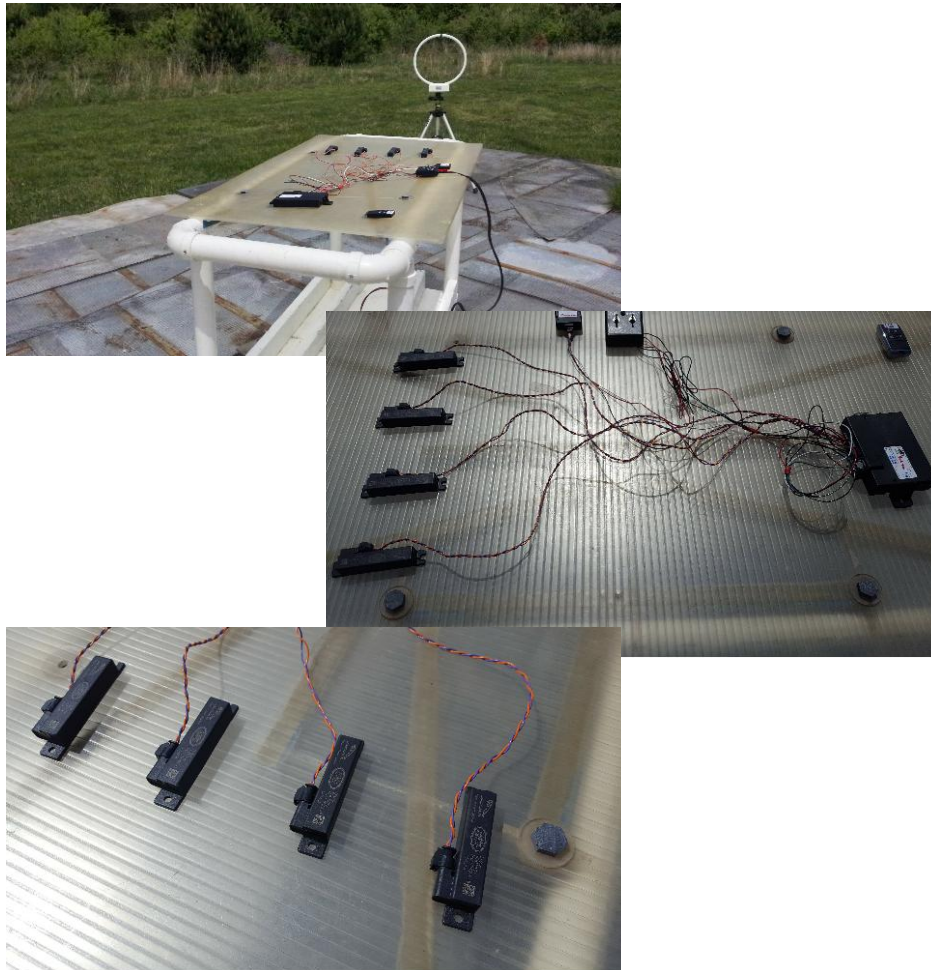

Figure 4: Radiated Emissions Test Setup Photograph(s).

4.1.2 Conducted Emissions Test Setup and Procedures

Vehicle Power Conducted Spurious The EUT is not subject to power line conducted emissions regulations as it is powered solely by the vehicle power system for use in said motor vehicle.

4.1.3 Power Supply Variation

Tests at extreme supply voltages are made if required by the the procedures specified in the test standard, and results of this testing are detailed in this report.

4.1.4 Thermal Variation

Tests at extreme temperatures are made if required by the procedures specified in the test standard, and results of this testing are detailed in this report. The provider has declared that the EUT is designed for operation over the temperature range -30°C to $+60^{\circ}\text{C}$. Before any temperature measurements are made, the equipment is allowed to reach a thermal balance in the test chamber, temperature and humidity are recorded, and thermal balance is verified via a thermocouple-based probe.

4.2 Intentional Emissions

4.2.1 Fundamental Emission Pulsed Operation

The details and results of testing the EUT for pulsed operation are summarized in Table 4. Plots showing the measurements made to obtain these values are provided in Figure 5.

Table 4: Pulsed Emission Characteristics (Duty Cycle).

Frequency Range	Det	IF Bandwidth	Video Bandwidth	Test Date:	12-Apr-17
9 kHz f 150 kHz	Pk/QPk	200 Hz	300 Hz	Test Engineer:	Joseph Brunett
150 kHz f 30 MHz	Pk/QPk	9 kHz	30 kHz	EUT Mode:	Nomral
25 MHz f 1 000 MHz	Pk/QPk	120 kHz	300 kHz	Meas. Distance:	10cm
f > 1 000 MHz	Pk	3 MHz	3MHz	EUT Tested:	Lear RFA
f > 1 000 MHz	Avg	3 MHz	10kHz		

#	EUT Mode	Overall Transmission			Internal Frame Characteristics			Computed Duty Cycle (per 100ms window)	
		Min. Repetition Rate (sec)	Max. No. of Frames	Total Transmission Length (sec)	Min. Frame Length (ms)	Min. Frame Period (ms)	Frame Encoding	(%)	Duty (dB)
1	Normal	Manual	3 sets	< 0.060	-	-	In the worst case, the EUT transmits one short wake frame, one encoded data frame, and one longer closing frame from each attached coil. These frames are interleaved sequentially between the antennas. Wake frame length is 700 us, data frame length is 12.75ms at 50% duty, and closing frame length is 4.0 ms. Three sets from three coils are transmitted in the worst case, for a total on time of 33.2 ms in any given 100 ms window.	33.2	-9.6
2									

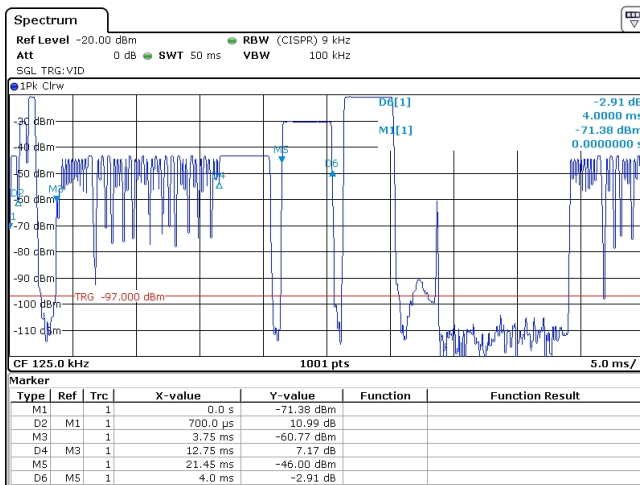
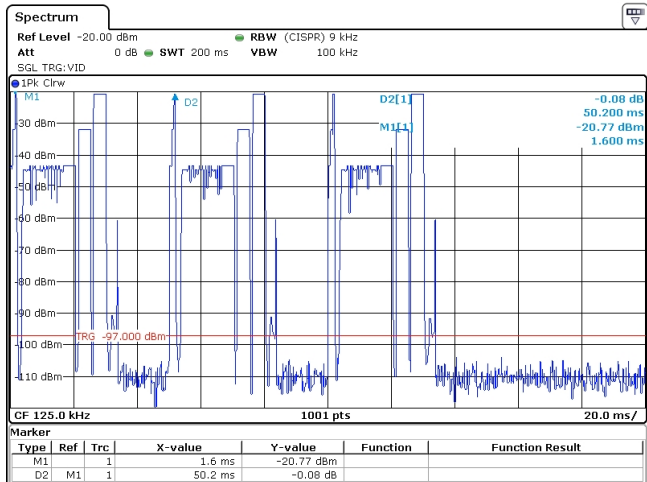
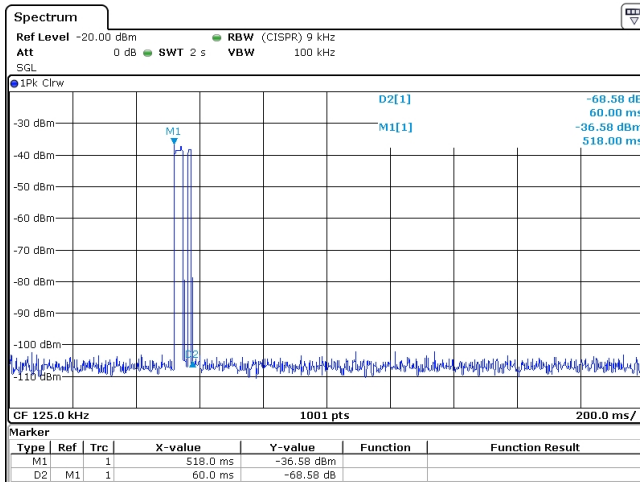

Figure 5: Pulsed Emission Characteristics (Duty Cycle).

4.2.2 Fundamental Emission Bandwidth

Emission bandwidth (EBW) of the EUT is measured with the device placed in the test mode(s) with the shortest available frame length and minimum frame spacing. Radiated emissions are recorded following the test procedures listed in Section 2.1. The 20 dB EBW is measured as the max-held peak-detected signal when the IF bandwidth is greater than or equal to 1% of the receiver span. For complex modulations other than ASK and FSK, the 99% emission bandwidth per IC test procedures has a different result, and is also separately reported. The results of EBW testing are summarized in Table 5. Plots showing measurements employed to obtain the emission bandwidth reported are provided in Figure 6.

Table 5: Intentional Emission Bandwidth.

Frequency Range 9 kHz f 150 kHz	Det Pk/QPk	IF Bandwidth > 1% Span	Video Bandwidth >= 3 * IFBW	Test Date: 1-Apr-17
				Test Engineer: Joseph Brunett
				EUT Mode: Normal
				Meas. Distance: 0.1 meters
				EUT: Lear RFA

#	Mode	Temp (C)	Supply (VDC)	99% PWR BW (kHz)	20 dB EBW (kHz)	110 kHz Restricted Band (dBc)
1	Normal	14	13.4	16.8	11.6	34.2

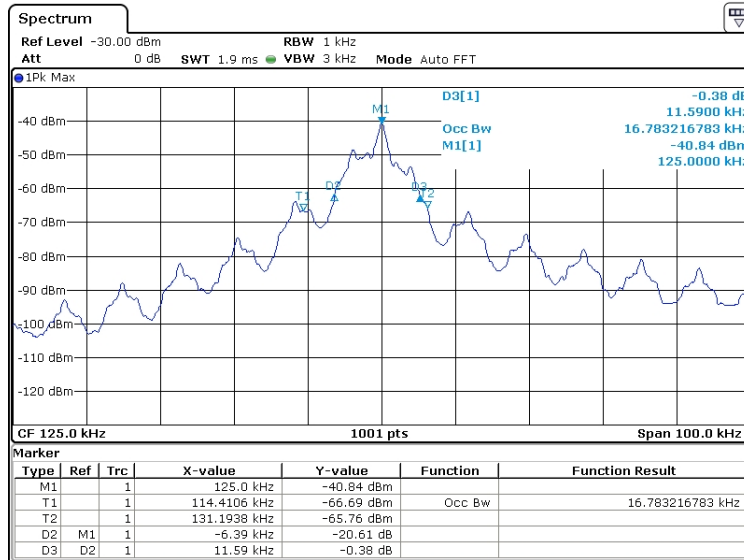

Figure 6: Intentional Emission Bandwidth.

4.2.3 Fundamental Emission

Following the test procedures listed in Section 2.1, field emissions measurements are made on the EUT for both Horizontal and Vertically polarized coupling fields. The EUT’s loop antenna(s) are measured when the EUT loop axes are (1) aligned along the same axis as the test loop antenna and horizontal with respect to the test site ground plane, (2) aligned coplanar (in the same plane) with the test antenna and aligned horizontal with respect to the test site ground plane, and (3) aligned coplanar (in the same plane) with the test antenna and vertical with respect to the test site ground plane. Table 6 details the results of these measurements.

Table 6: Fundamental Radiated Emissions.

Frequency Range	Det	IF Bandwidth	Video Bandwidth
9 kHz f 150 kHz	Pk/QPk	200 Hz	300 Hz
150 kHz f 30 MHz	Pk/QPk	9 kHz	30 kHz
25 MHz f 1 000 MHz	Pk/QPk	120 kHz	300 kHz
f > 1 000 MHz	Pk	3 MHz	3MHz
f > 1 000 MHz	Avg	3 MHz	10kHz

Test Date:	1-Apr-17
Test Engineer:	Joseph Brunett
EUT Mode:	CW
Meas. Distance:	3 meters
EUT Tested:	Lear RFA

#	Mode	Test Antenna Polarization	Freq. kHz	Ant. Used	Pr (Pk) dBm	Pr (QPk/Avg)* dBm	Ka dB/m	Kg dB	Cf** 3m / 300m (dB)	E300m (Pk) dBuV/m	E300m (QPk/Avg) dBuV/m	E300m Limit dBuV/m	Pass By
1	CW	Coaxial - Horz	125.0	S. Loop	-4.2	-13.8	9.9	0.0	80.0	32.7	23.1	25.7	2.5
2		Coplanar - Vert	125.0	S. Loop	-9.1	-18.7	9.9	0.0	80.0	27.8	18.2	25.7	7.4
3		Coplanar - Horz	125.0	S. Loop	-10.3	-19.9	9.9	0.0	80.0	26.6	17.0	25.7	8.6
4													
5													
6													
#	Mode	Polarization	Freq. kHz	DC Supply Voltage	Pr (Pk) dBm								
7	CW	Coaxial - Horz	125.0	9.00	-4.1								
8			125.0	13.40	-4.2								
9			125.0	18.00	-4.2								
10													
11													
12													

* Averaging applies up to 490 kHz as computed in Duty Cycle section of test report.

4.3 Unintentional Emissions

4.3.1 Transmit Chain Spurious Emissions

The results for the measurement of transmit chain spurious emissions at the nominal voltage and temperature are provided in Table 7. Following the test procedures listed in Section 2.1, field emissions measurements are made on the EUT for both Horizontal and Vertically polarized coupling fields. The EUT's loop antenna(s) are measured when the EUT loop axes are (1) aligned along the same axis as the test loop antenna and horizontal with respect to the test site ground plane, (2) aligned coplanar (in the same plane) with the test antenna and aligned horizontal with respect to the test site ground plane, and (3) aligned coplanar (in the same plane) with the test antenna and vertical with respect to the test site ground plane. The results for the measurement of transmit chain spurious emissions at the nominal voltage and temperature are provided in Table 7. Measurements are performed to 10 times the highest fundamental operating frequency.

Table 7: Transmit Chain Spurious Emissions.

Frequency Range	Det	IF Bandwidth	Video Bandwidth	Test Date:	1-Apr-17
9 kHz f 150 kHz	Pk/QPk	200 Hz	300 Hz	Test Engineer:	Joseph Brunett
150 kHz f 30 MHz	Pk/QPk	9 kHz	30 kHz	EUT Mode:	CW
25 MHz f 1 000 MHz	Pk/QPk	120 kHz	300 kHz	Meas. Distance:	3 meters
f > 1 000 MHz	Pk	3 MHz	3MHz	EUT Tested:	Lear RFA
f > 1 000 MHz	Avg	3 MHz	10kHz		

Transmit Chain Spurious Emissions														
#	Mode	Test Antenna Polarization	Freq. MHz	Ant. Used	Pr (Pk) dBm	Pr (QPk/Avg)* dBm	Ka dB/m	Kg dB	Cf 3/30/300m (dB)	E30/300m (Pk) dBuV/m	E30/300m (QPk/Avg) dBuV/m	E-field Limit (30/300m) dBuV/m	Pass By	Comments
1	CW	Max. All	250.0	S. Loop	-45.4	-55.0	9.9	0.0	80.0	-8.5	-18.1	19.6	37.7	
2		Max. All	375.0	S. Loop	-26.2	-35.8	9.9	0.0	80.0	10.7	1.1	16.1	15.0	
3		Max. All	500.0	S. Loop	-62.8		9.9	0.0	40.0	14.1		33.6	19.5	
4		Max. All	625.0	S. Loop	-50.2		9.9	0.0	40.0	26.7		31.7	5.0	background
5		Max. All	750.0	S. Loop	-64.2		9.9	0.0	40.0	12.7		30.1	17.4	
6		Max. All	875.0	S. Loop	-55.3		9.9	0.0	40.0	21.6		28.8	7.2	background
7		Max. All	1000.0	S. Loop	-66.7		9.9	0.0	40.0	10.2		27.6	17.4	
8		Max. All	1125.0	S. Loop	-57.3		9.9	0.0	40.0	19.6		26.6	7.0	background
9		Max. All	1250.0	S. Loop	-78.4		9.9	0.0	40.0	-1.5		25.7	27.2	
10														

* Averaging applies up to 490 kHz as computed in Duty Cycle section of test report.

4.3.2 Radiated Digital Spurious

The results for the measurement of digital spurious emissions are not reported herein as all digital emissions were greater than 20 dB below the regulatory limit. Radiation from digital components was measured to 4 GHz, or to five times the maximum digital component operating frequency, whichever is greater.

5 Measurement Uncertainty

The maximum values of measurement uncertainty for the laboratory test equipment and facilities associated with each test are given in the table below. This uncertainty is computed for a 95.45% confidence level based on a coverage factor of $k = 2$.

Table 8: Measurement Uncertainty.

Measured Parameter	Measurement Uncertainty [†]
Radio Frequency	$\pm(f_{Mkr}/10^7 + RBW/10 + (SPN/(PTS - 1))/2 + 1 \text{ Hz})$
Conducted Emm. Amplitude	$\pm 1.8 \text{ dB}$
Radiated Emm. Amplitude (30 – 200 MHz)	$\pm 2.7 \text{ dB}$
Radiated Emm. Amplitude (200 – 1000 MHz)	$\pm 2.5 \text{ dB}$
Radiated Emm. Amplitude ($f > 1000 \text{ MHz}$)	$\pm 3.7 \text{ dB}$
DC and Low Frequency Voltages	$\pm 2\%$
Temperature	$\pm 0.5^\circ\text{C}$
Humidity	$\pm 5\%$

[†]Ref: CISPR 16-4-2:2011+A1:2014