

TEST REPORT

Report Number: 101503619DEN-001A

Project Number: G101503619

Report Issue Date: March 10, 2014

Product Designation: Model: W0900-01 with PRO890-16 (Yagi Antenna)

Standards: FCC Part 15 Subpart C (15.247)
Operation within the bands 902-928 MHz

Tested by:
Intertek Testing Services NA, Inc.
1795 Dogwood St. Suite 200
Louisville, CO 80027

Client:
FreeWave Technologies, Inc.
5395 Pearl Parkway, Suite 100
Boulder, CO 80301

Report prepared by



Richard Georgerian
Senior Project Engineer

Report reviewed by



Michael Spataro
Engineering Team Leader

This report is for the exclusive use of Intertek's Client and is provided pursuant to the agreement between Intertek and its Client. Intertek's responsibility and liability are limited to the terms and conditions of the agreement. Intertek assumes no liability to any party, other than to the Client in accordance with the agreement, for any loss, expense or damage occasioned by the use of this report. Only the Client is authorized to permit copying or distribution of this report and then only in its entirety. Any use of the Intertek name or one of its marks for the sale or advertisement of the tested material, product or service must first be approved in writing by Intertek. The observations and test results in this report are relevant only to the sample tested. This report by itself does not imply that the material, product, or service is or has ever been under an Intertek certification program.

TABLE OF CONTENTS

1 Introduction and Conclusion..... 3

2 Test Summary 4

3 Description of Product Under Test 6

4 System setup including cable interconnection details, support equipment and simplified block diagram 9

5 AC Voltage Variation/ Battery Requirement..... 13

6 Antenna Requirement..... 13

7 DTS Requirement..... 13

8 DTS Bandwidth (6dB Bandwidth)..... 13

9 RF Conducted Output Power..... 13

10 RF Conducted Spurious Emissions (-20dBc) – Including Band Edge..... 13

11 Transmitter Radiated Spurious Emissions – Restricted Band/ Band Edge 14

12 Power Spectral Density – PSD..... 25

13 Radiated Emissions (Digital Part of Receiver) 25

14 AC Mains Conducted Emissions - Transmitter 25

15 RF Exposure Requirement 25

16 Duty Cycle/ Duty Cycle Correction Factor 25

17 Appendix A: Antenna Specifications 26

18 Measurement Uncertainty..... 27

19 Revision History 28

1 Introduction and Conclusion

The tests indicated in section 2.0 were performed on the product constructed as described in section 3.0. The remaining test sections are the verbatim text from the actual data sheets used during the investigation. These test sections include the test name, the specified test Method, a list of the actual Test Equipment Used, documentation Photos, Results and raw Data. No additions, deviations, or exclusions have been made from the standard(s) unless specifically noted.

Based on the results of our investigation, we have concluded **the product tested complies with the requirements of the standard(s) indicated**. The results obtained in this test report pertain only to the item(s) tested.

1.1 Test Report Scope

FCC Class II Permissive Change

The scope of this report was to qualify the existing approved radio module Model: W0900-01 with new antennas. This specific report covers the following antenna:

- Model: PRO890-16 (5' Yagi antenna)

This radio operates in the following 802.11 b/g Tx Band: 902 – 928MHz.

The Model: W0900-01 has previously been fully qualified and documented in the following SPORTON LAB test reports:

- FCC Test Report Number: KNYPRW1001ER

Below is a summary of Intertek Test Reports associated with the Class II Permissive Change:

- **5' Yagi antenna (900MHz): 101503619DEN-001A (This Report)**

1.2 Test Methodology

All measurements were performed according to the procedures in the following documents:

- ANSI C63.10: 2013 – ANSI Standard for Testing Unlicensed Wireless Devices
- FCC Publication 558074, April 9, 2013 (Guidelines for Compliance Measurements on DTS Operating Under 15.247)

Radiated emissions tests were formed at an antenna-to-product distance of 3-meters.

1.3 Test Facility

Intertek Denver's testing facilities are located at 1795 Dogwood St. Suite 200 Louisville, CO 80027. The testing facility is ISO17025:2005 accredited by A2LA, our lab code is 2506.02, our VCCI registration numbers are. R-1643, C-1752 and T-1558, our FCC designation no. US1121 and our IC lab no. 2042N.

Testing contained in this test report may not be covered under the laboratories scope of accreditation. A note will be placed in the specific test section for testing not covered under the laboratories scope.

2 Test Summary

TEST SECTION	TESTS	FCC REFERENCE	TEST DATE	RESULT
5	AC Voltage Variation	FCC 15.31(e)	-----	N/A
6	Antenna Requirement	FCC 15.203	-----	N/A
7	DTS Requirement	FCC 15.247(a)	-----	N/A
8	6dB Bandwidth	FCC 15.247(a)(2)	-----	N/A
9	RF Conducted Output Power (includes requirements for antenna gain > 6dBi)	FCC 15.247(b)(3)(4) FCC 15.247(c)(1)	-----	N/A
10	RF Conducted Spurious Emissions (- 20dBc) Includes Band Edge	FCC 15.247(d)	-----	N/A
11	Transmitter Radiated Spurious Emissions (Restricted Bands – Band Edge)	FCC 15.247(d) FCC 15.209/ 15.205	02/25/2014 to 02/26/2014	Complies
12	Power Spectral Density (PSD)	FCC 15.247(e)	-----	N/A
13	Radiated Emissions – Digital Receiver	FCC 15.109	-----	N/A
14	Tx AC Line Conducted Emissions	FCC 15.207	-----	N/A
15	RF Exposure Requirement	FCC 15.247(i) FCC 15.1.1307(b)(1)	-----	N/A
16	Duty Cycle/ Duty Cycle Correction Factor	FCC 15.35(c)	-----	N/A

Notes:

- 1) All Tx Radiated Emission measurements in this report utilized the transmit channels and worst-case band(s), modulation and data rates reported in the FCC report(s) listed on page 3 of this report.
- 2) Only selected testing required for the specific Class II Permissive change was performed.

General Radio Test Notes:

- ANSI C63.10, Section 4.2.3.2/ FCC 15.35: Measurement detector functions and bandwidths utilized in this testing were per the preceding guidelines.
- ANSI C63.10, Section 4.2.3.2.2/ FCC 15.35(b): When an average limit is specified, the peak emission must also be measured to ensure the emissions is less than 20dB above the average limit and/or below the peak limit specified. This report includes both average and peak test data.
- ANSI C63.10, Section 5.3/ FCC 15.31: All radiated field strength measurements taken at an antenna-to-product test distance of 3-meters.
- ANSI C63.10, Section 6.3/ FCC 15.31(m): Measurements were taken at the lowest, near the middle and highest channels of the product tested.

3 Description of Product Under Test

Model:	W0900-01 (900 MHz)
Type of EUT:	802.11 b/g PCIe Radio Module
Serial Number:	DEN1402111313
FCC ID:	KNYPRW1001ER
Industry Canada ID:	IC ID: -----
Related Submittal(s) Grants:	-----
Company:	FreeWave Technologies, Inc.
Customer:	FreeWave Technologies, Inc.
Address:	5395 Pearl Parkway, Suite 100
Phone:	(303) 962-7879
Fax:	-----
e-mail:	dbusch@freewave.com
Test Standards:	<input checked="" type="checkbox"/> 47 CFR, Part 15C:§15.247 DTS <input type="checkbox"/> RSS-210, Issue 8, 2010 <input type="checkbox"/> RSS-Gen, Issue 3, 2010 <input type="checkbox"/> 47 CFR, Part 15C:§15.207 <input type="checkbox"/> Other
Type of radio:	<input checked="" type="checkbox"/> Stand -alone <input type="checkbox"/> Module <input type="checkbox"/> Hybrid
Date Sample Submitted:	02/14/2014
Test Work Started:	02/25/2014
Test Work Completed:	02/27/2014
Test Sample Conditions:	<input type="checkbox"/> Damaged <input type="checkbox"/> Poor (Usable) <input checked="" type="checkbox"/> Good

Product Description:	Wireless router utilized in M2M industrial applications
Transmitter Type:	<input type="checkbox"/> FHSS <input checked="" type="checkbox"/> Digital Modulation <input type="checkbox"/> WiFi <input type="checkbox"/> Blue Tooth
Operating Frequency Range(s):	902MHz to 928MHz
Number of Channels:	IEEE 802.11b, IEEE 802.11g, one channel at 915 MHz. 900 MHz – 928 MHz
Modulation:	802.11b: DSSS-DBPSK, DQPSK, CCK 802.11g: OFDM-BPSK, QPSK, 16QAM, 64QAM
Antenna(s) Info:	Antenna: Type: 900 MHz Yagi antenna Gain: +16.0 dBi Connector Type: "N" External Antenna(s) (Dedicated) – Point-to-Point
Rated Power:	EIRP 20 dBm (100 mW) : Yagi
Antenna Installation:	<input type="checkbox"/> User <input checked="" type="checkbox"/> Professional <input type="checkbox"/> Factory
Transmitter power configuration:	<input type="checkbox"/> Internal battery <input checked="" type="checkbox"/> External power source
Special Test Arrangement:	Mounted on 80cm high plastic table: Yagi
Test Facility Accreditation:	A2LA (Certificate No. 2506.02)
Test Methodology:	Measurements performed according to the procedures in ANSI C63.10-2013 and FCC Guidance Publication 558074

3.1 Channel Configurations

CHANNELS IN THE 902 - 928 MHZ BAND				
Channel Number	Frequency (MHz)	802.11b and g	SISO N _{TX} = 1	MIMO N _{TX} = 2
1	915	xt	tested	tested

Note: x = available channels xt = tested channels

3.2 Product Description - Detailed

Description of Equipment Under Test (provided by client)

The system tested is the Model: W0900-01 (900 MHz) radio module configured with:

- Model: PRO890-16 (5' Yagi antenna)

The product is a wireless router utilized in M2M industrial applications

Signal & I/O Cables: Ethernet

The product is powered from an external power source.

For the testing of this specific test report, the product supports the following data rates in the 902 – 928 MHz band:

- IEEE 802.11 b and g

In 802.11b and g mode, the nominal bandwidth is 20MHz.

The product operates in both SISO (1-transmit chain) and MIMO (2-transmit chains) modes.

Equipment Under Test Power Configuration			
Rated Voltage	Rated Current	Rated Frequency	Number of Phases
AC Adapter Input: 100-240VAC	0.9 A	50/60	1
AC Adapter Output: 12VDC	3.0 A	---	---

Descriptions of EUT Exercising

- Standby/Idle Mode
- Continuous transmission, un-modulated carrier (CW)
- Continuous transmission, modulated carrier (CW) utilizing worst-case data rate
- Continuous Receive Mode

Note: The chosen mode of operation described above is dependent upon the specific test to be performed.

4 System setup including cable interconnection details, support equipment and simplified block diagram

4.1 Method:

Record the details of EUT cabling, document the support equipment, and show the interconnections in a block diagram.

4.2 EUT Block Diagram:)

Model: PRO890-16 (5' Yagi antenna)

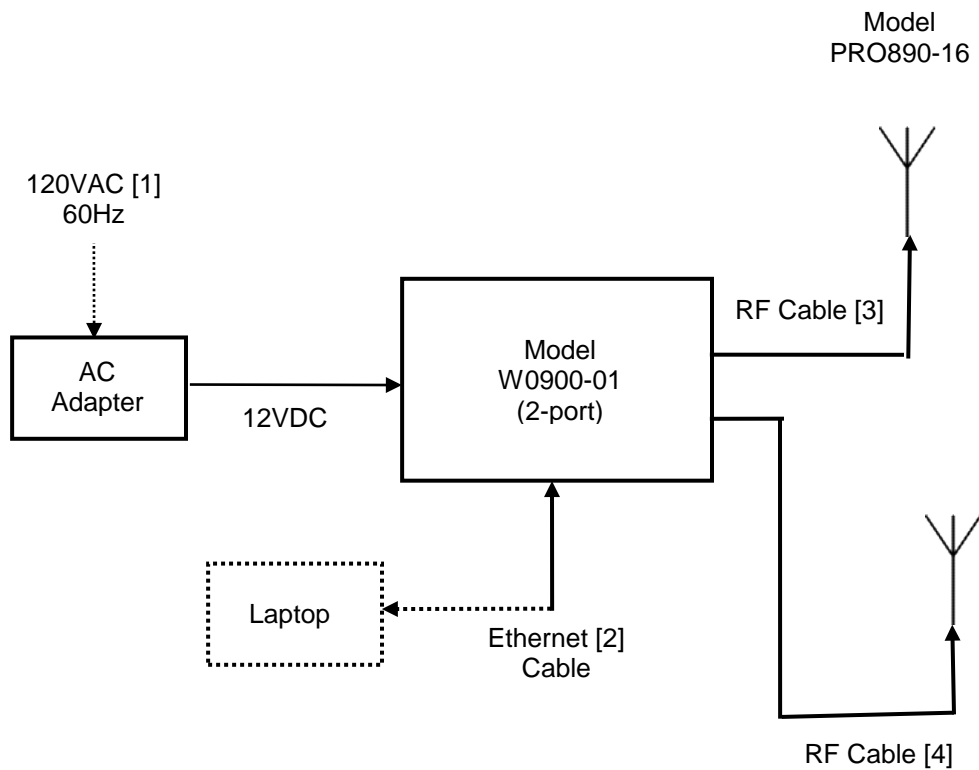

Note: Dashed lines indicate auxiliary/support equipment outside the test area. Ethernet cable was routed partially outside the test chamber with ~ 1-meter inside the test chamber – connected to the Model W0900-01 Ethernet port.

4.3 Antenna Specifications:

900MHz GHz						
			Beamwidth (degrees)			
Model	Type	Gain (dBi)	Horizontal	Vertical	Polarization	Datasheet
PRO890-16	5' Yagi antenna	16	32	26	Dual	Appendix A of this report

4.4 Determination of RF Power supplied to antenna input for testing

Per FCC 15.247(b)(4): The conducted output power limit specified in paragraph (b) of this section is based on the use of antennas with directional gains that do not exceed 6 dBi. Except as shown in paragraph (c) of this section, if transmitting antennas of directional gain greater than 6 dBi are used, the conducted output power from the intentional radiator shall be reduced below the stated values in paragraphs (b)(1), (b) (2), and (b)(3) of this section, as appropriate, by the amount in dB that the directional gain of the antenna exceeds 6 dBi.

Antenna tested:

- Model: PRO890-16 (5' Yagi antenna) Gain: 16dBi

Maximum Peak Conducted Output Power: If $G_{Tx} > 6\text{dBi}$, then $P_{Out} = 30 - ((G_{Tx} - 6)) \text{ dBm}$

Where:

P_{Out} = maximum peak conducted output power (dBm)

G_{Tx} = maximum transmitting antenna directional gain (dBi)

$P_{Out} = 30 - (G_{Tx} - 6) \text{ dBm} = 30 - (16-6) \text{ dBm} = 20 \text{ dBm}$

All Radiated measurements taken with the Model: W0900-01 transmitting at 20dBm. The actual rated maximum output power is less than the allowed 30dBm.

- Actual Rated Output Power: 27.86dBm (610.94 mW)

4.5 Support Data:

ID	Description/ Function	Shield Type	Length	Connector	Connection	Ferrites
1	DC Cable (ac adapter)	none	0.5 meter	DC	VDC – Model W2400-01	none
2	Ethernet Cable	none	4-meter	RJ45	RJ-45 – Model W0900-01	none
3-4	RF Cable(s)	Braid	3-meter	SMA-to-N	Model W0900-01 to Antenna	none

Support Equipment			
Description	Manufacturer	Model Number	Serial Number
Laptop	HP	---	---
Switching Power Supply	Sceptre Power	S036CQ1200300	---

Notes:

- 1) The laptop was utilized only to configure the product during testing (i.e. set channel, modulation, data rates, etc.).
- 2) The product has RF ports and Ethernet Cable ports.

4.6 Photograph: Product Tested - Model W0900-01 with PRO890-16 (5' Yagi antenna)

Model W0900-01 Radio Module (2-port maximum)

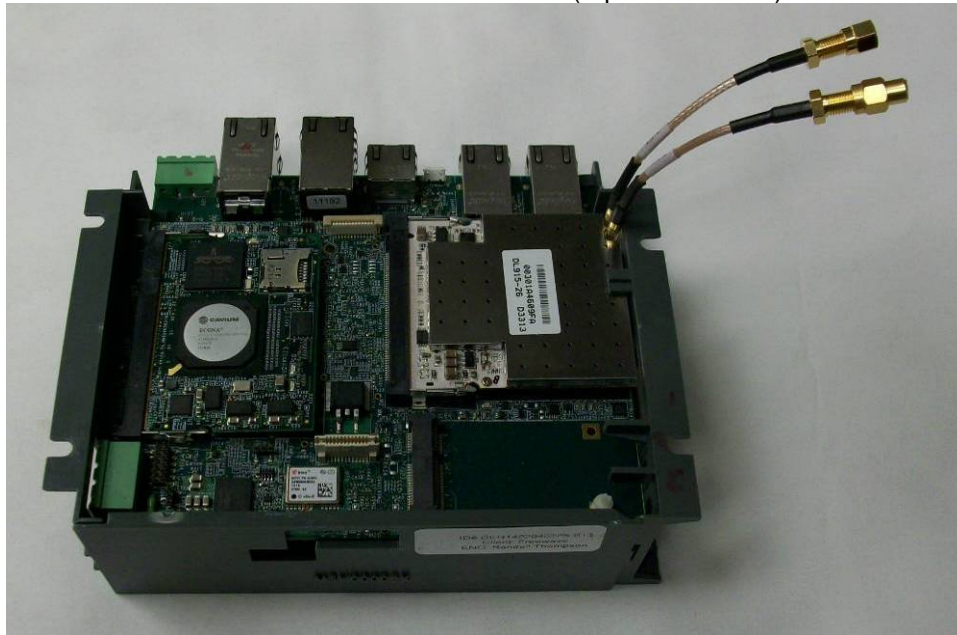

PRO890-16 (5' Yagi antenna, two Antennae shown – 1-port per antenna)



5 AC Voltage Variation/ Battery Requirement**5.1 Results:**

Test not required for Class II Permissive Change.

6 Antenna Requirement**6.1 Results:**

Test not required for Class II Permissive Change.

7 DTS Requirement**7.1 Results:**

Test not required for Class II Permissive Change.

8 DTS Bandwidth (6dB Bandwidth)**8.1 Test Results:**

Test not required for Class II Permissive Change.

9 RF Conducted Output Power**9.1 Results:**

Not required for Class II permissive change. However, the software utility utilized to configure the radio output power supplied to the antenna(s) during testing was verified to provide at least the minimum output power selected for testing.

10 RF Conducted Spurious Emissions (-20dBc) – Including Band Edge**10.1 Test Results:**

Test not required for Class II Permissive Change.

11 Transmitter Radiated Spurious Emissions – Restricted Band/ Band Edge

11.1 Method

Unless otherwise stated no deviations were made from FCC Part 15.209/205.

This testing was performed at Intertek Denver, located at 1795 Dogwood St. Suite 200, Louisville, CO 80027.

11.2 Test Requirement/ Specification:

Radiated emissions which fall in the restricted bands, as defined in FCC Part 15.205(a), must also comply with the radiated emission limits specified in Part 15.209(a) and Part 15.205(c). Measurements in the restricted bands include both peak detector and average detector measurements. Measurements in non-restricted bands include peak detector measurements.

Unwanted emissions below 1GHz must comply with the general field strength limits defined in FCC Part 15.209, when measured with a quasi-peak detector.

11.3 Test Equipment Used:

Asset ID	Description	Manufacturer	Model	Serial	Cal Date	Cal Due
DEN-073	EMI Receiver (10Hz – 26.5GHz)	RHODE & SCHWARZ	ESU 26	100265	01/29/2014	01/29/2015
18913	Spectrum Analyzer	Hewlett-Packard	E7405A	My44211889	07/26/2013	07/26/2014
18912	9 kHz- 1.3GHz Pre Amp	Hewlett-Packard	8447F	3113A05545	06/07/2013	06/07/2014
18906	RF Pre-Amp (1-4GHz)	Mini-Circuits Lab	ZHL-42	N052792-2	06/10/2013	06/10/2014
DEN-032	4-18GHz Preamp (LNA)	Narda	DBL- 0618N615	031	03/07/2013	03/07/2014
DEN-155	900MHz Notch Filter	Micro-Tronics	BRC50722	004	09/24/2013	09/24/2014
DEN-153	High Pass Filter	Mini-Circuits	VHF-3100+	3 1222	09/24/2013	09/24/2014
19937	Bilog Antenna 30MHz – 6GHz	Sunol Sciences	JB6	A050707-2	03/20/2013	03/20/2014
18887	Horn Antenna 1-18GHz	EMCO	3115	9205-3886	03/19/2013	03/19/2014
SW-6	Software for Radiated and Conducted emissions.	Intertek	OATS vba	V. 3.0	VBU	VBU

11.4 Test Procedure:

The Resolution Bandwidth is 120 kHz or greater for frequencies 30 MHz -1000 MHz and 1 MHz for frequencies above 1000 MHz. The Video Bandwidth was at least 3x the RBW.

The EUT is placed on a plastic turntable that is 80 cm in height. If the EUT attaches to peripherals, they are connected and operational (as typical as possible). During testing, all cables are manipulated to produce worst-case emissions. The signal is maximized by rotating the turntable through a 360° rotation. The antenna height is varied from 1-4 meters. Both vertical and horizontal antenna configurations are utilized in the testing.

Radiated emissions 30MHz to 18GHz are taken at 3-meter antenna-to-product test distance.

Radiated emissions above 18GHz are taken using a harmonic mixer antenna/pre-amp setup at 1-meter antenna-to-product test distance.

Data is included for the worst-case configuration – the configuration which resulted in the highest emission levels.

The following procedures described in FCC Publication 558074 (Guidelines for Compliance Measurements on DTS Operating Under 15.247), were used:

- 558074, Section 12.1 & 13.1
- ANSI C63.10: 2013 – General Guidance

11.5 Test Results:

The sample tested was found to Comply.

11.6 Setup Photographs: SIMO and MIMO Mode of Operation, PRO890-16 antenna

Transmitter Spurious Radiated Emissions – Test Setup (Rear View)
PRO890-16 – SISO



PRO890-16 – MIMO



Single-RF Port – PRO890 SISO

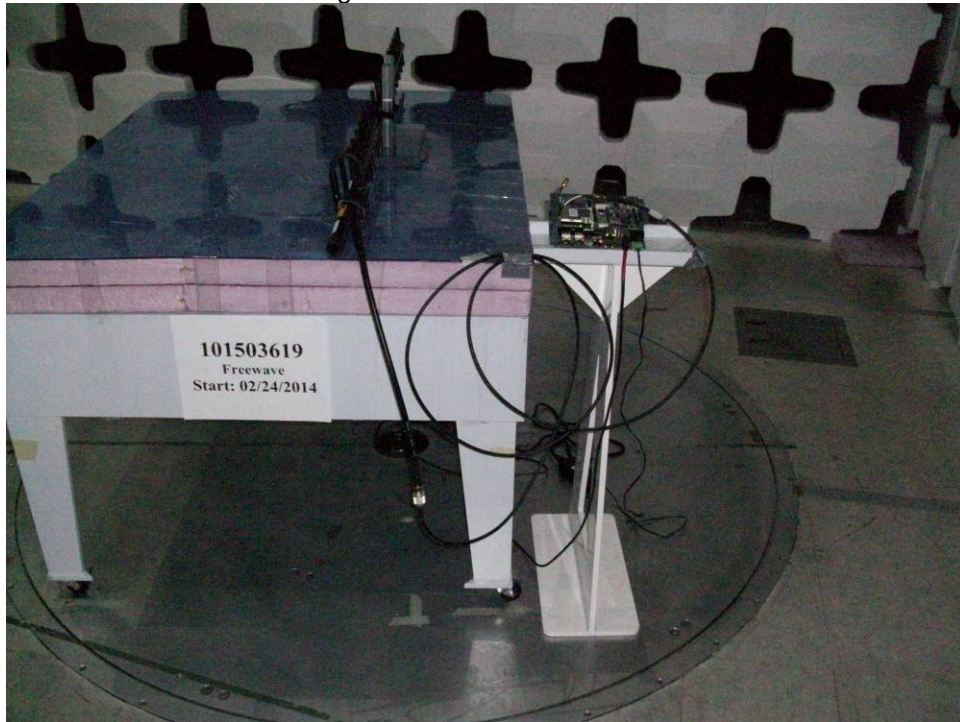

Two-RF Port – PRO890 MIMO



11.7 Antenna Setups:

Bilog Antenna (30MHz to 1GHz)



PRO890-16

Ridge-Guide Horn Antenna (1GHz to 18GHz)

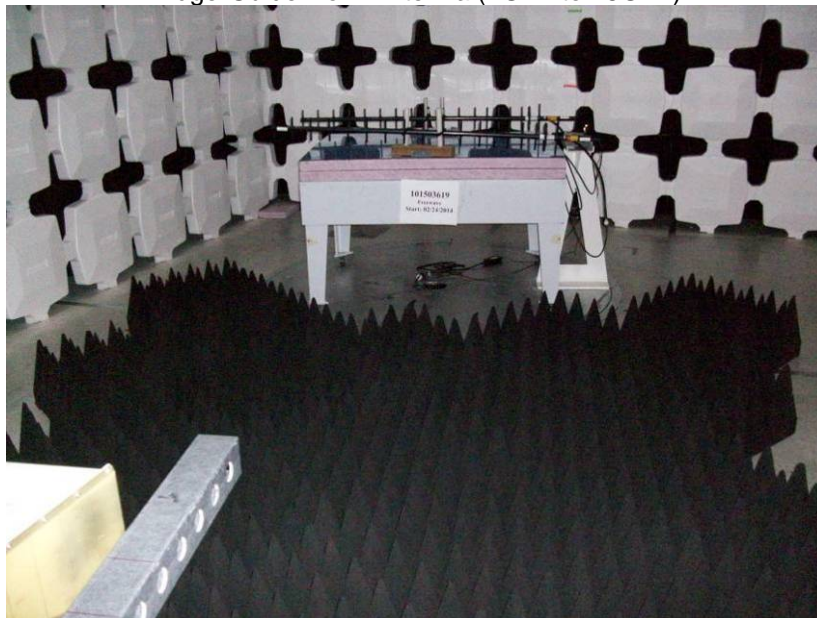

PRO890-16

11.8 Plots: SISO Mode of Operation – PRO890-16: 900 MHz

30MHz to 10GHz

Vertical Antenna

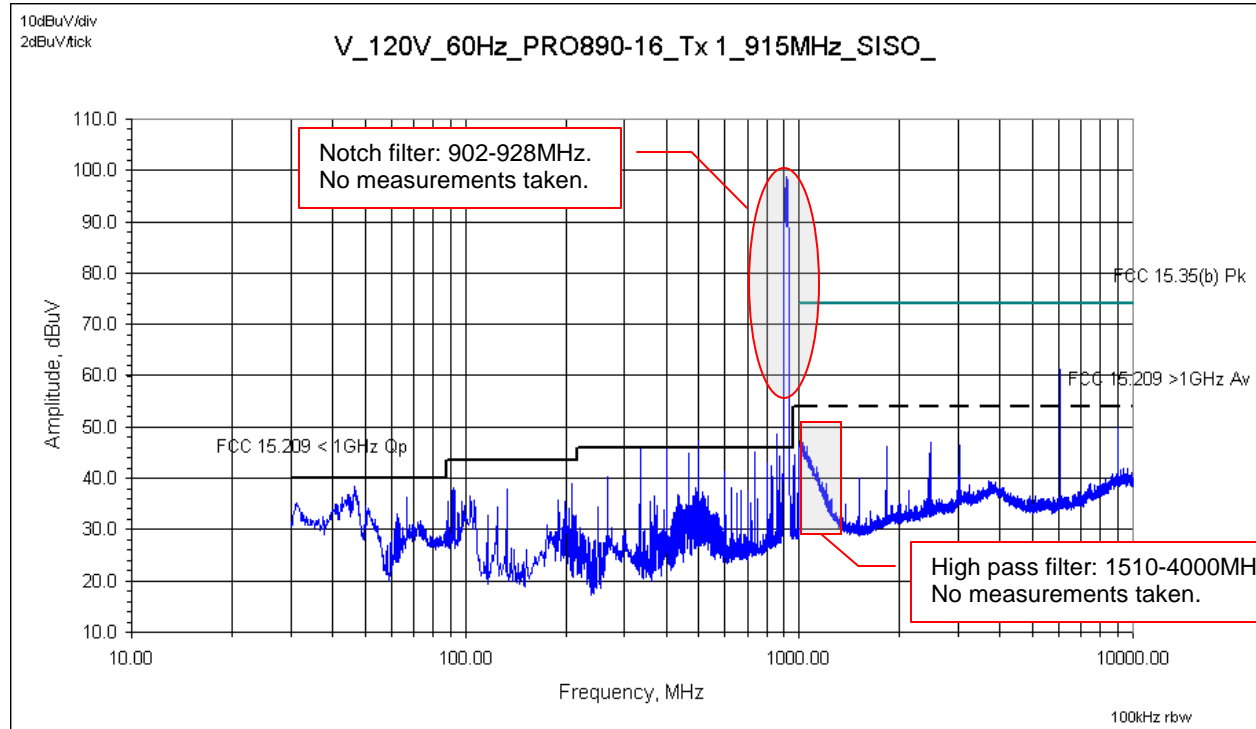

Horizontal Antenna

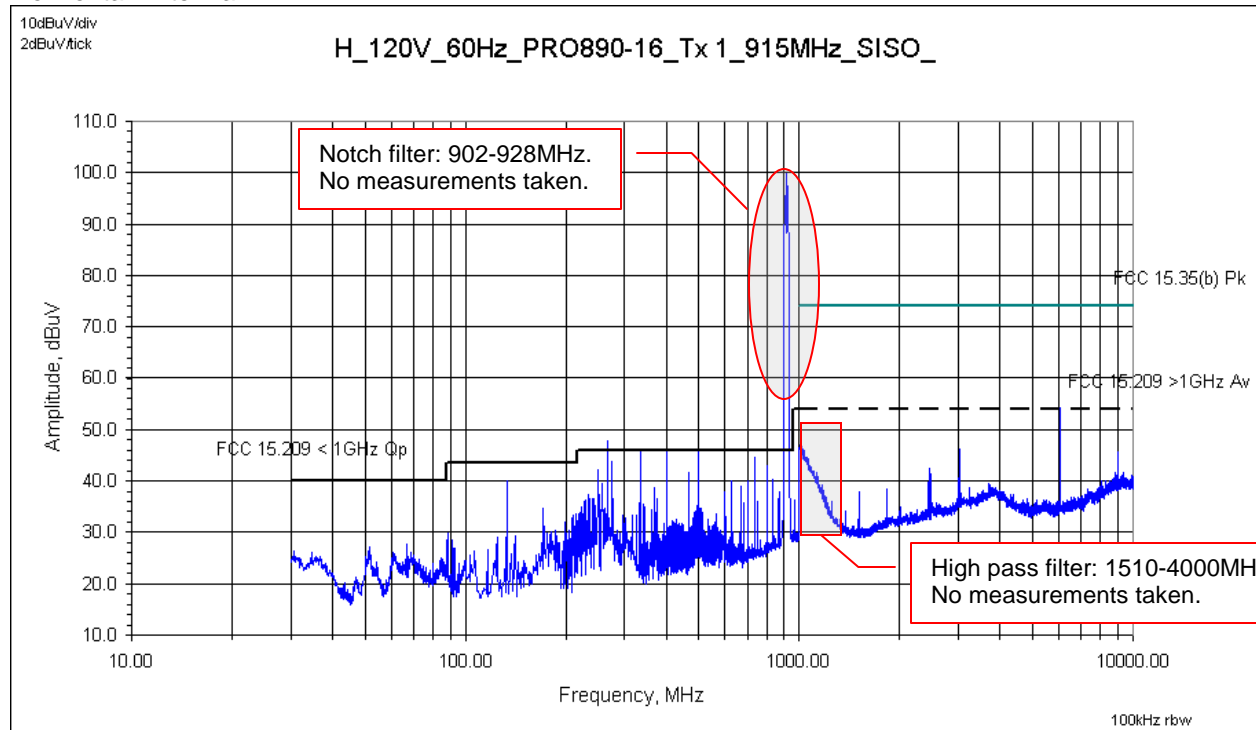

Reference only – max hold peak detector measurements referenced to quasi-peak, average & peak limits

11.9 Plots: MIMO Mode of Operation – PRO890-16: 900 MHz

30MHz to 10GHz

Vertical Antenna

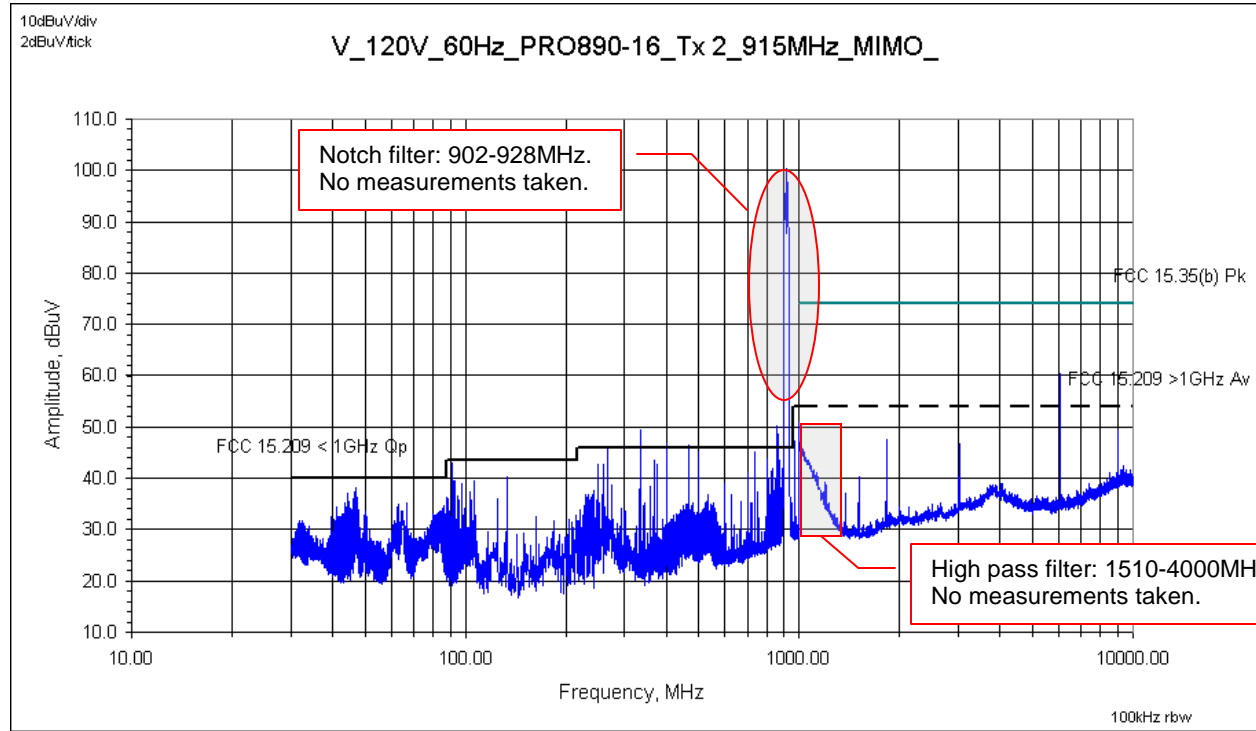

Horizontal Antenna

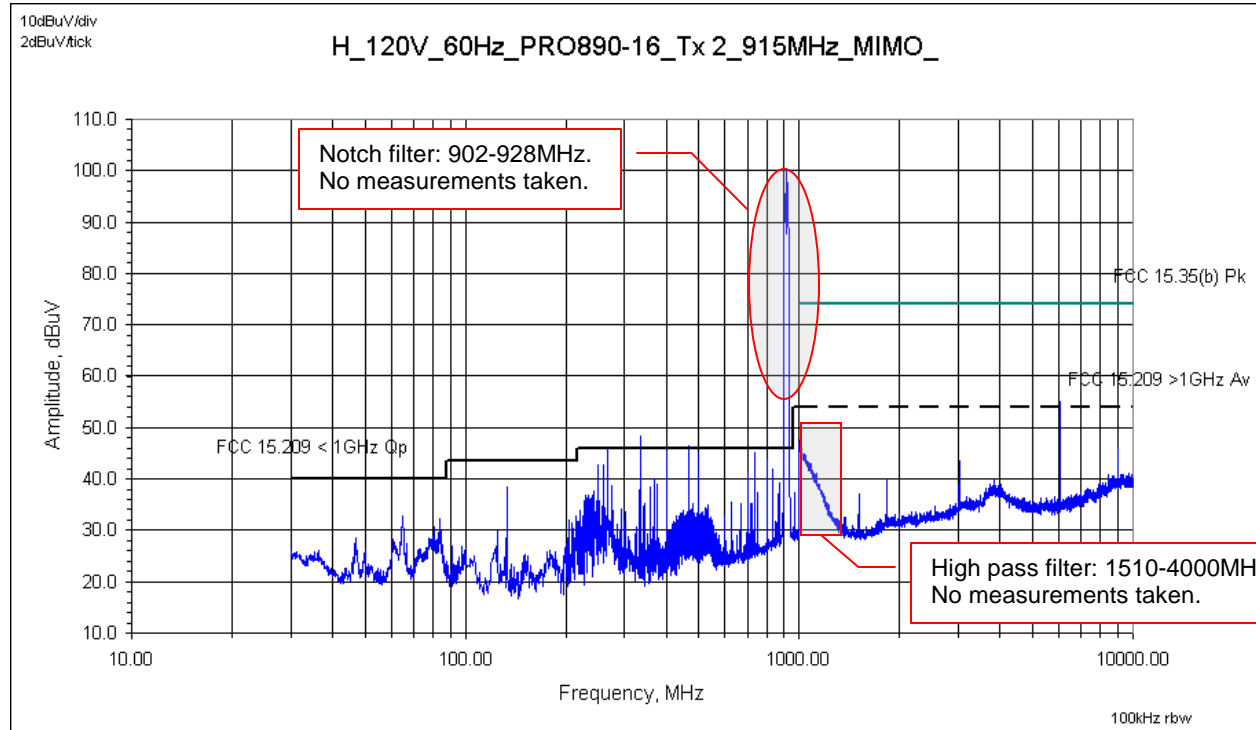

Reference only – max hold peak detector measurements referenced to quasi-peak, average & peak limits

Intertek

Report Number: 101503619DEN-001A

Issued: 03/10/2014

11.10 Test Data: SISO and MIMO Mode of Operation – PRO890-16: 900 MHz

Tx Spurious Radiated Electromagnetic Emissions

Test Report #:	101503619DEN-001A	Test Area:	CC1	Temperature:	24.1 24.0	C
Test Method:	FCC 15.209/ 15.205/ 15.35(b)	Test Date:	2/25/2014 2/26/2014	Relative Humidity:	18.2 20.9	%
EUT Model #:	Radio: W0900-01 Yagi Antenna: PRO890-16	EUT Power:	120VAC/60Hz	Air Pressure:	841.8 833.7	mBars
EUT Serial #:	Radio: DEN1402111313 Yagi Antenna(s): DEN1402040905-001 / -004			Page:	---	
Manufacturer:	FreeWave Technologies, Inc.			Level Key		
EUT Description:	Wireless router utilized in M2M industrial applications			Pk – Peak	Nb – Narrow Band	
Notes:	Product tested in SISO mode: single transmit chain/port – single antenna.			Qp – QuasiPeak	Bb – Broad Band	
	Product tested in MIMO mode: single transmit chain/port – two antennae.			Av – Average		
	Product continuously transmitting during all testing – worst-case modulation/data.					
	Conducted port power set at 20dBm.					

FREQ	LEVEL	DET	CABLE	ANT	PREAMP	ATTEN	FINAL	POL	HGT	AZ	DELTA1	DELTA2	RBW
MHz	dBuV	$\frac{Qp}{Av}{Pk}{Rms}$	+ [dB]	+ [dB/m]	- [dB]	+ [dB]	= [dBuV]	(V/H)	(m)	(DEG)	FCC 15.209 < 1GHz Qp	FCC 15.109 A < 1GHz Qp	(MHz)
Note: Unless otherwise noted, all frequencies observed, were generated from the base module.													
Frequencies that have been marked as over the FCC 15.209 limit are not in the restricted band, therefore the product under test complies with the requirements.													
SISO. One Yagi antenna.			Antenna model: PRO890-16										
			Module type: 900MHz				Center transmit frequency: single channel, 915MHz						
30-1000MHz													
V_120V_60Hz_PRO890-16_Tx1_915MHz_SISO_													
46.8442	50.03	Qp	0.77	9.56	28.25	1.11	33.22	V	1.00	88.8	- 6.78	- 16.32	0.120
333.3365	56.33	Qp	1.26	14.17	27.42	0.13	44.47	V	1.00	89.7	- 1.55	- 12.43	0.120
400.0016	55.47	Qp	1.37	15.70	27.89	0.34	44.99	V	1.00	121.1	- 1.03	- 11.91	0.120
499.9840	55.00	Qp	1.53	17.70	28.60	0.51	46.14	V	1.15	107.0	(0.12)	- 10.76	0.120
853.6058	25.98	Qp	2.04	21.40	27.95	1.12	22.59	V	1.00	263.2	- 23.43	- 34.31	0.120
860.0961	26.21	Qp	2.05	21.61	27.93	1.13	23.06	V	1.00	0.0	- 22.96	- 33.84	0.120
866.6666	40.56	Qp	2.05	21.90	27.91	1.14	37.75	V	1.30	63.4	- 8.27	- 19.15	0.120
999.9744	48.32	Qp	2.21	22.60	27.59	0.97	46.52	V	1.00	128.5	- 7.46	- 13.48	0.120
H_120V_60Hz_PRO890-16_Tx1_915MHz_SISO_													
133.3350	52.74	Qp	0.78	13.07	27.91	- 0.38	38.30	H	2.86	323.7	- 5.22	- 15.68	0.120
266.6682	59.94	Qp	1.11	12.97	27.31	0.12	46.82	H	1.76	305.3	(0.80)	- 10.08	0.120
333.3349	57.03	Qp	1.26	14.17	27.42	0.13	45.17	H	1.00	119.1	- 0.85	- 11.73	0.120
400.0032	61.85	Qp	1.37	15.70	27.89	0.34	51.37	H	1.08	97.7	(5.35)	- 5.53	0.120
499.9856	54.32	Qp	1.53	17.70	28.60	0.51	45.46	H	1.50	103.6	- 0.56	- 11.44	0.120
733.3398	49.66	Qp	1.89	20.47	28.34	0.91	44.59	H	1.38	154.7	- 1.43	- 12.31	0.120
800.0032	46.23	Qp	1.97	21.30	28.12	1.03	42.41	H	1.36	72.3	- 3.61	- 14.49	0.120

Intertek

Report Number: 101503619DEN-001A

Issued: 03/10/2014

FREQ	LEVEL	DET	CABLE	ANT	PREAMP	ATTEN	FINAL	POL	HGT	AZ	DELTA1	DELTA2	RBW
MHz	dBuV	Qp Av Pk Rms	+ [dB]	+ [dB/m]	- [dB]	+ [dB]	= [dBuV]	(V/H)	(m)	(DEG)	FCC 15.209 < 1GHz Qp	FCC 15.109 A < 1GHz Qp	(MHz)
999.9696	44.78	Qp	2.21	22.60	27.59	0.97	42.98	H	1.00	163.1	- 11.00	- 17.02	0.120

FREQ	LEVEL	DET	CABLE	ANT	PREAMP	ATTEN	FINAL	POL	HGT	AZ	DELTA1	DELTA2	RBW
MHz	dBuV	Qp Av Pk Rms	+ [dB]	+ [dB/m]	- [dB]	+ [dB]	= [dBuV]	(V/H)	(m)	(DEG)	FCC 15.209 >1GHz Av	FCC 15.36(b) >1GHz Pk	(MHz)

SISO. One Yagi antenna.

1-4GHz

V_120V_60Hz_PRO890-16_Tx 1_915MHz_SISO_

1506.9176	53.03	Pk	2.73	25.37	36.62	0.92	45.43	V	1.00	90.7	---	- 28.55	1.000
1829.8996	58.72	Pk	3.04	26.95	37.08	0.69	52.33	V	1.00	110.2	---	- 21.65	1.000
2467.9490	48.47	Pk	3.57	28.67	37.66	0.53	43.57	V	1.00	359.9	---	- 30.41	1.000
3013.8338	54.62	Pk	4.00	30.46	37.56	0.46	51.98	V	1.00	42.0	---	- 22.00	1.000
1506.9176	46.57	Av	2.73	25.37	36.62	0.92	38.97	V	1.00	90.7	- 15.01	- 35.01	1.000
1829.8996	36.13	Av	3.04	26.95	37.08	0.69	29.74	V	1.00	110.2	- 24.24	- 44.24	1.000
2467.9490	34.90	Av	3.57	28.67	37.66	0.53	30.00	V	1.00	359.9	- 23.98	- 43.98	1.000
3013.8338	49.39	Av	4.00	30.46	37.56	0.46	46.75	V	1.00	42.0	- 7.23	- 27.23	1.000

H_120V_60Hz_PRO890-16_Tx 1_915MHz_SISO_

1506.9201	51.62	Pk	2.73	25.37	36.62	0.92	44.02	H	1.00	95.4	---	- 29.96	1.000
1829.8876	54.16	Pk	3.04	26.95	37.08	0.69	47.77	H	1.00	43.7	---	- 26.21	1.000
2451.0000	48.51	Pk	3.55	28.64	37.66	0.53	43.58	H	1.00	359.9	---	- 30.40	1.000
3013.8386	53.64	Pk	4.00	30.46	37.56	0.46	51.00	H	1.00	338.1	---	- 22.98	1.000
1506.9201	44.27	Av	2.73	25.37	36.62	0.92	36.67	H	1.00	95.4	- 17.31	- 37.31	1.000
1829.8876	35.40	Av	3.04	26.95	37.08	0.69	29.01	H	1.00	43.7	- 24.97	- 44.97	1.000
2451.0000	34.90	Av	3.55	28.64	37.66	0.53	29.97	H	1.00	359.9	- 24.01	- 44.01	1.000
3013.8386	47.90	Av	4.00	30.46	37.56	0.46	45.26	H	1.00	338.1	- 8.72	- 28.72	1.000

4-10GHz

SISO. One Yagi antenna.

V_120V_60Hz_PRO890-16_Tx 1_915MHz_SISO_

6027.6703	67.83	Pk	5.80	34.65	45.04	0.00	63.24	V	1.53	142.3	---	- 10.74	1.000
9041.5051	57.36	Pk	7.35	38.37	47.39	0.00	55.69	V	1.00	50.1	---	- 18.29	1.000
6027.6703	66.83	Av	5.80	34.65	45.04	0.00	62.24	V	1.53	142.3	(8.26)	-11.74	1.000
9041.5051	51.60	Av	7.35	38.37	47.39	0.00	49.93	V	1.00	50.1	- 4.05	- 24.05	1.000

H_120V_60Hz_PRO890-16_Tx 1_915MHz_SISO_

6027.6704	61.73	Pk	5.80	34.65	45.04	0.00	57.14	H	1.00	198.2	---	- 16.84	1.000
9041.5057	55.47	Pk	7.35	38.37	47.39	0.00	53.80	H	1.76	169.9	- 0.18	- 20.18	1.000
6027.6704	59.38	Av	5.80	34.65	45.04	0.00	54.79	H	1.00	198.2	(0.81)	- 19.19	1.000
9041.5057	48.05	Av	7.35	38.37	47.39	0.00	46.38	H	1.76	169.9	- 7.60	- 27.60	1.000

Intertek

Report Number: 101503619DEN-001A

Issued: 03/10/2014

FREQ	LEVEL	DET	CABLE	ANT	PREAMP	ATTEN	FINAL	POL	HGT	AZ	DELTA1	DELTA2	RBW
MHz	dBuV	Qp Av Pk Rms	+ [dB]	+ [dB/m]	- [dB]	+ [dB]	= [dBuV]	(V/H)	(m)	(DEG)	FCC 15.209 < 1GHz Qp	FCC 15.109 A < 1GHz Qp	(MHz)
Note: Unless otherwise noted, all frequencies observed, were generated from the base module.													
Frequencies that have been marked as over the FCC 15.209 limit are not in the restricted band, therefore the product under test complies with the requirements.													
Antenna model: PRO890-16													
MIMO. Two Yagi antennas. 80cm apart.				Module type: 900MHz				Center transmit frequency: single channel, 915MHz					
30-1000MHz													
V_120V_60Hz_PRO890-16_Tx 2_915MHz_MIMO_													
133.3334	53.87	Qp	0.78	13.07	27.91	- 0.38	39.43	V	1.00	86.2	- 4.09	- 14.55	0.120
366.6698	50.84	Qp	1.31	15.17	27.65	0.24	39.91	V	1.00	288.2	- 6.11	- 16.99	0.120
499.9856	51.25	Qp	1.53	17.70	28.60	0.51	42.39	V	1.00	359.9	- 3.63	- 14.51	0.120
833.3381	42.84	Qp	2.01	21.63	28.02	1.09	39.56	V	1.00	359.9	- 6.46	- 17.34	0.120
858.3381	29.29	Qp	2.04	21.53	27.93	1.13	26.06	V	1.00	0.0	- 19.96	- 30.84	0.120
866.6827	40.64	Qp	2.05	21.90	27.91	1.14	37.83	V	1.00	359.9	- 8.19	- 19.07	0.120
966.6715	38.26	Qp	2.17	22.47	27.66	1.14	36.38	V	1.00	294.3	- 17.60	- 23.62	0.120
999.9744	50.66	Qp	2.21	22.60	27.59	0.97	48.86	V	1.09	115.5	- 5.12	- 11.14	0.120
H_120V_60Hz_PRO890-16_Tx 2_915MHz_MIMO_													
266.6682	58.33	Qp	1.11	12.97	27.31	0.12	45.21	H	1.32	81.2	- 0.81	- 11.69	0.120
733.3398	50.09	Qp	1.89	20.47	28.34	0.91	45.02	H	1.50	86.2	- 1.00	- 11.88	0.120
800.0048	47.93	Qp	1.97	21.30	28.12	1.03	44.11	H	1.00	106.0	- 1.91	- 12.79	0.120

FREQ	LEVEL	DET	CABLE	ANT	PREAMP	ATTEN	FINAL	POL	HGT	AZ	DELTA1	DELTA2	RBW
MHz	dBuV	Qp Av Pk Rms	+ [dB]	+ [dB/m]	- [dB]	+ [dB]	= [dBuV]	(V/H)	(m)	(DEG)	FCC 15.209 >1GHz Av	FCC 15.36(b) >1GHz Pk	(MHz)
1-4GHz													
MIMO. Two Yagi antennas. 80cm apart.													
V_120V_60Hz_PRO890-16_Tx 2_915MHz_MIMO_													
1506.9184	52.63	Pk	2.73	25.37	36.62	0.92	45.03	V	1.00	64.0	---	- 28.95	1.000
1829.9036	59.19	Pk	3.04	26.95	37.08	0.69	52.80	V	1.00	125.0	---	- 21.18	1.000
3013.8354	55.67	Pk	4.00	30.46	37.56	0.46	53.03	V	1.00	268.0	---	- 20.95	1.000
1506.9184	48.38	Av	2.73	25.37	36.62	0.92	40.78	V	1.00	64.0	- 13.20	- 33.20	1.000
1829.9036	36.23	Av	3.04	26.95	37.08	0.69	29.84	V	1.00	125.0	- 24.14	- 44.14	1.000
3013.8354	51.73	Av	4.00	30.46	37.56	0.46	49.09	V	1.00	268.0	- 4.89	- 24.89	1.000
H_120V_60Hz_PRO890-16_Tx 2_915MHz_MIMO_													
1506.9180	50.83	Pk	2.73	25.37	36.62	0.92	43.23	H	1.00	80.0	---	- 30.75	1.000
1829.9040	54.14	Pk	3.04	26.95	37.08	0.69	47.75	H	1.00	295.0	---	- 26.23	1.000
3013.8354	53.32	Pk	4.00	30.46	37.56	0.46	50.68	H	1.20	82.0	---	- 23.30	1.000
1506.9180	42.52	Av	2.73	25.37	36.62	0.92	34.92	H	1.00	80.0	- 19.06	- 39.06	1.000
1829.9040	35.43	Av	3.04	26.95	37.08	0.69	29.04	H	1.00	295.0	- 24.94	- 44.94	1.000
3013.8354	48.38	Av	4.00	30.46	37.56	0.46	45.74	H	1.20	82.0	- 8.24	- 28.24	1.000
4-10GHz													

Intertek

Report Number: 101503619DEN-001A

Issued: 03/10/2014

FREQ	LEVEL	DET	CABLE	ANT	PREAMP	ATTEN	FINAL	POL	HGT	AZ	DELTA1	DELTA2	RBW
MHz	dBuV	Qp Av Pk Rms	+ [dB]	+ [dB/m]	- [dB]	+ [dB]	= [dBuV]	(V/H)	(m)	(DEG)	FCC 15.209 >1GHz Av	FCC 15.36(b) >1GHz Pk	(MHz)
MIMO. Two Yagi antennas. 80cm apart.													
V_120V_60Hz_PRO890-16_Tx 2_915MHz_MIMO_													
6027.6711	67.74	Pk	5.80	34.65	45.04	0.00	63.15	V	2.24	138.0	---	- 10.83	1.000
9041.5075	58.56	Pk	7.35	38.37	47.39	0.00	56.89	V	1.33	60.0	---	- 17.09	1.000
6027.6711	66.70	Av	5.80	34.65	45.04	0.00	62.11	V	2.24	138.0	(8.13)	- 11.87	1.000
9041.5075	53.49	Av	7.35	38.37	47.39	0.00	51.82	V	1.33	60.0	- 2.16	- 22.16	1.000
H_120V_60Hz_PRO890-16_Tx 2_915MHz_MIMO_													
6027.6710	65.91	Pk	5.80	34.65	45.04	0.00	61.32	H	1.09	99.0	---	- 12.66	1.000
9041.5080	56.29	Pk	7.35	38.37	47.39	0.00	54.62	H	1.00	48.0	---	- 19.36	1.000
6027.6710	64.55	Av	5.80	34.65	45.04	0.00	59.96	H	1.09	99.0	(5.98)	- 14.02	1.000
9041.5080	50.06	Av	7.35	38.37	47.39	0.00	48.39	H	1.00	48.0	- 5.59	- 25.59	1.000

Example calculation:

Measured Level	+	Cable Loss	+	Antenna Factor	-	Pre-Amp	+	Atten	=	Final Corrected Reading	Specification Limit	-	Final Corrected Reading	=	Delta Specification
(dB μ V)		(dB)		(dB)		(dB)		(dB)		(dB μ V/m)	(dB μ V/m)		(dB μ V/m)		
20.0		3.0		5.0		10.0		0.0		18.0	40.0		18.0		- 22.0

Notes:

- 1) The highest signals determined to be from the radio and not the support equipment – as determined from pre-scan plots – were fully-maximized and measured.
- 2) For the general pre-scan plots 1-4GHz, a notch filter was utilized.

Deviations, Additions, or Exclusions: None

12 Power Spectral Density – PSD**12.1 Test Results:**

Test not required for Class II Permissive Change.

13 Radiated Emissions (Digital Part of Receiver)**13.1 Test Results:**

Test not required for Class II Permissive Change.

14 AC Mains Conducted Emissions – Transmitter**14.1 Test Results:**

Test not required for Class II Permissive Change.

15 RF Exposure Requirement**15.1 Test Results:**

Test not required for Class II Permissive Change.

16 Duty Cycle/ Duty Cycle Correction Factor**16.1 Results:**

Test not required for Class II Permissive Change.

17 Appendix A: Antenna Specifications



PROFESSIONAL GRADE YAGI

PRO890-16

890-960 MHz

ANTENNA SPECIFICATIONS

Operating Frequency (VSWR ≤ 1.5) MHz	890-960
Nominal Gain (dBi)	16
Horizontal Beamwidth (Deg-3dB)	32
Vertical Beamwidth (Deg-3dB)	26
Front To Back Ratio (dB)	25
Power Rating (W)	200
Length (inches)	63
Width (inches)	6.6
Antenna Weight (lbs.)	3.5
Cross Sectional Area (Max. Ft ²)	0.67
Lateral Thrust at 100mph (lbs.)	16.75
Rated Wind Velocity (mph)	125
Rated Wind Velocity with 1/2" radial ice (mph)	80



PRO890-16 is equipped with a standard feed line length of 2' LMR400 UltraFlex® cable and N-Female connector. Please contact our sales staff for alternate connector requirements.

Extended feed line available in 5' increments up to a maximum of 50'. All extended feed line antennas equipped with LMR400 cable and N-Male connector.

The **PRO890-16** is engineered to meet or exceed the requirements of a broadband, high gain, *Professional Grade 900 MHz Yagi antenna*.

The **PRO890-16** provides **16 dBi** gain and operates effectively across the frequency band of **890-960 MHz** with a VSWR of 1.5:1 or less.

All *WaveLink Professional Grade* antennas are manufactured using high strength 6061-T6 aluminum. The dipole and directive elements are fully welded to the boom completely eliminating misalignment problems. The antenna is also electrically **one piece**, effectively eliminating intermod issues and future performance degradation.

The dipole design incorporates an integral feed cable available in lengths up to 50 feet.

The extended feed line option offers many benefits:

1. Dramatically reduces install time, by up to 2 hours per site
2. Completely eliminates the connector at the antenna
3. Improves signal strength ½ to ¾ of a dB
4. Eliminates connector weatherproofing concerns
5. Significantly reduces long term cost of ownership

The **PRO890-16** is anodized to protect against environmental degradation even in the most severe environments.

To view polar plots for this antenna please visit www.wavelinkantenna.com/plots



**Includes mounting bracket
C1001A**

Easily permits vertical or horizontal polarization.
Mounts on 1"-2½" OD pipe.



Phone: 1 800.805.6922 (Toll Free USA & Canada)
Visit us online at WavelinkAntenna.com

18 Measurement Uncertainty



The measured value related to the corresponding limit will be used to decide whether the equipment meets the requirements.

The measurement uncertainty figures were calculated and correspond to a coverage factor of $k = 2$, providing a confidence level of respectively 95.45 % in the case where the distributions characterizing the actual measurement uncertainties are normal (Gaussian).

Measurement uncertainty Table

Parameter	Uncertainty \pm	Notes
Radiated emissions, 10kHz to 30 MHz	3.4 dB	
Radiated emissions, 30 to 200 MHz HP	2.2 dB	
Radiated emissions, 30 to 200 MHz VP	3.8 dB	
Radiated emissions, 200 to 1000 MHz HP	2.8 dB	
Radiated emissions, 200 to 1000 MHz VP	2.7 dB	
Radiated emissions, 1 to 18 GHz	5.2 dB	
Conducted port emissions 10kHz to 1000 MHz	1.0 dB	
Conducted port emissions 1 – 26.5 GHz	1.6 dB	
AC mains Conducted emissions, 9kHz to 30 MHz	3.14 dB	

19 Revision History

Revision Level	Date	Report Number	Notes
0	03/10/2014	101503619DEN-001A	Original Issue
1	05/28/2014	101503619DEN-001A	<p>Administrative change</p> <p>Page: 3 Change: This radio operates in the following 802.11 b/g/n Tx Band: 902 – 928MHz To: This radio operates in the following 802.11 b/g Tx Band: 902 – 928MHz</p> <p>Page 6: Change: 802.11 b/g/n PCIe Radio Module To: 802.11 b/g PCIe Radio Module</p> <p>Change: KNYASM1101CR To: KNYPRW1001ER</p> <p>Page 7: Change: 802.11a and g To: 802.11b and g</p> <p>Change: 802.11 g/n: To: 802.11 g</p> <p>Change: A2LA (Certificate No. 2506.01) To: A2LA (Certificate No. 2506.02)</p> <p>Page 8: Change: 902 – 902 MHz band: ▪ IEEE 802.11 a and g To: 902 – 928 MHz band: ▪ IEEE 802.11 b and g</p> <p>Change: In 802.11a and g mode, the nominal bandwidth is 20MHz. To: In 802.11b and g mode, the nominal bandwidth is 20MHz.</p> <p>Responsible engineer: Richard Georgerian </p> <p>Reviewer: Michael Spataro </p>