

The University of Michigan
Radiation Laboratory
3228 EECS Building
Ann Arbor, MI 48109-2122
Tel: (313) 747-1792

Measured Radio Frequency Emissions
From

Ford
Passive Antitheft System
(PATS CXVR)

Report No. 415031-956
August 5, 1998

For:
Ford Electronics Division
16800 Executive Plaza Drive
Dearborn, Michigan 48126

Contact:
Frank Thompson
Tel: (313) 390-8951
Fax: (313) 323-8438
PO: EIY0137513 (Germany)

EXHIBIT E
Page 1-10 of 10
U of Mich file 415031- 986

Measurements made by:

Glen Thibodeau

Tests supervised by:
Report approved by:

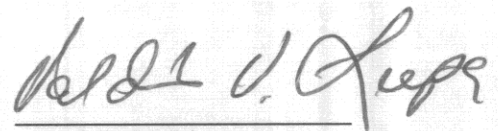

Valdis V. Liepa
Research Scientist

Summary

Tests for compliance with FCC Regulations subject to Part 15, Subpart C, were performed on Ford PATS Immobilizer Module. This device is subject to Rules and Regulations as a transmitter. As a digital device it is exempt, but we made such measurements to assess the device's overall emissions.

In testing performed on June 11, 12, and 16, 1998, the device tested in the worst case met the allowed specifications for transmitter radiated emissions by 46.7 dB (see p. 6). The digital emissions exceeded Class B limit by 1.7 dB at 64.4 MHz (see p. 6).

The conductive emission tests do not apply, since the device is powered from an automobile 12V system.

1. Introduction

Ford Passive Anti-Theft System (PATS) was tested for compliance with FCC Regulations, Part 15, adopted under Docket 87-389, April 18, 1989. The tests were performed at the University of Michigan Radiation Laboratory Willow Run Test Range following the procedures described in ANSI C63.4-1992 "Methods of Measurement of Radio-Noise Emissions from Low-Voltage Electrical and Electronic Equipment in the Range of 9 kHz to 40 GHz". The attenuation characteristics of the Open Site facility are on file with FCC Laboratory, Columbia, Maryland. (FCC file 31040/SIT)

2. Test Procedure and Equipment Used

The test equipment commonly used in our facility is listed in Table 2.1 below. The second column identifies the specific equipment used in these tests. The HP 8593E spectrum analyzer is used for primary amplitude and frequency reference.

Table 2.1. Test Equipment.

Test Instrument	Equipment Used	Manufacturer/Model	Cal. Date/By
Spectrum Analyzer (9kHz-22GHz)		Hewlett-Packard 8593A SN: 3107A01358	July 1997/HP
Spectrum Analyzer (9kHz-26GHz)	X	Hewlett-Packard 8593E SN: 3107A01131	June 1997/HP
Spectrum Analyzer (0.1-1500 MHz)		Hewlett-Packard 182T/8558B SN: 1529A01114/543592	August 1996/U of M Rad Lab
Preamplifier (5-1000MHz)	X	Watkins-Johnson A11 -1 plus A25-1S	May 1996/U of M Rad Lab
Preamplifier (5-4000 MHz)		Avantek	Nov. 1992/ U of M Rad Lab
Power Meter w/ Thermistor		Hewlett-Packard 432A Hewlett-Packard 478A	August 1989/U of M Rad Lab August 1989/U of M Rad Lab
Broadband Bicone (20-200 MHz)	X	University of Michigan	July 1988/U of M Rad Lab
Broadband Bicone (200-1000 MHz)		University of Michigan	June 1996/U of M Rad Lab
Dipole Antenna Set (25-1000 MHz)		University of Michigan	June 1996/U of M Rad Lab
Dipole Antenna Set (30-1000 MHz)		EMCO 3121C SN: 992	June 1996/U of M Rad Lab
Active Loop Antenna (0.090-30MHz)	X	EMCO 6502 SN: 2855	December 1993/ EMCO
Active Rod (30Hz-50 MHz)		EMCO 3301B SN: 3223	December 1993/EMCO
Ridge-horn Antenna (0.5-5 GHz)		University of Michigan	February 1991/U of M Rad Lab
LISN Box		University of Michigan	May 1994/U of M Rad Lab
Signal Cables	X	Assorted	January 1993/U of M Rad Lab
X-Y Plotter		Hewlett-Packard 7046A	During Use/U of M Rad Lab
Signal Generator (0.1-990 MHz)		Hewlett-Packard 8656A	January 1990/U of M Rad Lab
Printer	X	Hewlett-Packard 2225A	August 1989/HP

3. Configuration and Identification of Device Under Test

The DUT is a car security system that electronically identifies the "true" ignition key for the car. The system consists of a coupling coil (transmitter), a passive transponder in the key, and a control module. The operating frequency is 134 kHz and the frequency is crystal stabilized (16.1 MHz). The transponder is considered passive (it uses energy supplied by the transmitter coil to operate its micro that changes the resonant frequency of the transponder), and is not subject to the rules. The system tested consisted of a load box, digital control module, ignition key assembly, and the key. A test box that was provided, to select either a pulsed (normal operation) or a CW emission.

The DUT was designed and manufactured by Ford Motor Company, Dearborn, Michigan 48126. It is identified as:

Ford PATS system
Model PATS XCVR
PN: 98BP-15607-AB (TFC00060) (Full test performed)
PN: 98BP-15607-AB (TFC00080)
PN: 98VP-15607-AB (TGC00143)
PN: 98AP-15607-AB (TEC07209)
FCC ID: KMH15607-CP3PATS
CANADA: to be provided by IC

Four different assemblies (for different car lines) were provided. Electronically, they are same, but have different plastic cases and metal housings. For testing the metal housing was not used, but we did use a metal ring from one of the housings to support the coil on the lock cylinder. (We found that the metal ring does affect the resonant frequency of the coil and, hence, should be used in the tests.) One model was tested completely, and the others for the "worst case only".

3.1 EMI Relevant Modifications

None.

4. Emission Limits

4.1 Radiated Emission Limits

The DUT tested falls under the category of an Intentional Radiators and the Digital Devices, subject to Subpart C, Section 15.209; and Subpart B, Section 15.109 (transmitter generated signals excluded); and Subpart A, Section 15.33. The applicable testing frequencies with corresponding emission limits are given in Tables 4.1 and 4.2 below. As a digital device, it is exempt.

Table 4.1. Radiated Emission Limits (Ref: 15.209, 15.205) --Transmitter.

Frequency (MHz)	Fundamental and Spurious* ($\mu\text{V/m}$)
0.009-0.490	2400/F(kHz), 300m
0.490-1.705	24,000/F(kHz), 30m
0.090-0.110 0.49-0.51	Restricted Bands

* For extrapolating to other distances, see Section 6.6.

Table 4.2. Radiated Emission Limits (Ref: 15.33, 15.35, 15.109) -- Digital Class B.

Freq. (MHz)	E_{lim} (3m) μ V/m	E_{lim} dB(μ V/m)
30-88	100	40.0
88-216	150	43.5
216-960	200	46.0
960-2000	500	54.0

Note: Average readings apply above 1000 MHz (1 MHz BW)
 Quasi-Peak readings apply to 1000 MHz (120 kHz BW)

4.2 Conductive Emission Limits

The conductive emission limits and tests do not apply here, since the DUT is powered from an automobile 12V system.

5. Radiated Emission Tests and Results

5.1 Anechoic Chamber Measurements

To familiarize with the radiated emission behavior of the DUT, the DUT was first studied and measured in a shielded anechoic chamber. In the chamber there is a set-up similar to that of an outdoor 3-meter site, with a turntable, an antenna mast, and a ground plane. Instrumentation includes spectrum analyzers and other equipment as needed. In this case, the receiving antenna was an active loop, placed on a tripod, approximately 1.5 meters above the ground.

The DUT was laid on the test table as seen in Figure 5.1. Using the loop antenna we studied emissions up to 2 MHz. The resolution and video bandwidths were 300 Hz. The emissions were studied with the plane of the loop perpendicular and parallel to the direction of propagation from the DUT. Larger emissions were observed when the loop was perpendicular. In the chamber we also recorded the spectrum and modulation characteristics of the carrier. These data are presented in subsequent sections. We also note that in scanning from 0.0-2.0 MHz there were no spurious emissions observed other than harmonics. Sometimes it was difficult to separate the DUT emissions from the AM band signals.

5.2 Outdoor Measurements

After the chamber measurements, the emissions were measured on our outdoor 3-meter site. The DUT was laid on the turntable and the loop antenna was set at a 3 meter distance. Only the first (fundamental) harmonic could be seen. The resolution bandwidth used outdoors was 300 Hz.

See Section 6.6 for field extrapolation measurements from 3 m to 300 m.

5.3 Computations and Results

To convert the dBm measured on the spectrum analyzer to dB(μ V/m), we use expression

$$E_3(\text{dB}\mu\text{V/m}) = 107 + P_R + K_A - K_G + K_E$$

where P_R = power recorded on spectrum analyzer, dB, measured at 3m
 K_A = antenna factor, dB/m
 K_G = pre-amplifier gain, including cable loss, dB
 K_E = pulse operation correction factor, dB (see 6.1)

When presenting the data, at each frequency the highest measured emission under all of the possible orientations is given. Computations and results are given in Table 5.1. There we see that the DUT meets the limit by 46.7 dB.

6. Other Measurements and Computations

6.1 Correction For Pulse Operation

When the transmitter is activated to transmit, it transmits a single 134 kHz pulse 50.5 ms long. Thus, the averaging factor or pulse operation correction factor is

$$K_E = 50.5 \text{ ms} / 100 \text{ ms} = 0.505 \text{ or } -5.9 \text{ dB}$$

6.2 Emission Spectrum

Using the loop antenna, the emission spectrum was recorded and is shown in Figure 6.2.

6.3 Bandwidth of the Emission Spectrum

The measured spectrum of the signal is shown in Figure 6.3. From the plot we see that the -20 dB bandwidth is 384 Hz, and the center frequency is 134.25 kHz.

6.4 Effect of Supply Voltage Variation

The DUT has been designed to be operated from an automobile 12V system. For this test, the relative power radiated was measured at the fundamental as the voltage was varied from 5.0 to 18.0 volts. The emission variation is shown in Figure 6.4.

6.5 Input Voltage and Current

$$V = 13.8 \text{ V}$$

$$I = 75.8 \text{ mA (CW emission)}$$

6.6 Field Behavior at 134 kHz

Because at the specified 300 m measurement distance the signal is too small to measure, measurements were made at 3 m. To relate the 300 m distance to the 3 m, field attenuation experiments were performed using two loops, one transmitting, the other receiving. Even then we could only go up to 50 m before noise became a factor. Measurements were made with the loops coplanar (planes of the loops in the same plane) and with loops axial (same axis for both loops). Figures 6.5 and 6.6 show results. From these we then deduce the difference in dB between the 300 m and 3 m distances is:

$$\text{Coplanar case: } 0.0 - (-112.4) = 112.4 \text{ dB (56 dB/decade)}$$

$$\text{Axial case: } -6.0 - (-96.1) = 90.1 \text{ dB (45 dB/decade)}$$

The University of Michigan
Radiation Laboratory
3228 EECS Building
Ann Arbor, Michigan 48109-2122
(734) 647-1792

Table 5.1 Highest Emissions Measured

Radiated Emissions											Ford Immobilizer; FCC, IC
#	Freq. kHz	Ant. Used	Ant. Orien.	Pr, 3m dBm	Det. Used	Ka dB/m	Kg dB	E300* dBμV/m	E300lim dBμV/m	Pass dB	Comments
1	133.9	Loop	V	-42.7	Pk	9.9	0.0	-21.8	25.6	47.4	loop normal, PN: TFC00060
2	133.9	Loop	V	-47.7	Pk	9.9	0.0	-26.8	25.6	52.4	loop planar
3	268.2	Loop	V	-58.1	Pk	9.8	0.0	-37.3	25.6	62.9	loop normal (axis in dir. of prop.)
4	268.2	Loop	V	-62.4	Pk	9.8	0.0	-41.6	25.6	67.2	loop planar (loop in dir. of prop.)
5	402.7	Loop	V	-78.6	Pk	9.8	0.0	-57.8	25.6	83.4	loop normal
6	402.7	Loop	V	-83.0	Pk	9.8	0.0	-62.2	25.6	87.8	loop planar
7	545.2	Loop	V	-89.7	Pk	9.8	0.0	-68.9	25.6	94.5	loop normal, noise
8	545.2	Loop	V	-90.9	Pk	9.8	0.0	-70.1	25.6	95.7	loop planar, noise
9	669.0	Loop	V	-92.3	Pk	9.8	0.0	-71.5	25.6	97.1	loop normal, noise
10	669.0	Loop	V	-91.3	Pk	9.8	0.0	-70.5	25.6	96.1	loop planar, noise
All other harmonics/orientations are in the noise (Pr < -68 dBm)											
* The averaging factor is -5.9 dB; data is extrapolated to 300m distance											
300 Hz RBW used in measurements											
1	133.9	Loop	V	-42.4	Pk	9.9	0.0	-21.5	25.6	47.1	loop normal, PN: TGC00143
2	133.9	Loop	V	-47.2	Pk	9.9	0.0	-26.3	25.6	51.9	loop planar
1	133.9	Loop	V	-42.0	Pk	9.9	0.0	-21.1	25.6	46.7	loop normal, PN: TFC00080
2	133.9	Loop	V	-47.6	Pk	9.9	0.0	-26.7	25.6	52.3	loop planar
1	133.9	Loop	V	-45.0	Pk	9.9	0.0	-24.1	25.6	49.7	loop normal, PN: TEC07209
2	133.9	Loop	V	-50.4	Pk	9.9	0.0	-29.5	25.6	55.1	loop planar
DIGITAL EMISSIONS Class B Limits											
#	Freq. MHz	Ant. Used	Ant. Pol.	Pr, 3m dBm	Det. Used	Ka dB/m	Kg dB	E3 dBμV/m	E3lim dBμV/m	Pass dB	Comments
1	64.4	Dip	H	-54.5	Pk	4.5	24.8	32.2	40.0	7.8	
2	64.4	Dip	V	-45.0	Pk	4.5	24.8	41.7	40.0	- 1.7	Fail, but not subject to the rules
3	80.5	Bic	V	-70.0	Pk	11.2	24.5	23.7	40.0	16.3	
4	161.0	Bic	H	-71.0	Pk	15.1	23.3	27.8	43.5	15.7	
5	193.5	Bic	H	-73.0	Pk	15.8	22.9	26.9	43.5	16.6	

Conducted Emissions							
#	Freq. MHz	Line Side	Det. Used	Vtest dBμV	Vlim dBμV	Pass dB	Comments
							Not applicable

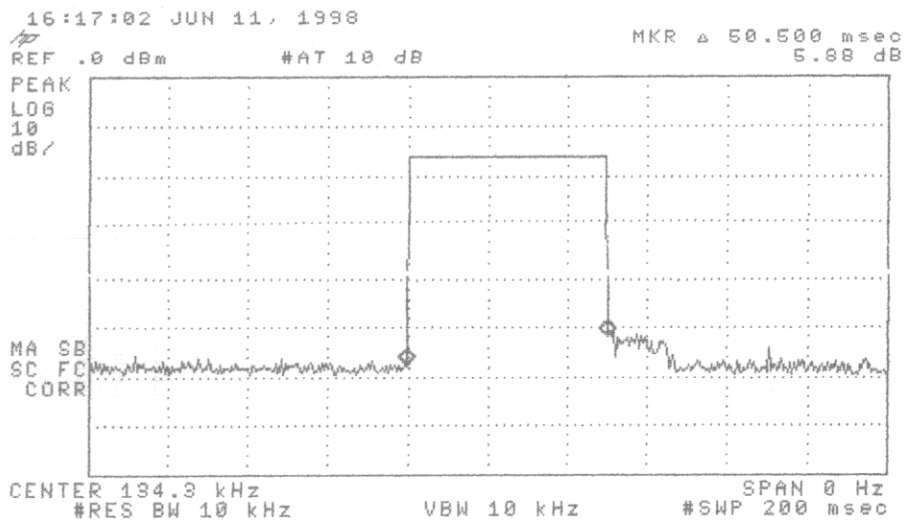

Figure 6.1. Transmissions modulation characteristics. Complete transmission is a single pulse.

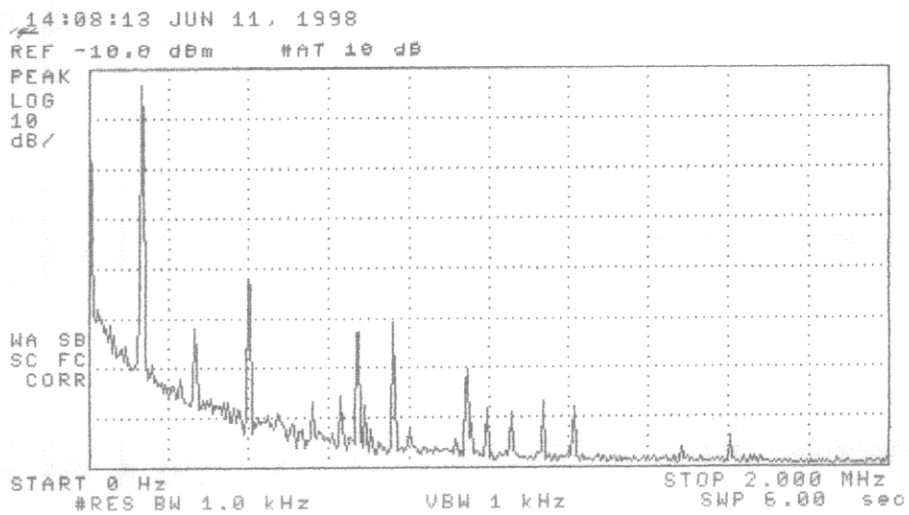

Figure 6.2. Emission spectrum of the DUT (CW emission).
The amplitudes are only indicative (not calibrated).

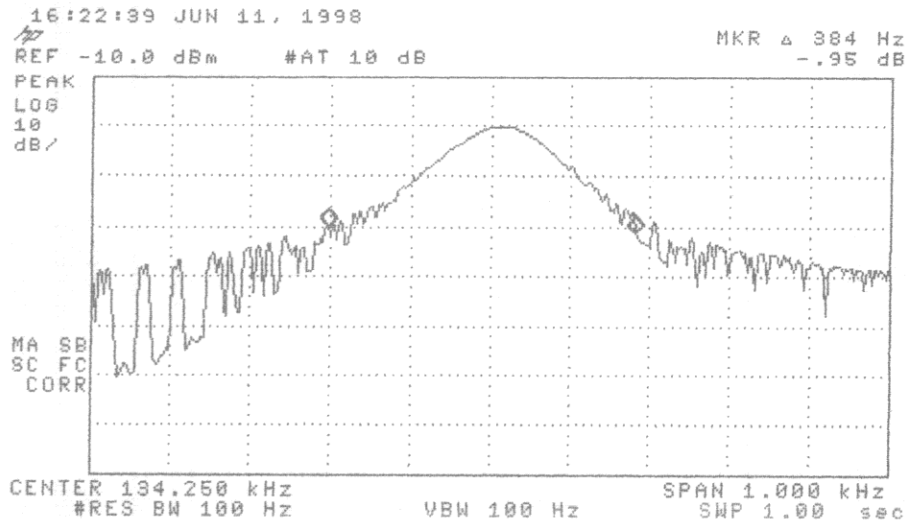

Figure 6.3. Measured bandwidth of the DUT (pulsed emission).

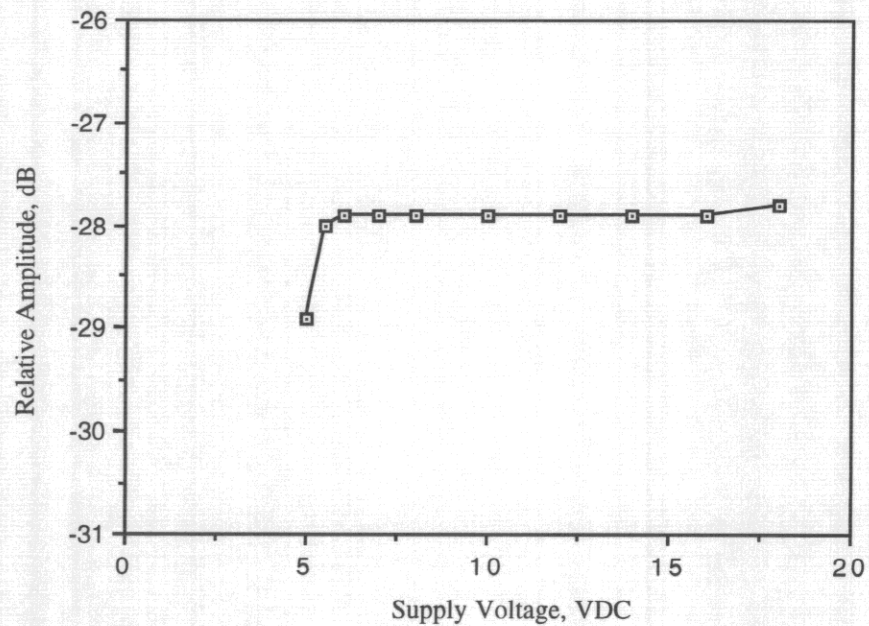

Figure 6.4. Relative emission at 133.9 MHz vs. supply voltage (CW emission).

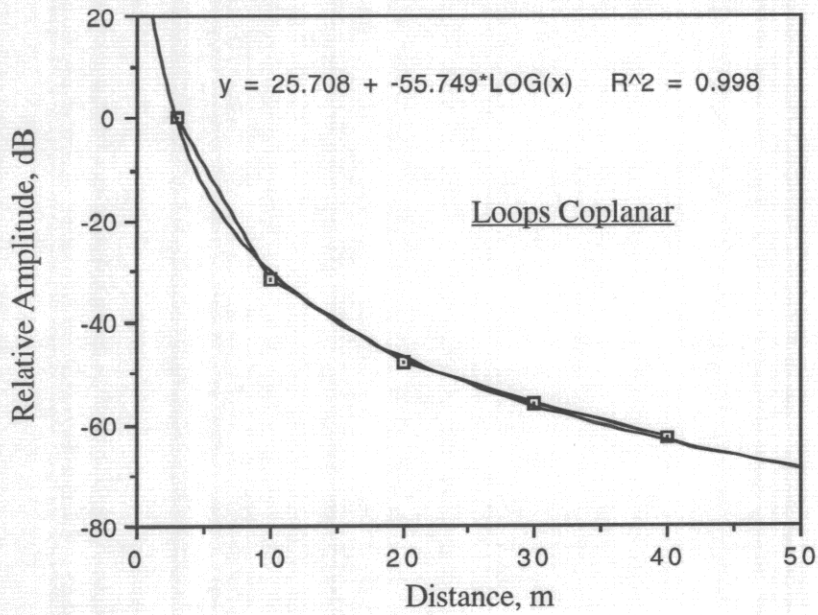

Figure 6.5. Field attenuation for case of coplanar loops.

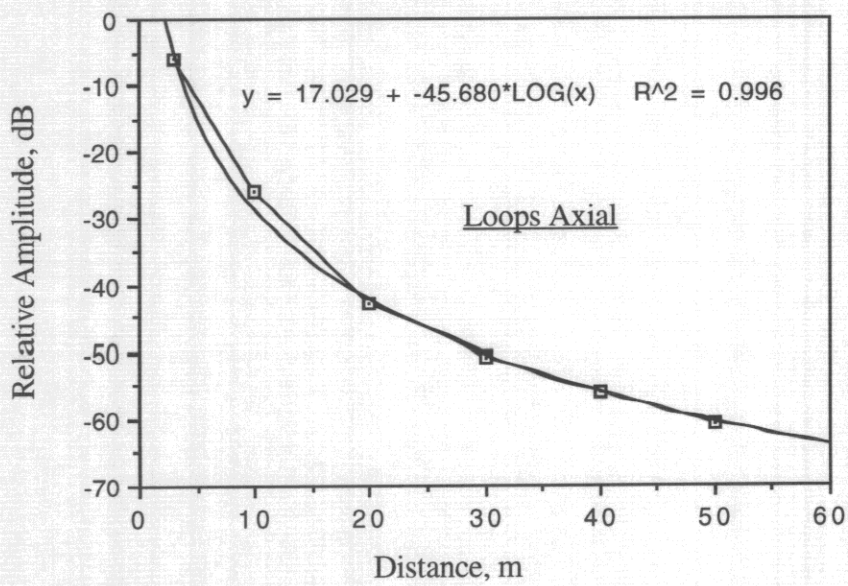

Figure 6.6. Field attenuation for case of axial loops.



Passive Anti-Theft System (PATS) Theory of Operation

Overview

The Passive Anti-Theft System (PATS) is a vehicle anti-theft system that uses Half-Duplex Radio Frequency Identification (RFID) technology to provide driveaway theft protection. During each vehicle start sequence, the electronically encoded ignition key is interrogated by the PATS. If the key's electronic ID code matches one programmed into the PATS memory, the vehicle is enabled to start. If no match is found for the key the vehicle's electronics do not allow the vehicle to start. The PATS system contains an electronically encoded ignition key, a radio frequency transmitter/receiver (transceiver) module and a control module (system controller). Each of the system components will be briefly described below:

Transponder

PATS utilizes a passive RFID half-duplex transponder. The device is packaged in a small, hermetically sealed glass capsule (23mm X 3.85mm). The transponder is imbedded in the plastic head of the ignition key. The transponder has no internal battery and thus must receive its power from the transceiver (through induction). The transponder charge-up frequency is 134.2Khz. The transponder transmits its data packet in Frequency Shift Keyed (FSK) format. The two FSK frequencies used during data transmission are 134.2Khz and 123.2Khz.

Transceiver

The PATS transceiver is used to interface the controller to the transponder. The transceiver charges-up the transponder power source upon receiving a charge-up pulse from the controller. After a 50ms charge, the transceiver receives the transponder FSK signal and amplifies it through a two-stage amplifier. The amplifier output is sent to the controller.

Controller

The PATS control module (controller) contains circuitry to interface to the vehicle electrical system, the transceiver module, the vehicle multiplex communications network and the vehicle theft indicator located in the instrument cluster. The controller uses a microprocessor to control the system functions. The microprocessor clock oscillator frequency is 16.104Mhz. The controller uses a separate microcontroller in the multiplex communications network hardware. The microcontroller clock oscillator frequency is 16.00Mhz. The amplified transponder data packet signal is demodulated by the controller using a PLL based FSK demodulator. The free-running frequency of the PLL VCO is approximately 268Khz.

System Operation

The PATS is off until the ignition key is rotated to the ignition position. At that time, ignition power is supplied to the controller. The controller then sends the 50ms charge-up pulse to the transceiver module which amplifies it to the primary coil circuit. This charge-up pulse charges-up the transponder so it can send back its identification code to the transceiver. After 50ms, the controller terminates the charge-up pulse and is ready to receive the amplified transponder data packet. When the transponder senses the end of the charge-up pulse (magnetic field collapse), it begins transmitting its data packet. The transceiver primary and secondary coils now function as the receiving coil. The transceiver receives the data packet signal and amplifies it to the controller. The controller then demodulates the data packet and compares the received ID Code with codes stored in its EEPROM memory. If a match is found, the controller sends an "okay to start" vehicle security message to the engine management system. The transponder data packet signal is approximately 15ms in duration. The total interrogation period from charge-up to vehicle enable takes approximately 90ms. After this, no further transponder interrogation is performed until the ignition key is cycled off and back on.

EXHIBIT F

Page 1 of 2

U of Mich file 415031-952



Ford - Werke Aktiengesellschaft

Postanschrift: Ford - Werke Aktiengesellschaft · 50725 Köln

Besucheradresse:
Spessartstraße
Köln - Merkenich
☎ (02 21) 90 - 0
Telex: 8 88 483

15.07.1998

Ihre Zeichen/Ihre Nachricht	Telefon (02 21) 90 -	Teletex	Telefax (02 21)	Unsere Zeichen/Brief - Nr.
Betreff				

Ford-Werke Aktiengesellschaft, Köln hereby declares that:

All PATS XCVR variants listed here under are electrically identical (also concerning RF aspects) and only have differences in mechanical respects (housing, fixture) .

PATS XCVR Variants

98AP - 15607 - A	:	0° housing angle, direct plug-in connector
98BP - 15607 - A	:	90° housing angle, direct plug-in connector, long mounting tab
98VP - 15607 - A	:	90° housing angle, direct plug-in connector, short mounting tab

EXHIBIT F

Page 2 of 2

U of Mich file 415031-956

K98AP-3458-ZBB

NO.	DATE	REVISIONS	BY	CHKD
970236	970236	DELG E 1070926 000		
970532	970532	DELG E 1070620 000 R11 249K.15 -- 100K.58 R41 249K.15 -- 240K.58 Remove placeholder C14 Rename C15 -- C14 C15 100K.58		
970725	970725	DELG E 1076761 000 C20 250K.58 -- 500K.100 Add D2		

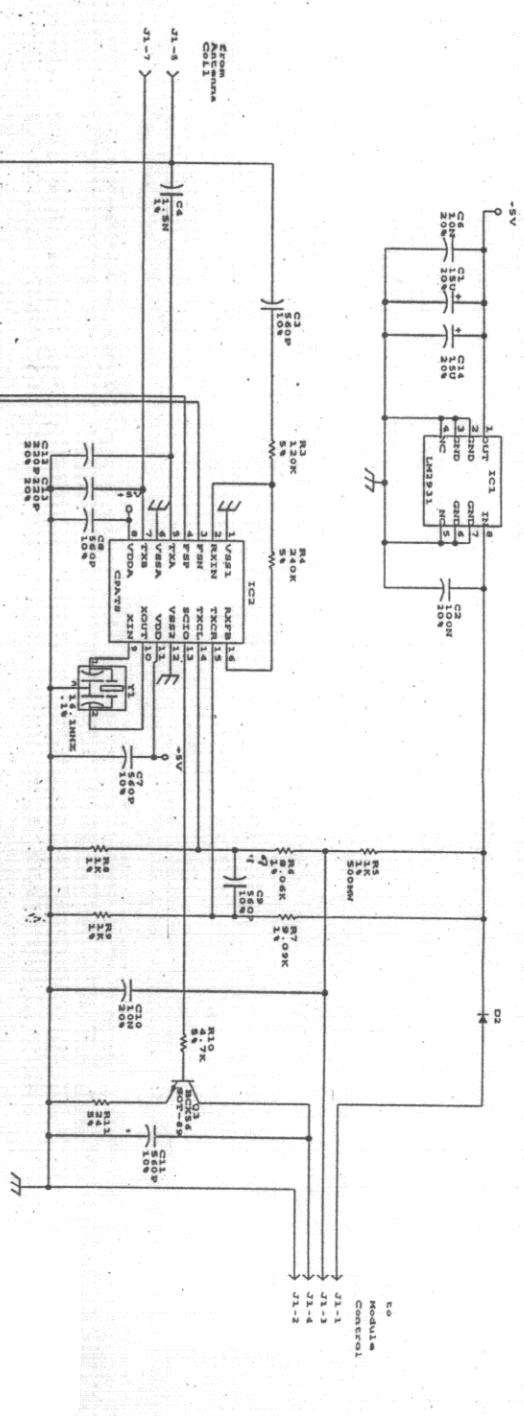

EXHIBIT 5
 Page 2 of 2
 U of Mich file 415031-952

NAME: []
 DATE: []
 APPROVED: []
 CHECKED: []
 DRAWN BY: []
 DATE: []
 NO. OF SHEETS: []
 SHEET NO.: []
 PROJECT: K98AP-3458-ZBB
 DRAWING TITLE: []
 DRAWING SCALE: []
 DRAWING DATE: []
 DRAWING BY: []
 DRAWING CHECKED: []
 DRAWING APPROVED: []

FORD PRODUCT ENGINEERING			
DESIGNER	DATE	SCALE	CHECKED
N. TIDWASH	5/27/75	1:1	NAI
CONDUCTOR - BOTTOM		L. BOEK	
(088131A6.D81)		(P48131)	
BOARD - PRINTED WORKING			
98AP-14A608-ZBB			
BOARD - PRINTED WORKING HEADFILE			
XXX-14A615-XXX			

EXHIBIT H
 Page 1 of 2
 U of Mich file 415031-952

