



Product Service

**Choose certainty.
Add value.**

Report On

Environmental Approval Testing of the
McMurdo Ltd Z500 Family

In accordance with

RTCM Paper 219-2011-SC119-155 (CDV - RTCM 11901.1) and
IEC 60945

Document 75912801 Report 07 Issue 2

March 2012



Product Service

TÜV SÜD Product Service Ltd, Octagon House, Concorde Way, Segensworth North,
Fareham, Hampshire, United Kingdom, PO15 5RL
Tel: +44 (0) 1489 558100. Website: www.tuvps.co.uk

REPORT ON Limited Environmental Approval Testing of the
McMurdo Ltd Z500 Family
In accordance with RTCM Paper 219-2011-SC119-155 (CDV - RTCM
11901.1) and IEC 60945



Document 75912801 Report 07 Issue 2

March 2012

PREPARED FOR McMurdo Ltd
Silver Point
Airport Service Road
Hilsea
Portsmouth
Hampshire
PO3 5PB

PREPARED BY 
S Jones
Project Engineer

APPROVED BY

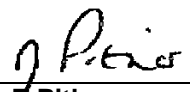
 M Jenkins Authorised Signatory	 K Archer Authorised Signatory	 J Pither Authorised Signatory
--	--	---

DATED 29 March 2012 29 March 2012 29 March 2012

This report has been revised to issue 2 to correct typographical errors.



CONTENTS

Section		Page No
1	REPORT SUMMARY	4
1.1	Introduction	5
1.2	Brief Summary of Results	6
1.3	Declaration of Build Status	8
1.4	Product Information	10
1.5	Deviations from the Standard	12
1.6	Modification Record	12
2	TEST DETAILS	13
2.1	Performance Requirements: AU Controls and Indicators	14
2.2	Performance Requirements: Self-Test Function	17
2.3	Performance Requirements: Buoyancy	18
2.4	Dry Heat (Storage).....	20
2.5	Dry Heat (Functional).....	23
2.6	Damp Heat.....	26
2.7	Low Temperature (Storage)	28
2.8	Low Temperature (Functional)	30
2.9	Thermal Shock.....	33
2.10	Drop onto Hard Surface.....	37
2.11	Drop into Water.....	40
2.12	Vibration.....	43
2.13	Immersion (Z501)	57
2.14	Immersion (Z502)	59
2.15	Solar Radiation	61
2.16	Oil Resistance.....	62
2.17	Corrosion	63
2.18	Construction Requirements	64
2.19	Optional Performance Features	70
2.20	Documentation.....	71
2.21	Performance Tests – Buoyancy	76
2.22	Performance Tests – Immersion Suit Glove.....	77
2.23	Performance Tests – Controls Durability.....	78
2.24	Performance Tests – Water Activation Test (Z501 only).....	79
2.25	Performance Tests – Rain/spray Non-Activation Test	81
2.26	Performance Tests – Self Test Mode	83
2.27	Performance Tests – Battery Capacity Test.....	84
2.28	Performance Tests – Spurious and Out-Of-Band Emissions	85
2.29	Performance Tests – Base Unit (BU)	91
2.30	Annex E – System Components.....	92
2.31	Annex E – Performance Characteristics.....	93
2.32	Annex E – dOCUMENTATION	96
2.33	Annex E – Battery Capacity Test (Varta Cell)	97
2.34	Annex E – Battery Capacity Test (Panasonic Cell)	99
2.35	Annex E – Frequency Error	101
2.36	Annex E – Conducted Power	102
2.37	Annex E – Radiated Power	104
2.38	Annex E – Modulation Spectrum Slotted Transmission	105
2.39	Annex E – Transmitter Test Sequence and Modulation Accuracy.....	107
2.40	Annex E – Transmitter Output Power Versus Time Function.....	119
2.41	Annex E – Spurious Emissions from the Transmitter.....	122
2.42	Annex E – Link Layer Tests.....	125



Product Service

2.43	Annex F – Internal Navigation Device test methods and procedures	126
3	TEST EQUIPMENT USED	135
3.1	Test Equipment Used	136
4	PHOTOGRAPHS.....	139
4.1	Photographs of Equipment Under Test (EUT).....	140
5	DISCLAIMERS AND COPYRIGHT.....	142
5.1	Disclaimers and Copyright.....	143
ANNEX A	Customer Supplied Information	A.2



Product Service

SECTION 1

REPORT SUMMARY

Limited Approval Testing of the
McMurdo Ltd Z500 Family
In accordance with RTCM Paper 219-2011-Sc119-155 (CDV - RTCM 11901.1) and IEC 60945



Product Service

1.1 INTRODUCTION

The information contained in this report is intended to show verification of the Approval Testing of the McMurdo Ltd Z500 family to the requirements of RTCM Paper 219-2011-SC119-155 (CDV - RTCM 11901.1) and IEC 60945.

Objective	To perform Type Approval Testing to determine the Equipment Under Test's (EUT's) compliance with the Test Specification, for the series of tests carried out.
Manufacturer	McMurdo Ltd
Model Number(s)	Z501 Z502
Serial Number(s)	Z501: 970120005, 970120008, 97000009, 970122289 Z502: 970120031, 97000032
Number of Samples Tested	Six
Test Specification/Issue/Date	RTCM Paper 219-2011-SC119-155 (CDV - RTCM 11901.1) IEC 60945: 2002
Order Number	PC0004399
Date	10 February 2011
Start of Test	11 July 2011
Finish of Test	30 January 2012
Name of Engineer(s)	I Bromley S Mooney C Bowles R Hampton N Williams
Related Test Specifications	IEC 61097-14 2010 EN 60068-2-18: 2001



1.2 BRIEF SUMMARY OF RESULTS

A brief summary of the tests carried out in accordance with RTCM Paper 219-2011-SC119-155 (CDV - RTCM 11901.1) and IEC 60945 is shown below.

Section	Clause			Test Description	Result	Comments
	RTCM	IEC 60945	EN 60068			
2.1	4.1	-	-	Performance Requirements: AU Controls and Indicators	Satisfactory	-
2.2	4.2	-	-	Performance Requirements: Self-Test Function	-	Manufacturers Declaration
2.3	4.3 and 8.1.3	-	-	Performance Requirements: Buoyancy	Satisfactory	-
2.4	4.4	8.2.1	-	Dry Heat (Storage)	Satisfactory	-
2.5	4.4	8.2.2	-	Dry Heat (Functional)	Satisfactory	-
2.6	4.4	8.3	-	Damp Heat	Satisfactory	-
2.7	4.4	8.4.1	-	Low Temperature (Storage)	Satisfactory	-
2.8	4.4	8.4.2	-	Low Temperature (Functional)	Satisfactory	-
2.9	4.4	8.5	-	Thermal Shock	Satisfactory	-
2.10	4.4	8.6.1	-	Drop onto Hard Surface	Satisfactory	Z501 was dropped with the antenna in the stowed position.
2.11	4.4	8.6.2	-	Drop into Water	Satisfactory	Z501 was dropped installed in a lifejacket.
2.12	4.4	8.7	-	Vibration	Satisfactory	-
2.13	4.4	8.9.2	-	Immersion (Z01)	Satisfactory	10m: Z501 only.
2.14	4.4	-	Method R c 2	Immersion (Z502)	Satisfactory	In accordance with EN 60068-2-16, 60m: Z502 only.
2.15	4.4	8.10	-	Solar Radiation	-	Waiver request: see Annex A
2.16	4.4	8.11	-	Oil Resistance	-	Waiver request: see Annex A
2.17	4.4	8.12	-	Corrosion	-	Waiver request: see Annex A
2.18	5	-	-	Construction Requirements	-	-
2.19	6	-	-	Optional Performance Features	-	-
2.20	7	-	-	Documentation	Satisfactory	-



Section	Clause			Test Description	Result	Comments
	RTCM	IEC 60945	EN 60068			
2.21	8.1.3	-	-	Performance Tests - Buoyancy	Satisfactory	See section 2.3.5
2.22	8.1.4.1	-	-	Performance Tests – Immersion Suit Glove	Satisfactory	-
2.23	8.1.4.2	-	-	Performance Tests – Controls Durability	-	Manufacturer's Declaration – see annex A
2.24	8.1.5.1	-	-	Performance Tests – Water Activation Test (Z501 only)	Satisfactory	-
2.25	8.1.5.2	-	-	Performance Tests – Rain/spray Non-Activation Test	Satisfactory	-
2.26	8.1.6	-	-	Performance Tests – Self Test Mode	Satisfactory	-
2.27	8.1.7	-	-	Performance Tests – Battery Capacity Test	-	See section 2.32
2.28	8.1.8	-	-	Performance Tests – Spurious and Out-Of-Band Emissions	Satisfactory	-
2.29	8.2	-	-	Performance Tests – Base Unit (BU)	-	Not Applicable
2.30	E.2	-	-	Annex E – System Components	Satisfactory	-
2.31	E.3	-	-	Annex E – Performance Characteristics	Satisfactory	-
2.32	E.6.5	-	-	Annex E – Battery Capacity Test (Varta Cell)	Satisfactory	-
2.33	E.6.5	-	-	Annex E – Battery Capacity Test (Panasonic Cell)	Satisfactory	-
2.34	E.7.1.1.1			Annex E – Frequency Error	Pass	-
2.35	E.7.2	-	-	Annex E – Conducted Power	Pass	-
2.36	E.7.3	-	-	Annex E – Radiated Power	Pass	-
2.37	E.7.3.1.4	-	-	Annex E – Modulation Spectrum Slotted Transmission	Pass	-
2.38	E.7.4	-	-	Annex E – Transmitter Test Sequence and Modulation Accuracy	Pass	-
2.39	E.7.5	-	-	Annex E – Transmitter Output Power Versus Time Function	Pass	-
2.40	E.7.6	-	-	Annex E – Spurious Emissions from the Transmitter	Pass	-
2.41	E.8	-	-	Annex E – Link Layer Tests	-	Not tests at TUV SUD Product Service
2.42	F.2.2	-	-	Annex F – Scenarios	Pass	See Section 2.42



Product Service

1.3 DECLARATION OF BUILD STATUS

MAIN EUT		
MANUFACTURING DESCRIPTION	OEM	
MANUFACTURER	McMurdo Ltd	
TYPE	Z501	
PART NUMBER	K98-001-001A	
SERIAL NUMBER	970120008 970000009	
HARDWARE VERSION	Issue 1	
SOFTWARE VERSION	1.1.4	
TRANSMITTER OPERATING RANGE	161.975MHz to 162.025MHz	
RECEIVER OPERATING RANGE	Not applicable	
COUNTRY OF ORIGIN	United Kingdom	
INTERMEDIATE FREQUENCIES	Not applicable	
ITU DESIGNATION OF EMISSION	16K0F1DXN	
HIGHEST INTERNALLY GENERATED FREQUENCY	162.025MHz	
OUTPUT POWER (W or dBm)	0.72W ERP nominal	
FCC ID	KLS-Z501	
INDUSTRY CANADA ID	IC6913A-Z501	
TECHNICAL DESCRIPTION (a brief description of the intended use and operation)	Used as a personal AIS SART beacon, the Z501 has a unique ID code and will receive its position via an internal GPS module; this data is combined and transmitted using the international AIS channels (AIS 1 – 161.975MHz and AIS 2 – 162.025MHz) in the maritime VHF band.	
BATTERY/POWER SUPPLY		
MANUFACTURING DESCRIPTION	OEM	
MANUFACTURER	Varta microbattery (or Panasonic)	
TYPE	Lithium Manganese Dioxide	
PART NUMBER	Varta CR2/3AH Panasonic CR123A	
VOLTAGE	6v nominal	
COUNTRY OF ORIGIN	Germany (Varta micro battery) or USA (Panasonic)	
ANCILLARIES (if applicable)		
MANUFACTURING DESCRIPTION	Webbing clip	Oral tube clip
MANUFACTURER	McMurdo	McMurdo
TYPE	-	-
PART NUMBER	98-202	98-203
SERIAL NUMBER	N/A	N/A
COUNTRY OF ORIGIN	United Kingdom	United Kingdom



Product Service

MAIN EUT	
MANUFACTURING DESCRIPTION	OEM
MANUFACTURER	McMurdo Ltd
TYPE	Z502
PART NUMBER	98-051-001A
SERIAL NUMBER	9701200031 9700000032
HARDWARE VERSION	Issue 1
SOFTWARE VERSION	1.1.4
TRANSMITTER OPERATING RANGE	161.975MHz to 162.025MHz
RECEIVER OPERATING RANGE	Not applicable
COUNTRY OF ORIGIN	United Kingdom
INTERMEDIATE FREQUENCIES	Not applicable
ITU DESIGNATION OF EMISSION	16K0F1DXN
HIGHEST INTERNALLY GENERATED FREQUENCY	162.025MHz
OUTPUT POWER (W or dBm)	1.18W ERP nominal
FCC ID	KLS-Z502
INDUSTRY CANADA ID	IC6913A-Z502
TECHNICAL DESCRIPTION (a brief description of the intended use and operation)	Used as a personal AIS SART beacon, the Z501 has a unique ID code and will receive its position via an internal GPS module; this data is combined and transmitted using the international AIS channels (AIS 1 – 161.975MHz and AIS 2 – 162.025MHz) in the maritime VHF band.
BATTERY/POWER SUPPLY	
MANUFACTURING DESCRIPTION	OEM
MANUFACTURER	Varta microbattery (or Panasonic)
TYPE	Lithium Manganese Dioxide
PART NUMBER	Varta CR2/3AH Panasonic CR123A
VOLTAGE	6v nominal
COUNTRY OF ORIGIN	Germany (Varta micro battery) or USA (Panasonic)

Signature

Signature held on file

Date

18 May 2011

Note: This document has been prepared to enable manufacturers with no mechanism for producing their own Declaration of Build Status, to declare the build state of the equipment submitted for test.

No responsibility will be accepted by TÜV SÜD Product Service Ltd as to the accuracy of the information declared in this document by the manufacturer.

1.4 PRODUCT INFORMATION

1.4.1 Technical Description

The Equipment Under Test (EUT) was a McMurdo Ltd Z501 and Z502 (AIS SARTs) as shown in the photographs below. A full technical description can be found in the manufacturer's documentation.



Z501: antenna stowed



Z501: antenna deployed



Z502



Product Service

1.5 DEVIATIONS FROM THE STANDARD

No deviations from the applicable test standards or test plan were made during testing.

1.6 MODIFICATION RECORD

No modifications were made to the EUT during testing.



Product Service

SECTION 2

TEST DETAILS

Limited Approval Testing of the
McMurdo Ltd Z500 family In accordance with
RTCM Paper 219-2011-SC119-155 (CDV - RTCM 11901.1) and IEC 60945



Product Service

2.1 PERFORMANCE REQUIREMENTS: AU CONTROLS AND INDICATORS

2.1.1 Specification Reference

RTCM Paper 219-2011-sc119-155 CDV – RTCM 11901.1, Clause 4.1

2.1.2 Equipment Under Test

Z500 Family (Z501), S/N: 970000009
Z500 Family (Z502), S/N: 970000032

2.1.3 Date of Test and Modification State

30 January 2012 - Modification State 0

2.1.4 Test Equipment Used

The major items of test equipment used for the above tests are identified in Section 3.1.



Product Service

2.1.5 Test Results

The EUTs were physically inspected for the various clauses and documented below.

Z501 Observation Outcome

4.1.1: AUs provided with only manual activation shall have as a minimum, clearly marked integral manual controls to operate the device in the following modes: ON, TEST and OFF

The Z501 activation is capable of being both manual and automatic.

4.1.2: User Controls for AUs with both manual and automatic activation in the following modes: READY or ARMED, ON and TEST

The Z501 activation is both manual and automatic and is equipped with limited written operating instructions on the device.

There is a 2 piece orange and red tamperproof system which prevents inadvertent activation. For manual activation the user is guided (by arrows) to remove the orange tab and then the red end section. On removing the red section of the tamperproof device the EUT will commence operation (confirmed by bleeping and the LED flashes). The Z501 label provides indication of the LED flash pattern and additional instructions are provided in the operator's manual supplied with the product.

When installed on a lifejacket the Z501 is in the ARMED position: it is normally deactivated but will activate when the lifejacket inflates (as a result of entering water for example (see Immersion tests Section 2.13)).

There are two TEST modes on the Z501, both are indicated on the unit itself.

4.1.3: Function of the ON control

Once manually activated the Z501 begins the transmission of the alert signal within 30 seconds of switch ON.

4.1.4.1: Indicators - Alerting

The Z501 has a visual indicator that commences within 5 seconds once activated. The Z501 also has an audible indicator but this is not considered by the manufacturer as an 'Alerting Indication' as defined in the relevant standard – the 'beeper' is provided for the user's reference. McMurdo Ltd have declared that the visual indicators are visible in direct sunlight, low light and no light conditions.

4.1.4.2: Indicators – Self-test

The Z501 has several LED flash patterns which indicate whether the self test was successful or not. These LED flash patterns are indicated in the manual. A long and short self test is possible and described in the manual; completion of the short test is indicated by one of several flash patterns, the long test is confirmed by rapid flash patterns. The self test was confirmed in accordance with the manual at all three temperatures, with and without GNSS data.



Product Service

4.1.5: Indicators – Water activation function

The Z501, when installed on a lifejacket, is capable of being automatically activated. For automatic activation tests see section 2.24. For protection against inadvertent activation from salt water or rain see section 2.25.

Z502 Observation Outcome

4.1.1: AUs provided with only manual activation shall have as a minimum, clearly marked integral manual controls to operate the device in the following modes: ON, TEST and OFF.

The Z502 activation is manual and is equipped with limited written operating instruction on the device. To switch the unit ON there is an orange activation mechanism which contains a “Pull to Release” pin which prevents inadvertent activation. The user is required to remove the release pin and then pull down and twist clockwise the orange activation mechanism in order to activate the device (confirmed by LED flashes). To switch the unit OFF the user is required to twist the orange activation mechanism in an anticlockwise direction. There are two TEST modes on the Z502, both are indicated on the unit itself.

The Z502 label provides indication of the LED flash pattern and additional instructions are provided in the operator’s manual supplied with the product.

4.1.2: User Controls for AUs with both manual and automatic activation in the following modes: READY or ARMED, ON and TEST.

The Z502 activation is only via manually operation.

4.1.3: Function of the ON control.

Once manually activated the Z502 begins the transmission of the alert signal within the first 30 seconds after switch ON.

4.1.4.1: Indicators - Alerting

The Z502 has a visual indicator that commences within 5 seconds once activated. The visual indicator is visible in bright day light, low light and no light conditions.

4.1.4.2: Indicators – Self-test

The Z502 has several LED flash patterns which indicate whether the self test was successful or not. These LED flash patterns are indicated in the manual. A long and short self test is possible and described in the manual; completion of the short test is indicated by one of several flash patterns, the long test is confirmed by rapid flash patterns. The self test was confirmed in accordance with the manual at all three temperatures, with and without GNSS data.

4.1.5: Indicators – Water activation function

There is no provision for a water-activation function on the Z502.



Product Service

2.2 PERFORMANCE REQUIREMENTS: SELF-TEST FUNCTION

2.2.1 Specification Reference

RTCM Paper 219-2011-sc119-155 CDV – RTCM 11901.1, Clause 4.2

2.2.2 Manufacturers Declaration

Refer to Annex A for manufacturer's declaration.



Product Service

2.3 PERFORMANCE REQUIREMENTS: BUOYANCY

2.3.1 Specification Reference

RTCM Paper 219-2011-sc119-155 CDV – RTCM 11901.1, Clause 4.3 & 8.1.3

2.3.2 Equipment Under Test

Z500 Family (Z502), S/N: 970120032

2.3.3 Date of Test and Modification State

12 December 2011 - Modification State 0

2.3.4 Test Equipment Used

The major items of test equipment used for the above tests are identified in Section 3.1.

2.3.5 Test Procedure

The Z502 was placed in a container of water and the buoyancy was calculated.

2.3.6 Test Set-up and Operating Modes

The test was performed with the EUT in the following mode(s): Idle.



Buoyancy Test

2.3.7 Test Results

The EUT was completely submerged in a vessel completely filled with domestic tap water. The reserve buoyancy was calculated by dividing the displaced water (EUT volume above the waterline) by the EUT volume below the waterline:

Container Full: 1.806Kg
EUT bouyant: 1.617Kg
EUT fully Submerged: 1.596Kg
Buoyant = 0.189Kg

Fully Submerged = 0.21 Kg

Volume above unit = $0.21 - 0.189 = 0.021$

Reserve Buoyancy = $0.021 / 0.21 = 0.1 \times 100 = 10\%$ Reserve Buoyancy

Note: The Z501 is buoyant when incorporated in a lifejacket.



Product Service

2.4 DRY HEAT (STORAGE)

2.4.1 Specification Reference

RTCM Paper 219-2011-sc119-155 CDV – RTCM 11901.1, Clause 4.4
IEC 60945, Clause 8.2.1

2.4.2 Equipment Under Test

Z501: TUV ref: 75912801-TSR0011 (S/N 970120008)
Z502: TUV ref: 75912801-TSR0012 (S/N 970120031)

2.4.3 Date of Test and Modification State

11 July 2011 – 12 July 2011 - Modification State 0

2.4.4 Test Equipment Used

The major items of test equipment used for the above tests are identified in Section 3.1.

2.4.5 Test Procedure

The EUT was placed in the environmental chamber at laboratory ambient conditions. The temperature of the chamber was then raised to +70 °C. The temperature of the chamber was maintained for a period of 16 hours after which time the temperature of the chamber was returned to lab ambient. The performance check was then carried out.

2.4.6 Test Set-up and Operating Modes

The test was performed with the EUT in the following mode(s): Idle.



Test Set-up – Dry Heat (Storage and Functional), Damp Heat and Low Temperature (Storage and Functional)



2.4.7 Test Results

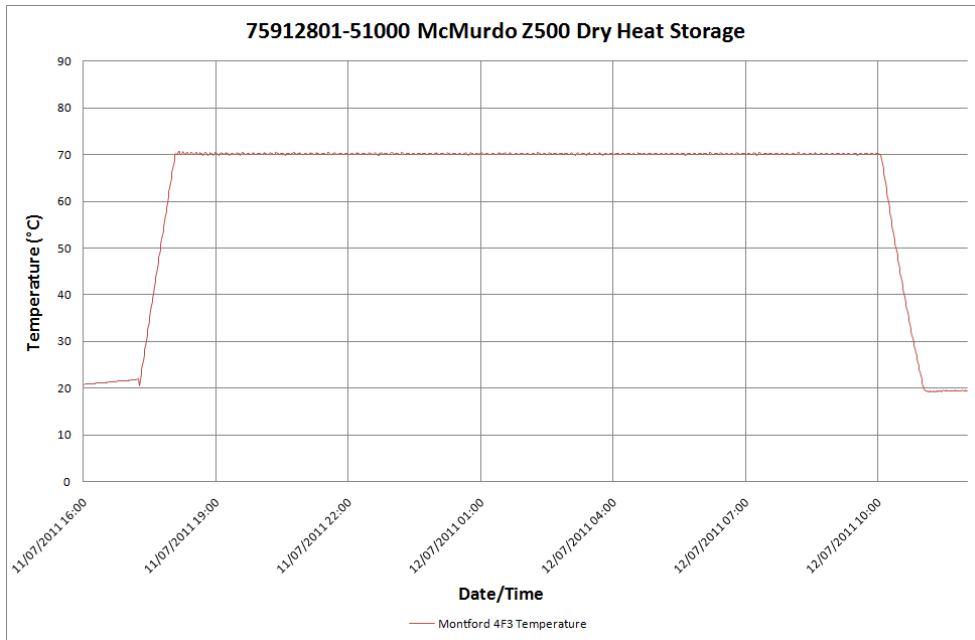

The test was completed successfully and no damage or derogation to the unit was observed.

Performance Check

The performance check described in IEC 61097-14 was carried out; consisting of activating the EUT in self test mode with a GPS signal provided via a GPS simulator. Messages 1 and 14 from both the Z501 and Z502 were received by an AIS receiver.



Product Service

2.5 DRY HEAT (FUNCTIONAL)

2.5.1 Specification Reference

RTCM Paper 219-2011-sc119-155 CDV – RTCM 11901.1, Clause 4.4
IEC 60945, Clause 8.2.2

2.5.2 Equipment Under Test

Z501: TUV ref: 75912801-TSR0011 (S/N 970120008)
Z502: TUV ref: 75912801-TSR0012 (S/N 970120031)

2.5.3 Date of Test and Modification State

12 July 2011 – 13 July 2011 - Modification State 0

2.5.4 Test Equipment Used

The major items of test equipment used for the above tests are identified in Section 3.1.

2.5.5 Test Procedure

The EUT was placed in the environmental chamber at laboratory ambient conditions and switched on. The temperature of the chamber was then raised to +55 °C for a period of 21.5 hours. The performance check was then carried out whilst at temperature. Following completion of the performance check the chamber conditions were returned to laboratory ambient.

2.5.6 Test Set-up and Operating Modes

The test was performed with the EUT in the following mode(s): Active.

For test set-up photograph see section 2.1.6.



2.5.7 Test Results

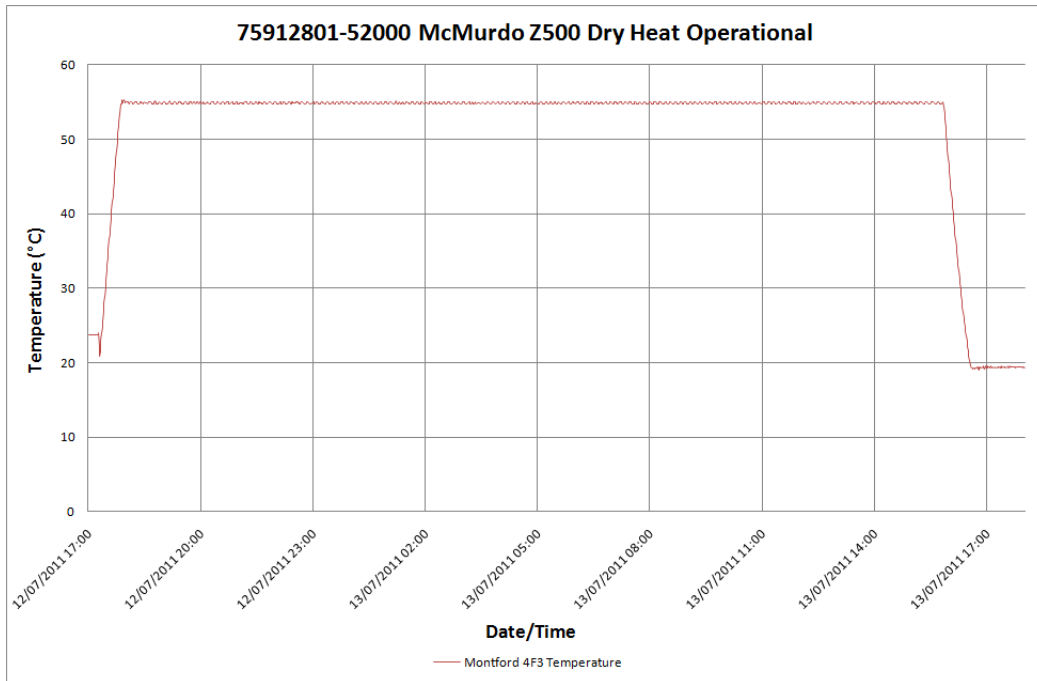

The test was completed successfully and no damage or derogation to the unit was observed.



Performance Check

The performance check described in IEC 61097-14 was carried out; consisting of activating the EUT in self test mode with a GPS signal provided via a GPS simulator. Messages 1 and 14 from both the Z501 and Z502 were received by an AIS receiver.

In addition to the performance check the performance test was also carried out; this test consisted of activating the EUT in self test mode with GPS signal provided via a GPS simulator. The integrity of the transmitted bursts was checked.

61097-14 Performance Test (Clause 5.2.3, 8.3.2.2)	Comments / Data	Result
A: EUT starts transmission after valid GNSS data is available.	GNSS data was supplied to both EUTs and the self test function was activated. Messages 1 and 14 were received by an AIS receiver for both EUTs therefore transmissions were successful.	Pass
B: A single burst of 8 messages in the correct order and correctly populated as per 3.7.2.	8 messages were received for each EUT and the actual decoded messages were compared against the required decoded message.	Pass
C: User ID as configured in the EUT.	Z501 Received and Actual User ID:970120008 Z502 Received and Actual User ID:970120031	Pass
D: Navigational status = 15 (not defined).	Navigational status of all message 1 messages for both EUTs was equal to 15.	Pass
E: SOG = actual SOG from GNSS receiver.	The SOG value received for the Z501 was equal to 0 knots. The SOG value received for the Z502 was equal to 0.1 knots. See Note 1.	-
F: Position accuracy = according to the RAIM result if provided, otherwise 0.	Position accuracy was equal to 0 for both EUTs.	Pass
G: Position = actual position from internal GNSS receiver.	The applied position was equal to the received position for both EUTs.	Pass
H: COG = actual COG from internal GNSS receiver	The COG was 360 (not available) for both EUTs.	Pass
I: Time stamp = actual UTC second (0...59).	Timestamp was valid for both EUTs (36 and 55).	Pass
J: The communication state time-out always = 0 with sub message = 0.	The communication state time-out was = 0 with sub message = 0 for both EUTs.	Pass
K: The transmission of Messages 1 and 14 stops after one burst of 8 messages.	The AIS receiver did not receive any more than 8 messages for each self test for each EUT.	Pass
L: The text message in Message 14 is "SART TEST".	Text message of message 14 was decoded as "SART TEST" for each EUT	Pass
M: Verify correct indication as per manufacturer's documentation.	Z501: three long beeps and flashes. Z502: three long flashes.	Pass

Note 1: Applied position had no COG or SOG, however, given the SOG is the smallest value possible to encode apart from zero, this was disregarded, that being the case, the COG also becomes invalid. It is likely that the SOG/COG came from the acquired position changing as accuracy improved in the initial few seconds of position validity. NB: 0.1kts = 0.051ms-1



Product Service

2.6 DAMP HEAT

2.6.1 Specification Reference

RTCM Paper 219-2011-sc119-155 CDV – RTCM 11901.1, Clause 4.4
IEC 60945, Clause 8.3

2.6.2 Equipment Under Test

Z501: TUV ref: 75912801-TSR0011 (S/N 970120008)
Z502: TUV ref: 75912801-TSR0012 (S/N 970120031)

2.6.3 Date of Test and Modification State

13 July 2011 to 14 July 2011 - Modification State 0

2.6.4 Test Equipment Used

The major items of test equipment used for the above tests are identified in Section 3.1.

2.6.5 Test Procedure

The EUT was placed in the environmental chamber at laboratory ambient conditions. The temperature of the chamber was then raised to +40 °C and the relative humidity raised to 93% over a period of 3 hours. The conditions were maintained for a period of 12 hours and 55 minutes during which time the performance check was carried out and the EUT was allowed to operate for a period of 2 hours. Once the performance check was complete the chamber conditions were returned to laboratory ambient.

2.6.6 Test Set-up and Operating Modes

The test was performed with the EUT in the following mode(s): Idle.

For test set-up photograph see section 2.1.6.



2.6.7 Test Results

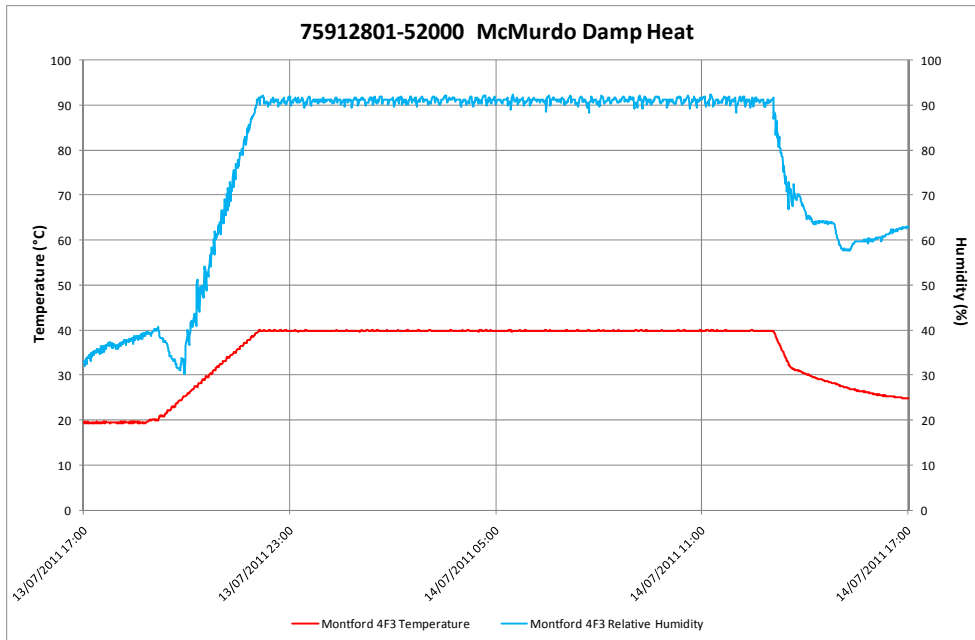

The test was completed successfully and no damage or derogation to the unit was observed.

Performance Check

The performance check described in IEC 61097-14 was carried out; consisting of activating the EUT in self test mode with a GPS signal provided via a GPS simulator. Messages 1 and 14 from both the Z501 and Z502 were received by an AIS receiver.



2.7 LOW TEMPERATURE (STORAGE)

2.7.1 Specification Reference

RTCM Paper 219-2011-sc119-155 CDV – RTCM 11901.1, Clause 4.4
IEC 60945, Clause 8.4.1

2.7.2 Equipment Under Test

Z501: TUV ref: 75912801-TSR0011 (S/N 970120008)
Z502: TUV ref: 75912801-TSR0012 (S/N 970120031)

2.7.3 Date of Test and Modification State

14 July 2011 – 15 July 2011 - Modification State 0

2.7.4 Test Equipment Used

The major items of test equipment used for the above tests are identified in Section 3.1.

2.7.5 Test Procedure

The EUT was placed in the environmental chamber at laboratory ambient conditions. The temperature of the chamber was then reduced to -30 °C. The temperature of the chamber was maintained for a period of 12 hours and 45 minutes after which time the temperature of the chamber was returned to lab ambient. The performance check was then carried out.

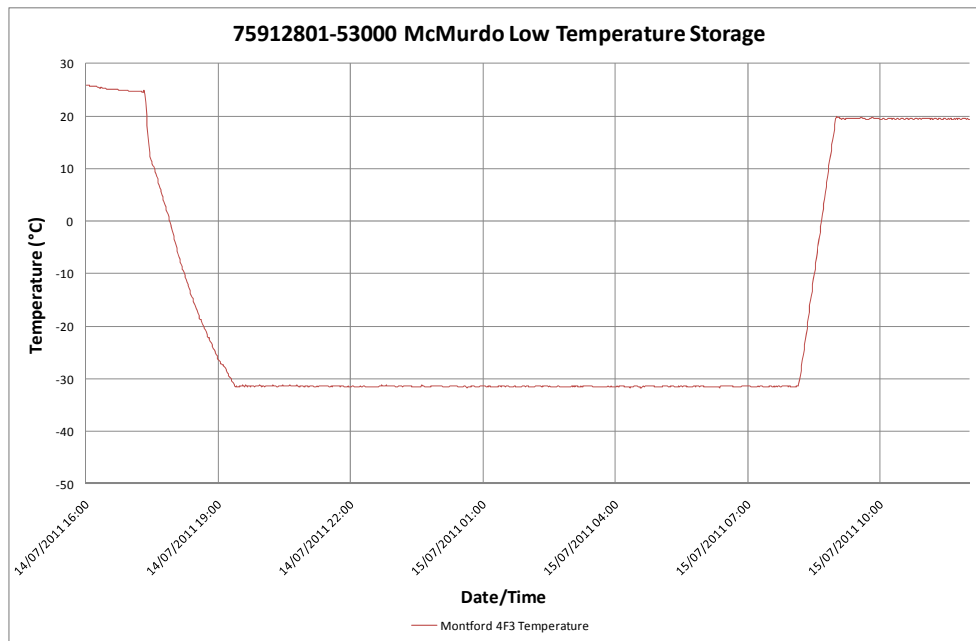

The test was completed successfully and no damage or derogation to the unit was observed



Product Service

2.7.6 Test Set-up and Operating Modes

The test was performed with the EUT in the following mode(s): Idle.

For test set-up photograph see section 2.1.6.

2.7.7 Test Results

The test was completed successfully and no damage or derogation to the unit was observed.

Performance Check

The performance check described in IEC 61097-14 was carried out; consisting of activating the EUT in self test mode with a GPS signal provided via a GPS simulator. Messages 1 and 14 from both the Z501 and Z502 were received by an AIS receiver.



Product Service

2.8 LOW TEMPERATURE (FUNCTIONAL)

2.8.1 Specification Reference

RTCM Paper 219-2011-sc119-155 CDV – RTCM 11901.1, Clause 4.4
IEC 60945, Clause 8.4.2

2.8.2 Equipment Under Test

Z501: TUV ref: 75912801-TSR0011 (S/N 970120008)
Z502: TUV ref: 75912801-TSR0012 (S/N 970120031)

2.8.3 Date of Test and Modification State

17 July 2011 – 18 July 2011 - Modification State 0

2.8.4 Test Equipment Used

The major items of test equipment used for the above tests are identified in Section 3.1.

2.8.5 Test Procedure

The EUT was placed in the environmental chamber at laboratory ambient conditions. The temperature of the chamber was then reduced to -21 °C for a period of 20 hours 35 minutes after which the EUT was switched on and continued to operate for 2 hours 50 minutes; the performance check was carried out whilst at temperature. Following completion of the performance check the chamber conditions were returned to laboratory ambient.

2.8.6 Test Set-up and Operating Modes

The test was performed with the EUT in the following mode(s): Active.

For test set-up photograph see section 2.1.6.

2.8.7 Test Results

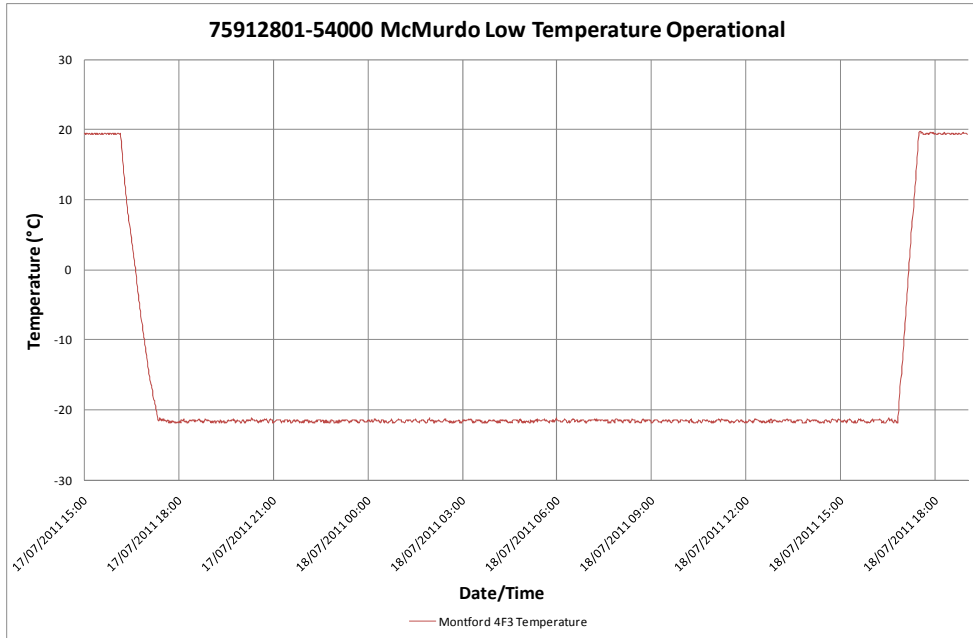

The test was completed successfully and no damage or derogation to the unit was observed.

Performance Check

The performance check described in IEC 61097-14 was carried out; consisting of activating the EUT in self test mode with a GPS signal provided via a GPS simulator. Messages 1 and 14 from both the Z501 and Z502 were received by an AIS receiver.

In addition to the performance check the performance test was also carried out; this test consisted of activating the EUT in self test mode with GPS signal provided via a GPS simulator. The integrity of the transmitted bursts was checked.

61097-14 Performance Test (Clause 5.2.3, 8.3.2.2)	Comments / Data	Result
A: EUT starts transmission after valid GNSS data is available.	GNSS data was supplied to both EUTs and the self test function was activated. Messages 1 and 14 were received by an AIS receiver for both EUTs therefore transmissions were successful.	Pass
B: A single burst of 8 messages in the correct order and correctly populated as per 3.7.2.	8 messages were received for each EUT and the actual decoded messages were compared against the required decoded message.	Pass
C: User ID as configured in the EUT.	Z501 Received and Actual User ID:970120008 Z502 Received and Actual User ID:970120031	Pass
D: Navigational status = 15 (not defined).	Navigational status of all message 1 messages for both EUTs was equal to 15.	Pass
E: SOG = actual SOG from GNSS receiver.	The SOG value received for the Z501 and Z502 was equal to 0 knots. See Note 1.	-
F: Position accuracy = according to the RAIM result if provided, otherwise 0.	Position accuracy was equal to 0 for both EUTs.	Pass
G: Position = actual position from internal GNSS receiver.	The applied position was equal to the received position for both EUTs.	Pass
H: COG = actual COG from internal GNSS receiver	The COG was 360 (not available) for both EUTs.	Pass
I: Time stamp = actual UTC second (0...59).	Time stamp valid for both EUTs (36 for both).	Pass
J: The communication state time-out always = 0 with sub message = 0.	The communication state time-out was = 0 with sub message = 0 for both EUTs.	Pass



Product Service

K: The transmission of Messages 1 and 14 stops after one burst of 8 messages.	The AIS receiver did not receive any more than 8 messages for each self test for each EUT.	Pass
L: The text message in Message 14 is "SART TEST".	Text message of message 14 was decoded as "SART TEST" for each EUT	Pass
M: Verify correct indication as per manufacturer's documentation.	Z501: three long beeps and flashes. Z502: three long flashes.	Pass

Note 1: Applied position had no COG or SOG, however, given the SOG is the smallest value possible to encode apart from zero, this was disregarded, that being the case, the COG also becomes invalid. It is likely that the SOG/COG came from the acquired position changing as accuracy improved in the initial few seconds of position validity. NB: 0.1kts = 0.051ms⁻¹



Product Service

2.9 THERMAL SHOCK

2.9.1 Specification Reference

RTCM Paper 219-2011-sc119-155 CDV – RTCM 11901.1, Clause 4.4
IEC 60945, Clause 8.5

2.9.2 Equipment Under Test

Z501: TUV ref: 75912801-TSR0011 (S/N 970120008)
Z502: TUV ref: 75912801-TSR0012 (S/N 970120031)

2.9.3 Date of Test and Modification State

19 July 2011 to 20 July 2011 - Modification State 0

2.9.4 Test Equipment Used

The major items of test equipment used for the above tests are identified in Section 3.1.

2.9.5 Test Procedure

The EUT was placed in the environmental chamber at laboratory ambient conditions. The temperature of the chamber was then raised to +70°C for 1 hour 40 mins. The EUT was then immersed in water at +25°C to a depth of 100mm, measured from the highest point of the EUT to the surface of the water, for a period of 1 hour; after which time the EUT was subject to a performance check. There were no signs of damage or unwanted ingress of water.

2.9.6 Test Set-up and Operating Modes

The test was performed with the EUT in the following mode(s): Idle.



Test Set-up – Thermal Shock (EUT pre-conditioning)



Test Set-up – Thermal Shock (submerged EUTs)

2.9.7 Test Results

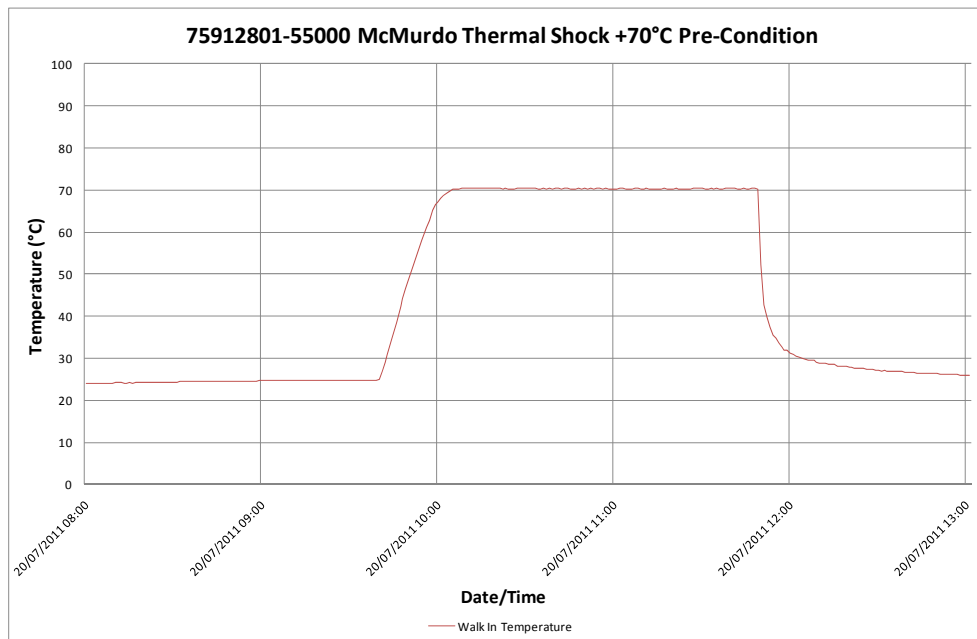

The test was completed successfully and no damage or derogation to the unit was observed.



Product Service

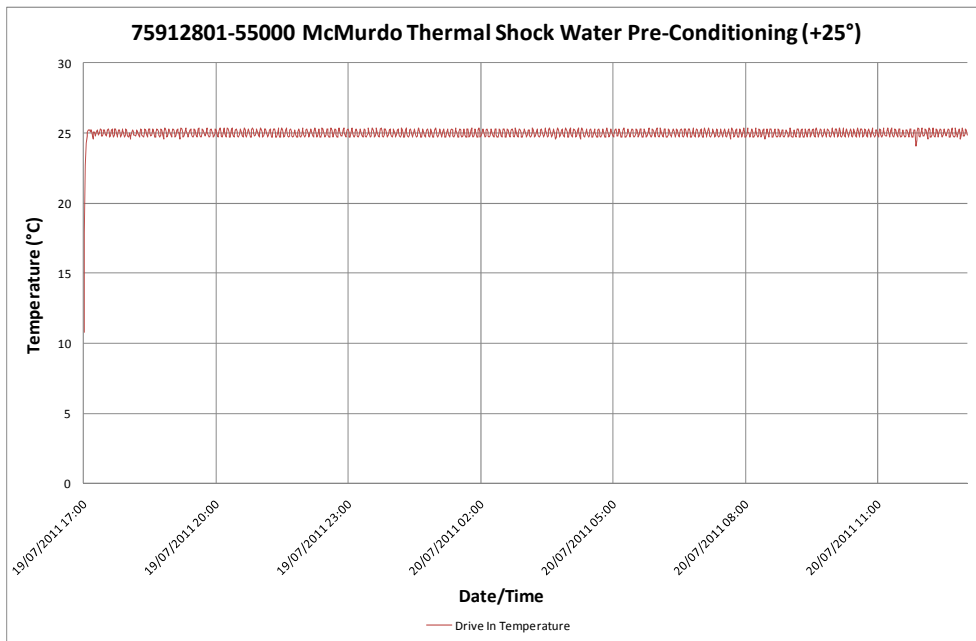

Performance Check

The performance check described in IEC 61097-14 was carried out; consisting of activating the EUT in self test mode with a GPS signal provided via a GPS simulator. Messages 1 and 14 for both the Z501 and Z502 were received by an AIS receiver.



Product Service

2.10 DROP ONTO HARD SURFACE

2.10.1 Specification Reference

RTCM Paper 219-2011-sc119-155 CDV – RTCM 11901.1, Clause 4.4
IEC 60945, Clause 8.6.1

2.10.2 Equipment Under Test

Z501: TUV ref: 75912801-TSR0011 (S/N 970120008)
Z502: TUV ref: 75912801-TSR0012 (S/N 970120031)

2.10.3 Date of Test and Modification State

20 July 2011 - Modification State 0

2.10.4 Test Equipment Used

The major items of test equipment used for the above tests are identified in Section 3.1.

2.10.5 Test Procedure

The EUT was subject to a series of 6 drops; one on each face.

The EUT was dropped onto a solid piece of hard wood.

The height of the lowest part of the EUT to the test surface was 1000mm.

2.10.6 Test Set-up and Operating Modes

The test was performed with the EUT in the following mode(s): Idle.

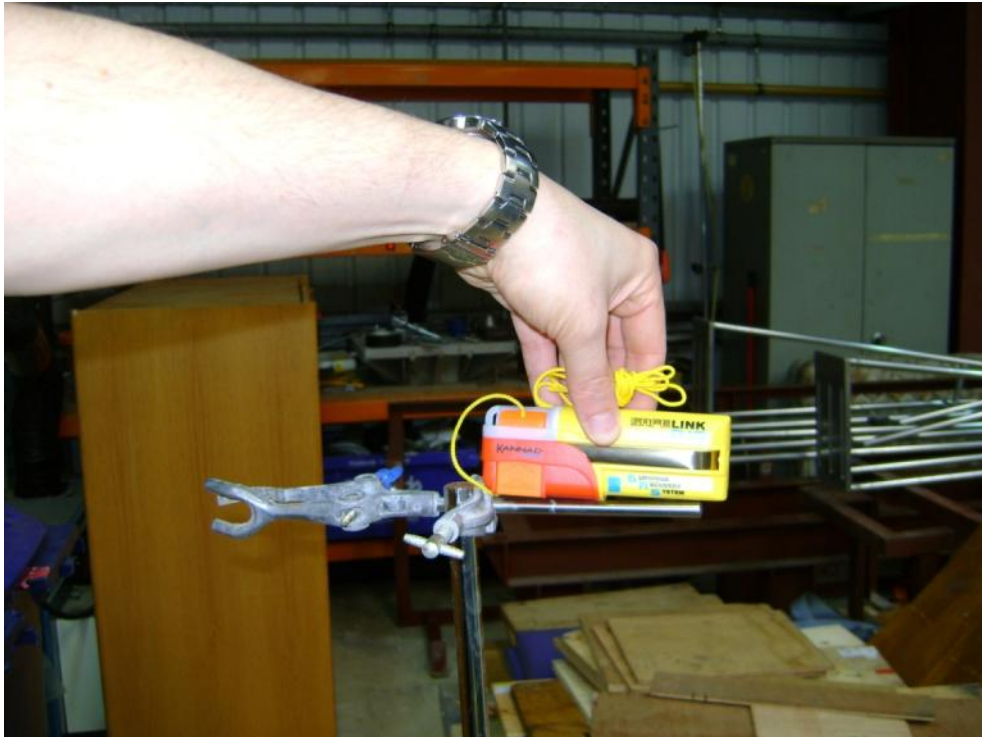

Test Set-up – Drop onto Hard Surface (Z501)



Test Set-up – Drop onto Hard Surface (Z502)



Product Service

2.10.7 Test Results

On completion of the 6 drops the EUT was subject to the performance check. There were no external indications of damage.

It was noted however that the release pin of the Z502 became dislodged after the first drop. Neither the Z501 nor Z502 activated on any of the six drops.

Performance Check

The performance check described in IEC 61097-14 was carried out; consisting of activating the EUT in self test mode with a GPS signal provided via a GPS simulator. Messages 1 and 14 of both the Z501 and Z502 were received by an AIS receiver.



Product Service

2.11 DROP INTO WATER

2.11.1 Specification Reference

RTCM Paper 219-2011-sc119-155 CDV – RTCM 11901.1, Clause 4.4
IEC 60945, Clause 8.6.2

2.11.2 Equipment Under Test

Z501: TUV ref: 75912801-TSR0013 (S/N 970000009)
Z502: TUV ref: 75912801-TSR0014 (S/N 970000032)

2.11.3 Date of Test and Modification State

21 July 2011 - Modification State 0

2.11.4 Test Equipment Used

The major items of test equipment used for the above tests are identified in Section 3.1.

2.11.5 Test Procedure

The EUT was subject to a series of 3 drops with each drop performed with the position of the EUT different from the preceding one.

The EUT was dropped into water.

The height of the lowest part of the EUT to the water surface was 20 m.

The manufacturer declared that the Z501 is designed to be installed in a lifejacket and therefore the drop into water test was carried out with the Z501 installed in a lifejacket.

The Z502 was dropped directly into the water.

2.11.6 Test Set-up and Operating Modes

The test was performed with the EUT in the following mode(s): Idle.



Test Set-up – Drop into Water Z501 installed in lifejacket and being hoisted by crane



Test Set-up – Drop into Water Z502 in preparation for hoisting



Product Service

2.11.7 Test Results

On completion of the 3 drops the EUT was subject to the performance check. There were no external indications of damage or signs unwanted water ingress.

Performance Check

The performance check described in IEC 61097-14 was carried out; consisting of activating the EUT in self test mode with a GPS signal provided via a GPS simulator. Messages 1 and 14 for both the Z501 and Z502 were received by an AIS receiver.



Product Service

2.12 VIBRATION

2.12.1 Specification Reference

RTCM Paper 219-2011-sc119-155 CDV – RTCM 11901.1, Clause 4.4
IEC 60945, Clause 8.7

2.12.2 Equipment Under Test

Z501: TUV ref: 75912801-TSR0011 (S/N 970120008)
Z502: TUV ref: 75912801-TSR0012 (S/N 970120031)

2.12.3 Date of Test and Modification State

27 July 2011 – 29 July 2011 - Modification State 0

2.12.4 Test Equipment Used

The major items of test equipment used for the above tests are identified in Section 3.1.

2.12.5 Test Procedure

The EUT was fixed to the vibration table and was subject to the following vibration profiles:

Resonance Sweep

- 5 Hz and up to 13.2 Hz with an excursion of ± 1 mm (7 m/s² maximum acceleration at 13.2 Hz);
- above 13.2 Hz and up to 100 Hz with a constant maximum acceleration of 7 m/s².

One sweep was performed at a rate of 0.5 octaves / minute.

Endurance Test

No resonances were found and hence both the Z501 and Z502 were subjected to the endurance run of 2 hours at 30 Hz in each axis as prescribed by the standard.

The equipment was subject to a performance test once during and once before the end of each endurance run in each of the axis.

2.12.6 Test Set-up and Operating Modes

The test was performed with the EUT in the following mode(s): idle.

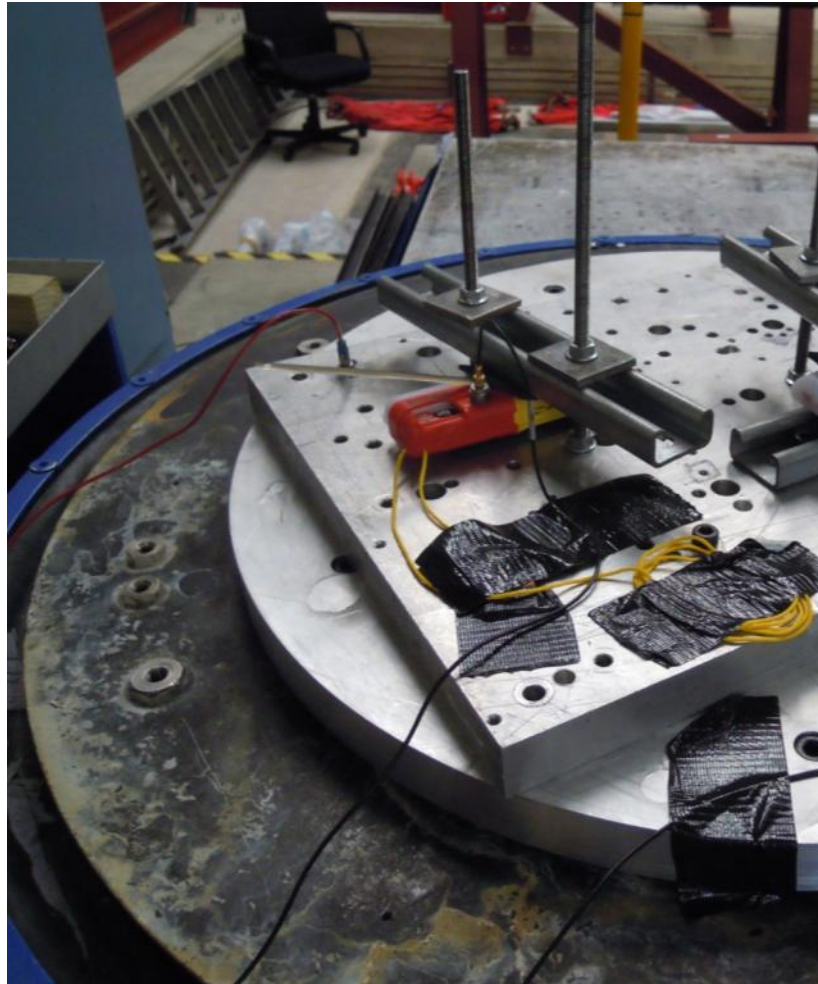

Test Set-up – Vibration (Z501 vertical axis)

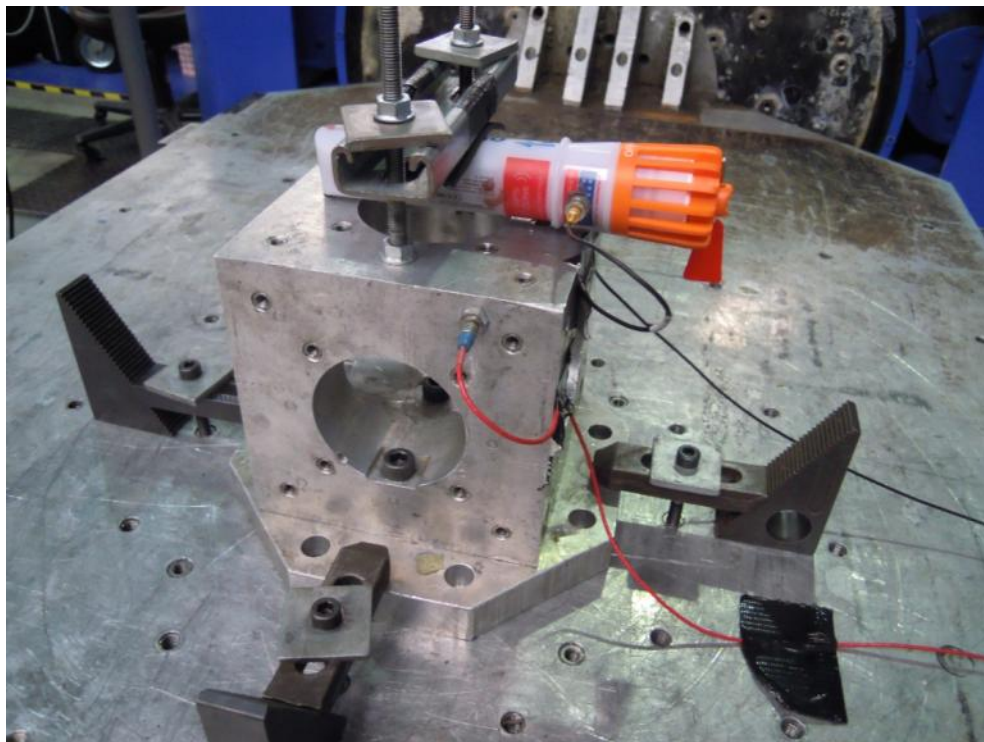

Test Set-up – Vibration (Z502 vertical axis)

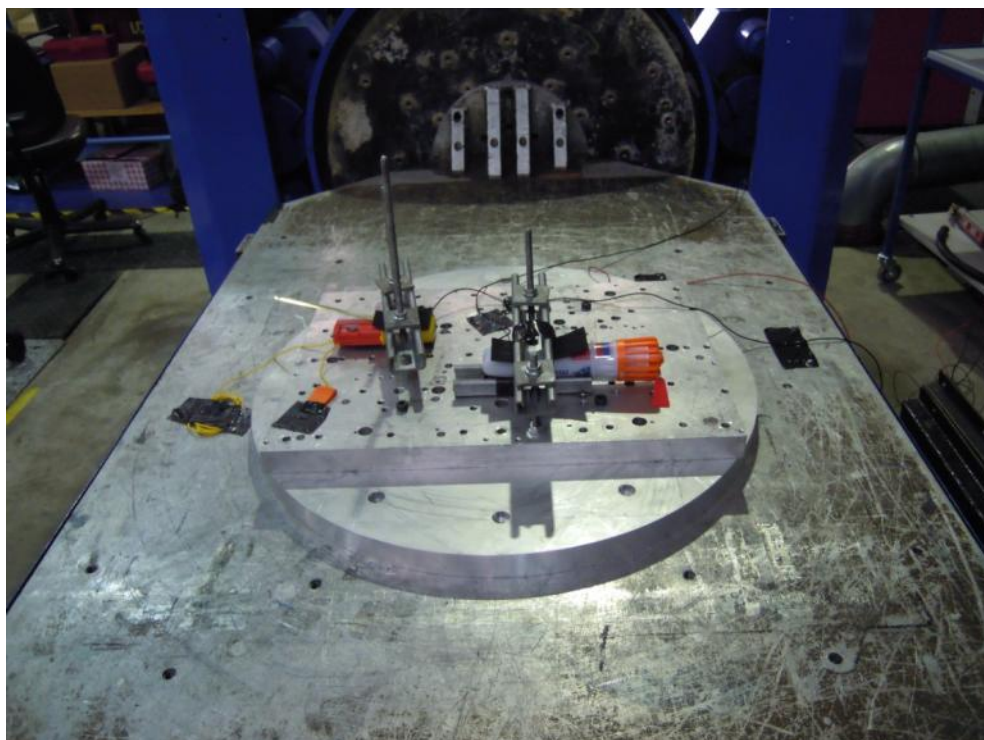

Test Set-up – Vibration (lateral axis – both EUTs)

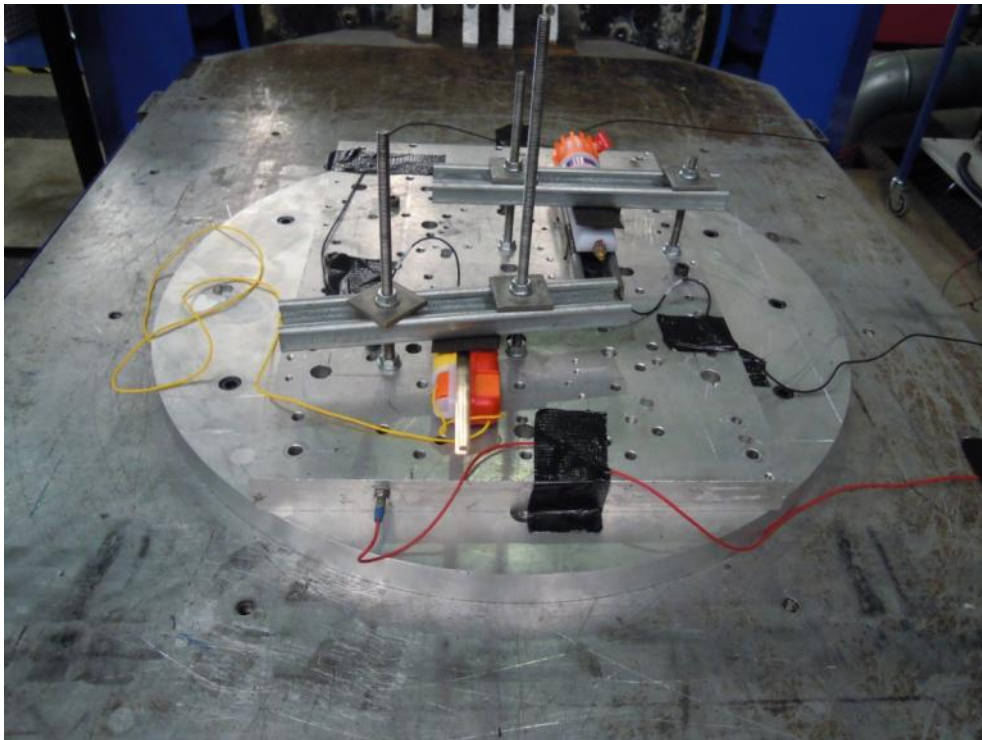

Test Set-up – Vibration (longitudinal axis)

2.12.7 Test Results

The test was completed successfully and no damage or derogation to the unit was observed

No resonances were found and hence both the Z501 and Z502 were subjected to the endurance run of 2 hours at 30 Hz in each axis as prescribed by the standard.

Performance Check

The performance check described in IEC 61097-14 was carried out once during each endurance test period and once before the end of each endurance test period. The performance test consisted of activating the EUT in self test mode with a GPS signal provided via a GPS simulator. Messages 1 and 14 for both the Z501 and Z502 were received by an AIS receiver.



Product Service

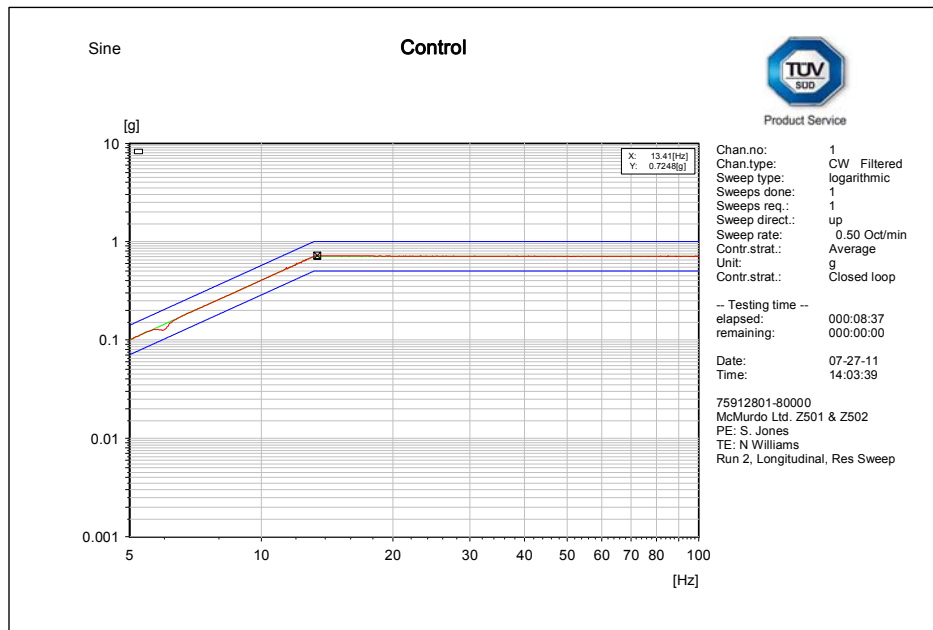

Longitudinal Axis – Resonance Search

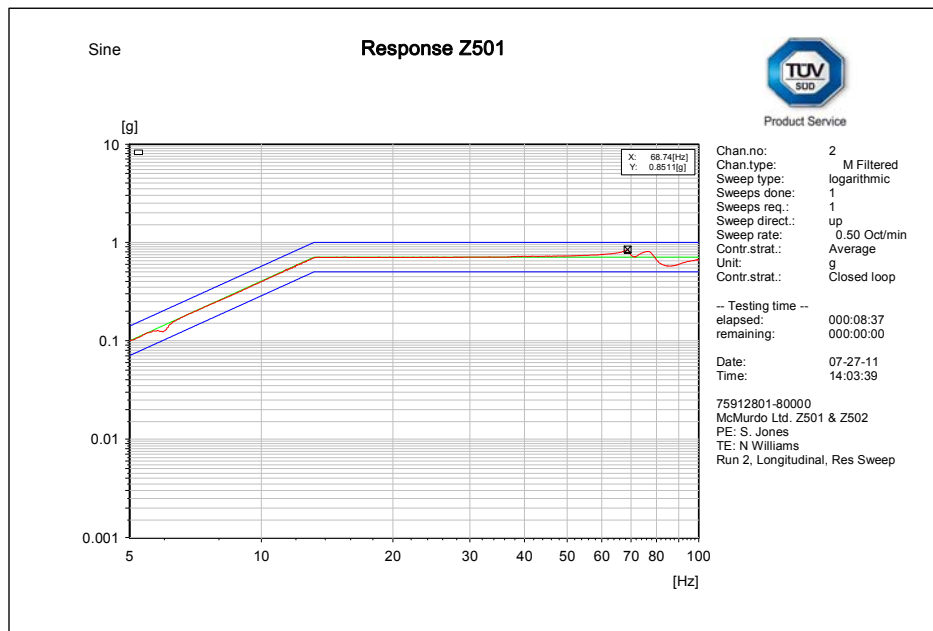

Longitudinal Axis – Resonance Search Z501 Response



Product Service

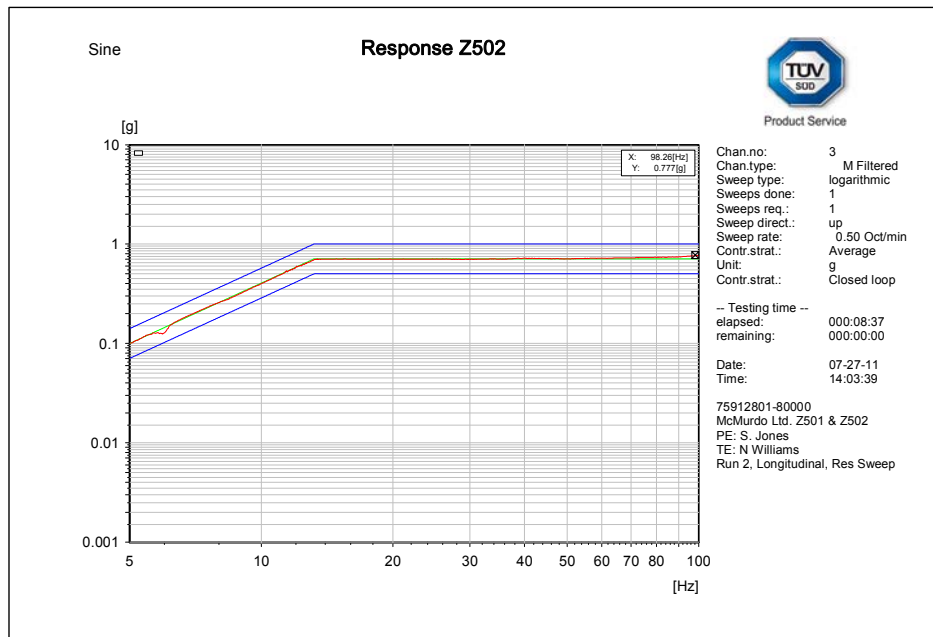

Longitudinal Axis – Resonance Search Z502 Response

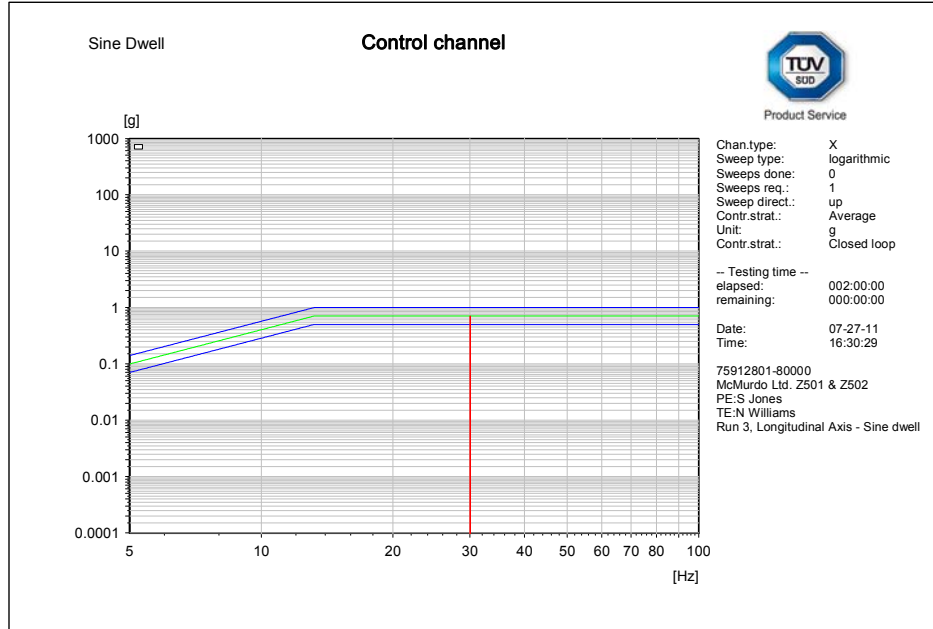

Longitudinal Axis – Endurance Run



Product Service

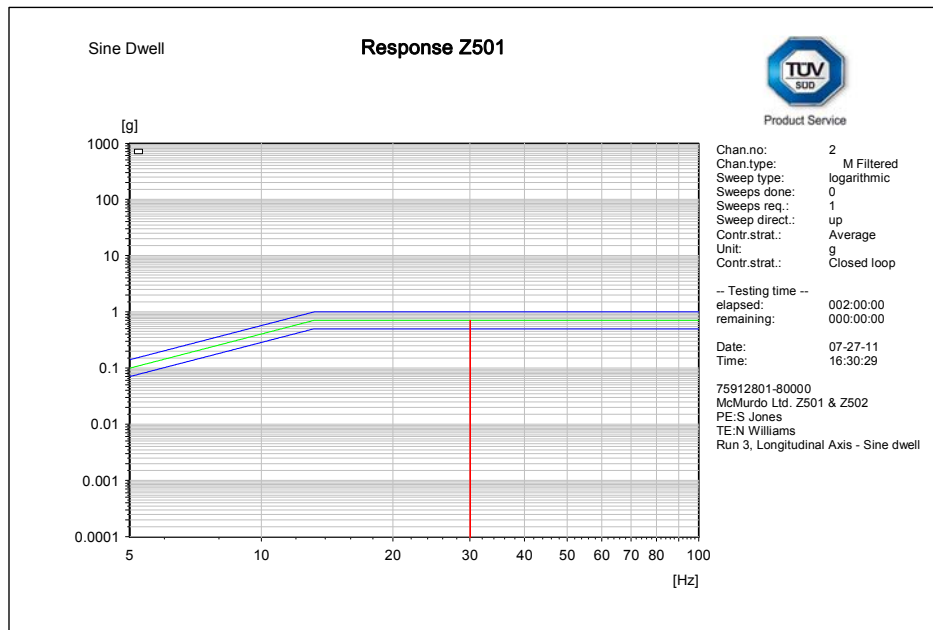

Longitudinal Axis – Z501 Endurance Run

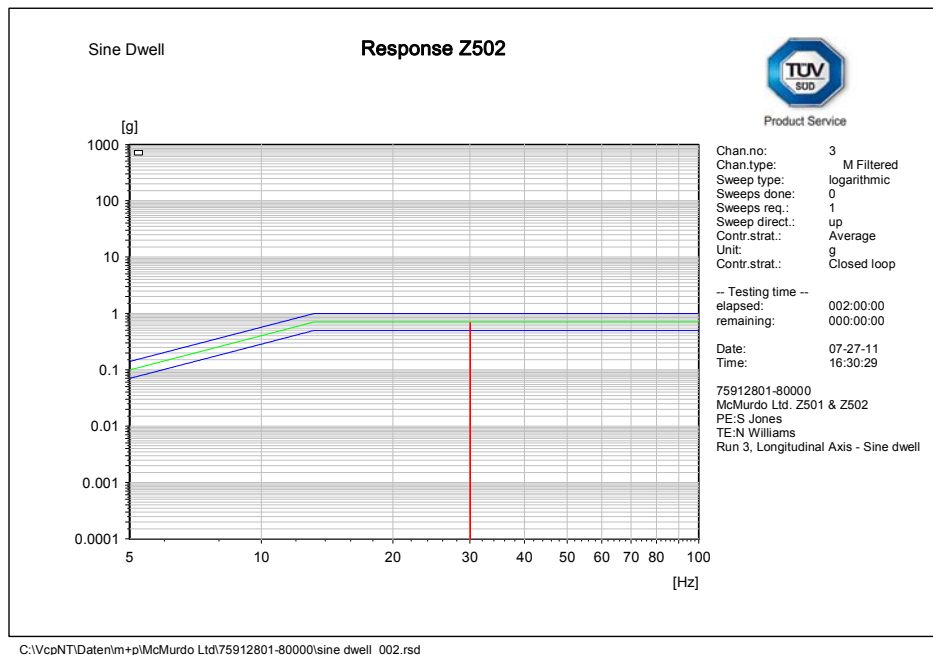

Longitudinal Axis – Z502 Endurance Run



Product Service

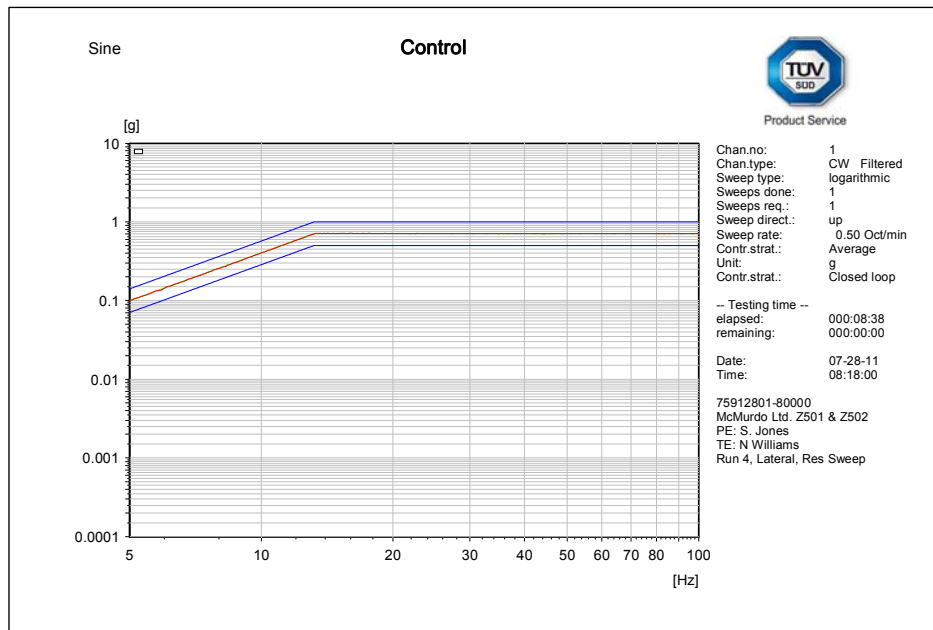

Lateral Axis – Resonance Search

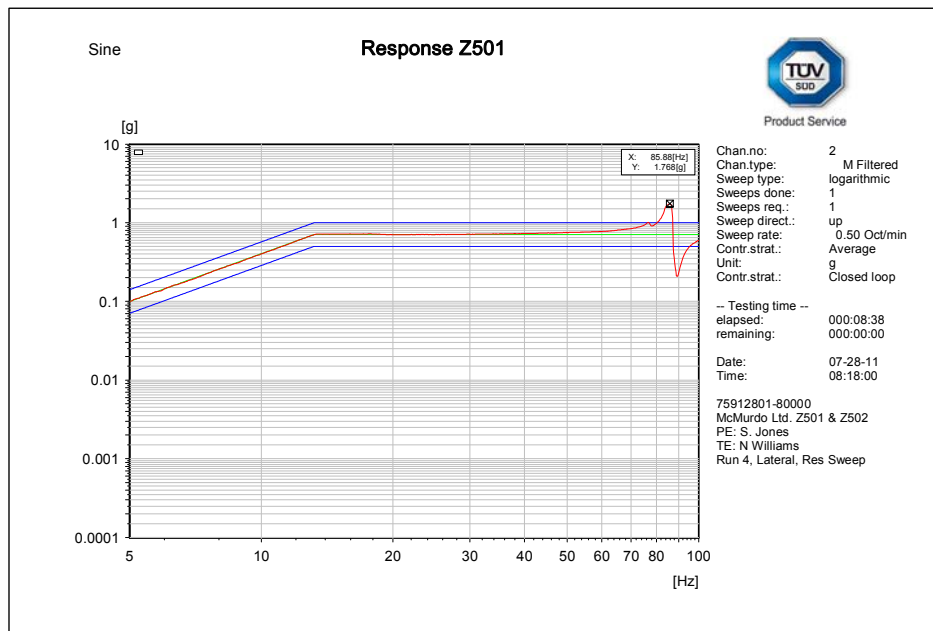

Lateral Axis – Resonance Search Z501 Response



Product Service

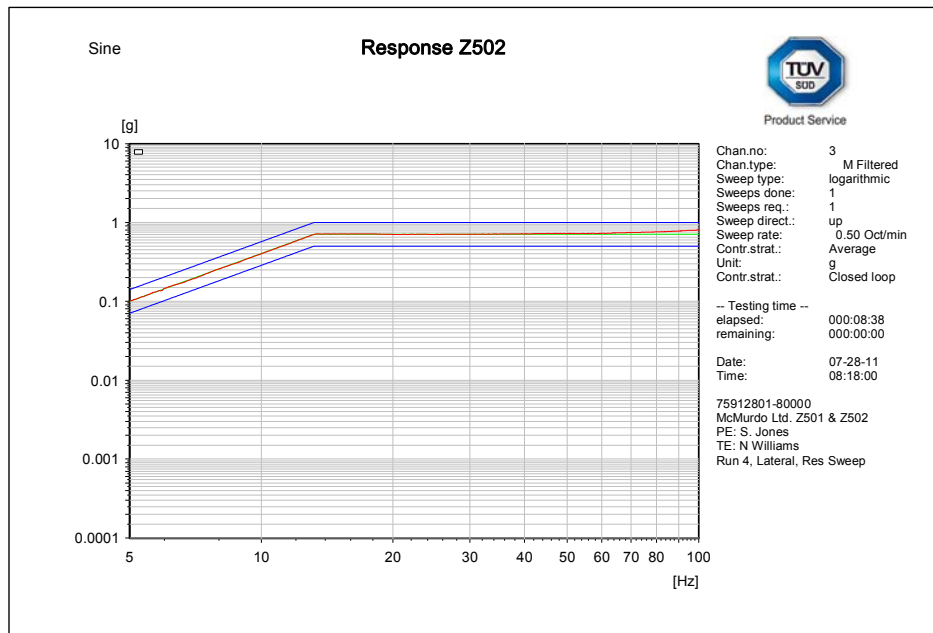

Lateral Axis – Resonance Search Z502 Response

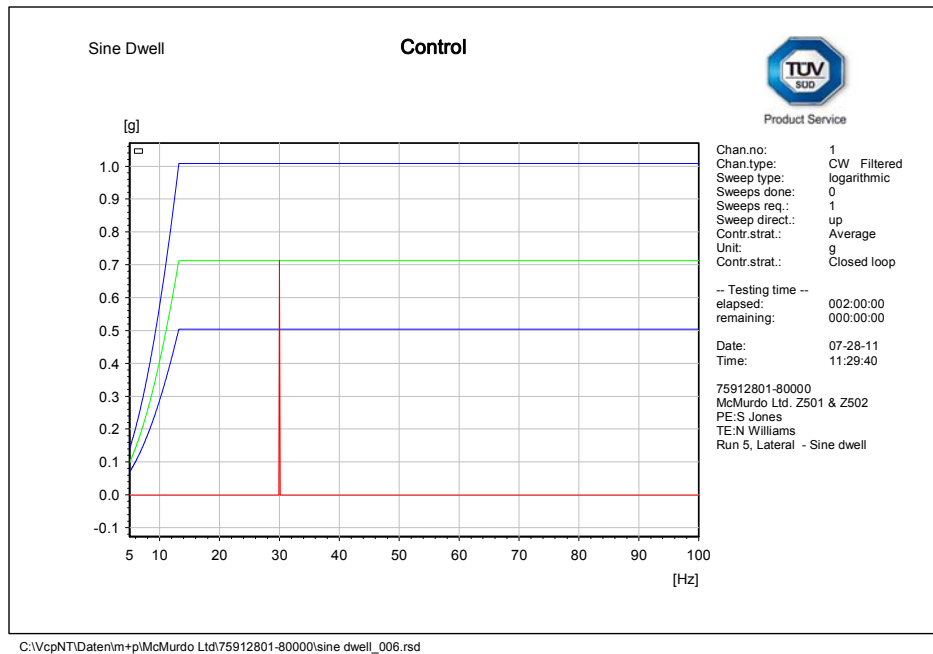

Lateral Axis – Endurance Test



Product Service



Lateral Axis – Z501 Endurance Test

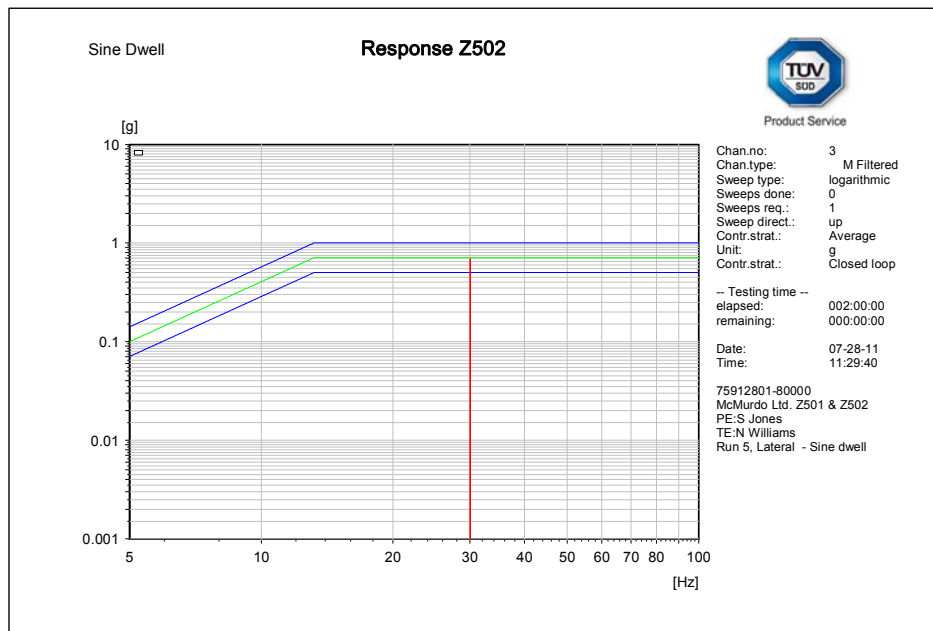

Lateral Axis – Z502 Endurance Test



Product Service

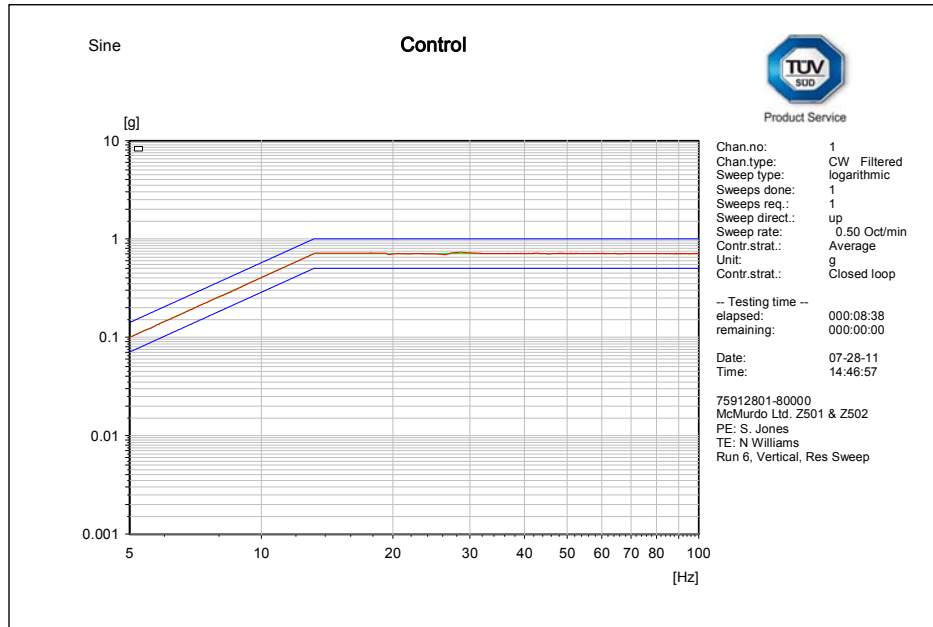

Vertical Axis – Resonance Search (Z501 only)

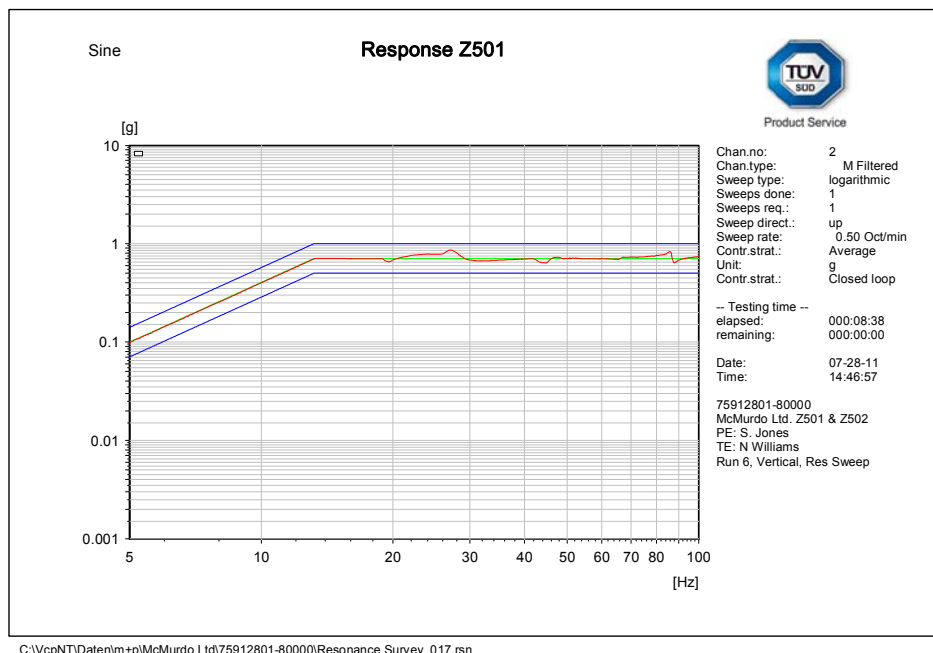

Vertical Axis – Z501 Resonance Search



Product Service

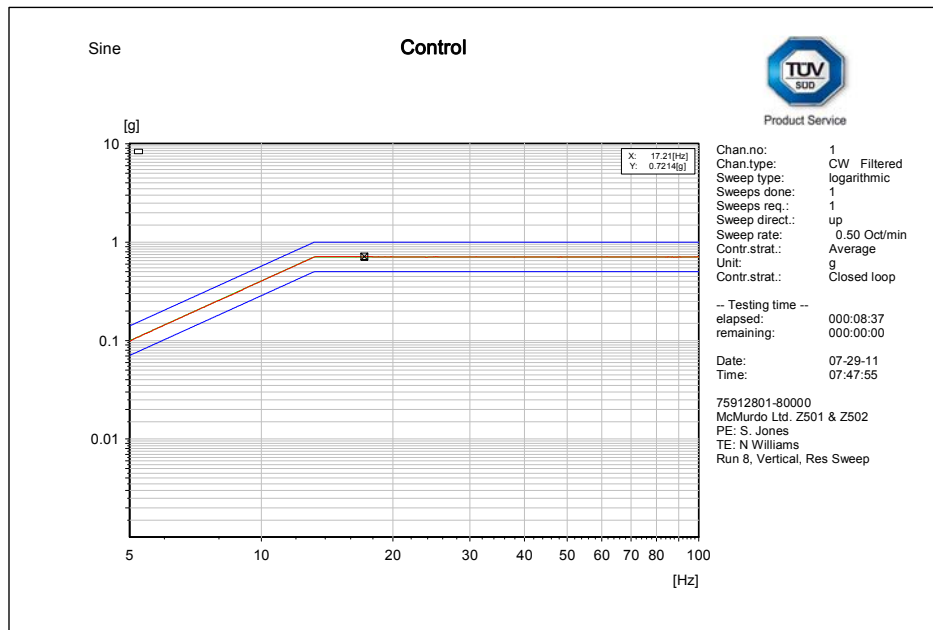

C:\VcpNT\Daten\m+p\McMurdo Ltd\75912801-80000\Resonance Survey_020.rsn

Vertical Axis – Resonance Search (Z502 only)

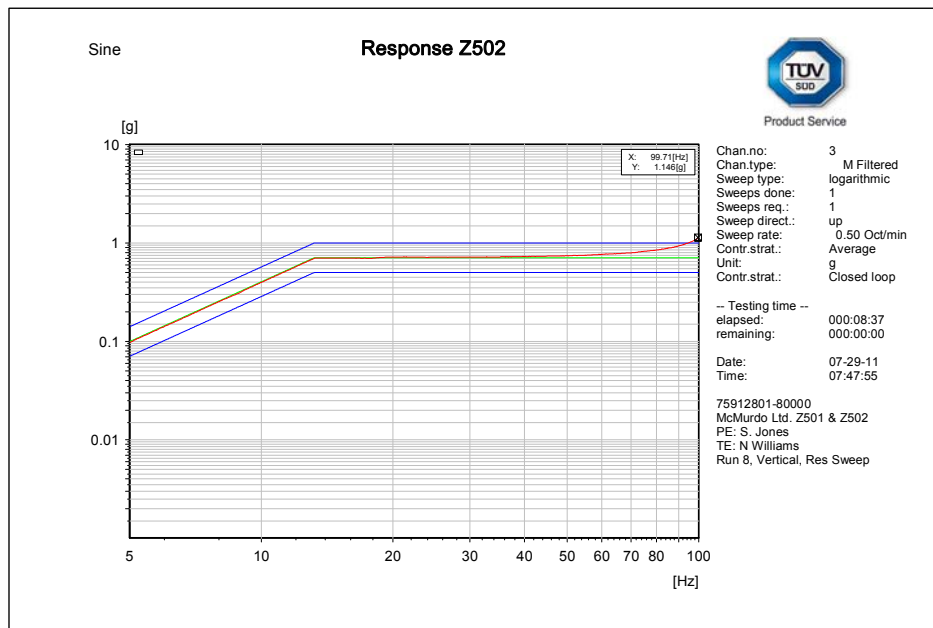

C:\VcpNT\Daten\m+p\McMurdo Ltd\75912801-80000\Resonance Survey_020.rsn

Vertical Axis – Z502 Resonance Search



Product Service

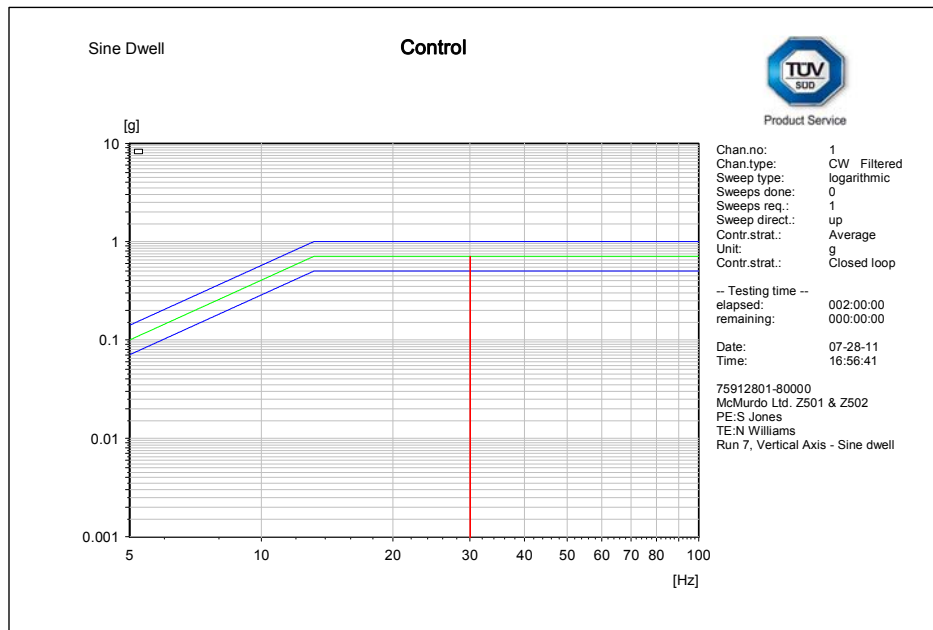

Vertical Axis – Endurance Test (Z501 only)

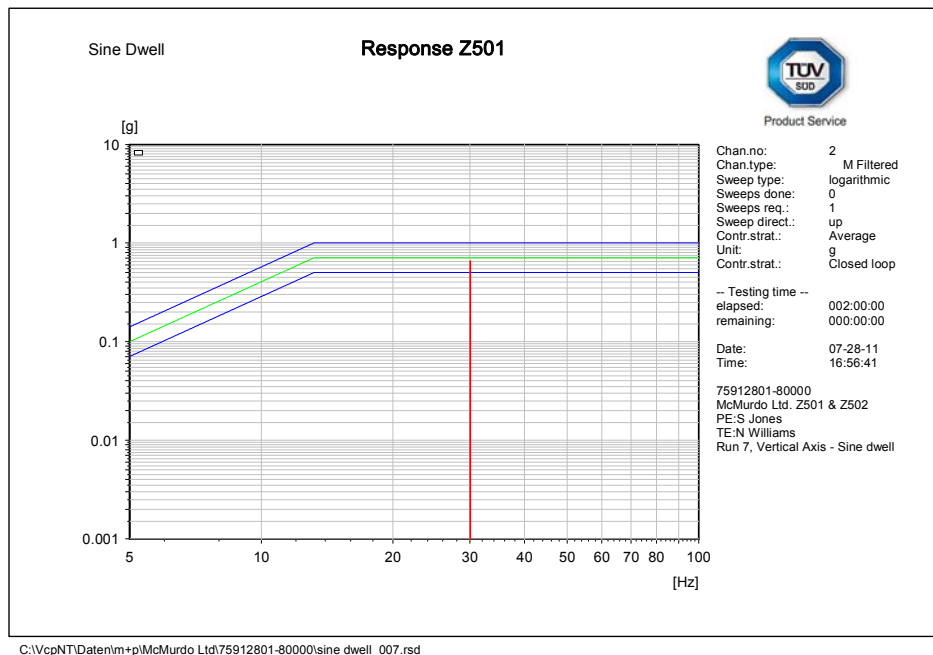

Vertical Axis – Z501 Endurance Test



Product Service

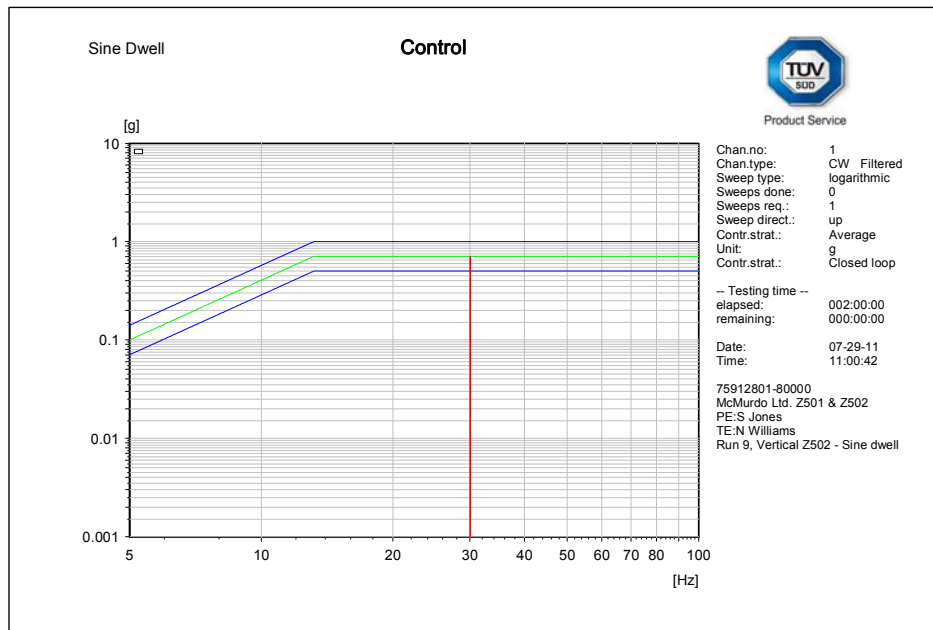

Vertical Axis – Endurance Test (Z502 only)

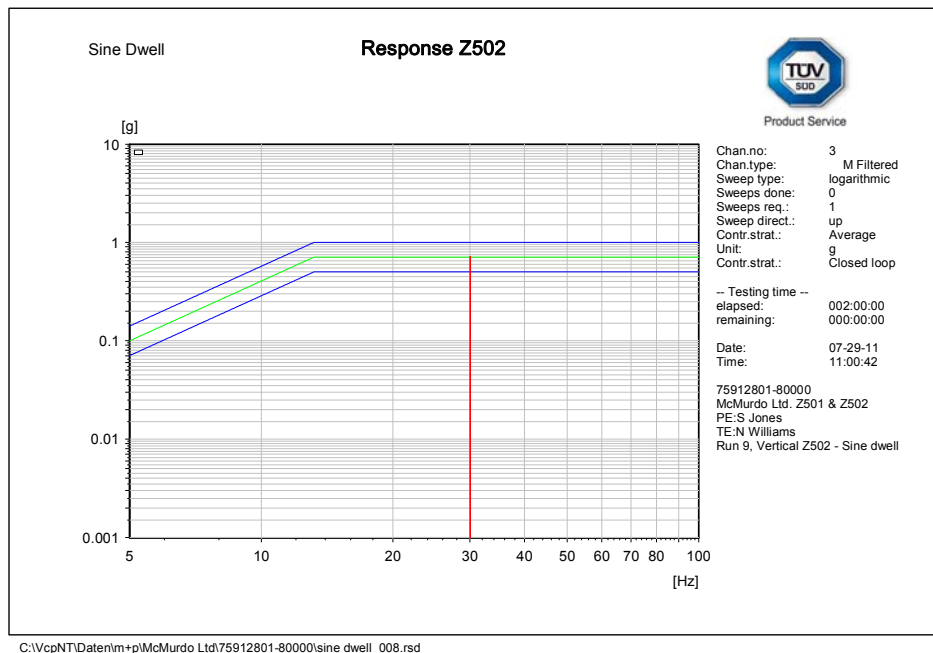

Vertical Axis – Z502 Endurance Test



Product Service

2.13 IMMERSION (Z501)

2.13.1 Specification Reference

RTCM Paper 219-2011-sc119-155 CDV – RTCM 11901.1, Clause 4.4
IEC 60945, Clause 8.9.2

2.13.2 Equipment Under Test

Z501: TUV ref: 75912801-TSR0011 (S/N 970120008)

2.13.3 Date of Test and Modification State

29 July 2011 - Modification State 0

2.13.4 Test Equipment Used

The major items of test equipment used for the above tests are identified in Section 3.1.

2.13.5 Test Procedure

The EUT was submerged in water in the over pressure vessel. The outer chamber was subjected to air overpressure; hence a hydraulic pressure of 100 kPa (1 bar, equivalent to 10m) was applied to the EUT for a period of 5 minutes. The EUT was weighed before and after the immersion and subjected to the performance check on completion of the test.

2.13.6 Test Set-up and Operating Modes

The test was performed with the EUT in the following mode(s): Idle.



Test Set-up – Z501 Immersion

2.13.7 Test Results

The test was completed successfully and no damage or derogation to the unit was observed

Z501 pre immersion test weight: 0.113kg.

Z501 post immersion weight: 0.114kg.

Following the test there were no visible external indication of damage or of unwanted ingress of water. The difference in weight before and after the test is considered negligible and could be attributed to water being absorbed in the lanyard and / or other crevices.

Performance Check

The performance check described in IEC 61097-14 was carried out; consisting of activating the EUT in self test mode with a GPS signal provided via a GPS simulator. Messages 1 and 14 were received by an AIS receiver.



Product Service

2.14 IMMERSION (Z502)

2.14.1 Specification Reference

RTCM Paper 219-2011-sc119-155 CDV – RTCM 11901.1, Clause 4.4
EN 60068-2-18: Method R c 2

2.14.2 Equipment Under Test

Z502: TUV ref: 75912801-TSR0012 (S/N 970120031)

2.14.3 Date of Test and Modification State

02 August 2011 - Modification State 0

2.14.4 Test Equipment Used

The major items of test equipment used for the above tests are identified in Section 3.1.

2.14.5 Test Procedure

The EUT was submerged in water in the over pressure vessel. Using a hydraulic pump the vessel pressure was increased to 5.88bar (g) (equivalent to 60m). The EUT remained under these conditions for a period of 2 hours. The EUT was weighed before and after the immersion and was subjected to the performance check on completion of the test.

2.14.6 Test Set-up and Operating Modes

The test was performed with the EUT in the following mode(s): Idle.

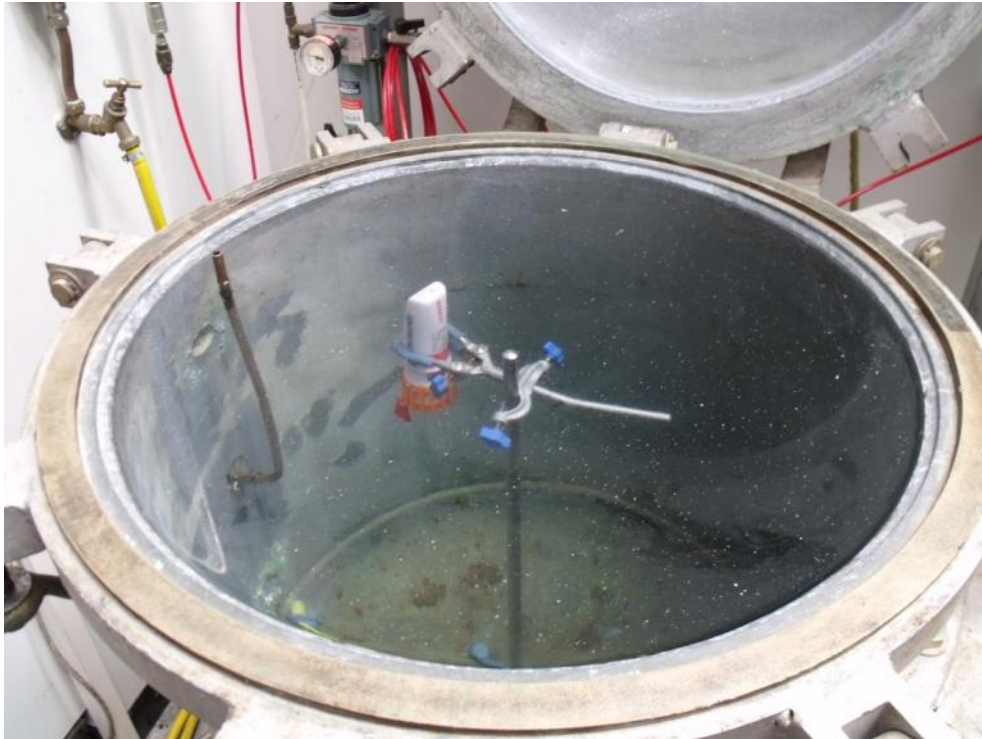

Test Set-up – Z502 Immersion

2.14.7 Test Results

The test was completed successfully and no damage or derogation to the unit was observed

Z502 pre immersion test weight: 0.175kg.

Z502 post immersion weight: 0.175kg.

Following the test there were no visible external indication of damage or of unwanted ingress of water. There was no difference in weight before and after the test suggesting that there was no unwanted ingress of water.

Performance Check

The performance check described in IEC 61097-14 was carried out; consisting of activating the EUT in self test mode with a GPS signal provided via a GPS simulator. Messages 1 and 14 were received by an AIS receiver.



Product Service

2.15 SOLAR RADIATION

2.15.1 Specification Reference

RTCM Paper 219-2011-sc119-155 CDV – RTCM 11901.1, Clause 4.4
IEC 60945, Clause 8.10

2.15.2 Waiver Request

Refer to Annex A for manufacturer's materials declaration.



Product Service

2.16 OIL RESISTANCE

2.16.1 Specification Reference

RTCM Paper 219-2011-sc119-155 CDV – RTCM 11901.1, Clause 4.4
IEC 60945, Clause 8.11

2.16.2 Waiver Request

Refer to Annex A for manufacturer's materials declaration.



Product Service

2.17 CORROSION

2.17.1 Specification Reference

RTCM Paper 219-2011-sc119-155 CDV – RTCM 11901.1, Clause 4.4
IEC 60945, Clause 8.12

2.17.2 Waiver Request

Refer to Annex A for manufacturer's materials declaration.



Product Service

2.18 CONSTRUCTION REQUIREMENTS

2.18.1 Specification Reference

RTCM Paper 219-2011-sc119-155 CDV – RTCM 11901.1, Clause 5

2.18.2 Equipment Under Test

Z500 Family (Z501), S/N: 970000009
Z500 Family (Z502), S/N: 970000032

2.18.3 Date of Test and Modification State

30 January 2012 - Modification State 0

2.18.4 Test Equipment Used

The major items of test equipment used for the above tests are identified in Section 3.1.



Product Service

2.18.5 Test Results

The EUTs were physically inspected for the various clauses and documented below.

5.1: The AU should be wearable, or arranged to be attached to the user's clothing or personal floatation device without interfering with the user's activities. The AU should be provided with adequate means of attachment to the user in its "operational" position. The AU should be designed for "hands free" operation, so that the user is not required to hold the unit out of the water for operation after activation. The external design of the AU should avoid sharp edges or points to prevent injury or damage to equipment.

Z501 Observation Outcome

The manufacturer declared that the Z501 is designed to be installed in a lifejacket, when installed correctly the Z501 is hidden within the lifejacket and does not therefore interfere with the user's activities. As the Z501 is designed to be installed in the lifejacket the activation of the device is automatic and as such the user is not required to hold the unit thus making it "hands free". When mounted on the lifejacket, the Z501 is mounted on the front of the lifejacket; assuming the lifejacket is self righting the Z501 will not be required to be held out of the water for operation after activation.

The Z501 was inspected for rough edges with the Sharp Edge Tester, consisting of a 'repeatable-force arm' and a padded 'finger' covered with tape, was run along all edges of the Z501.

Upon inspection of the tape covering the 'finger' no cuts were found, merely creases.

Z502 Observation Outcome

The Z502 is supplied with a lanyard and or belt / arm pouch to ease the handling of the device.

The Z502 is designed to be held out of the water for operation after activation, McMurdo Limited have advised that a strap is provided with the unit which allows the user to fix the unit to their head to provide hands free operation.

The Z502 was inspected for rough edges. All surfaces are smooth with no pointed edges with the exception of the "Pull to Release" pin.

McMurdo Limited have indicated that the "Pull to Release" pin is supplied with the end protected with a plastic coating. Furthermore a neoprene pouch is supplied as standard which covers this pin.

5.2: The AU shall have its own battery or batteries and should not depend upon any external source of power for its operation when activated. The batteries shall be an integral part of the equipment.

Z501 and Z502 Observation Outcome

Both the Z501 and Z502 are equipped with integral battery packs. The integral battery packs supply the only power source to the devices.



Product Service

5.2.1: The AU shall not be hazardous to personnel handling it, operating it, or performing manufacturer-approved servicing of it nor shall it release toxic or corrosive products outside the AU case.

Z501 and Z502 Observation Outcome

Refer to Manufacturers documentation.

5.2.2: The Manufacturer should establish a useful life and expiration date for primary batteries... The battery replacement date marked on the AU should be the date of the battery installation in the AU plus no more than 50% of the rated life of the battery, provided that the battery cells are no older than 25% of the rated life of the battery.

Z501 and Z502 Observation Outcome

Refer to Manufacturers documentation for useful life and expiration data.

The Z501 and Z502 share common battery packs. The units can be shipped with either a Panasonic cell or Varta cell battery pack. The labels are similar for both types of battery packs. The replacement date of the battery packs is detailed in the Manufacturers documentation for useful life and expiration data document.

5.2.3: Replacement of the battery, if user-replaceable, should be possible with relative ease...

Z501 and Z502 Observation Outcome

The battery packs for both the Z501 and Z502 are not intended to be user-replaceable. The manuals of both devices state that the device should be returned to the service centre for battery replacement if the battery level is low.

5.3.1: The MSLD documentation should include instructions on AU battery replacement intervals. All batteries in the AU should use polarized connectors or wires to battery connectors uniquely colour coded. The wire to the most positive (+) terminal should be RED; the wire to the most negative (-) terminal should be BLACK...

Z501 Observation Outcome

The manual for the Z501 indicates that the battery offers 24 hours operation and 7 years storage. Users are advised to check that the battery expiry date shown is in date for the duration of its intended use.

The connectors between the battery pack and PCB are polarized.



Product Service

Z502 Observation Outcome

The manual for the Z502 indicates that the battery offers 24 hours operation and 5 years storage. Users are advised to check that the battery expiry date shown is in date for the duration of its intended use.

The connectors between the battery pack and PCB are polarized.

5.3.2: All labelling on the exterior of the AU shall be resistant to deterioration by prolonged exposure to sunlight, and shall not be unduly affected by seawater or oil, and shall be abrasion resistant.

Z501 and Z502 Observation Outcome

The Manufacturer has provided waivers for both the Z501 and Z502 for the Solar Radiation, Corrosion and Oil Resistance tests – refer to Annex A for manufacturer's materials declaration.

5.3.2: The outside of the AU shall be marked indelibly and legibly with the following:

a) Concise markings for operating controls... including how to turn the AU on and how to clear an alarm.

Z501 and Z502 Observation Outcome

Brief operating and test instruction (in English) are provided on the body of the Z501 and Z502 indicating how to activate the unit and how to switch off. Labels were provided which are to be positioned on the devices; these labels contain fields for the serial number (unique ID) and battery expiry date.

In addition the identification of the manufacturer, equipment type number or model identification under which it was type tested, serial number and the requirements for the compass safe distance were all identified on the main body of both the Z501 and Z502.

b) Self test instructions.

Z501 and Z502 Observation Outcome

A self test function is provided so that the unit can be tested periodically on both the Z501 and Z502.

c) The name and address of the manufacturer.

Z501 and Z502 Observation Outcome

The Manufacturers name and web address can be found on the Z501 and Z501 labels. The specific address details are not displayed on either label.



Product Service

d) The AU type number of model identification under which it was type tested.

Z501 and Z502 Observation Outcome

The labels which are affixed to the Z501 and Z502 both contain the model identification under which it was type tested: R10 and S10 respectively.

e) The serial number or identification number of the AU.

Z501 and Z502 Observation Outcome

Each test sample provided by McMurdo Limited was coded with a unique ID. McMurdo Limited have advised that the end user is not able to change this ID. The ID information is contained within a label affixed to the unit by the manufacturer.

Each unique identifier seen was of the correct format (9 digits) as specified in IEC 61097-14, starting 970XXXXXX. McMurdo Limited have advised that units intended for the North American market will be coded as specified in RTCM 11901.1, i.e. 972xyyyy, where xx = manufacturer ID (in this case 11 McMurdo); yyyy the sequence number.

f) Battery safety warning and disposal statement, if applicable.

Z501 and Z502 Observation Outcome

Both the Z501 and Z502 contain integrated lithium battery packs. The Manufacturer indicates in the user manual that the units are not user-serviceable. Furthermore the user is directed to return the unit to the service centre to have the battery pack changed. Therefore, disposal statements are not applicable.

g) Storage and operating temperature range of the AU.

Z501 and Z502 Observation Outcome

The storage and operating temperature range can be found on both the Z501 and Z502. The storage and operating temperature can also be found in both user manuals.

h) Regulatory authority markings, if required.

Z501 and Z502 Observation Outcome

The FCC ID and CE mark can be found on both the Z501 and Z502 labels.

i) Compass safe distance.

Z501 and Z502 Observation Outcome

The compass safe distance of 0.3m is identified on the Z501 and 0.6m on the Z502.



Product Service

j) Warning to only activate device in an emergency.

Z501 and Z502 Observation Outcome

Both the Z501 and Z502 include the following text “Use only in emergency”.

k) If a GNSS receiver is included, a warning to not block the antenna.

Z501 and Z502 Observation Outcome

The Z501 and Z502 both include the statement “DO NOT OBSTRUCT” where the GNSS receiver is located.



Product Service

2.19 OPTIONAL PERFORMANCE FEATURES

2.19.1 Specification Reference

RTCM Paper 219-2011-sc119-155 CDV – RTCM 11901.1, Clause 6

The Z501 and Z502 do not support any optional performance features.



Product Service

2.20 DOCUMENTATION

2.20.1 Specification Reference

RTCM Paper 219-2011-sc119-155 CDV – RTCM 11901.1, Clause 7

2.20.2 Equipment Under Test

Not Applicable

2.20.3 Date of Test and Modification State

30 January 2012 - Modification State 0

2.20.4 Test Equipment Used

The major items of test equipment used for the above tests are identified in Section 3.1.



2.20.5 Operational Clauses

Z501 Observation Outcomes

Clause	Test Description	Result	Comments
7.0	The manufacturer shall provide an operation manual including the following:		
a	Intended use of the MSLD system	Satisfactory	<p>"...a personal portable AIS device. Lightweight and compact, it is designed to be carried by all crewmembers and can be mounted on a lifejacket. When triggered, the R10 SRS [Z501] transmits GPS position information to all AIS-equipped vessels and stations within range to assist fast recovery in distress situations."</p> <p>The unit can also be operated manually – pictograms are provided indicating this activation method.</p>
b	Complete instructions for testing and operating the MSLD system.	Satisfactory	<p>"It is recommended that the Short Test is performed monthly...."</p> <p>Instructions for both a Long and Short Test are provided with pictorial references.</p>
c	Information explaining the BU and LF system	Satisfactory	<p>There is no Base Unit (BU) supplied with the device. The Z501 when activated will transmit GPS position information to all AIS-equipped vessels within range. The Z501 "also features an ultra-bright LED beacon and buzzer": these features act as the Locating Function (LF).</p>
d	Cautions and recommendations to prevent false alarms	Satisfactory	<p>"Caution: DO NOT ACTIVATE EXCEPT IN AN EMERGENCY. This device is designed for use with an AIS receiver and is not a substitute for a PLB or EPIRB. This beacon is intended for use within the maritime environmental where permitted by national administrations. When activated, it transmits a digital alert message to any vessel or shore station in radio range which is equipped with an AIS receiver. Deliberate misuse of the device could result in a penalty."</p>
e	General battery information	Satisfactory	<p>"The lithium power cell offers a minimum 24hr continuous operation and a 7 year battery storage life... Confirm that the battery expiry date shown is in date for the duration of intended use... This product contains small lithium metal batteries." Battery type, life (storage) and transmit duration are also provided.</p>
f	Information on when battery replacement is required	Satisfactory	<p>"It is recommended that the Short Test is performed monthly. Return the R10 [Z501] to a service centre for battery replacement if battery level is low." The Short Test includes a battery life test (indicated pictorially), where one flash indicates a low battery.</p>
g	Information related to the requirements of preventive maintenance	Satisfactory	<p>"Avoid cleaning the unit with chemical solvents as this may damage the case material"</p>
h	Minimum operating life time, operating, and stowage temperature ranges	Satisfactory	<p>"The lithium power cell offers a minimum 24hr continuous operation and a 7 year battery storage life..." The operating and stowage temperature ranges are also provided.</p>
i	Information explaining the requirement and procedure for licensing and registering MSLDs, as appropriate	Satisfactory	<p>"Use of this equipment requires a user licence, it may be operated in the following EC countries:...This product is a radio transmitter. Some administrations may require that the</p>



			<p>user holds a valid radio license to cover its ownership and use.”</p> <p>McMurdo have advised that it is not necessary to register the device.</p>
j	Information relating to the shipment of the MSLD	Satisfactory	<p>“Transportation</p> <ul style="list-style-type: none"> • Product contains small lithium metal batteries. • Passenger aircraft: Product can normally be carried on passenger aircraft in carry-on baggage as a personal item. It is recommended that you declare the device to airline staff at check-in, in the same way you would a laptop PC or video camera. • Air cargo: Not restricted as air cargo under IATA code UN3091–P1970. Always check with carrier for additional restrictions.”
k	Instructions on actions to be taken in case of false alarms	Satisfactory	<p>“False Alarm: If the unit has been accidentally activated contact the coastguard”</p>
l	If a 121.5MHz signal is transmitted during the self-test	N/A	<p>The Z501 does not include a 121.5MHz transmitter.</p>
m	A warning to the effect that the device should only be activated in an emergency	Satisfactory	<p>“Caution: DO NOT ACTIVATE EXCEPT IN AN EMERGENCY“</p>
n	Instructions for fitting / attaching the AU to the user and for correct operation in the water in an emergency	Satisfactory	<p>The Z501 can be mounted on a lifejacket. “If lifejacket mounted, ensure the R10 remains on a part which stays out of the water, as direct contact to the sea will severely reduce the transmission range... Ensure that the blue area marked “GPS Zone” is not obstructed or covered in any way and always has a clear view of the sky.”</p> <p>Pictograms are supplied indicating how the Z501 can be attached to a lifejacket webbing.</p>
o	Instructions for BU installation, testing, use and maintenance	N/A	<p>The Z501 and Z502 are Alerting Units (AU) rather than Base Units (BU)</p>



Z502 Observation Outcomes

Clause	Test Description	Result	Comments
7.0	The manufacturer shall provide an operation manual including the following:		
a	Intended use of the MSLD system	Satisfactory	"...an innovative manually activated personal portable safety device which incorporates both AIS... and GPS technology. It is designed to aid the speed recovery of personnel / crew member who find themselves in difficulty at sea."
b	Complete instructions for testing and operating the MSLD system.	Satisfactory	"Note that is it necessary to remove the S10 [Z502] from the pouch all the time it is in operation... It is recommended that the Short Test is performed monthly..." Instructions for both a Long and Short Test are provided with pictorial references.
c	Information explaining the BU and LF system	Satisfactory	There is no Base Unit (BU) supplied with the device. The Z502 when activated will transmit GPS position information to all AIS-equipped vessels within range. The Z502 "also features a flashing LED light": thid feature act as the Locating Function (LF).
d	Cautions and recommendations to prevent false alarms	Satisfactory	"Caution: DO NOT ACTIVATE EXCEPT IN AN EMERGENCY. This device is designed for use with an AIS receiver and is not a substitute for a PLB or EPIRB. This beacon is intended for use within the maritime environmental where permitted by national administrations. When activated, it transmits a digital alert message to any vessel or shore station in radio range which is equipped with an AIS receiver. Deliberate misuse of the device could result in a penalty."
e	General battery information	Satisfactory	"The lithium power cell offers a minimum 24hr continuous operation and a 5 year battery storage life... Confirm that the battery expiry date shown is in date for the duration of intended use... Contains small lithium." Battery type, life (storage) and transmit duration are also provided.
f	Information on when battery replacement is required	Satisfactory	"It is recommended that the Short Test is performed monthly. Return the S10 [Z502] to a service centre for battery replacement if battery level is low." The Short Test includes a battery life test (indicated pictorially), where one flash indicates a low battery.
g	Information related to the requirements of preventive maintenance	Satisfactory	"Avoid cleaning the unit with chemical solvents as this may damage the case material"
h	Minimum operating life time, operating, and stowage temperature ranges	Satisfactory	"The lithium power cell offers a minimum 24hr continuous operation and a 5 year battery storage life..." The operating and stowage temperature ranges are also provided.
i	Information explaining the requirement and procedure for licensing and registering MSLDs, as appropriate	Satisfactory	"Use of this equipment requires a user licence, it may be operated in the following EC countries:...This product is a radio transmitter. Some administrations may require that the user holds a valid radio license to cover its ownership and use." McMurdo have advised that it is not necessary to register the device.
j	Information relating to the shipment of the MSLD	Satisfactory	"Transportation • Product contains small lithium metal batteries.



Product Service

			<ul style="list-style-type: none"> • Passenger aircraft: Product can normally be carried on passenger aircraft in carry-on baggage as a personal item. It is recommended that you declare the device to airline staff at check-in, in the same way you would a laptop PC or video camera. • Air cargo: Not restricted as air cargo under IATA code UN3091–PI970. Always check with carrier for additional restrictions.”
k	Instructions on actions to be taken in case of false alarms	Satisfactory	“False Alarm: If the unit has been accidentally activated contact the coastguard”
l	If a 121.5MHz signal is transmitted during the self-test	N/A	The Z502 does not include a 121.5MHz transmitter.
m	A warning to the effect that the device should only be activated in an emergency	Satisfactory	“Caution: DO NOT ACTIVATE EXCEPT IN AN EMERGENCY”
n	Instructions for fitting / attaching the AU to the user and for correct operation in the water in an emergency	Satisfactory	<p>Deployment Options</p> <ol style="list-style-type: none"> 1. Lanyard 2. Belt or Arm Pouch <p>The belt or arm pouch includes a belt loop and removable velcro arm strap. Note that it is necessary to remove the S10 [Z502] from the pouch all the time it is in operation. It is important that the unit is returned to the holster when not in use.</p> <p>The S10 is buoyant but must be kept in physical contact with you when activated as your body forms part of the antenna. The S10 must always be kept above water when activated, as direct contact with the sea will severely reduce the transmission range. For optimum transmission, the S10 must be held upright when activated. Ensure that the red area marked “GPS Zone” is not obstructed or covered in any way and always has a clear view of the sky.</p>
o	Instructions for BU installation, testing, use and maintenance	N/A	The Z501 and Z502 are Alerting Units (AU) rather than Base Units (BU)



Product Service

2.21 PERFORMANCE TESTS – BUOYANCY

2.21.1 Specification Reference

RTCM Paper 219-2011-sc119-155 CDV – RTCM 11901.1, Clause 8.1.3 (Buoyancy test)

See section 2.3.5



Product Service

2.22 PERFORMANCE TESTS – IMMERSION SUIT GLOVE

2.22.1 Specification Reference

RTCM Paper 219-2011-sc119-155 CDV – RTCM 11901.1, Clause 8.1.4.1 (Controls and Indicators Tests – Function) – Gloved hand test

2.22.2 Equipment Under Test

Z500 Family (Z501), S/N: 970000009
Z500 Family (Z502), S/N: 970000032

2.22.3 Date of Test and Modification State

12 January 2012 - Modification State 0

2.22.4 Test Equipment Used

The major items of test equipment used for the above tests are identified in Section 3.1.

2.22.5 Test Procedure

Whilst wearing an immersion suit glove activation of both the Z501 and Z502 was attempted.

2.22.6 Test Results

Both the Z501 and Z502 were successfully activated whilst wearing an immersion suit glove.



Product Service

2.23 PERFORMANCE TESTS – CONTROLS DURABILITY

2.23.1 Specification Reference

RTCM Paper 219-2011-sc119-155 CDV – RTCM 11901.1, Clause 8.1.4.2 (Controls Durability)

2.23.2 Manufacturers Declaration

Refer to Annex A for manufacturer's declaration.



Product Service

2.24 PERFORMANCE TESTS – WATER ACTIVATION TEST (Z501 ONLY)

2.24.1 Specification Reference

RTCM Paper 219-2011-sc119-155 CDV – RTCM 11901.1, Clause 8.1.5.1 (Water Activation Test (for automatically-activated types only))

2.24.2 Equipment Under Test

Z500 Family (Z501), S/N: 970000009

2.24.3 Date of Test and Modification State

5 December 2011 - Modification State 0

2.24.4 Test Equipment Used

The major items of test equipment used for the above tests are identified in Section 3.1.

2.24.5 Test Procedure

The EUT was installed in a lifejacket and was submerged in a 0.1% salt solution. .

2.24.6 Test Set-up and Operating Modes

The test was performed with the EUT in the following mode(s): Idle.



Test Set-up – Z501 Water Activation

2.24.7 Test Results

The lifejacket inflated immediately and the EUT activated. The Z501 was identified by a Class A AIS receiver.



Product Service

2.25 PERFORMANCE TESTS – RAIN/SPRAY NON-ACTIVATION TEST

2.25.1 Specification Reference

RTCM Paper 219-2011-sc119-155 CDV – RTCM 11901.1, Clause 8.1.5.2 (Rain/spray non-activation test)

2.25.2 Equipment Under Test

Z500 Family (Z501), S/N: 970000009
Z500 Family (Z502), S/N: 970000032

2.25.3 Date of Test and Modification State

01 December 2011 - Modification State 0

2.25.4 Test Equipment Used

The major items of test equipment used for the above tests are identified in Section 3.1.

2.25.5 Test Procedure

The Z501 was fitted to the lifejacket.

The Z502 was tested standalone.

Both EUTs were positioned in a chamber and preconditioned at +20°C for 3 hours and 20 minutes. The EUTs were removed from the chamber and positioned in the rain test facility. A pump, immersed in salt solution (3.5% by weight) was calibrated to provide a flow of 10 litre / minute. The EUTs were subject to a total of 10 minutes of salt water spray.

2.25.6 Test Set-up and Operating Modes

The test was performed with the EUT in the following mode(s): Idle.



Test Set-up – Rain/Spray Non-Activation (Z501 installed in lifejacket and Z502 standalone)

2.25.7 Test Results

Neither the Z501 or Z502 activated.



Product Service

2.26 PERFORMANCE TESTS – SELF TEST MODE

2.26.1 Specification Reference

RTCM Paper 219-2011-sc119-155 CDV – RTCM 11901.1, Clause 8.1.6 (Test of the Self-Test mode)

2.26.2 Equipment Under Test

Z500 Family (Z501), S/N: 97000009
Z500 Family (Z502), S/N: 97000032

2.26.3 Date of Test and Modification State

12 January 2012 - Modification State 0

2.26.4 Test Equipment Used

The major items of test equipment used for the above tests are identified in Section 3.1.

2.26.5 Test Procedure

The unites were placed inside an environmental chamber and allowed to attain thermal balance for a period of at least 2 hours. The self test was then performed with and without the presence of GPS data.

2.26.6 Test Results

The Z501 and Z502 operated in accordance with the manuals for both short and long self test features.



Product Service

2.27 PERFORMANCE TESTS – BATTERY CAPACITY TEST

2.27.1 Specification Reference

RTCM Paper 219-2011-sc119-155 CDV – RTCM 11901.1, Clause 8.1.7 (Battery Capacity Test)

See section 2.32 (as per Annex E.6.5)



Product Service

2.28 PERFORMANCE TESTS – SPURIOUS AND OUT-OF-BAND EMISSIONS

2.28.1 Specification Reference

RTCM Paper 219-2011-sc119-155 CDV – RTCM 11901.1, Clause 8.1.8 (Spurious and out-of-band emissions)

2.28.2 Equipment Under Test

Z500 Family (Z501), S/N: 970000009
Z500 Family (Z502), S/N: 970000032

2.28.3 Date of Test and Modification State

25 January 2012 – 26 January 2012 - Modification State 0

2.28.4 Test Equipment Used

The major items of test equipment used for the above tests are identified in Section 3.1.

2.28.5 Test Procedure

For all tests the EUT was set up in accordance with the relevant test standard and to represent typical operating conditions. Tests were applied with the EUT situated in a shielded enclosure, test laboratories or an open test area as appropriate.

The EUTs were powered from a internal battery pack.

The EUTs were configured so that they transmitted into a dummy load.

2.28.6 Test Set-up and Operating Modes

The test was performed with the EUT in the following mode(s): Transmit.



Test Set-up – Z501 Magnetic Emissions

2.28.7 Test Results

For the period of test the EUT met the requirements of IEC 60945 for Enclosure Port Magnetic Emissions - Field Strength.

The test results are shown below.



Z501 – H Field Measurements

Note for plots:

The data depicted on the following graphical results (Red Line) is a record of the preliminary pre-scan emissions detected from the EUT using a Peak detector.

The highest peak emissions are then re-measured using the appropriate quasi-peak detector, with these results then compared against the appropriate limit line. These final Emissions are displayed graphically as markers on the graph and numerically within the results table.

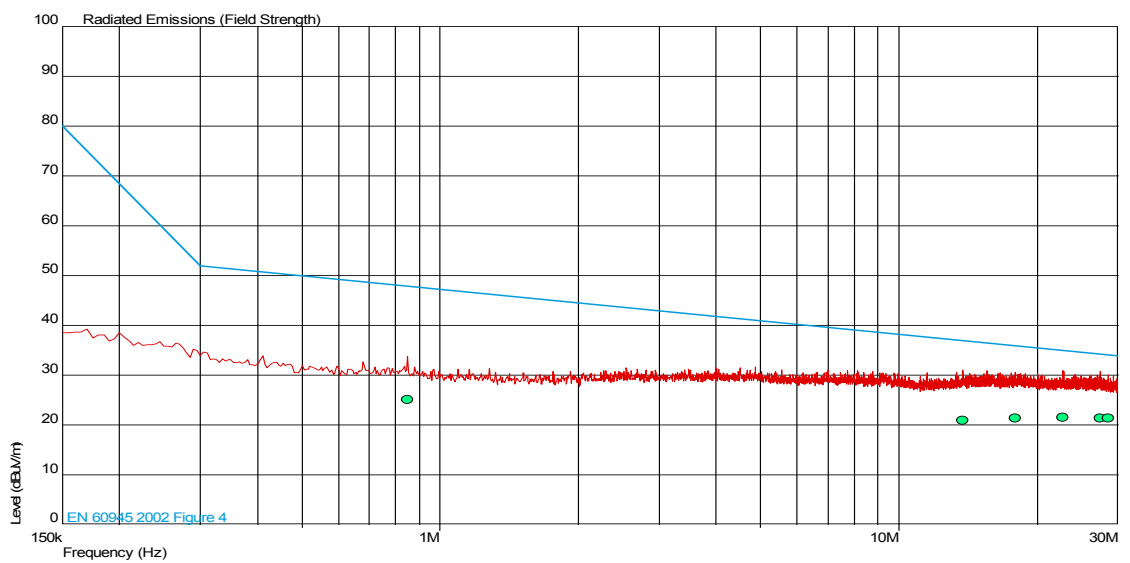

Frequency (MHz)	QP Level (dBµV/m)	QP Limit (dBµV/m)	QP Margin (dBµV/m)	Angle(Deg)	Height(m)	Polarity
0.850	25.1	47.9	-22.8	47	1.00	Horizontal
13.752	20.9	37.0	-16.1	360	1.00	Vertical
17.929	21.4	36.0	-14.6	290	1.00	Vertical
22.747	21.6	35.1	-13.5	90	1.00	Vertical
27.426	21.4	34.4	-12.9	360	1.00	Vertical
28.597	21.4	34.2	-12.8	96	1.00	Vertical



Product Service

Z502 – H Field Measurements

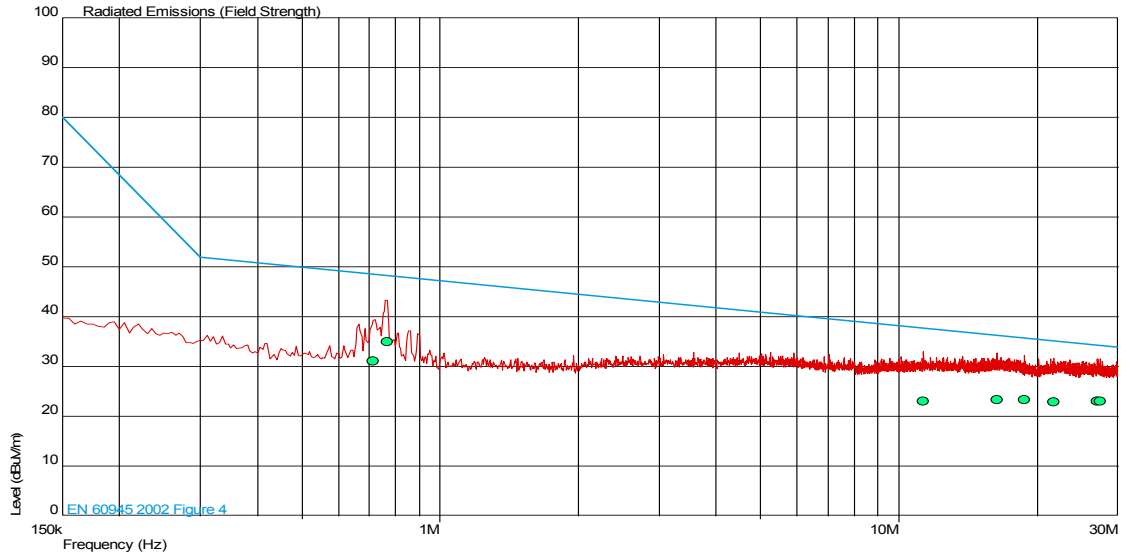

Frequency (MHz)	QP Level (dBµV/m)	QP Limit (dBµV/m)	QP Margin (dBµV/m)	Angle(Deg)	Height(m)	Polarity
0.714	31.2	48.6	-17.4	224	1.00	Vertical
0.765	35.0	48.3	-13.3	164	1.00	Horizontal
11.320	23.1	37.8	-14.7	317	1.00	Vertical
16.340	23.4	36.4	-13.0	11	1.00	Vertical
18.740	23.4	35.8	-12.4	154	1.00	Vertical
21.706	22.9	35.3	-12.4	58	1.00	Vertical
26.991	23.1	34.4	-11.3	47	1.00	Vertical
27.446	23.1	34.3	-11.3	360	1.00	Vertical

For the period of test the EUT met the requirements of IEC 60945 for Radiated Emissions (Enclosure Port).

The test results are shown below.



Z501 – E Field Measurements

Note for plots:

The data depicted on the following graphical results (Red Line) is a record of the preliminary pre-scan emissions detected from the EUT using a Peak detector; some peak emissions will exceed the quasi-peak limit, but this does not constitute a failure.

The highest peak emissions are then re-measured using the appropriate quasi-peak detector, with these results then compared against the appropriate limit line. These final Emissions are displayed graphically as markers on the graph and numerically within the results table.

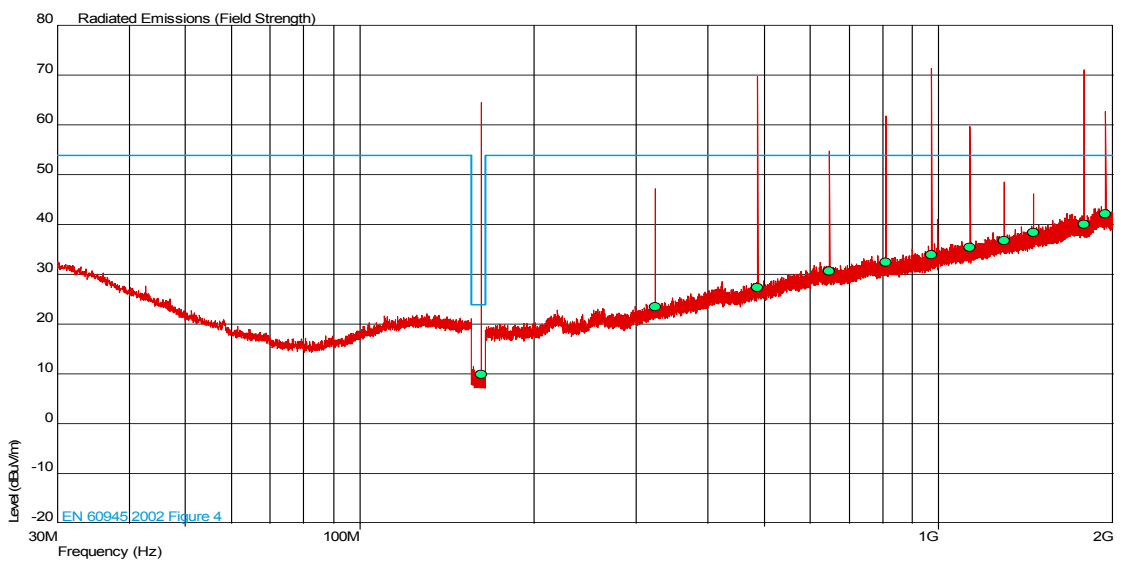

Frequency (MHz)	QP Level (dBµV/m)	QP Limit (dBµV/m)	QP Margin (dBµV/m)	Angle(Deg)	Height(m)	Polarity
161.976	9.9	24.0	-14.1	294	1.00	Vertical
323.900	23.5	54.0	-30.5	164	1.00	Vertical
486.050	27.5	54.0	-26.5	360	1.00	Vertical
648.110	30.7	54.0	-23.3	170	2.54	Horizontal
810.168	32.4	54.0	-21.6	258	3.99	Vertical
971.900	33.9	54.0	-20.1	4	3.98	Vertical
1133.850	35.4	54.0	-18.6	281	3.82	Horizontal
1295.761	36.8	54.0	-17.2	144	1.00	Vertical
1457.793	38.4	54.0	-15.6	360	1.03	Vertical
1782.232	40.1	54.0	-13.9	167	1.00	Horizontal
1944.324	42.2	54.0	-11.8	326	1.00	Vertical



Product Service

Z502 – E Field Measurements

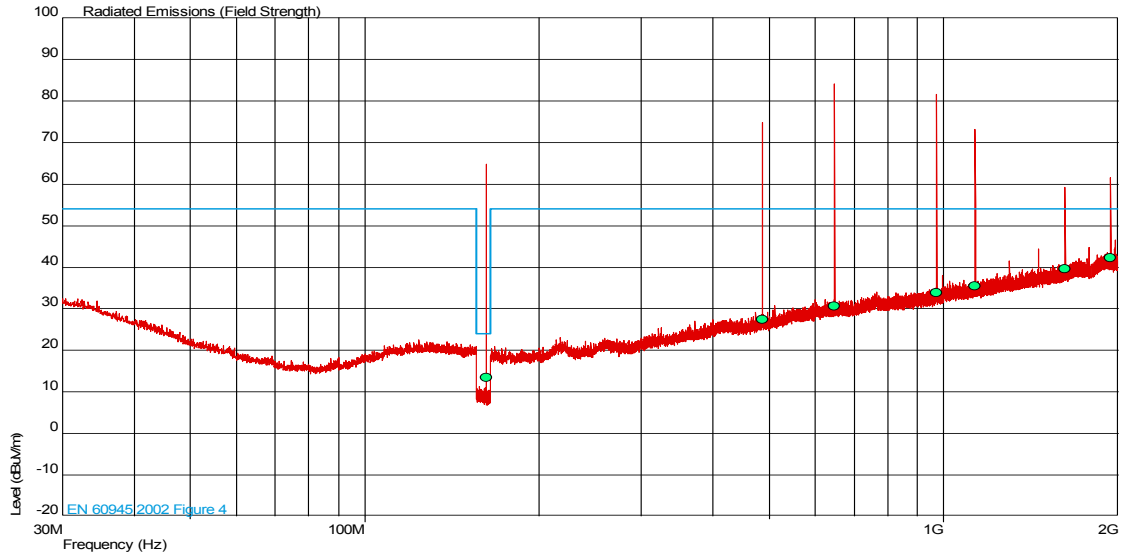

Frequency (MHz)	QP Level (dBµV/m)	QP Limit (dBµV/m)	QP Margin (dBµV/m)	Angle(Deg)	Height(m)	Polarity
161.976	13.4	24.0	-10.6	66	1.00	Vertical
486.050	27.4	54.0	-26.6	161	1.00	Vertical
648.100	30.7	54.0	-23.3	124	1.00	Vertical
971.850	33.9	54.0	-20.1	123	1.00	Vertical
1133.795	35.4	54.0	-18.6	356	1.00	Vertical
1620.242	39.5	54.0	-14.5	75	1.00	Vertical
1943.449	42.2	54.0	-11.8	220	1.37	Horizontal



Product Service

2.29 PERFORMANCE TESTS – BASE UNIT (BU)

2.29.1 Specification Reference

RTCM Paper 219-2011-sc119-155 CDV – RTCM 11901.1, Clause 8.2 (Base Unit (BU))

Test not applicable as the EUTs are Alerting Units only.



Product Service

2.30 ANNEX E – SYSTEM COMPONENTS

2.30.1 Specification Reference

RTCM Paper 219-2011-sc119-155 CDV – RTCM 11901.1, Clause E.2

2.30.2 Equipment Under Test

Z500 Family (Z501), S/N: 970000009
Z500 Family (Z502), S/N: 970000032

2.30.3 Date of Test and Modification State

30 January 2012 - Modification State 0

2.30.4 Test Equipment Used

The major items of test equipment used for the above tests are identified in Section 3.1.

2.30.5 Test Results

The EUTs were physically inspected for the various clauses and documented below.

E.2.1 – Alerting Unit: The AU shall be capable of indicating its location and updating its position and transmitting this position to the BU at regular intervals. The AU shall incorporate a GNSS receiver to provide the locating function. In addition the AU shall include a secondary means of indicating its location to searches in the near vicinity (e.g. by the inclusion of a flashing light).

Z501 and Z502 Observation Outcome

The Z501 and Z502, when activated, transmits a message containing details of its unique identification number and positional data. A secondary indication is provided in the form of a LED flash light (both Z501 and Z502) and audible buzzer (Z501 only).

E.2.2 – Base Unit: The BU will usually be an AIS shipborne station (either Class A or Class B), however it may also be an AIS Base Station or an AIS SAR mobile aircraft equipment. All BUs shall comply with Recommendation ITU-R M. 1371-4 and shall decode and display the GNSS position of the AU.

Z501 and Z502 Observation Outcome

The Z501 and Z502 are Alerting Units and are sold on a standalone basis, therefore this clause is not applicable.



Product Service

2.31 ANNEX E – PERFORMANCE CHARACTERISTICS

2.31.1 Specification Reference

RTCM Paper 219-2011-sc119-155 CDV – RTCM 11901.1, Clause E.3

2.31.2 Equipment Under Test

Z500 Family (Z501), S/N: 970000009
Z500 Family (Z502), S/N: 970000032

2.31.3 Date of Test and Modification State

30 January 2012 - Modification State 0

2.31.4 Test Equipment Used

The major items of test equipment used for the above tests are identified in Section 3.1.

2.31.5 Test Results

The EUTs were physically inspected for the various clauses and documented below.

E.3.1 – Operating time: The AU shall operate for a minimum of 12 hours.

Z501 Observation Outcome

During the battery capacity test the Z501 ran for a total of 28 hours. McMurdo Limited declare that the current load drawn by Z501 and Z502 are the same.

E.3.2 – Interoperability: The AU should be capable of communicating with nearby vessels by transmitting an ITU-R M. 1371-4 Annex 9 compliant Burst Transmission.

Z501 and Z502 Observation Outcome

Aforementioned tests (dry heat, damp heat etc) which required a performance check were carried out using an independent AIS receiver. Messages from both the Z501 and Z502 were received and displayed on the AIS receiver.



Product Service

E.3.3 – Operational functions: The AU shall be capable of either Manual or Manual and Automatic Activation... In addition to the indicators required... the AU shall also provide an indication that is visible to the user in the normal mode of operation of the device that a valid GNSS position has been obtained and that this is being transmitted as a part of the message. If the GNSS position is subsequently lost and is no longer being transmitted, then this shall be indicated to the user.

The RF Self-Test... shall be a single radiated Burst at the full transmit power...

Z501 and Z502 Observation Outcome

The Z501 is capable of manual and automatic activation (via an inflated lifejacket). The Z502 is capable of manual activation only. The EUT LED for both models flashes with several rates / patterns depending on its status, i.e. when a GPS lock is achieved and a valid GNSS position is transmitted, and when the GPS position is lost and is no longer transmitted. The flash patterns are identified in each user manual.

E.3.4 – Unique identifier (user ID): The AIS MSLD AU shall have a unique identifier to ensure the integrity of the VHF data link. The user ID for an AIS MSLD AU is 972xyyyy, where xx = manufacturer ID 01 to 99; yyyy – the sequence number 0000 to 9999...

Not tested at TUV SUD Product Service.



Product Service

E.3.5 – AIS and DSC Combination MSLD Devices.

Z501 and Z502 Observation Outcome

The Z501 and Z502 are not AIS and DSC combination MSLD device, therefore this clause is not applicable.

E.3.6 – Battery: For an AIS MSLD, the AU shall not use a rechargeable battery. Only primary batteries...

Z501 and Z502 Observation Outcome

The Z501 and Z502 are both supplied with internal lithium battery packs.

E.3.7 – Output Power: The nominal radiated power (EIRP) of the AIS MSLD AU shall be 1W.

Z501 and Z502 Observation Outcome

See TUV SUD document 75911998 THC 01 and THC 02.

E.3.8 – Transmission Performance.

Z501 and Z502 Observation Outcome

Not Tested at TUV SUD Product Service.

E.3.9 – Position Source and Data.

Z501 and Z502 Observation Outcome

Not Tested at TUV SUD Product Service.



Product Service

2.32 ANNEX E – DOCUMENTATION

2.32.1 Specification Reference

RTCM Paper 219-2011-sc119-155 CDV – RTCM 11901.1, Clause E.5

2.32.2 Test Results

General instructions advising the user of what to expect when using the EUTs are provided in the relevant manual. For completeness, Section & Documentation has also been addressed (see section 2.20).



Product Service

2.33 ANNEX E – BATTERY CAPACITY TEST (VARTA CELL)

2.33.1 Specification Reference

RTCM Paper 219-2011-sc119-155 CDV – RTCM 11901.1, Clause E.6.5 (Battery Capacity Test)

2.33.2 Equipment Under Test

Z500 Family (Z501), S/N: 970120005 with VARTA battery pack

2.33.3 Date of Test and Modification State

28 to 30 July - Modification State 0

2.33.4 Test Equipment Used

The major items of test equipment used for the above tests are identified in Section 3.1.

2.33.5 Environmental Conditions

	28 July 2011
Ambient Temperature	23.3°C
Relative Humidity	44.7%

2.33.6 Test Results

Procedure

The Varta battery pack was pre-discharged for 0.316Ah prior to the test. The battery was discharged by constant current discharge via a connection to a resistive load (100R for 5.6 hours).

The EUT was placed in the environmental chamber at laboratory ambient conditions. The temperature of the chamber was then reduced to -20 °C. The temperature of the chamber was maintained for a period of 17 hours after which time the EUT was activated (without GPS data available). The EUT was allowed to operate for a period of 28 hours. A Class A AIS receiver was positioned outside of the chamber and was connected to the EUT; this confirmed that the EUT continued to operate throughout the 28 hour operational period.

Test Observations

The operational period of the test ran for 28 hours. The AIS receiver continued to receive messages throughout the operational period. After 28 hour the EUT was subject to the performance test.



Performance Check

The performance check described in IEC 61097-14 was carried out; consisting of activating the EUT in self test mode with a GPS signal provided via a GPS simulator. Messages 1 and 14 from the Z501 were received by an AIS receiver.

In addition to the performance check the performance test was also carried out; this test consisted of activating the EUT in self test mode with GPS signal provided via a GPS simulator. The integrity of the transmitted bursts was checked.

61097-14 Performance Test (Clause 5.2.3, 8.3.2.2)	Comments / Data	Result
A: EUT starts transmission after valid GNSS data is available.	GNSS data was supplied to the EUT and the self test function was activated. Messages 1 and 14 were received by an AIS receiver for the EUT therefore transmissions were successful.	Pass
B: A single burst of 8 messages in the correct order and correctly populated as per 3.7.2.	8 messages were received from the EUT and the actual decoded messages were compared against the required decoded message.	Pass
C: User ID as configured in the EUT.	Z501 Received and Actual User ID:970120005	Pass
D: Navigational status = 15 (not defined).	Navigational status of all message 1 messages was equal to 15.	Pass
E: SOG = actual SOG from GNSS receiver.	The SOG value received for the Z501 was equal to 0 knots.	Pass
F: Position accuracy = according to the RAIM result if provided, otherwise 0.	Position accuracy was equal to 0.	Pass
G: Position = actual position from internal GNSS receiver.	The applied position was equal to the received position.	Pass
H: COG = actual COG from internal GNSS receiver	The COG was 360 (not available).	Pass
I: Time stamp = actual UTC second (0...59).	Time stamp was valid for the EUTs (34).	Pass
J: The communication state time-out always = 0 with sub message = 0.	The communication state time-out was = 0 with sub message = 0.	Pass
K: The transmission of Messages 1 and 14 stops after one burst of 8 messages.	The AIS receiver did not receive any more than 8 messages for each self test.	Pass
L: The text message in Message 14 is "SART TEST".	Text message of message 14 was decoded as "SART TEST".	Pass
M: Verify correct indication as per manufacturer's documentation.	Z501: three long beeps and flashes.	Pass



2.34 ANNEX E – BATTERY CAPACITY TEST (PANASONIC CELL)

2.34.1 Specification Reference

RTCM Paper 219-2011-sc119-155 CDV – RTCM 11901.1, Clause E.6.5 (Battery Capacity Test)

2.34.2 Equipment Under Test

Z500 Family (Z501), S/N: 970120005 with Panasonic battery pack

2.34.3 Date of Test and Modification State

01 to 03 August 2011 - Modification State 0

2.34.4 Test Equipment Used

The major items of test equipment used for the above tests are identified in Section 3.1.

2.34.5 Environmental Conditions

	01 August 2011	03 August 2011
Ambient Temperature	24.2°C	24.0°C
Relative Humidity	48.0%	46.0%

2.34.6 Test Results

Procedure

The alternate Panasonic battery pack was pre-discharged for 0.316Ah prior to the test (See Annex A for manufacturer calculations). The battery was discharged by constant current discharge via a connection to a resistive load (100R for 5.6 hours).

The EUT was placed in the environmental chamber at laboratory ambient conditions. The temperature of the chamber was then reduced to -20 °C. The temperature of the chamber was maintained for a period of 17 hours after which time the EUT was activated (without GPS data available). The EUT was allowed to operate for a period of 28 hours. A Class A AIS receiver was positioned outside of the chamber and was connected to the EUT; this confirmed that the EUT continued to operate throughout the 28 hour operational period.

Test Observations

The operational period of the test ran for 28 hours. The AIS receiver continued to receive messages throughout the operational period. After 28 hours the EUT was subject to the performance test.



Performance Check

The performance check described in IEC 61097-14 was carried out; consisting of activating the EUT in self test mode with a GPS signal provided via a GPS simulator. Messages 1 and 14 from the Z501 were received by an AIS receiver.

In addition to the performance check the performance test was also carried out; this test consisted of activating the EUT in self test mode with GPS signal provided via a GPS simulator. The integrity of the transmitted bursts was checked.

61097-14 Performance Test (Clause 5.2.3, 8.3.2.2)	Comments / Data	Result
A: EUT starts transmission after valid GNSS data is available.	GNSS data was supplied to the EUT and the self test function was activated. Messages 1 and 14 were received by an AIS receiver for the EUT therefore transmissions were successful.	Pass
B: A single burst of 8 messages in the correct order and correctly populated as per 3.7.2.	8 messages were received from the EUT and the actual decoded messages were compared against the required decoded message.	Pass
C: User ID as configured in the EUT.	Z501 Received and Actual User ID:970120005	Pass
D: Navigational status = 15 (not defined).	Navigational status of all message 1 messages was equal to 15.	Pass
E: SOG = actual SOG from GNSS receiver.	The SOG value received for the Z501 was equal to 0 knots.	Pass
F: Position accuracy = according to the RAIM result if provided, otherwise 0.	Position accuracy was equal to 0.	Pass
G: Position = actual position from internal GNSS receiver.	The applied position was equal to the received position.	Pass
H: COG = actual COG from internal GNSS receiver	The COG was 360 (not available).	Pass
I: Time stamp = actual UTC second (0...59).	Time stamp was valid for the EUT (6).	Pass
J: The communication state time-out always = 0 with sub message = 0.	The communication state time-out was = 0 with sub message = 0.	Pass
K: The transmission of Messages 1 and 14 stops after one burst of 8 messages.	The AIS receiver did not receive any more than 8 messages for each self test.	Pass
L: The text message in Message 14 is "SART TEST".	Text message of message 14 was decoded as "SART TEST".	Pass
M: Verify correct indication as per manufacturer's documentation.	Z501: three long beeps and flashes.	Pass



2.35 ANNEX E – FREQUENCY ERROR

2.35.1 Specification Reference

RTCM Paper 219-2011-sc119-155 CDV – RTCM 11901.1, Clause E.7.1.1.1

2.35.2 Equipment Under Test

Z500 Family (Z501), S/N: 970120005

2.35.3 Date of Test and Modification State

18 and 27 May 2011 - Modification State 0

2.35.4 Test Equipment Used

The major items of test equipment used for the above tests are identified in Section 3.1.

2.35.5 Environmental Conditions

	18 May 2011	27 May 2011
Ambient Temperature	20.8°C	20.2°C
Relative Humidity	54.3%	40.0%

2.35.6 Test Results

5.45 V DC Supply

Test Conditions		Frequency Error (kHz)	
		AIS 1	AIS 2
		161.975 MHz	162.025 MHz
T _{nom} (+20.8°C)	V _{nom} (5.45 V DC)	0.210	0.270
T _{min} (-20.0°C)	V _{min} (4.8 V DC)	-0.043	-0.159
	V _{max} (6.0 V DC)	-0.045	-0.163
T _{max} (+55.0°C)	V _{min} (4.8 V DC)	-0.166	-0.249
	V _{max} (6.0 V DC)	-0.165	-0.258
Measurement Uncertainty (Hz)		± 9.25	

Limit Clause 7.2.3

The frequency error shall not exceed ± 0.5 kHz, under normal test conditions and ± 1 kHz under extreme test conditions.



2.36 ANNEX E – CONDUCTED POWER

2.36.1 Specification Reference

RTCM Paper 219-2011-sc119-155 CDV – RTCM 11901.1, Clause E.7.2

2.36.2 Equipment Under Test

Z500 Family (Z501), S/N: 970120005

2.36.3 Date of Test and Modification State

27 May 2011 - Modification State 0

2.36.4 Test Equipment Used

The major items of test equipment used for the above tests are identified in Section 3.1.

2.36.5 Environmental Conditions

	27 May 2011
Ambient Temperature	20.2°C
Relative Humidity	40.0%

2.36.6 Test Results

5.45 V DC Supply

Test Conditions		Power (dBm)		
		AIS 1		
		P_{20}	P_{-20}	P_{+55}
T_{nom} (+20.8°C)	V_{nom} (5.45 V DC)	+32.79	-	-
T_{min} (-20.0°C)	V_{min} (4.8 V DC)	-	+31.76	-
	V_{max} (6.0 V DC)	-	+32.89	-
T_{max} (+55.0°C)	V_{min} (4.8 V DC)	-	-	+32.84
	V_{max} (6.0 V DC)	-	-	+33.65
Measurement Uncertainty (dB)		± 0.70		



Z501

P_d (dB)	Gain of the Antenna (G) = P_R - P₂₀ - P_d	Conducted power, corrected for the antenna gain
1.01	29.2 - 32.79 - 1.01 = -4.6 dB	P ₋₂₀ + G + P _d = 31.76 - 4.6 + 1.01 = 28.17 dBm
		P ₅₅ + G + P _d = 33.65 - 4.6 + 1.01 = 30.06 dBm

Z502*

P_d (dB)	Gain of the Antenna (G) = P_R - P₂₀ - P_d	Conducted power, corrected for the antenna gain
0.81	30.64 - 32.79 - 0.81 = -2.96 dB	P ₋₂₀ + G + P _d = 31.76 - 2.96 + 0.81 = 29.61 dBm
		P ₅₅ + G + P _d = 33.65 - 4.6 + 1.01 = 31.50 dBm

P_R is the radiated power level (See section 2.7)

P₂₀ is the conducted power level at normal conditions

P_d (dB) = standard unit power (dBm) - modified unit power (dBm)

*Note: The Z502 calculations have been based on the conducted power measurement measured for the Z501. McMurdo Limited have declared that the Z501 and Z502 share a common PCB and therefore will produce the same power into 50ohms. The antenna configuration provides the difference between the two products.

Limit Clause, Table E.5

Power	dBm
P ₋₂₀ + G + P _d	27
P ₅₅ + G + P _d	27
NOTE: This power equates to the radiated power at extreme temperatures.	



Product Service

2.37 ANNEX E – RADIATED POWER

2.37.1 Specification Reference

RTCM Paper 219-2011-sc119-155 CDV – RTCM 11901.1, Clause E.7.3

2.37.2 Test Results

Refer to 75911998 THC 01 and THC 02.



Product Service

2.38 ANNEX E – MODULATION SPECTRUM SLOTTED TRANSMISSION

2.38.1 Specification Reference

RTCM Paper 219-2011-sc119-155 CDV – RTCM 11901.1, Clause E.7.3.1.4

2.38.2 Equipment Under Test

Z500 Family (Z501), S/N: 970120005

2.38.3 Date of Test and Modification State

18 May 2011 - Modification State 0

2.38.4 Test Equipment Used

The major items of test equipment used for the above tests are identified in Section 3.1.

2.38.5 Environmental Conditions

	18 May 2011
Ambient Temperature	21.2°C
Relative Humidity	55.6%

2.38.6 Test Results

5.45 V DC Supply

Test Signal Number 3

AIS 1

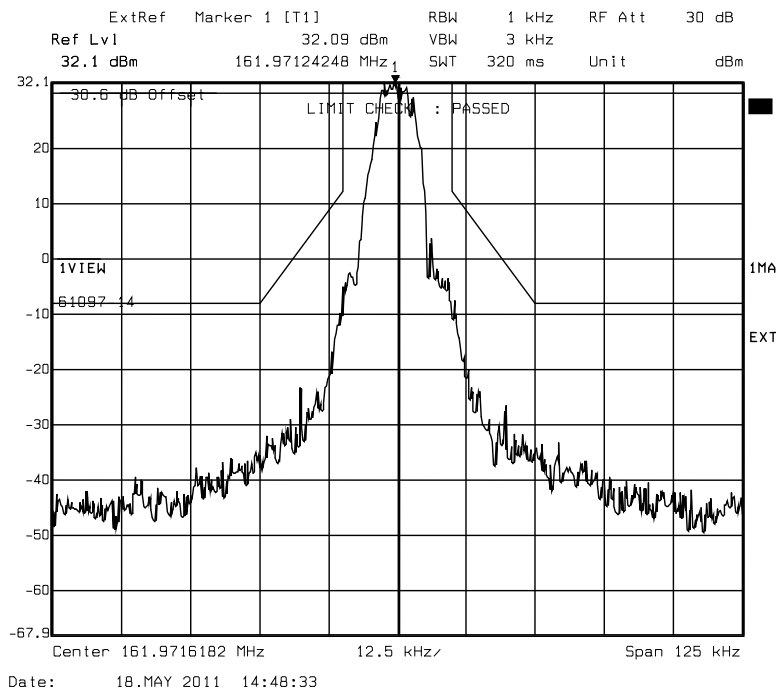

Limit Clause E.7.3.1.7

- In the region between the carrier and ± 10 kHz removed from the carrier, the modulation and transient sidebands shall be below 0 dBc
- At 10 kHz removed from the carrier, the modulation and transient sidebands shall be below -20 dBc
- At 25 kHz to ± 62.5 kHz removed from the carrier, the modulation and transient sidebands shall be below the lower value of -40 dBc
- In the region between ± 10 kHz and ± 25 kHz removed from the carrier, the modulation and transient sidebands shall be below a line specified between these two points.

The reference level for the measurement shall be the carrier power (conducted) recorded for the appropriate test frequency in E.7.2

Also, please refer to the mask shown in figure 4 of the specification.



Product Service

2.39 ANNEX E – TRANSMITTER TEST SEQUENCE AND MODULATION ACCURACY

2.39.1 Specification Reference

RTCM Paper 219-2011-sc119-155 CDV – RTCM 11901.1, Clause E.7.4

2.39.2 Equipment Under Test

Z500 Family (Z501), S/N: 97012005

2.39.3 Date of Test and Modification State

28 June 2011 - Modification State 0

2.39.4 Test Equipment Used

The major items of test equipment used for the above tests are identified in Section 3.1.

2.39.5 Environmental Conditions

	28 June 2011
Ambient Temperature	24.6°C
Relative Humidity	53.7%



Product Service

2.39.6 Test Results

5.45 V DC Supply

AIS 1, Test Signal 1

Ambient Temperature 24.6°C, Nominal Voltage 5.45 V DC

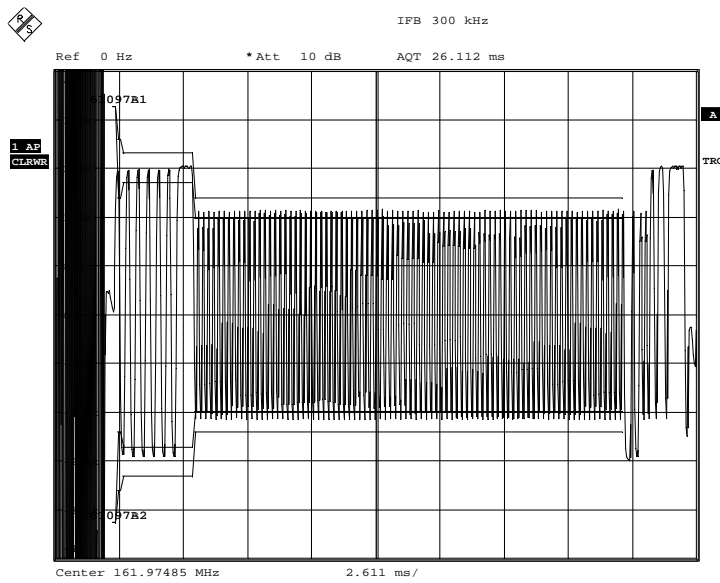

Date: 28.JUN.2011 11:19:40

Low Temperature -20°C, Minimum Voltage 4.8 V DC

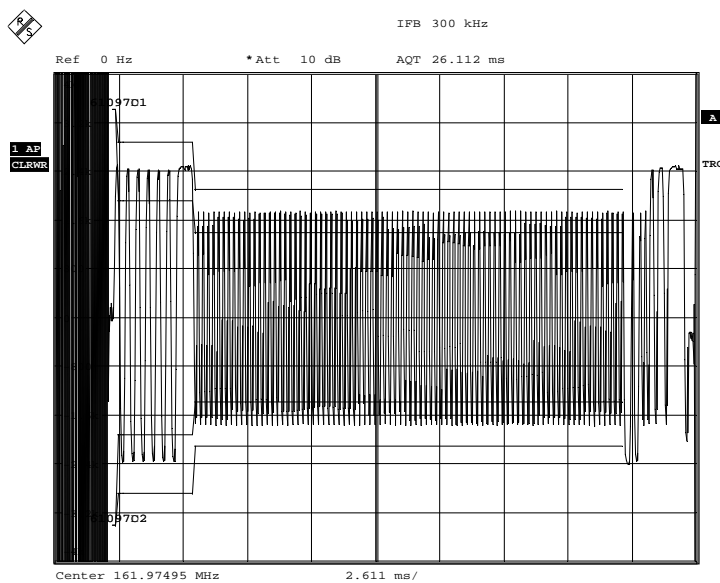

Date: 28.JUN.2011 15:11:35



Product Service

Low Temperature -20°C, Maximum Voltage 6.0 V DC

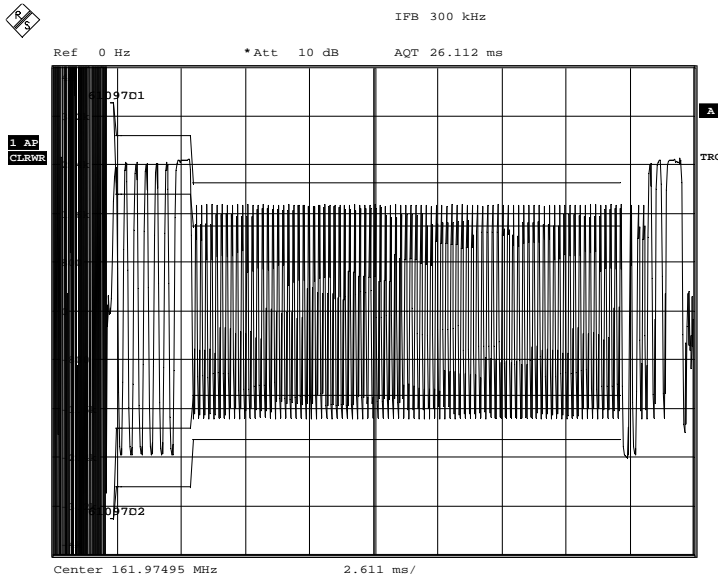

Date: 28.JUN.2011 15:12:13

High Temperature +55°C, Minimum Voltage 4.8 V DC

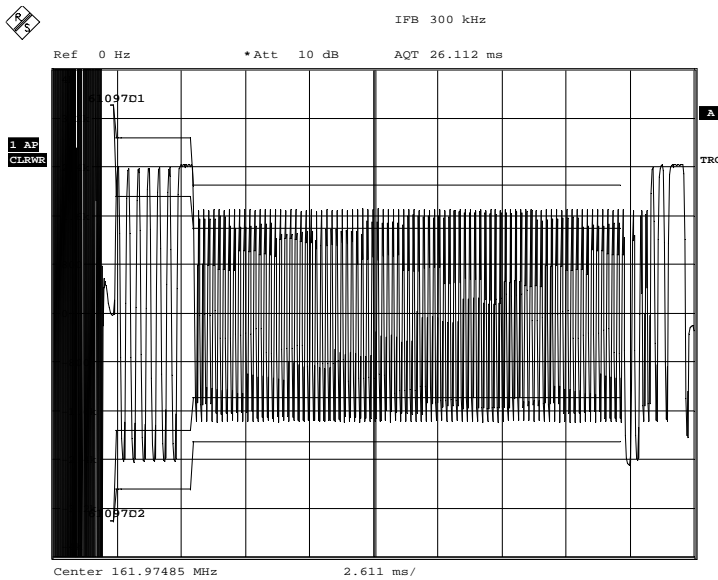

Date: 28.JUN.2011 13:21:38



Product Service

High Temperature +55°C, Maximum Voltage 6.0 V DC

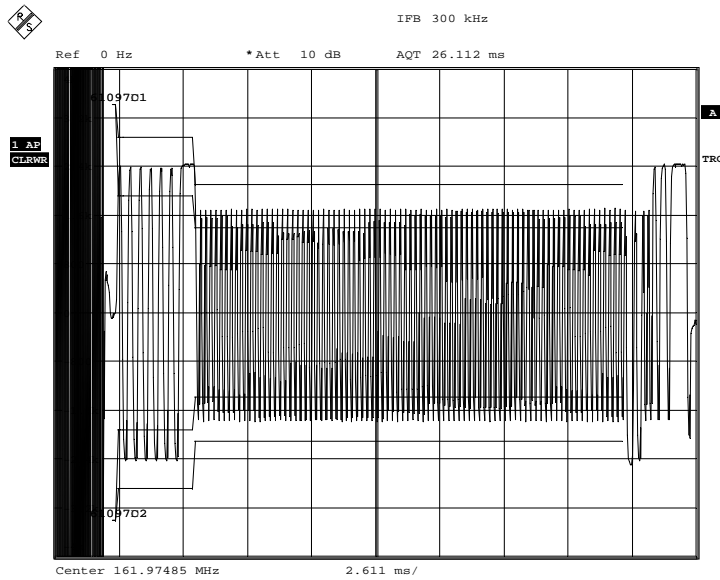

Date: 28.JUN.2011 13:22:56

AIS 1, Test Signal 2

Ambient Temperature 24.6°C, Nominal Voltage 5.45 V DC

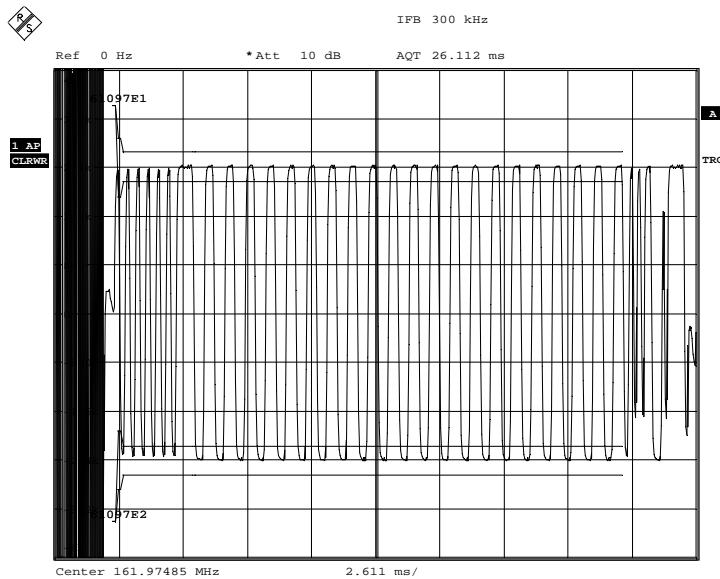

Date: 28.JUN.2011 11:27:44



Product Service

Low Temperature -20°C, Minimum Voltage 4.8 V DC

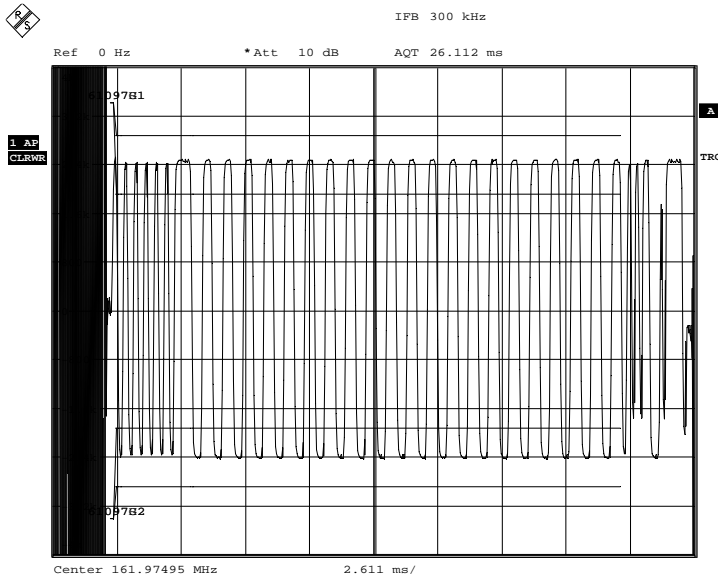

Date: 28.JUN.2011 15:13:26

Low Temperature -20°C, Maximum Voltage 6.0 V DC

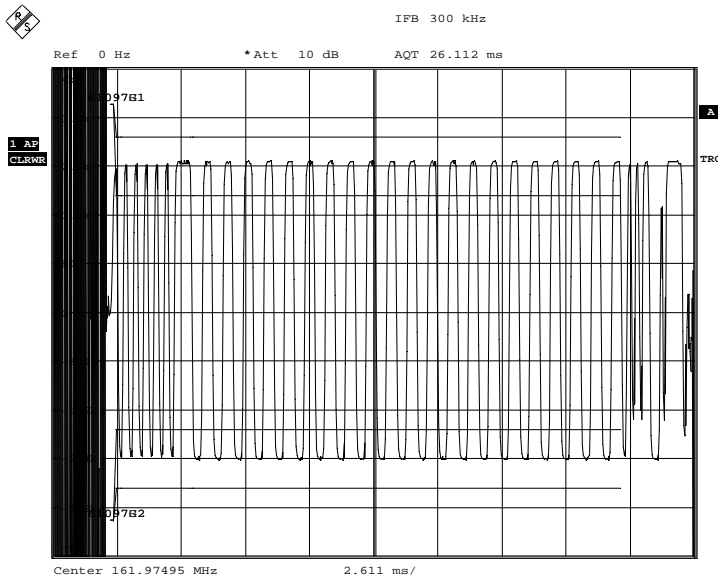

Date: 28.JUN.2011 15:12:53



Product Service

High Temperature +55°C, Minimum Voltage 4.8 V DC

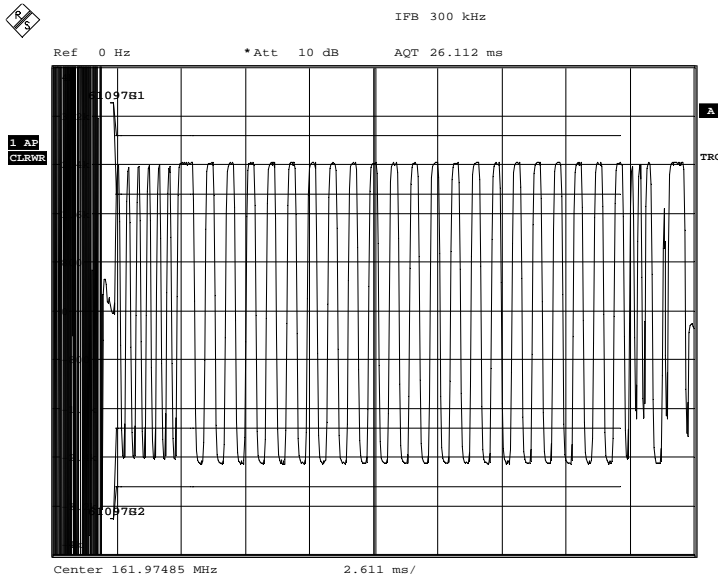

Date: 28.JUN.2011 13:24:22

High Temperature +55°C, Maximum Voltage 6.0 V DC

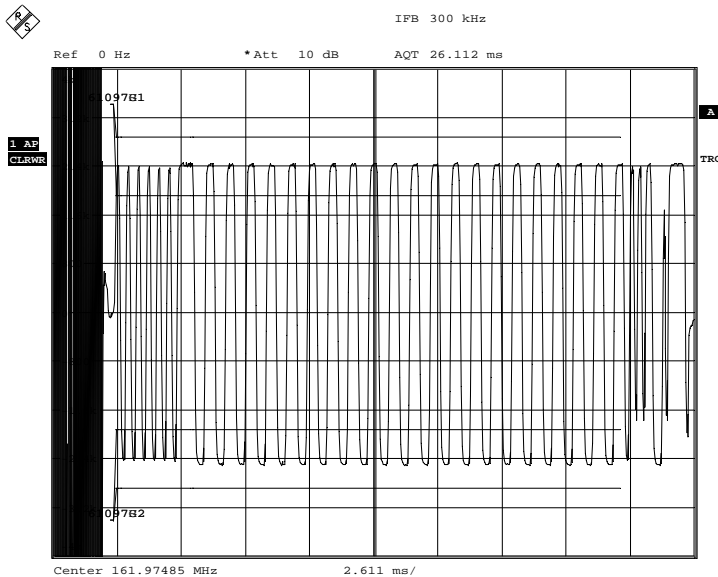

Date: 28.JUN.2011 13:23:52



Product Service

AIS 2, Test Signal 1

Ambient Temperature 24.6°C, Nominal Voltage 5.45 V DC

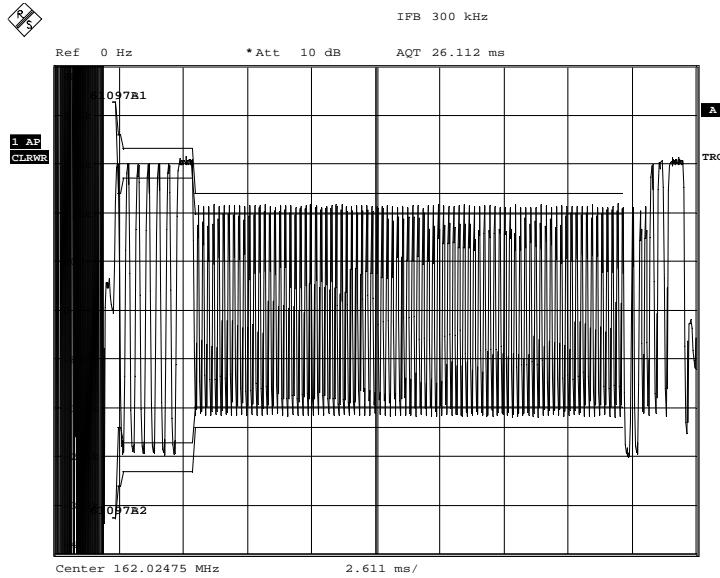

Date: 28.JUN.2011 11:25:54

Low Temperature -20°C, Minimum Voltage 4.8 V DC

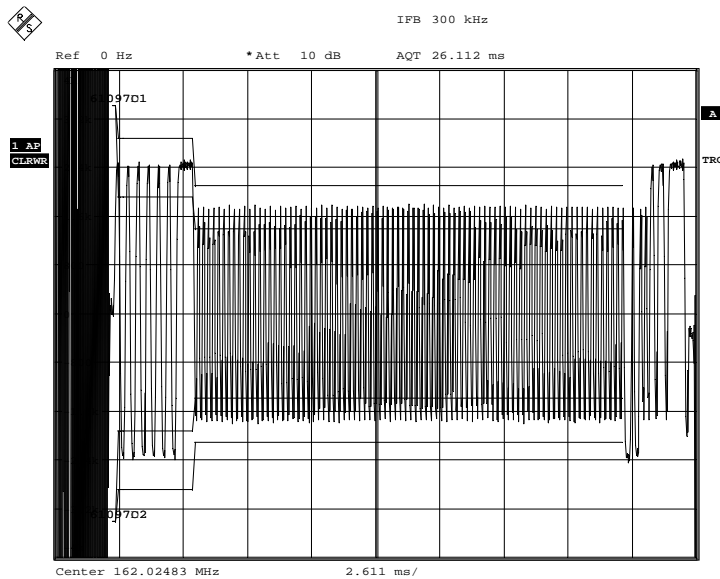

Date: 28.JUN.2011 15:15:42



Product Service

Low Temperature -20°C, Maximum Voltage 6.0 V DC

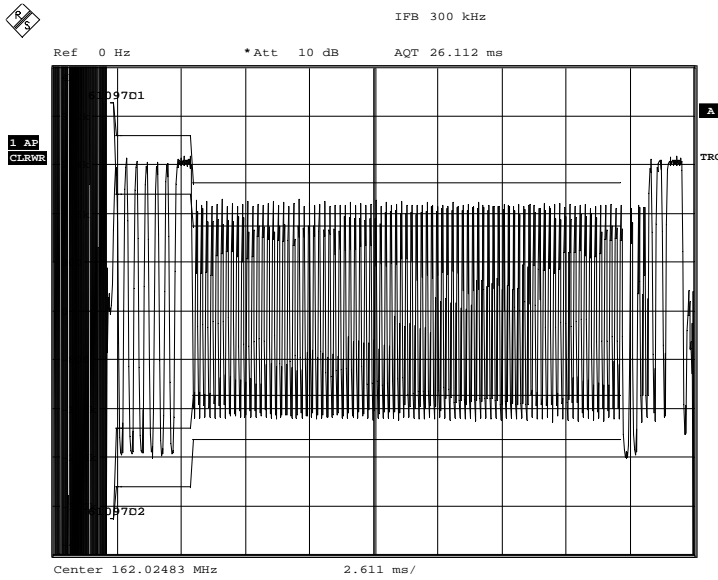

Date: 28.JUN.2011 15:16:14

High Temperature +55°C, Minimum Voltage 4.8 V DC

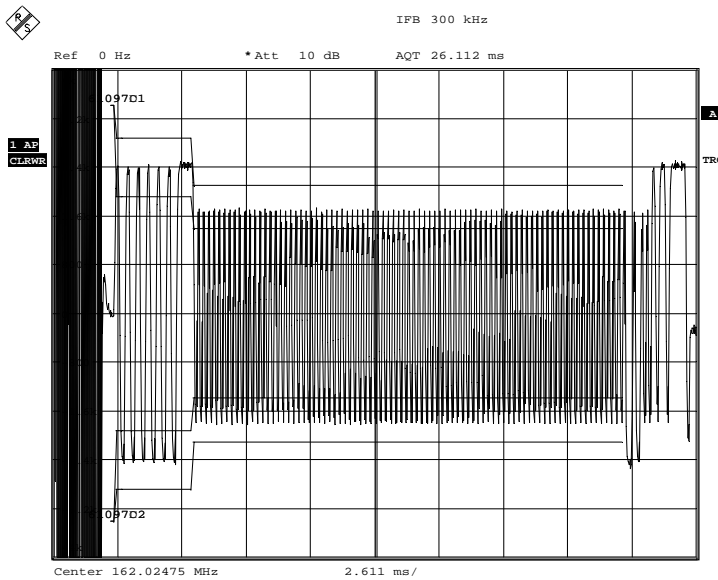

Date: 28.JUN.2011 14:19:05



Product Service

High Temperature +55°C, Maximum Voltage 6.0 V DC

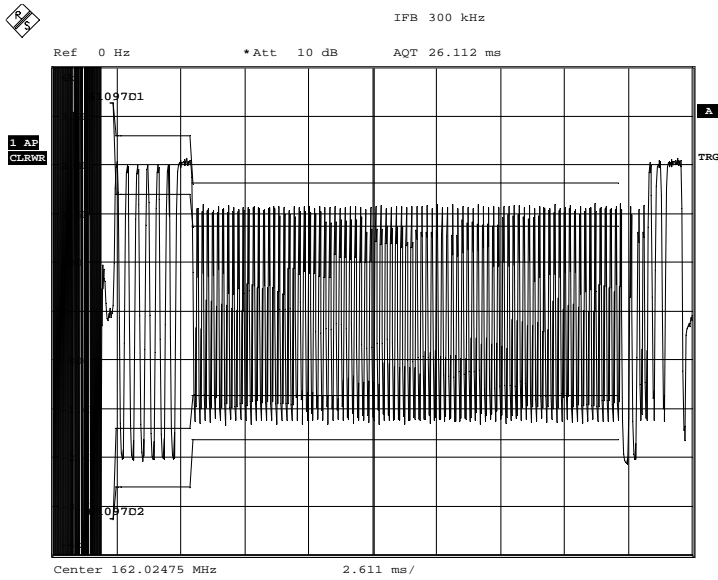

Date: 28.JUN.2011 14:19:37

AIS 2, Test Signal 2

Ambient Temperature 24.6°C, Nominal Voltage 5.45 V DC

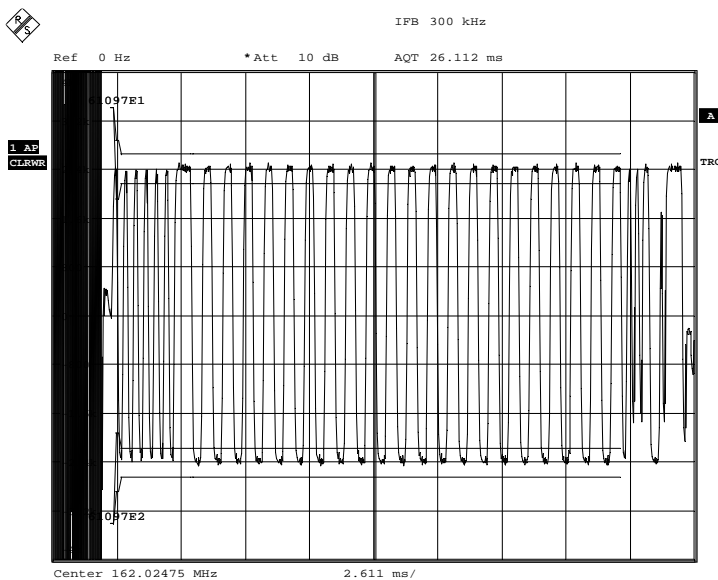

Date: 28.JUN.2011 11:26:38



Product Service

Low Temperature -20°C, Minimum Voltage 4.8 V DC

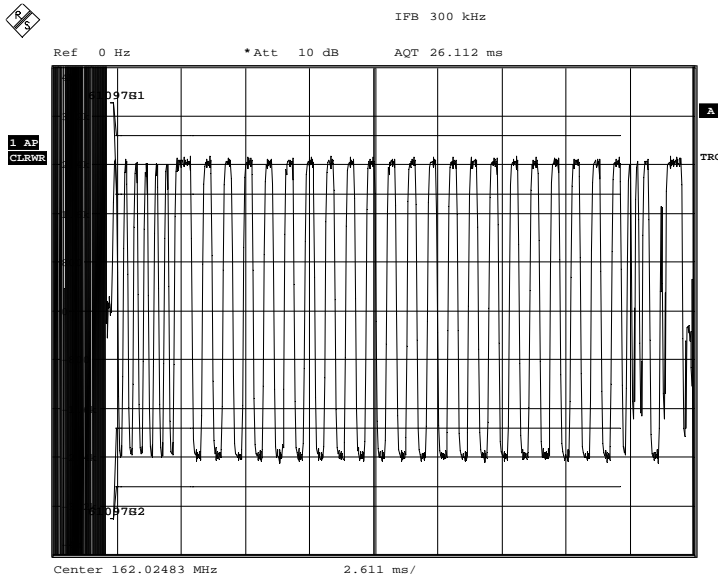

Date: 28.JUN.2011 15:26:42

Low Temperature -20°C, Maximum Voltage 6.0 V DC

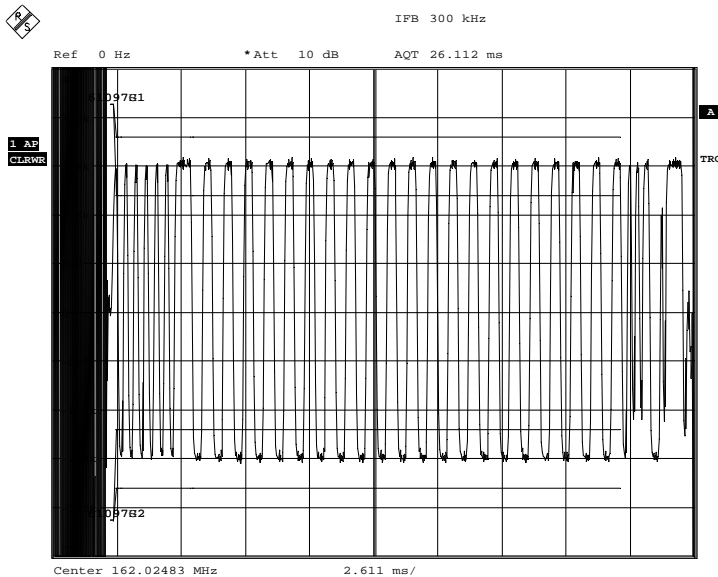

Date: 28.JUN.2011 15:27:35



Product Service

High Temperature +55°C, Minimum Voltage 4.8 V DC

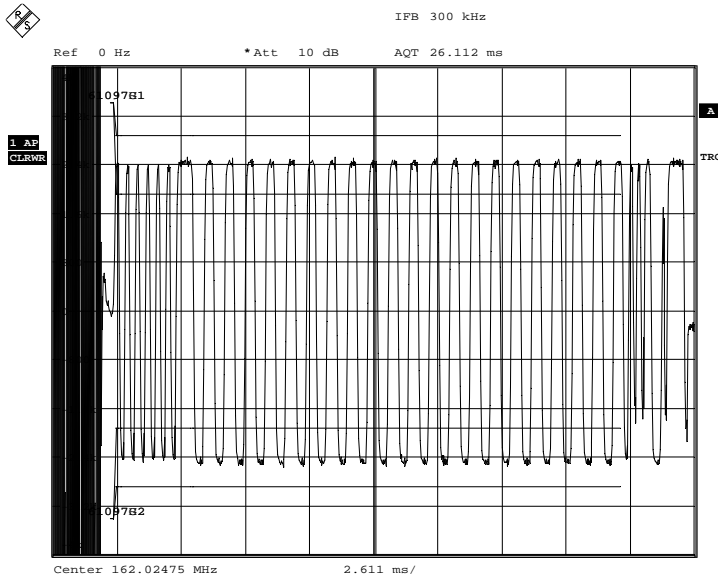

Date: 28.JUN.2011 14:21:17

High Temperature +55°C, Maximum Voltage 6.0 V DC

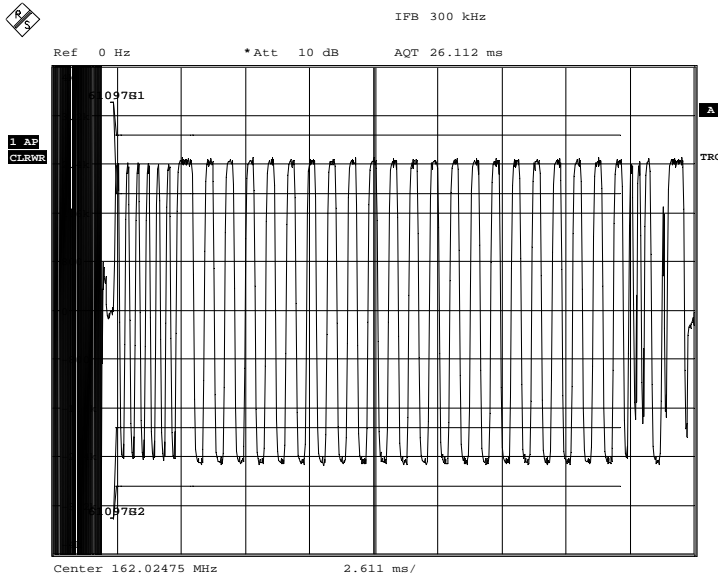

Date: 28.JUN.2011 14:20:53



Product Service

Limit Clause E.7.4.1.3

In each case, verify that the training sequence begins with '0'.

Measurement period from centre to centre of each bit	Test Signal 1		Test Signal 2	
	Normal	Extreme	Normal	Extreme
Bit 0 to bit 1	< 3400 Hz			
Bit 2 to bit 3	2400 Hz \pm 480 Hz			
Bit 4 to bit 31	2400 Hz \pm 240 Hz	2 400 Hz \pm 480 Hz	2 400 Hz \pm 240 Hz	2 400 Hz \pm 480 Hz
Bit 32 to bit 199	1740 Hz \pm 175 Hz	1 740 Hz \pm 350 Hz	2 400 Hz \pm 240 Hz	2 400 Hz \pm 480 Hz



Product Service

2.40 ANNEX E – TRANSMITTER OUTPUT POWER VERSUS TIME FUNCTION

2.40.1 Specification Reference

RTCM Paper 219-2011-sc119-155 CDV – RTCM 11901.1, Clause E.7.5

2.40.2 Equipment Under Test

Z500 Family (Z501), S/N: 970120005

2.40.3 Date of Test and Modification State

19 May 2011 - Modification State 0

2.40.4 Test Equipment Used

The major items of test equipment used for the above tests are identified in Section 3.1.

2.40.5 Environmental Conditions

	19 May 2011
Ambient Temperature	22.1°C
Relative Humidity	31.8%



Product Service

2.40.6 Test Results

5.45 V DC Supply

Test Signal Number 1

AIS 1

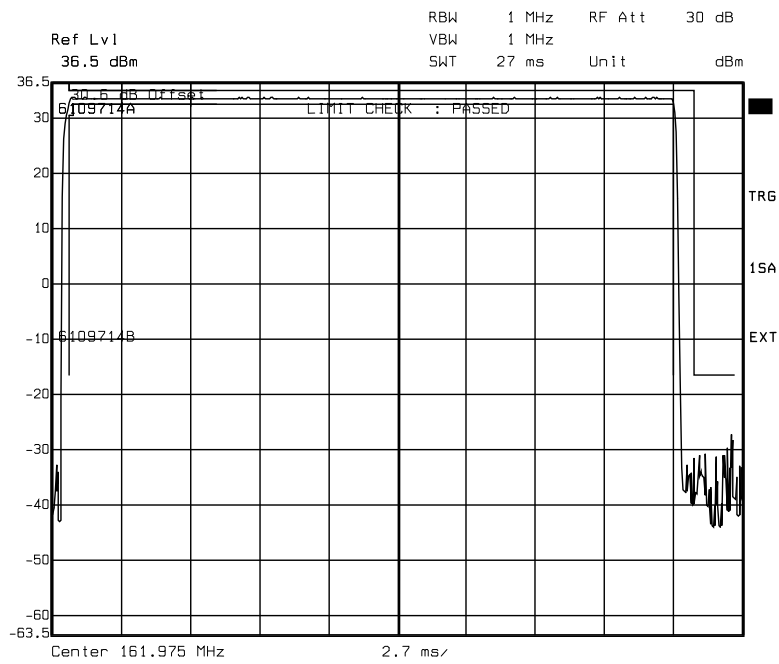

Date: 19.MAY 2011 15:35:14

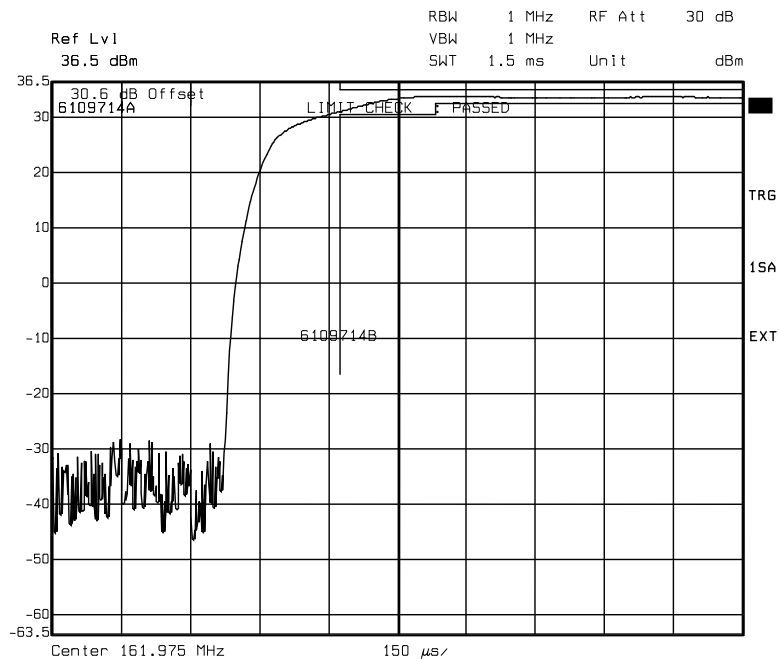

Date: 19.MAY 2011 15:37:24



Limit Clause E.7

Reference	Bits	Time ms	Definition
T ₀	0	0	Start of transmission slot. Power shall NOT exceed -50 dB of P _{ss} before T ₀
T ₀ – T _A	0 to 6	0 to 0,625	Power may exceed -50 dB of P _{ss} ^a
T _B	T _{B1}	6	Power shall be within +1,5 dB or -3 dB of P _{ss} ^a
	T _{B2}	8	Power shall be within +1,5 dB or -1 dB of P _{ss} ^a
T _E (includes 1 stuffing bit)	233	24,271	Power shall remain within +1,5 dB or -1 dB of P _{ss} during the period T _{B2} to T _E ^a
T _F (includes 1 stuffing bit)	241	25,104	Power shall be -50 dB of P _{ss} and stay below this
T _G	256	26,667	Start of next transmission time period
^a There shall be no modulation of the RF after the termination of transmission (T _E) until the power has reached zero and next slot begins (T _G).			



Product Service

2.41 ANNEX E – SPURIOUS EMISSIONS FROM THE TRANSMITTER

2.41.1 Specification Reference

RTCM Paper 219-2011-sc119-155 CDV – RTCM 11901.1, Clause E.7.6

2.41.2 Equipment Under Test

Z500 Family (Z501), S/N: 970120005

2.41.3 Date of Test and Modification State

19 May 2011 - Modification State 0

2.41.4 Test Equipment Used

The major items of test equipment used for the above tests are identified in Section 3.1.

2.41.5 Environmental Conditions

	19 May 2011
Ambient Temperature	21.0°C
Relative Humidity	34.7%



Product Service

2.41.6 Test Results

5.45 V DC Supply

108 MHz to 137 MHz

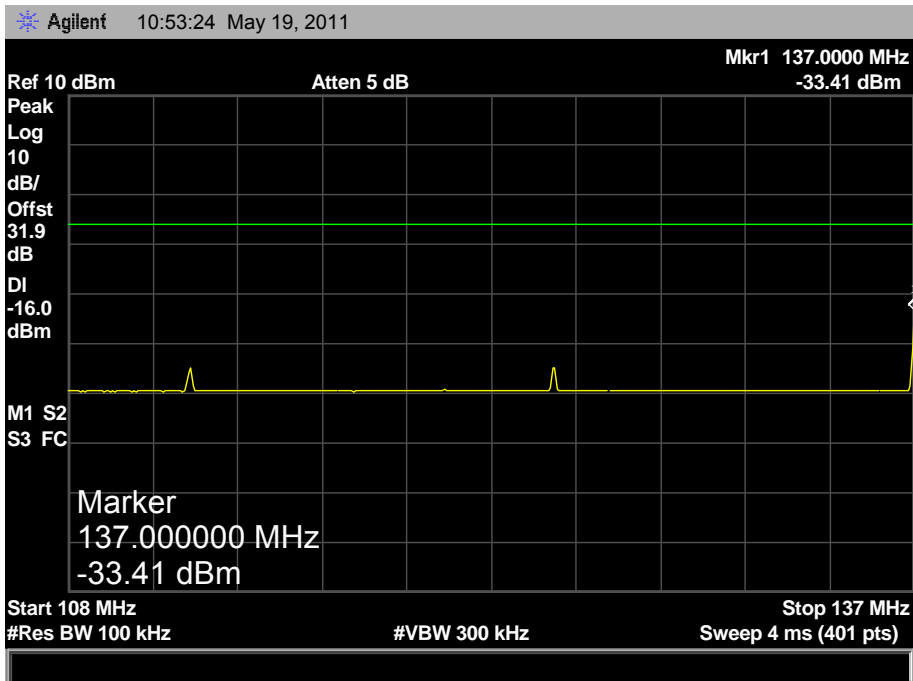

156 MHz to 161.5 MHz

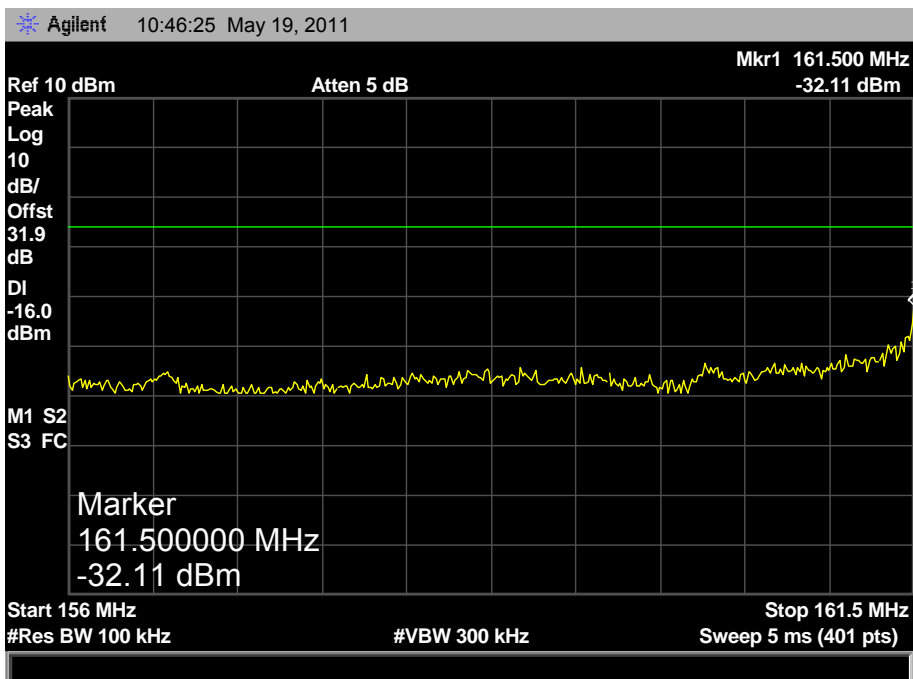



Product Service

406.0 MHz to 406.1 MHz

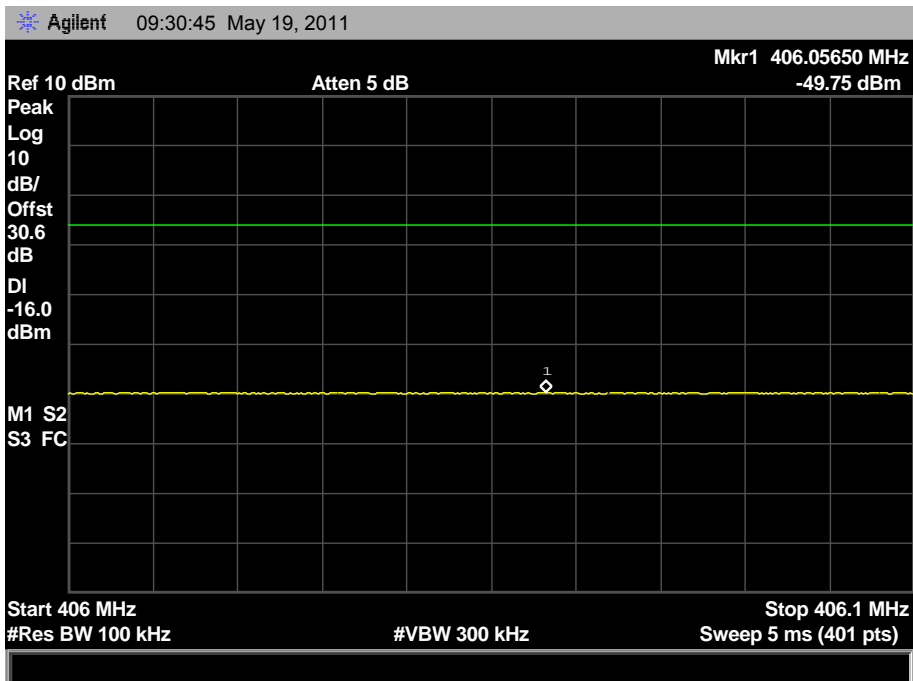

1525 MHz to 1610 MHz

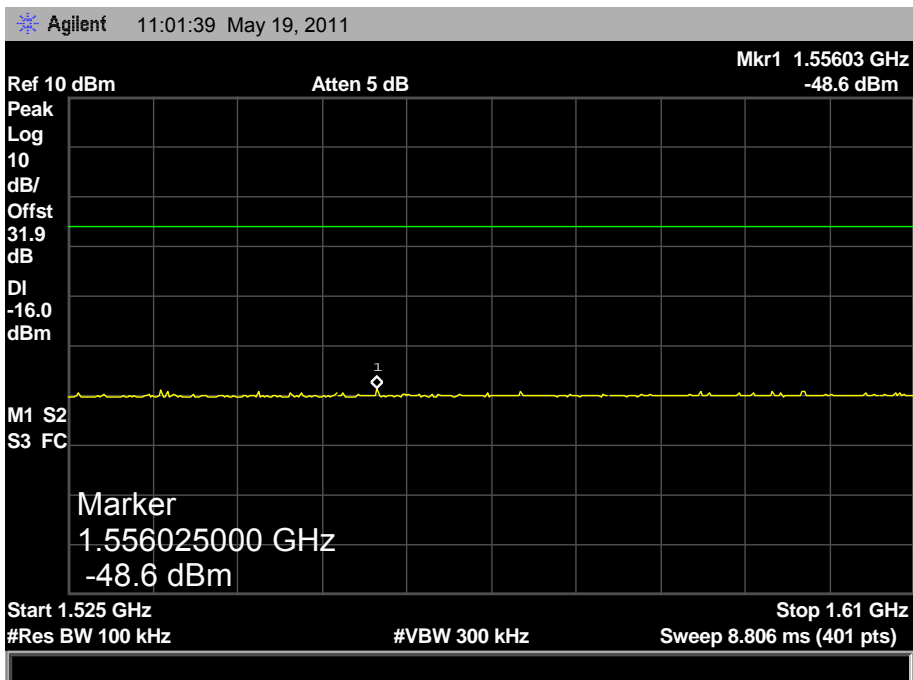

Limit Clause E.7.6.1.3

No signal level within these bands shall exceed 25 μ W (-16 dBm).



Product Service

2.42 ANNEX E – LINK LAYER TESTS

2.42.1 Specification Reference

RTCM Paper 219-2011-sc119-155 CDV – RTCM 11901.1, Clause E.8

Not tested at TUV SUD Product Service.



Product Service

2.43 ANNEX F – INTERNAL NAVIGATION DEVICE TEST METHODS AND PROCEDURES

2.43.1 Specification Reference

RTCM Paper 219-2011-SC119-155 CDV – RTCM 11901.1, Annex F

2.43.2 Equipment Under Test

Z501: TUV ref: 75912801-TSR0023 (S/N 970122289)

Z502: TUV ref: 75912801-TSR0012 (S/N 970120031)

2.43.3 Date of Test and Modification State

16 January 2012 and 08 February 2012 - Modification State 0

2.43.4 Test Equipment Used

The major items of test equipment used for the above tests are identified in Section 3.1.

2.43.5 Test Procedure

Clause F.3.4 Summarised:

- *within 10 seconds of the scenario starting the AU shall be switched on*
- *At the same time as the AU is activated a stop watch or similar timer is started.*
- *The Scenario is then left to run until either;*
- *a GPS fix is obtained and a location message containing position is received by the AIS receiver; or*
- *the scenario runs to completion plus one minute*
- *If a location is received then the stop watch or timer shall immediately be stopped and the time and received location shall be recorded in the test results tables.*
- *If a location is not received within 13[*] minutes of starting the Scenario then a “Fail” shall be indicated for that Scenario in the Table. Note that the first transmitted location as received by the AIS receiver is the one that should be recorded; any subsequent updated locations should be ignored.*
- *The Scenario is NOT repeated and the next Scenario is loaded as described below.*
- *Note that the TTFF is the time until the AU transmits a burst containing location data, not the time until an indicator on the AU indicates that a GPS fix has been obtained.*
- *The AU is then switched off and left turned off for at least the specified time interval (see F.3.2). During this period the next Scenario is loaded into the Simulator and the Beacon Tester and stop watch are reset. Once the specified AU off period [see below] has elapsed this procedure should be repeated.*
- *[Specified time interval, from Clause F.3.2:] The manufacturer shall provide evidence of the time it takes all of the power supplies within the AU to drop to 0V (in this case 0V means less than 0.1Vdc). The minimum time between tests that the AU shall remain off for is the above time plus one minute.*

* Note: RTCM Paper 236-2011-SC119-158 “Comments on RTCM SC119 MSLD Standard CDV as of 5 December 2011 (RTCM Paper 219-2011-SC119-155)” states:

- *Section F.3.5 Line 15 delete “13 minutes” and replace it with “5 minutes”.*

Hence, TTFF limit is actually 5 minutes.

2.43.6 Test Set-up and Operating Modes

The test was performed with the EUT in the following mode(s): Activate.



Test Set-up – Z501

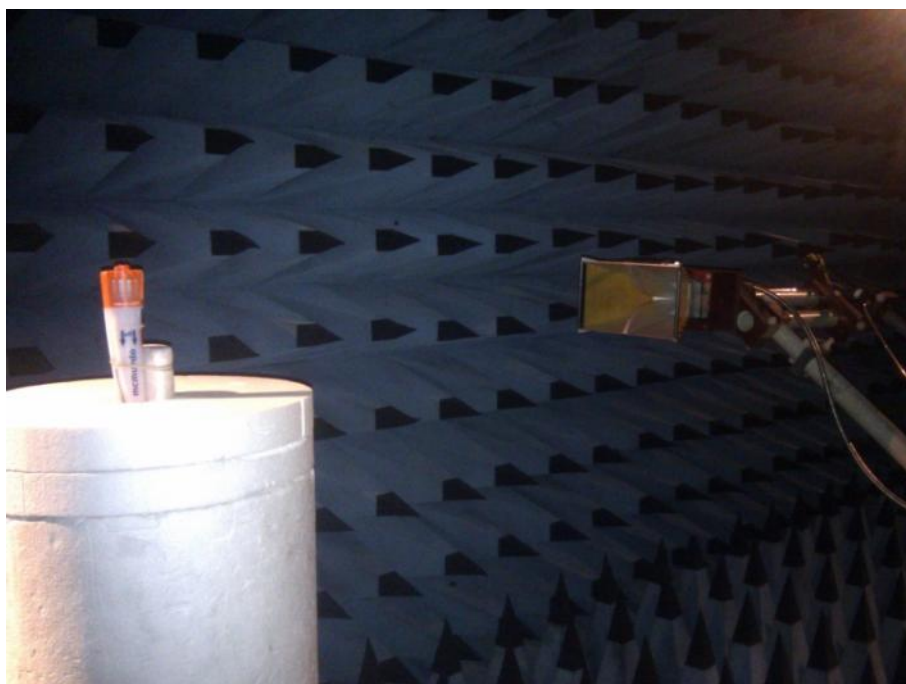

Test Set-up – Z502

Field Calibration

The test is set up as per the following schematic:

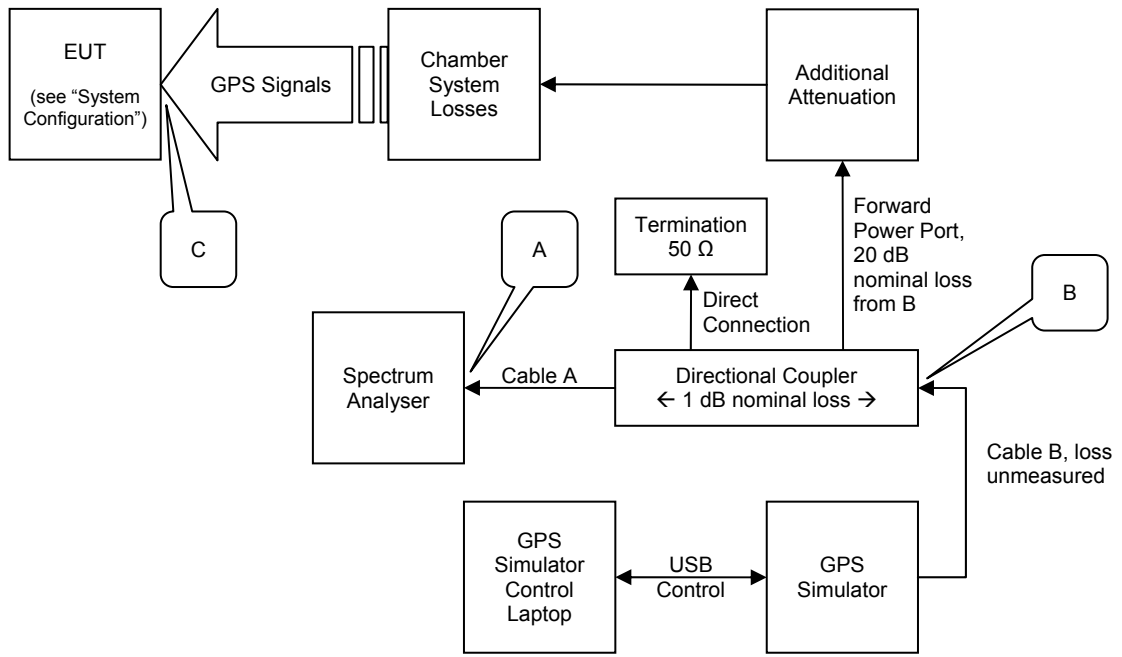

Field Calibration Schematic

The basic premise of the Field Calibration procedure is that power at C equals power at B minus the loss from B to C, where the power measured at B equals the power at A plus the loss B to A.

Resultant Field/RSS is recorded for each test at the test results section, below.



2.43.7 Test Results

Z501 – 08 February 2012

RSS Summary Table:

Scenario #	Number of SVs	Required RSS [dBm]	Actual RSS [dBm]
1	7	-130	-130.19
2	7	-130	-130.17
6*	7	-130	-130.68
7	7	-130	-130.15
8 *	10 *	-130	-130.72
9	7	-130	-130.74
12 *	7 *	-130	-130.65
13 *	7 *	-130	-130.13
14 *	7 *	-130	-130.01
16 *	7 *	-130	-129.93
17 *	7 *	-130	-130.45
18 *	7 *	-130	-130.33
20	7	-130	-130.42
22	7	-130	-130.39
24 *	11 *	-130	-130.79
26 *	11 *	-130	-130.72
28	7	-130	-130.95
30	7	-130	-130.89
32	7	-130	-130.40
33	7	-135	-135.11
34	7	-135	-135.38
35	7	-135	-135.26
36	7	-135	-135.21
37	7	-130	-130.18
38	7	-130	-130.03
39 *	8 *	-130	-130.32

* Note 1: Deviations from the standard: Scenarios 8, 12, 13, 14, 16, 17, 18, 24, 26 and 39 all had more SVs (Satellite Vehicles, i.e. simulated satellites) active than as per Table G.2 of the standard. As the scenarios were designed to test EUT response to pitch/roll and various data corruption, as opposed to poor HDOP, none of the additional SVs was “deactivated”.



Maritime Scenario Results recorded as per table within CDV – RTCM 11901.1 (RTCM Paper 219-2011-SC119-155), Clause F.3.1:

Scenario #	TFFF (min : sec)	Simulator Location	Transmitted Location	Location Error (m)
1	02:15	0° 0' N, 0° 0' E	S 0° 0.0002' E 0° 0.0002'	0.52
2	03:14	0° 0' N, 0° 0' E	N 0° 0.0001' E 0° 0.0001'	0.26
6**	02:14	0° 0' N, 0° 0' E **	N 79° 59.999' W 0° 0.0008'	1.86
7	03:15	0° 0' N, 0° 0' E	N 0° 0' W 0° 0.0007'	1.30
8	03:14	0° 0' N, 0° 0' E	S 0° 0.0003' E 0° 0'	0.56
9	03:14	0° 0' N, 0° 0' E	N 0° 0' E 0° 0'	0.00
12 ***	02:15	80° 0' N, 0° 0' E	N 79° 59.9999' W 0° 0.0021'	0.47
13	03:14	80° 0' N, 0° 0' E	N 79° 59.9998' W 0° 0.0005'	0.38
14	02:14	80° 0' N, 0° 0' E	N 79° 59.999' W 0° 0.0014'	1.87
16	02:14	80° 0' N, 0° 0' E	N 79° 59.9996' W 0° 0.0029'	0.95
17	02:14	80° 0' N, 0° 0' E	N 79° 59.9997' W 0° 0.0002'	0.56
18	03:14	80° 0' N, 0° 0' E	N 79° 59.9999' E 0° 0.001'	0.28
20	02:14	0° 0' N, 0° 0' E	N 0° 0.0002' E 0° 0.0021'	3.91
22	02:15	0° 0' N, 0° 0' E	N 0° 0' E 0° 0'	0.00
24	01:15	0° 0' N, 0° 0' E	S 0° 0.0018' E 0° 0.0025'	5.71
26	02:14	0° 0' N, 0° 0' E	S 0° 0.0001' E 0° 0.0001'	0.26
28	05:14	0° 0' N, 0° 0' E	N 0° 0.0001' E 0° 0'	0.19
30	03:14	0° 0' N, 0° 0' E	S 0° 0.0013' W 0° 0.0002'	2.43
32	04:14	0° 0' N, 0° 0' E	S 0° 0.0002' E 0° 0.0002'	0.52
33	Fail	0° 0' N, 0° 0' E	N/A	N/A
34	Fail	0° 0' N, 0° 0' E	N/A	N/A
35	Fail	0° 0' N, 0° 0' E	N/A	N/A
36	Fail	0° 0' N, 0° 0' E	N/A	N/A
37 **	03:15	44° 0' S, 175° 0' E **	S 44° 3.0001' E 174° 9'	0.19
38 **	01:14	47° 0' N, 8° 0' E **	N 47° 21.0004' W 8° 27.0123'	22.25
39	02:14	0° 0' N, 0° 0' E	N 0° 0' E 0° 0.0001'	0.19

** Note 2: Deviations from the standard: Scenarios 6, 37 and 38, supplied by Spirent Communications as per the standard, were not set with the correct position. All other parameters were correct. The actual simulated position was used to determine the position error, not the intended simulated position. Scenarios 37 and 38 also appeared to have pitch/roll of approximately 15° at a rate of approximately 5°/s whereas the standard specifies none.

*** Note 3: Scenario 12 also did not have any apparent pitch or roll whereas the standard specifies 15° at a rate of 60°/s.



Product Service

Maritime Scenarios Results Analysis:

Criteria	Limit / Condition	Result
No of Successful Tests	TTFF \leq 5 minutes	21
Total No of Maritime Scenarios	26	N/A
TTFF Percentage Success Rate	$(\text{No Success Tests} / 26) \times 100$	80.8 %
TTFF Pass / Fail Limit	$\geq 70\%$	N/A
No of Locations with Errors	≤ 30 m	22
No of Scenarios with Locations	Enter result	22
Location Accuracy Percentage Pass Rate	$(\text{No Locations Errors} \leq 30 \text{ m} / \text{No Scenarios with Location}) \times 100$	100 %
Location Accuracy Pass / Fail Limit	$\geq 70\%$	N/A

Pass/Fail Analysis:

	EUT Pass / Fail
Maritime TTFF Success Rate $\geq 70\%$	Pass
Maritime Location Accuracy Pass Rate $\geq 70\%$	Pass
Both results must be a "Pass" for the AU to pass, any one or more "Fails" indicates failure	



Z502 – 16 January 2012

RSS Summary Table:

Scenario #	Number of SVs	Required RSS [dBm]	Actual RSS [dBm]
1	7	-130	-130.42
2	7	-130	-132.35
6*	7	-130	-131.13
7	7	-130	-130.83
8 *	10 *	-130	-131.37
9	7	-130	-131.75
12 *	7 *	-130	-131.19
13 *	7 *	-130	-130.84
14 *	7 *	-130	-131.46
16 *	7 *	-130	-131.57
17 *	7 *	-130	-131.24
18 *	7 *	-130	-131.65
20	7	-130	-131.39
22	7	-130	-131.38
24 *	11 *	-130	-131.20
26 *	11 *	-130	-130.26
28	7	-130	-130.73
30	7	-130	-130.77
32	7	-130	-131.01
33	7	-135	-135.14
34	7	-135	-135.99
35	7	-135	-135.98
36	7	-135	-135.98
37	7	-130	-130.81
38	7	-130	-130.09
39 *	8 *	-130	-131.40

* Note 1: Deviations from the standard: Scenarios 8, 12, 13, 14, 16, 17, 18, 24, 26 and 39 all had more SVs (Satellite Vehicles, i.e. simulated satellites) active than as per Table G.2 of the standard. As the scenarios were designed to test EUT response to pitch/roll and various data corruption, as opposed to poor HDOP, none of the additional SVs was “deactivated”.



Maritime Scenario Results recorded as per table within CDV – RTCM 11901.1 (RTCM Paper 219-2011-SC119-155), Clause F.3.1:

Scenario #	TTF (min : sec)	Simulator Location	Transmitted Location	Location Error (m)
1	2:12	0° 0' N, 0° 0' E	N 0° 0' E 0° 0'	0.00
2	5:29	0° 0' N, 0° 0' E	N 0° 0' E 0° 0.0001'	0.19
6**	1:04	0° 0' N, 0° 0' E **	N 80° 0.0001' E 0° 0.0004'	0.20
7	1:15	0° 0' N, 0° 0' E	N 0° 0' W 0° 0.0001'	0.19
8	1:15	0° 0' N, 0° 0' E	S 0° 0.0002' W 0° 0.0026'	4.84
9	1:15	0° 0' N, 0° 0' E	N 0° 0.0001' E 0° 0.0003'	0.59
12 ***	1:14	80° 0' N, 0° 0' E	N 79° 59.9998' W 0° 0.0002'	0.37
13	1:15	80° 0' N, 0° 0' E	N 79° 59.9999' E 0° 0.0005'	0.21
14	1:15	80° 0' N, 0° 0' E	N 79° 59.9996' E 0° 0.0022'	0.87
16	1:14	80° 0' N, 0° 0' E	N 80° 0' W 0° 0.0008'	0.16
17	1:15	80° 0' N, 0° 0' E	N 79° 59.9999' W 0° 0.0003'	0.19
18	1:14	80° 0' N, 0° 0' E	N 79° 59.9999' E 0° 0.0014'	0.34
20	1:15	0° 0' N, 0° 0' E	S 0° 0.0001' W 0° 0.0002'	0.41
22	2:15	0° 0' N, 0° 0' E	N 0° 0' E 0° 0'	0.00
24	1:15	0° 0' N, 0° 0' E	N 0° 0' E 0° 0'	0.00
26	1:15	0° 0' N, 0° 0' E	N 0° 0' E 0° 0'	0.00
28	1:14	0° 0' N, 0° 0' E	S 0° 0.0002' E 0° 0'	0.37
30	1:14	0° 0' N, 0° 0' E	S 0° 0.0042' W 0° 0.0019'	8.53
32	2:15	0° 0' N, 0° 0' E	S 0° 0.0002' E 0° 0'	0.37
33	2:15	0° 0' N, 0° 0' E	S 0° 0.0002' E 0° 0'	0.37
34	1:15	0° 0' N, 0° 0' E	N 0° 0.0001' E 0° 0.0003'	0.59
35	1:14	0° 0' N, 0° 0' E	S 0° 0.001' W 0° 0.0009'	2.49
36	1:14	0° 0' N, 0° 0' E	N 0° 0' E 0° 0.0011'	2.04
37 **	1:15	44° 0' S, 175° 0' E **	S 44° 3.0003' E 174° 9'	0.56
38 **	1:15	47° 0' N, 8° 0' E **	N 47° 20.9999' W 8° 26.9999'	0.26
39	1:16	0° 0' N, 0° 0' E	N 0° 0' E 0° 0'	0.00

** Note 2: Deviations from the standard: Scenarios 6, 37 and 38, supplied by Spirent Communications as per the standard, were not set with the correct position. All other parameters were correct. The actual simulated position was used to determine the position error, not the intended simulated position. Scenarios 37 and 38 also appeared to have pitch/roll of approximately 15° at a rate of approximately 5°/s whereas the standard specifies none.

*** Note 3: Scenario 12 also did not have any apparent pitch or roll whereas the standard specifies 15° at a rate of 60°/s.



Product Service

Maritime Scenarios Results Analysis:

Criteria	Limit / Condition	Result
No of Successful Tests	TTFF \leq 5 minutes	25
Total No of Maritime Scenarios	26	N/A
TTFF Percentage Success Rate	$(\text{No Success Tests} / 26) \times 100$	96.2 %
TTFF Pass / Fail Limit	$\geq 70\%$	N/A
No of Locations with Errors	≤ 30 m	22
No of Scenarios with Locations	Enter result	22
Location Accuracy Percentage Pass Rate	$(\text{No Locations Errors} \leq 30 \text{ m} / \text{No Scenarios with Location}) \times 100$	100 %
Location Accuracy Pass / Fail Limit	$\geq 70\%$	N/A

Pass/Fail Analysis:

	EUT Pass / Fail
Maritime TTFF Success Rate $\geq 70\%$	Pass
Maritime Location Accuracy Pass Rate $\geq 70\%$	Pass
Both results must be a "Pass" for the AU to pass, any one or more "Fails" indicates failure	



Product Service

SECTION 3

TEST EQUIPMENT USED



3.1 TEST EQUIPMENT USED

List of absolute measuring and other principal items of test equipment.

Instrument	Manufacturer	Type No.	TE No.	Calibration Period (months)	Calibration Due
Section 2.4- 2.8 Climatic – Dry Heat, Damp Heat and Low Temperature					
Montford F43	Montford	4FT CUBED	2126	12	1-Jun-2012
Section 2.9 Climatic - Thermal Shock					
Stopwatch	Farnell	SUPER LAB/SPLIT	2465	12	31-Aug-2011
Climatic Chamber	Climatec	WALK-IN	2847	12	23-May-2012
Climatic Chamber	Climatec	Drive-In	2848	12	15-Mar-2012
5 m tape measure	Stanley	Fatmax 5 m	3712	-	TU
Section 2.10 ENV - Free Fall Drop					
Hardwood Block	Unknown	ELM	2650	-	TU
5 m tape measure	Stanley	Fatmax 5 m	3712	-	TU
Section 2.11 Beacons – 20m Drop into Water					
Bomb release	MOD	1000kg	N/S	-	TU
Section 2.12Vibration - Sine					
Vibrator	Derritron	VP400	2286	6	2-Dec-2011
Isotron Accelerometer	Endevco	256-10	3377	6	7-Jan-2012
Isotron Accelerometer	Endevco	256-10	3392	6	6-Jan-2012
Vibration & Shock Controller	Muller & Partner	VibPilot VP8	3730	12	26-Aug-2011
Isotron Accelerometer	Endevco	256-10	3789	6	15-Jan-2012
Section 2.13 and 2.14 Climatic - Immersion					
Over Pressure (T)	ASL (TUV)	0 TO 15 PSI	2125	-	TU
Balance	Geniweigher	GM-11K	2334	12	14-Mar-2012
Data Logging Thermometer	Digitron	2098T	2348	12	26-Oct-2011
Pressure Indicator	Druck	DPI 700	2458	12	26-Nov-2011
Hygrometer	Rotronic	A1	3027	12	17-Aug-2011
Thermocouple	Unknown	Type T Thermocouple	3415	24	24-Feb-2013
Digital Pressure Gauge	Druck	DPI 700	2342	12	18-Aug-2011
Stopwatch	Farnell	SUPER LAB/SPLIT	2465	12	31-Aug-2011
Section 2.21, 2.24 and 2.25 – Water Tests					
Over Pressure (T)	ASL (TUV)	0 TO 15 PSI	2125	-	TU
Temperature Chamber	Instron	906	2128	12	17-Oct-2012
Balance	Geniweigher	GM-11K	2334	12	14-Mar-2012
Hygrometer	Rotronic	HYGROPALM 1	2338	12	16-Feb-2012
Digital Pressure Gauge	Druck	DPI 700	2342	12	18-Aug-2011
Data Logging Thermometer	Digitron	2098T	2348	12	26-Oct-2011
Stopwatch	Farnell	SUPER LAB/SPLIT	2465	12	31-Aug-2011
Stop Watch	Acctim	Timer	2466	12	17-Aug-2012
Temperature Logger	Digitron	2098T	2479	12	19-Oct-2012
Water Spray Head	Pipework & Eng Serv	BS EN 60529	2590	24	30-Aug-2013
Thermocouple	Unknown	Type T Thermocouple	3415	24	24-Feb-2013
5 m tape measure	Stanley	Fatmax 5 m	3712	-	TU
Section 2.28 - Magnetic Emissions (Spurious Out of Band Emissions)					
Antenna (Active Loop, 9kHz-30MHz)	Rohde & Schwarz	HFH2-Z2	333	24	20-Sep-2012
Screened Room (5)	Rainford	Rainford	1545	36	3-Feb-2014
Mast Controller	Inn-Co GmbH	CO 1000	1606	-	TU
Test Receiver	Rohde & Schwarz	ESIB26	2085	12	9-Dec-2012
Section 2.28 - Radiated Emissions (Spurious Out of Band Emissions)					
Screened Room (5)	Rainford	Rainford	1545	36	3-Feb-2014
Mast Controller	Inn-Co GmbH	CO 1000	1606	-	TU
Antenna (Bilog)	Chase	CBL6143	2904	24	12-May-2013
EMI Test Receiver	Rohde & Schwarz	ESU40	3506	12	29-Sep-2012
Tilt Antenna Mast	matur GmbH	TAM 4.0-P	3916	-	TU
Mast Controller	matur GmbH	NCD	3917	-	TU



Product Service

Instrument	Manufacturer	Type No.	TE No.	Calibration Period (months)	Calibration Due
Section 2.34 - Frequency Error					
Counter	Hewlett Packard	53181A	159	12	25-May-2011
Counter	Hewlett Packard	53181A	159	12	26-May-2012*
Multimeter	White Gold	WG022	190	12	26-Oct-2011
GPS Frequency Standard	Rapco	GPS-804/3	1312	6	11-Sep-2011
Power Supply	Iso-tech	IPS 2010	2439	-	O/P Mon
Hygrometer	Rotronic	I-1000	2891	12	3-May-2012
Attenuator (30dB, 150W)	Narda	769-30	3369	12	24-May-2011
Attenuator (30dB, 150W)	Narda	769-30	3369	12	24-May-2012*
Section 2.35 – Conducted Power					
Spectrum Analyser	Rohde & Schwarz	FSEM	37	12	18-Apr-2012
Directional Coupler	Narda	4242-20	57	-	TU
Multimeter	White Gold	WG022	190	12	26-Oct-2011
GPS Frequency Standard	Rapco	GPS-804/3	1312	6	11-Sep-2011
Power Supply	Iso-tech	IPS 2010	2439	-	O/P Mon
Hygrometer	Rotronic	I-1000	2891	12	3-May-2012
Attenuator (30dB, 150W)	Narda	769-30	3369	12	24-May-2012
Section 2.37 - Modulation Spectrum Slotted Transmission					
Spectrum Analyser	Rohde & Schwarz	FSEM	37	12	18-Apr-2012
Signal Generator	Marconi	2031	53	12	28-Feb-2012
Multimeter	White Gold	WG022	190	12	26-Oct-2011
GPS Frequency Standard	Rapco	GPS-804/3	1312	6	11-Sep-2011
Power Supply	Iso-tech	IPS 2010	2439	-	O/P Mon
Hygrometer	Rotronic	I-1000	2891	12	3-May-2012
Attenuator (30dB, 150W)	Narda	769-30	3369	12	24-May-2011
Section 2.38 – Transmitter Test Sequence and Modulation Accuracy					
Climatic Chamber	Votsch	VT4002	161	-	O/P Mon
GPS Frequency Standard	Rapco	GPS-804/3	1312	6	11-Sep-2011
Multimeter	Iso-tech	IDM101	2424	12	3-Sep-2011
Power Supply	Iso-tech	IPS 2010	2439	-	O/P Mon
Hygrometer	Rotronic	I-1000	2891	12	3-May-2012
Attenuator (30dB/50W)	Aeroflex / Weinschel	47-30-34	3164	12	1-Dec-2011
Thermocouple Thermometer	Fluke	51	3174	12	31-Aug-2011
Signal Analyser	Rohde & Schwarz	FSQ 26	3545	12	23-Feb-2012
Section 2.39 - Transmitter Output Power versus Time Function					
Spectrum Analyser	Rohde & Schwarz	FSEM	37	12	18-Apr-2012
Signal Generator	Marconi	2031	53	12	28-Feb-2012
Multimeter	White Gold	WG022	190	12	26-Oct-2011
GPS Frequency Standard	Rapco	GPS-804/3	1312	6	11-Sep-2011
Power Supply	Iso-tech	IPS 2010	2439	-	O/P Mon
Hygrometer	Rotronic	I-1000	2891	12	3-May-2012
Attenuator (30dB, 150W)	Narda	769-30	3369	12	24-May-2011

*Re-calibrated between test dates.



Product Service

Instrument	Manufacturer	Type No.	TE No.	Calibration Period (months)	Calibration Due
Section 2.40 - Spurious Emissions from the Transmitter					
Signal Generator	Marconi	2031	53	12	28-Feb-2012
Multimeter	White Gold	WG022	190	12	26-Oct-2011
Attenuator (30dB, 50W)	Bird	8321	494	12	22-Mar-2012
GPS Frequency Standard	Rapco	GPS-804/3	1312	6	11-Sep-2011
Attenuator (10dB, 10W)	Trilithic	HFP-50N	1377	12	13-Oct-2011
High Pass Filter	Mini-Circuits	NHP-300	1640	12	12-Aug-2011
Power Supply	Iso-tech	IPS 2010	2439	-	O/P Mon
Spectrum Analyser	Rohde & Schwarz	FSU26	2747	12	12-Nov-2011
Hygrometer	Rotronic	I-1000	2891	12	3-May-2012
ESA-E Series Spectrum Analyser	Agilent	E4402B	3348	12	2-Jun-2011
Attenuator (30dB, 150W)	Narda	769-30	3369	12	24-May-2011
Tunable Notch Filter	Wainwright	WRCD 130.0/170.0- 0.05/50-5EEK	3412	-	TU
Network Analyser	Rohde & Schwarz	ZVA 40	3548	12	8-Feb-2012
Section 2.42 - Scenarios					
Antenna (Double Ridge Guide)	EMCO	3115	34	12	22-Jul-2012
Spectrum Analyser	Rohde & Schwarz	FSEM	37	12	18-Apr-2012
Power Supply Unit	Farnell	LT-30-2	41	-	O/P Mon
Power Meter	Hewlett Packard	436A	94	12	12-Oct-2012
3dB/10W Attenuator	Texscan	HFP-50N	475	12	24-Mar-2012
GPS Frequency Standard	Rapco	GPS-804/3	1312	6	13-Mar-2012
Power Sensor	Hewlett Packard	8481A	1338	12	20-Dec-2012
Directional Coupler	Hewlett Packard	778D	1401	12	7-Feb-2012
Screened Room (8)	Rainford	Rainford	1548	-	TU
Multimeter	Iso-tech	IDM101	2421	12	26-Oct-2012
Programmable Power Supply	Iso-tech	IPS 2010	2437	-	O/P Mon
Power Supply	Iso-tech	IPS 2010	2439	-	O/P Mon
Hygrometer	Rotronic	I-1000	2882	12	5-Aug-2012
GPS/SBAS Simulator	Spirent	STR4500	3056	-	TU
Termination (50ohm, 15W)	Diamond Antenna	DL-30N	3097	12	11-May-2012
Power Sensor	Agilent	8482A	3290	12	6-Jan-2013
ESA-E Series Spectrum Analyser	Agilent	E4402B	3348	12	6-Jun-2012
Cable (3m, N-type)	Rhophase	NPS-1601-3000- NPS	3361	12	20-Apr-2012
Signal Generator: 10MHz to 20GHz	Rohde & Schwarz	SMR20	3475	12	20-Dec-2012
DC - 4 GHz Attenuator	Narda	766F-3	3962	12	24-Jun

TU – Traceability Unscheduled



Product Service

SECTION 4

PHOTOGRAPHS

4.1 PHOTOGRAPHS OF EQUIPMENT UNDER TEST (EUT)



Equipment under test: Z501



Equipment under test: Z501 – antenna deployed



Equipment under test: Z502



Product Service

SECTION 5

DISCLAIMERS AND COPYRIGHT



Product Service

5.1 DISCLAIMERS AND COPYRIGHT

This report relates only to the actual item/items tested.

This report must not be reproduced, except in its entirety, without the written permission of
TÜV SÜD Product Service Limited

© 2012 TÜV SÜD Product Service Limited



Product Service

ANNEX A

CUSTOMER SUPPLIED INFORMATION



Product Service

COMMERCIAL IN CONFIDENCE

mcmurdo
EMERGENCY LOCATION BEACONS

Z501 Materials Declaration

As required by IEC 61097-14 & IEC 60945; the McMurdo Ltd Z501 product is required to be tested and to meet the specific tests -

- Corrosion (Salt Mist) IEC 60945 8.12 & IEC 61097-14 6.1
- Solar Radiation IEC 60945 8.10 & IEC 61097-14 6.1
- Oil Resistance IEC 60945 8.11 & IEC 61097-14 6.1

IEC 60945 stipulates that where a manufacturer can produce evidence that the components, materials and finishes employed in the equipment would satisfy the tests then the tests shall be waived.

In this instance McMurdo Ltd claim, for the one or more of the reasons listed below that these criteria are met and therefore make application that the tests be waived.

1. The materials have a proven history of service in a marine environment. Either from use in McMurdo's existing approved marine equipment range, or by implication from a long established history of exposure without effect (e.g. stainless steel).
2. The material manufacturer has conducted equivalent testing and has declared the product as being immune to these effects in the relevant data sheet.
3. McMurdo in-house testing has proven the materials to be immune to the cause of degradation (e.g. oil resistance).

McMurdo Ltd hereby declares that the materials used in the construction of the Z501 product as here-in listed are not affected by the degrading agents listed above.

Signed on behalf of McMurdo Ltd

Date25-7-2011.....

Neil Jordan
Engineering Manager

McMurdo Ltd.
Registered in England No. 06952856
Registered Office: Silver Point, Airport Service Road, Portsmouth PO3 5PB
VAT NO GB 980 2079 17

Page 1 of 2



Product Service

COMMERCIAL IN CONFIDENCE

mcmurdo
EMERGENCY LOCATION BEACONS

Components and materials listed below are in contact with the marine environment

BATTERY MOULDING	CALIBRE 303-15
TOP MOULDING	CYCOLOY C1200
ORAL TUBE BRACKETS	CYCOLOY C1200
WEBBING STRAP BRACKET	CYCOLOY C1200
BATTERY LABEL	POLYESTER
CORNER MOULDING	CYCOLOY C1200
ARMING TAB	CYCOLOY C1200
MAIN SEALING GASKET	SILICONE FOAM
KEYPAD	SILICONE RUBBER
ANTENNA	STAINLESS STEEL SUS-301 S/S
ANTENNA BOLT	STAINLESS STEEL SUS-316
ANTENNA O-RING	BS005 N70 SILICONE O-RING
LABEL SET	CLEAR POLYPROPYLENE
M3X12MM PAN HEAD POZI STAINLESS STEEL SCREW	STAINLESS STEEL
M2.5 NYLOC NUT	STAINLESS STEEL

McMurdo Ltd.
Registered in England No. 06952856
Registered Office: Silver Point, Airport Service Road, Portsmouth PO3 5PB
VAT NO GB 980 2079 17

Page 2 of 2



Product Service

COMMERCIAL IN CONFIDENCE

mcmurdo
EMERGENCY LOCATION BEACONS

Z502 Materials Declaration

As required by IEC 61097-14 & IEC 60945; the McMurdo Ltd Z502 product is required to be tested and to meet the specific tests -

- Corrosion (Salt Mist) IEC 60945 8.12 & IEC 61097-14 6.1
- Solar Radiation IEC 60945 8.10 & IEC 61097-14 6.1
- Oil Resistance IEC 60945 8.11 & IEC 61097-14 6.1

IEC 60945 stipulates that where a manufacturer can produce evidence that the components, materials and finishes employed in the equipment would satisfy the tests then the tests shall be waived.

In this instance McMurdo Ltd claim, for the one or more of the reasons listed below that these criteria are met and therefore make application that the tests be waived.

1. The materials have a proven history of service in a marine environment. Either from use in McMurdo's existing approved marine equipment range, or by implication from a long established history of exposure without effect (e.g. stainless steel).
2. The material manufacturer has conducted equivalent testing and has declared the product as being immune to these effects in the relevant data sheet.
3. McMurdo in-house testing has proven the materials to be immune to the cause of degradation (e.g. oil resistance).

McMurdo Ltd hereby declares that the materials used in the construction of the Z502 product as here-in listed are not affected by the degrading agents listed above.

Signed on behalf of McMurdo Ltd

Date25-7-2011.....

Neil Jordan
Engineering Manager

McMurdo Ltd.
Registered in England No. 06952856
Registered Office: Silver Point, Airport Service Road, Portsmouth PO3 5PB
VAT NO GB 980 2079 17

Page 1 of 2



Product Service

COMMERCIAL IN CONFIDENCE

mcmurdo
EMERGENCY LOCATION BEACONS

Components and materials listed below are in contact with the marine environment

SWITCH RING MOULDING	CYCOLOY C1200
TOP MOULDING	CALIBRE 303-15
END CAP	CALIBRE 303-15
ANTENNA O-RING	BS025 SILICONE O-RING
LABEL SET	CLEAR POLYPROPYLENE
TORSION SPRING	STAINLESS STEEL SUS-316
M3.5x14mm TORX HEAD SCREW	STAINLESS STEEL

McMurdo Ltd.
Registered in England No. 06952856
Registered Office: Silver Point, Airport Service Road, Portsmouth PO3 5PB
VAT NO GB 980 2079 17

Page 2 of 2



Z501 & Z502 Statement on self-test routine

Z501 Self-test routine

The Z501 has two test routines that work over the temperature range -20°C to +55°C.

The first is a short self-test to confirm that the RF power level, battery status and GPS NMEA sentence present. The short self-test is accessed as follows: press the Test button for 1 second and release; self-test then operates as follows.

- a) Power up the micro-controller, and the GPS module.
- b) Generate a 33ms burst. Check the antenna RF level is above threshold. (This also confirms the battery is capable of high current loads).
- c) Confirm the GPS receiver has output normal NMEA sentences. (do not wait for a fix).

The self-test completes within 5s. If all of the above checks prove true then the white LED will flash three times.

Long self-test to confirm that the RF power level, battery status and valid GNSS fix acquired. The long self-test is accessed as follows: press the Test button for 10 seconds and release; self-test then operates as follows.

- a) Power up the micro-controller, and the GPS module.
- b) Confirm the GPS receiver has output a valid GNSS fix.
- c) Generate a full Transmission burst. Check the antenna RF level is above threshold. (This also confirms the battery is capable of high current loads).

The self-test completes within 1minute. If all of the above checks prove true then the white LED will flash three times.

Z502 Self-test routine

The Z502 has two test routines that work over the temperature range -20°C to +55°C.

Short self-test: Confirms that the RF power level, battery status and GPS NMEA sentence present. The short self-test is accessed as follows: Rotate the end cap fully anti-clockwise, hold for 1 second and release; self-test then operates as follows.

- a) Power up the micro-controller, and the GPS module.
- b) Generate a 33ms burst. Check the antenna RF level is above threshold. (This also confirms the battery is capable of high current loads).
- c) Confirm the GPS receiver has output normal NMEA sentences. (do not wait for a fix).

The self-test completes within 5s. If all of the above checks prove true then the white LED will flash three times.



Product Service

mcmurdo
EMERGENCY LOCATION BEACONS

Long self-test: Confirms that the RF power level, battery status and valid GNSS fix acquired. The long self-test is accessed as follows: Rotate the end cap fully anti-clockwise, hold for 10 second and release; self-test then operates as follows.

- a) Power up the micro-controller, and the GPS module.
- b) Confirm the GPS receiver has output a valid GNSS fix.
- c) Generate a full Transmission burst. Check the antenna RF level is above threshold. (This also confirms the battery is capable of high current loads).

The self-test completes within 1minute. If all of the above checks prove true then the white LED will flash three times.

Self-test for both Z501 & Z502 may only be re-initiated by deliberate intervention on the part of the user.

Neil Jordan
Engineering Manager
McMurdo Limited
2-2-2012

McMurdo Ltd.
Registered in England No. 06952856 Registered Office: Silver Point, Airport Service Road, Portsmouth PO3 5PB
VAT NO GB 980 2079 17

COMMERCIAL IN CONFIDENCE

RTCM 11901.1 – 8.1.4.2 Controls durability

Z501

As shown in Fig 1 below the mechanism was operated for 500 cycles in the Activation (Live) mode (red activation cap removed) and 500 cycles in the test mode. No degradation was noted in the performance of the mechanism for both modes of operation.

Performance at the end of the test was confirmed with a 'live' life jacket inflation – See Fig 2. The Z501 activated as intended.



Fig 1



Fig 2

Z502

As shown in Fig 3 & 4 below the mechanism was operated for 500 cycles in the Activation (Live) mode and 500 cycles in the test mode. No degradation was noted in the performance of the mechanism for both modes of operation which was confirmed via 'live' activation and inspection as shown in Fig 5 to 7.

ACTIVATION



Fig 3

TEST



Fig 4



Fig 5



Fig 6



Fig 7

Neil Jordan
Engineering Manager
McMurdo Limited
8-2-2012

McMurdo Ltd.
Registered in England No. 06952856 Registered Office: Silver Point, Airport Service Road, Portsmouth PO3 5PB
VAT NO GB 980 2079 17

COMMERCIAL IN CONFIDENCE