

CADDX Controller

Patent Pending - Part #CE2R-AU



Installation Manual Street Smart Security

CE2R-AU (02/03) 4814 (01/03)

Caddx Controller

Location of the control module is the most important determining factor for range and reliability of your Caddx Controller. Select a location that is as centrally located as possible. Keep in mind that your customer will want to control the operation of the garage door from the driveway, and will also expect the use of the remote for alarm On/Off in the area of entry and exit.

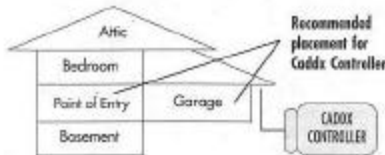

Since the Caddx Controller uses the communication bus wires from the keypad, you may want to place the receiver in or near the garage to easily control the following:

- Easy connection to the garage door push button
- Easy visual LED status mounting location (optional)
- Easy connection to the keypad wires for complete alarm control

Although you can wire at the panel, it may reduce labor by installing the Caddx Controller receiver at the point of entry. In most cases that is the garage which will provide an easy installation for garage door Open/Close, status indicator and alarm controls through the keypad. **DO NOT MOUNT THE CONTROL MODULE IN THE ALARM PANELS METAL ENCLOSURE.**

1

Installation

Red Aux +
Black Aux -
Yellow Keypad Data Line (Connect to Caddx KP DATA)

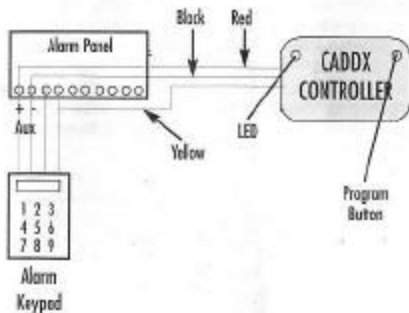

3

Wiring and Auto Recognition

COMPLETE STEPS 1-8

- Step 1) Unplug the receiver from the wire harness.
Step 2) Wire the Red, Black and Yellow to the keypad.

RED Connect to Keypad Red or Aux (+)
BLACK Connect to Keypad Black or Aux (-)
YELLOW For Caddx connect to KP DATA.

NOTE: You can make these connections at the panel or at the keypad itself. If you place the Caddx Controller in the garage or any other location away from the panel you may choose to wire the Caddx Controller directly to the keypad.

- Step 3) Power the panel down and then back up.
Step 4) While watching the LED light on the Control module, plug the receiver into the Caddx Controller harness.
Step 5) The LED will blink 1 time on power up, after 2 seconds COUNT the flashes that you see. The corresponding flashes will indicate which panel the Caddx Controller has detected.

4

Wiring Diagram

Yellow	Connect to yellow of keypad (Caddx connect to KP DATA)
Gray	(-) Channel 2 Timed Output
Red/White	Channel 2 N/O relay (Garage Door Pushbutton)
White	Channel 2 Common (Garage Door Pushbutton)
Brown	Channel 3 Common (Samp)
Brown/White	Channel 3 N/O (Samp)
Blue/Green	Channel 3 N/C (Samp)
Red	+12VDC
Black	(-) Ground
Purple	LED (-) Output (optional)

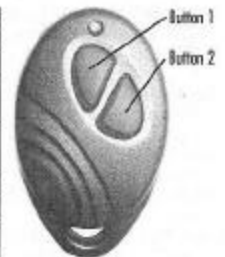

Button 1 Alarm ON/OFF/STAY**
Button 2 Garage Door OPEN/CLOSE
Both PANIC OUTPUT
Held for 3 seconds:
RELAY OUTPUT
Press and Release

**Press and hold for 3 seconds to activate "STAY" or "BYPASS" mode

2

Automatic Recognition Continued:

Number of Flashes:	Alarm Panel detected by the CE II
1	No Alarm connected (CE II defaults to relay mode) SEE PAGE 15 "Default Mode"
2	
3	
4	
5	
6	Caddx IX4, IX6, IX8
7	

Go to Mandatory Programming (Steps 6, 7 and 8)

5

Mandatory Programming

Programming a User Code is mandatory when using the Coddex Controller. This gives the Coddex Controller microprocessor a User Code to arm and disarm the panel.

You must use a 4 digit code ONLY. The CEII will not operate properly if you teach it a 3 or 5 digit user code.

- Step 6)** Verify that the four-digit code you plan to teach the Coddex Controller is a valid four-digit user code. Example: From the keypad, use that four-digit code to arm the panel, if the panel arms, that is a good code. If it does not, program that user code into the alarm panel. - The Coddex Controller uses that four-digit code to arm and disarm the panel, thus that code must be valid. **NOTE: If you are using Coddex, you must power the panel down and then back up before step 7.**
- Step 7)** Press and HOLD the program button on the receiver. The light will come ON and stay ON for three seconds then turn OFF. Once the light turns off, RELEASE the program button, the light will begin to flash rapidly.
- Step 8)** From keypad #1, slowly and firmly enter the four-digit user code.

IMPORTANT: Coddex panels must be powered down and then up before Step 7 and you must enter the 4 digit code through keypad #1.

***NOTE:** We recommend using a user code that the customer cannot change. If the user code that is programmed into the Module is changed, the Coddex Controller will not disarm the alarm panel.

6

Channel 2 Outputs

(Every time button #2 is pressed, two outputs happen simultaneously.)

- Output #1** Momentary Contact Closure for Opening and Closing garage door (See Garage Door Interface)
- Output #2** 500ms (-) output for 3 minutes. (See Channel 2 Timed Output)

Garage Door Interface

All garage doors have a well mounted push button that activates the door via a two-wire connection. Make your connection at the push button switch or at the garage door motor where these two wires terminate. The Coddex Controller will interface with this connection by attaching the red/white and white wires from the Code Encryptor II to these two wires. If you choose to connect to the motor, trace the wires from the push button to the motor to determine the proper connection point. Most garage doors (except MDM Crusader models) use terminals #1 and #2. For MDM Crusader models, use terminals #2 and #3.

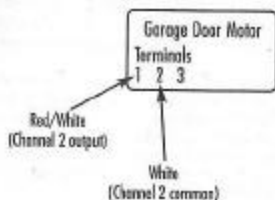

9

Mandatory Programming Continued

- Press and Release button #1 Alarm "Away"
 Press and Release button #1 Alarm "Disarm"
 Press and Hold for 3 seconds Alarm "Stay" or "Bypass"

NOTE: The Coddex Controller will arm in the AWAY mode even if you are outside the house. You do not have to arm the alarm before you exit. We do however recommend that you Arm the alarm system within sight of the status LED or keypad to verify that the alarm has received and responded to your remote request.

LED Wiring (optional)

**DO NOT CONNECT LED DIRECTLY TO GROUND!
 USE ANY 2V LED (not supplied)**

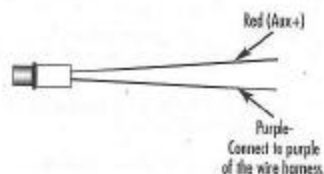

The LED output is a low voltage type and must run through the Coddex Controller. If you attempt to connect the LED directly to ground (-) the LED will burn and will NOT operate again.

Go TO Channel 2 Outputs

7

8

Channel 2 Timed Output

Every time you press button 2 on the Coddex Controller remote the Gray wire sends a 500ms (-) output for 3 minutes.

Application #1 - If you hardwire the garage door you can use this output to trigger a 12VDC relay that will energize when you open or close your garage door extending your entry/exit delay by another 3 minutes. For security you can make the entry delay minimal so if a thief enters through the garage, the entry delay will be short. If the homeowner opens the garage with our Coddex Controller we will extend the entry delay by 3 minutes. If you are using the status output in the garage then you may not need this extra time, as our remote can immediately de-activate the alarm system and you will receive visual indication the alarm is disarmed. **NOTE: If you are using this output see additional programmability on page 20.**

Application #2 - You can use this output to drive entry/exit illumination. Every time the customer enters or exits the house this output can trigger a relay or an X-10 powerflash module to interface with driveway, porch or Motion lighting, illuminating their way as they leave and return home. The output activates automatically when you press button 2 on the Coddex Controller remote and will shut off after 3 minutes. **NOTE: If you are using this output see additional programmability on page 20.**

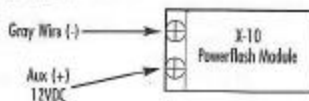

10

Channel 3 Applications

- Press and Release button #3 See Relay Output
 Press and Hold button #3 for seconds See Panic Mode

11

Panic Mode

Press and hold both buttons on the remote control for at least 3 seconds. This will cause the panel to go into a panic mode. Press button 1 (largest button) to disarm the panel.

If you are using a panel that does not have a default setting for keypad panic you must program that option "ON" before our system will operate. Most manufacturers set the keypad Panic as a default setting.

DEACTIVATING THE PANIC FEATURE:

In the event the user does not want to access a panic button through the remote control, it can be de-activated from the Caddx Controller's memory.

- Step 1) Unplug the wire harness from the Caddx Controller.
- Step 2) Press and HOLD the program button.
- Step 3) While HOLDING the program button, plug the Caddx Controller harness back in. The LED light located on the front will turn ON.
- Step 4) Wait until the light turns "OFF".
- Step 5) Once the light has turned "OFF" release the button

12

DEFAULT MODE:

- If the Caddx Controller fails to recognize any of the data coming from the keypad wires, it will automatically default to a relay mode for button #1
- If this happens, verify that you are properly wired to one of the alarms listed on page 5.
- If you have connected the Caddx controller to an alarm it does not recognize, follow the wiring below for a keyswitch mode.
- Program a selected zone as "Keyswitch Arming."
- Do not use the green or yellow wires.

Installation for Keyswitch Arming

- Red Aux +
- Black Aux -
- Brown/White Zone programmed for keyswitch arming
- Brown Common adjacent to zone

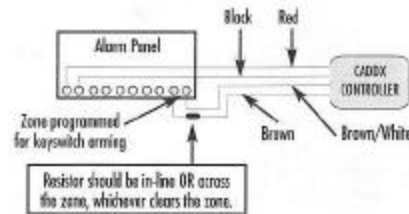

15

Panic Continued

ACTIVATING THE PANIC MODE

NOTE: This is the default setting of the Caddx Controller.

If you have previously programmed remote panic "OFF" and would like to turn it back "ON" follow the steps below. If this is a NEW installation Panic "ON" is the DEFAULT setting for the Caddx Controller.

- Step 1) Unplug the wire harness from the Caddx Controller.
- Step 2) Press and HOLD the program button.
- Step 3) While HOLDING the program button, plug the Caddx Controller harness back in. The LED light located on the front will turn ON.
- Step 4) Immediately release the program button.

IF NECESSARY, PROGRAM THE ALARM PANEL FOR KEYPAD PANIC.

13

To Add or Delete Remotes

TO ADD A NEW REMOTE

METHOD #1

To add a remote to your Caddx Controller, disarm the panel and Enter 78738 from the #1 keypad. The system will arm in the "STAY" mode. Press and release button #1 until the arm system disarms. It should take a total of four presses.

METHOD #2

To add a remote to your Caddx Controller PRESS AND RELEASE the program button on the receiver. The light on the receiver will come ON. Immediately PRESS button 1 on the new remote control THREE TIMES. The light on the receiver should go OFF, indicating the remote has been learned. If the light on the receiver stays ON, the remote has not been learned. Remove and replace the harness, wait 15 seconds while auto recognition occurs and follow these instructions again.

The Caddx Controller can hold up to seven remotes.

14

Caddx Panels

- If a zone is programmed for "HOME/AWAY BYPASS" or AUTO-BYPASS, the alarm will bypass that zone unless an "ENTRY/EXIT" zone is tripped after arming.
- If you wish to have a zone programmed as mentioned above, the CEII can be installed to allow you to arm the panel in the "AWAY" mode from outside the house.

- Step 1) Remove BOTH jumpers from the CEII control module. They are located next to the wire harness.
- Step 2) Connect the Channel 3 wires to the zone programmed for "ENTRY/EXIT". When armed with the Caddx Controller remote, the relay will energize for 1 second, causing the zone to be tripped and arm the alarm in the "AWAY" mode.

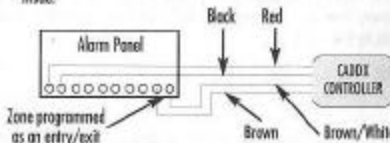

Channel 3 wires offer N/O and N/C contacts. Utilize the wires to open or close the zone based on your installation.

16

To Delete ALL Remotes

METHOD #1

To delete a lost or stolen remote from the Caddx Controller, you must purge the entire memory. This will delete all of the current remotes. You will then have to add them back in one at a time. To purge the memory, disarm the panel. Enter 76278, from the keypad. The keypad on most panels will "beep" or the lights will turn off momentarily to confirm delete. Follow the instructions on page 14 (To Add a New Remote).

METHOD #2

To delete a lost or stolen remote from the Caddx Controller, you must purge the entire memory. This will delete all of the current remotes. You will then have to add them back into memory. To purge, PRESS AND HOLD the program button, the light will come ON for four seconds, then go OFF, and finally it will come ON again, indicating that all the remotes in memory have been purged. Release the program button and follow the instructions on page 14 (To Add a New Remote).

17

troubleshooting

- PROBLEM:** I press Button #1 (largest button) but nothing happens.
- SOLUTION:** 1) Did you teach the Caddy Controller a VALID four-digit user code?
Note: The code you teach the Caddy Controller must be a master code or one of the current user codes.
- 2) Press button #2 (middle button), if you do NOT hear a "click" at the receiver, GO TO PAGE 14 and learn that remote into the Code Encryptor II.
- 3) Power Caddy panel down on back up and go to Step 6-8 on page 6. Enter date from #1 keypad.

- PROBLEM:** I press and hold button #3 (smallest button) and I do not get a panic.
- SOLUTION:** 1) Did you program the panel for keypad panic?

2) To program the Caddy Controller for panic GO TO PAGE 13.

- PROBLEM:** Unit does not seem to identify the panel I am using.
- SOLUTION:** Call technical 888-768-2846.

specifications

- RECEIVER**
- 12VDC Power Input
 - Channels: 1 Data outputs
 - Channel 2 Relay N/O, Comm (1 lamp)
 - Channel 3 selectable: Form C Relay (N/O, N/C, Comm) Sump
This output can be reconfigured from a pulsed output to a latching, 75 second timed or 150 second timed output.
 - Channel 3 - keypad panic data output (Programmable On or Off)
- Frequency** 303MHz
- Stand by Power Consumption** 15ma
- Temperature Range** -5°F to 160°F (Indoor use only)
- REMOTE CONTROL**
- Battery** 12VDC Mini (Part #GP23A) Replace battery at least once a year.
- Range** 150+ feet
- CHANNEL 3 OUTPUT**
- | | |
|--|--|
| Both jumpers in (default) | Momentary output |
| Jumper closest to the harness removed | Latching (on/off) output |
| Jumper farthest from the harness removed | 75sec timed output |
| Both jumpers out | 150sec timed output (not applicable if using the feature on page 16) |

STREET SMART SECURITY TECHNICAL CAN BE REACHED AT:
12925 Brook Printer Place, Suite 410, Poway, CA 92064
M-F 7AM-5PM PST AT (888) 768-2846 OR (619) 513-9352-FAX 19

18

Street Smart Limited Warranty

Street Smart, a Division of Pitney Corporation, and its divisions, subsidiaries and affiliates ("Seller"), 12925 Brook Printer Place, Suite 410 Poway, California 92064, warrants its products to be in conformance with its own plans and specifications and to be free from defects in materials and workmanship under normal use and service for 24 months from the date stamp control on the product or, for products not having a Street Smart date stamp, for 12 months from date of original purchase unless the installation instructions or catalog sets forth a shorter period, in which case the shorter period shall apply. Seller's obligation shall be limited to repairing or replacing, at its option, free of charge for materials or labor, any product which is proved not in compliance with Seller's specifications or proves defective in materials or workmanship under normal use and service. Seller shall have no obligation under this Limited Warranty or otherwise if the product is altered or improperly repaired or serviced by anyone other than Street Smart factory service. For warranty service, return product transportation prepaid, to Street Smart Factory Service, 12925 Brook Printer Place, Ste. 410, Poway, California 92064.

THESE ARE NO WARRANTIES, EXPRESS OR IMPLIED, OF MERCHANTABILITY OR FITNESS FOR A PARTICULAR PURPOSE OR OTHERWISE, WHICH EXTEND BEYOND THE DESCRIPTION ON THE FACE HEREOF. IN NO CASE SHALL SELLER BE LIABLE TO ANYONE FOR ANY CONSEQUENTIAL OR INCIDENTAL DAMAGES FOR BREACH OF THIS OR ANY OTHER WARRANTY, EXPRESS OR IMPLIED, OR UPON ANY OTHER BASIS OR LIABILITY WHATSOEVER, EVEN IF THE LOSS OR DAMAGE IS CAUSED BY THE SELLER'S OWN NEGLIGENCE OR FAULT.

Seller does not represent that the products it sells may not be compromised or discontinued; that the products will prevent any personal injury or property loss by burglary, robbery, fire or otherwise; or that the products will in all cases provide adequate warning or protection. Customer understands that a properly installed and maintained alarm may only reduce the risk of a burglary, robbery, fire or other events occurring without providing an alarm, but it is not insurance or a guarantee that such will not occur or that there will be no personal injury or property loss as a result. CONSEQUENTLY, SELLER SHALL HAVE NO LIABILITY FOR ANY PERSONAL INJURY, PROPERTY DAMAGE OR OTHER LOSSES BASED ON A CLAIM THE PRODUCT FAILED TO GIVE WARNING. HOWEVER, IF SELLER IS HELD LIABLE, WHETHER DIRECTLY OR INDIRECTLY, FOR ANY LOSSES OR DAMAGES ARISING UNDER THIS LIMITED WARRANTY OR OTHERWISE, REGARDLESS OF CAUSE OR ORIGIN, SELLER'S MAXIMUM LIABILITY SHALL NOT IN ANY CASE EXCEED THE PURCHASE PRICE OF THE PRODUCT, WHICH SHALL BE THE COMPLETE AND EXCLUSIVE REMEDY AGAINST SELLER. This warranty replaces any previous warranties and is the only warranty made by Seller on this product. No increase or alteration, written or verbal, of the obligations of this Limited Warranty is authorized.

21

Federal Communications Commission (FCC) Statement

This equipment has been tested to FCC requirements and has been found acceptable for use. The FCC requires the following statement for your information:

This equipment generates and uses radio frequency energy and if not installed and used properly, that is, in strict accordance with the manufacturer's instructions, may cause interference to radio and television reception. It has been type tested and found to comply with the limits for a Class B computing device in accordance with the specifications in Part 15 of FCC Rules, which are designed to provide reasonable protection against such interference in a residential installation. However, there is no guarantee that interference will not occur in a particular installation. If this equipment does cause interference to radio or television reception, which can be determined by turning the equipment off and on, the user is encouraged to try to correct the interference by one or more of the following measures:

- If using an indoor antenna, have a quality outdoor antenna installed.
- Reorient the receiving antenna until interference is reduced or eliminated.
- Move the receiver away from the control/communicator.
- Plug the control/communicator into a different outlet so that it and the receiver are on different branch circuits.

If necessary, the user should consult the dealer or an experienced radio/television technician for additional suggestions.

The user or installer may find the following booklet prepared by the Federal Communications Commission helpful: "Interference Handbook"

This booklet is available from the U.S. Government Printing Office, Washington, DC 20402. The user shall not make any changes or modifications to the equipment unless authorized by the installation instructions or User's Manual. Unauthorized changes or modifications could void the user's authority to operate the equipment.

Optional Reversible Outputs

Channel 2 has two independent outputs that occur when button #2 is pressed. The first output is a momentary relay contact closure which is intended for the use of opening and closing a garage door. This is the primary output and can not be changed or reconfigured. The second output is a (-) 500ma transistor output to provide a zone bypass or illuminated entry/exit.

- If you are not using the relay for Channel 3 you may choose to swap the (-) transistor output for the relay. In this instance you will then have two contact closures every time Button #2 is pressed. The standard momentary contact closure and ALSO a Form C relay that will energize automatically for 3 minutes every time the garage door is opened or closed.

To Swap the transistor and relay outputs.

- Step 1)** While watching the LED on the Caddy Controller receiver press and HOLD button 1 and 3 simultaneously on the remote control until the LED on the Caddy Controller receiver illuminates (approx. 5 seconds)
- Step 2)** To make channel 2 a relay press the program button on the Caddy Controller Receiver TWICE, to make it a transistor output press ONCE (Default setting)
- Step 3)** Wait 10 seconds and the Caddy Controller will automatically reconfigure the outputs.

NOTE: Even if you swap outputs, the Panic button will still operate if you press and HOLD button #3 for three seconds.

20

Canadian Department of Communications (DOC) Statement

NOTICE: The Canadian Department of Communications label identifies certified equipment. This certification means that the equipment meets certain telecommunications network protective, operational and safety requirements. The Department does not guarantee the equipment will operate to the user's satisfaction. Before installing this equipment, users should ensure that it is permissible to be connected to the facilities of the local telecommunications company. The equipment must also be installed using an acceptable method of connection. In some cases, the company's inside wiring associated with a single line individual service may be extended by means of certified connector assembly (telephone extension cord). The customer should be aware that compliance with the above conditions may not prevent degradation of service in some situations.

Repairs to certified equipment should be made by an authorized Canadian maintenance facility designed by the supplier. Any repairs or alterations made by the user to this equipment, or equipment malfunctions, may give the telecommunications company cause to request the user to disconnect the equipment.

Users should ensure for their own protection that the electrical ground connections of the power utility, telephone lines and internal metallic water pipe system, if present, are connected together. This precaution may be particularly important in rural areas.

CAUTION: User should not attempt to make such connections themselves, but should contact the appropriate electric inspection authority, or electrician, as appropriate.

The Load Number (LN) assigned to each terminal device denotes the percentage of the total load to be connected to a telephone loop which is used by the device, to prevent overloading. The termination on a loop may consist of any combination of devices subject only to the requirement that the total of the Load Numbers of all the devices does not exceed 100.

23

22

