



**FCC 47 CFR PART 15 SUBPART C: 2012
ANSI C63.4: 2009**

TEST REPORT

For

Z-Wave Curtain Module Relay Output

Model: ZW4102US

Brand: N/A

Issued to

Vision Automobile Electronics Industrial Co., Ltd

No. 78, Gongye 3rd Rd., Technology Industrial Park, Tainan City 70955,
Taiwan (R.O.C.)

Issued by

Compliance Certification Services Inc.

Tainan Lab.

No.8, Jiucengling, Xinhua Dist., Tainan City 712, Taiwan (R.O.C.)

TEL: (06) 580-2201

FAX: (06) 580-2202

Issued Date: June 30, 2014



Note: This report shall not be reproduced except in full, without the written approval of Compliance Certification Services Inc. This document may be altered or revised by Compliance Certification Services Inc. personnel only, and shall be noted in the revision section of the document.



REVISION HISTORY

| Rev. | Issue Date | Revisions | Effect Page | Revised By |
|-------------|-------------------|------------------|--------------------|-------------------|
| 00 | June 30, 2014 | Initial Issue | ALL | Sunny Chang |
| | | | | |
| | | | | |



TABLE OF CONTENTS

| | |
|--|-----------|
| 1. TEST RESULT CERTIFICATION | 4 |
| 2. EUT DESCRIPTION | 5 |
| 3. TEST METHODOLOGY | 6 |
| 3.1 EUT CONFIGURATION | 6 |
| 3.2 EUT EXERCISE | 6 |
| 3.3 GENERAL TEST PROCEDURES..... | 6 |
| 3.4 FCC PART 15.205 RESTRICTED BANDS OF OPERATIONS | 7 |
| 3.5 DESCRIPTION OF TEST MODES..... | 7 |
| 4. INSTRUMENT CALIBRATION | 8 |
| 4.1 MEASURING INSTRUMENT CALIBRATION | 8 |
| 4.2 MEASUREMENT EQUIPMENT USED | 8 |
| 4.3 MEASUREMENT UNCERTAINTY | 9 |
| 5. FACILITIES AND ACCREDITATIONS | 10 |
| 5.1 FACILITIES | 10 |
| 5.2 EQUIPMENT | 10 |
| 5.3 LABORATORY ACCREDITATIONS LISTING | 10 |
| 5.4 TABLE OF ACCREDITATIONS AND LISTINGS..... | 11 |
| 6. SETUP OF EQUIPMENT UNDER TEST | 12 |
| 6.1 SETUP CONFIGURATION OF EUT | 12 |
| 6.2 SUPPORT EQUIPMENT..... | 12 |
| 7. FCC PART 15.249 REQUIREMENTS | 13 |
| 7.1 20 DB BANDWIDTH..... | 13 |
| 7.2 BAND EDGES MEASUREMENT | 16 |
| 7.3 DUTY CYCLE..... | 17 |
| 7.4 SPURIOUS EMISSION | 20 |
| 7.5 POWERLINE CONDUCTED EMISSIONS | 29 |
| APPENDIX I - PHOTOGRAPHS OF TEST SETUP | 30 |
| APPENDIX II - PHOTOGRAPHS OF EUT | A1 |



1. TEST RESULT CERTIFICATION

| | |
|----------------------|--|
| Product: | Z-Wave Curtain Module Relay Output |
| Model: | ZW4102US |
| Brand: | N/A |
| Applicant: | Vision Automobile Electronics Industrial Co., Ltd No. 78, Gongye 3rd Rd., Technology Industrial Park, Tainan City 70955, Taiwan (R.O.C.) |
| Manufacturer: | Vision Automobile Electronics Industrial Co., Ltd No. 78, Gongye 3rd Rd., Technology Industrial Park, Tainan City 70955, Taiwan (R.O.C.) |
| Tested: | June 18, 2014 ~ June 20, 2014 |

| APPLICABLE STANDARDS | |
|---|-------------------------|
| STANDARD | TEST RESULT |
| FCC 47 CFR Part 15 Subpart C: 2012 ANSI C63.4 : 2009 | No non-compliance noted |

We hereby certify that:

The above equipment was tested by Compliance Certification Services Inc. The test data, data evaluation, test procedures, and equipment configurations shown in this report were made in accordance with the procedures given in ANSI C63.4: 2009 and the energy emitted by the sample EUT tested as described in this report is in compliance with the requirements emission limits of FCC Rules Part 15.107, 15.109,15.207, 15.209 and 15.249.

The test results of this report relate only to the tested sample identified in this report.

Approved by:

Jeter Wu
Assistant Manager

Reviewed by:

Eric Huang
Assistant Section Manager



2. EUT DESCRIPTION

| | |
|----------------------------|------------------------------------|
| Product | Z-Wave Curtain Module Relay Output |
| Model Number | ZW4102US |
| Brand | N/A |
| Received Date | June 13, 2014 |
| Frequency Range | 908.42MHz ± 20KHz |
| Transmit Peak Power | 87.97 dBµV/m |
| Data Rate | 9.6 kbps , 40kbps |
| Number of Channels | 1 Channel |
| Type of Modulation | FSK |
| Power Supply | DC 12V (Powered by Battery) |
| Antenna Type | Wire antenna Gain: -14 dBi |
| Temperature Range | -15°C ~ +60°C |

Remark:

1. Client consigns only one model sample to test (Model Number: **ZW4102US**).
Therefore, the testing Lab. just guarantees the unit, which has been tested.
2. This submittal(s) (test report) is intended for FCC ID: **KFR-ZW4102US** filing to comply with Section 15.107 & 15.109 (FCC Part 15, Subpart B) and Section 15.207, 15.209, 15.249.



3. TEST METHODOLOGY

The tests documented in this report were performed in accordance with ANSI C63.4 and FCC CFR 47 2.1046, 2.1047, 2.1049, 2.1051, 2.1053, 2.1055, 2.1057, 15.207, 15.209 and 15.249.

3.1 EUT CONFIGURATION

The EUT configuration for testing is installed on RF field strength measurement to meet the Commissions requirement and operating in a manner that intends to maximize its emission characteristics in a continuous normal application.

3.2 EUT EXERCISE

The EUT was operated in the engineering mode to fix the TX frequency that was for the purpose of the measurements.

According to its specifications, the EUT must comply with the requirements of the Section 15.107 and 15.109 under the FCC Rules Part 15 Subpart B and Section 15.207, 15.209, 15.249 under the FCC Rules Part 15 Subpart C.

3.3 GENERAL TEST PROCEDURES

Conducted Emissions

The EUT is placed on the turntable, which is 0.8 m above ground plane. According to the requirements in Section 13.1.4.1 of ANSI C63.4 Conducted emissions from the EUT measured in the frequency range between 0.15 MHz and 30MHz using CISPR Quasi-peak and average detector modes.

Radiated Emissions

The EUT is placed on a turn table, which is 0.8 m above ground plane. The turntable shall rotate 360 degrees to determine the position of maximum emission level. EUT is set 3m away from the receiving antenna, which varied from 1m to 4m to find out the highest emission. And also, each emission was to be maximized by changing the polarization of receiving antenna both horizontal and vertical. In order to find out the maximum emissions, exploratory radiated emission measurements were made according to the requirements in Section 13.1.4.1 of ANSI C63.4.



3.4 FCC PART 15.205 RESTRICTED BANDS OF OPERATIONS

1. Except as shown in paragraph (d) of this section, only spurious emissions are permitted in any of the frequency bands listed below:

| MHz | MHz | MHz | GHz |
|----------------------------|---------------------|-----------------|------------------|
| 0.090 - 0.110 | 16.42 - 16.423 | 399.9 - 410 | 4.5 - 5.15 |
| ¹ 0.495 - 0.505 | 16.69475 - 16.69525 | 608 - 614 | 5.35 - 5.46 |
| 2.1735 - 2.1905 | 16.80425 - 16.80475 | 960 - 1240 | 7.25 - 7.75 |
| 4.125 - 4.128 | 25.5 - 25.67 | 1300 - 1427 | 8.025 - 8.5 |
| 4.17725 - 4.17775 | 37.5 - 38.25 | 1435 - 1626.5 | 9.0 - 9.2 |
| 4.20725 - 4.20775 | 73 - 74.6 | 1645.5 - 1646.5 | 9.3 - 9.5 |
| 6.215 - 6.218 | 74.8 - 75.2 | 1660 - 1710 | 10.6 - 12.7 |
| 6.26775 - 6.26825 | 108 - 121.94 | 1718.8 - 1722.2 | 13.25 - 13.4 |
| 6.31175 - 6.31225 | 123 - 138 | 2200 - 2300 | 14.47 - 14.5 |
| 8.291 - 8.294 | 149.9 - 150.05 | 2310 - 2390 | 15.35 - 16.2 |
| 8.362 - 8.366 | 156.52475 - | 2483.5 - 2500 | 17.7 - 21.4 |
| 8.37625 - 8.38675 | 156.52525 | 2655 - 2900 | 22.01 - 23.12 |
| 8.41425 - 8.41475 | 156.7 - 156.9 | 3260 - 3267 | 23.6 - 24.0 |
| 12.29 - 12.293 | 162.0125 - 167.17 | 3332 - 3339 | 31.2 - 31.8 |
| 12.51975 - 12.52025 | 167.72 - 173.2 | 3345.8 - 3358 | 36.43 - 36.5 |
| 12.57675 - 12.57725 | 240 - 285 | 3600 - 4400 | (²) |
| 13.36 - 13.41 | 322 - 335.4 | | |

¹ Until February 1, 1999, this restricted band shall be 0.490-0.510 MHz.

² Above 38.6

2. Except as provided in paragraphs (d) and (e), the field strength of emissions appearing within these frequency bands shall not exceed the limits shown in Section 15.209. At frequencies equal to or less than 1000 MHz, compliance with the limits in Section 15.209 shall be demonstrated using measurement instrumentation employing a CISPR quasi-peak detector. Above 1000 MHz, compliance with the emission limits in Section 15.209 shall be demonstrated based on the average value of the measured emissions. The provisions in Section 15.35 apply to these measurements.

3.5 DESCRIPTION OF TEST MODES

The EUT(**Model: ZW4102US**) had been tested under engineering test mode condition and the EUT staying in continuous transmitting mode.

Note :

- 1) EUT has supported two data rates (4.8kbps; 9.6kbps) which have been investigated during the test, and found the 9.6kbps as the worst case recorded.
- 2) The field strength of spurious emission was measured in the following position: EUT stand-up position (Y axis), lie-down position (X, Z axis). The worst emission was found in s lie-down position (X axis) and the worst case was recorded.



4. INSTRUMENT CALIBRATION

4.1 MEASURING INSTRUMENT CALIBRATION

The measuring equipment, which was utilized in performing the tests documented herein, has been calibrated in accordance with the manufacturer's recommendations for utilizing calibration equipment, which is traceable to recognized national standards.

4.2 MEASUREMENT EQUIPMENT USED

Equipment Used for Emissions Measurement

| Open Area Test Site # 6 | | | | |
|------------------------------------|--------------------------|--------------------|---------------|-----------------|
| Name of Equipment | Manufacturer | Model | Serial Number | Calibration Due |
| TYPE N COAXIAL CABLE | SUHNER | CHA9513 | 6 | DEC. 18, 2014 |
| BI-LOG Antenna | Sunol | JB1 | A070506-2 | SEP. 26, 2014 |
| LOOP ANTENNA | EMCO | 6502 | 8905-2356 | JUN. 10, 2015 |
| Pre-Amplifier | HP | 8447F | NCR | NCR |
| EMI Receiver | R&S | ESVS10 | 833206/012 | JUN. 26, 2015 |
| RF Cable | SUHNER | SUCOFLEX104P EA | 20520/4PEA | NOV. 10, 2014 |
| Horn Antenna | Com-Power | AH-118 | 071032 | DEC. 05, 2014 |
| 3116 Double Ridge Antenna (40G) | ETS-LINDGREN | 3116 | 00078900 | DEC. 27, 2014 |
| Turn Table | Yo Chen | 001 | ----- | N.C.R. |
| Antenna Tower | AR | TP1000A | 309874 | N.C.R. |
| Controller | CT | SC101 | ----- | N.C.R. |
| RF Switch | E-INSTRUMENT TELH LTD | ERS-180A | EC1204141 | N.C.R |
| Power Meter | Anritsu | ML2487A | 6K00003888 | MAY. 20, 2015 |
| Power Sensor | Anritsu | MA2491A | 33265 | MAY. 20, 2015 |
| Temp./Humidity Chamber | K.SON | THS-M1 | 242 | AUG. 08, 2014 |
| DC Power Source | LOKO | DSP-5050 | L1507009282 | N.C.R |
| Spectrum Analyzer | R&S | FSU | 200789 | JUL. 01, 2014 |
| Spectrum Analyzer | R&S | FSEK 30 | 835253/002 | SEP. 28, 2014 |

Remark: Each piece of equipment is scheduled for calibration once a year.



4.3 MEASUREMENT UNCERTAINTY

| Parameter | Uncertainty |
|--|-------------|
| Radiated Emission, 30 to 200 MHz Test Site : OATS-6 | ±3.3456dB |
| Radiated Emission, 200 to 1000 MHz Test Site : OATS-6 | ±2.6828dB |
| Radiated Emission, 1 to 8 GHz | ± 2.6485dB |
| Radiated Emission, 8 to 18 GHz | ± 2.6852dB |
| Radiated Emission, 18 to 26.5 GHz | ± 2.6485dB |
| Radiated Emission, 26 to 40 GHz | ± 3.0295dB |
| Power Line Conducted Emission | ±1.91dB |
| Band Width | 136.49kHz |
| Peak Output Power MU | ±1.904dB |
| Band Edge MU | ±0.302dBuV |
| Channel Separation MU | 361.69Hz |
| Duty Cycle MU | 0.064ms |
| Frequency Stability MU | 0.223kHz |

Uncertainty figures are valid to a confidence level of 95%, k=2



5. FACILITIES AND ACCREDITATIONS

5.1 FACILITIES

All measurement facilities used to collect the measurement data are located at

No.8, Jiucengling, Xinhua Dist., Tainan City 712, Taiwan (R.O.C.)

The sites are constructed in conformance with the requirements of ANSI C63.7:1992, ANSI C63.4 : 2009 and CISPR Publication 22.

5.2 EQUIPMENT

Radiated emissions are measured with one or more of the following types of linearly polarized antennas: tuned dipole, biconical, log periodic, bi-log, and/or ridged waveguide, horn. Spectrum analyzers with pre-selectors and quasi-peak detectors are used to perform radiated measurements.

Conducted emissions are measured with Line Impedance Stabilization Networks and EMI Test Receivers.

Calibrated wideband preamplifiers, coaxial cables, and coaxial attenuators are also used for making measurements.

All receiving equipment conforms to CISPR Publication 16-1, "Radio Interference Measuring Apparatus and Measurement Methods."

5.3 LABORATORY ACCREDITATIONS LISTING

The test facilities used to perform radiated and conducted emissions tests are accredited by Taiwan Accreditation Foundation for the specific scope of accreditation under Lab Code: 1109 to perform Electromagnetic Interference tests according to FCC PART 15 AND CISPR 22 requirements. No part of this report may be used to claim or imply product endorsement by TAF or any agency of the Government. In addition, the test facilities are listed with Federal Communications Commission (registration no: TW-1037).



5.4 TABLE OF ACCREDITATIONS AND LISTINGS

Our laboratories are accredited and approved by the following accreditation body according to ISO/IEC 17025.

| | |
|---------------|-----|
| Taiwan | TAF |
|---------------|-----|

The measuring facility of laboratories has been authorized or registered by the following approval agencies.

| | |
|----------------|-----------------|
| Canada | Industry Canada |
| Germany | TUV NORD |
| Taiwan | BSMI |
| USA | FCC |

Copies of granted accreditation certificates are available for downloading from our web site, <http://www.ccsrf.com>



6. SETUP OF EQUIPMENT UNDER TEST

6.1 SETUP CONFIGURATION OF EUT

See test photographs attached in Appendix I for the actual connections between EUT and support equipment.

6.2 SUPPORT EQUIPMENT

| No. | Product | Manufacturer | Model No. | Certify No. | Signal cable |
|-----|---------|--------------|-----------|-------------|--------------|
| 1 | N/A | --- | --- | --- | --- |

| No. | Signal cable description | |
|-----|--------------------------|-------------------------|
| A | DC Power | Unshielded, 0.2m, 1pcs. |

Remark:

1. All the equipment/cables were placed in the worst-case configuration to maximize the emission during the test.
2. Grounding was established in accordance with the manufacturer's requirements and conditions for the intended use.

6.3 EUT OPERATING CONDITION

RF Setup

1. Set up a whole system as the setup diagram.
2. Turn on power.

**7. FCC PART 15.249 REQUIREMENTS****7.1 20 DB BANDWIDTH****LIMIT**

None; for reporting purposes only.

MEASUREMENT EQUIPMENT USED

| Open Area Test Site # 6 | | | | |
|------------------------------------|--------------------------|--------------------|----------------------|------------------------|
| Name of Equipment | Manufacturer | Model | Serial Number | Calibration Due |
| TYPE N COAXIAL CABLE | SUHNER | CHA9513 | 6 | DEC. 18, 2014 |
| BI-LOG Antenna | Sunol | JB1 | A070506-2 | SEP. 26, 2014 |
| LOOP ANTENNA | EMCO | 6502 | 8905-2356 | JUN. 10, 2015 |
| Pre-Amplifier | HP | 8447F | NCR | NCR |
| EMI Receiver | R&S | ESVS10 | 833206/012 | JUN. 26, 2015 |
| RF Cable | SUHNER | SUCOFLEX104P EA | 20520/4PEA | NOV. 10, 2014 |
| Horn Antenna | Com-Power | AH-118 | 071032 | DEC. 05, 2014 |
| 3116 Double Ridge Antenna (40G) | ETS-LINDGREN | 3116 | 00078900 | DEC. 27, 2014 |
| Turn Table | Yo Chen | 001 | ----- | N.C.R. |
| Antenna Tower | AR | TP1000A | 309874 | N.C.R. |
| Controller | CT | SC101 | ----- | N.C.R. |
| RF Swicth | E-INSTRUMENT TELH LTD | ERS-180A | EC1204141 | N.C.R |
| Power Meter | Anritsu | ML2487A | 6K00003888 | MAY. 20, 2015 |
| Power Sensor | Anritsu | MA2491A | 33265 | MAY. 20, 2015 |
| Temp./Humidity Chamber | K.SON | THS-M1 | 242 | AUG. 08, 2014 |
| DC Power Source | LOKO | DSP-5050 | L1507009282 | N.C.R |
| Spectrum Analyzer | R&S | FSU | 200789 | JUL. 01, 2014 |
| Spectrum Analyzer | R&S | FSEK 30 | 835253/002 | SEP. 28, 2014 |

Remark: Each piece of equipment is scheduled for calibration once a year.



Test Configuration

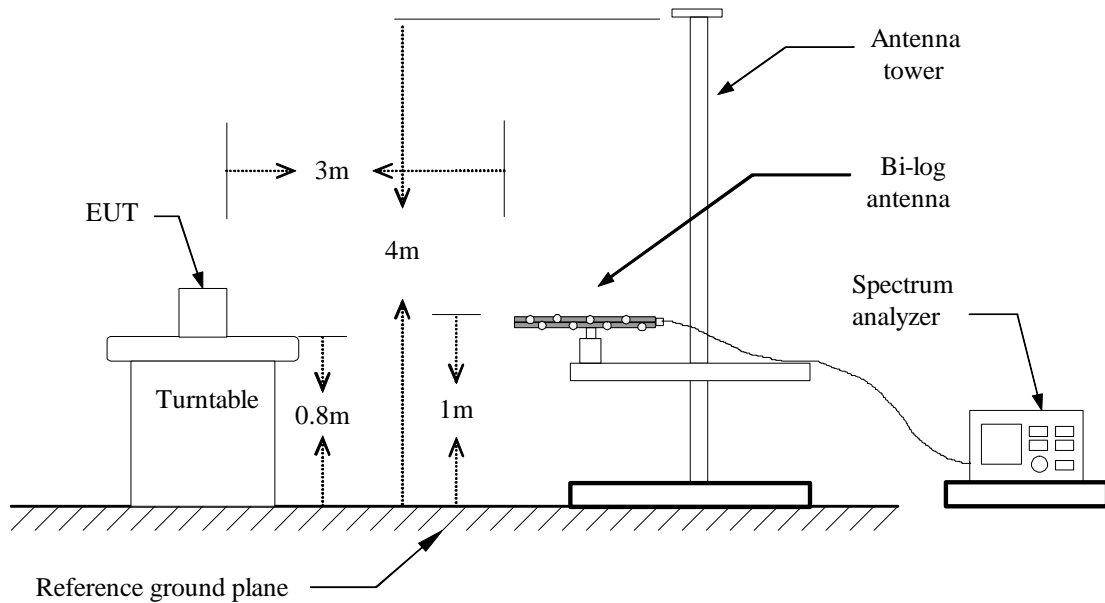

TEST PROCEDURE

1. The EUT is placed on a turntable, which is 0.8m above ground plane.
2. The turntable shall be rotated for 360 degrees to determine the position of maximum emission level.
3. EUT is set 3m away from the receiving antenna, which is varied from 1m to 4m to find out the highest emissions.
4. Maximum procedure was performed on the six highest emissions to ensure EUT compliance.
5. And also, each emission was to be maximized by changing the polarization of receiving antenna both horizontal and vertical.
6. Set the spectrum analyzer in the following setting as:
RBW is set to 10 kHz and VBW is set 300kHz.

TEST RESULTS

No non-compliance noted.

Test Data

| Modulation | Frequency | 20 dB Bandwidth |
|------------|-----------|-----------------|
| | (MHz) | (kHz) |
| 9.6kbps | 908.42 | 182.36 |



Test Plot

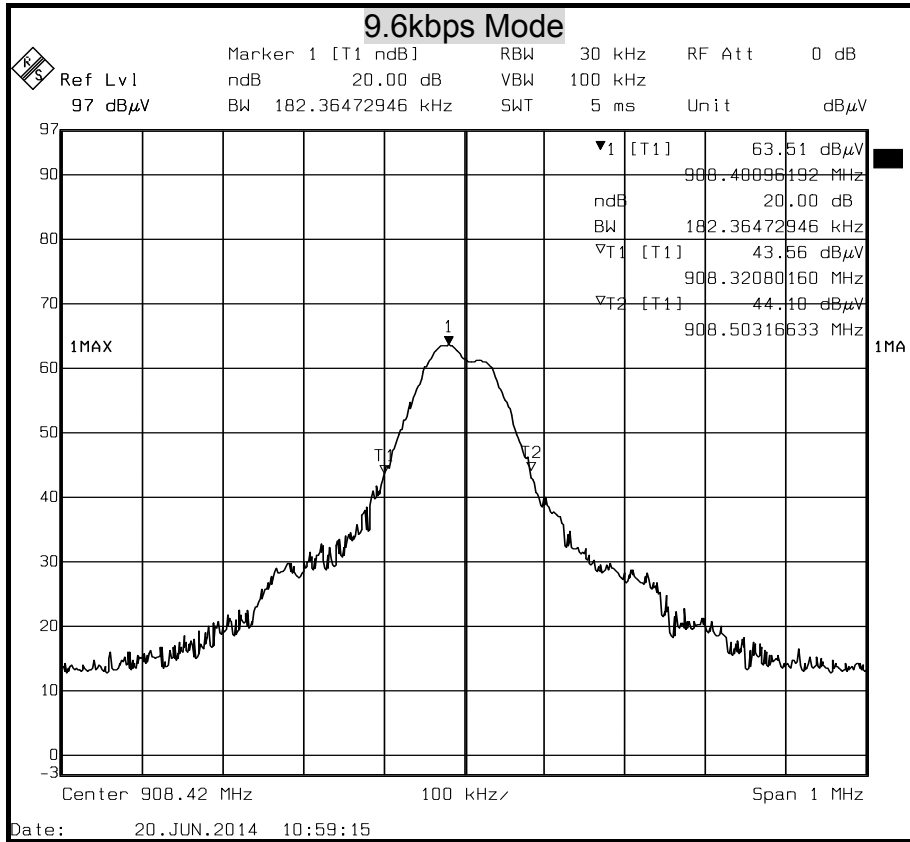



7.2 BAND EDGES MEASUREMENT

LIMIT

1. In the above emission table, the tighter limit applies at the band edges.

| Frequency (MHz) | Field Strength ($\mu\text{V}/\text{m}$ at 3-meter) | Field Strength ($\text{dB}\mu\text{V}/\text{m}$ at 3-meter) |
|-----------------|---|--|
| 30-88 | 100 | 40 |
| 88-216 | 150 | 43.5 |
| 216-960 | 200 | 46 |
| Above 960 | 500 | 54 |

2. As shown in Section 15.35(b), for frequencies above 1000 MHz, the above field strength limits in paragraphs (a) and (b) of this section are based on average limits. However, the peak field strength of any emission shall not exceed the maximum permitted average limits specified above by more than 20 dB under any condition of modulation. For point-to-point operation under paragraph (b) of this section, the peak field strength shall not exceed 2500 millivolts/meter at 3 meters along the antenna azimuth.

TEST CONFIGURATION

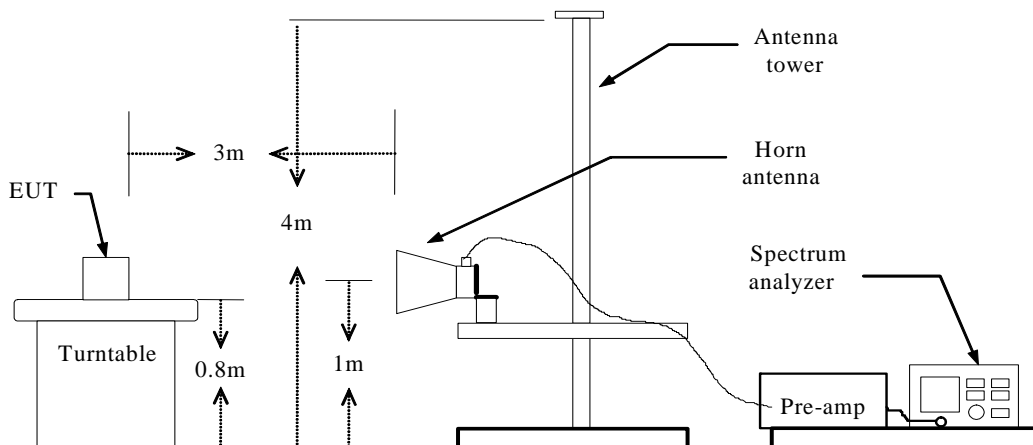

TEST PROCEDURE

1. The EUT is placed on a turntable, which is 0.8m above the ground plane.
2. The turntable shall be rotated for 360 degrees to determine the position of maximum emission level.
3. EUT is set 3m away from the receiving antenna, which is varied from 1m to 4m to find out the highest emission.
4. Set the spectrum analyzer in the following setting in order to capture the lower and upper band-edges of the emission:
 - (a) PEAK: RBW=VBW=1MHz / Sweep=AUTO
 - (b) AVERAGE: Peak Level + Duty Factor
5. Repeat the procedures until all the PEAK and AVERAGE versus polarization are measured.

TEST RESULTS

After estimate 20dB bandwidth of 1st and last channel ,the declared frequency will not invade restrict band. There is no requirement for this test.



7.3 DUTY CYCLE

LIMIT

Nil (No dedicated limit specified in the Rules)

MEASUREMENT EQUIPMENT USED

| Name of Equipment | Manufacturer | Model | Serial Number | Calibration Due |
|-------------------|--------------|---------|---------------|-----------------|
| SPECTRUM ANALYZER | R&S | FSEK 30 | 835253/002 | SEP. 28, 2014 |

Remark: Each piece of equipment is scheduled for calibration once a year.

TEST CONFIGURATION

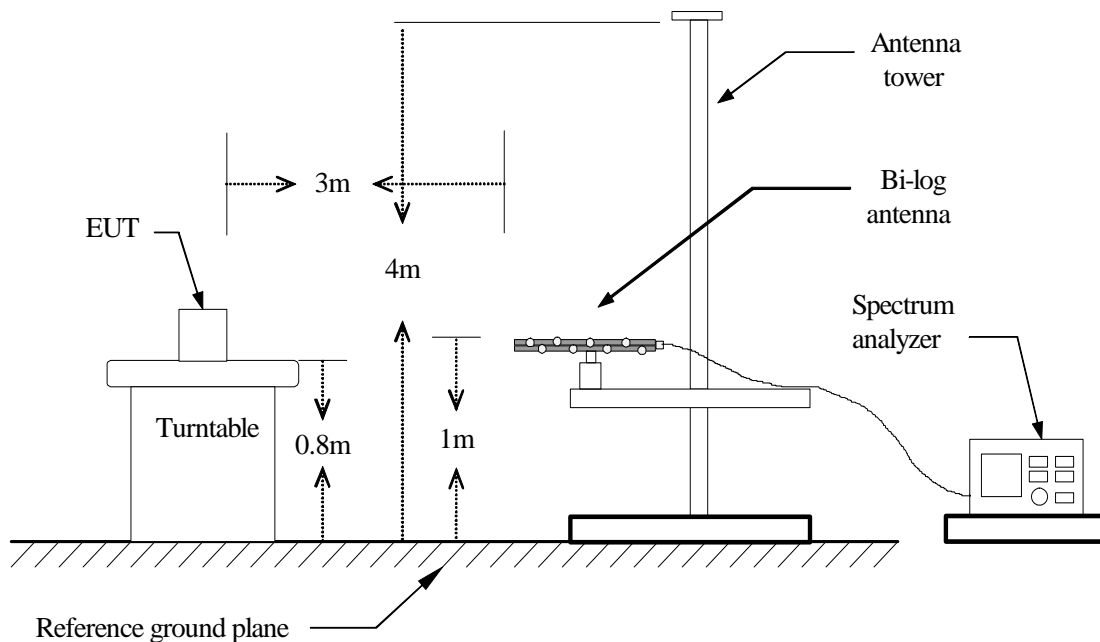

TEST PROCEDURE

1. Place the EUT on the table and set it in transmitting mode.
2. Set center frequency of spectrum analyzer = operating frequency.
3. Set the spectrum analyzer as RBW, VBW=100KHz, Span = 0Hz, a suitable Sweep Time.
4. Repeat above procedures until all frequency measured were complete.

TEST RESULTS

No non-compliance noted.



TEST DATA

| | us | Times | Ton | Total Ton time(ms) |
|------|----------|-------|----------|--------------------|
| Ton1 | 9218.437 | 1 | 9218.437 | 9.218 |
| Ton2 | | 0 | 0.000 | |
| Ton3 | | 0 | 0.000 | |
| Tp | | | | 100.000 |

| | |
|--------------|---------|
| Ton | 9.218 |
| Tp(Ton+Toff) | 100.000 |
| Duty Cycle | 0.092 |
| Duty Factor | -20.000 |

9.218437 %



Test Plot

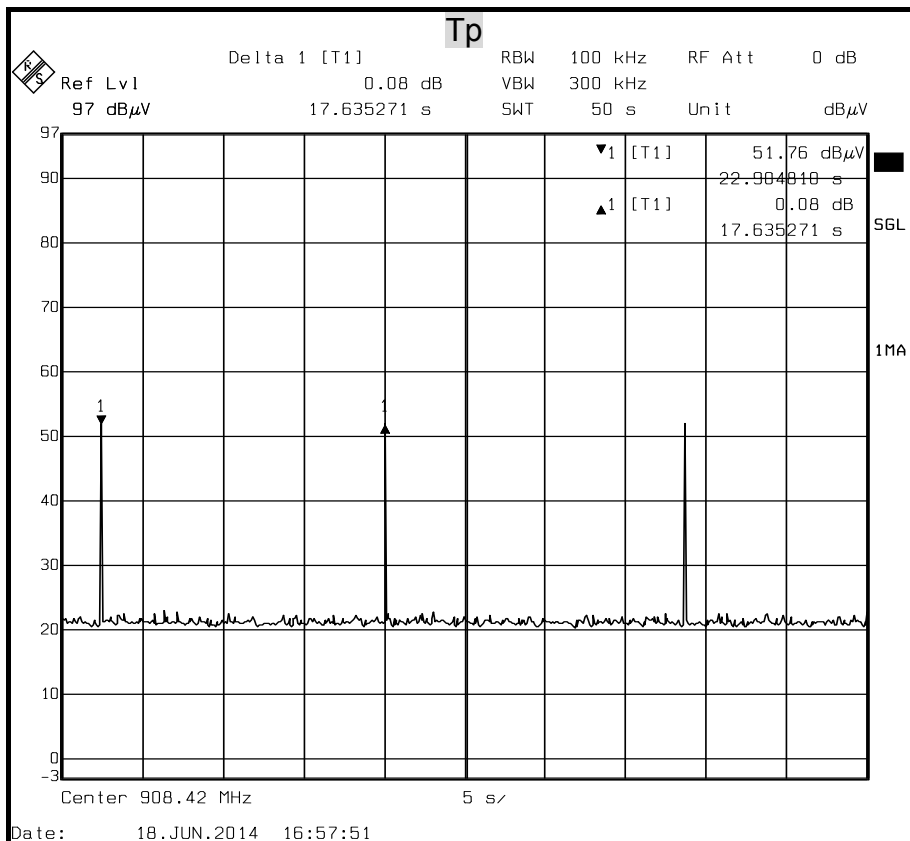
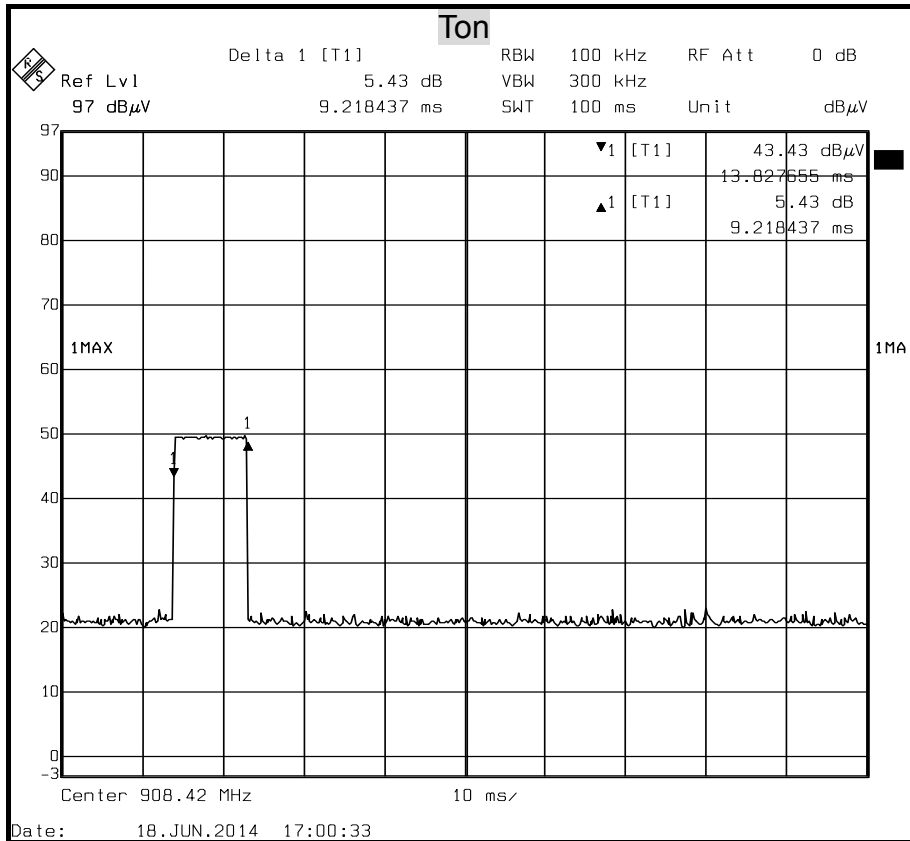



7.4 SPURIOUS EMISSION

LIMIT

1. In the section 15.249(a):

Except as provided in paragraph (b) of this section, the field strength of emissions from intentional radiators operated within these frequency bands shall comply with the following:

| Fundamental Frequency (MHz) | Field Strength of Fundamental Field Strength (mV/m) | Field Strength of Harmonics (μ V/m) |
|-----------------------------|---|--|
| 902-928 MHz | 50 | 500 |
| 2400 - 2483.5 MHz | 50 | 500 |
| 5725 - 5875 MHz | 50 | 500 |
| 24.0 - 24.25 GHz | 250 | 2500 |

2. Except as provided elsewhere in this Subpart, the emissions from an intentional radiator shall not exceed the field strength levels specified in the following table:

| Frequency (MHz) | Field Strength (μ V/m) | Measurement Distance (m) |
|-----------------|-----------------------------|--------------------------|
| 30-88 | 100* | 3 |
| 88-216 | 150* | 3 |
| 216-960 | 200* | 3 |
| Above 960 | 500 | 3 |

Remark: Except as provided in paragraph (g), fundamental emissions from intentional radiators operating under this Section shall not be located in the frequency bands 54-72 MHz, 76-88 MHz, 174-216 MHz or 470-806 MHz. However, operation within these frequency bands is permitted under other sections of this Part, e.g., Sections 15.231 and 15.241.

3. In the above emission table, the tighter limit applies at the band edges.

| Frequency (MHz) | Field Strength (μ V/m at 3-meter) | Field Strength (dB μ V/m at 3-meter) |
|-----------------|--|--|
| 30-88 | 100 | 40 |
| 88-216 | 150 | 43.5 |
| 216-960 | 200 | 46 |
| Above 960 | 500 | 54 |



MEASUREMENT EQUIPMENT USED

| Open Area Test Site # 6 | | | | |
|------------------------------------|--------------------------|--------------------|----------------------|------------------------|
| Name of Equipment | Manufacturer | Model | Serial Number | Calibration Due |
| TYPE N COAXIAL CABLE | SUHNER | CHA9513 | 6 | DEC. 18, 2014 |
| BI-LOG Antenna | Sunol | JB1 | A070506-2 | SEP. 26, 2014 |
| LOOP ANTENNA | EMCO | 6502 | 8905-2356 | JUN. 10, 2015 |
| Pre-Amplifier | HP | 8447F | NCR | NCR |
| EMI Receiver | R&S | ESVS10 | 833206/012 | JUN. 26, 2015 |
| RF Cable | SUHNER | SUCOFLEX104P EA | 20520/4PEA | NOV. 10, 2014 |
| Horn Antenna | Com-Power | AH-118 | 071032 | DEC. 05, 2014 |
| 3116 Double Ridge Antenna (40G) | ETS-LINDGREN | 3116 | 00078900 | DEC. 27, 2014 |
| Turn Table | Yo Chen | 001 | ----- | N.C.R. |
| Antenna Tower | AR | TP1000A | 309874 | N.C.R. |
| Controller | CT | SC101 | ----- | N.C.R. |
| RF Swicth | E-INSTRUMENT TELH LTD | ERS-180A | EC1204141 | N.C.R |
| Power Meter | Anritsu | ML2487A | 6K00003888 | MAY. 20, 2015 |
| Power Sensor | Anritsu | MA2491A | 33265 | MAY. 20, 2015 |
| Temp./Humidity Chamber | K.SON | THS-M1 | 242 | AUG. 08, 2014 |
| DC Power Source | LOKO | DSP-5050 | L1507009282 | N.C.R |
| Spectrum Analyzer | R&S | FSU | 200789 | JUL. 01, 2014 |
| Spectrum Analyzer | R&S | FSEK 30 | 835253/002 | SEP. 28, 2014 |

Remark: Each piece of equipment is scheduled for calibration once a year.



TEST CONFIGURATION

9kHz ~ 30MHz

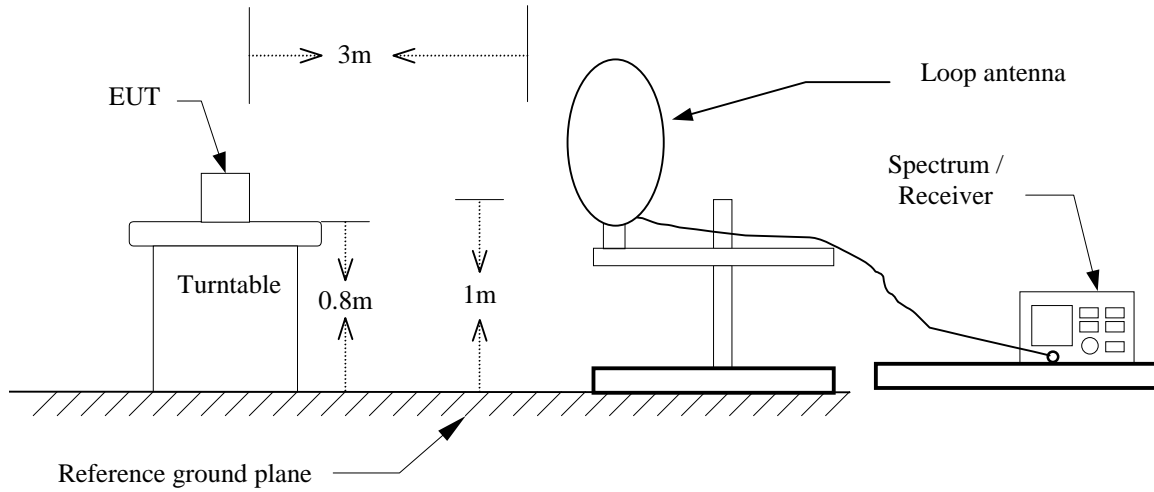

30MHz ~ 1GHz

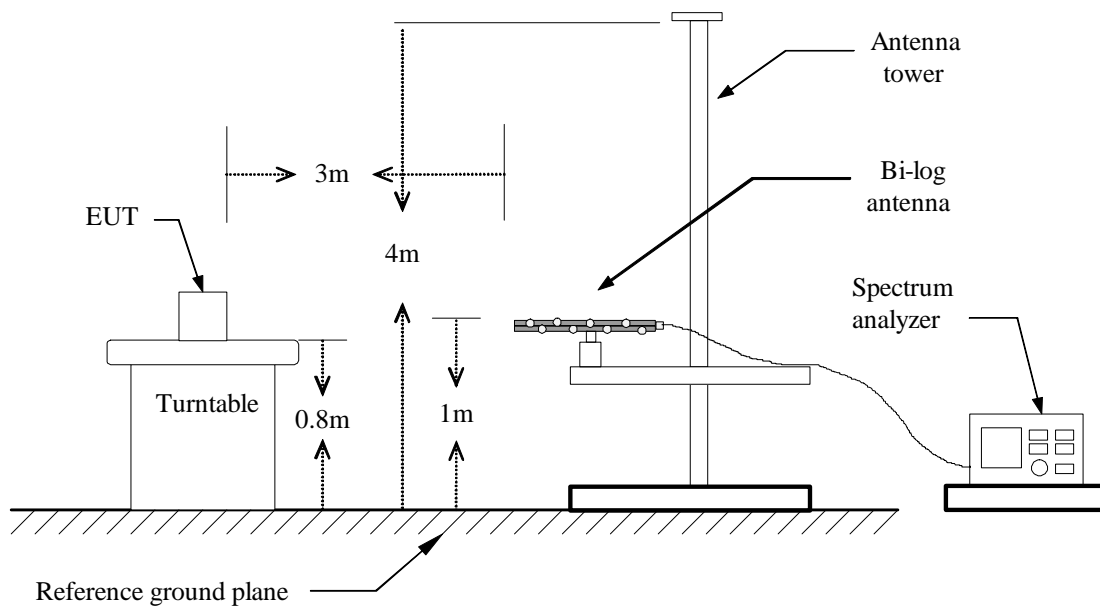



Above 1 GHz

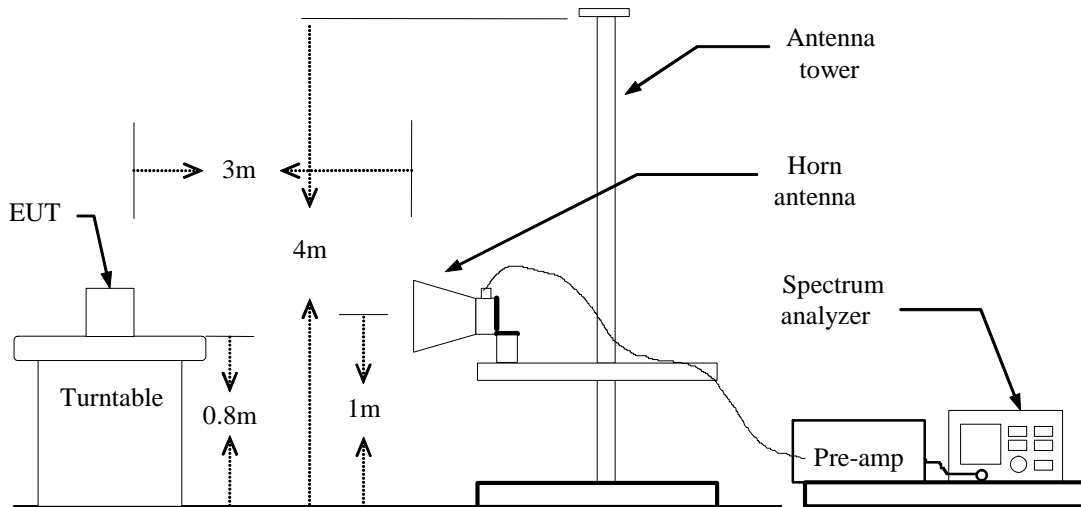

TEST PROCEDURE

7. The EUT is placed on a turntable, which is 0.8m above ground plane.
8. The turntable shall be rotated for 360 degrees to determine the position of maximum emission level.
9. EUT is set 3m away from the receiving antenna, which is varied from 1m to 4m to find out the highest emissions.
10. Maximum procedure was performed on the six highest emissions to ensure EUT compliance.
11. And also, each emission was to be maximized by changing the polarization of receiving antenna both horizontal and vertical.
12. Set the spectrum analyzer in the following setting as:
Below 1GHz:
RBW=100kHz / VBW=300kHz / Sweep=AUTO
Above 1GHz:
(a) PEAK: RBW=VBW=1MHz / Sweep=AUTO
(b) AVERAGE: Peak Level + Duty Factor
13. Repeat above procedures until the measurements for all frequencies are complete.



Below 1 GHz

Operation Mode: Normal Operation

Test Date: 2014/06/16

Temperature: 25°C

Tested by: Taiyu Cyu

Humidity: 44% RH

Polarity: Ver. / Hor.

Vertical

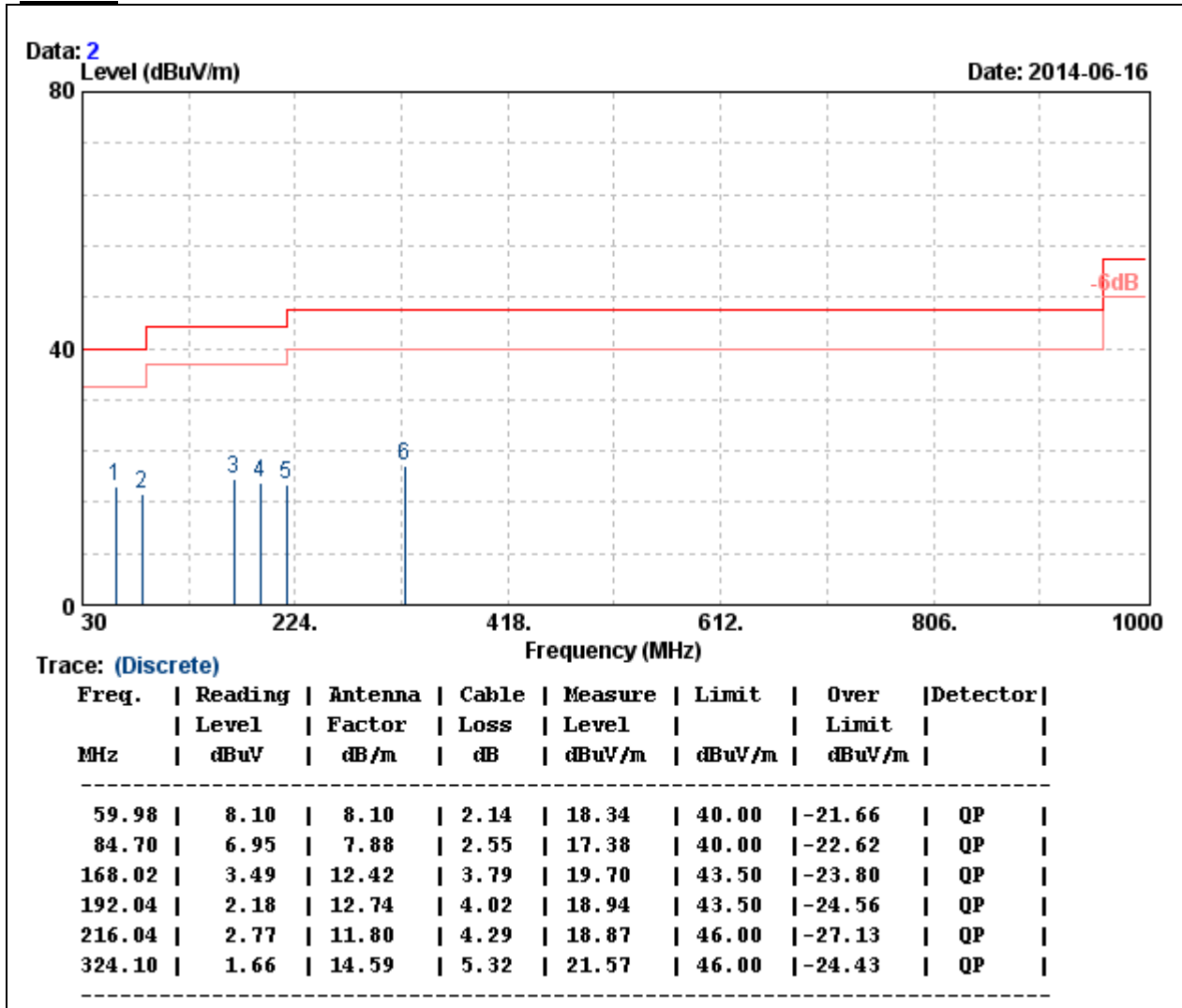

Remark:

1. No emission found between lowest internal used/generated frequency to 30MHz (9kHz~30MHz).
2. Radiated emissions measured in frequency range from 30 MHz to 1000MHz were made with an instrument using peak/quasi-peak detector mode.
3. Quasi-peak test would be performed if the peak result were greater than the quasi-peak limit or as required by the applicant.
4. Measurements above show only up to 6 maximum emissions noted, or would be lesser, with " N/A " remark, if no specific emissions from the EUT are recorded (ie: margin>20dB from the applicable limit) and considered that's already beyond the background noise floor.
5. Margin (dB) = Remark result (dBuV/m) – Quasi-peak limit (dBuV/m).
6. That the limit for signals below 1GHz is a QP limit and peak readings are below the QP limit.
7. The fundamental signal is not shown in the test data because measurements at fundamental frequency are shown separately and were ignored during the 30 – 1000 MHz scan.



Operation Mode: Normal Operation
Temperature: 25°C
Humidity: 44% RH

Test Date: 2014/06/16
Tested by: Taiyu Cyu
Polarity: Ver. / Hor.

Horizontal

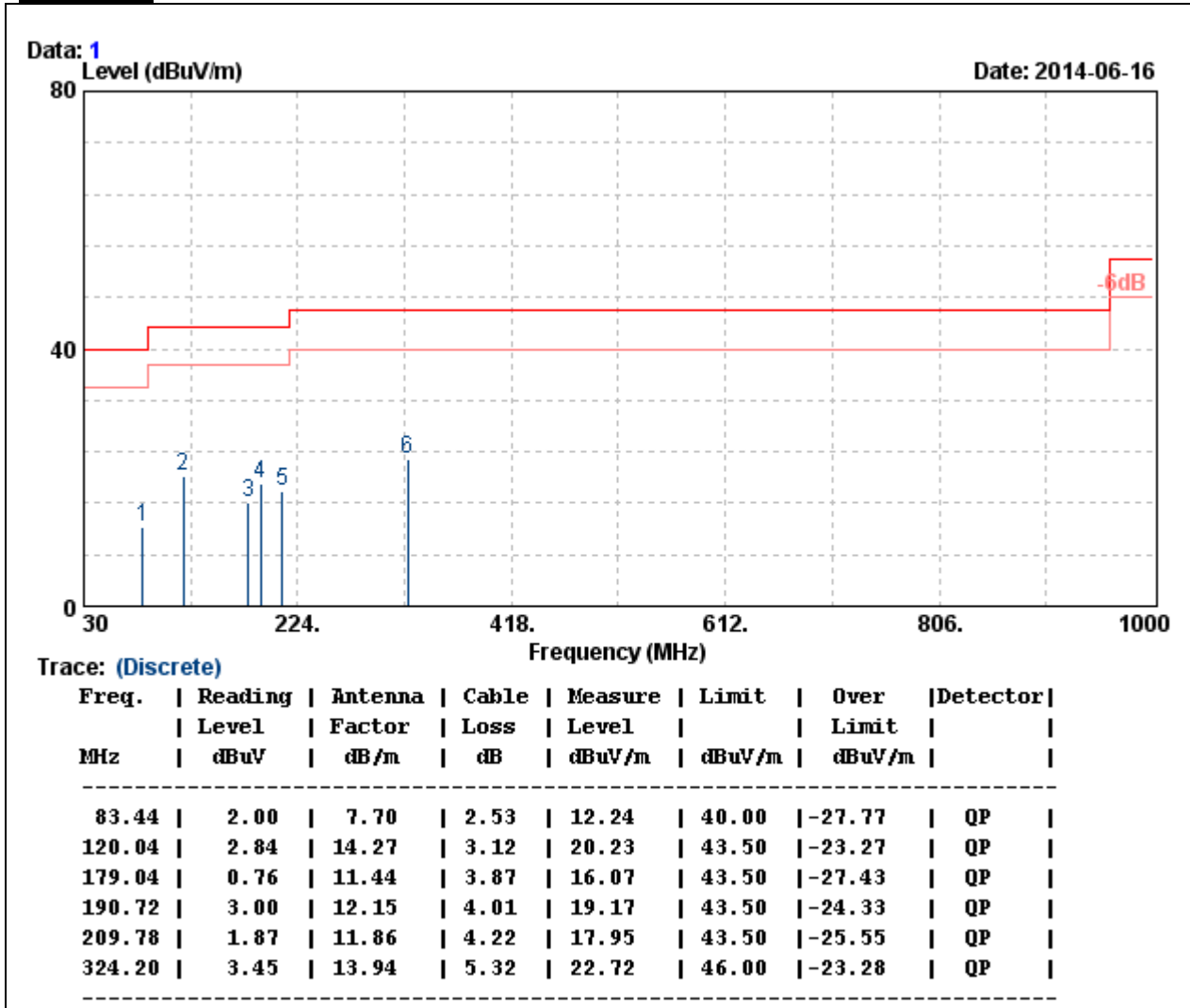

Remark:

1. No emission found between lowest internal used/generated frequency to 30MHz (9kHz~30MHz).
2. Radiated emissions measured in frequency range from 30 MHz to 1000MHz were made with an instrument using peak/quasi-peak detector mode.
3. Quasi-peak test would be performed if the peak result were greater than the quasi-peak limit or as required by the applicant.
4. Measurements above show only up to 6 maximum emissions noted, or would be lesser, with " N/A " remark, if no specific emissions from the EUT are recorded (ie: margin>20dB from the applicable limit) and considered that's already beyond the background noise floor.
5. Margin (dB) = Remark result (dBuV/m) – Quasi-peak limit (dBuV/m).
6. That the limit for signals below 1GHz is a QP limit and peak readings are below the QP limit.
7. The fundamental signal is not shown in the test data because measurements at fundamental frequency are shown separately and were ignored during the 30 – 1000 MHz scan.



The fundamental signal

Operation Mode: TX / 9.6kbps Mode (X axis)

Test Date: 2014/06/19

Temperature: 26.4°C

Tested by: Ted Huang

Humidity: 56% RH

Polarity: Ver. / Hor.

Horizontal

| Freq. | Reading | AF | Cable Loss | Pre-amp | Filter | Level | Limit | Margin | Mark |
|--------|---------|--------|------------|---------|--------|----------|----------|--------|---------|
| (MHz) | (dBμV) | (dB/m) | (dB) | (dB) | (dB) | (dBμV/m) | (dBμV/m) | (dB) | (P/Q/A) |
| 908.42 | 83.32 | 23.11 | 5.95 | 24.41 | 0.00 | 87.97 | 114.00 | -26.03 | P |
| 908.42 | 83.32 | 23.11 | 5.95 | 24.41 | 0.00 | 87.97 | 94.00 | -6.03 | Q |

Vertical

| Freq. | Reading | AF | Cable Loss | Pre-amp | Filter | Level | Limit | Margin | Mark |
|--------|---------|--------|------------|---------|--------|----------|----------|--------|---------|
| (MHz) | (dBμV) | (dB/m) | (dB) | (dB) | (dB) | (dBμV/m) | (dBμV/m) | (dB) | (P/Q/A) |
| 908.42 | 78.40 | 23.11 | 5.95 | 24.41 | 0.00 | 83.05 | 114.00 | -30.95 | P |
| 908.42 | 78.40 | 23.11 | 5.95 | 24.41 | 0.00 | 83.05 | 94.00 | -10.95 | Q |

Remark:

Margin (dB) = Remark result (dBuV/m) – Quasi-peak limit (dBuV/m).



Above 1 GHz

Operation Mode: TX / 9.6kbps Mode (X axis)

Test Date: 2014/06/19

Temperature: 26.4°C

Tested by: Ted Huang

Humidity: 56% RH

Polarity: Ver. / Hor.

Horizontal

| Freq. | Reading | AF | Cable Loss | Pre-amp | Filter | Level | Limit | Margin | Mark |
|-----------|---------|--------|------------|---------|--------|----------|----------|--------|---------|
| (MHz) | (dBµV) | (dB/m) | (dB) | (dB) | (dB) | (dBµV/m) | (dBµV/m) | (dB) | (P/Q/A) |
| 1816.85 | 66.93 | 29.14 | 2.21 | 48.33 | 0.30 | 50.25 | 74.00 | -23.75 | P |
| 1816.85 | 46.93 | 29.14 | 2.21 | 48.33 | 0.30 | 30.25 | 54.00 | -23.75 | A |
| * 2725.22 | 54.84 | 30.38 | 2.77 | 47.29 | 0.30 | 41.00 | 74.00 | -33.00 | P |
| * 2725.22 | 34.84 | 30.38 | 2.77 | 47.29 | 0.30 | 21.00 | 54.00 | -33.00 | A |
| * 3633.69 | 55.63 | 31.04 | 3.23 | 47.60 | 0.30 | 42.60 | 74.00 | -31.40 | P |
| * 3633.69 | 35.63 | 31.04 | 3.23 | 47.60 | 0.30 | 22.60 | 54.00 | -31.40 | A |
| N/A | --- | --- | --- | --- | --- | --- | --- | --- | --- |

Remark:

1. Measuring frequencies from 1 GHz to the 10th harmonic of highest fundamental frequency.
2. Radiated emissions measured in frequency above 1000MHz were made with an instrument using peak/average detector mode.
3. Average test would be performed if the peak result were greater than the average limit or as required by the applicant.
4. Data of measurement within this frequency range shown " --- " in the table above means the reading of emissions are attenuated more than 20dB below the permissible limits or the field strength is too small to be measured.
5. Measurements above show only up to 6 maximum emissions noted, or would be lesser, with " N/A " remark, if no specific emissions from the EUT are recorded (ie: margin>20dB from the applicable limit) and considered that's already beyond the background noise floor.
6. Margin (dB) = Remark result (dBuV/m) – Average limit (dBuV/m). Peak detector mode and average detector mode of the emission shown in Result column.



Operation Mode: TX / 9.6kbps Mode (X axis)

Test Date: 2014/06/19

Temperature: 26.4°C

Tested by: Ted Huang

Humidity: 56% RH

Polarity: Ver. / Hor.

Vertical

| Freq. | Reading | AF | Cable Loss | Pre-amp | Filter | Level | Limit | Margin | Mark |
|-----------|---------|--------|------------|---------|--------|----------|----------|--------|---------|
| (MHz) | (dBµV) | (dB/m) | (dB) | (dB) | (dB) | (dBµV/m) | (dBµV/m) | (dB) | (P/Q/A) |
| 1816.83 | 64.86 | 29.14 | 2.21 | 48.33 | 0.30 | 48.18 | 74.00 | -25.82 | P |
| 1816.83 | 44.86 | 29.14 | 2.21 | 48.33 | 0.30 | 28.18 | 54.00 | -25.82 | A |
| * 2725.22 | 54.65 | 30.38 | 2.77 | 47.29 | 0.30 | 40.81 | 74.00 | -33.19 | P |
| * 2725.22 | 34.65 | 30.38 | 2.77 | 47.29 | 0.30 | 20.81 | 54.00 | -33.19 | A |
| * 3633.64 | 55.77 | 31.04 | 3.23 | 47.60 | 0.30 | 42.74 | 74.00 | -31.26 | P |
| * 3633.64 | 35.77 | 31.04 | 3.23 | 47.60 | 0.30 | 22.74 | 54.00 | -31.26 | A |
| N/A | --- | --- | --- | --- | --- | --- | --- | --- | --- |

Remark:

1. Measuring frequencies from 1 GHz to the 10th harmonic of highest fundamental frequency.
2. Radiated emissions measured in frequency above 1000MHz were made with an instrument using peak/average detector mode.
3. Average test would be performed if the peak result were greater than the average limit or as required by the applicant.
4. Data of measurement within this frequency range shown " --- " in the table above means the reading of emissions are attenuated more than 20dB below the permissible limits or the field strength is too small to be measured.
5. Measurements above show only up to 6 maximum emissions noted, or would be lesser, with " N/A " remark, if no specific emissions from the EUT are recorded (ie: margin>20dB from the applicable limit) and considered that's already beyond the background noise floor.
6. Margin (dB) = Remark result (dBuV/m) – Average limit (dBuV/m). Peak detector mode and average detector mode of the emission shown in Result column.



7.5 POWERLINE CONDUCTED EMISSIONS

LIMIT

According to §15.207(a), except as shown in paragraphs (b) and (c) of this section, for an intentional radiator that is designed to be connected to the public utility (AC) power line, the radio frequency voltage that is conducted back onto the AC power line on any frequency or frequencies within the band 150 kHz to 30 MHz shall not exceed the limits in the following table, as measured using a 50 μ H/50 ohms line impedance stabilization network (LISN). Compliance with the provisions of this paragraph shall be based on the measurement of the radio frequency voltage between each power line and ground at the power terminal. The lower limit applies at the boundary between the frequency ranges.

| Frequency Range (MHz) | Limits (dB μ V) | |
|-----------------------|---------------------|----------|
| | Quasi-peak | Average |
| 0.15 to 0.50 | 66 to 56 | 56 to 46 |
| 0.50 to 5 | 56 | 46 |
| 5 to 30 | 60 | 50 |

Compliance with this provision shall be based on the measurement of the radio frequency voltage between each power line (LINE and NEUTRAL) and ground at the power terminals.

MEASUREMENT EQUIPMENT USED

| Conducted Emission room #1 | | | | |
|----------------------------|---------------------------|-----------|---------------|-----------------|
| Name of Equipment | Manufacturer | Model | Serial Number | Calibration Due |
| L.I.S.N. | SCHWARZBECK | NNLK 8130 | 8130124 | AUG. 12, 2014 |
| | Rohde & Schwarz | ESH 3-Z5 | 840062/021 | SEP. 09, 2014 |
| | Rohde & Schwarz | ESH 3-Z5 | 893540/015 | APR. 13, 2015 |
| TEST RECEIVER | Rohde & Schwarz | ESCS 30 | 100348 | AUG. 09, 2014 |
| BNC COAXIAL CABLE | CCS | BNC50 | 11 | NOV. 19, 2014 |
| Test S/W | e-3 (5.04211c) R&S (2.27) | | | |

Remark: Each piece of equipment is scheduled for calibration once a year.

TEST RESULTS

No non-compliance noted.

This EUT is not connected to AC Source directly. Not applicable for this test.