

**FCC 47 CFR PART 15 SUBPART C: 2014  
ANSI C63.10: 2013**

**TEST REPORT**

For

**Wireless Shock Sensor**

**Model: ZS5101US-5**

**Brand: VISION**

Issued to

**Vision Automobile Electronics Industrial Co., Ltd.**

No. 78, Gongye 3rd Rd., Technology Industrial Park, Tainan City 70955,  
Taiwan (R.O.C.)

Issued by

**Compliance Certification Services Inc.**

**Tainan Lab.**

No.8, Jiucengling, Xinhua Dist., Tainan City 712, Taiwan (R.O.C.)

**TEL: (06) 580-2201**

**FAX: (06) 580-2202**

**Issued Date: January 08, 2016**



---

*Note: This report shall not be reproduced except in full, without the written approval of Compliance Certification Services Inc. This document may be altered or revised by Compliance Certification Services Inc. personnel only, and shall be noted in the revision section of the document.*

**REVISION HISTORY**

<b>Rev.</b>	<b>Issue Date</b>	<b>Revisions</b>	<b>Effect Page</b>	<b>Revised By</b>
00	January 08, 2016	Initial Issue	ALL	Daphne Liang

## TABLE OF CONTENTS

<b>1. TEST RESULT CERTIFICATION .....</b>	<b>4</b>
<b>2. EUT DESCRIPTION.....</b>	<b>5</b>
<b>3. TEST METHODOLOGY.....</b>	<b>6</b>
3.1 EUT CONFIGURATION .....	6
3.2 EUT EXERCISE .....	6
3.3 GENERAL TEST PROCEDURES.....	6
3.4 FCC PART 15.205 RESTRICTED BANDS OF OPERATIONS.....	7
3.5 DESCRIPTION OF TEST MODES.....	7
<b>4. INSTRUMENT CALIBRATION .....</b>	<b>8</b>
4.1 MEASURING INSTRUMENT CALIBRATION .....	8
4.2 MEASUREMENT EQUIPMENT USED .....	8
4.3 MEASUREMENT UNCERTAINTY .....	9
<b>5. FACILITIES AND ACCREDITATIONS .....</b>	<b>10</b>
5.1 FACILITIES .....	10
5.2 EQUIPMENT .....	10
5.3 LABORATORY ACCREDITATIONS LISTING .....	10
5.4 TABLE OF ACCREDITATIONS AND LISTINGS.....	11
<b>6. SETUP OF EQUIPMENT UNDER TEST .....</b>	<b>12</b>
6.1 SETUP CONFIGURATION OF EUT .....	12
6.2 SUPPORT EQUIPMENT.....	12
<b>7. FCC PART 15.249 REQUIREMENTS .....</b>	<b>13</b>
7.1 20 DB BANDWIDTH.....	13
7.2 BAND EDGES MEASUREMENT .....	16
7.3 DUTY CYCLE.....	18
7.4 SPURIOUS EMISSION .....	20
7.5 POWERLINE CONDUCTED EMISSIONS .....	29
<b>APPENDIX I - PHOTOGRAPHS OF TEST SETUP .....</b>	<b>30</b>
<b>APPENDIX II - PHOTOGRAPHS OF EUT .....</b>	<b>A1</b>

# 1. TEST RESULT CERTIFICATION

<b>Product:</b>	Wireless Shock Sensor
<b>Model:</b>	ZS5101US-5
<b>Brand:</b>	<b>VISION</b>
<b>Applicant:</b>	<b>Vision Automobile Electronics Industrial Co., Ltd.</b> No. 78, Gongye 3rd Rd., Technology Industrial Park, Tainan City 70955, Taiwan (R.O.C.)
<b>Manufacturer:</b>	<b>Vision Automobile Electronics Industrial Co., Ltd.</b> No. 78, Gongye 3rd Rd., Technology Industrial Park, Tainan City 70955, Taiwan (R.O.C.)
<b>Tested:</b>	December 21, 2015 ~ December 28, 2015

APPLICABLE STANDARDS	
STANDARD	TEST RESULT
FCC 47 CFR Part 15 Subpart C: 2014 ANSI C63.10: 2013	No non-compliance noted

**We hereby certify that:**

The above equipment was tested by Compliance Certification Services Inc. The test data, data evaluation, test procedures, and equipment configurations shown in this report were made in accordance with the procedures given in ANSI C63.10: 2013 and the energy emitted by the sample EUT tested as described in this report is in compliance with the requirements emission limits of FCC Rules Part 15.107, 15.109,15.207, 15.209 and 15.249.

The test results of this report relate only to the tested sample identified in this report.

**Approved by:**

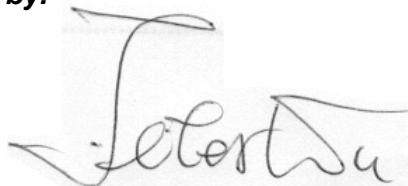

**Jeter Wu**  
Assistant Manager

**Reviewed by:**

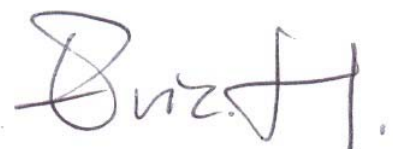

**Eric Huang**  
Assistant Section Manager

## 2. EUT DESCRIPTION

<b>Product</b>	Wireless Shock Sensor
<b>Model Number</b>	ZS5101US-5
<b>Brand Name</b>	<b>VISION</b>
<b>Received Date</b>	December 15, 2015
<b>Frequency Range</b>	908.42MHZ $\pm$ 20kHz
<b>Transmit Peak Power</b>	67.44 dB $\mu$ V/m
<b>Data Rate</b>	9.6 kbps , 40kbps
<b>Number of Channels</b>	1 Channel
<b>Type of Modulation</b>	Frequency Shift Keying (FSK)
<b>Power Supply</b>	DC 3V
<b>Antenna Type</b>	Wire antenna Model: ZS5101US-5 Gain: -0.1 dBi
<b>RF Module Model</b>	PCB: ZM5202AU IC: SD3502
<b>Temperature Range</b>	-15°C ~ +60°C
<b>Hardware Version</b>	V1.0
<b>Software Version</b>	V1.0

### Remark:

1. Client consigns only one model sample to test (Model Number: **ZS5101US-5** ). Therefore, the testing Lab. just guarantees the unit, which has been tested.
2. This submittal(s) (test report) is intended for FCC ID: **KFR-ZS5101US-5** filing to comply with Section 15.107 & 15.109 (FCC Part 15, Subpart B) and Section 15.207, 15.209, 15.249.

### **3. TEST METHODOLOGY**

The tests documented in this report were performed in accordance with ANSI C63.10 and FCC CFR 47 2.1046, 2.1047, 2.1049, 2.1051, 2.1053, 2.1055, 2.1057, 15.207, 15.209 and 15.249.

#### **3.1 EUT CONFIGURATION**

The EUT configuration for testing is installed on RF field strength measurement to meet the Commissions requirement and operating in a manner that intends to maximize its emission characteristics in a continuous normal application.

#### **3.2 EUT EXERCISE**

The EUT was operated in the engineering mode to fix the TX frequency that was for the purpose of the measurements.

According to its specifications, the EUT must comply with the requirements of the Section 15.107 and 15.109 under the FCC Rules Part 15 Subpart B and Section 15.207, 15.209, 15.249 under the FCC Rules Part 15 Subpart C.

#### **3.3 GENERAL TEST PROCEDURES**

##### **Conducted Emissions**

The EUT is placed on the turntable, which is 0.8 m above ground plane. According to the requirements in Section 13.1.4.1 of ANSI C63.10 Conducted emissions from the EUT measured in the frequency range between 0.15 MHz and 30MHz using CISPR Quasi-peak and average detector modes.

##### **Radiated Emissions**

The EUT is placed on a turn table, which is 1.5 m above ground plane. The turntable shall rotate 360 degrees to determine the position of maximum emission level. EUT is set 3m away from the receiving antenna, which varied from 1m to 4m to find out the highest emission. And also, each emission was to be maximized by changing the polarization of receiving antenna both horizontal and vertical. In order to find out the maximum emissions, exploratory radiated emission measurements were made according to the requirements in Section 13.1.4.1 of ANSI C63.10.

### 3.4 FCC PART 15.205 RESTRICTED BANDS OF OPERATIONS

1. Except as shown in paragraph (d) of this section, only spurious emissions are permitted in any of the frequency bands listed below:

MHz	MHz	MHz	GHz
0.090 - 0.110	16.42 - 16.423	399.9 - 410	4.5 - 5.15
<sup>1</sup> 0.495 - 0.505	16.69475 - 16.69525	608 - 614	5.35 - 5.46
2.1735 - 2.1905	16.80425 - 16.80475	960 - 1240	7.25 - 7.75
4.125 - 4.128	25.5 - 25.67	1300 - 1427	8.025 - 8.5
4.17725 - 4.17775	37.5 - 38.25	1435 - 1626.5	9.0 - 9.2
4.20725 - 4.20775	73 - 74.6	1645.5 - 1646.5	9.3 - 9.5
6.215 - 6.218	74.8 - 75.2	1660 - 1710	10.6 - 12.7
6.26775 - 6.26825	108 - 121.94	1718.8 - 1722.2	13.25 - 13.4
6.31175 - 6.31225	123 - 138	2200 - 2300	14.47 - 14.5
8.291 - 8.294	149.9 - 150.05	2310 - 2390	15.35 - 16.2
8.362 - 8.366	156.52475 -	2483.5 - 2500	17.7 - 21.4
8.37625 - 8.38675	156.52525	2655 - 2900	22.01 - 23.12
8.41425 - 8.41475	156.7 - 156.9	3260 - 3267	23.6 - 24.0
12.29 - 12.293	162.0125 - 167.17	3332 - 3339	31.2 - 31.8
12.51975 - 12.52025	167.72 - 173.2	3345.8 - 3358	36.43 - 36.5
12.57675 - 12.57725	240 - 285	3600 - 4400	( <sup>2</sup> )
13.36 - 13.41	322 - 335.4		

<sup>1</sup> Until February 1, 1999, this restricted band shall be 0.490-0.510 MHz.

<sup>2</sup> Above 38.6

2. Except as provided in paragraphs (d) and (e), the field strength of emissions appearing within these frequency bands shall not exceed the limits shown in Section 15.209. At frequencies equal to or less than 1000 MHz, compliance with the limits in Section 15.209 shall be demonstrated using measurement instrumentation employing a CISPR quasi-peak detector. Above 1000 MHz, compliance with the emission limits in Section 15.209 shall be demonstrated based on the average value of the measured emissions. The provisions in Section 15.35 apply to these measurements.

### 3.5 DESCRIPTION OF TEST MODES

The EUT ( **Model: ZS5101US-5** ) had been tested under engineering test mode condition and the EUT staying in continuous transmitting mode.

Note :

The field strength of spurious emission was measured in the following position:

- 1) EUT has supported two data rates ( 9.6kbps , 40kbps) which have been the test. The worst emission was found in **40kbps** and the worst case was recorded.
- 2) The field strength of spurious emission was measured in the following position: EUT stand-up position (Y axis), lie-down position (X, Z axis). The worst emission was found in **stand-up position (Y axis)**, and the worst case was recorded.

## 4. INSTRUMENT CALIBRATION

### 4.1 MEASURING INSTRUMENT CALIBRATION

The measuring equipment, which was utilized in performing the tests documented herein, has been calibrated in accordance with the manufacturer's recommendations for utilizing calibration equipment, which is traceable to recognized national standards.

### 4.2 MEASUREMENT EQUIPMENT USED

#### Equipment Used for Emissions Measurement

Chamber Room # 966				
Name of Equipment	Manufacturer	Model	Serial Number	Calibration Due
HUBER+SUHNER	Cable	SUCOFLEX 104PEA	SN25737 /4PEA	JAN. 14, 2016
Antenna	Sunol sciences	JB1	A021306	AUG. 02, 2016
LOOP ANTENNA	EMCO	6502	8905-2356	JUN. 10, 2016
Pre-Amplifier	HP	8447F	2443A01671	JAN. 14, 2016
Pre-Amplifier	EMCI	EMC 012645	980098	DEC. 04, 2016
Horn Antenna	Com-Power	AH-118	071032	JAN. 09, 2016
3116 Double Ridge Antenna (40G)	ETS-LINDGREN	3116	00078900	MAR. 04, 2016
Turn Table	Yo Chen	001	-----	N.C.R.
Antenna Tower	AR	TP1000A	309874	N.C.R.
Controller	UC	UC300	-----	N.C.R.
RF Swicth	E-INSTRUMENT TELH LTD	ERS-180A	EC1204141	N.C.R
EXA Spectrum Analyzer	KEYSIGHT	N9010A	MY54430216	JAN. 23, 2016
Test S/W	e-3 (5.04303e)			

**Remark:** Each piece of equipment is scheduled for calibration once a year.



**4.3 MEASUREMENT UNCERTAINTY**

<b>Parameter</b>	<b>Uncertainty</b>
Radiated Emission, 30 to 200 MHz Test Site : Chamber 966	±3.21dB
Radiated Emission, 200 to 1000 MHz Test Site : Chamber 966	±3.09dB
Radiated Emission, 1 to 8 GHz	± 2.65dB
Radiated Emission, 8 to 18 GHz	± 2.66dB
Radiated Emission, 18 to 26.5 GHz	± 2.65dB
Radiated Emission, 26 to 40 GHz	± 3.03dB
Power Line Conducted Emission	±1.91dB
Band Width	136.49kHz
Peak Output Power MU	±1.34dB
Band Edge MU	±0.30dBuV
Channel Separation MU	361.69Hz
Duty Cycle MU	0.064ms
Frequency Stability MU	0.223kHz

Uncertainty figures are valid to a confidence level of 95%, k=2

## **5. FACILITIES AND ACCREDITATIONS**

### **5.1 FACILITIES**

All measurement facilities used to collect the measurement data are located at

No.8, Jiucengling, Xinhua Dist., Tainan City 712, Taiwan (R.O.C.)

The sites are constructed in conformance with the requirements of ANSI C63.7:1992, ANSI C63.10 : 2013 and CISPR Publication 22.

### **5.2 EQUIPMENT**

Radiated emissions are measured with one or more of the following types of linearly polarized antennas: tuned dipole, biconical, log periodic, bi-log, and/or ridged waveguide, horn. Spectrum analyzers with pre-selectors and quasi-peak detectors are used to perform radiated measurements.

Conducted emissions are measured with Line Impedance Stabilization Networks and EMI Test Receivers.

Calibrated wideband preamplifiers, coaxial cables, and coaxial attenuators are also used for making measurements.

All receiving equipment conforms to CISPR Publication 16-1, "Radio Interference Measuring Apparatus and Measurement Methods."

### **5.3 LABORATORY ACCREDITATIONS LISTING**

The test facilities used to perform radiated and conducted emissions tests are accredited by Taiwan Accreditation Foundation for the specific scope of accreditation under Lab Code: 1109 to perform Electromagnetic Interference tests according to FCC PART 15 AND CISPR 22 requirements. No part of this report may be used to claim or imply product endorsement by TAF or any agency of the Government. In addition, the test facilities are listed with Federal Communications Commission (registration no: TW-1037).

## 5.4 TABLE OF ACCREDITATIONS AND LISTINGS

Our laboratories are accredited and approved by the following accreditation body according to ISO/IEC 17025.

<b>Taiwan</b>	TAF
---------------	-----

The measuring facility of laboratories has been authorized or registered by the following approval agencies.

<b>Canada</b>	Industry Canada
---------------	-----------------

<b>Germany</b>	TUV NORD
----------------	----------

<b>Taiwan</b>	BSMI
---------------	------

<b>USA</b>	FCC
------------	-----

Copies of granted accreditation certificates are available for downloading from our web site, <http://www.ccsrf.com>

## 6. SETUP OF EQUIPMENT UNDER TEST

### 6.1 SETUP CONFIGURATION OF EUT

See test photographs attached in Appendix I for the actual connections between EUT and support equipment.

### 6.2 SUPPORT EQUIPMENT

**【RF】**

No.	Product	Manufacturer	Model No.	Certify No.	Signal cable
1	N/A	---	---	---	---

No.	Signal cable description				
A	N/A	---			

**【EMC】**

No.	Product	Manufacturer	Model No.	Certify No.	Signal cable
1	N/A	---	---	---	---

No.	Signal cable description				
A	N/A	---			

**Remark:**

1. All the equipment/cables were placed in the worst-case configuration to maximize the emission during the test.
2. Grounding was established in accordance with the manufacturer’s requirements and conditions for the intended use.

### 6.3 EUT OPERATING CONDITION

**RF Setup**

1. Set up a whole system as the setup diagram.
2. Turn on power.

## 7. FCC PART 15.249 REQUIREMENTS

### 7.1 20 DB BANDWIDTH

#### LIMIT

None; for reporting purposes only.

#### MEASUREMENT EQUIPMENT USED

Chamber Room # 966				
Name of Equipment	Manufacturer	Model	Serial Number	Calibration Due
HUBER+SUHNER	Cable	SUCOFLEX 104PEA	SN25737 /4PEA	JAN. 14, 2016
Antenna	Sunol sciences	JB1	A021306	AUG. 02, 2016
LOOP ANTENNA	EMCO	6502	8905-2356	JUN. 10, 2016
Pre-Amplifier	HP	8447F	2443A01671	JAN. 14, 2016
Pre-Amplifier	EMCI	EMC 012645	980098	DEC. 04, 2016
Horn Antenna	Com-Power	AH-118	071032	JAN. 09, 2016
3116 Double Ridge Antenna (40G)	ETS-LINDGREN	3116	00078900	MAR. 04, 2016
Turn Table	Yo Chen	001	-----	N.C.R.
Antenna Tower	AR	TP1000A	309874	N.C.R.
Controller	UC	UC300	-----	N.C.R.
RF Swicth	E-INSTRUMENT TELH LTD	ERS-180A	EC1204141	N.C.R
EXA Spectrum Analyzer	KEYSIGHT	N9010A	MY54430216	JAN. 23, 2016
Test S/W	e-3 (5.04303e)			

**Remark:** Each piece of equipment is scheduled for calibration once a year.

**Test Configuration**

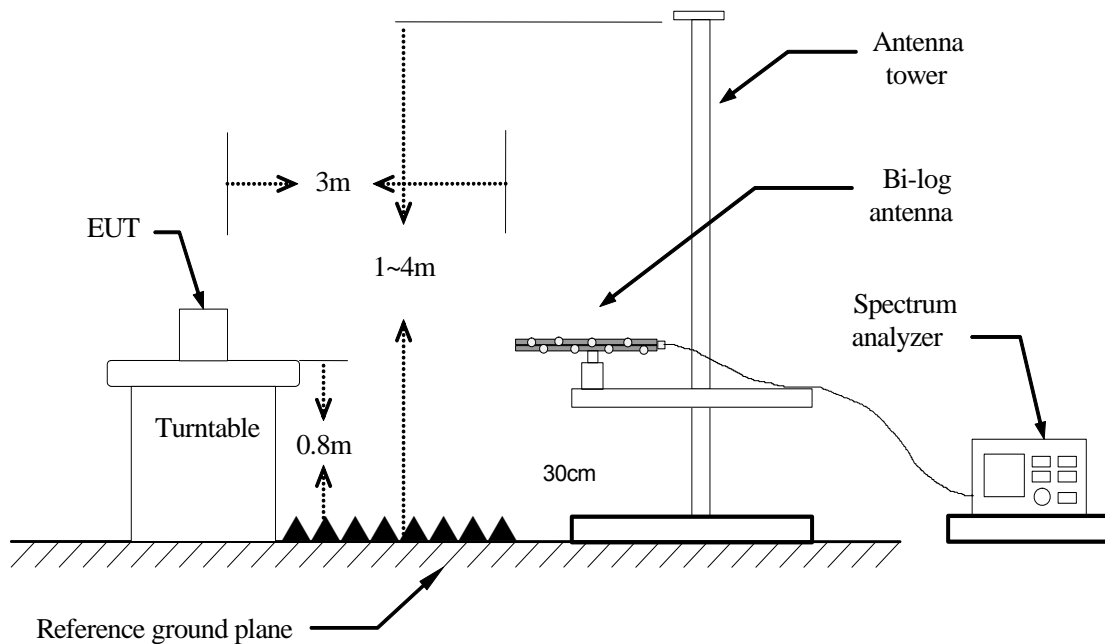

**TEST PROCEDURE**

1. The EUT is placed on a turntable, which is 0.8m above ground plane.
2. The turntable shall be rotated for 360 degrees to determine the position of maximum emission level.
3. EUT is set 3m away from the receiving antenna, which is varied from 1m to 4m to find out the highest emissions.
4. Maximum procedure was performed on the six highest emissions to ensure EUT compliance.
5. And also, each emission was to be maximized by changing the polarization of receiving antenna both horizontal and vertical.
6. Set the spectrum analyzer in the following setting as:  
RBW is set to 1 kHz and VBW is set 3kHz.

**TEST RESULTS**

No non-compliance noted.

**Test Data**

Modulation	Frequency (MHz)	20 dB Bandwidth (kHz)
40kbps	908.42	55.10

**Test Plot**

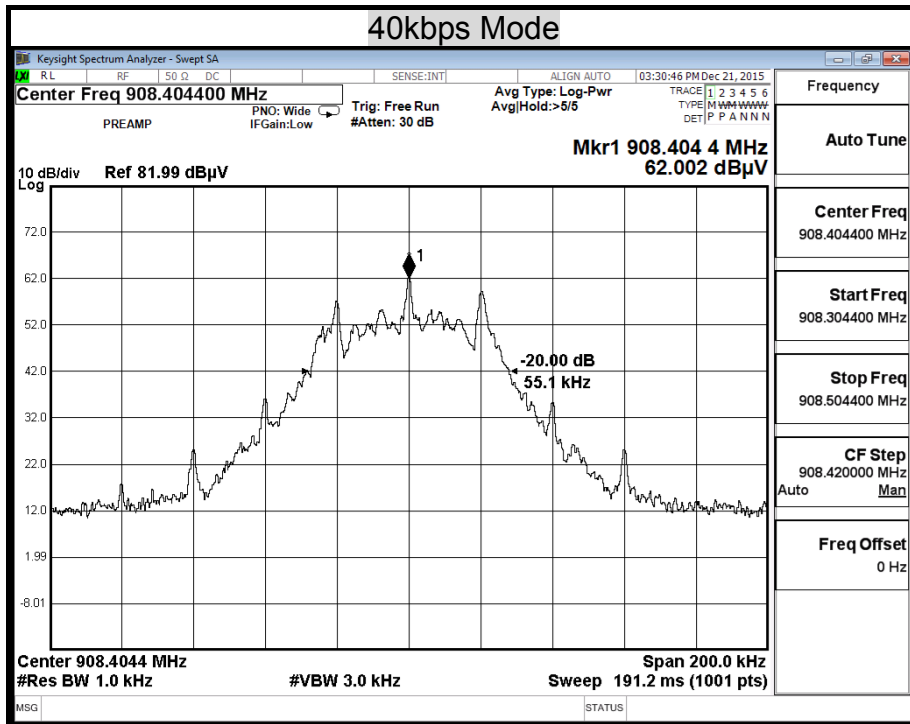

## 7.2 BAND EDGES MEASUREMENT

### LIMIT

1. In the above emission table, the tighter limit applies at the band edges.

Frequency (MHz)	Field Strength ( $\mu\text{V}/\text{m}$ at 3-meter)	Field Strength ( $\text{dB}\mu\text{V}/\text{m}$ at 3-meter)
30-88	100	40
88-216	150	43.5
216-960	200	46
Above 960	500	54

2. As shown in Section 15.35(b), for frequencies above 1000 MHz, the above field strength limits in paragraphs (a) and (b) of this section are based on average limits. However, the peak field strength of any emission shall not exceed the maximum permitted average limits specified above by more than 20 dB under any condition of modulation. For point-to-point operation under paragraph (b) of this section, the peak field strength shall not exceed 2500 millivolts/meter at 3 meters along the antenna azimuth.

### TEST CONFIGURATION

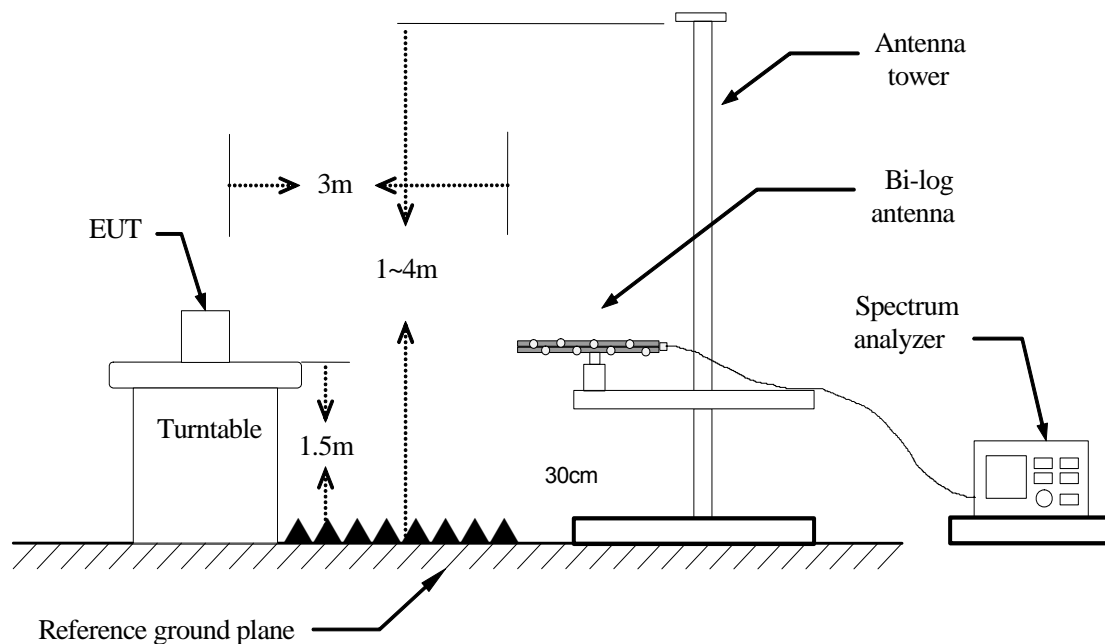



**TEST PROCEDURE**

1. The EUT is placed on a turntable, which is 1.5m above the ground plane.
2. The turntable shall be rotated for 360 degrees to determine the position of maximum emission level.
3. EUT is set 3m away from the receiving antenna, which is varied from 1m to 4m to find out the highest emission.
4. Set the spectrum analyzer in the following setting in order to capture the lower and upper band-edges of the emission:
  - (a) PEAK: RBW=VBW=1MHz / Sweep=AUTO
  - (b) AVERAGE: Peak Level + Duty Factor
5. Repeat the procedures until all the PEAK and AVERAGE versus polarization are measured.

**TEST RESULTS**

- ※ After estimate 20dB bandwidth of 1st and last channel ,the declared frequency will not invade restrict band. There is no requirement for this test.

### 7.3 DUTY CYCLE

#### LIMIT

Nil (No dedicated limit specified in the Rules)

#### MEASUREMENT EQUIPMENT USED

Name of Equipment	Manufacturer	Model	Serial Number	Calibration Due
EXA Spectrum Analyzer	KEYSIGHT	N9010A	MY54430216	JAN. 23, 2016

**Remark:** Each piece of equipment is scheduled for calibration once a year.

#### TEST CONFIGURATIONS

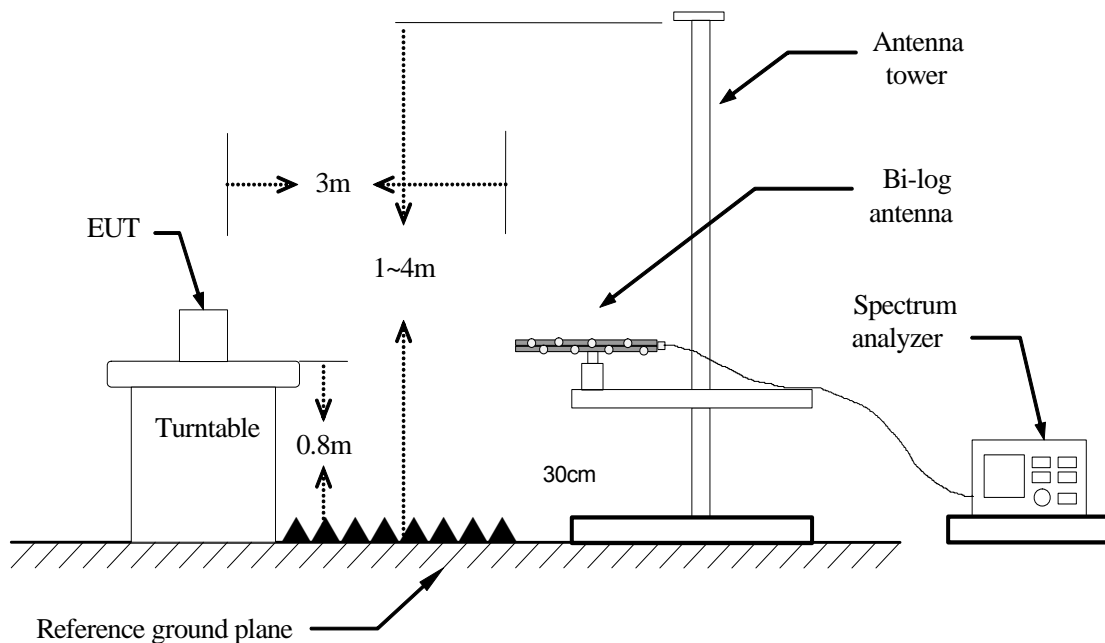

#### TEST PROCEDURE

1. Place the EUT on the table and set it in transmitting mode.
2. Set center frequency of spectrum analyzer = operating frequency.
3. Set the spectrum analyzer as RBW, VBW=100KHz, Span = 0Hz, a suitable Sweep Time.
4. Repeat above procedures until all frequency measured were complete.

#### TEST RESULTS

No non-compliance noted.

**TEST DATA**

	us	Times	Ton	Total Ton time(ms)
Ton1	100000.000	1	100000.000	100.000
Ton2		0	0.000	
Ton3		0	0.000	
Tp				100.000

Ton	100.000
Tp(Ton+Toff)	100.000
Duty Cycle	1.000
Duty Factor	0.000

100 %

**TEST PLOT**

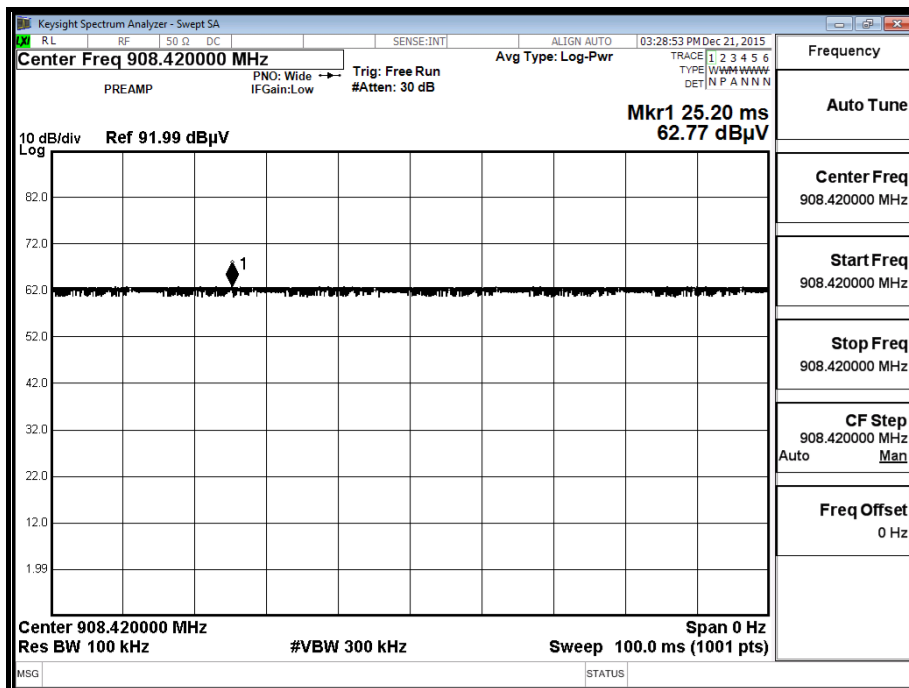

## 7.4 SPURIOUS EMISSION

### LIMIT

1. In the section 15.249(a):

Except as provided in paragraph (b) of this section, the field strength of emissions from intentional radiators operated within these frequency bands shall comply with the following:

Fundamental Frequency (MHz)	Field Strength of Fundamental Field Strength (mV/m)	Field Strength of Harmonics (µV/m)
902-928 MHz	50	500
2400 - 2483.5 MHz	50	500
5725 - 5875 MHz	50	500
24.0 - 24.25 GHz	250	2500

2. Except as provided elsewhere in this Subpart, the emissions from an intentional radiator shall not exceed the field strength levels specified in the following table:

Frequency (MHz)	Field Strength (µV/m)	Measurement Distance (m)
30-88	100*	3
88-216	150*	3
216-960	200*	3
Above 960	500	3

**Remark:** Except as provided in paragraph (g), fundamental emissions from intentional radiators operating under this Section shall not be located in the frequency bands 54-72 MHz, 76-88 MHz, 174-216 MHz or 470-806 MHz. However, operation within these frequency bands is permitted under other sections of this Part, e.g., Sections 15.231 and 15.241.

3. In the above emission table, the tighter limit applies at the band edges.

Frequency (MHz)	Field Strength (µV/m at 3-meter)	Field Strength (dBµV/m at 3-meter)
30-88	100	40
88-216	150	43.5
216-960	200	46
Above 960	500	54

**MEASUREMENT EQUIPMENT USED**

Chamber Room # 966				
Name of Equipment	Manufacturer	Model	Serial Number	Calibration Due
HUBER+SUHNER	Cable	SUCOFLEX 104PEA	SN25737 /4PEA	JAN. 14, 2016
Antenna	Sunol sciences	JB1	A021306	AUG. 02, 2016
LOOP ANTENNA	EMCO	6502	8905-2356	JUN. 10, 2016
Pre-Amplifier	HP	8447F	2443A01671	JAN. 14, 2016
Pre-Amplifier	EMCI	EMC 012645	980098	DEC. 04, 2016
Horn Antenna	Com-Power	AH-118	071032	JAN. 09, 2016
3116 Double Ridge Antenna (40G)	ETS-LINDGREN	3116	00078900	MAR. 04, 2016
Turn Table	Yo Chen	001	-----	N.C.R.
Antenna Tower	AR	TP1000A	309874	N.C.R.
Controller	UC	UC300	-----	N.C.R.
RF Swith	E-INSTRUMENT TELH LTD	ERS-180A	EC1204141	N.C.R
EXA Spectrum Analyzer	KEYSIGHT	N9010A	MY54430216	JAN. 23, 2016
Test S/W	e-3 (5.04303e)			

**Remark:** Each piece of equipment is scheduled for calibration once a year.

## TEST CONFIGURATION

9kHz ~ 30MHz

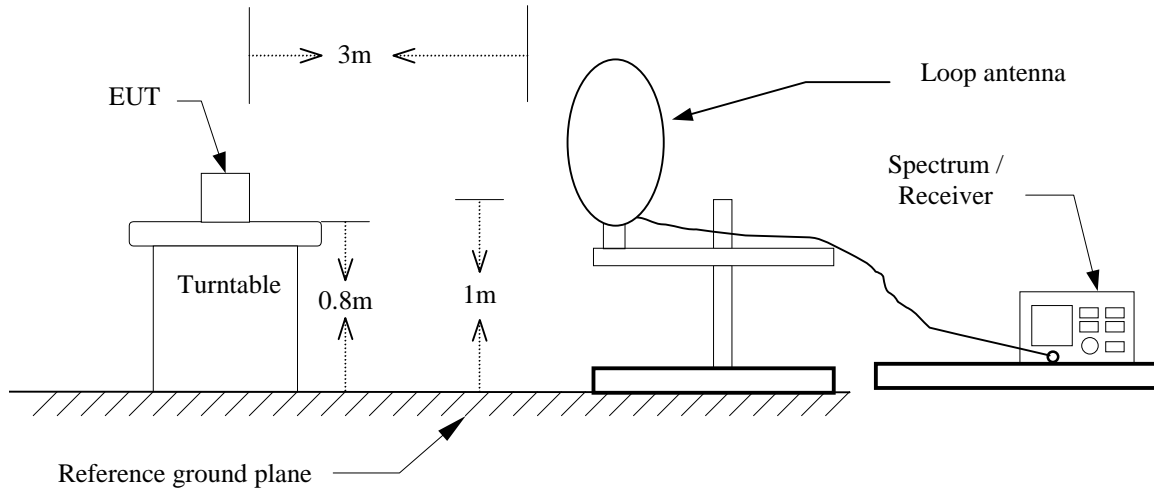

30MHz ~ 1GHz

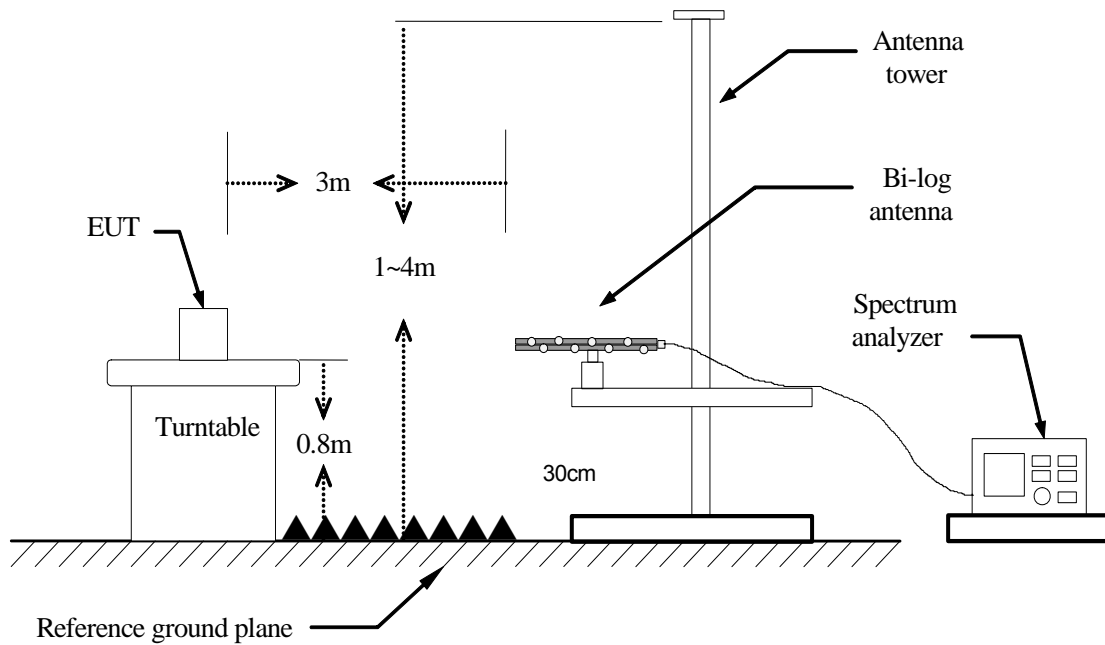

## Above 1 GHz

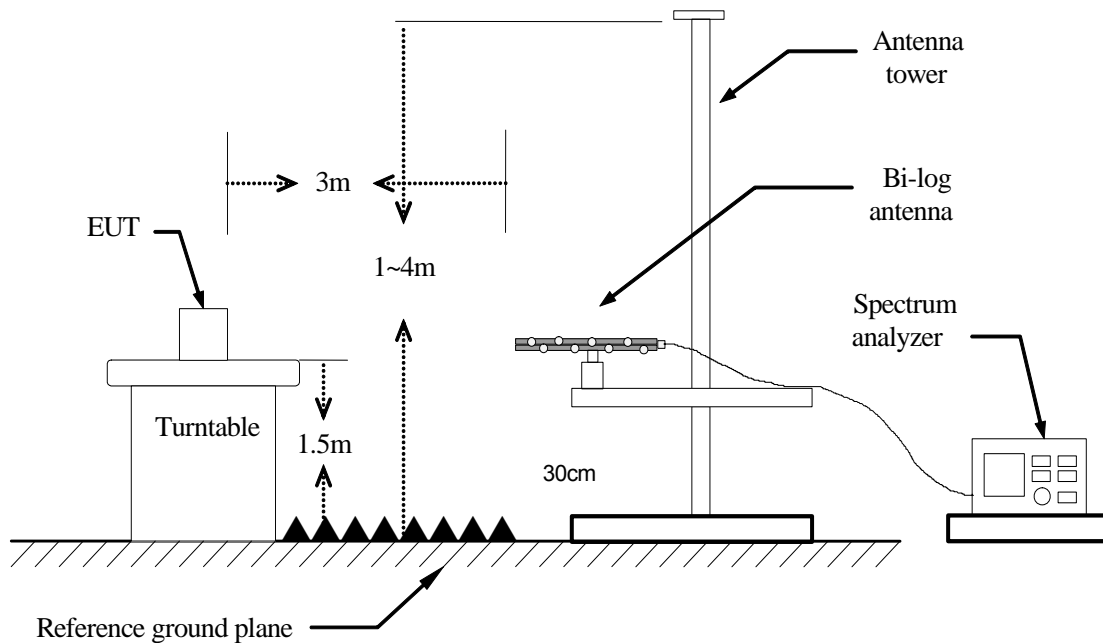

## TEST PROCEDURE

1. The EUT is placed on a turntable, which is 0.8/1.5m above ground plane.
2. The turntable shall be rotated for 360 degrees to determine the position of maximum emission level.
3. EUT is set 3m away from the receiving antenna, which is varied from 1m to 4m to find out the highest emissions.
4. Maximum procedure was performed on the six highest emissions to ensure EUT compliance.
5. And also, each emission was to be maximized by changing the polarization of receiving antenna both horizontal and vertical.
6. Set the spectrum analyzer in the following setting as:  
Below 1GHz:  
RBW=100kHz / VBW=300kHz / Sweep=AUTO  
Above 1GHz:  
(a) PEAK: RBW=VBW=1MHz / Sweep=AUTO  
(b) AVERAGE: RBW=1MHz / VBW=10Hz / Sweep=AUTO
7. Repeat above procedures until the measurements for all frequencies are complete.

**Below 1 GHz**

**Operation Mode:** Normal Operation

**Test Date:** 2015/12/24

**Temperature:** 27.3 °C

**Tested by:** Ted Huang

**Humidity:** 52% RH

**Polarity:** Ver. / Hor.

**Horizontal**

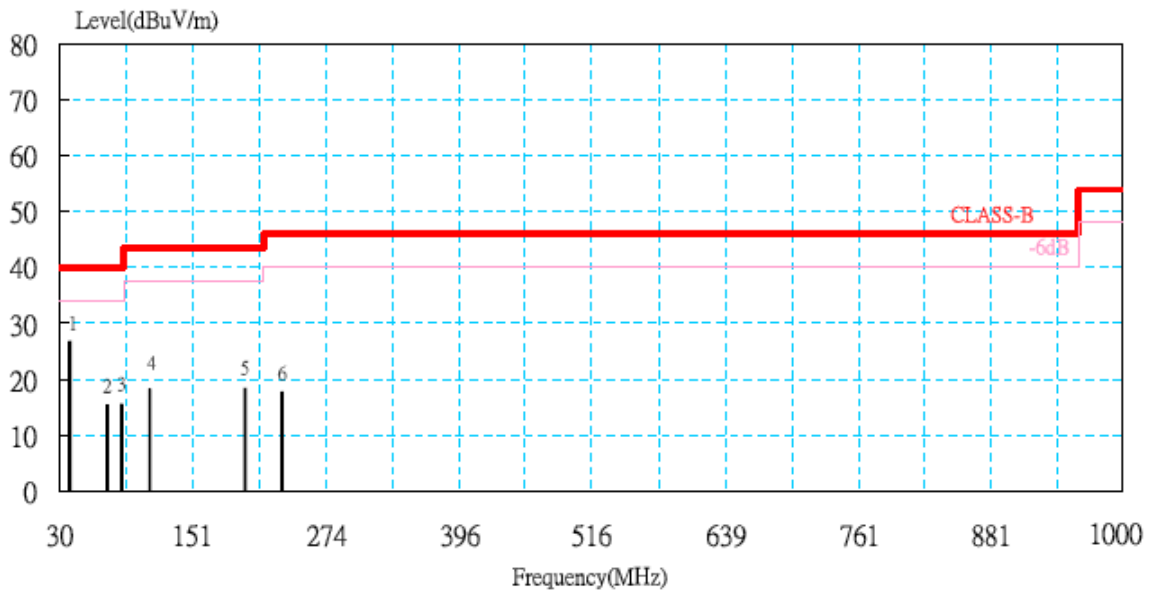

No.	Freq- uency (MHz)	Meter Reading at 3 m Level (dBµV)	Antenna Factor (dB/m)	Cable Loss (dB)	Emission at 3 m Level (dBµV/m)	Limits (dBµV/m)	Margin (dB)	Detector Mode PK/QP
1	39.48	9.86	14.96	1.88	26.70	40.00	-13.30	QP
2	73.65	4.66	8.30	2.31	15.27	40.00	-24.73	QP
3	86.48	4.97	7.92	2.57	15.45	40.00	-24.55	QP
4	112.54	2.46	12.65	3.00	18.11	43.50	-25.39	QP
5	199.84	1.22	13.51	3.56	18.29	43.50	-25.21	QP
6	233.57	1.06	12.72	3.83	17.61	46.00	-28.39	QP

**Remark:**

1. No emission found between lowest internal used/generated frequency to 30MHz (9kHz~30MHz).
2. Radiated emissions measured in frequency range from 30 MHz to 1000MHz were made with an instrument using peak/quasi-peak detector mode.
3. Quasi-peak test would be performed if the peak result were greater than the quasi-peak limit or as required by the applicant.
4. Measurements above show only up to 6 maximum emissions noted, or would be lesser, with " N/A " remark, if no specific emissions from the EUT are recorded (ie: margin>20dB from the applicable limit) and considered that's already beyond the background noise floor.
5. Margin (dB) = Remark result (dBuV/m) – Quasi-peak limit (dBuV/m).
6. That the limit for signals below 1GHz is a QP limit and peak readings are below the QP limit.
7. The fundamental signal is not shown in the test data because measurements at fundamental frequency are shown separately and were ignored during the 30 – 1000 MHz scan.



**Operation Mode:** Normal Operation

**Test Date:** 2015/12/24

**Temperature:** 27.3 °C

**Tested by:** Ted Huang

**Humidity:** 52% RH

**Polarity:** Ver. / Hor.

**Vertical**

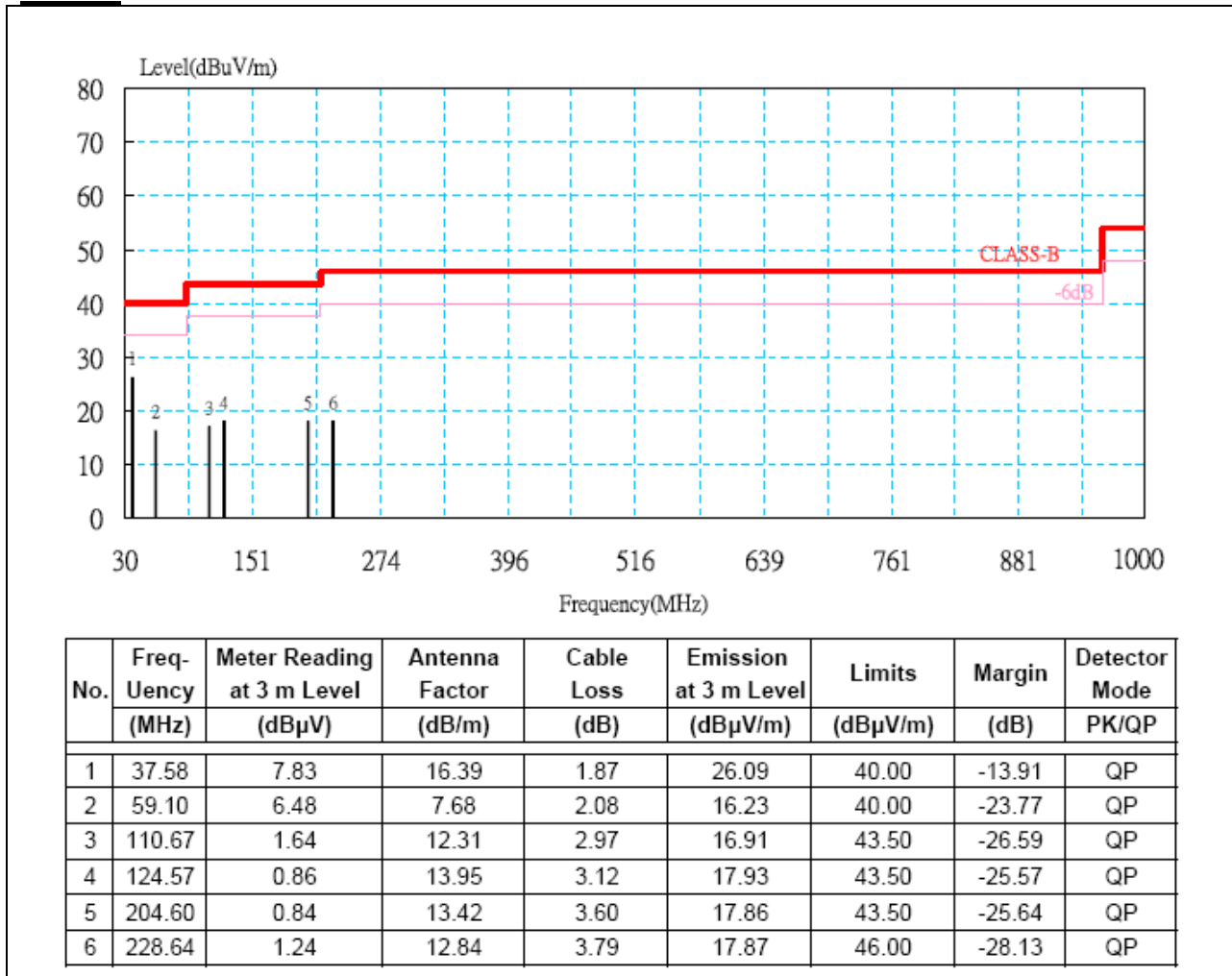

**Remark:**

1. No emission found between lowest internal used/generated frequency to 30MHz (9kHz~30MHz).
2. Radiated emissions measured in frequency range from 30 MHz to 1000MHz were made with an instrument using peak/quasi-peak detector mode.
3. Quasi-peak test would be performed if the peak result were greater than the quasi-peak limit or as required by the applicant.
4. Measurements above show only up to 6 maximum emissions noted, or would be lesser, with " N/A " remark, if no specific emissions from the EUT are recorded (ie: margin>20dB from the applicable limit) and considered that's already beyond the background noise floor.
5. Margin (dB) = Remark result (dBuV/m) – Quasi-peak limit (dBuV/m).
6. That the limit for signals below 1GHz is a QP limit and peak readings are below the QP limit.
7. The fundamental signal is not shown in the test data because measurements at fundamental frequency are shown separately and were ignored during the 30 – 1000 MHz scan.

**The fundamental signal**

**Operation Mode:** TX / 40kbps Mode (Y axis)

**Test Date:** 2015/12/23

**Temperature:** 27.4 °C

**Tested by:** Ted Huang

**Humidity:** 58% RH

**Polarity:** Ver. / Hor.

**Horizontal**

Freq.	Reading	AF	Cable Loss	Pre-amp	Filter	Level	Limit	Margin	Mark
(MHz)	(dBμV)	(dB/m)	(dB)	(dB)	(dB)	(dBμV/m)	(dBμV/m)	(dB)	(P/Q/A)
908.42	48.88	22.10	5.95	24.41	0.00	67.44	114.00	-46.56	P
908.42	48.63	22.10	5.95	24.41	0.00	67.19	94.00	-26.81	Q

**Vertical**

Freq.	Reading	AF	Cable Loss	Pre-amp	Filter	Level	Limit	Margin	Mark
(MHz)	(dBμV)	(dB/m)	(dB)	(dB)	(dB)	(dBμV/m)	(dBμV/m)	(dB)	(P/Q/A)
908.42	45.53	22.10	5.95	24.41	0.00	64.08	114.00	-49.92	P
908.42	45.11	22.10	5.95	24.41	0.00	63.67	94.00	-30.33	Q

**Remark:**

*Margin (dB) = Remark result (dBuV/m) – Quasi-peak limit (dBuV/m).*

**Above 1 GHz**

**Operation Mode:** TX / 40kbps Mode (Y axis)

**Test Date:** 2015/12/23

**Temperature:** 27.4 °C

**Tested by:** Ted Huang

**Humidity:** 58% RH

**Polarity:** Ver. / Hor.

Horizontal

Freq.	Reading	AF	Cable Loss	Pre-amp	Filter	Level	Limit	Margin	Mark
(MHz)	(dBµV)	(dB/m)	(dB)	(dB)	(dB)	(dBµV/m)	(dBµV/m)	(dB)	(P/Q/A)
* 2725.32	64.56	30.38	2.77	47.29	0.30	50.71	74.00	-23.29	P
* 2725.32	58.10	30.38	2.77	47.29	0.30	44.26	54.00	-9.74	A
* 3633.72	64.62	31.04	3.23	47.60	0.30	51.60	74.00	-22.40	P
* 3633.72	55.26	31.04	3.23	47.60	0.30	42.23	54.00	-11.77	A
6358.83	61.64	36.26	4.36	47.67	0.40	55.00	74.00	-19.00	P
6358.83	53.53	36.26	4.36	47.67	0.40	46.89	54.00	-7.11	A
* 7267.14	64.20	39.59	4.56	47.84	0.45	60.96	74.00	-13.04	P
* 7267.14	53.37	39.59	4.56	47.84	0.45	50.13	54.00	-3.87	A
* 8175.44	62.97	39.36	4.64	47.07	0.50	60.40	74.00	-13.60	P
* 8175.44	53.29	39.36	4.64	47.07	0.50	50.72	54.00	-3.28	A

**Remark:**

1. Measuring frequencies from 1 GHz to the 10th harmonic of highest fundamental frequency.
2. Radiated emissions measured in frequency above 1000MHz were made with an instrument using peak/average detector mode.
3. Average test would be performed if the peak result were greater than the average limit or as required by the applicant.
4. Data of measurement within this frequency range shown " --- " in the table above means the reading of emissions are attenuated more than 20dB below the permissible limits or the field strength is too small to be measured.
5. Measurements above show only up to 6 maximum emissions noted, or would be lesser, with " N/A " remark, if no specific emissions from the EUT are recorded (ie: margin>20dB from the applicable limit) and considered that's already beyond the background noise floor.
6. Margin (dB) = Remark result (dBuV/m) – Average limit (dBuV/m). Peak detector mode and average detector mode of the emission shown in Result column.

**Operation Mode:** TX / 40kbps Mode (Y axis)

**Test Date:** 2015/12/23

**Temperature:** 27.4 °C

**Tested by:** Ted Huang

**Humidity:** 58% RH

**Polarity:** Ver. / Hor.

Vertical

Freq.	Reading	AF	Cable Loss	Pre-amp	Filter	Level	Limit	Margin	Mark
(MHz)	(dBµV)	(dB/m)	(dB)	(dB)	(dB)	(dBµV/m)	(dBµV/m)	(dB)	(P/Q/A)
* 2725.22	68.62	30.38	2.77	47.29	0.30	54.78	74.00	-19.22	P
* 2725.22	65.30	30.38	2.77	47.29	0.30	51.46	54.00	-2.54	A
* 3633.61	66.49	31.04	3.23	47.60	0.30	53.46	74.00	-20.54	P
* 3633.61	61.41	31.04	3.23	47.60	0.30	48.38	54.00	-5.62	A
6358.74	64.16	36.26	4.36	47.67	0.40	57.51	74.00	-16.49	P
6358.74	54.55	36.26	4.36	47.67	0.40	47.90	54.00	-6.10	A
* 7267.29	64.75	39.59	4.56	47.84	0.45	61.50	74.00	-12.50	P
* 7267.29	55.07	39.59	4.56	47.84	0.45	51.83	54.00	-2.17	A
* 8175.95	63.63	39.36	4.64	47.07	0.50	61.06	74.00	-12.94	P
* 8175.95	53.61	39.36	4.64	47.07	0.50	51.04	54.00	-2.96	A

**Remark:**

1. Measuring frequencies from 1 GHz to the 10th harmonic of highest fundamental frequency.
2. Radiated emissions measured in frequency above 1000MHz were made with an instrument using peak/average detector mode.
3. Average test would be performed if the peak result were greater than the average limit or as required by the applicant.
4. Data of measurement within this frequency range shown " --- " in the table above means the reading of emissions are attenuated more than 20dB below the permissible limits or the field strength is too small to be measured.
5. Measurements above show only up to 6 maximum emissions noted, or would be lesser, with " N/A " remark, if no specific emissions from the EUT are recorded (ie: margin>20dB from the applicable limit) and considered that's already beyond the background noise floor.
6. Margin (dB) = Remark result (dBuV/m) – Average limit (dBuV/m). Peak detector mode and average detector mode of the emission shown in Result column.

## 7.5 POWERLINE CONDUCTED EMISSIONS

### LIMIT

According to §15.207(a), except as shown in paragraphs (b) and (c) of this section, for an intentional radiator that is designed to be connected to the public utility (AC) power line, the radio frequency voltage that is conducted back onto the AC power line on any frequency or frequencies within the band 150 kHz to 30 MHz shall not exceed the limits in the following table, as measured using a 50  $\mu$ H/50 ohms line impedance stabilization network (LISN). Compliance with the provisions of this paragraph shall be based on the measurement of the radio frequency voltage between each power line and ground at the power terminal. The lower limit applies at the boundary between the frequency ranges.

Frequency Range (MHz)	Limits (dB $\mu$ V)	
	Quasi-peak	Average
0.15 to 0.50	66 to 56	56 to 46
0.50 to 5	56	46
5 to 30	60	50

Compliance with this provision shall be based on the measurement of the radio frequency voltage between each power line (LINE and NEUTRAL) and ground at the power terminals.

### MEASUREMENT EQUIPMENT USED

Conducted Emission room #1				
Name of Equipment	Manufacturer	Model	Serial Number	Calibration Due
L.I.S.N.	SCHWARZBECK	NNLK 8130	8130124	OCT. 27, 2016
	Rohde & Schwarz	ESH 3-Z5	893540/015	APR. 12, 2016
TEST RECEIVER	Rohde & Schwarz	ESCS 30	100348	DEC. 06, 2016
BNC COAXIAL CABLE	CCS	BNC50	11	DEC. 04, 2016
R.F.Current Probe	SOLAR	9208-1	041037	APR. 01, 2016
Capacitive Voltage Probe	SCHAFFNER	CVP 2200	15984	APR. 01, 2016
Test S/W	e-3 (5.04211c) R&S (2.27)			

**Remark:** Each piece of equipment is scheduled for calibration once a year.

### TEST RESULTS

✘ This EUT is not connected to AC Source directly. Not applicable for this test.