

FCC 47 CFR PART 15 SUBPART C: 2014 AND ANSI C63.10: 2013

TEST REPORT

For

Z-Wave Smart Gateway

Model: ZA1002US-5

Brand: VISION

Issued for

Vision Automobile Electronics Industrial Co., Ltd.

No. 78, Gongye 3rd Rd., Technology Industrial Park, Tainan City 70955, Taiwan (R.O.C.)

Issued by

Compliance Certification Services Inc.

Tainan Lab.

No.8, Jiucengling, Xinhua Dist., Tainan City 712, Taiwan (R.O.C.)

TEL: 886-6-580-2201

FAX: 886-6-580-2202

Date of Issue: December 09, 2015



Note: This report shall not be reproduced except in full, without the written approval of Compliance Certification Services Inc. Ltd. This document may be altered or revised by Compliance Certification Services Inc. personnel only, and shall be noted in the revision section of the document

REVISION HISTORY

Rev.	Issue Date	Revisions	Effect Page	Revised By
00	December 09, 2015	Initial Issue	ALL	Sunny Chang

TABLE OF CONTENTS.

1. TEST REPORT CERTIFICATION 4

2. EUT DESCRIPTION 5

3. DESCRIPTION OF TEST MODES 6

4. TEST METHODOLOGY 7

5. FACILITIES AND ACCREDITATIONS..... 7

 5.1 FACILITIES 7

 5.2 EQUIPMENT 7

 5.3 LABORATORY ACCREDITATIONS LISTINGS 7

 5.4 TABLE OF ACCREDITATIONS AND LISTINGS 8

6. CALIBRATION AND UNCERTAINTY 9

 6.1 MEASURING INSTRUMENT CALIBRATION..... 9

 6.2 MEASUREMENT UNCERTAINTY 9

7. SETUP OF EQUIPMENT UNDER TEST 10

 7.1 SETUP CONFIGURATION OF EUT 10

 7.2 SUPPORT EQUIPMENT 11

 7.3 EUT OPERATING CONDITION..... 12

8. APPLICABLE LIMITS AND TEST RESULTS..... 13

 8.1 6DB BANDWIDTH..... 13

 8.2 MAXIMUM PEAK OUTPUT POWER 24

 8.3 DUTY CYCLE 45

 8.4 POWER SPECTRAL DENSITY 55

 8.5 CONDUCTED SPURIOUS EMISSION..... 65

 8.6 RADIATED EMISSIONS 74

 8.6.1 TRANSMITTER RADIATED SUPURIOUS EMSSIONS..... 74

 8.6.2 WORST-CASE RADIATED EMISSION BELOW 1 GHZ 79

 8.6.3 TRANSMITTER RADIATED EMISSION ABOVE 1 GHZ 81

 8.6.4 RESTRICTED BAND EDGES..... 93

 8.7 POWERLINE CONDUCTED EMISSIONS 109

9. ANTENNA REQUIREMENT 113

 9.1 STANDARD APPLICABLE 113

 9.2 ANTENNA CONNECTED CONSTRUCTION 113

APPENDIX II PHOTOGRAPHS OF EU..... A1

1. TEST REPORT CERTIFICATION

Applicant : **Vision Automobile Electronics Industrial Co., Ltd.**
 No. 78, Gongye 3rd Rd., Technology Industrial Park, Tainan City 70955, Taiwan (R.O.C.)

Manufacturer : **Vision Automobile Electronics Industrial Co., Ltd.**
 No. 78, Gongye 3rd Rd., Technology Industrial Park, Tainan City 70955, Taiwan (R.O.C.)

Equipment Under Test : Z-Wave Smart Gateway

Model : ZA1002US-5

Brand : **VISION**

Date of Test : December 01, 2015 ~ December 03, 2015

APPLICABLE STANDARD	
STANDARD	TEST RESULT
FCC Part 15 Subpart C: 2014 AND ANSI C63.10: 2013	No non-compliance noted

Approved by:



Jeter Wu
Assistant Manager

Reviewed by:

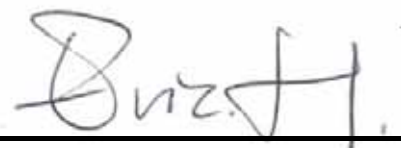

Eric Huang
Assistant Section Manager

2. EUT DESCRIPTION

Product Name	Z-Wave Smart Gateway
Model	ZA1002US-5
Brand	VISION
Received Date	October 26, 2015
Frequency Range	IEEE 802.11b/g, 802.11n HT20 (DTS Band):2412MHz~2462MHz IEEE 802.11n HT40 (DTS Band):2422MHz~2452MHz
Transmit Power	IEEE 802.11b Mode : 1.62dBm (DTS Band) (1.4521mW) IEEE 802.11g Mode : 10.28dBm (DTS Band) (10.666mW) IEEE 802.11n HT20 Mode : 8.73dBm (DTS Band) (7.4645mW) IEEE 802.11n HT40 Mode : 10.86dBm (DTS Band) (12.19mW)
Channel Spacing	IEEE 802.11b/g, 802.11n HT20/HT40: 5MHz
Channel Number	IEEE 802.11b/g, 802.11n HT20:11 Channels IEEE 802.11n HT40 :7 Channels
Transmit Data Rate	IEEE 802.11b : 11, 5.5, 2, 1 Mbps IEEE 802.11g : 54, 48, 36, 24, 18, 12, 9, 6 Mbps IEEE 802.11n (HT20) : Up to 300 Mbps IEEE 802.11n (HT40) : Up to 300 Mbps
Type of Modulation	IEEE 802.11b : DSSS (CCK, DQPSK, DBPSK)
	IEEE 802.11g : OFDM (64QAM, 16QAM, QPSK, BPSK)
	IEEE 802.11n HT20/HT40 : OFDM (64QAM, 16QAM, QPSK, BPSK)
Frequency Selection	By software / firmware
Antenna Type	Antenna (1TX1RX) Type: PCB Mode: AVA88 Gain : 5.3 dBi
Temperature Range	-15°C ~ +60°C

Power Adapter :

No.	Manufacturer	Model No.	Power Input	Power Output
1	I.T.E.POWER SUPPLY	HORIZON-794mu	100-240Vac~50/60Hz, 0.5A	12Vdc, 1A

REMARK:

1. The sample (**ZA1002US-5**) selected for test was engineering sample that approximated to production product and was provided by manufacturer.
2. This submittal(s) (test report) is intended for FCC ID: **KFR-ZA1002US-5** filing to comply with Section 15.207, 15.209 and 15.247 of the FCC Part 15, Subpart C Rules.
3. For more details, please refer to the User's manual of the EUT.

3. DESCRIPTION OF TEST MODES

The EUT is a 11n router. It has two transmitter chains and two receive chains (1x1 configurations). The 1x1 configuration is implemented with two outside chains (Chain 0).

The RF chipset is manufactured by Atheros

The antenna peak gain 5.3dBi (highest gain) were chosen for full testing.

IEEE 802.11 b ,802.11g ,802.11n HT20 mode (DTS Band)

The EUT had been tested under operating condition.

There are three channels have been tested as following:

Channel	Frequency (MHz)
Low	2412
Middle	2437
High	2462

IEEE 802.11b mode: 1Mbps long data rate (worst case) were chosen for full testing.

IEEE 802.11g mode: 6Mbps data rate (worst case) were chosen for full testing.

IEEE 802.11n HT20 mode: 6.5Mbps data rate (worst case) were chosen for full testing.

IEEE 802.11n HT40 mode (DTS Band)

The EUT had been tested under operating condition.

There are three channels have been tested as following:

Channel	Frequency (MHz)
Low	2422
Middle	2437
High	2452

IEEE 802.11n HT40 mode: 13Mbps data rate (worst case) were chosen for full testing.

The worst-case data rates are determined according to the description above, based on the investigations by measuring the PSD, peak power and average power across all the data rates, bandwidths, modulations and spatial stream modes.

4. TEST METHODOLOGY

The tests documented in this report were performed in accordance with ANSI C63.10 and FCC CFR 47 15.207, 15.209 and 15.247.

5. FACILITIES AND ACCREDITATIONS

5.1 FACILITIES

All measurement facilities used to collect the measurement data are located at No.8, Jiucengling, Xinhua Dist., Tainan City 712, Taiwan (R.O.C.)

The sites are constructed in conformance with the requirements of ANSI C63.7, ANSI C63.10 and CISPR Publication 22.

5.2 EQUIPMENT

Radiated emissions are measured with one or more of the following types of linearly polarized antennas: tuned dipole, bi-conical, log periodic, bi-log, and/or ridged waveguide, horn. Spectrum analyzers with pre-selectors and quasi-peak detectors are used to perform radiated measurements.

Conducted emissions are measured with Line Impedance Stabilization Networks and EMI Test Receivers.

Calibrated wideband preamplifiers, coaxial cables, and coaxial attenuators are also used for making measurements.

All receiving equipment conforms to CISPR Publication 16-1, "Radio Interference Measuring Apparatus and Measurement Methods."

5.3 LABORATORY ACCREDITATIONS LISTINGS

The test facilities used to perform radiated and conducted emissions tests are accredited by Taiwan Accreditation Foundation for the specific scope of accreditation under Lab Code: 1109 to perform Electromagnetic Interference tests according to FCC PART 15 AND CISPR 22 requirements. No part of this report may be used to claim or imply product endorsement by TAF or any agency of the Government. In addition, the test facilities are listed with Federal Communications Commission (registration no: TW-1037 and 455173).

5.4 TABLE OF ACCREDITATIONS AND LISTINGS

Our laboratories are accredited and approved by the following accreditation body according to ISO/IEC 17025.

Taiwan	TAF
---------------	-----

The measuring facility of laboratories has been authorized or registered by the following approval agencies.

Canada	Industry Canada
Germany	TUV NORD
Taiwan	BSMI
USA	FCC

Copies of granted accreditation certificates are available for downloading from our web site, <http://www.ccsrf.com>

6. CALIBRATION AND UNCERTAINTY

6.1 MEASURING INSTRUMENT CALIBRATION

The measuring equipment utilized to perform the tests documented in this report has been calibrated in accordance with the manufacturer’s recommendations, and is traceable to recognized national standards.

6.2 MEASUREMENT UNCERTAINTY

Where relevant, the following measurement uncertainty levels have been estimated for tests performed on the apparatus:

Parameter	Uncertainty
Radiated Emission, 30 to 200 MHz Test Site : OATS-6	±3.21dB
Radiated Emission, 200 to 1000 MHz Test Site : OATS-6	±3.09dB
Radiated Emission, 1 to 8 GHz	± 2.65dB
Radiated Emission, 8 to 18 GHz	± 2.66dB
Radiated Emission, 18 to 26.5 GHz	± 2.65dB
Radiated Emission, 26 to 40 GHz	± 3.03dB
Power Line Conducted Emission	±1.91dB
Band Width	136.49kHz
Peak Output Power MU	±1.34dB
Band Edge MU	±0.30dBuV
Channel Separation MU	361.69Hz
Duty Cycle MU	0.064ms
Frequency Stability MU	0.223kHz

Uncertainty figures are valid to a confidence level of 95%, K=2

7. SETUP OF EQUIPMENT UNDER TEST

7.1 SETUP CONFIGURATION OF EUT

For RF test

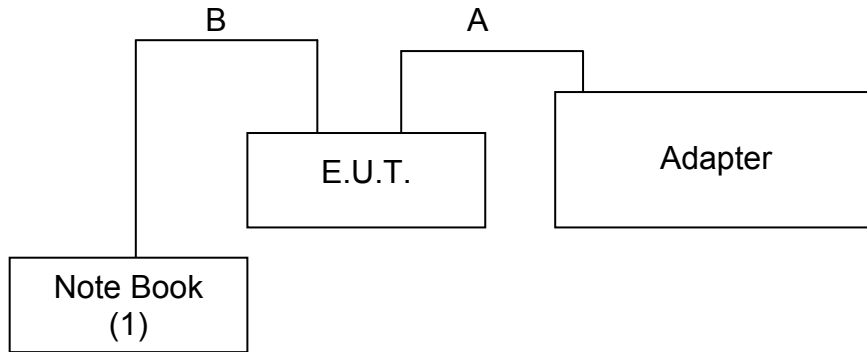

For EMI test

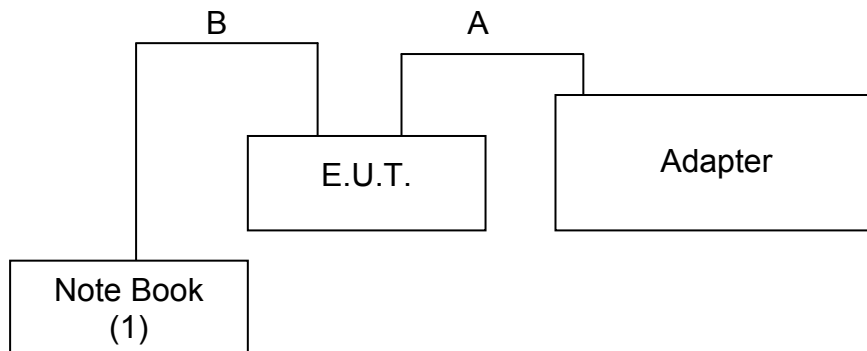

7.2 SUPPORT EQUIPMENT

RF test

No.	Product	Manufacturer	Model No.	Certify No.	Signal cable
1.	Notebook	ASUS	X54C	DOC	Power cable, unshd, 1.6m

No.	Signal cable description	
A	Power	Unshielded, 1.5m, 1pcs
B	LAN	Unshielded, 10m, 1pcs

EMI test

No.	Product	Manufacturer	Model No.	Certify No.	Signal cable
1	Notebook	ASUS	X54C	DOC	Power cable, unshd, 1.6m

No.	Signal cable description	
A	Power	Unshielded, 1.5m, 1pcs
B	LAN	Unshielded, 10m, 1pcs

REMARK:

1. All the above equipment/cables were placed in worse case positions to maximize emission signals during emission test.
2. Grounding was established in accordance with the manufacturer's requirements and conditions for the intended use.

7.3 EUT OPERATING CONDITION

RF Setup

1. Set up all computers like the setup diagram.
2. The Test Program for "artgui.exe" software was used for testing
3. "Home" -> "Load Cards" , DUT"IP Address" set "192.168.1.2",and push button "Load Card"button.
4. "Tests" -> "ContTx"

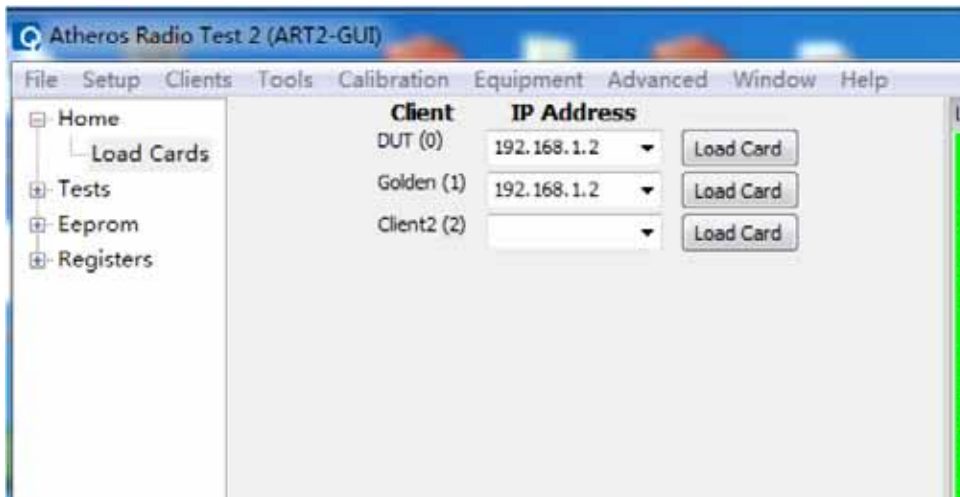

TX Mode:

- ⇒ **Tx Mode:**CCK 、 OFDM、 HT MixMode (Bandwidth: 20、 40)
- ⇒ **Tx Data Rate:** 1Mbps long (IEEE 802.11b mode ,chain 0 TX)
 - 6Mbps** (IEEE 802.11g mode ,chain 0 TX)
 - 6.5Mbps** (IEEE 802.11n HT20 mode ,chain 0)
 - 13Mbps** (IEEE 802.11n HT40 mode, chain 0)

Power control mode

- Target Power:** IEEE 802.11b Channel Low (2412MHz) = 1.5
IEEE 802.11b Channel Middle (2437MHz) = 2.5
IEEE 802.11b Channel High (2462MHz) = 3.5
- Target Power:** IEEE 802.11g Channel Low (2412MHz) = 4.0
IEEE 802.11g Channel Middle (2437MHz) = 5.0
IEEE 802.11g Channel High (2462MHz) = 4.0
- Target Power:** IEEE 802.11 n HT20 Channel Low (2412MHz) = 3.0
IEEE 802.11 n HT20 Channel Middle (2437MHz) = 4.0
IEEE 802.11 n HT20 Channel High (2462MHz) = 4.0
- Target Power:** IEEE 802.11 n HT40 Channel Low (2422MHz) = 4.0
IEEE 802.11 n HT40 Channel Middle (2437MHz) = 4.0
IEEE 802.11 n HT40 Channel High (2452MHz) = 4.0

RX Mode :

Start RX

8. APPLICABLE LIMITS AND TEST RESULTS

8.1 6DB BANDWIDTH

LIMIT

§ 15.247(a) (2) For direct sequence systems, the minimum 6dB bandwidth shall be at least 500kHz

TEST EQUIPMENTS

Name of Equipment	Manufacturer	Model	Serial Number	Calibration Due
EXA Spectrum Analyzer	KEYSIGHT	N9010A	MY54430216	JAN. 23, 2016

TEST SETUP

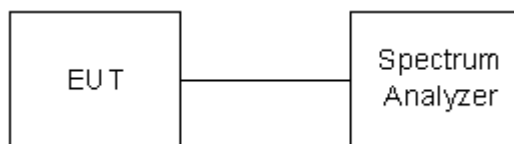

TEST PROCEDURE

1. Set resolution bandwidth (RBW) = 1-5 % of the emission bandwidth (EBW).
2. Set the video bandwidth (VBW) $\geq 3 \times$ RBW.
3. Detector = Peak.
4. Trace mode = max hold.
5. Sweep = auto couple.
6. Allow the trace to stabilize.
7. Measure the maximum width of the emission that is constrained by the frequencies associated with the two outermost amplitude points (upper and lower) that are attenuated by 6 dB relative to the maximum level measured in the fundamental emission. Compare the resultant bandwidth with the RBW setting of the analyzer. Readjust RBW and repeat measurement as needed until the RBW/EBW ratio is 1-5 %.

TEST RESULTS

No non-compliance noted.

Model Name	ZA1002US-5	Test By	Ted Huang
Temp & Humidity	28.6°C, 57%	Test Date	2015/12/03

IEEE 802.11b mode

Channel	Channel Frequency (MHz)	6dB Bandwidth (MHz)	Minimum Limit (kHz)	Pass / Fail
Low	2412	10.12	500	PASS
Middle	2437	10.12	500	PASS
High	2462	10.11	500	PASS

NOTE :

1. At final test to get the worst-case emission at 1Mbps long.
2. The cable assembly insertion loss of 11.1dB (including 10 dB pad and 1.1 dB cable) was entered as an offset in the spectrum analyzer to allow for direct reading of power.

IEEE 802.11g mode

Channel	Channel Frequency (MHz)	6dB Bandwidth (MHz)	Minimum Limit (kHz)	Pass / Fail
Low	2412	16.59	500	PASS
Middle	2437	16.60	500	PASS
High	2462	16.58	500	PASS

NOTE :

1. At final test to get the worst-case emission at 6Mbps.
2. The cable assembly insertion loss of 11.1dB (including 10 dB pad and 1.1 dB cable) was entered as an offset in the spectrum analyzer to allow for direct reading of power.

IEEE 802.11n HT20 mode

Channel	Channel Frequency (MHz)	6dB Bandwidth (MHz)	Minimum Limit (kHz)	Pass / Fail
		Chain 0		
Low	2412	17.82	500	PASS
Middle	2437	17.81	500	PASS
High	2462	17.83	500	PASS

NOTE :

1. At final test to get the worst-case emission at 6.5Mbps.
2. The cable assembly insertion loss of 11.1dB (including 10 dB pad and 1.1 dB cable) was entered as an offset in the spectrum analyzer to allow for direct reading of power.

IEEE 802.11n HT40 mode

Channel	Channel Frequency (MHz)	6dB Bandwidth (MHz)	Minimum Limit (kHz)	Pass / Fail
		Chain 0		
Low	2422	36.60	500	PASS
Middle	2437	36.62	500	PASS
High	2452	36.60	500	PASS

NOTE :

1. At final test to get the worst-case emission at 13Mbps.
2. The cable assembly insertion loss of 11.1dB (including 10 dB pad and 1.1 dB cable) was entered as an offset in the spectrum analyzer to allow for direct reading of power.

6dB BANDWIDTH (802.11b MODE)

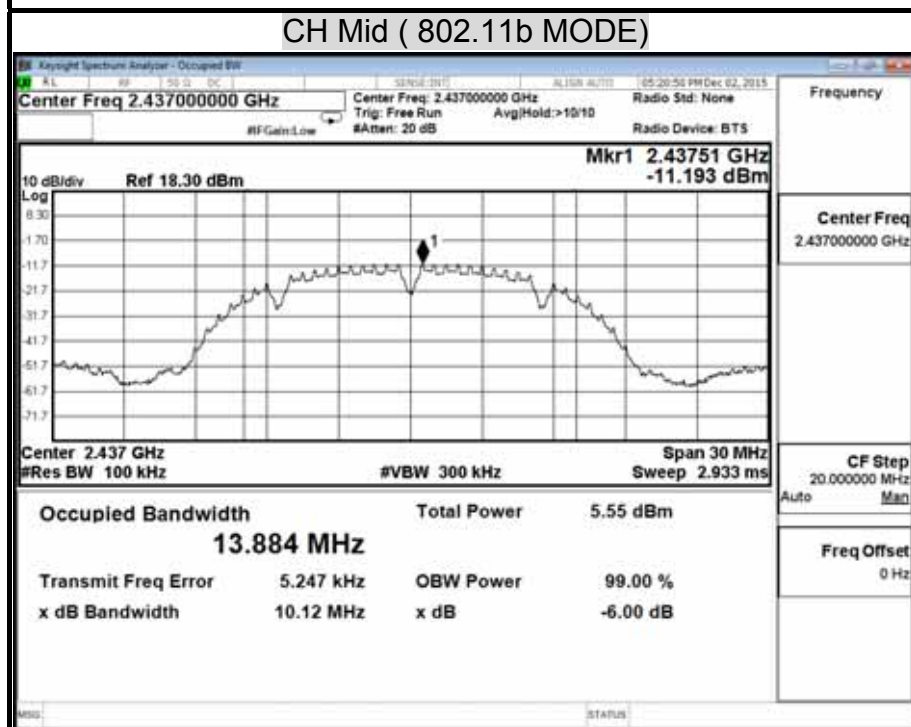
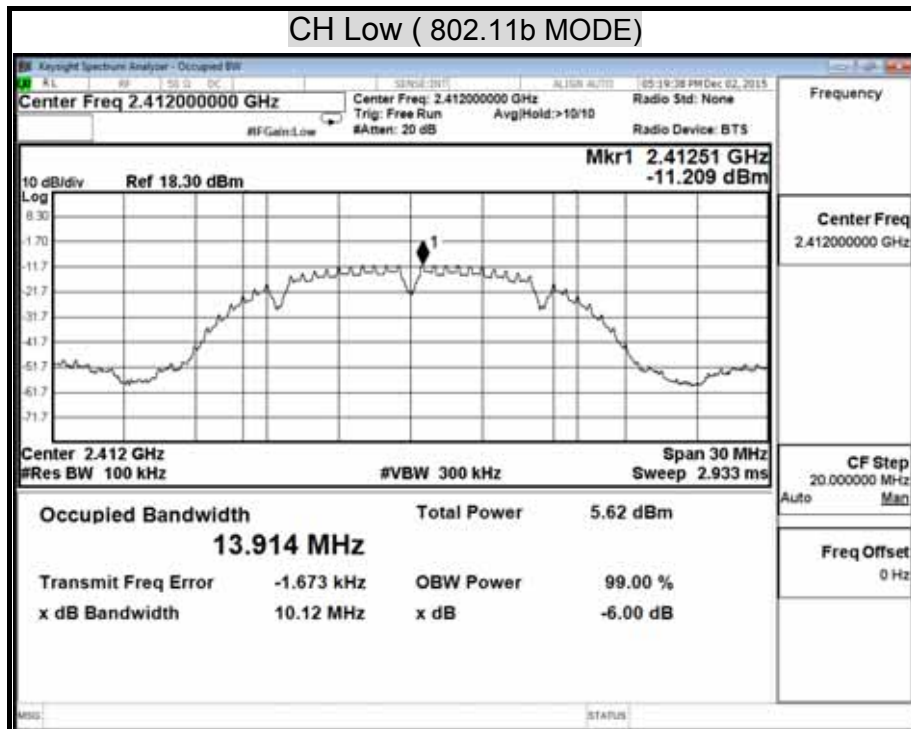

6dB BANDWIDTH (802.11g MODE)

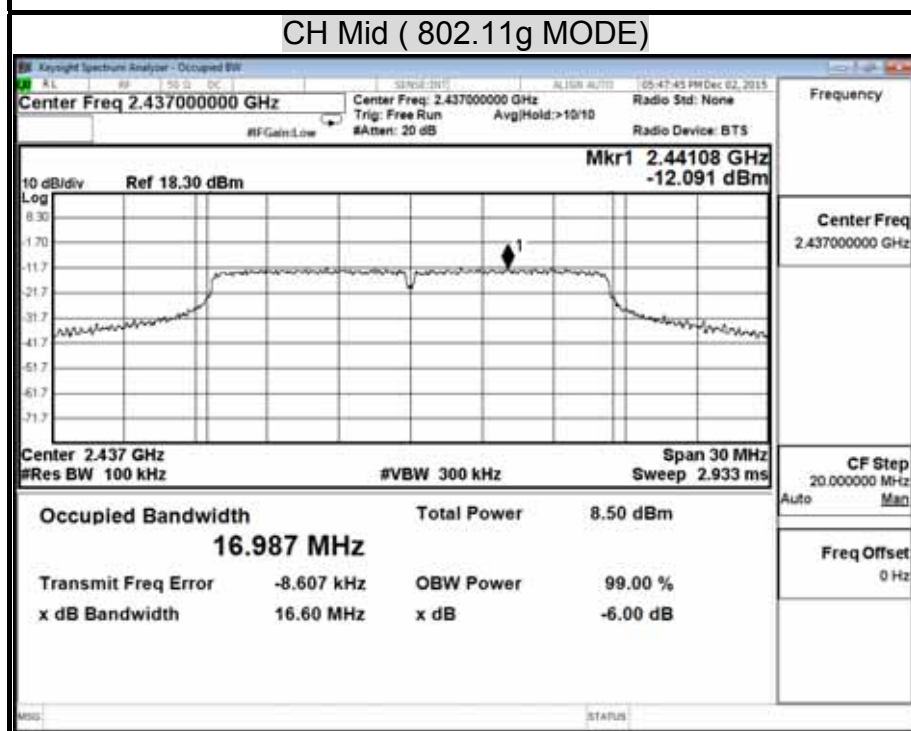
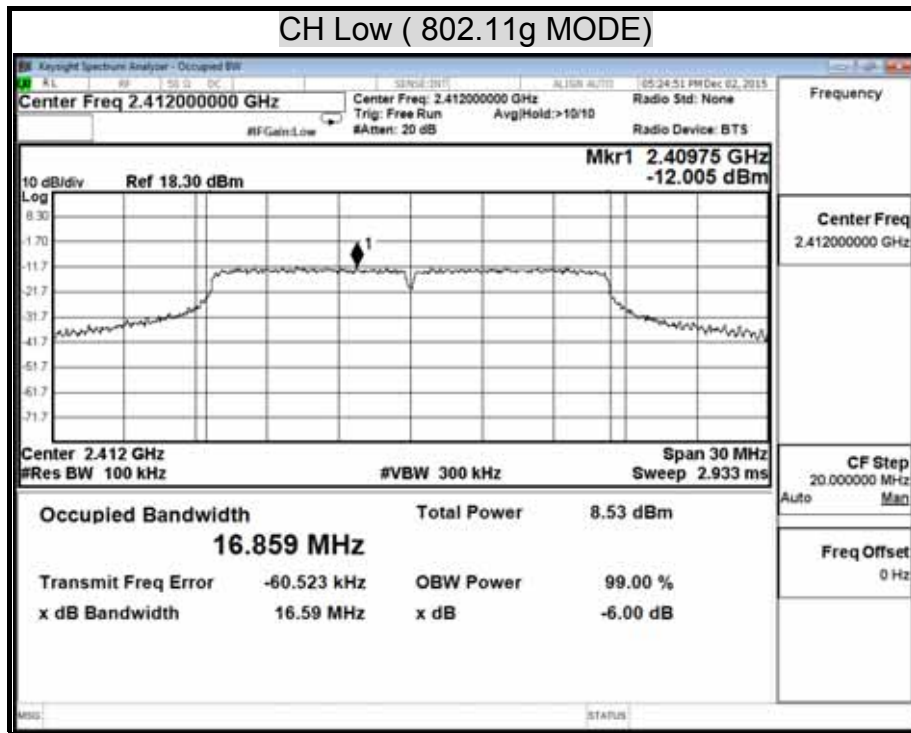

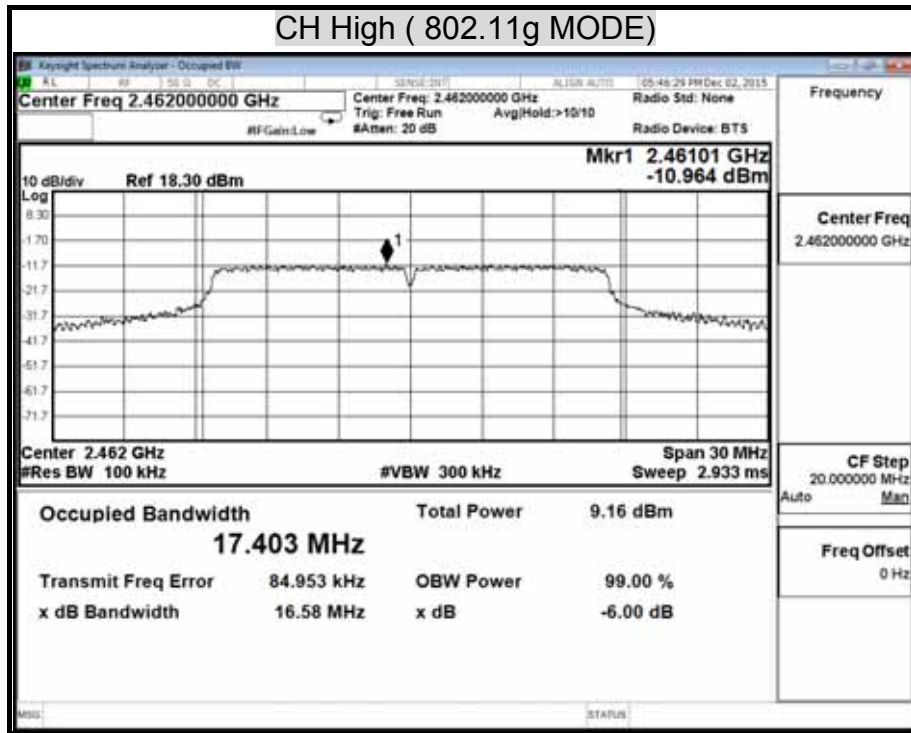

6dB BANDWIDTH (802.11n HT20 MODE) Chain 0

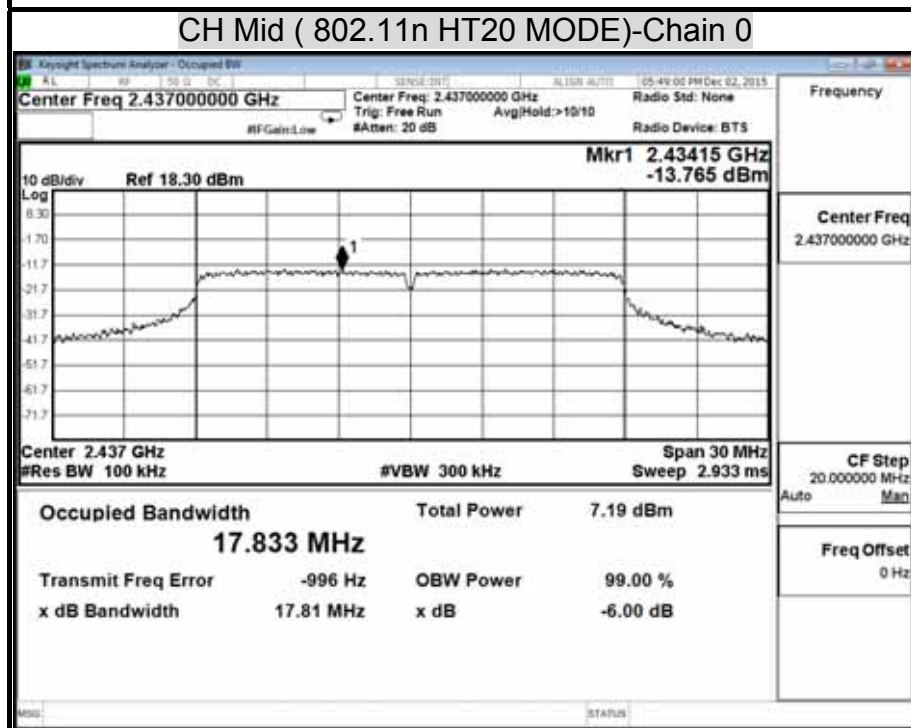
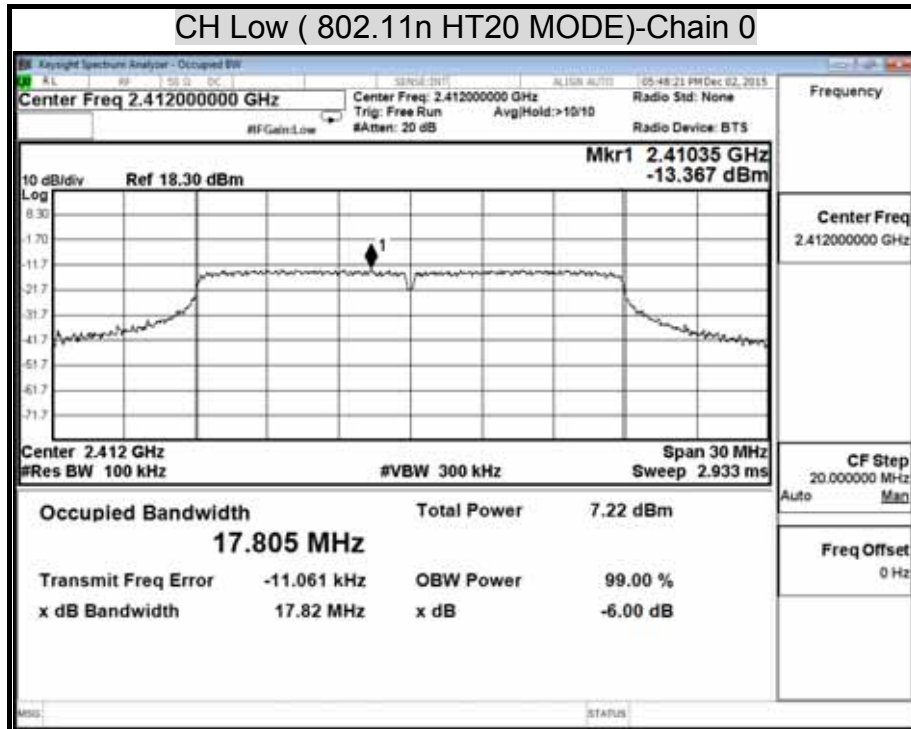

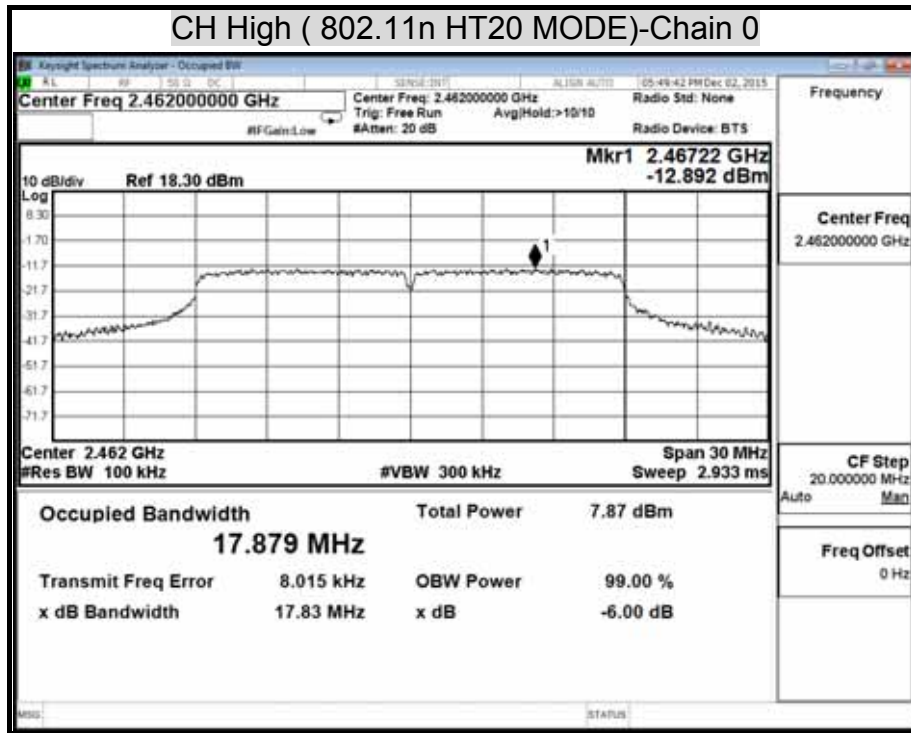

6dB BANDWIDTH (802.11n HT40 MODE) Chain 0

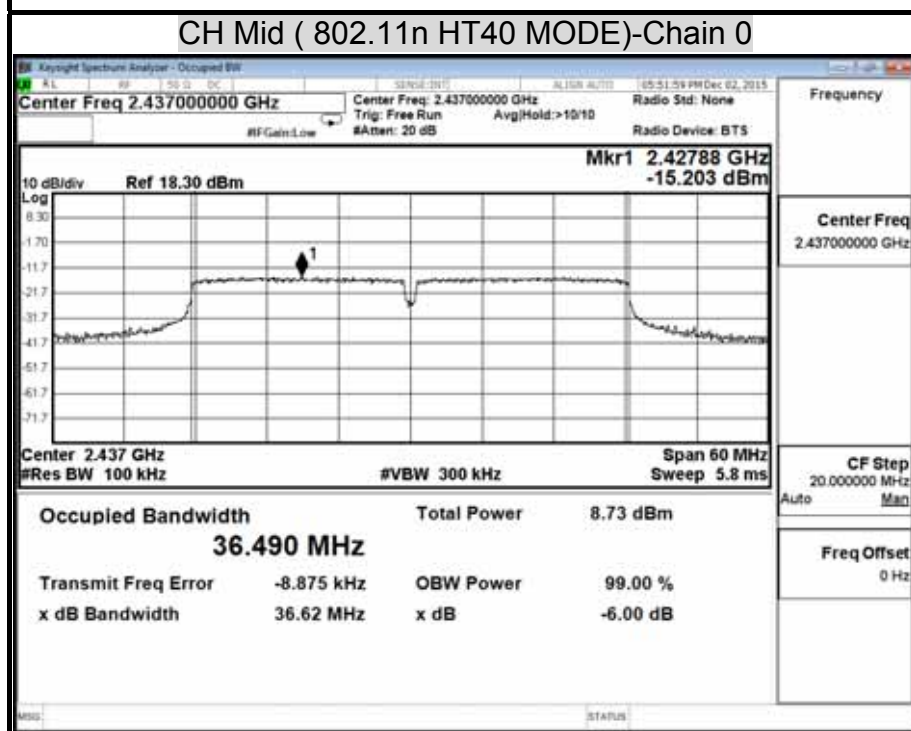
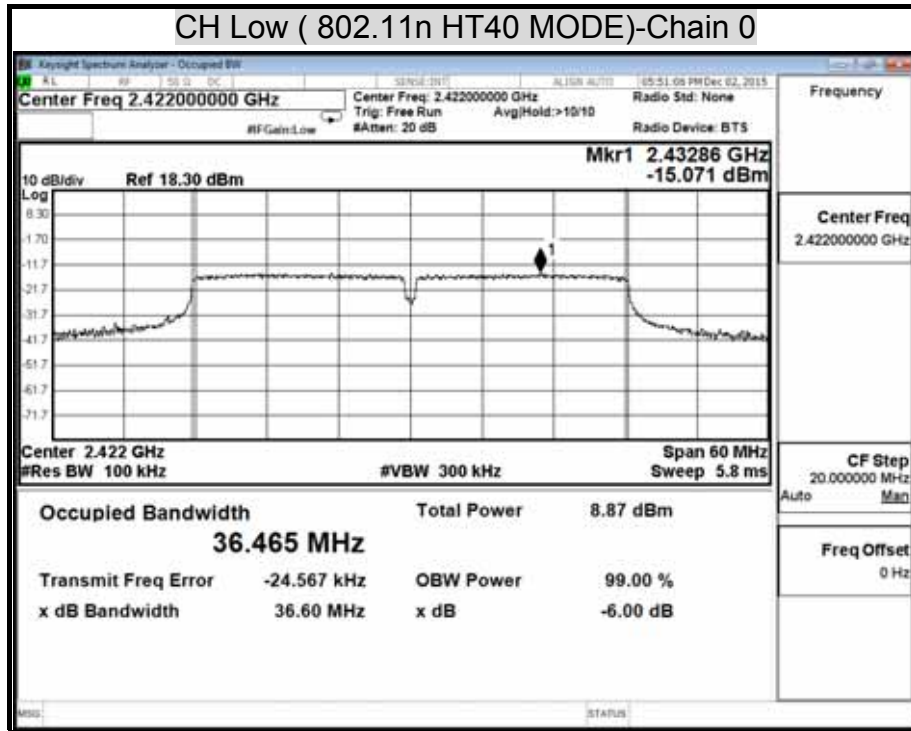

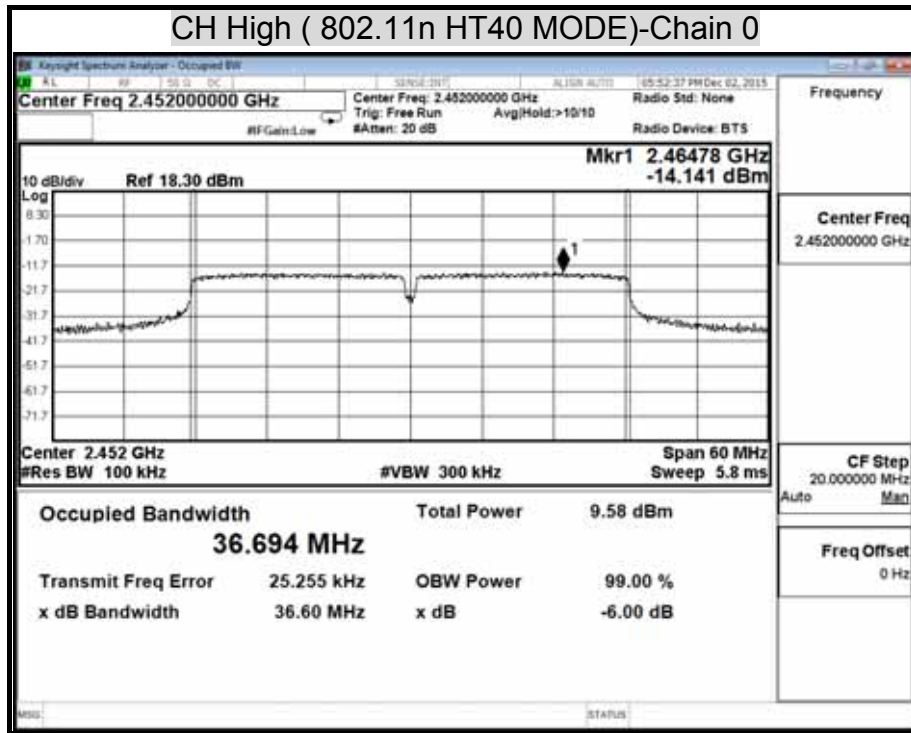

8.2 MAXIMUM PEAK OUTPUT POWER

LIMIT

§ 15.247(b) The maximum peak output power of the intentional radiator shall not exceed the following :

§ 15.247(b) (3) For systems using digital modulation in the 902-928 MHz, 2400-2483.5 MHz, and 5725-5850 MHz bands : 1 watt.

§ 15.247(b) (4) Except as shown in paragraphs (c) of this section , if transmitting antennas of directional gain greater than 6 dBi are used the peak output power from the intentional radiator shall be reduced below the stated values in paragraphs (b)(1) or (b)(2), and (b)(3) of this section , as appropriate, by the amount in dB that the directional gain of the antenna exceeds 6 dBi.

TEST EQUIPMENTS

Name of Equipment	Manufacturer	Model	Serial Number	Calibration Due
EXA Spectrum Analyzer	KEYSIGHT	N9010A	MY54430216	JAN. 23, 2016

TEST SETUP

For Peak Power

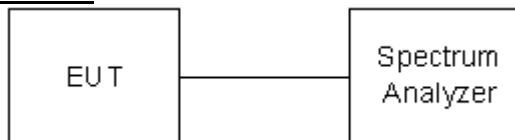

For Average Power

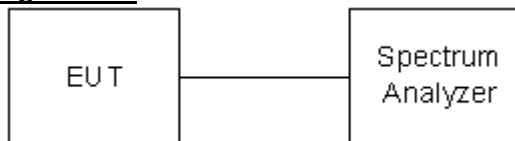

TEST PROCEDURE

The tests were performed in accordance with KDB 558074 5.2.1.2 and 5.2.2.1.

5.2.1.2 Measurement Procedure PK2:

1. Set the RBW = 1 MHz.
2. Set the VBW ≥ 3 RBW
3. Set the span $\geq 1.5 \times$ DTS bandwidth.
4. Detector = peak.
5. Sweep time = auto couple.
6. Trace mode = max hold.
7. Allow trace to fully stabilize.
8. Use the instrument’s band/channel power measurement function with the band limits set equal to the DTS bandwidth edges (for some instruments, this may require a manual override to select peak detector). If the instrument does not have a band power function,
9. Sum the spectrum levels (in linear power units) at intervals equal to the RBW extending across the DTS bandwidth.

5.2.2.1 Measurement Procedure AVG1(power averaging over the EBW with slow sweep speed):

- 1.Set the analyzer span to 5-30% greater than the EBW.
- 2.Set the RBW = 1 MHz.
- 3.Set the VBW ≥ 3 MHz.
- 4.Detector = power average (RMS).
- 5.Ensure that the number of measurement points in the sweep $\geq 2 \times$ (span/RBW).
- 6.Manually set the sweep time to: $\geq 10 \times$ (number of measurement points in sweep) x (transmission symbol period).
- 7.Perform the measurement over a single sweep.
- 8.Use the spectrum analyzer’s integrated band power measurement function with band limits set equal to the EBW band edges to determine the maximum conducted output power of the EUT over the EBW. Note: If the analyzer does not have a band power function, sum the spectral levels (in linear power units) at 1 MHz intervals extending across the entire EBW.

TEST RESULTS

No non-compliance noted.

Model Name	ZA1002US-5	Test By	Ted Huang
Temp & Humidity	28.6°C, 57%	Test Date	2015/12/03

IEEE 802.11b mode

Channel	Channel Frequency (MHz)	Peak Power (dBm)	Peak Power Limit (dBm)	Pass / Fail
Low	2412	0.95	30.00	PASS
Middle	2437	0.91	30.00	PASS
High	2462	1.62	30.00	PASS

NOTE : 1. At final test to get the worst-case emission at 1Mbps long.
 2. The cable assembly insertion loss of 11.1dB (including 10 dB pad and 1.1 dB cable) was entered as an offset in the spectrum analyzer to allow for direct reading of power.

IEEE 802.11g mode

Channel	Channel Frequency (MHz)	Peak Power (dBm)	Peak Power Limit (dBm)	Pass / Fail
Low	2412	9.48	30.00	PASS
Middle	2437	9.81	30.00	PASS
High	2462	10.28	30.00	PASS

NOTE : 1. At final test to get the worst-case emission at 6Mbps.
 2. The cable assembly insertion loss of 11.1dB (including 10 dB pad and 1.1 dB cable) was entered as an offset in the spectrum analyzer to allow for direct reading of power.

IEEE 802.11n HT20 mode

Channel	Channel Frequency (MHz)	Peak Power (dBm)	Peak Power Limit (dBm)	Pass / Fail
		Chain 0		
Low	2412	8.20	29.58	PASS
Middle	2437	8.12	29.58	PASS
High	2462	8.73	29.58	PASS

NOTE : 1. At final test to get the worst-case emission at 6.5Mbps.
 2. The cable assembly insertion loss of 11.1dB (including 10 dB pad and 1.1 dB cable) was entered as an offset in the spectrum analyzer to allow for direct reading of power.

IEEE 802.11n HT40 mode

Channel	Channel Frequency (MHz)	Peak Power (dBm)	Peak Power Limit (dBm)	Pass / Fail
		Chain 0		
Low	2422	9.86	29.58	PASS
Middle	2437	9.94	29.58	PASS
High	2452	10.86	29.58	PASS

NOTE : 1. At final test to get the worst-case emission at 13Mbps.
 2. The cable assembly insertion loss of 11.1dB (including 10 dB pad and 1.1 dB cable) was entered as an offset in the spectrum analyzer to allow for direct reading of power.

Average Power Data

IEEE 802.11b mode

Channel	Channel Frequency (MHz)	Average Power (dBm)
Low	2412	-2.04
Middle	2437	-2.18
High	2462	-1.41

IEEE 802.11g mode

Channel	Channel Frequency (MHz)	Average Power (dBm)
Low	2412	1.33
Middle	2437	1.18
High	2462	1.84

IEEE 802.11n HT20 mode

Channel	Channel Frequency (MHz)	Average Power (dBm)
		Chain 0
Low	2412	0.14
Middle	2437	-0.01
High	2462	0.65

IEEE 802.11n HT40 mode

Channel	Channel Frequency (MHz)	Average Power (dBm)
		Chain 0
Low	2422	1.30
Middle	2437	1.19
High	2452	2.08

MAXIMUM PEAK OUTPUT POWER (802.11b MODE)

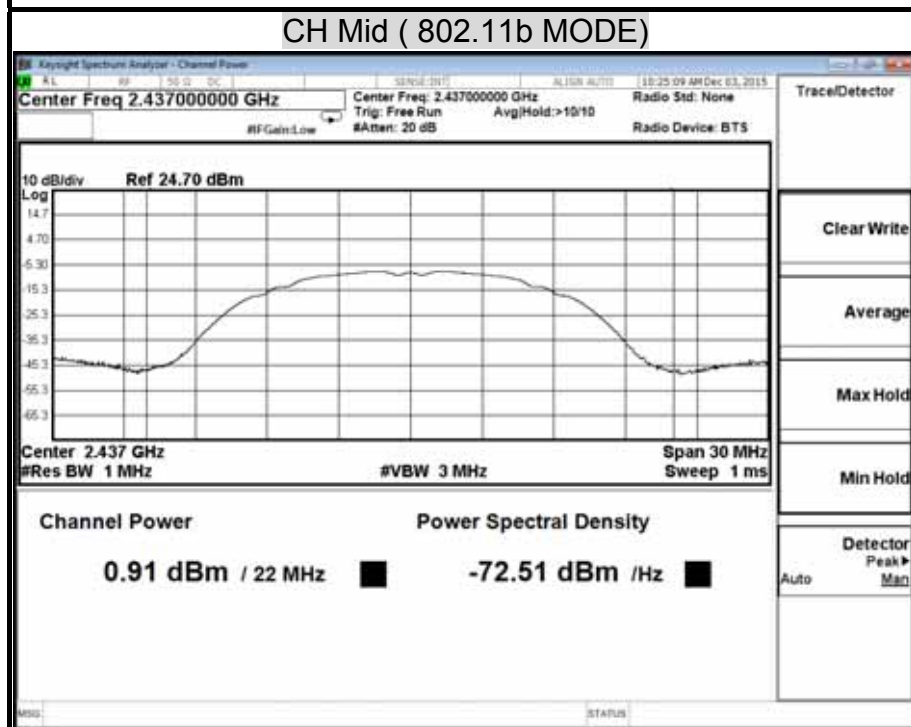
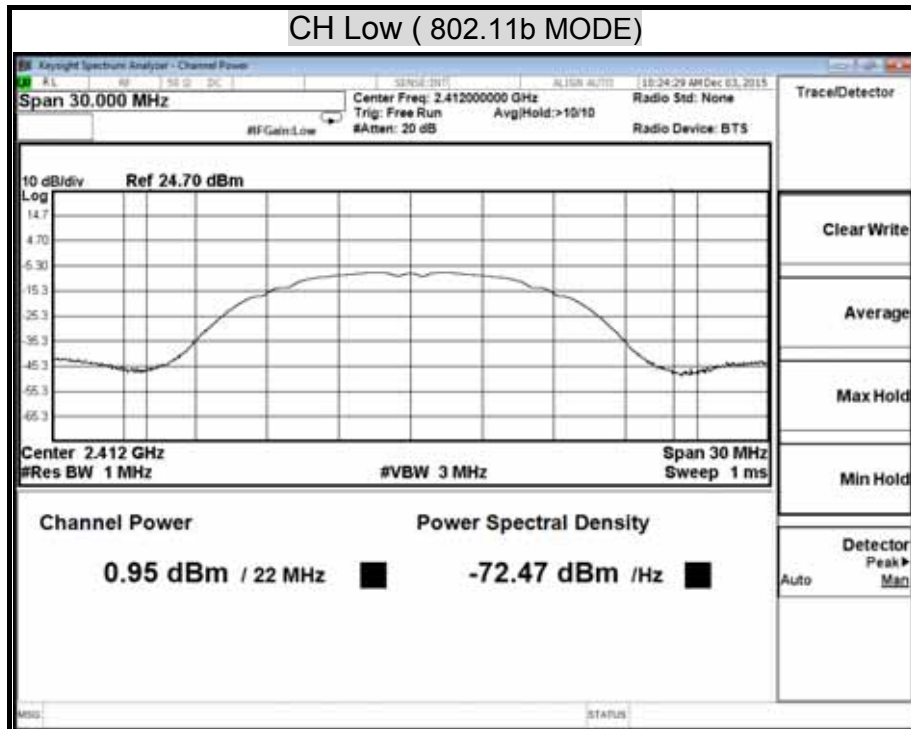

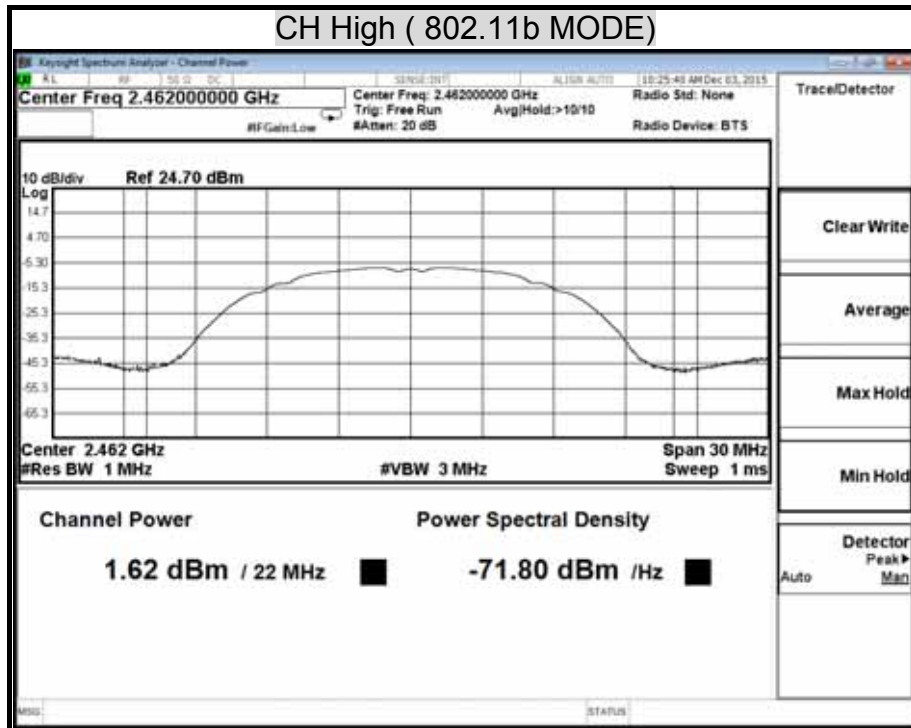

MAXIMUM PEAK OUTPUT POWER (802.11g MODE)

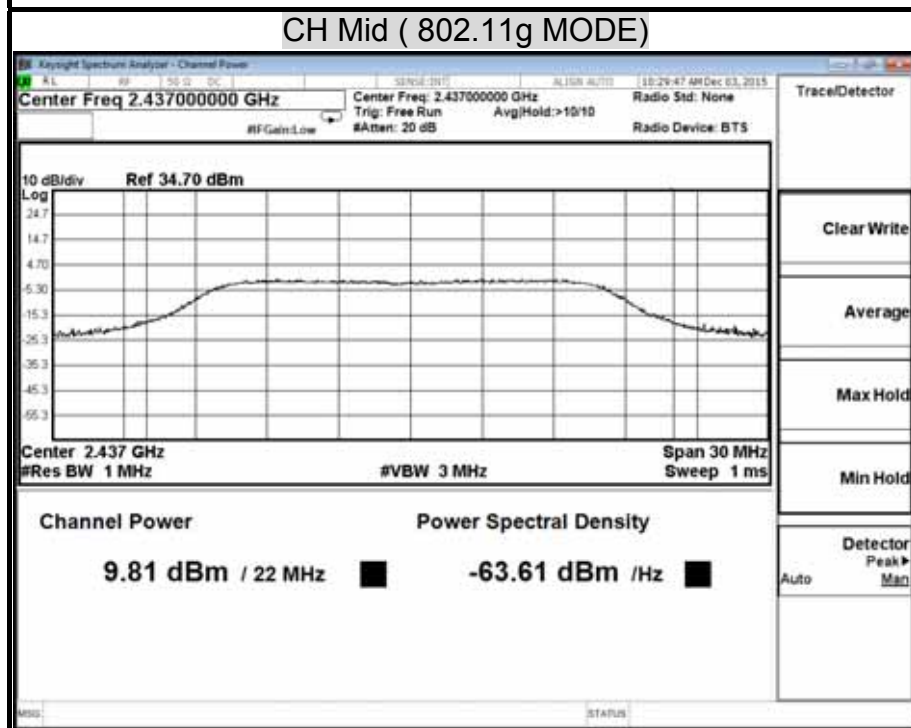
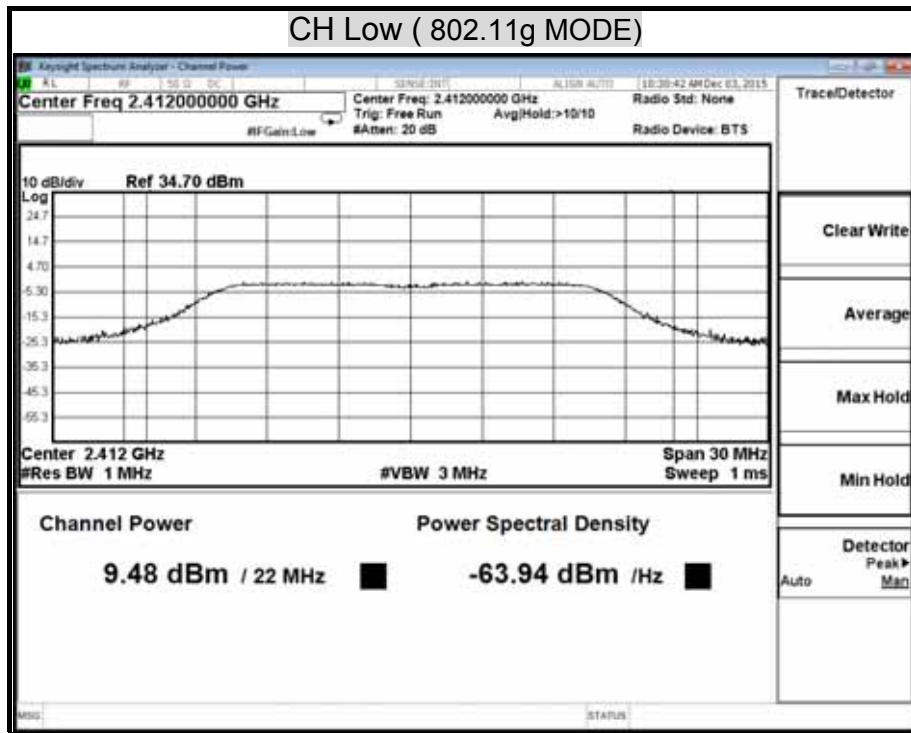

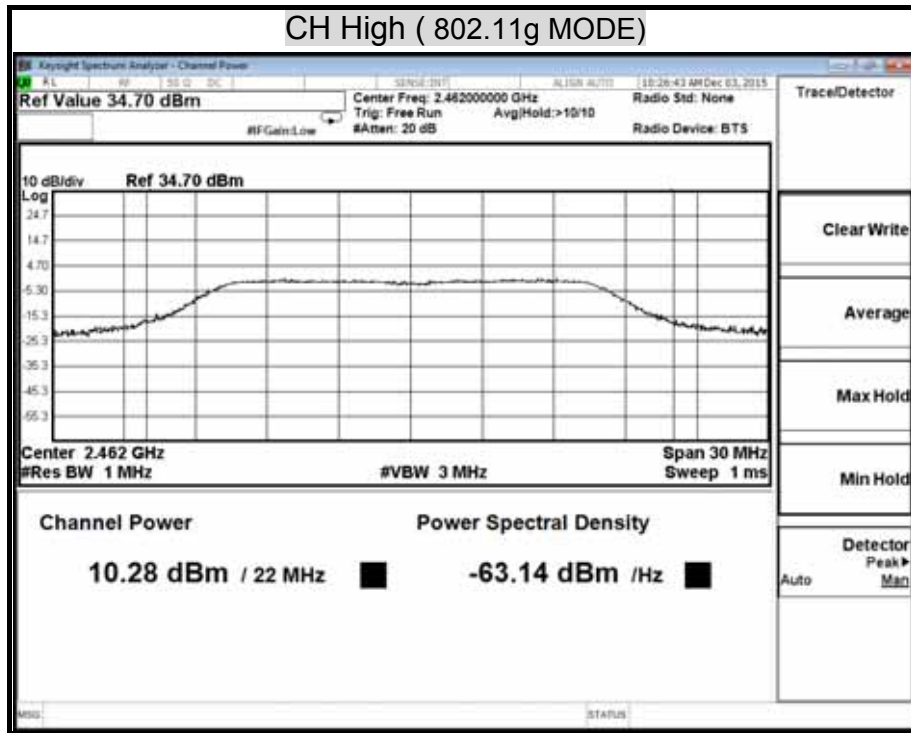

MAXIMUM PEAK OUTPUT POWER (802.11n HT20 MODE) Chain 0

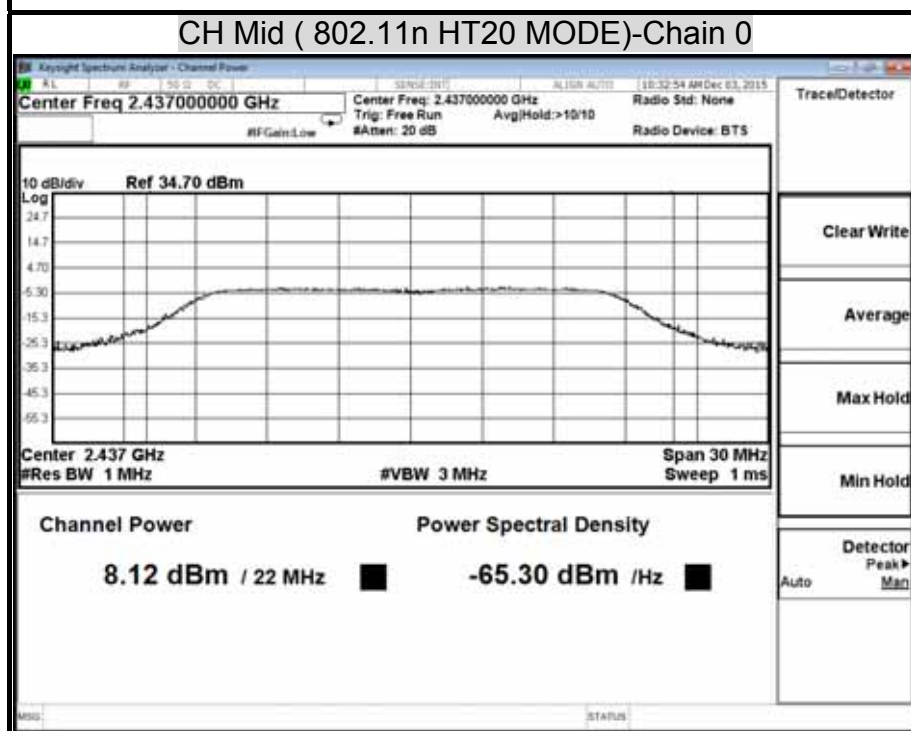
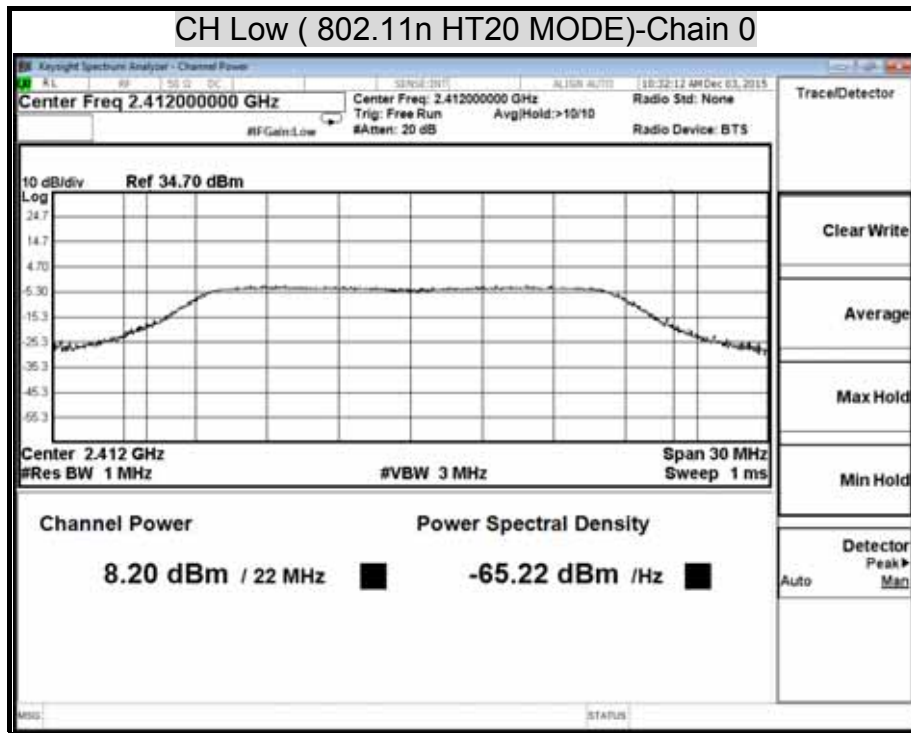

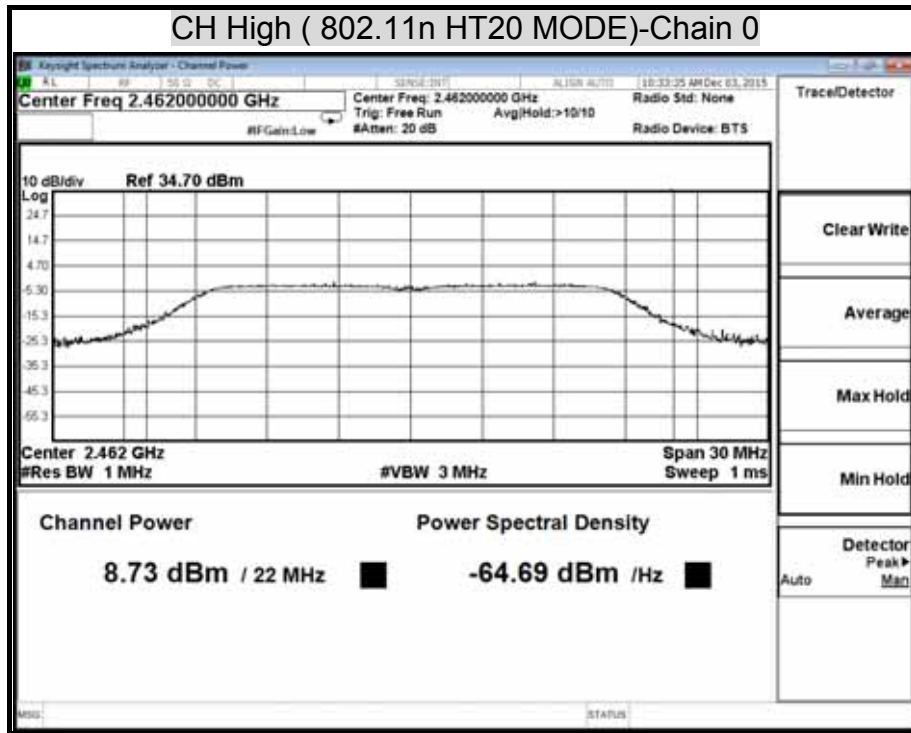

MAXIMUM PEAK OUTPUT POWER (802.11n HT40 MODE) Chain 0

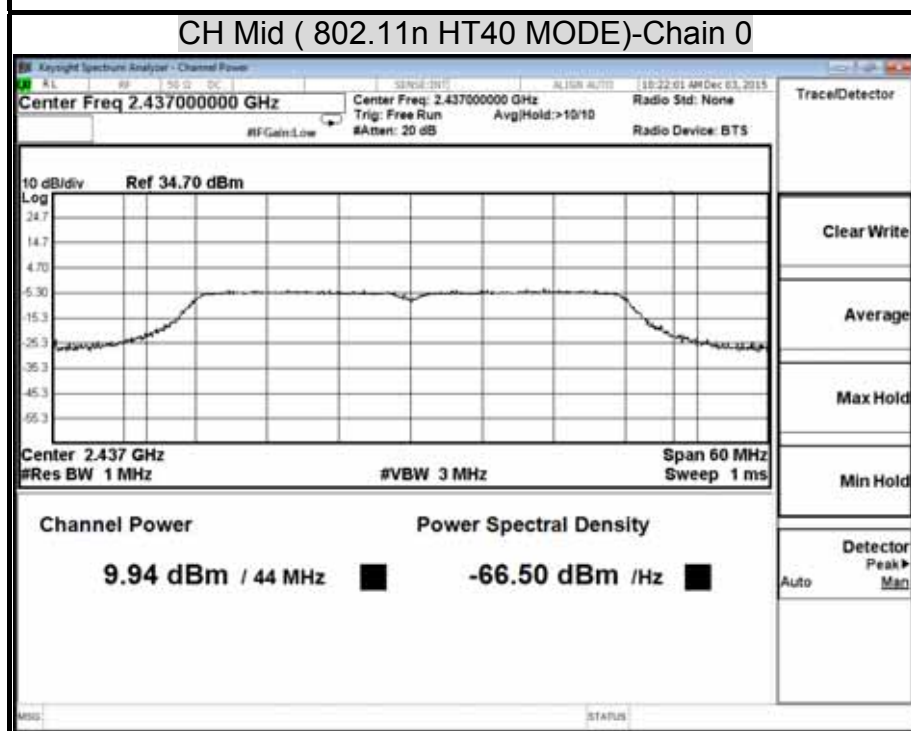
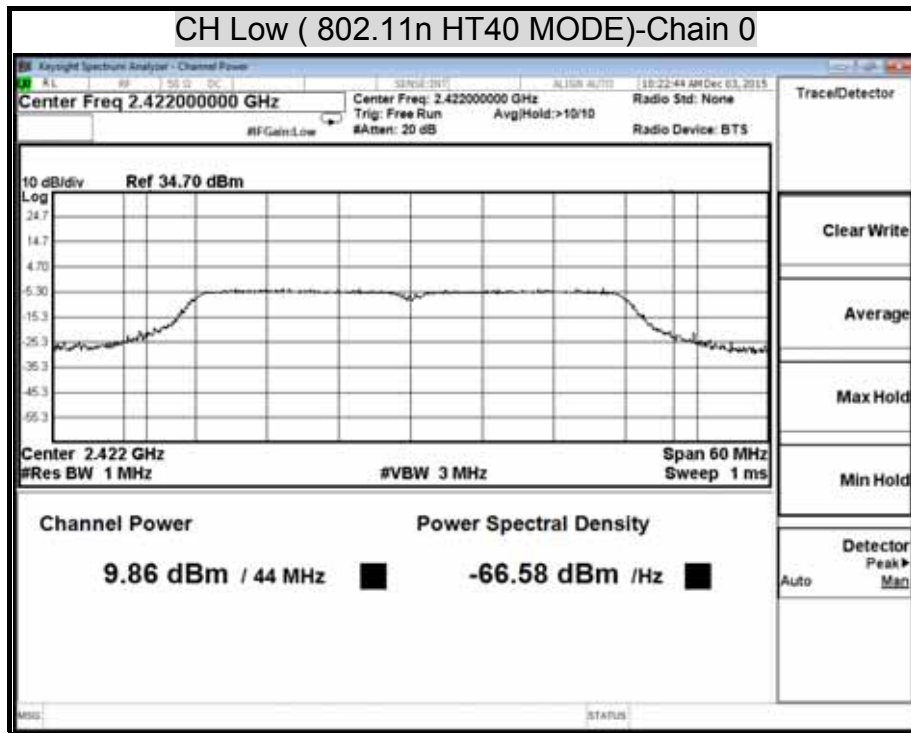

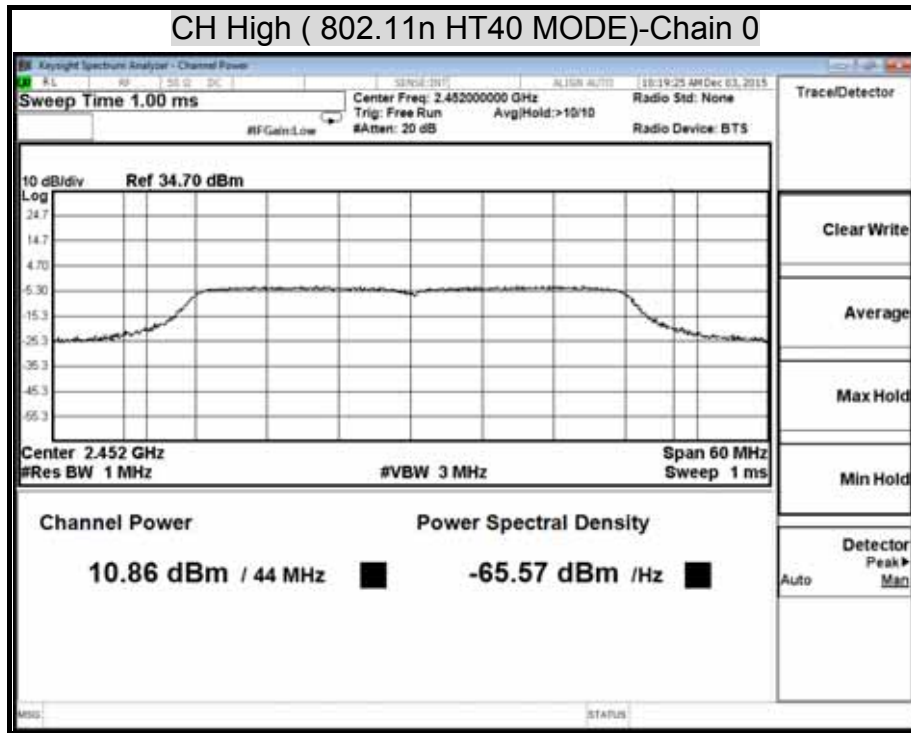

AVERAGE POWER (802.11b MODE)

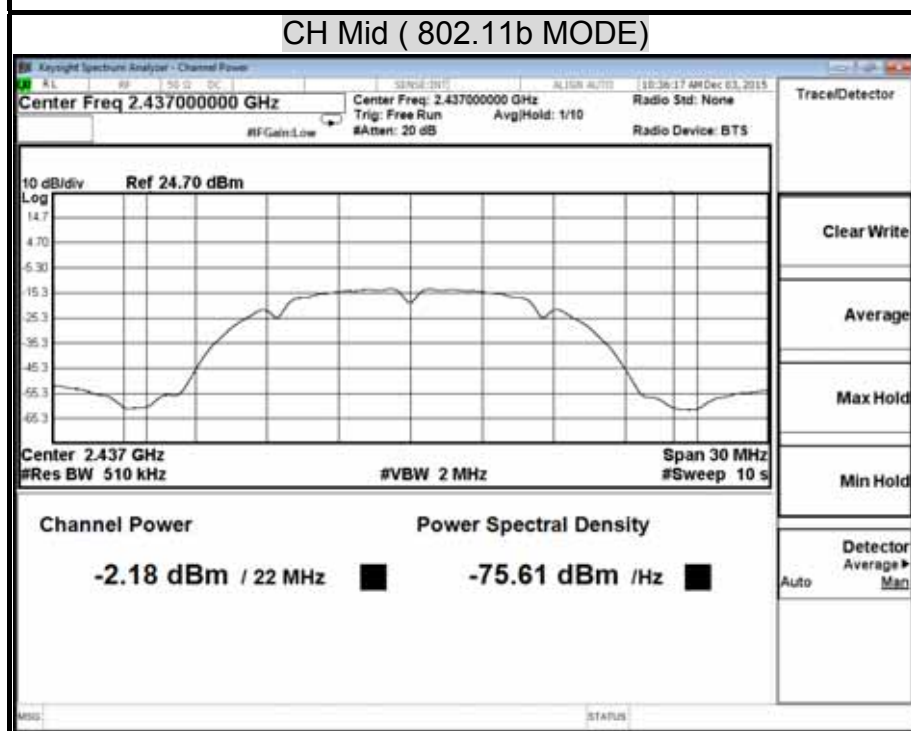
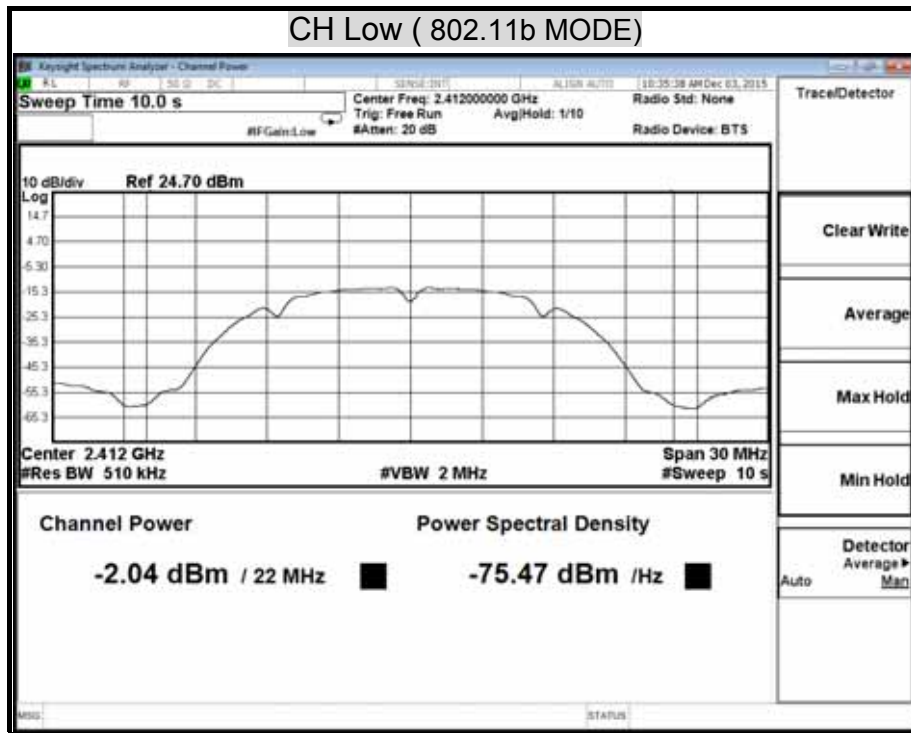

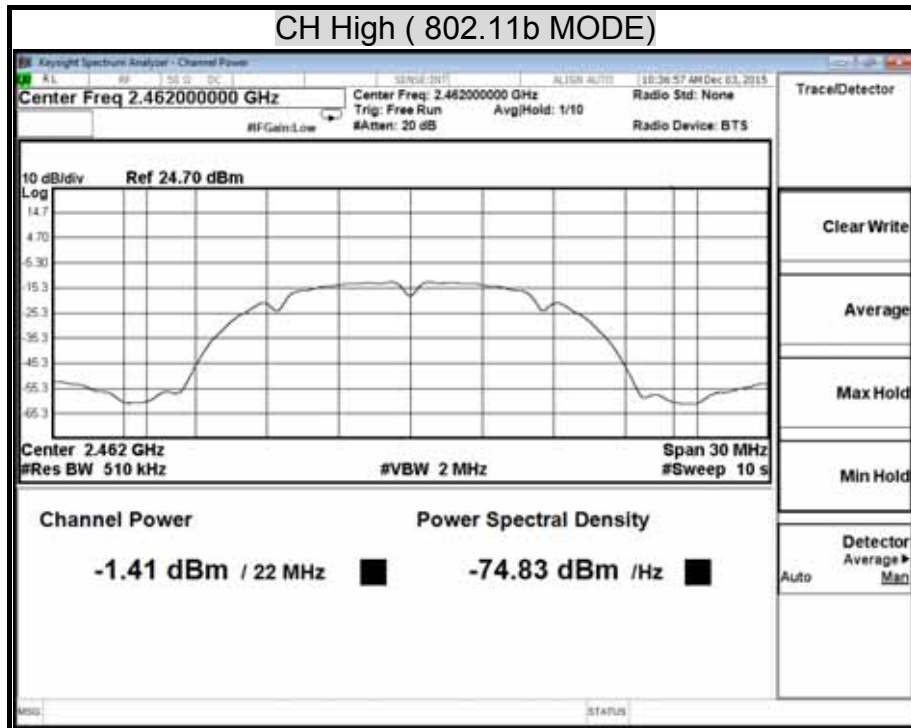

AVERAGE POWER (802.11g MODE)

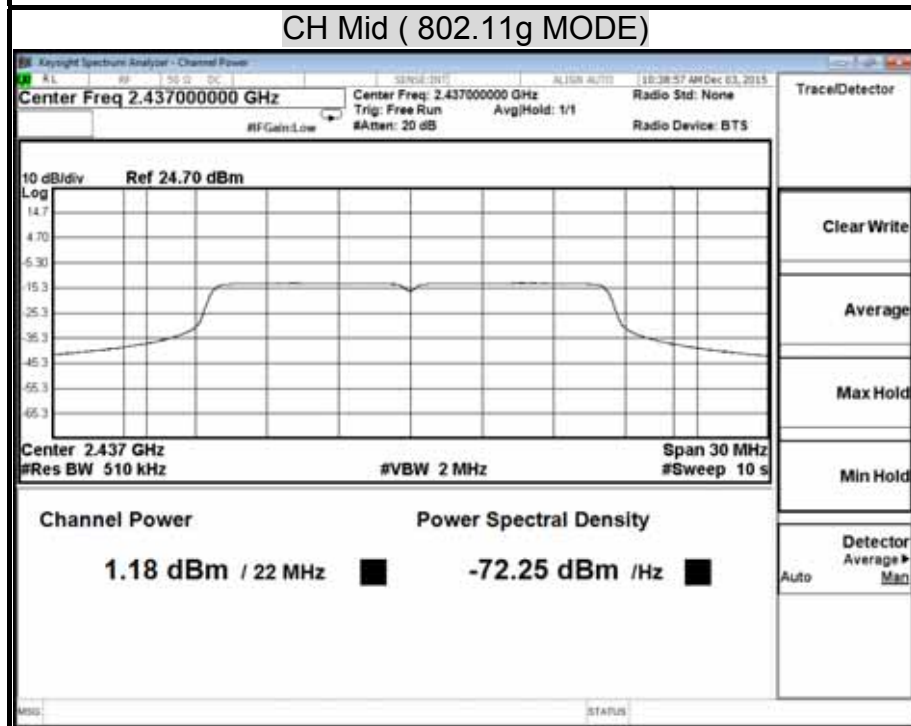
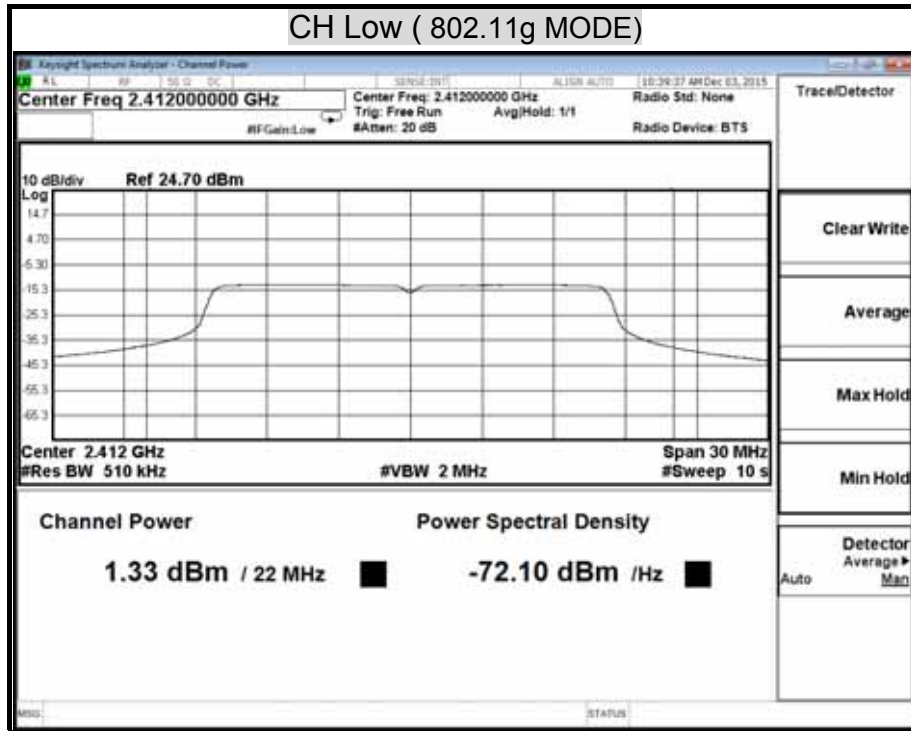

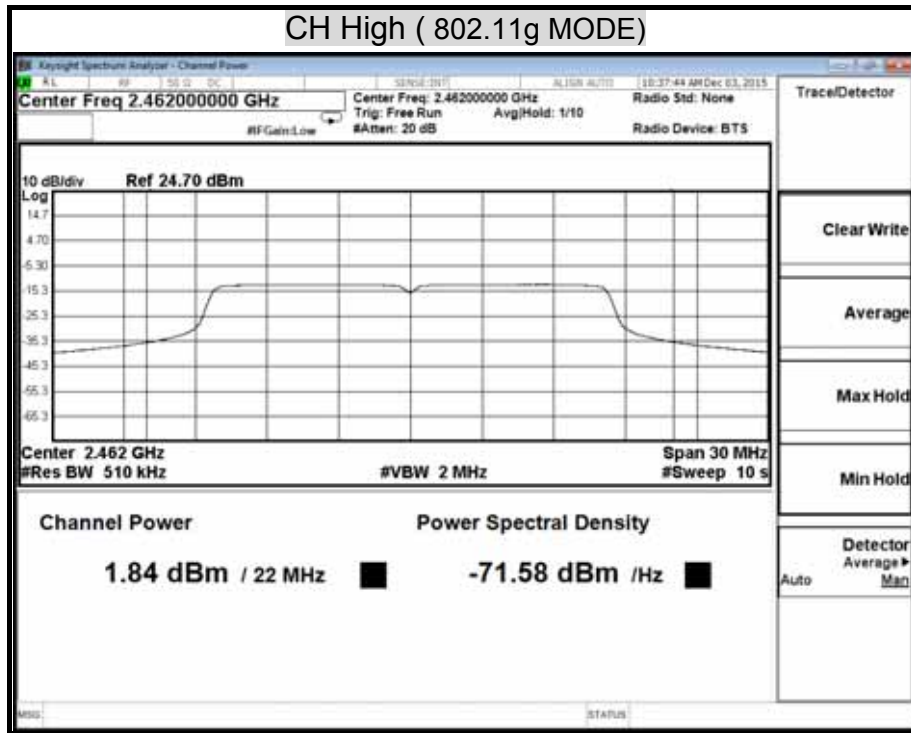

AVERAGE POWER (802.11n HT20 MODE) Chain 0

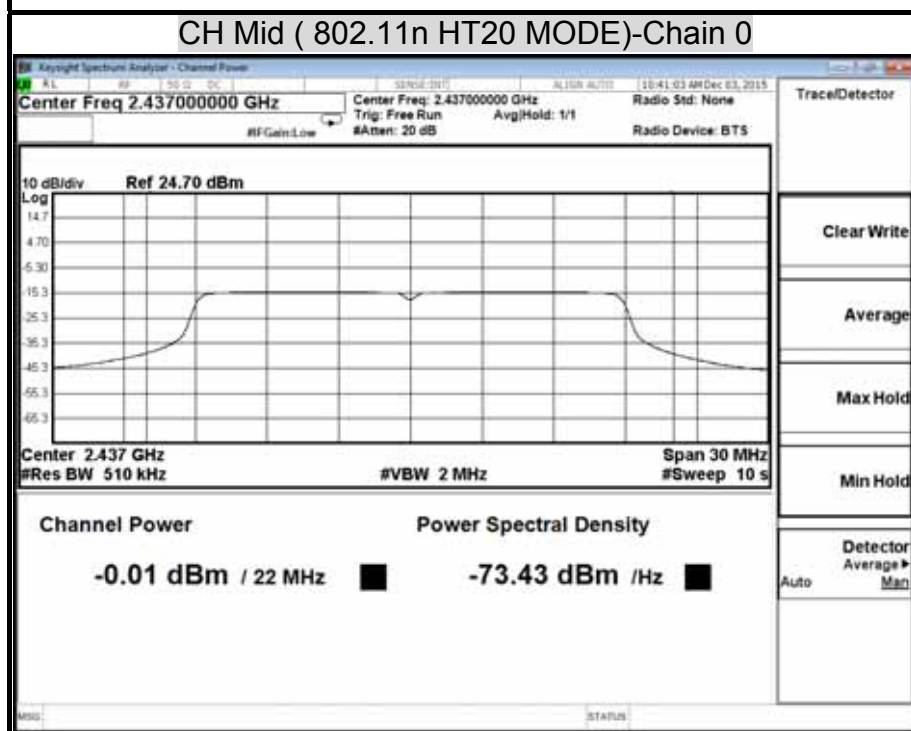
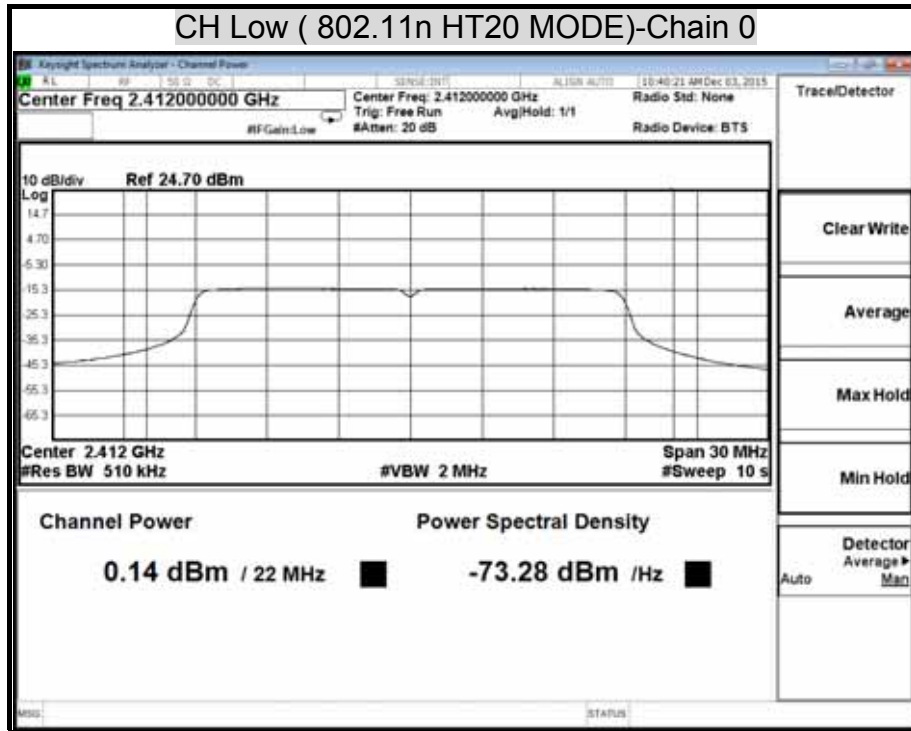

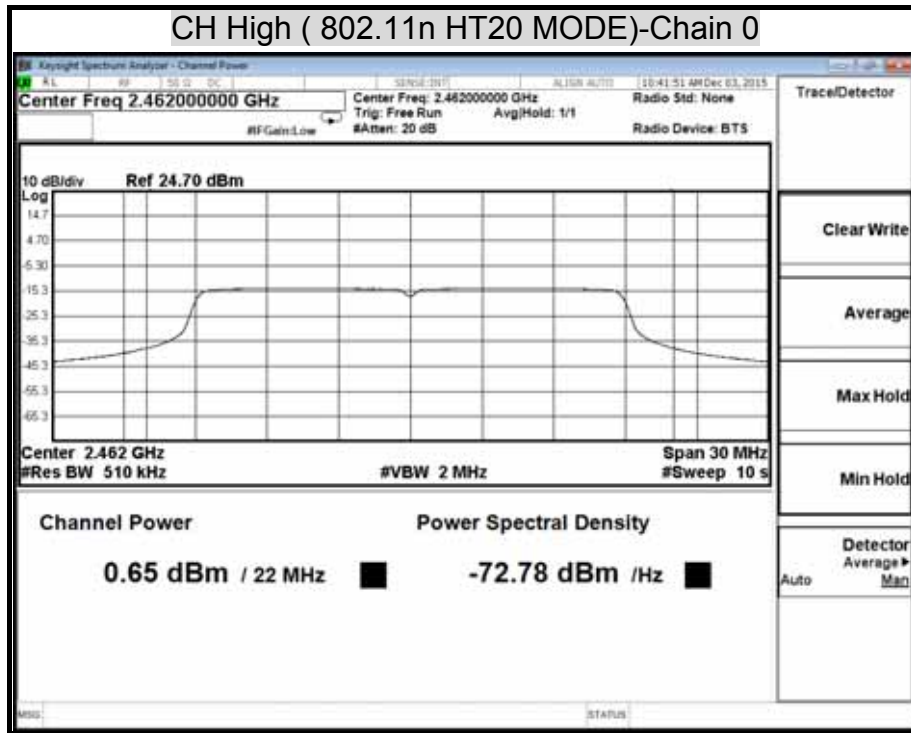

AVERAGE POWER (802.11n HT40 MODE) Chain 0

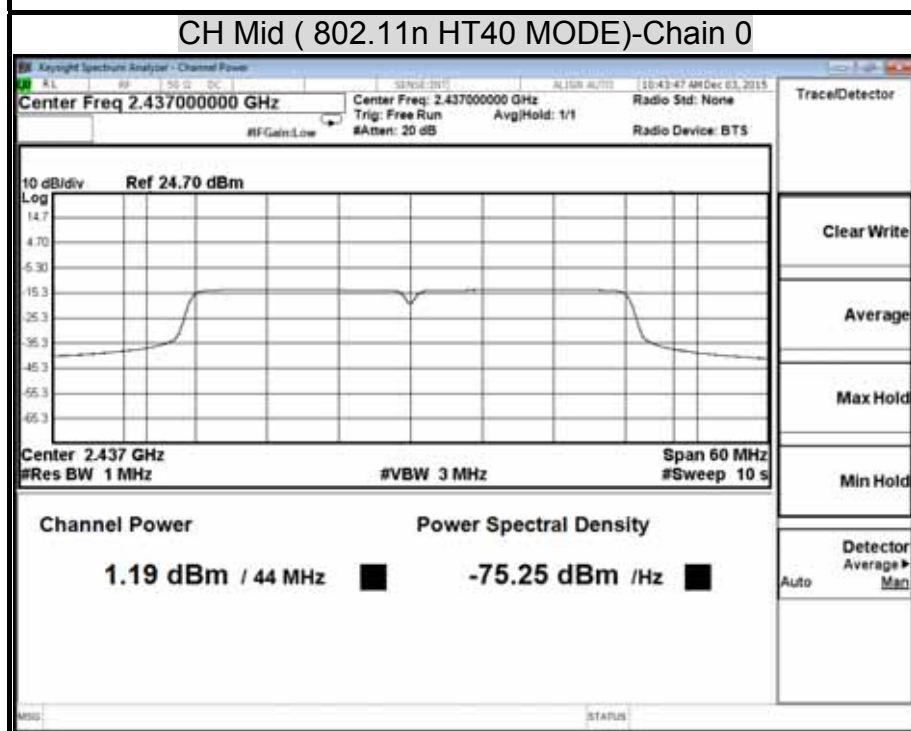
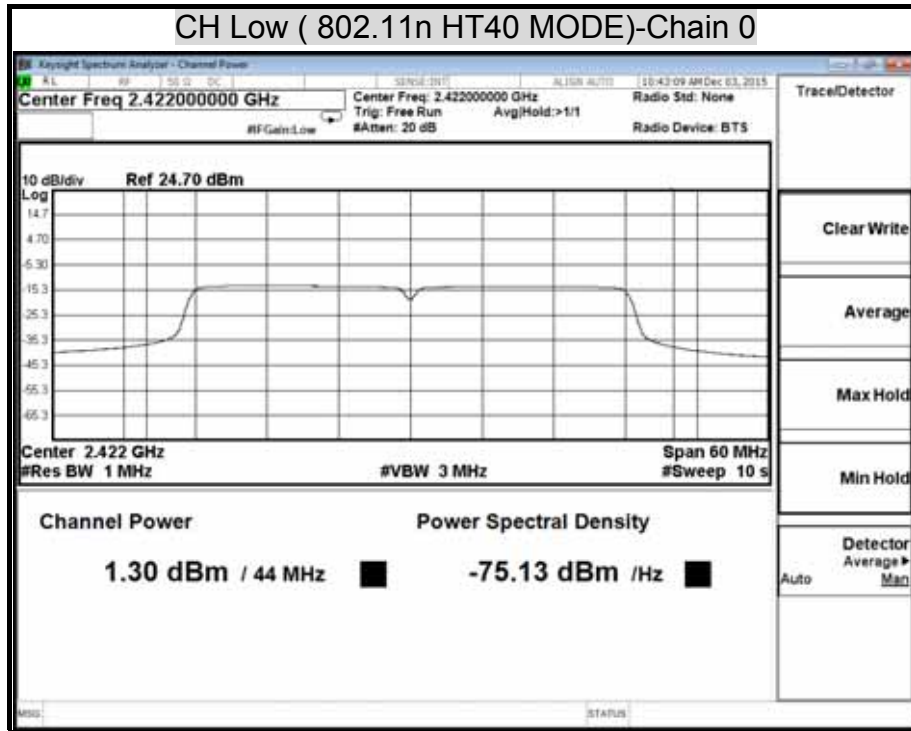

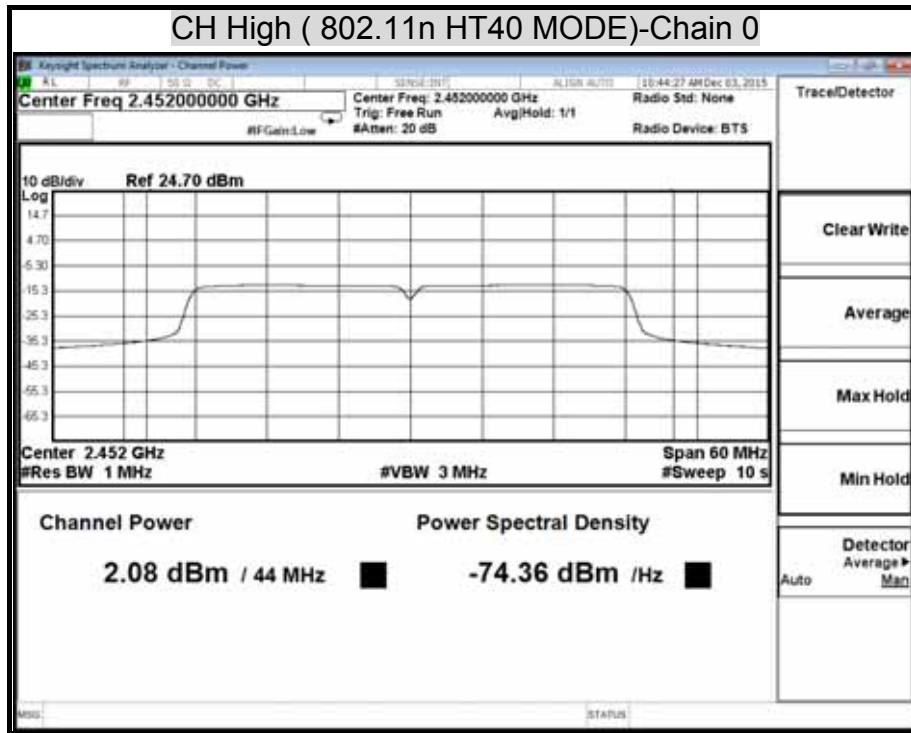

8.3 DUTY CYCLE

LIMIT

Nil (No dedicated limit specified in the Rules)

TEST EQUIPMENT

Name of Equipment	Manufacturer	Model	Serial Number	Calibration Due
EXA Spectrum Analyzer	KEYSIGHT	N9010A	MY54430216	JAN. 23, 2016

Remark: Each piece of equipment is scheduled for calibration once a year.

TEST SETUP



TEST PROCEDURE

1. Place the EUT on the table and set it in transmitting mode.
2. Remove the antenna from the EUT and then connect a low loss RF cable from the antenna port to the spectrum analyzer.
3. The zero-span mode on a spectrum analyzer or EMI receiver if the response time and spacing between bins on the sweep are sufficient to permit accurate measurements of the on and off times of the transmitted signal. Set the center frequency of the instrument to the center frequency of the transmission. Set $RBW \geq OBW$ if possible; otherwise, set RBW to the largest available value. Set $VBW \geq RBW$. Set detector = peak or average. The zero-span measurement method shall not be used unless both RBW and VBW are $> 50/T$ and the number of sweep points across duration T exceeds 100. (For example, if VBW and/or RBW are limited to 3 MHz, then the zero-span method of measuring duty cycle shall not be used if $T \leq 16.7$ microseconds.)

TEST RESULTS

No non-compliance noted.

Model Name	ZA1002US-5	Test By	Ted Huang
Temp & Humidity	28.6°C, 57%	Test Date	2015/12/03

TEST DATA

	us	Times	Ton	Total Ton time(ms)
Ton1	100000.000	1	100000.000	100.000
Ton2		0	0.000	
Ton3		0	0.000	
Tp				100.000

Ton	100.000		
Tp(Ton+Toff)	100.000		
Duty Cycle	1.000	100	%
Duty Factor	0.000		

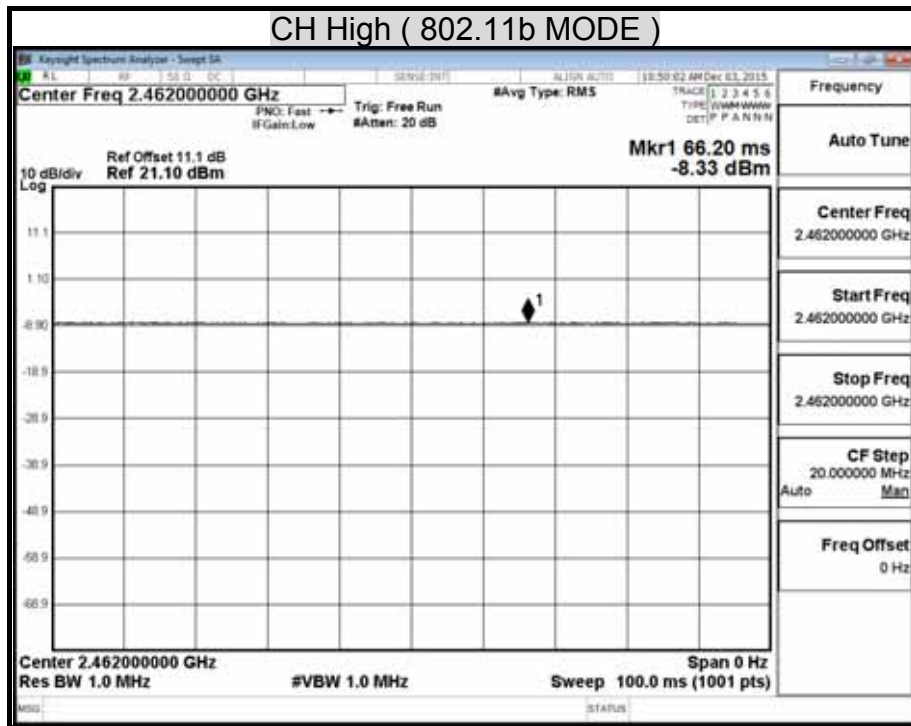

Duty Cycle (IEEE 802.11g MODE)

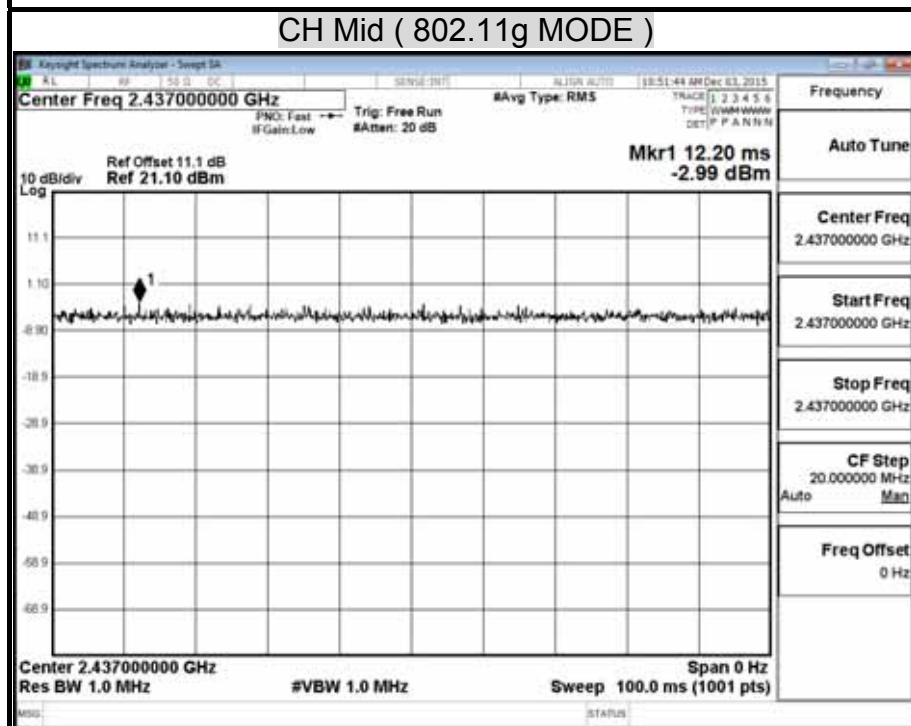
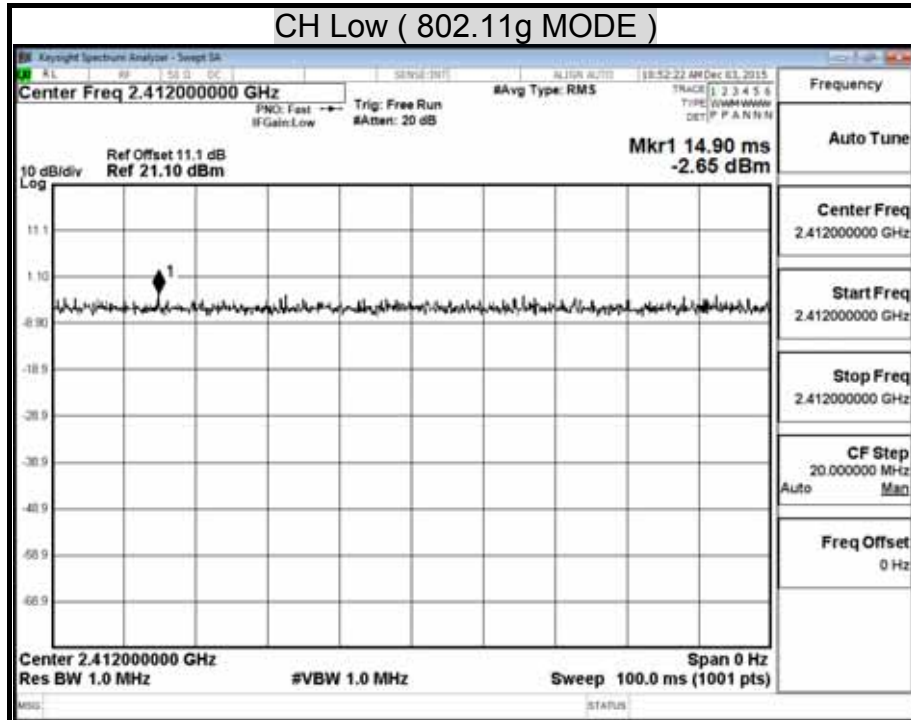

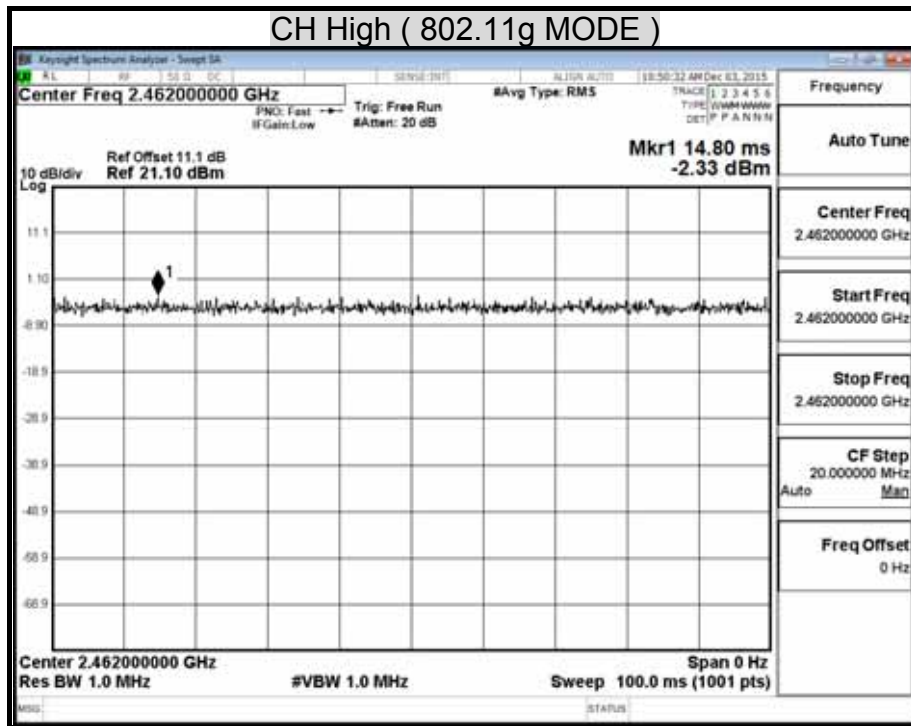

Duty Cycle (802.11n HT20 MODE)

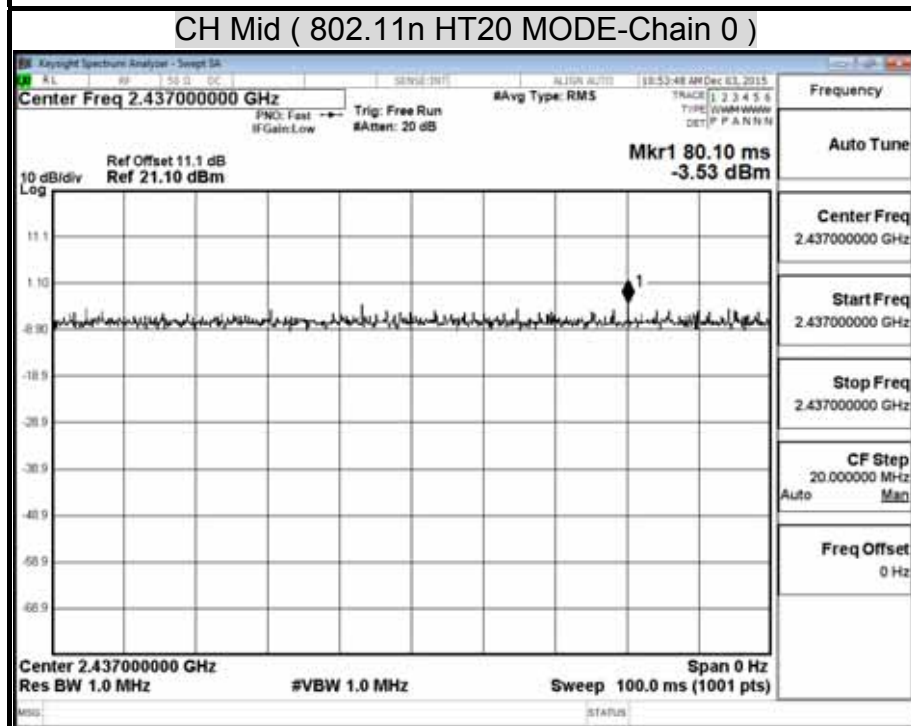
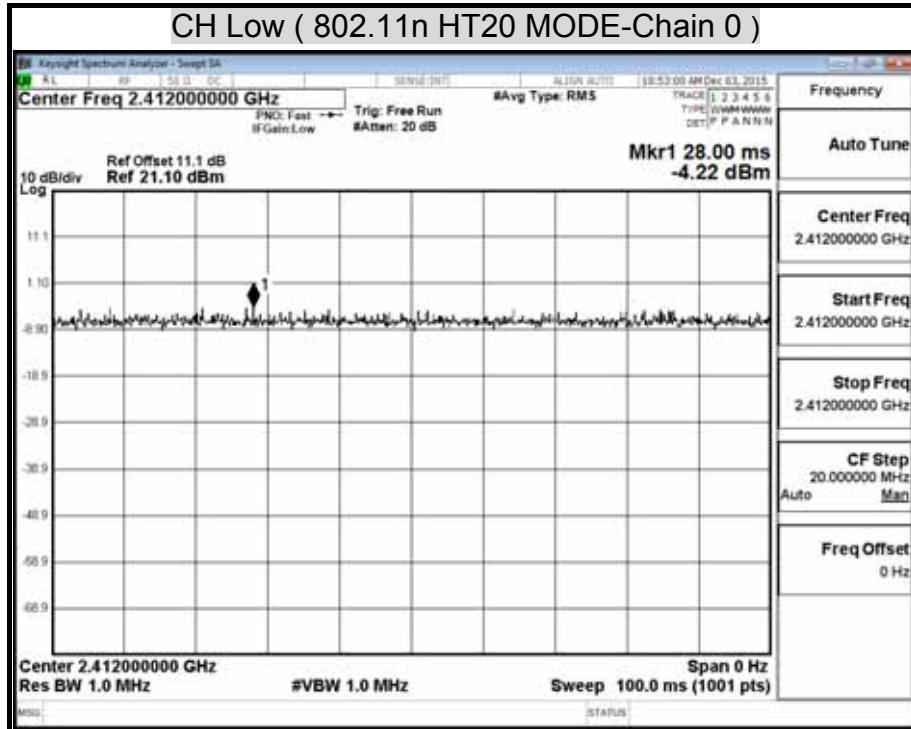

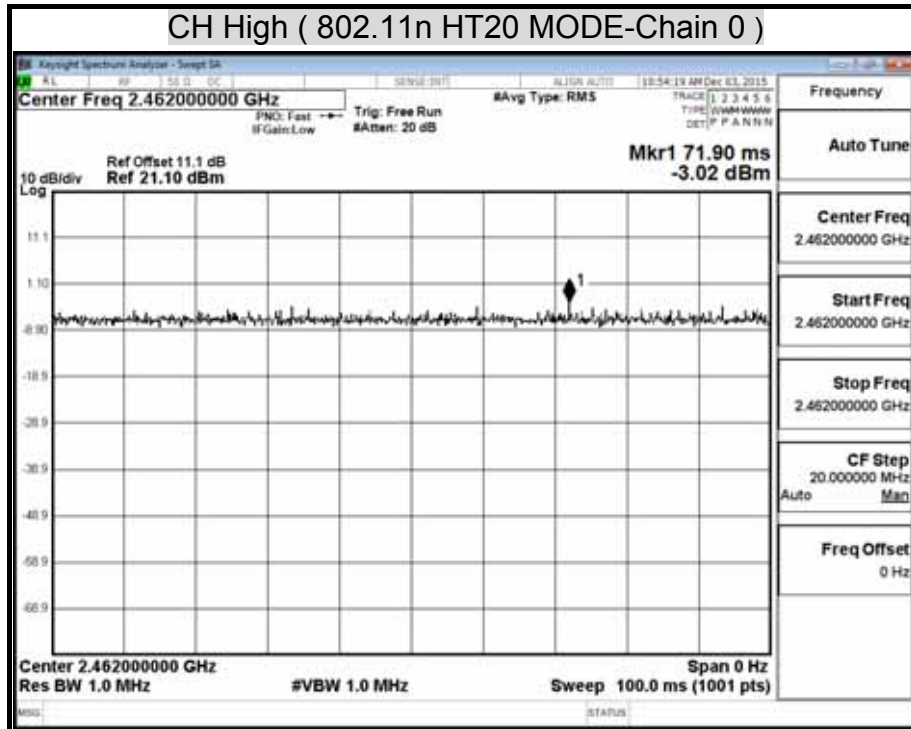

Duty Cycle (802.11n HT40 MODE)

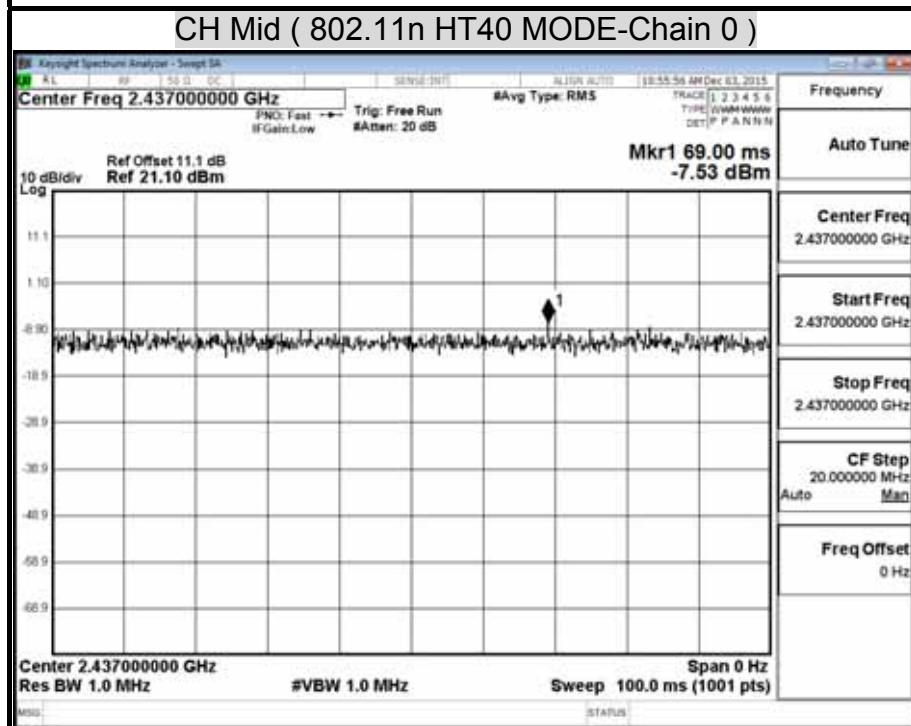
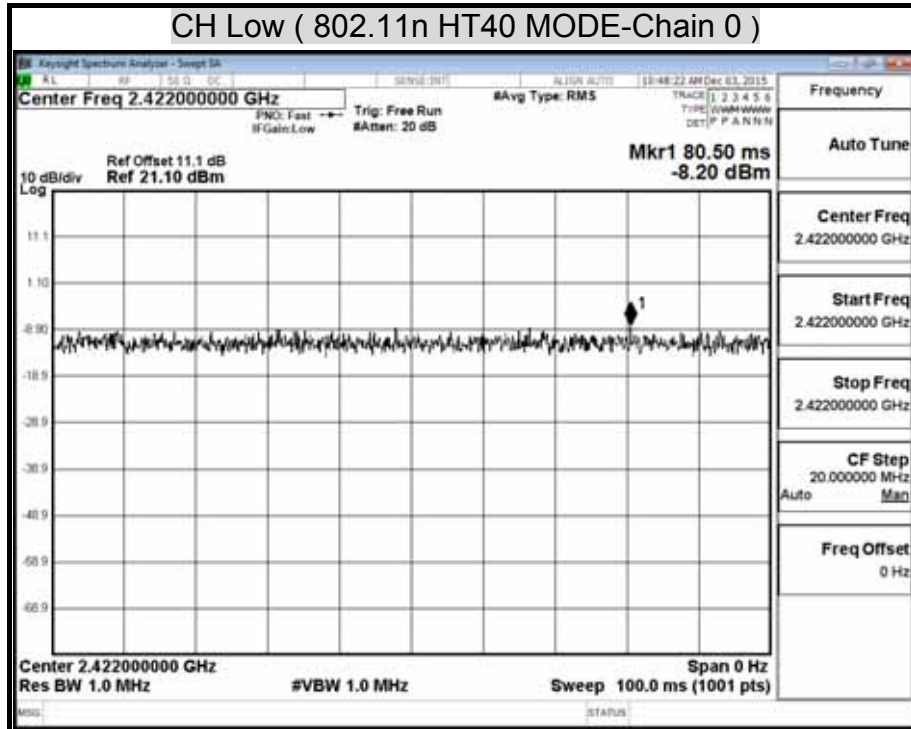

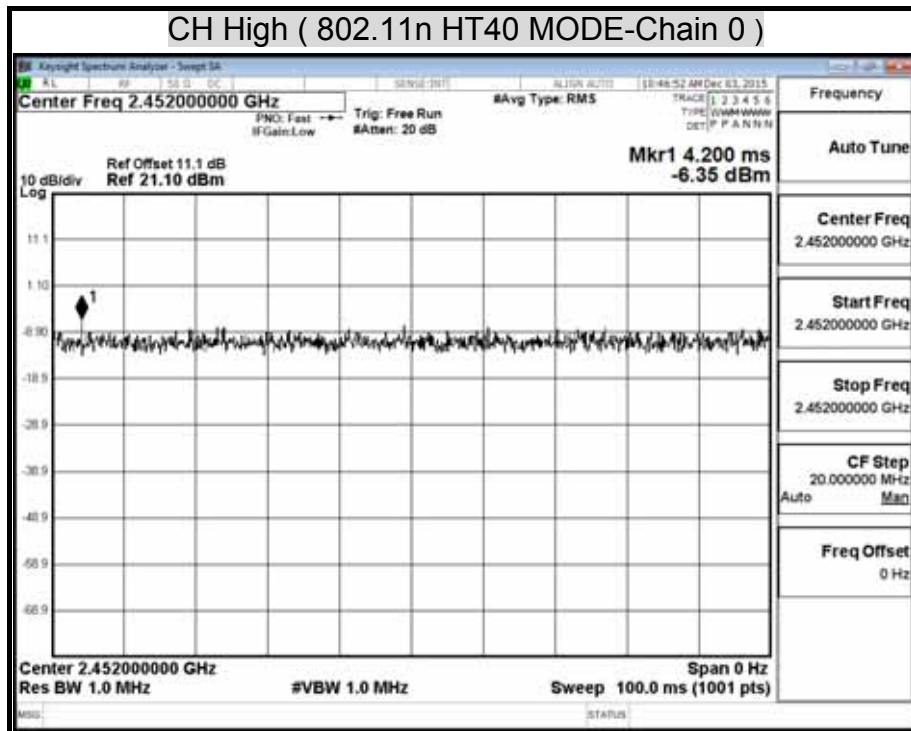

8.4 POWER SPECTRAL DENSITY

LIMIT

§ 15.247(e) For digitally modulated systems, the power spectral density conducted from the intentional radiator to the antenna shall not greater than 8 dBm in any 3 kHz band during any time interval of continuous transmission.

TEST EQUIPMENTS

Name of Equipment	Manufacturer	Model	Serial Number	Calibration Due
EXA Spectrum Analyzer	KEYSIGHT	N9010A	MY54430216	JAN. 23, 2016

TEST SETUP



TEST PROCEDURE

The tests were performed in accordance with KDB 558074 5.3.1.

5.3.1 Measurement Procedure PKPSD:

1. Set analyzer center frequency to DTS channel center frequency.
2. Set the span to 1.5 times the *DTS bandwidth*.
3. Set the RBW to: $3 \text{ kHz} \leq \text{RBW} \leq 100 \text{ kHz}$.
4. Set the VBW $\geq 3 \text{ RBW}$.
5. Detector = peak.
6. Sweep time = auto couple.
7. Trace mode = max hold.
8. Allow trace to fully stabilize.
9. Use the peak marker function to determine the maximum amplitude level within the RBW.
10. If measured value exceeds limit, reduce RBW (no less than 3 kHz) and repeat.

TEST RESULTS

No non-compliance noted.

Model Name	ZA1002US-5	Test By	Ted Huang
Temp & Humidity	28.6°C, 57%	Test Date	2015/12/03

IEEE 802.11b mode

Channel	Frequency (MHz)	PPSD (dBm)	Limit (dBm)	Margin (dB)	Pass / Fail
Low	2412	-11.21	8.00	-19.21	PASS
Middle	2437	-11.19	8.00	-19.19	PASS
High	2462	-10.53	8.00	-18.53	PASS

NOTE : 1. At final test to get the worst-case emission at 11Mbps long.
 2. The cable assembly insertion loss of 11.1dB (including 10 dB pad and 1.1 dB cable) was Entered as an offset in the spectrum analyzer to allow for direct reading of power.

IEEE 802.11g mode

Channel	Frequency (MHz)	PPSD (dBm)	Limit (dBm)	Margin (dB)	Pass / Fail
Low	2412	-12.01	8.00	-20.01	PASS
Middle	2437	-12.09	8.00	-20.09	PASS
High	2462	-10.96	8.00	-18.96	PASS

NOTE : 1. At final test to get the worst-case emission at 6Mbps long.
 2. The cable assembly insertion loss of 11.1dB (including 10 dB pad and 1.1 dB cable) was Entered as an offset in the spectrum analyzer to allow for direct reading of power.

IEEE 802.11n HT20 mode

Channel	Frequency (MHz)	PPSD Chain0 (dBm)	Limit (dBm)	Margin (dB)	Pass / Fail
Low	2412	-13.37	7.58	-20.94	PASS
Middle	2437	-13.77	7.58	-21.34	PASS
High	2462	-12.89	7.58	-20.47	PASS

NOTE : 1. At final test to get the worst-case emission at 6.5Mbps long.
 2. The cable assembly insertion loss of 11.1dB (including 10 dB pad and 1.1 dB cable) was Entered as an offset in the spectrum analyzer to allow for direct reading of power.

IEEE 802.11n HT40 mode

Channel	Frequency (MHz)	PPSD Chain0 (dBm)	Limit (dBm)	Margin (dB)	Pass / Fail
Low	2422	-15.07	7.58	-22.65	PASS
Middle	2437	-15.20	7.58	-22.78	PASS
High	2452	-14.14	7.58	-21.72	PASS

NOTE : 1. At final test to get the worst-case emission at 13Mbps long.
 2. The cable assembly insertion loss of 11.1dB (including 10 dB pad and 1.1 dB cable) was Entered as an offset in the spectrum analyzer to allow for direct reading of power.

POWER SPECTRAL DENSITY (IEEE 802.11b MODE)

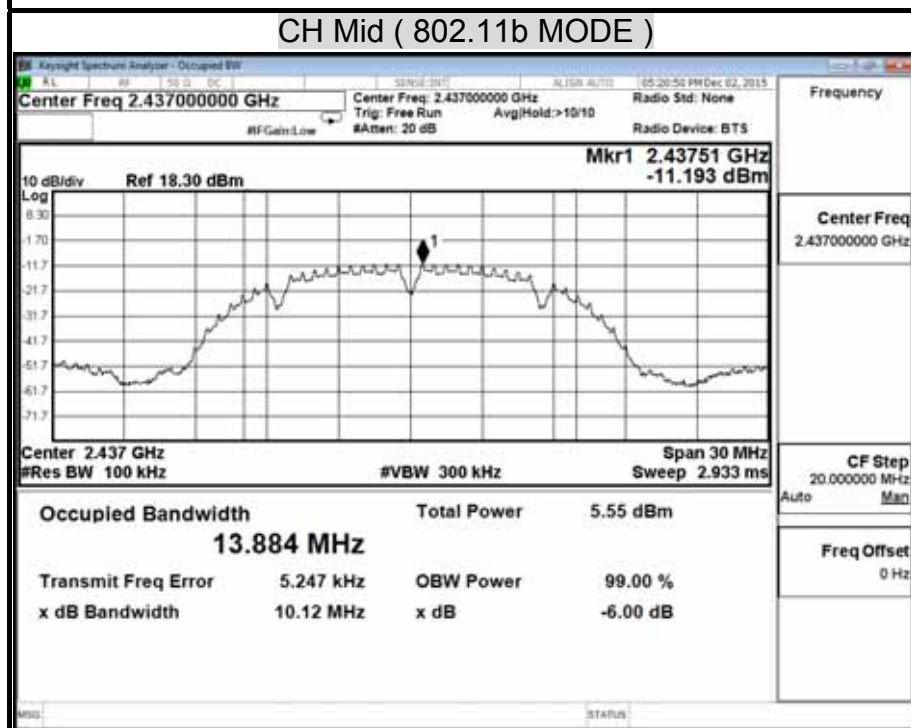
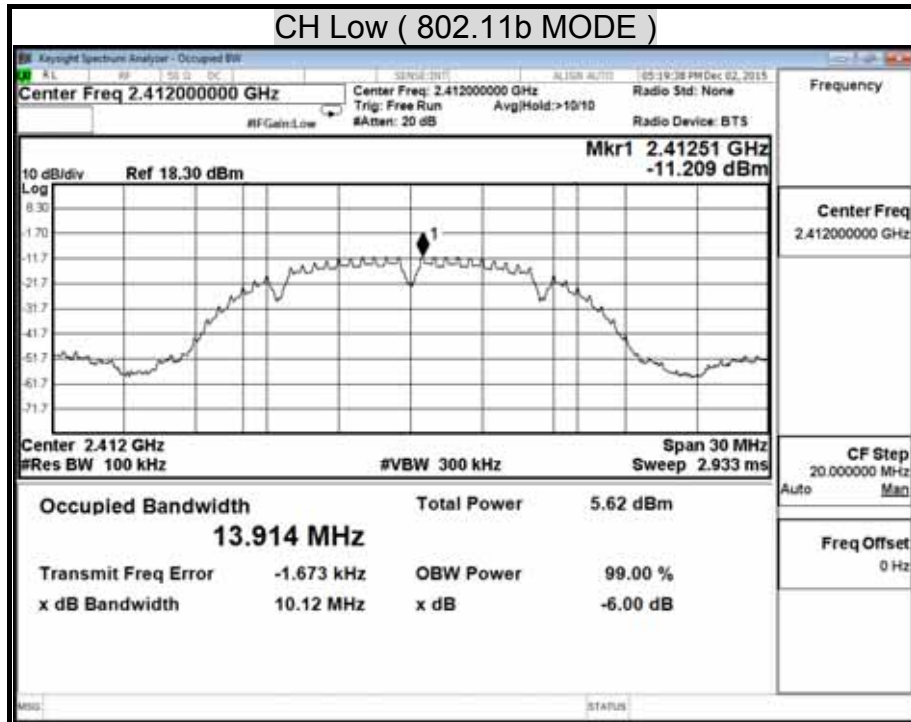

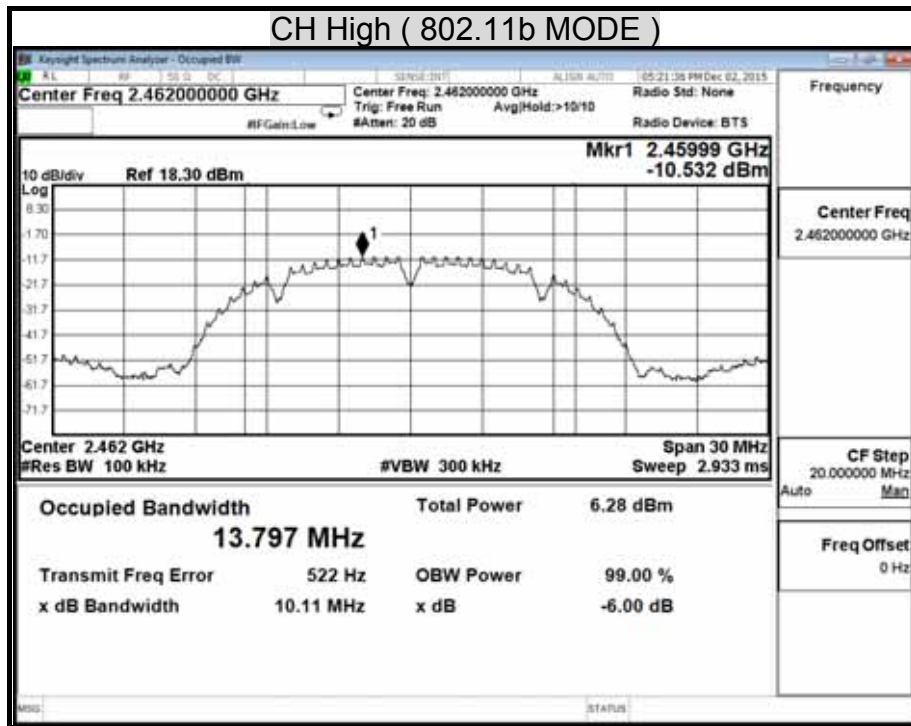

POWER SPECTRAL DENSITY (IEEE 802.11g MODE)

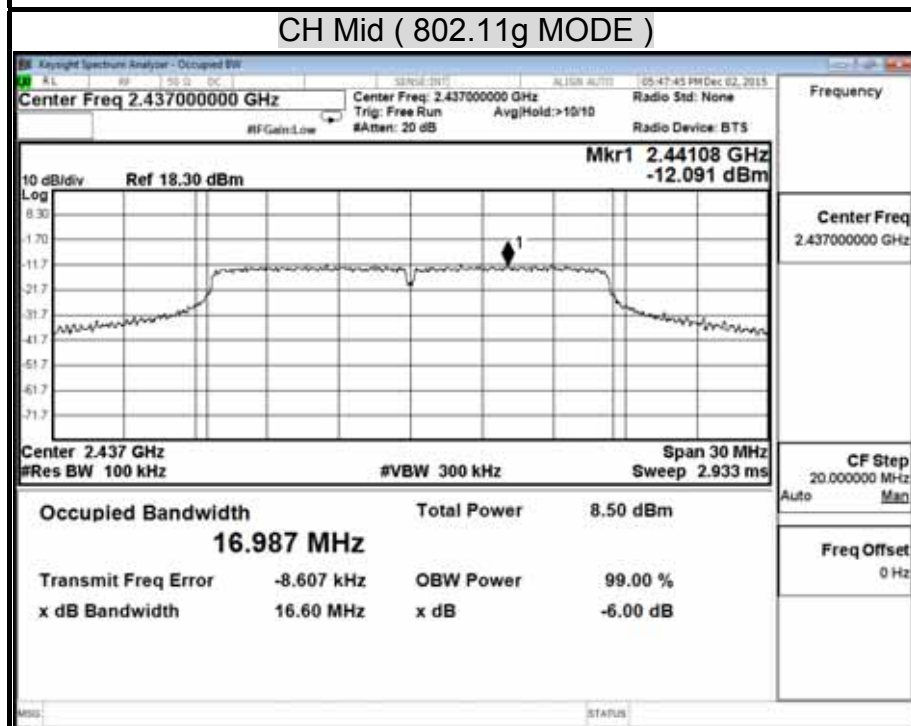
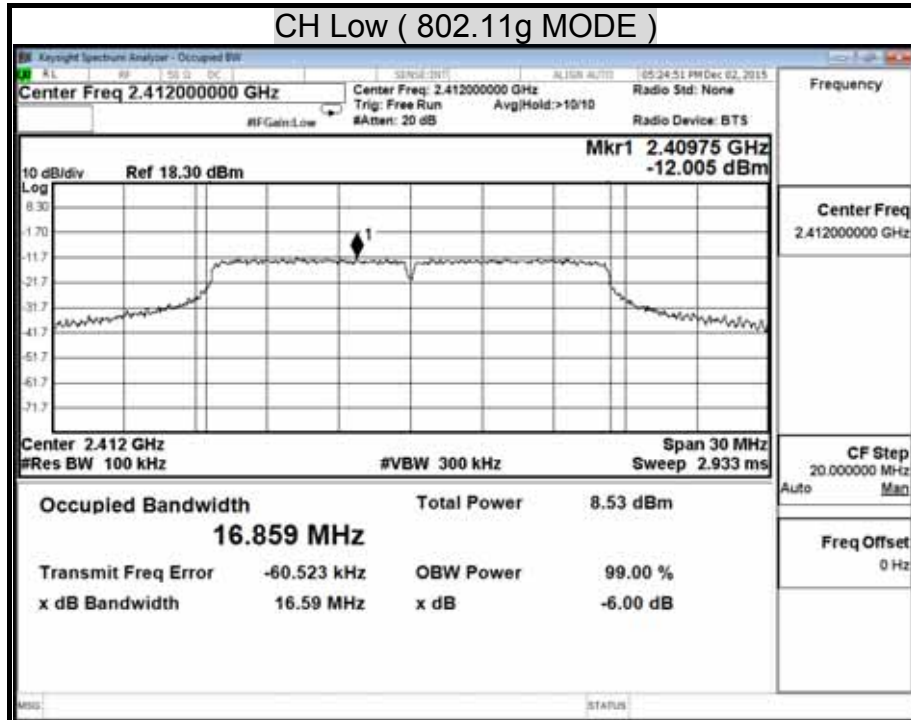

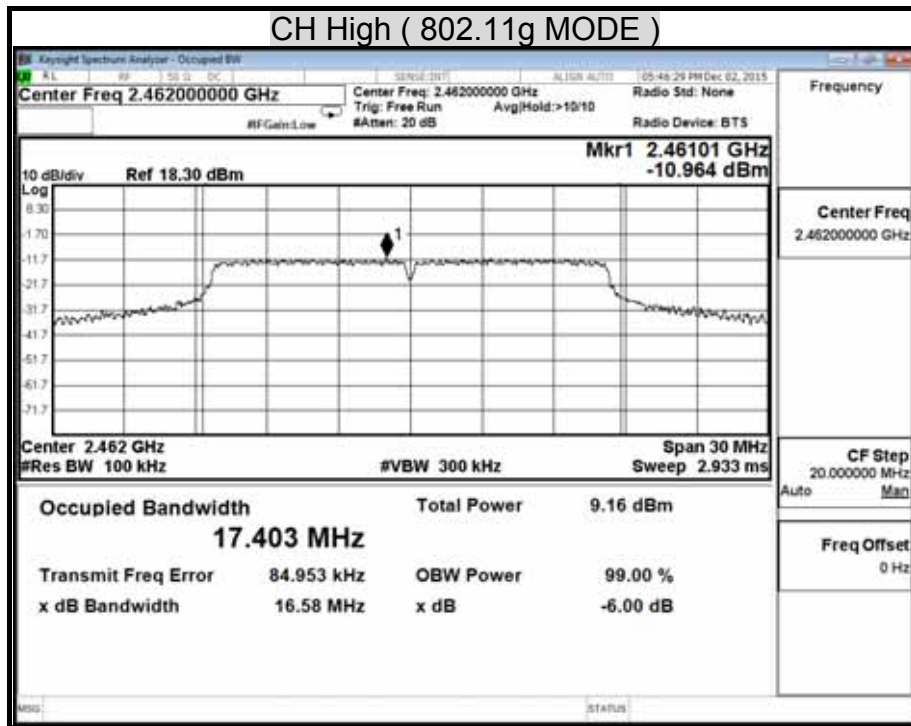

POWER SPECTRAL DENSITY (802.11n HT20 MODE)

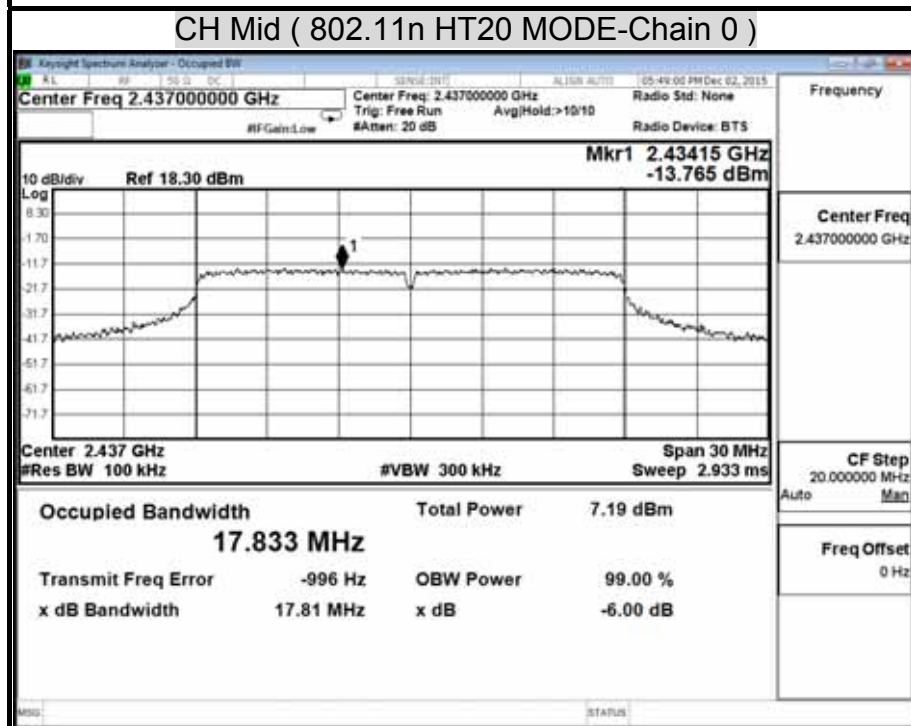
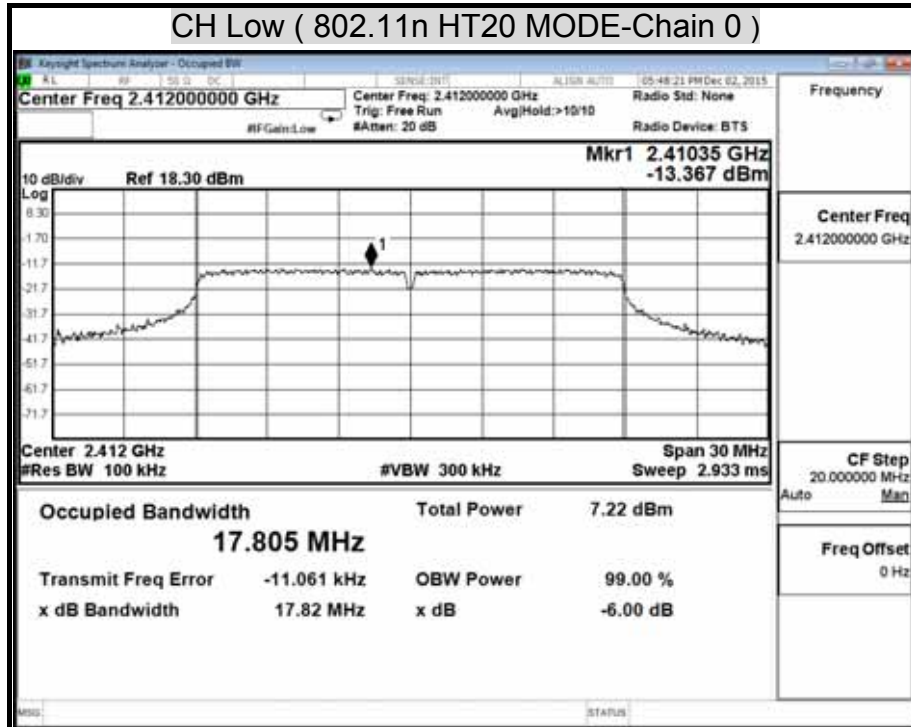

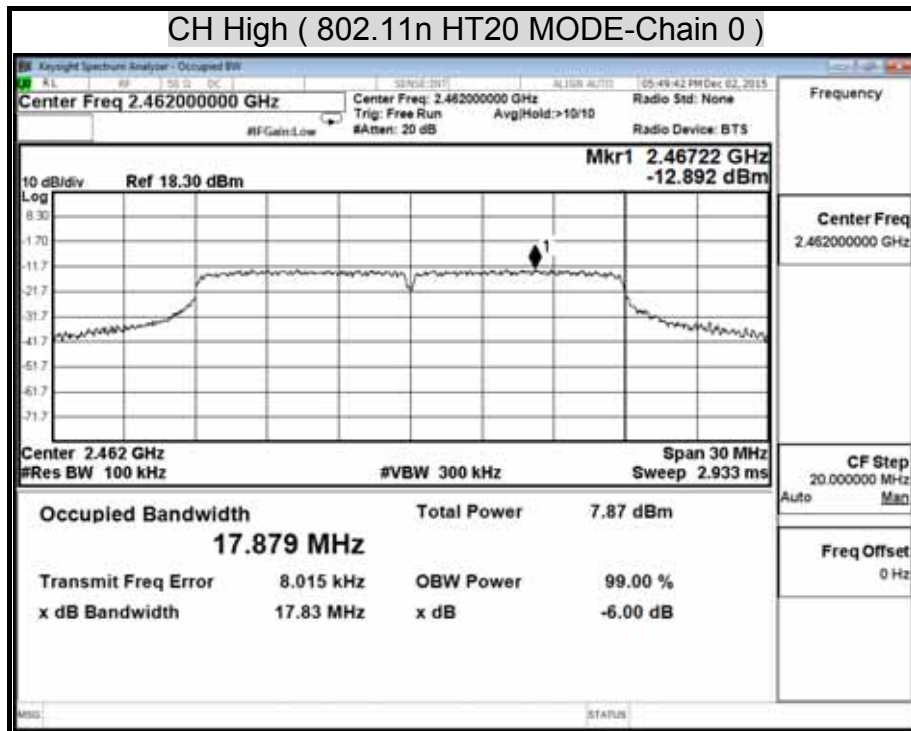

POWER SPECTRAL DENSITY (802.11n HT40 MODE)

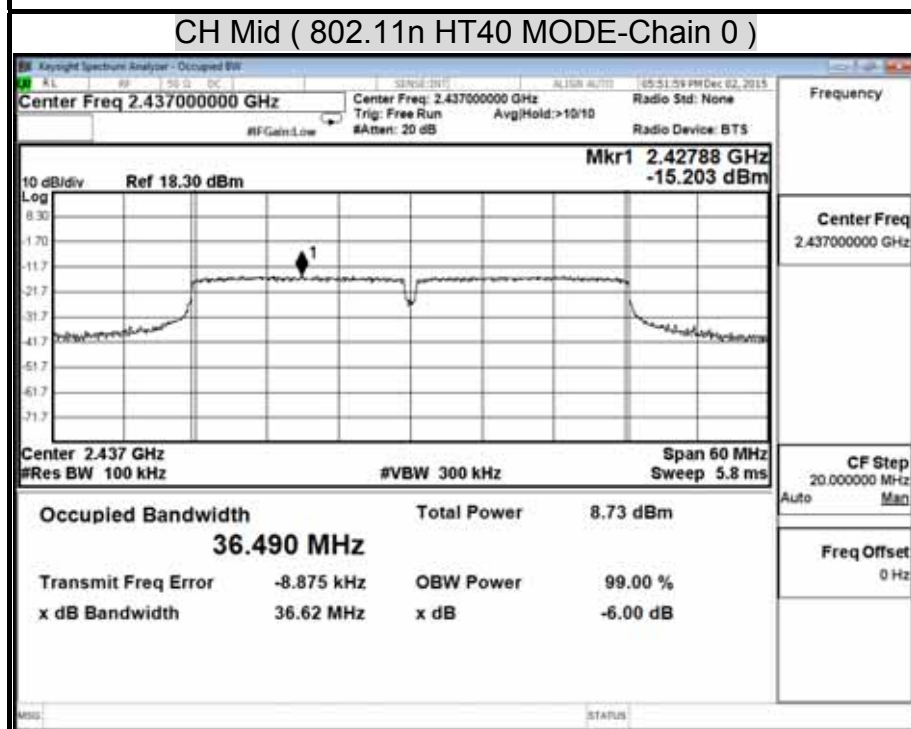
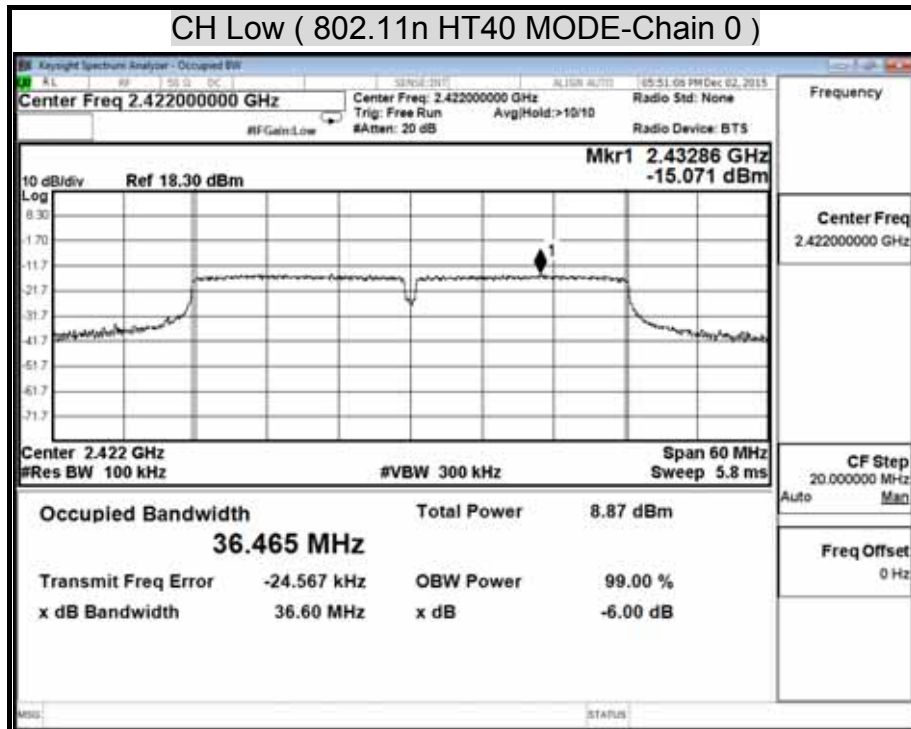

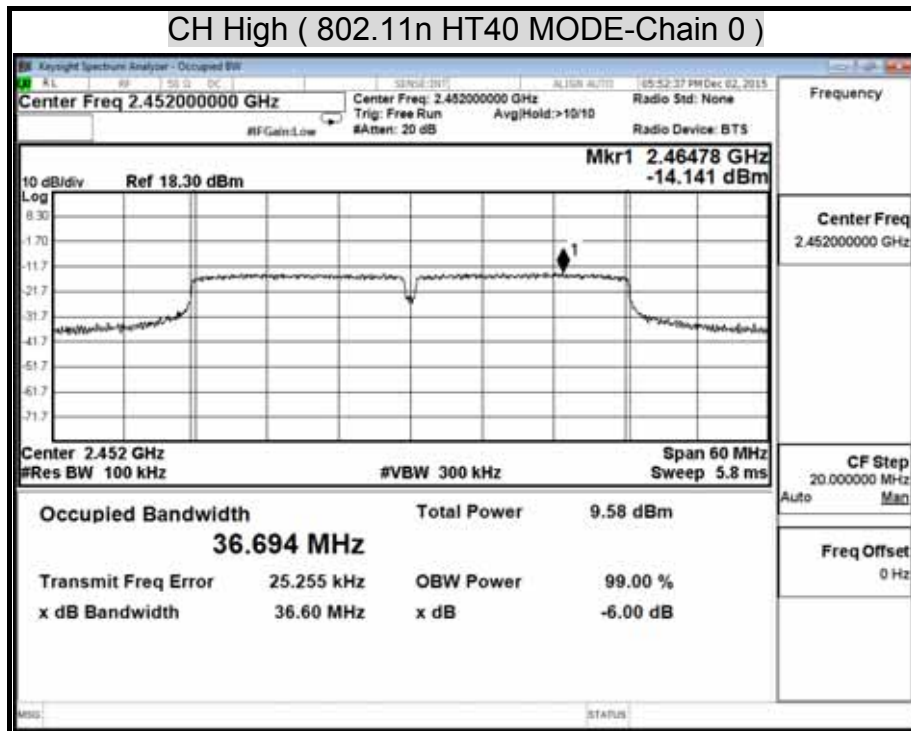

8.5 CONDUCTED SPURIOUS EMISSION

LIMITS

§ 15.247(d) In any 100 kHz bandwidth outside the frequency band in which the spread spectrum intentional radiator is operating, the radio frequency power that is produced by the intentional radiator shall be at least 20 dB below that in the 100 kHz bandwidth within the band that contains the highest level of the desired power, based on either an RF conducted or a radiated measurement. Attenuation below the general limits specified in § 15.209(a) is not required. In addition, radiated emissions which fall in the restricted bands, as defined in § 15.205(a), must also comply with the radiated emission limits specified in § 15.209(a) (see § 15.205(c)).

TEST EQUIPMENT

Name of Equipment	Manufacturer	Model	Serial Number	Calibration Due
EXA Spectrum Analyzer	KEYSIGHT	N9010A	MY54430216	JAN. 23, 2016

Remark: Each piece of equipment is scheduled for calibration once a year.

TEST SETUP



TEST PROCEDURE

The transmitter output is connected to a spectrum analyzer. The resolution bandwidth is set to 100 kHz. The video bandwidth is set to 300 kHz.

The spectrum from 30 MHz to 26 GHz is investigated with the transmitter set to the lowest, middle, and highest channels in the 2.4 GHz band.

TEST RESULTS

No non-compliance noted.

Model Name	ZA1002US-5	Test By	Ted Huang
Temp & Humidity	28.6°C, 57%	Test Date	2015/12/03

OUT-OF-BAND SPURIOUS EMISSIONS-CONDUCTED MEASUREMENT

(IEEE 802.11b MODE)

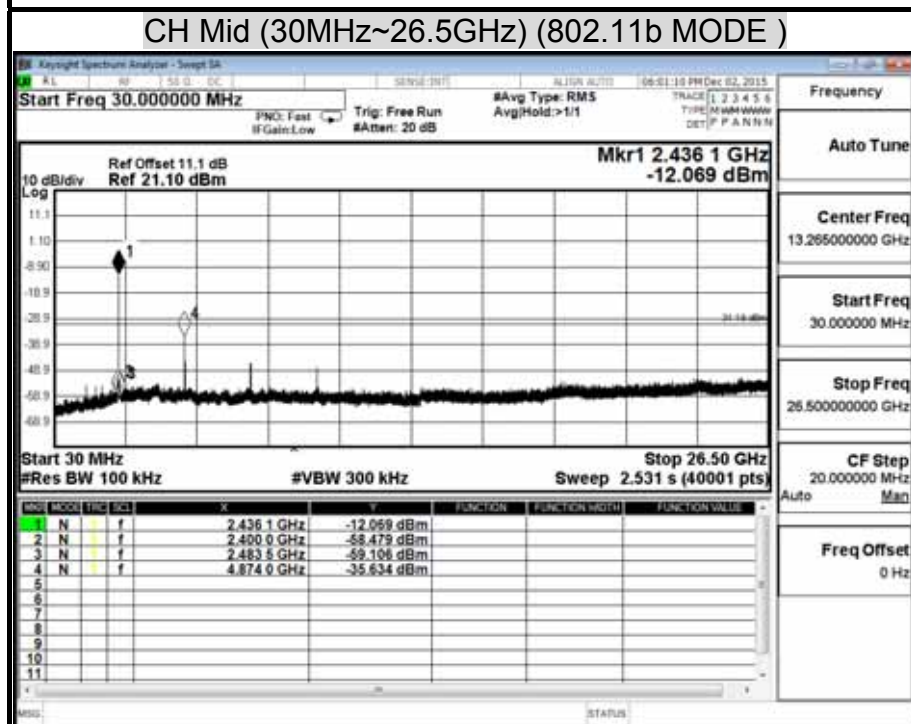
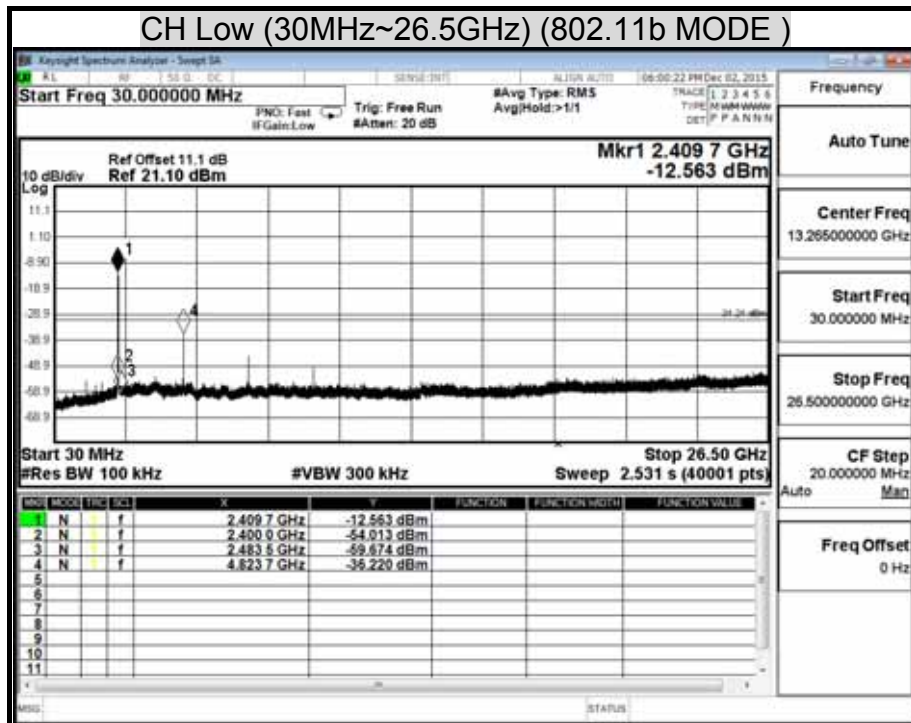

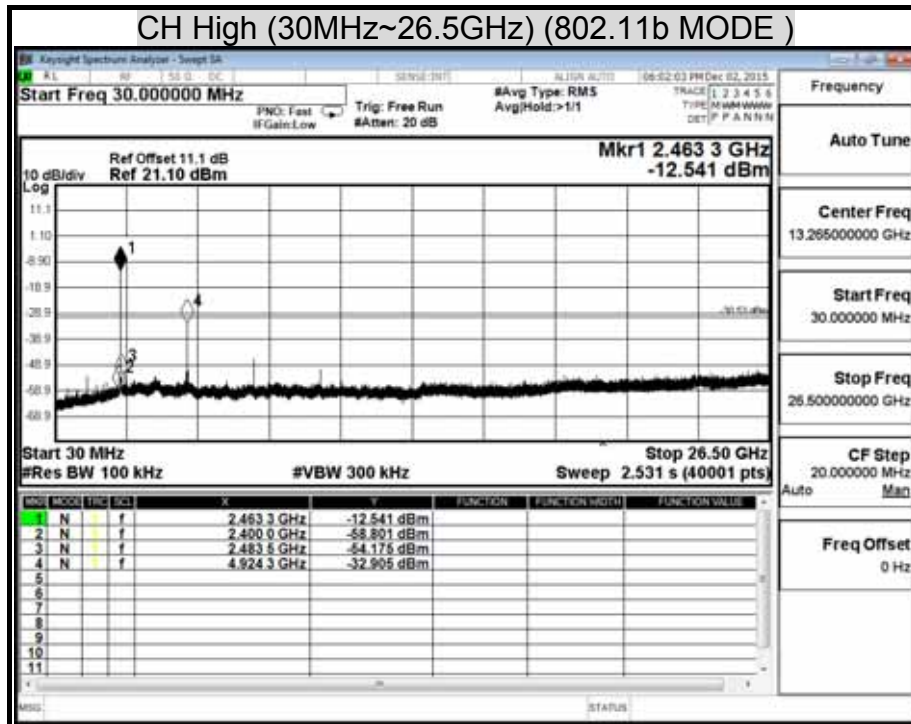

OUT-OF-BAND SPURIOUS EMISSIONS-CONDUCTED MEASUREMENT

(802.11g MODE)

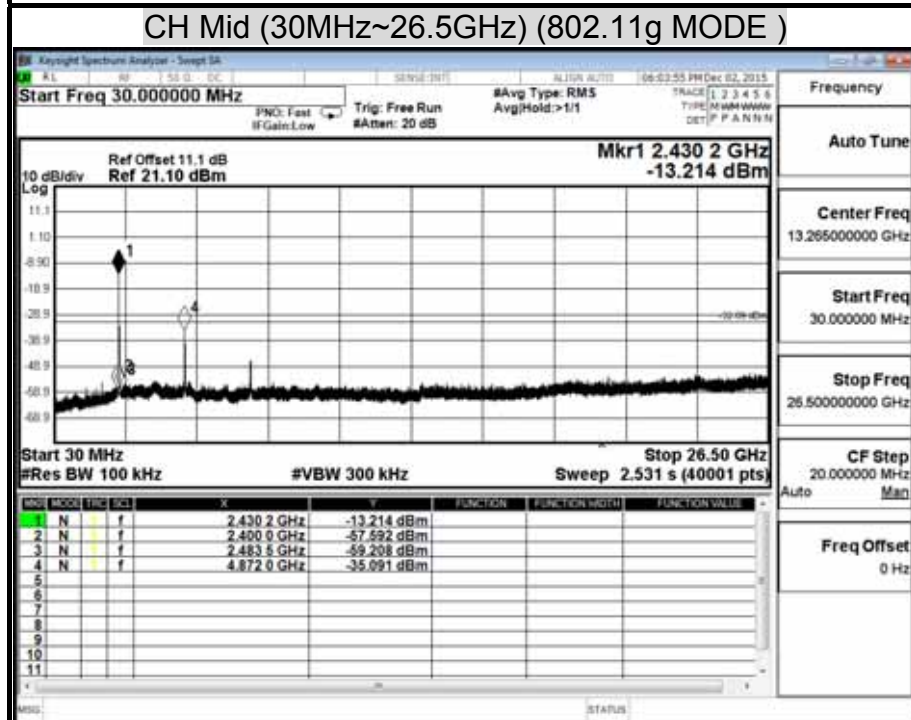
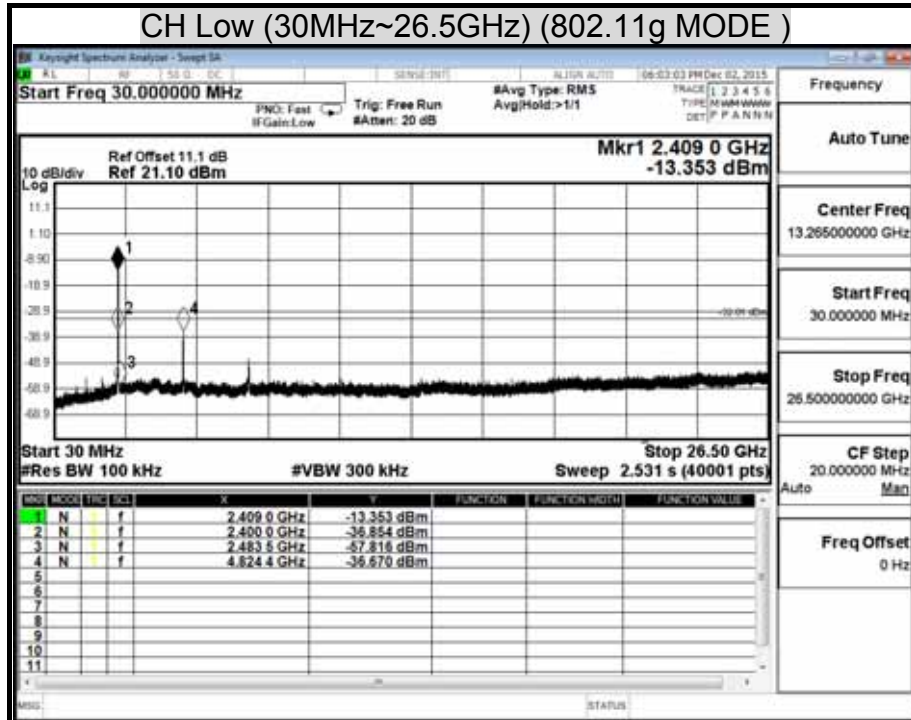

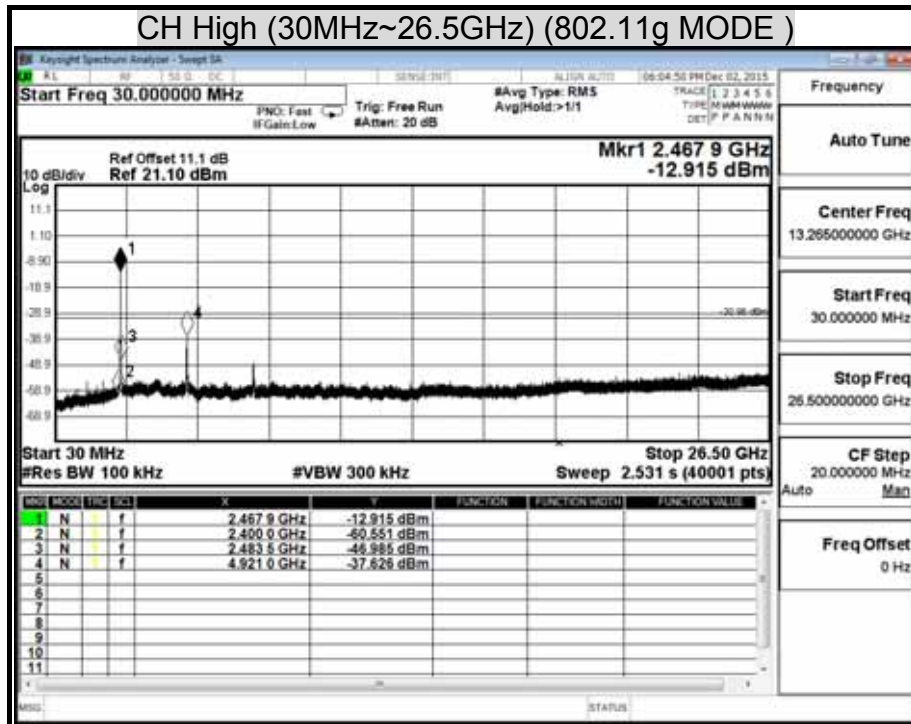

OUT-OF-BAND SPURIOUS EMISSIONS-CONDUCTED MEASUREMENT (802.11n HT20 MODE)

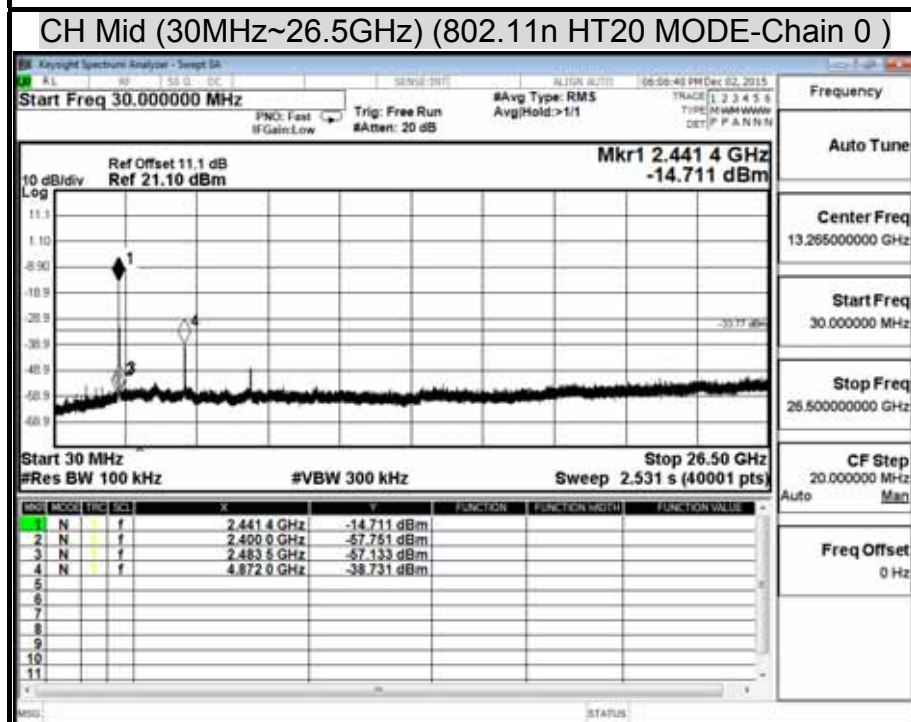
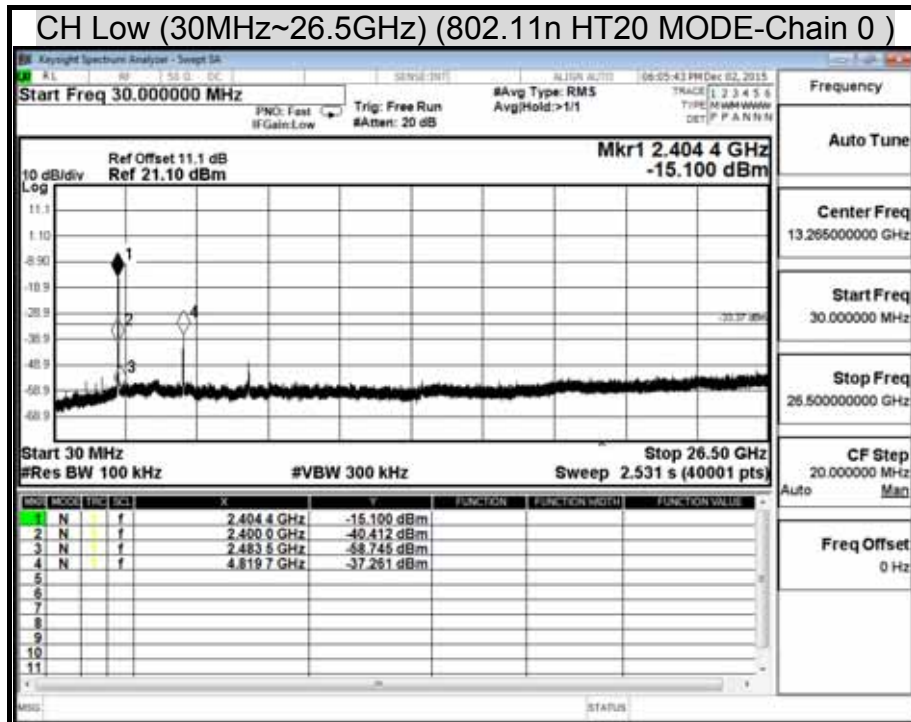

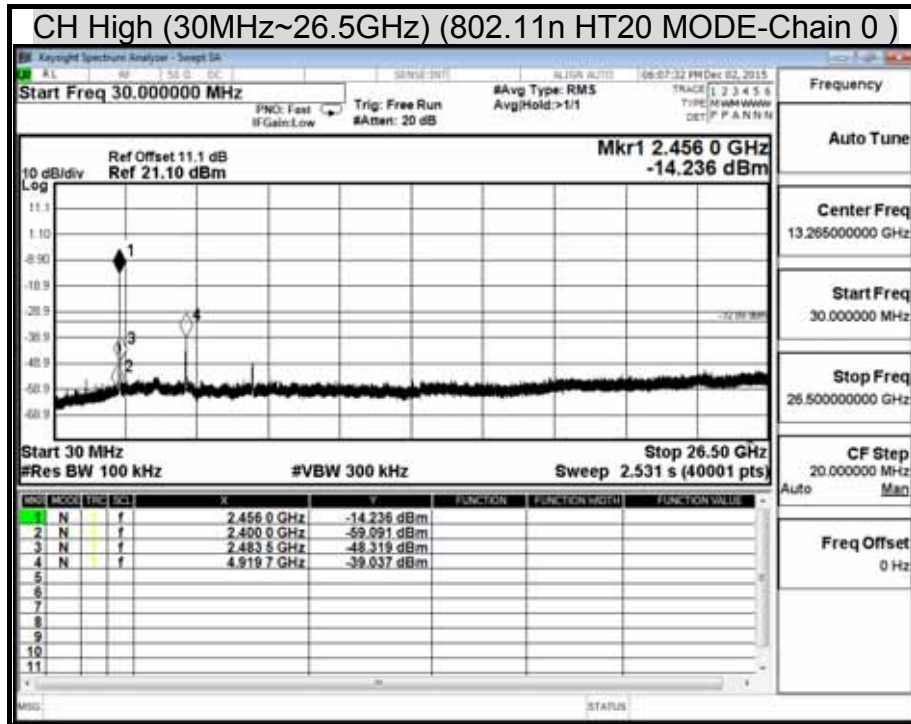

OUT-OF-BAND SPURIOUS EMISSIONS-CONDUCTED MEASUREMENT (802.11n HT40 MODE)

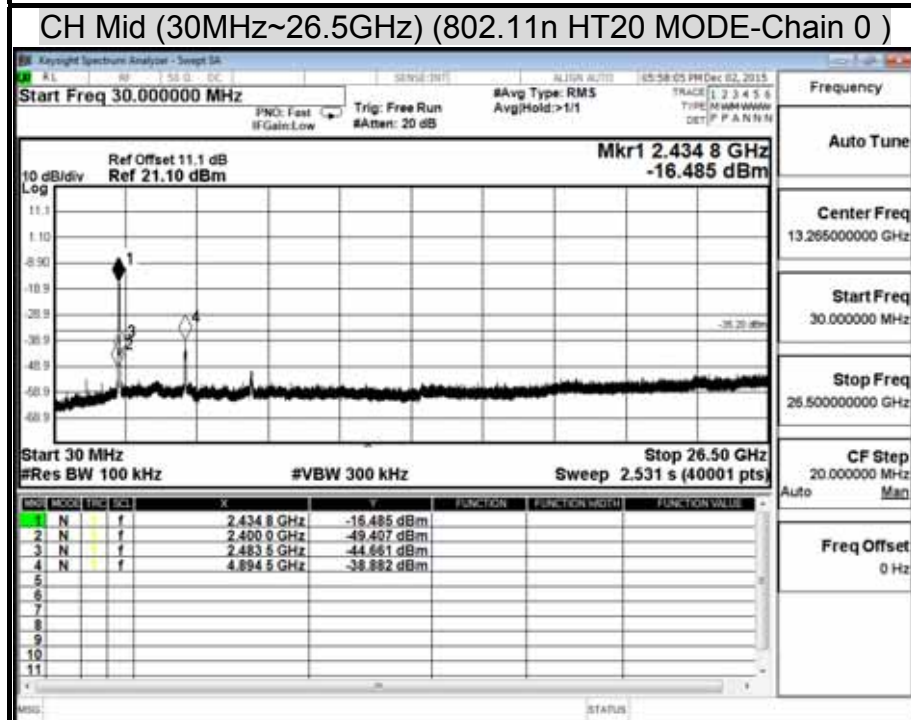
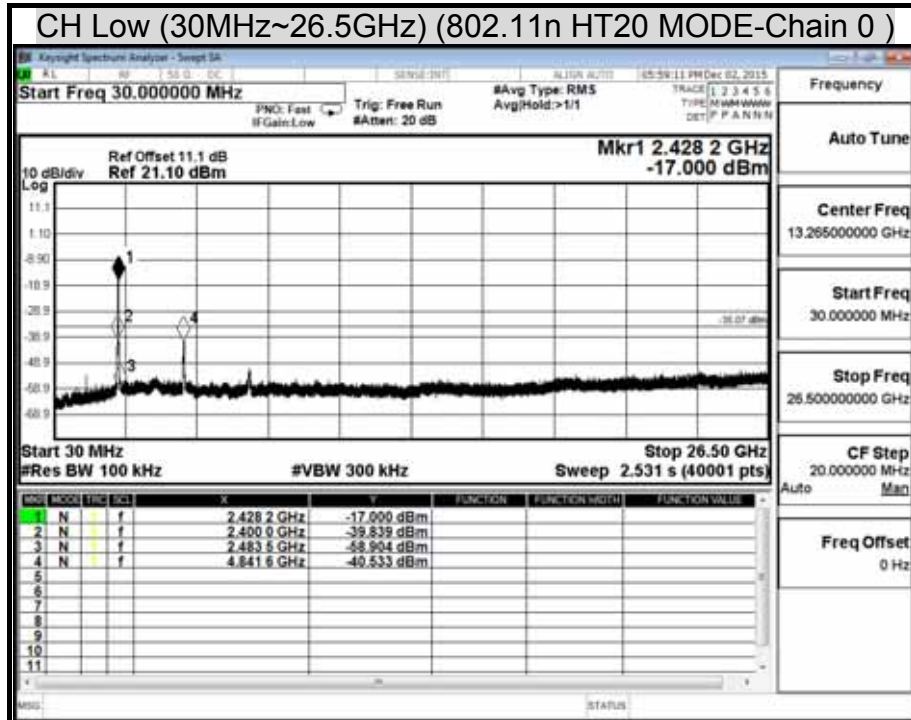

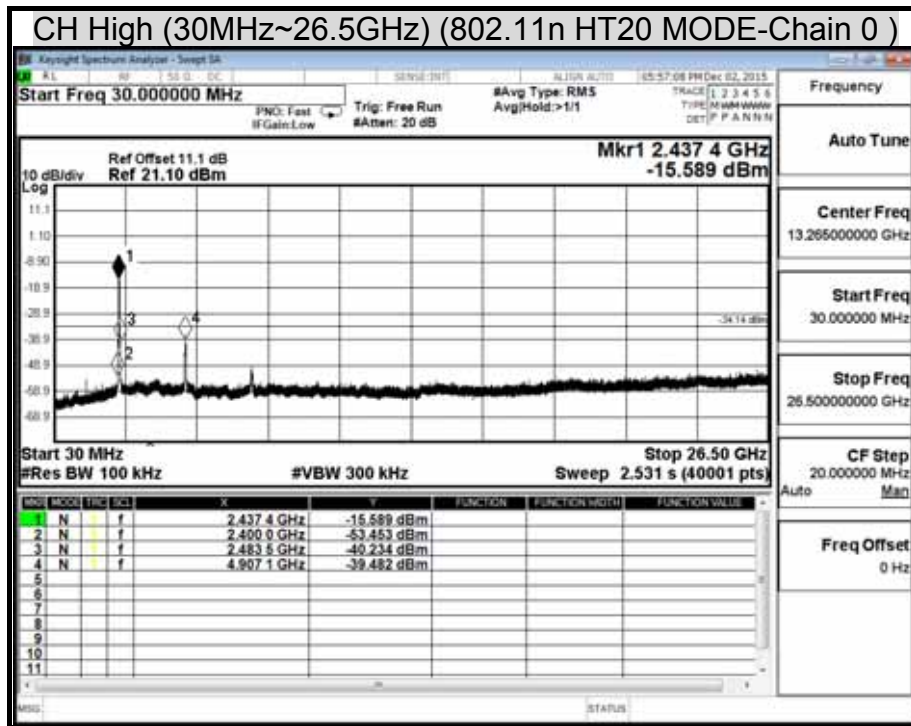

8.6 RADIATED EMISSIONS

8.6.1 TRANSMITTER RADIATED SUPURIOUS EMSSIONS

LIMITS

§ 15.205 (a) Except as shown in paragraph (d) of this section, only spurious emissions are permitted in any of the frequency bands listed below:

MHz	MHz	MHz	GHz
0.090 - 0.110	16.42 - 16.423	399.9 - 410	4.5 - 5.15
¹ 0.495 - 0.505	16.69475 - 16.69525	608 - 614	5.35 - 5.46
2.1735 - 2.1905	16.80425 - 16.80475	960 - 1240	7.25 - 7.75
4.125 - 4.128	25.5 - 25.67	1300 - 1427	8.025 - 8.5
4.17725 - 4.17775	37.5 - 38.25	1435 - 1626.5	9.0 - 9.2
4.20725 - 4.20775	73 - 74.6	1645.5 - 1646.5	9.3 - 9.5
6.215 - 6.218	74.8 - 75.2	1660 -1710	10.6 -12.7
6.26775 - 6.26825	108 -121.94	1718.8 - 1722.2	13.25 -13.4
6.31175 - 6.31225	123 - 138	2200 - 2300	14.47 – 14.5
8.291 - 8.294	149.9 - 150.05	2310 - 2390	15.35 -16.2
8.362 - 8.366	156.52475 - 156.52525	2483.5 - 2500	17.7 - 21.4
8.37625 - 8.38675	156.7 - 156.9	2655 - 2900	22.01 - 23.12
8.41425 - 8.41475	162.0125 - 167.17	3260 - 3267	23.6 - 24.0
12.29 - 12.293	167.72 - 173.2	3332 - 3339	31.2 - 31.8
12.51975 - 12.52025	240 - 285	3345.8 - 3338	36.43 - 36.5
12.57675 - 12.57725	322 -335.4	3600 - 4400	(²)
13.36 - 13.41			

¹ Until February 1, 1999, this restricted band shall be 0.490-0.510 MHz.

² Above 38.6

§ 15.205 (b) Except as provided in paragraphs (d) and (e), the field strength of emissions appearing within these frequency bands shall not exceed the limits shown in Section 15.209. At frequencies equal to or less than 1000 MHz, compliance with the limits in Section 15.209 shall be demonstrated using measurement instrumentation employing a CISPR quasi-peak detector. Above 1000 MHz, compliance with the emission limits in Section 15.209 shall be demonstrated based on the average value of the measured emissions. The provisions in Section 15.35 apply to these measurements.

§ 15.209 (a) Except as provided elsewhere in this Subpart, the emissions from an intentional radiator shall not exceed the field strength levels specified in the following table :

Frequency (MHz)	Field Strength (microvolts/meter)	Measurement Distance (meters)
30 - 88	100 **	3
88 - 216	150 **	3
216 - 960	200 **	3
Above 960	500	3

** Except as provided in paragraph (g), fundamental emissions from intentional radiators operating under this Section shall not be located in the frequency bands 54-72 MHz, 76-88 MHz, 174-216 MHz or 470-806 MHz, However, operation within these frequency bands is permitted under other sections of this Part, e-g, Sections 15.231 and 15.241.

§ 15.209 (b) In the emission table above, the tighter limit applies at the band edges.

TEST EQUIPMENTS

The following test equipments are utilized in making the measurements contained in this report.

Chamber Room # 966				
Name of Equipment	Manufacturer	Model	Serial Number	Calibration Due
HUBER+SUHNER	Cable	SUCOFLEX 104PEA	SN25737 /4PEA	JAN. 14, 2016
Antenna (天線)	Sunol sciences	JB1	A021306	AUG. 02, 2016
LOOP ANTENNA	EMCO	6502	8905-2356	JUN. 10, 2016
Pre-Amplifier	HP	8447F	2443A01671	JAN. 14, 2016
Pre-Amplifier	EMCI	EMC 012645	980098	DEC. 04, 2016
Horn Antenna	Com-Power	AH-118	071032	JAN. 09, 2016
3116 Double Ridge Antenna (40G)	ETS-LINDGREN	3116	00078900	MAR. 04, 2016
Turn Table	Yo Chen	001	-----	N.C.R.
Antenna Tower	AR	TP1000A	309874	N.C.R.
Controller	UC	UC300	-----	N.C.R.
RF Swith	E-INSTRUMENT TELH LTD	ERS-180A	EC1204141	N.C.R
EXA Spectrum Analyzer	KEYSIGHT	N9010A	MY54430216	JAN. 23, 2016
Test S/W	e-3 (5.04303e)			

TEST SETUP

The diagram below shows the test setup that is utilized to make the measurements for emission from 30 to 1GHz.

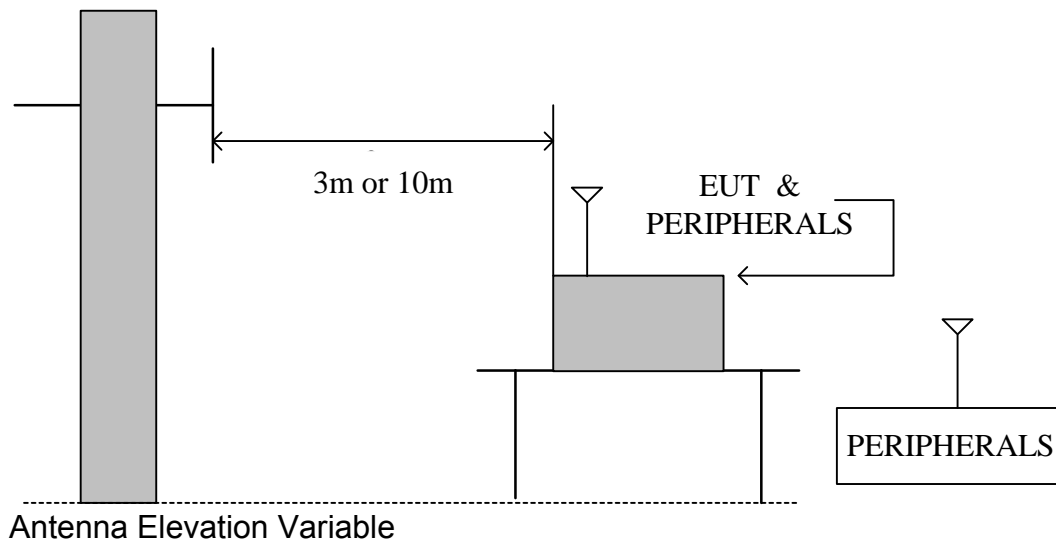

The diagram below shows the test setup that is utilized to make the measurements for emission above 1GHz.

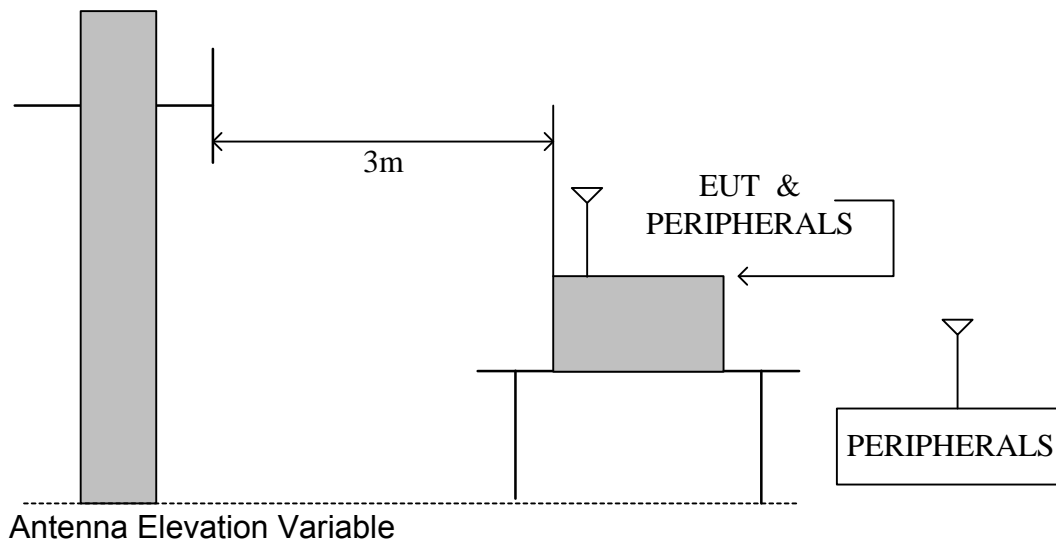

TEST PROCEDURE

- a. The EUT was placed on the top of a rotating table 1.5 meters above the ground at a 10 meter chamber test site. The table was rotated 360 degrees to determine the position of the highest radiation.
- b. While measuring the radiated emission below 1GHz, the EUT was set 3/10 meters away from the interference-receiving antenna, which was mounted on the top of a variable-height antenna tower. While measuring the radiated emission above 1GHz, the EUT was set 3 meters away from the interference-receiving antenna
- c. The antenna is a broadband antenna, and its height is varied from one meter to four meters above the ground to determine the maximum value of the field strength. Both horizontal and vertical polarization of the antenna are set to make the measurement.
- d. For each suspected emission, the EUT was arranged to its worst case and then the antenna was tuned to heights from 1 meter to 4 meters and the table was turned from 0 degrees to 360 degrees to find the maximum reading.
- e. The test-receiver system was set to Peak Detect Function and Specified Bandwidth with Maximum Hold Mode.
- f. If the emission level of the EUT in peak mode was 10 dB lower than the limit specified, then testing could be stopped and the peak values of the EUT would be reported. Otherwise the emissions that did not have 10 dB margin would be re-tested one by one using peak, quasi-peak or average method as specified and then reported in a data sheet.
- g. The tests were performed in accordance with KDB 558074 5.4 .

NOTE :

1. The resolution bandwidth and video bandwidth of test receiver/spectrum analyzer is 120 KHz for Peak detection (PK) and Quasi-peak detection (QP) at frequency below 1GHz.
2. The resolution bandwidth and video bandwidth of test receiver/spectrum analyzer is 1 MHz for Peak detection and frequency above 1GHz.
3. The resolution bandwidth of test receiver/spectrum analyzer is 1 MHz and the video bandwidth is 10 Hz for Average detection (AV) at frequency above 1GHz.
4. No emission is found between lowest internal used/generated frequency to 30MHz (9kHz~30MHz)

TEST RESULTS

No non-compliance noted.

8.6.2 WORST-CASE RADIATED EMISSION BELOW 1 GHZ

Model No.	ZA1002US-5	Test Mode	Normal Operation
Environmental Conditions	27.4 , 58% RH	Resolution Bandwidth	120 kHz
Antenna Pole	Vertical	Antenna Distance	10m
Detector Function:	Quasi-peak.	Tested By	Ted Huang
Test Site	OATS 5	Tested Data	2015/11/06

(The chart below shows the highest readings taken from the final data.)

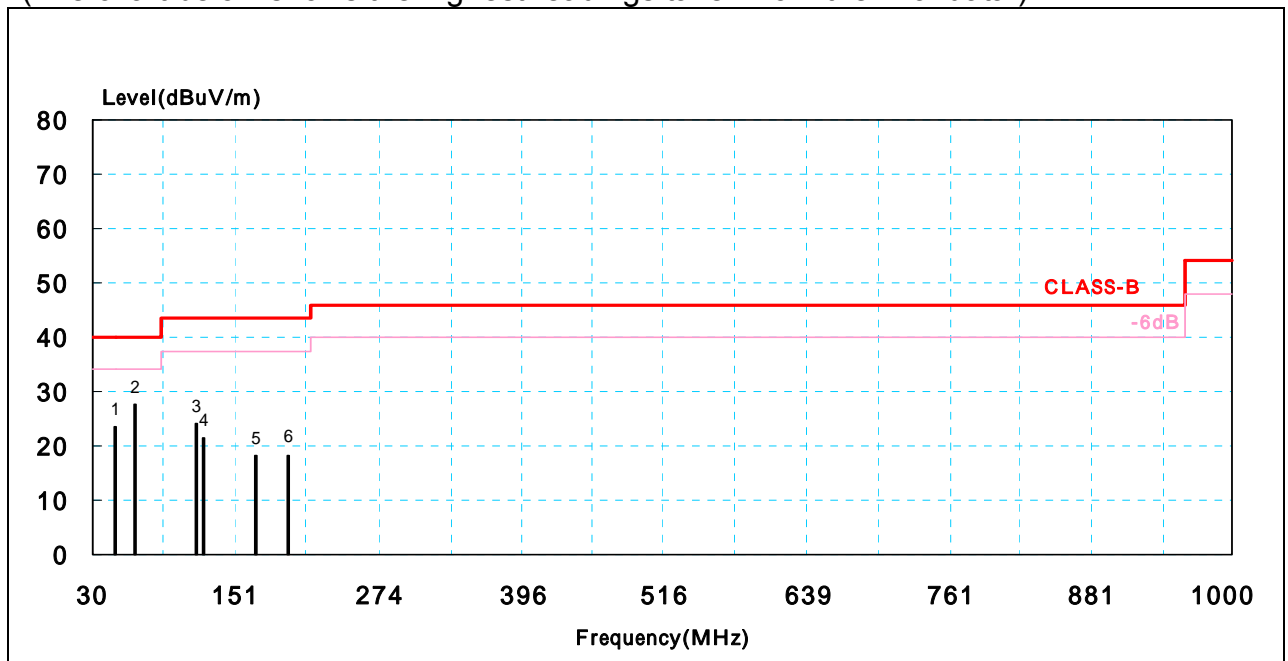

No.	Freq- Uency	Meter Reading at 3 m Level	Antenna Factor	Cable Loss	Emission at 3 m Level	Limits	Margin	Detector Mode
	(MHz)	(dBμV)	(dB/m)	(dB)	(dBμV/m)	(dBμV/m)	(dB)	PK/QP
1	49.40	12.68	8.92	2.02	23.62	40.00	-16.38	QP
2	66.37	17.42	8.10	2.21	27.73	40.00	-12.27	QP
3	117.30	7.52	13.55	3.06	24.13	43.50	-19.37	QP
4	124.68	4.55	13.95	3.12	21.62	43.50	-21.88	QP
5	168.45	2.55	12.24	3.39	18.18	43.50	-25.32	QP
6	196.48	1.48	13.19	3.55	18.22	43.50	-25.28	QP

Note: 1. QP= Quasi-peak Reading.
 2. The other emission levels were very low against the limit

Model No.	ZA1002US-5	Test Mode	Normal Operation
Environmental Conditions	27.4 , 58% RH	Resolution Bandwidth	120 kHz
Antenna Pole	Horizontal	Antenna Distance	10m
Detector Function	Quasi-peak.	Tested By	Ted Huang
Test Site	OATS 5	Tested Data	2015/11/06

(The chart below shows the highest readings taken from the final data.)

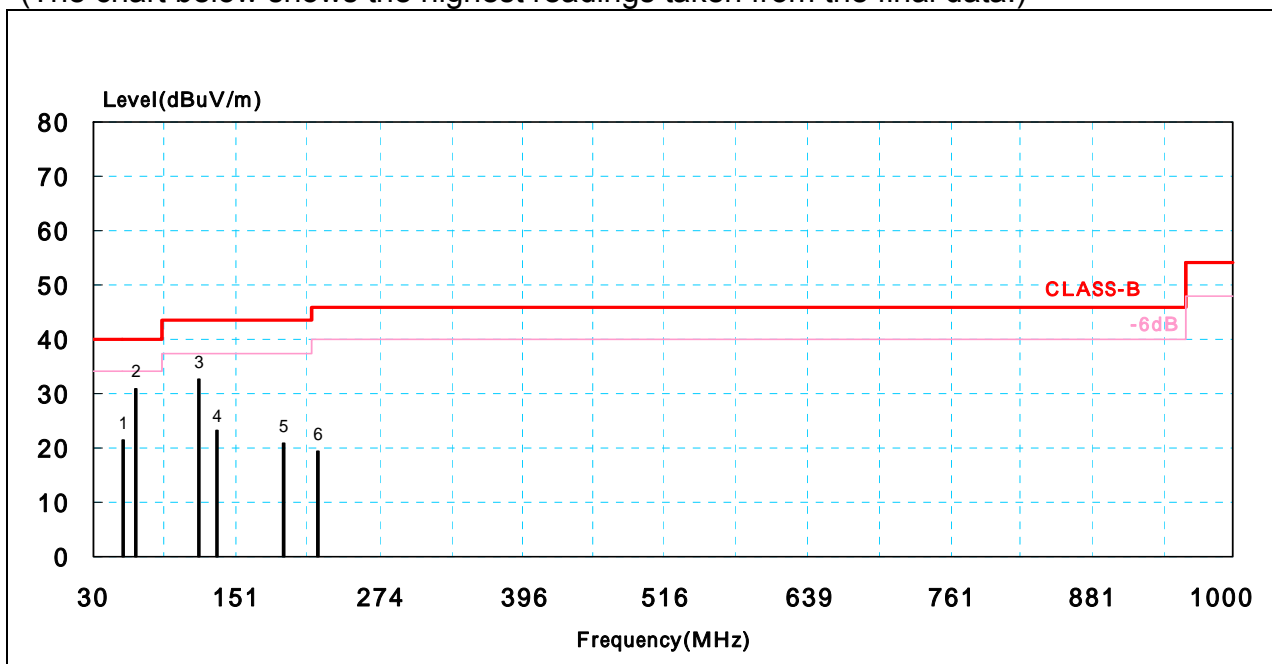

No.	Freq- Uency (MHz)	Meter Reading at 3 m Level (dBμV)	Antenna Factor (dB/m)	Cable Loss (dB)	Emission at 3 m Level (dBμV/m)	Limits (dBμV/m)	Margin (dB)	Detector Mode PK/QP
1	54.84	11.36	8.09	2.05	21.50	40.00	-18.50	QP
2	66.37	20.68	8.10	2.21	30.99	40.00	-9.01	QP
3	119.72	15.48	14.00	3.10	32.57	43.50	-10.93	QP
4	134.68	6.39	13.73	3.13	23.25	43.50	-20.25	QP
5	192.48	4.66	12.79	3.54	21.00	43.50	-22.50	QP
6	220.35	2.68	13.04	3.72	19.44	46.00	-26.56	QP

Note: 1. QP= Quasi-peak Reading.
 2. The other emission levels were very low against the limit

8.6.3 TRANSMITTER RADIATED EMISSION ABOVE 1 GHz

Product Name	Enterprise Access Point	Test Date	2015/12/03
Model	ZA1002US-5	Test By	Ted Huang
Test Mode	IEEE 802.11b TX (CH Low)	TEMP& Humidity	28.6 , 57%

TX / IEEE 802.11b mode / CH Low				Measurement Distance at 3m				Horizontal polarity	
Freq.	Reading	AF	Cable Loss	Pre-amp	Filter	Level	Limit	Margin	Mark
(MHz)	(dBµV)	(dB/m)	(dB)	(dB)	(dB)	(dBµV/m)	(dBµV/m)	(dB)	(P/Q/A)
1935.98	60.58	30.03	2.29	48.17	0.30	45.03	74.00	-28.97	P
1935.98	56.77	30.03	2.29	48.17	0.30	41.22	54.00	-12.78	A
3215.95	54.19	30.69	3.03	47.27	0.30	40.93	74.00	-33.07	P
3215.95	46.18	30.69	3.03	47.27	0.30	32.92	54.00	-21.08	A
* 4824.04	63.39	33.87	3.78	48.29	0.40	53.15	74.00	-20.85	P
* 4824.04	59.13	33.87	3.78	48.29	0.40	48.88	54.00	-5.12	A
N/A	-----	-----	-----	-----	-----	-----	-----	-----	P
N/A	-----	-----	-----	-----	-----	-----	-----	-----	A

TX / IEEE 802.11b mode / CH Low				Measurement Distance at 3m				Vertical polarity	
Freq.	Reading	AF	Cable Loss	Pre-amp	Filter	Level	Limit	Margin	Mark
(MHz)	(dBµV)	(dB/m)	(dB)	(dB)	(dB)	(dBµV/m)	(dBµV/m)	(dB)	(P/Q/A)
* 1584.12	57.93	27.42	2.06	48.65	0.30	39.06	74.00	-34.94	P
* 1584.12	52.15	27.42	2.06	48.65	0.30	33.28	54.00	-20.72	A
3215.89	54.47	30.69	3.03	47.27	0.30	41.21	74.00	-32.79	P
3215.89	45.43	30.69	3.03	47.27	0.30	32.17	54.00	-21.83	A
* 4824.03	60.58	33.87	3.78	48.29	0.40	50.34	74.00	-23.66	P
* 4824.03	56.75	33.87	3.78	48.29	0.40	46.50	54.00	-7.50	A
N/A	-----	-----	-----	-----	-----	-----	-----	-----	P
N/A	-----	-----	-----	-----	-----	-----	-----	-----	A

REMARK:

1. AF: Antenna Factor, Cable: Cable Loss, Pre-Amp: Preamplifier gain, Filter: 2.4GHz~2.5GHz Filter Insertion Loss
2. Spectrum analyzer setting P(Peak): RBW=1MHz, VBW=1MHz, A(Average): RBW=1MHz, VBW=10Hz
3. The result basic equation calculation is as follow:
Level = Reading + AF + Cable – Preamp + Filter , Margin = Level-Limit
4. The other emission levels were 20dB below the limit
5. The test limit distance is 3M limit.

Product Name	Enterprise Access Point	Test Date	2015/12/03
Model	ZA1002US-5	Test By	Ted Huang
Test Mode	IEEE 802.11b TX (CH Middle)	TEMP& Humidity	28.6 , 57%

TX / IEEE 802.11b mode / CH Middle				Measurement Distance at 3m				Horizontal polarity	
Freq.	Reading	AF	Cable Loss	Pre-amp	Filter	Level	Limit	Margin	Mark
(MHz)	(dBμV)	(dB/m)	(dB)	(dB)	(dB)	(dBμV/m)	(dBμV/m)	(dB)	(P/Q/A)
1935.97	60.80	30.03	2.29	48.17	0.30	45.24	74.00	-28.76	P
1935.97	56.46	30.03	2.29	48.17	0.30	40.91	54.00	-13.09	A
3249.33	55.48	30.70	3.04	47.30	0.30	42.22	74.00	-31.78	P
3249.33	46.74	30.70	3.04	47.30	0.30	33.48	54.00	-20.52	A
* 4874.04	63.62	34.02	3.80	48.29	0.40	53.54	74.00	-20.46	P
* 4874.04	59.24	34.02	3.80	48.29	0.40	49.16	54.00	-4.84	A
N/A	-----	-----	-----	-----	-----	-----	-----	-----	P
N/A	-----	-----	-----	-----	-----	-----	-----	-----	A

TX / IEEE 802.11b mode / CH Middle				Measurement Distance at 3m				Vertical polarity	
Freq.	Reading	AF	Cable Loss	Pre-amp	Filter	Level	Limit	Margin	Mark
(MHz)	(dBμV)	(dB/m)	(dB)	(dB)	(dB)	(dBμV/m)	(dBμV/m)	(dB)	(P/Q/A)
* 1583.95	56.78	27.42	2.06	48.65	0.30	37.91	74.00	-36.09	P
* 1583.95	50.65	27.42	2.06	48.65	0.30	31.78	54.00	-22.22	A
3249.34	54.04	30.70	3.04	47.30	0.30	40.79	74.00	-33.21	P
3249.34	45.64	30.70	3.04	47.30	0.30	32.38	54.00	-21.62	A
* 4873.97	60.45	34.02	3.80	48.29	0.40	50.38	74.00	-23.62	P
* 4873.97	56.83	34.02	3.80	48.29	0.40	46.75	54.00	-7.25	A
N/A	-----	-----	-----	-----	-----	-----	-----	-----	P
N/A	-----	-----	-----	-----	-----	-----	-----	-----	A

REMARK:

1. AF: Antenna Factor, Cable: Cable Loss, Pre-Amp: Preamplifier gain, Filter: 2.4GHz-2.5GHz Filter Insertion Loss
2. Spectrum analyzer setting P(Peak): RBW=1MHz, VBW=1MHz, A(Average): RBW=1MHz, VBW=10Hz
3. The result basic equation calculation is as follow:
Level = Reading + AF + Cable – Preamp + Filter , Margin = Level-Limit
4. The other emission levels were 20dB below the limit
5. The test limit distance is 3M limit.

Product Name	Enterprise Access Point	Test Date	2015/12/03
Model	ZA1002US-5	Test By	Ted Huang
Test Mode	IEEE 802.11b TX (CH High)	TEMP& Humidity	28.6 , 57%

TX / IEEE 802.11b mode / CH High				Measurement Distance at 3m				Horizontal polarity	
Freq.	Reading	AF	Cable Loss	Pre-amp	Filter	Level	Limit	Margin	Mark
(MHz)	(dBµV)	(dB/m)	(dB)	(dB)	(dB)	(dBµV/m)	(dBµV/m)	(dB)	(P/Q/A)
1935.98	60.73	30.03	2.29	48.17	0.30	45.18	74.00	-28.82	P
1935.98	57.40	30.03	2.29	48.17	0.30	41.85	54.00	-12.15	A
3282.62	55.26	30.71	3.06	47.33	0.30	42.01	74.00	-31.99	P
3282.62	47.13	30.71	3.06	47.33	0.30	33.88	54.00	-20.12	A
* 4924.00	64.52	34.17	3.82	48.30	0.40	54.61	74.00	-19.39	P
* 4924.00	59.33	34.17	3.82	48.30	0.40	49.42	54.00	-4.58	A
N/A	-----	-----	-----	-----	-----	-----	-----	-----	P
N/A	-----	-----	-----	-----	-----	-----	-----	-----	A

TX / IEEE 802.11b mode / CH High				Measurement Distance at 3m				Vertical polarity	
Freq.	Reading	AF	Cable Loss	Pre-amp	Filter	Level	Limit	Margin	Mark
(MHz)	(dBµV)	(dB/m)	(dB)	(dB)	(dB)	(dBµV/m)	(dBµV/m)	(dB)	(P/Q/A)
* 1583.99	57.41	27.42	2.06	48.65	0.30	38.54	74.00	-35.46	P
* 1583.99	51.48	27.42	2.06	48.65	0.30	32.61	54.00	-21.39	A
3282.69	54.38	30.71	3.06	47.33	0.30	41.12	74.00	-32.88	P
3282.69	47.09	30.71	3.06	47.33	0.30	33.84	54.00	-20.16	A
* 4924.00	60.75	34.17	3.82	48.30	0.40	50.84	74.00	-23.16	P
* 4924.00	56.08	34.17	3.82	48.30	0.40	46.18	54.00	-7.82	A
N/A	-----	-----	-----	-----	-----	-----	-----	-----	P
N/A	-----	-----	-----	-----	-----	-----	-----	-----	A

REMARK:

1. AF: Antenna Factor, Cable: Cable Loss, Pre-Amp: Preamplifier gain, Filter: 2.4GHz~2.5GHz Filter Insertion Loss
2. Spectrum analyzer setting P(Peak): RBW=1MHz, VBW=1MHz, A(Average): RBW=1MHz, VBW=10Hz
3. The result basic equation calculation is as follow:
Level = Reading + AF + Cable – Preamp + Filter , Margin = Level-Limit
4. The other emission levels were 20dB below the limit
5. The test limit distance is 3M limit.

Product Name	Enterprise Access Point	Test Date	2015/12/03
Model	ZA1002US-5	Test By	Ted Huang
Test Mode	IEEE 802.11g TX (CH Low)	TEMP& Humidity	28.6 , 57%

TX / IEEE 802.11g mode / CH Low				Measurement Distance at 3m				Horizontal polarity	
Freq.	Reading	AF	Cable Loss	Pre-amp	Filter	Level	Limit	Margin	Mark
(MHz)	(dBμV)	(dB/m)	(dB)	(dB)	(dB)	(dBμV/m)	(dBμV/m)	(dB)	(P/Q/A)
1936.02	60.82	30.03	2.29	48.17	0.30	45.27	74.00	-28.73	P
1936.02	56.93	30.03	2.29	48.17	0.30	41.38	54.00	-12.62	A
3215.95	54.81	30.69	3.03	47.27	0.30	41.55	74.00	-32.45	P
3215.95	46.31	30.69	3.03	47.27	0.30	33.05	54.00	-20.95	A
* 4825.60	71.20	33.88	3.78	48.29	0.40	60.96	74.00	-13.04	P
* 4825.60	60.11	33.88	3.78	48.29	0.40	49.87	54.00	-4.13	A
N/A	-----	-----	-----	-----	-----	-----	-----	-----	P
N/A	-----	-----	-----	-----	-----	-----	-----	-----	A

TX / IEEE 802.11g mode / CH Low				Measurement Distance at 3m				Vertical polarity	
Freq.	Reading	AF	Cable Loss	Pre-amp	Filter	Level	Limit	Margin	Mark
(MHz)	(dBμV)	(dB/m)	(dB)	(dB)	(dB)	(dBμV/m)	(dBμV/m)	(dB)	(P/Q/A)
* 1584.22	57.62	27.42	2.06	48.65	0.30	38.75	74.00	-35.25	P
* 1584.22	52.16	27.42	2.06	48.65	0.30	33.29	54.00	-20.71	A
3215.95	54.72	30.69	3.03	47.27	0.30	41.46	74.00	-32.54	P
3215.95	45.49	30.69	3.03	47.27	0.30	32.23	54.00	-21.77	A
* 4823.20	66.49	33.87	3.78	48.29	0.40	56.25	74.00	-17.75	P
* 4823.20	56.10	33.87	3.78	48.29	0.40	45.86	54.00	-8.14	A
N/A	-----	-----	-----	-----	-----	-----	-----	-----	P
N/A	-----	-----	-----	-----	-----	-----	-----	-----	A

REMARK:

1. AF: Antenna Factor, Cable: Cable Loss, Pre-Amp: Preamplifier gain, Filter: 2.4GHz~2.5GHz Filter Insertion Loss
2. Spectrum analyzer setting P(Peak): RBW=1MHz, VBW=1MHz, A(Average): RBW=1MHz, VBW=10Hz
3. The result basic equation calculation is as follow:
Level = Reading + AF + Cable – Preamp + Filter , Margin = Level-Limit
4. The other emission levels were 20dB below the limit
5. The test limit distance is 3M limit.

Product Name	Enterprise Access Point	Test Date	2015/12/03
Model	ZA1002US-5	Test By	Ted Huang
Test Mode	IEEE 802.11g TX (CH Middle)	TEMP& Humidity	28.6 , 57%

TX / IEEE 802.11g mode / CH Middle				Measurement Distance at 3m				Horizontal polarity	
Freq.	Reading	AF	Cable Loss	Pre-amp	Filter	Level	Limit	Margin	Mark
(MHz)	(dBμV)	(dB/m)	(dB)	(dB)	(dB)	(dBμV/m)	(dBμV/m)	(dB)	(P/Q/A)
1936.02	60.44	30.03	2.29	48.17	0.30	44.89	74.00	-29.11	P
1936.02	56.76	30.03	2.29	48.17	0.30	41.20	54.00	-12.80	A
3249.29	55.16	30.70	3.04	47.30	0.30	41.91	74.00	-32.09	P
3249.29	45.94	30.70	3.04	47.30	0.30	32.68	54.00	-21.32	A
* 4873.93	71.26	34.02	3.80	48.29	0.40	61.18	74.00	-12.82	P
* 4873.93	60.33	34.02	3.80	48.29	0.40	50.25	54.00	-3.75	A
N/A	-----	-----	-----	-----	-----	-----	-----	-----	P
N/A	-----	-----	-----	-----	-----	-----	-----	-----	A

TX / IEEE 802.11g mode / CH Middle				Measurement Distance at 3m				Vertical polarity	
Freq.	Reading	AF	Cable Loss	Pre-amp	Filter	Level	Limit	Margin	Mark
(MHz)	(dBμV)	(dB/m)	(dB)	(dB)	(dB)	(dBμV/m)	(dBμV/m)	(dB)	(P/Q/A)
* 1584.02	56.39	27.42	2.06	48.65	0.30	37.52	74.00	-36.48	P
* 1584.02	48.97	27.42	2.06	48.65	0.30	30.10	54.00	-23.90	A
3249.18	54.97	30.70	3.04	47.30	0.30	41.71	74.00	-32.29	P
3249.18	46.38	30.70	3.04	47.30	0.30	33.12	54.00	-20.88	A
* 4874.68	65.84	34.02	3.80	48.29	0.40	55.77	74.00	-18.23	P
* 4874.68	55.83	34.02	3.80	48.29	0.40	45.76	54.00	-8.24	A
N/A	-----	-----	-----	-----	-----	-----	-----	-----	P
N/A	-----	-----	-----	-----	-----	-----	-----	-----	A

REMARK:

1. AF: Antenna Factor, Cable: Cable Loss, Pre-Amp: Preamplifier gain, Filter: 2.4GHz-2.5GHz Filter Insertion Loss
2. Spectrum analyzer setting P(Peak): RBW=1MHz, VBW=1MHz, A(Average): RBW=1MHz, VBW=10Hz
3. The result basic equation calculation is as follow:
Level = Reading + AF + Cable – Preamp + Filter , Margin = Level-Limit
4. The other emission levels were 20dB below the limit
5. The test limit distance is 3M limit.

Product Name	Enterprise Access Point	Test Date	2015/12/03
Model	ZA1002US-5	Test By	Ted Huang
Test Mode	IEEE 802.11g TX (CH High)	TEMP& Humidity	28.6 , 57%

TX / IEEE 802.11g mode / CH High				Measurement Distance at 3m				Horizontal polarity	
Freq.	Reading	AF	Cable Loss	Pre-amp	Filter	Level	Limit	Margin	Mark
(MHz)	(dBµV)	(dB/m)	(dB)	(dB)	(dB)	(dBµV/m)	(dBµV/m)	(dB)	(P/Q/A)
1935.98	59.87	30.03	2.29	48.17	0.30	44.31	74.00	-29.69	P
1935.98	56.17	30.03	2.29	48.17	0.30	40.62	54.00	-13.38	A
3282.69	54.63	30.71	3.06	47.33	0.30	41.37	74.00	-32.63	P
3282.69	46.58	30.71	3.06	47.33	0.30	33.33	54.00	-20.67	A
* 4924.22	71.52	34.17	3.82	48.30	0.40	61.61	74.00	-12.39	P
* 4924.22	61.28	34.17	3.82	48.30	0.40	51.37	54.00	-2.63	A
N/A	-----	-----	-----	-----	-----	-----	-----	-----	P
N/A	-----	-----	-----	-----	-----	-----	-----	-----	A

TX / IEEE 802.11g mode / CH High				Measurement Distance at 3m				Vertical polarity	
Freq.	Reading	AF	Cable Loss	Pre-amp	Filter	Level	Limit	Margin	Mark
(MHz)	(dBµV)	(dB/m)	(dB)	(dB)	(dB)	(dBµV/m)	(dBµV/m)	(dB)	(P/Q/A)
* 1583.94	57.59	27.42	2.06	48.65	0.30	38.72	74.00	-35.28	P
* 1583.94	51.82	27.42	2.06	48.65	0.30	32.95	54.00	-21.05	A
3282.63	55.22	30.71	3.06	47.33	0.30	41.97	74.00	-32.03	P
3282.63	45.78	30.71	3.06	47.33	0.30	32.52	54.00	-21.48	A
* 4923.68	66.25	34.17	3.82	48.30	0.40	56.34	74.00	-17.66	P
* 4923.68	56.34	34.17	3.82	48.30	0.40	46.43	54.00	-7.57	A
N/A	-----	-----	-----	-----	-----	-----	-----	-----	P
N/A	-----	-----	-----	-----	-----	-----	-----	-----	A

REMARK:

1. AF: Antenna Factor, Cable: Cable Loss, Pre-Amp: Preamplifier gain, Filter: 2.4GHz~2.5GHz Filter Insertion Loss
2. Spectrum analyzer setting P(Peak): RBW=1MHz, VBW=1MHz, A(Average): RBW=1MHz, VBW=10Hz
3. The result basic equation calculation is as follow:
Level = Reading + AF + Cable – Preamp + Filter , Margin = Level-Limit
4. The other emission levels were 20dB below the limit
5. The test limit distance is 3M limit.

Product Name	Enterprise Access Point	Test Date	2015/12/03
Model	ZA1002US-5	Test By	Ted Huang
Test Mode	IEEE 802.11n HT20 TX (CH Low)	TEMP& Humidity	28.6 , 57%

TX / IEEE 802.11n HT20 mode / CH Low				Measurement Distance at 3m				Horizontal polarity	
Freq.	Reading	AF	Cable Loss	Pre-amp	Filter	Level	Limit	Margin	Mark
(MHz)	(dBµV)	(dB/m)	(dB)	(dB)	(dB)	(dBµV/m)	(dBµV/m)	(dB)	(P/Q/A)
1935.96	60.66	30.03	2.29	48.17	0.30	45.11	74.00	-28.89	P
1935.96	56.71	30.03	2.29	48.17	0.30	41.16	54.00	-12.84	A
3215.96	55.35	30.69	3.03	47.27	0.30	42.09	74.00	-31.91	P
3215.96	46.64	30.69	3.03	47.27	0.30	33.38	54.00	-20.62	A
* 4823.96	70.21	33.87	3.78	48.29	0.40	59.96	74.00	-14.04	P
* 4823.96	59.64	33.87	3.78	48.29	0.40	49.39	54.00	-4.61	A
N/A	-----	-----	-----	-----	-----	-----	-----	-----	P
N/A	-----	-----	-----	-----	-----	-----	-----	-----	A

TX / IEEE 802.11n HT20 mode / CH Low				Measurement Distance at 3m				Vertical polarity	
Freq.	Reading	AF	Cable Loss	Pre-amp	Filter	Level	Limit	Margin	Mark
(MHz)	(dBµV)	(dB/m)	(dB)	(dB)	(dB)	(dBµV/m)	(dBµV/m)	(dB)	(P/Q/A)
* 1584.14	57.84	27.42	2.06	48.65	0.30	38.97	74.00	-35.03	P
* 1584.14	52.06	27.42	2.06	48.65	0.30	33.19	54.00	-20.81	A
3215.97	54.53	30.69	3.03	47.27	0.30	41.27	74.00	-32.73	P
3215.97	45.74	30.69	3.03	47.27	0.30	32.48	54.00	-21.52	A
* 4824.03	65.34	33.87	3.78	48.29	0.40	55.10	74.00	-18.90	P
* 4824.03	56.02	33.87	3.78	48.29	0.40	45.78	54.00	-8.22	A
N/A	-----	-----	-----	-----	-----	-----	-----	-----	P
N/A	-----	-----	-----	-----	-----	-----	-----	-----	A

REMARK:

1. AF: Antenna Factor, Cable: Cable Loss, Pre-Amp: Preamplifier gain, Filter: 2.4GHz-2.5GHz Filter Insertion Loss
2. Spectrum analyzer setting P(Peak): RBW=1MHz, VBW=1MHz, A(Average): RBW=1MHz, VBW=10Hz
3. The result basic equation calculation is as follow:
Level = Reading + AF + Cable – Preamp + Filter , Margin = Level-Limit
4. The other emission levels were 20dB below the limit
5. The test limit distance is 3M limit.

Product Name	Enterprise Access Point	Test Date	2015/12/03
Model	ZA1002US-5	Test By	Ted Huang
Test Mode	IEEE 802.11n HT20 TX (CH Middle)	TEMP& Humidity	28.6 , 57%

TX / IEEE 802.11n HT20 mode / CH Middle				Measurement Distance at 3m				Horizontal polarity	
Freq.	Reading	AF	Cable Loss	Pre-amp	Filter	Level	Limit	Margin	Mark
(MHz)	(dBμV)	(dB/m)	(dB)	(dB)	(dB)	(dBμV/m)	(dBμV/m)	(dB)	(P/Q/A)
1936.05	61.32	30.03	2.29	48.17	0.30	45.77	74.00	-28.23	P
1936.05	56.87	30.03	2.29	48.17	0.30	41.32	54.00	-12.68	A
3249.42	55.74	30.70	3.04	47.30	0.30	42.48	74.00	-31.52	P
3249.42	46.13	30.70	3.04	47.30	0.30	32.87	54.00	-21.13	A
* 4873.97	70.46	34.02	3.80	48.29	0.40	60.38	74.00	-13.62	P
* 4873.97	59.22	34.02	3.80	48.29	0.40	49.14	54.00	-4.86	A
N/A	-----	-----	-----	-----	-----	-----	-----	-----	P
N/A	-----	-----	-----	-----	-----	-----	-----	-----	A

TX / IEEE 802.11n HT20 mode / CH Middle				Measurement Distance at 3m				Vertical polarity	
Freq.	Reading	AF	Cable Loss	Pre-amp	Filter	Level	Limit	Margin	Mark
(MHz)	(dBμV)	(dB/m)	(dB)	(dB)	(dB)	(dBμV/m)	(dBμV/m)	(dB)	(P/Q/A)
* 1584.03	56.39	27.42	2.06	48.65	0.30	37.52	74.00	-36.48	P
* 1584.03	48.97	27.42	2.06	48.65	0.30	30.10	54.00	-23.90	A
3249.21	55.24	30.70	3.04	47.30	0.30	41.99	74.00	-32.01	P
3249.21	46.57	30.70	3.04	47.30	0.30	33.31	54.00	-20.69	A
* 4874.45	64.83	34.02	3.80	48.29	0.40	54.76	74.00	-19.24	P
* 4874.45	55.34	34.02	3.80	48.29	0.40	45.27	54.00	-8.73	A
N/A	-----	-----	-----	-----	-----	-----	-----	-----	P
N/A	-----	-----	-----	-----	-----	-----	-----	-----	A

REMARK:

1. AF: Antenna Factor, Cable: Cable Loss, Pre-Amp: Preamplifier gain, Filter: 2.4GHz~2.5GHz Filter Insertion Loss
2. Spectrum analyzer setting P(Peak): RBW=1MHz, VBW=1MHz, A(Average): RBW=1MHz, VBW=10Hz
3. The result basic equation calculation is as follow:
Level = Reading + AF + Cable – Preamp + Filter , Margin = Level-Limit
4. The other emission levels were 20dB below the limit
5. The test limit distance is 3M limit.

Product Name	Enterprise Access Point	Test Date	2015/12/03
Model	ZA1002US-5	Test By	Ted Huang
Test Mode	IEEE 802.11n HT20 TX (CH High)	TEMP& Humidity	28.6 , 57%

TX / IEEE 802.11n HT20 mode / CH High				Measurement Distance at 3m				Horizontal polarity		
Freq.	Reading	AF	Cable Loss	Pre-amp	Filter	Level	Limit	Margin	Mark	
(MHz)	(dBµV)	(dB/m)	(dB)	(dB)	(dB)	(dBµV/m)	(dBµV/m)	(dB)	(P/Q/A)	
1935.76	59.87	30.02	2.29	48.17	0.30	44.31	74.00	-29.69	P	
1935.76	56.34	30.02	2.29	48.17	0.30	40.78	54.00	-13.22	A	
3282.83	54.86	30.71	3.06	47.33	0.30	41.61	74.00	-32.39	P	
3282.83	46.75	30.71	3.06	47.33	0.30	33.49	54.00	-20.51	A	
* 4924.14	69.52	34.17	3.82	48.30	0.40	59.61	74.00	-14.39	P	
* 4924.14	58.68	34.17	3.82	48.30	0.40	48.77	54.00	-5.23	A	
N/A	-----	-----	-----	-----	-----	-----	-----	-----	P	
N/A	-----	-----	-----	-----	-----	-----	-----	-----	A	

TX / IEEE 802.11n HT20 mode / CH High				Measurement Distance at 3m				Vertical polarity		
Freq.	Reading	AF	Cable Loss	Pre-amp	Filter	Level	Limit	Margin	Mark	
(MHz)	(dBµV)	(dB/m)	(dB)	(dB)	(dB)	(dBµV/m)	(dBµV/m)	(dB)	(P/Q/A)	
* 1583.97	57.37	27.42	2.06	48.65	0.30	38.50	74.00	-35.50	P	
* 1583.97	51.76	27.42	2.06	48.65	0.30	32.89	54.00	-21.11	A	
3282.58	55.58	30.71	3.06	47.33	0.30	42.33	74.00	-31.67	P	
3282.58	45.96	30.71	3.06	47.33	0.30	32.71	54.00	-21.29	A	
* 4923.76	64.85	34.17	3.82	48.30	0.40	54.94	74.00	-19.06	P	
* 4923.76	55.23	34.17	3.82	48.30	0.40	45.32	54.00	-8.68	A	
N/A	-----	-----	-----	-----	-----	-----	-----	-----	P	
N/A	-----	-----	-----	-----	-----	-----	-----	-----	A	

REMARK:

1. AF: Antenna Factor, Cable: Cable Loss, Pre-Amp: Preamplifier gain, Filter: 2.4GHz-2.5GHz Filter Insertion Loss
2. Spectrum analyzer setting P(Peak): RBW=1MHz, VBW=1MHz, A(Average): RBW=1MHz, VBW=10Hz
3. The result basic equation calculation is as follow:
Level = Reading + AF + Cable – Preamp + Filter , Margin = Level-Limit
4. The other emission levels were 20dB below the limit
5. The test limit distance is 3M limit.

Product Name	Enterprise Access Point	Test Date	2015/12/03
Model	ZA1002US-5	Test By	Ted Huang
Test Mode	IEEE 802.11n HT40 TX (CH Low)	TEMP& Humidity	28.6 , 57%

TX / IEEE 802.11n HT40 mode / CH Low				Measurement Distance at 3m				Horizontal polarity	
Freq.	Reading	AF	Cable Loss	Pre-amp	Filter	Level	Limit	Margin	Mark
(MHz)	(dBµV)	(dB/m)	(dB)	(dB)	(dB)	(dBµV/m)	(dBµV/m)	(dB)	(P/Q/A)
1935.99	60.46	30.03	2.29	48.17	0.30	44.91	74.00	-29.09	P
1935.99	56.11	30.03	2.29	48.17	0.30	40.56	54.00	-13.44	A
3242.69	55.59	30.70	3.04	47.29	0.30	42.33	74.00	-31.67	P
3242.69	47.91	30.70	3.04	47.29	0.30	34.65	54.00	-19.35	A
* 4843.26	67.48	33.93	3.78	48.29	0.40	57.30	74.00	-16.70	P
* 4843.26	57.86	33.93	3.78	48.29	0.40	47.68	54.00	-6.32	A
N/A	-----	-----	-----	-----	-----	-----	-----	-----	P
N/A	-----	-----	-----	-----	-----	-----	-----	-----	A

TX / IEEE 802.11n HT40 mode / CH Low				Measurement Distance at 3m				Vertical polarity	
Freq.	Reading	AF	Cable Loss	Pre-amp	Filter	Level	Limit	Margin	Mark
(MHz)	(dBµV)	(dB/m)	(dB)	(dB)	(dB)	(dBµV/m)	(dBµV/m)	(dB)	(P/Q/A)
* 1583.99	57.91	27.42	2.06	48.65	0.30	39.04	74.00	-34.96	P
* 1583.99	51.71	27.42	2.06	48.65	0.30	32.84	54.00	-21.16	A
3242.61	55.88	30.70	3.04	47.29	0.30	42.62	74.00	-31.38	P
3242.61	46.93	30.70	3.04	47.29	0.30	33.67	54.00	-20.33	A
* 4844.17	63.64	33.93	3.78	48.29	0.40	53.46	74.00	-20.54	P
* 4844.17	54.34	33.93	3.78	48.29	0.40	44.16	54.00	-9.84	A
N/A	-----	-----	-----	-----	-----	-----	-----	-----	P
N/A	-----	-----	-----	-----	-----	-----	-----	-----	A

REMARK:

1. AF: Antenna Factor, Cable: Cable Loss, Pre-Amp: Preamplifier gain, Filter: 2.4GHz-2.5GHz Filter Insertion Loss
2. Spectrum analyzer setting P(Peak): RBW=1MHz, VBW=1MHz, A(Average): RBW=1MHz, VBW=10Hz
3. The result basic equation calculation is as follow:
Level = Reading + AF + Cable – Preamp + Filter , Margin = Level-Limit
4. The other emission levels were 20dB below the limit
5. The test limit distance is 3M limit.

Product Name	Enterprise Access Point	Test Date	2015/12/03
Model	ZA1002US-5	Test By	Ted Huang
Test Mode	IEEE 802.11n HT40 TX (CH Middle)	TEMP& Humidity	28.6 , 57%

TX / IEEE 802.11n HT40 mode / CH Middle				Measurement Distance at 3m				Horizontal polarity		
Freq.	Reading	AF	Cable Loss	Pre-amp	Filter	Level	Limit	Margin	Mark	
(MHz)	(dBμV)	(dB/m)	(dB)	(dB)	(dB)	(dBμV/m)	(dBμV/m)	(dB)	(P/Q/A)	
1935.96	61.40	30.03	2.29	48.17	0.30	45.85	74.00	-28.15	P	
1935.96	57.59	30.03	2.29	48.17	0.30	42.04	54.00	-11.96	A	
* 3262.55	55.52	30.71	3.05	47.31	0.30	42.26	74.00	-31.74	P	
* 3262.55	47.07	30.71	3.05	47.31	0.30	33.82	54.00	-20.18	A	
* 4873.85	65.41	34.02	3.80	48.29	0.40	55.33	74.00	-18.67	P	
* 4873.85	56.98	34.02	3.80	48.29	0.40	46.91	54.00	-7.09	A	
N/A	-----	-----	-----	-----	-----	-----	-----	-----	P	
N/A	-----	-----	-----	-----	-----	-----	-----	-----	A	

TX / IEEE 802.11n HT40 mode / CH Middle				Measurement Distance at 3m				Vertical polarity		
Freq.	Reading	AF	Cable Loss	Pre-amp	Filter	Level	Limit	Margin	Mark	
(MHz)	(dBμV)	(dB/m)	(dB)	(dB)	(dB)	(dBμV/m)	(dBμV/m)	(dB)	(P/Q/A)	
* 1584.06	56.82	27.42	2.06	48.65	0.30	37.95	74.00	-36.05	P	
* 1584.06	51.74	27.42	2.06	48.65	0.30	32.87	54.00	-21.13	A	
* 3262.59	55.28	30.71	3.05	47.31	0.30	42.03	74.00	-31.97	P	
* 3262.59	46.58	30.71	3.05	47.31	0.30	33.33	54.00	-20.67	A	
* 4874.86	63.58	34.02	3.80	48.29	0.40	53.51	74.00	-20.49	P	
* 4874.86	54.33	34.02	3.80	48.29	0.40	44.25	54.00	-9.75	A	
N/A	-----	-----	-----	-----	-----	-----	-----	-----	P	
N/A	-----	-----	-----	-----	-----	-----	-----	-----	A	

REMARK:

1. AF: Antenna Factor, Cable: Cable Loss, Pre-Amp: Preamplifier gain, Filter: 2.4GHz-2.5GHz Filter Insertion Loss
2. Spectrum analyzer setting P(Peak): RBW=1MHz, VBW=1MHz, A(Average): RBW=1MHz, VBW=10Hz
3. The result basic equation calculation is as follow:
Level = Reading + AF + Cable – Preamp + Filter , Margin = Level-Limit
4. The other emission levels were 20dB below the limit
5. The test limit distance is 3M limit.

Product Name	Enterprise Access Point	Test Date	2015/12/03
Model	ZA1002US-5	Test By	Ted Huang
Test Mode	IEEE 802.11n HT40 TX (CH High)	TEMP& Humidity	28.6 , 57%

TX / IEEE 802.11n HT40 mode / CH High				Measurement Distance at 3m				Horizontal polarity	
Freq.	Reading	AF	Cable Loss	Pre-amp	Filter	Level	Limit	Margin	Mark
(MHz)	(dBµV)	(dB/m)	(dB)	(dB)	(dB)	(dBµV/m)	(dBµV/m)	(dB)	(P/Q/A)
1935.98	60.26	30.03	2.29	48.17	0.30	44.70	74.00	-29.30	P
1935.98	56.36	30.03	2.29	48.17	0.30	40.80	54.00	-13.20	A
3282.61	55.82	30.71	3.06	47.33	0.30	42.57	74.00	-31.43	P
3282.61	46.64	30.71	3.06	47.33	0.30	33.39	54.00	-20.61	A
* 4904.49	67.65	34.11	3.81	48.30	0.40	57.68	74.00	-16.32	P
* 4904.49	56.48	34.11	3.81	48.30	0.40	46.51	54.00	-7.49	A
N/A	-----	-----	-----	-----	-----	-----	-----	-----	P
N/A	-----	-----	-----	-----	-----	-----	-----	-----	A

TX / IEEE 802.11n HT40 mode / CH High				Measurement Distance at 3m				Vertical polarity	
Freq.	Reading	AF	Cable Loss	Pre-amp	Filter	Level	Limit	Margin	Mark
(MHz)	(dBµV)	(dB/m)	(dB)	(dB)	(dB)	(dBµV/m)	(dBµV/m)	(dB)	(P/Q/A)
* 1583.95	57.39	27.42	2.06	48.65	0.30	38.52	74.00	-35.48	P
* 1583.95	51.10	27.42	2.06	48.65	0.30	32.23	54.00	-21.77	A
3282.64	55.21	30.71	3.06	47.33	0.30	41.96	74.00	-32.04	P
3282.64	46.53	30.71	3.06	47.33	0.30	33.28	54.00	-20.72	A
* 4903.73	63.44	34.11	3.81	48.30	0.40	53.47	74.00	-20.53	P
* 4903.73	54.06	34.11	3.81	48.30	0.40	44.08	54.00	-9.92	A
N/A	-----	-----	-----	-----	-----	-----	-----	-----	P
N/A	-----	-----	-----	-----	-----	-----	-----	-----	A

REMARK:

1. AF: Antenna Factor, Cable: Cable Loss, Pre-Amp: Preamplifier gain, Filter: 2.4GHz-2.5GHz Filter Insertion Loss
2. Spectrum analyzer setting P(Peak): RBW=1MHz, VBW=1MHz, A(Average): RBW=1MHz, VBW=10Hz
3. The result basic equation calculation is as follow:
Level = Reading + AF + Cable – Preamp + Filter , Margin = Level-Limit
4. The other emission levels were 20dB below the limit
5. The test limit distance is 3M limit.

8.6.4 RESTRICTED BAND EDGES

Model Name	ZA1002US-5	Test By	Ted Huang
Temp & Humidity	28.6°C, 57%	Test Date	2015/12/03

Detector mode : Peak

Polarity : Horizontal

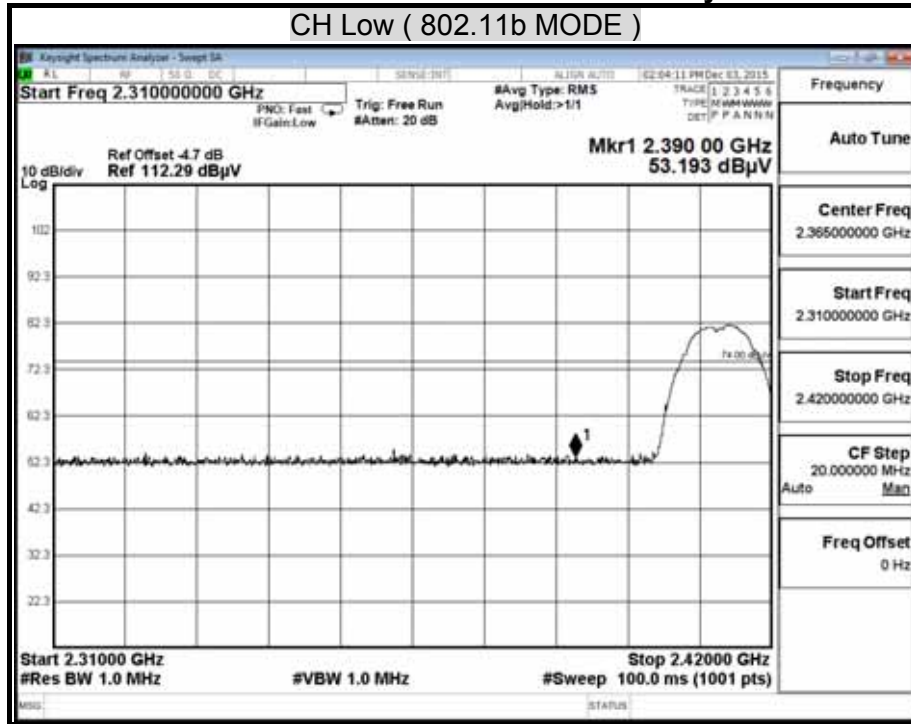

Detector mode : Average

Polarity : Horizontal

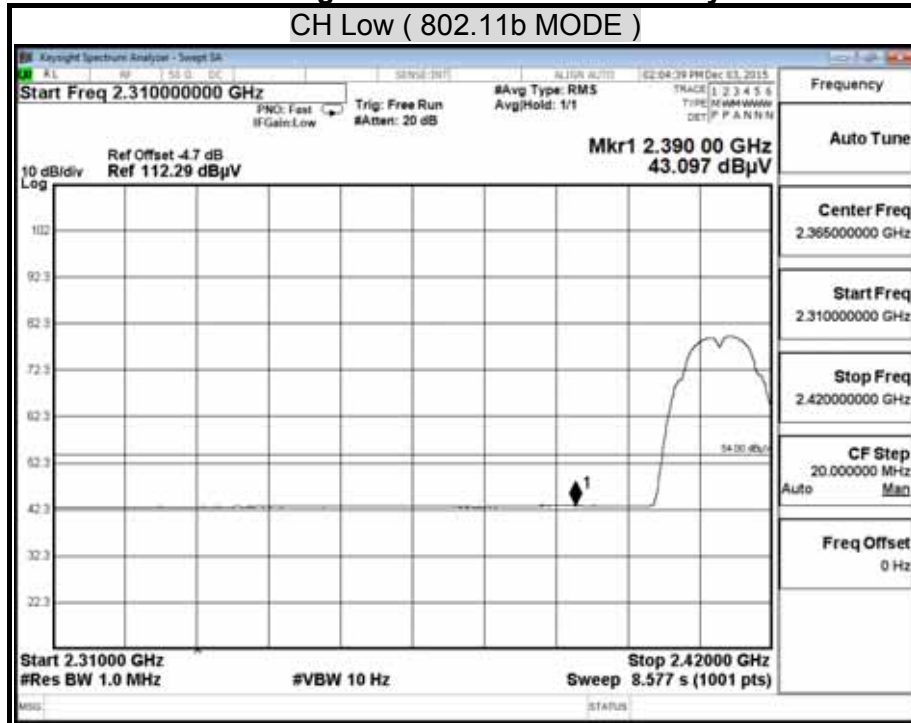

Detector mode : Peak

Polarity : Vertical

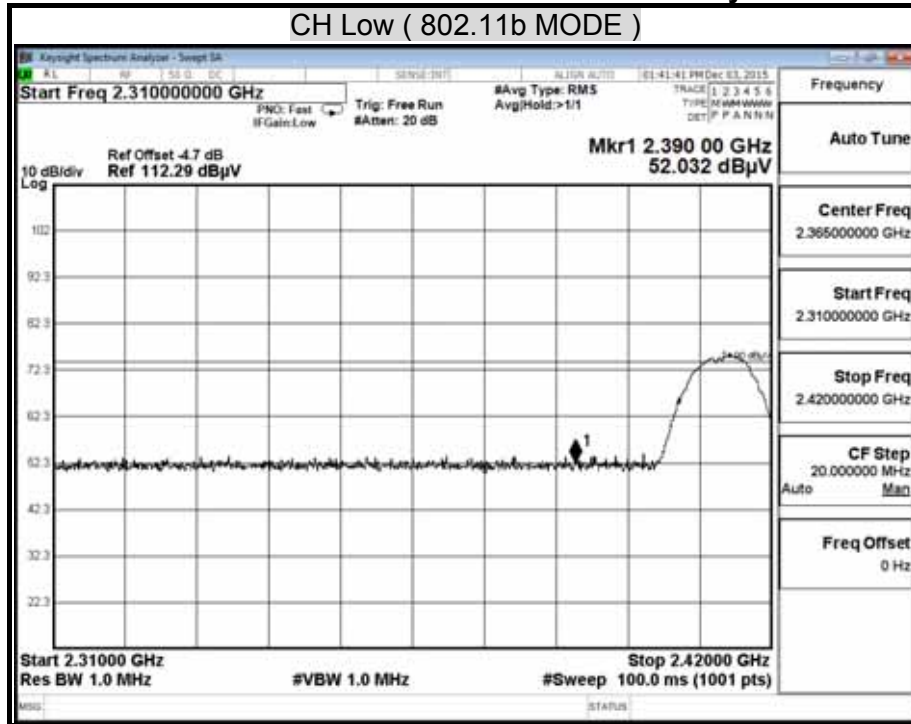

Detector mode : Average

Polarity : Vertical

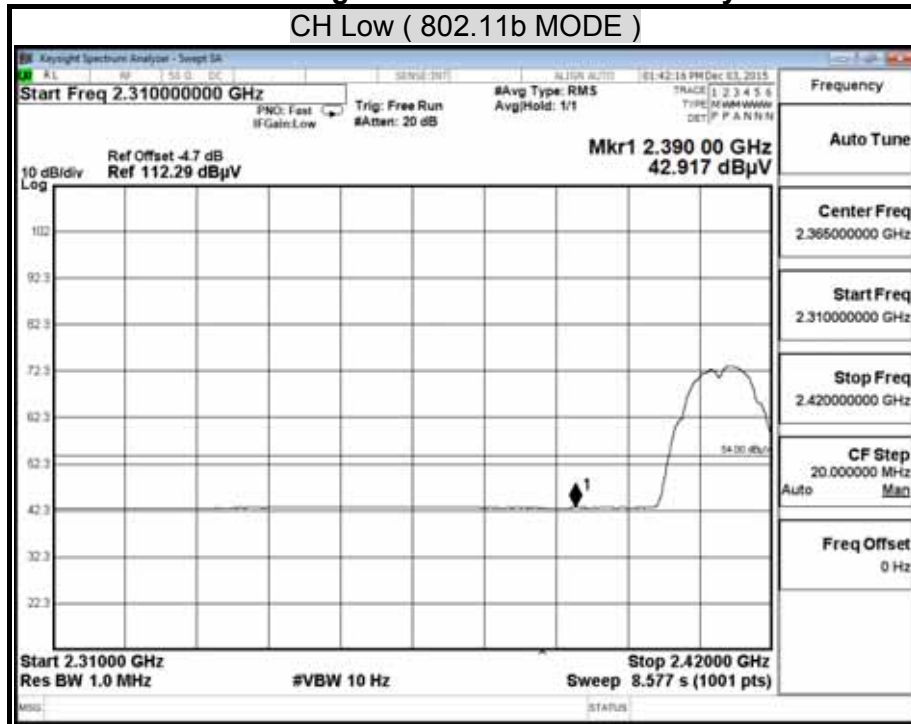

Detector mode : Peak

Polarity : Horizontal

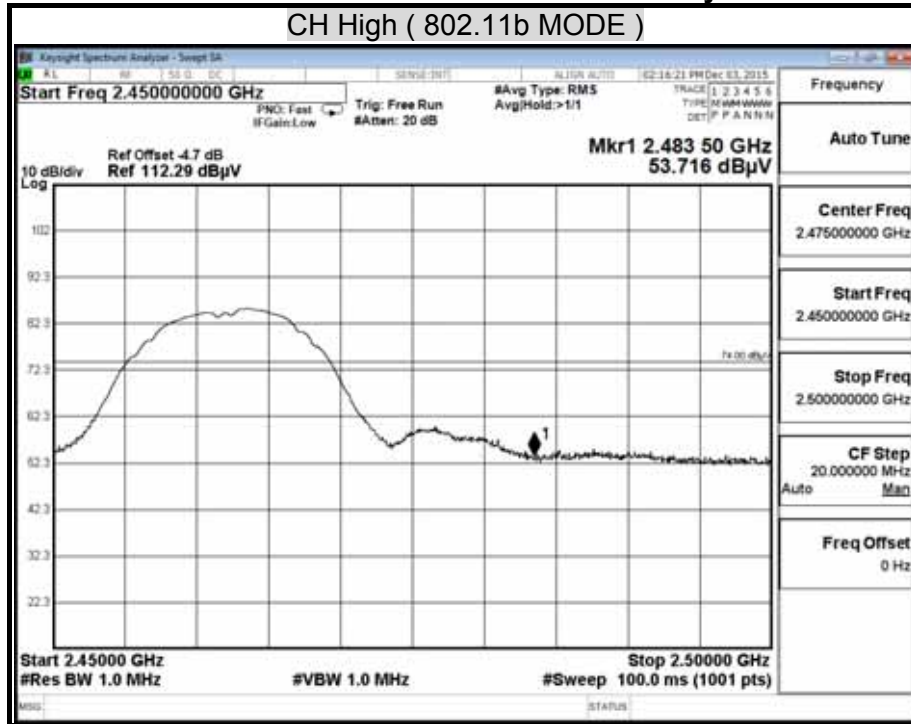

Detector mode : Average

Polarity : Horizontal

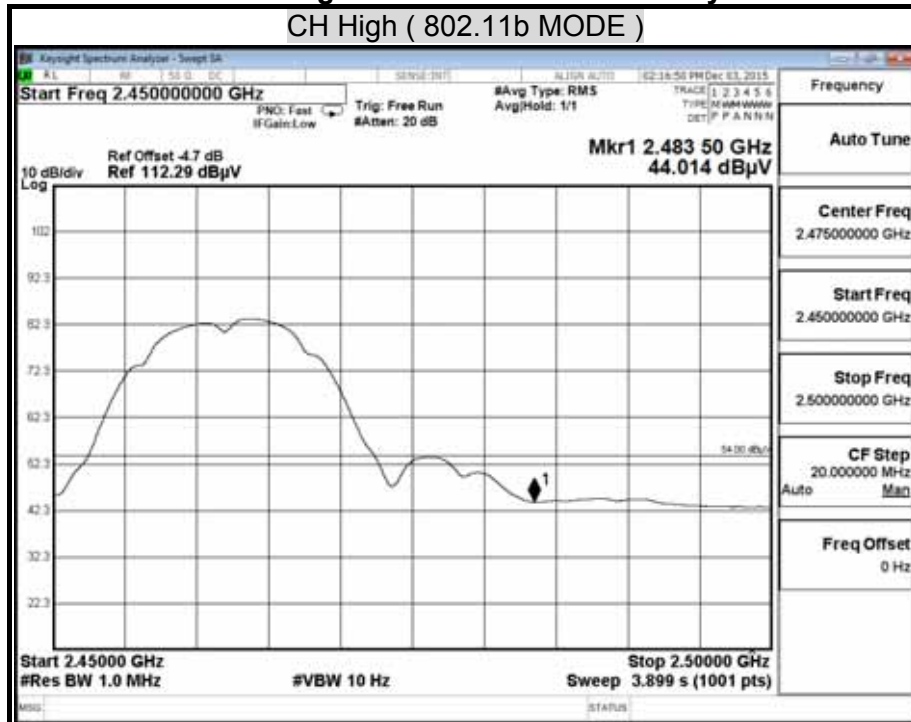

Detector mode : Peak

Polarity : Vertical

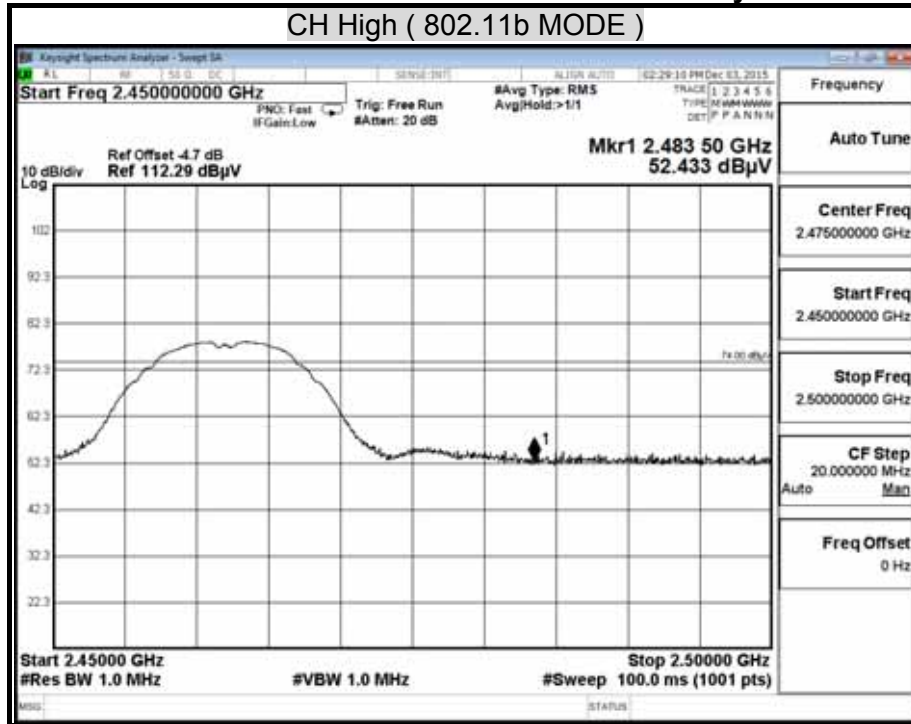

Detector mode : Average

Polarity : Vertical

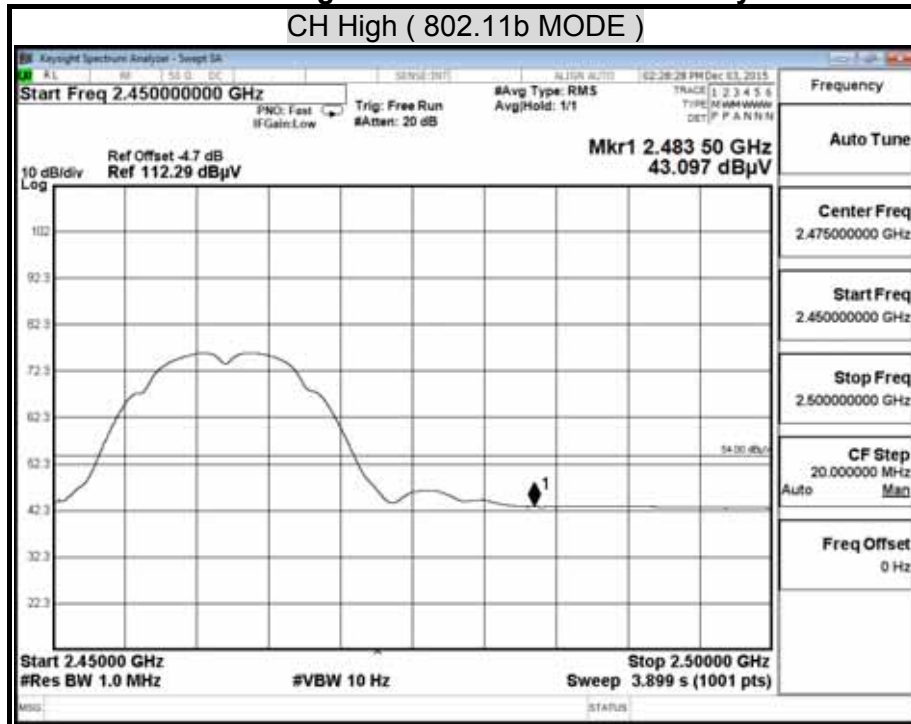

Detector mode : Peak

Polarity : Horizontal

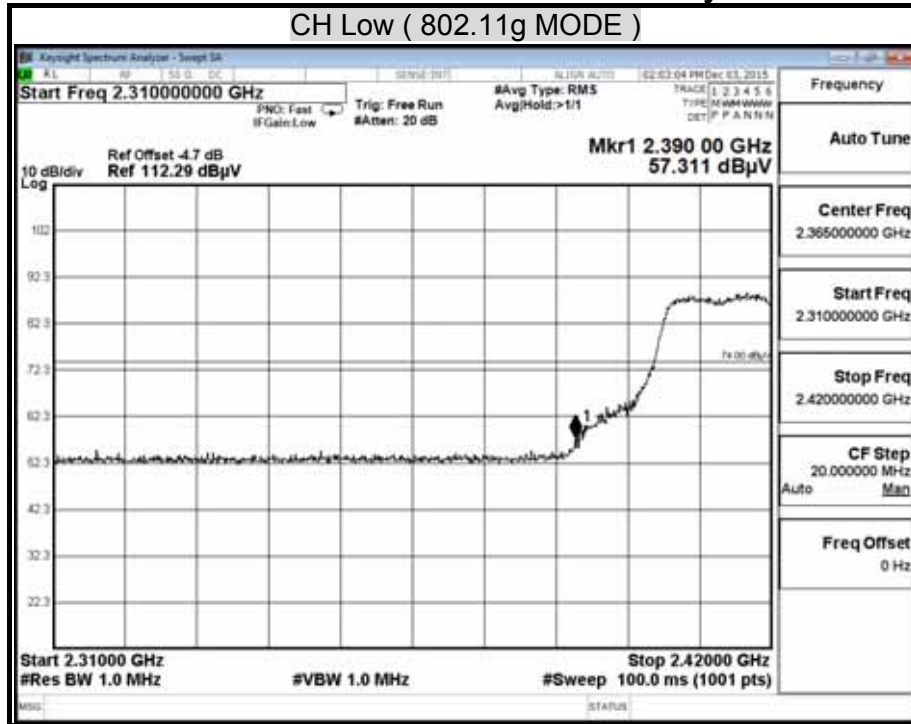

Detector mode : Average

Polarity : Horizontal

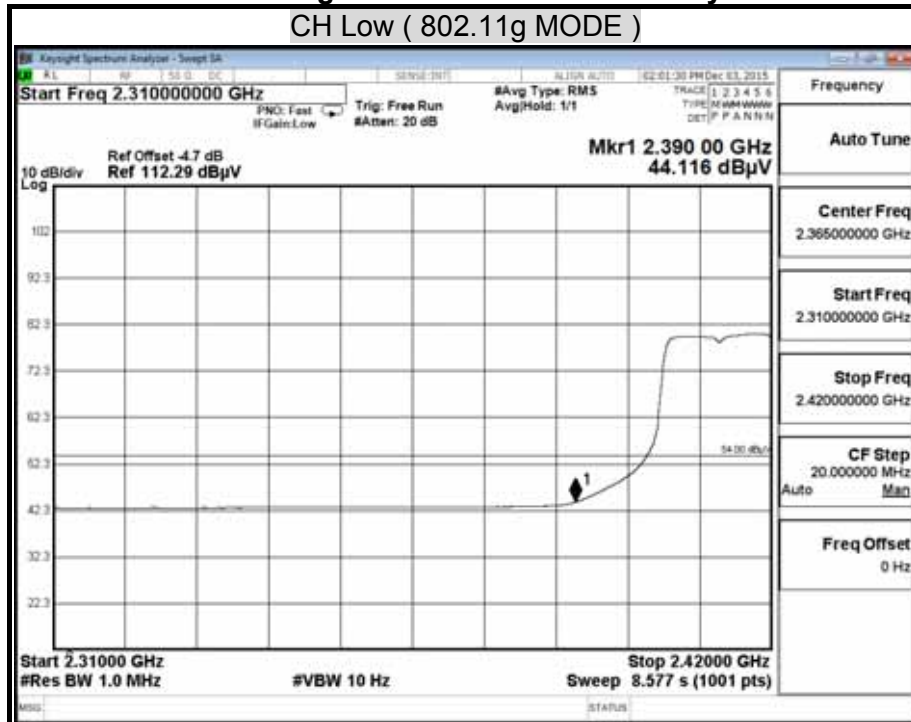

Detector mode : Peak

Polarity : Vertical

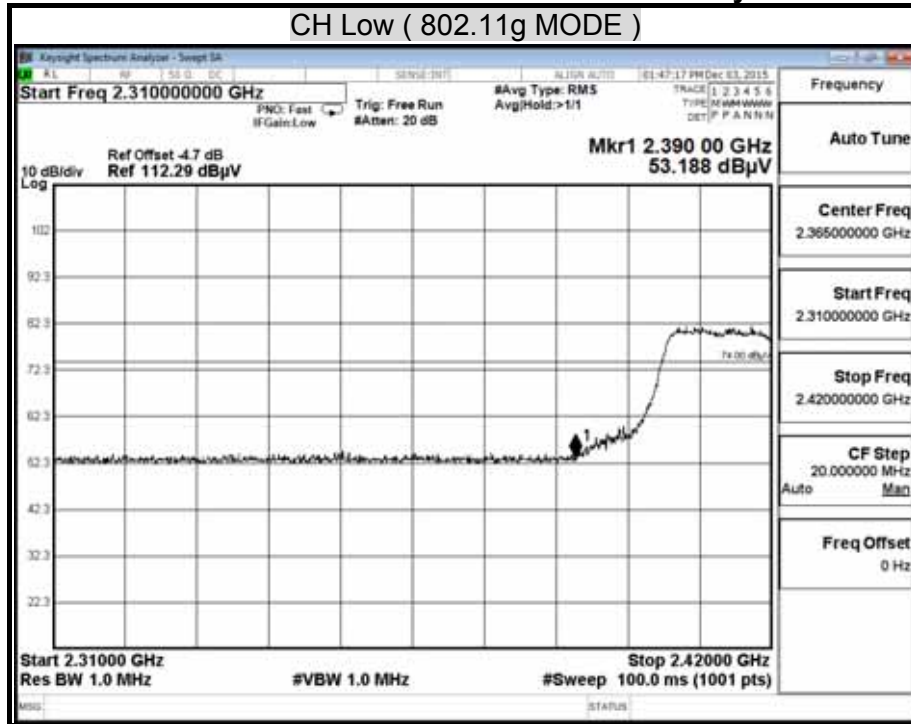

Detector mode : Average

Polarity : Vertical

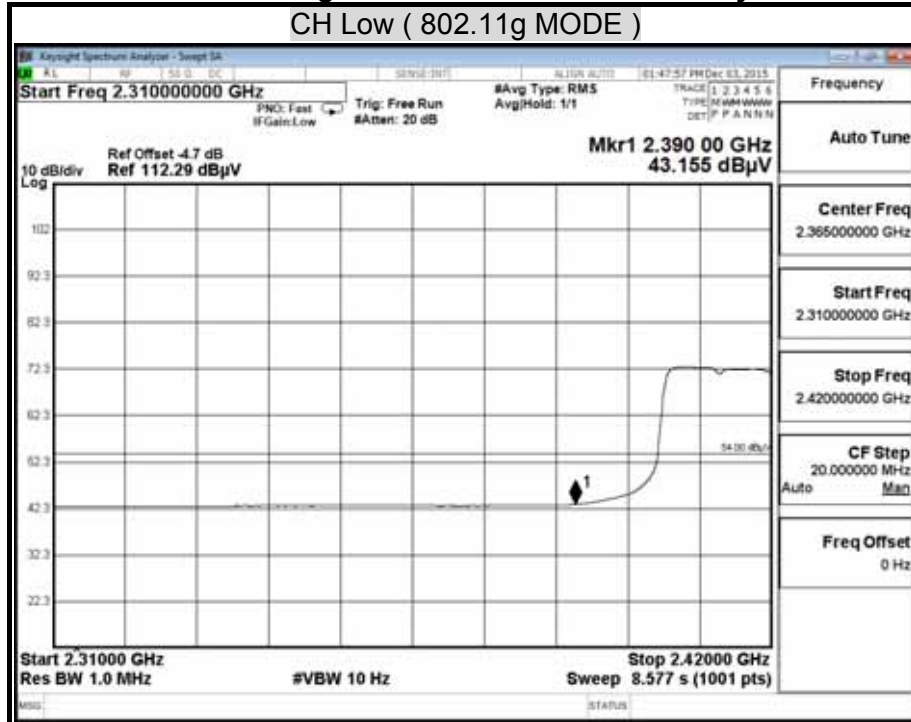

Detector mode : Peak

Polarity : Horizontal

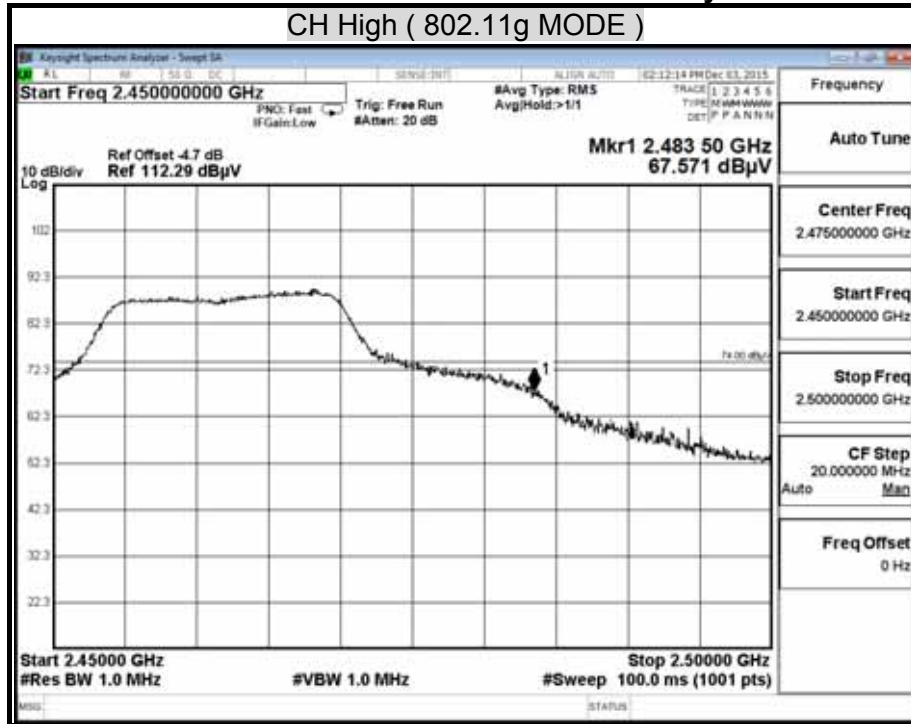

Detector mode : Average

Polarity : Horizontal

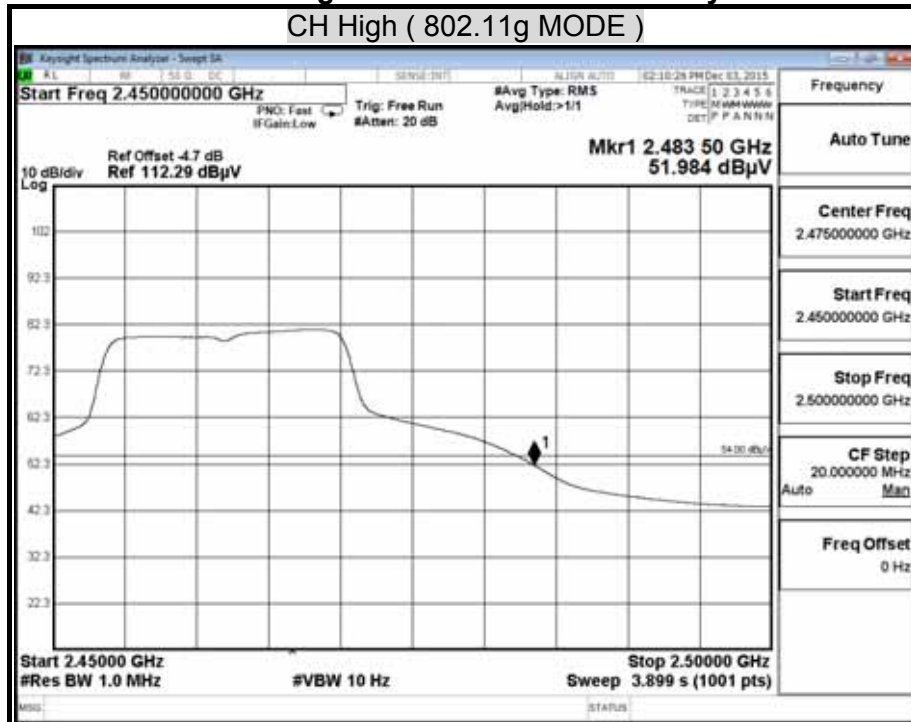

Detector mode : Peak

Polarity : Vertical

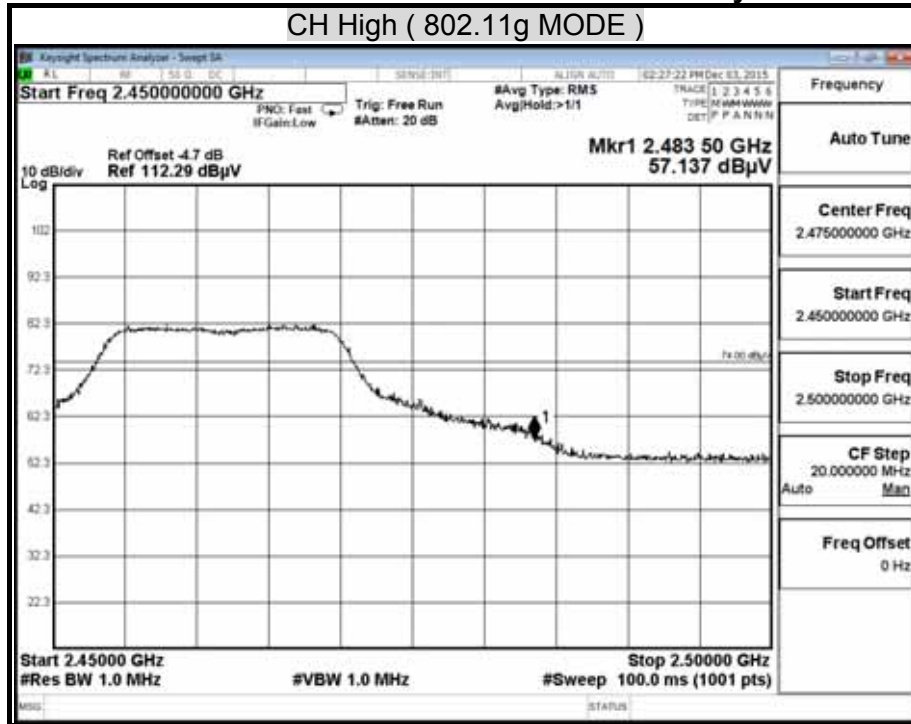

Detector mode : Average

Polarity : Vertical

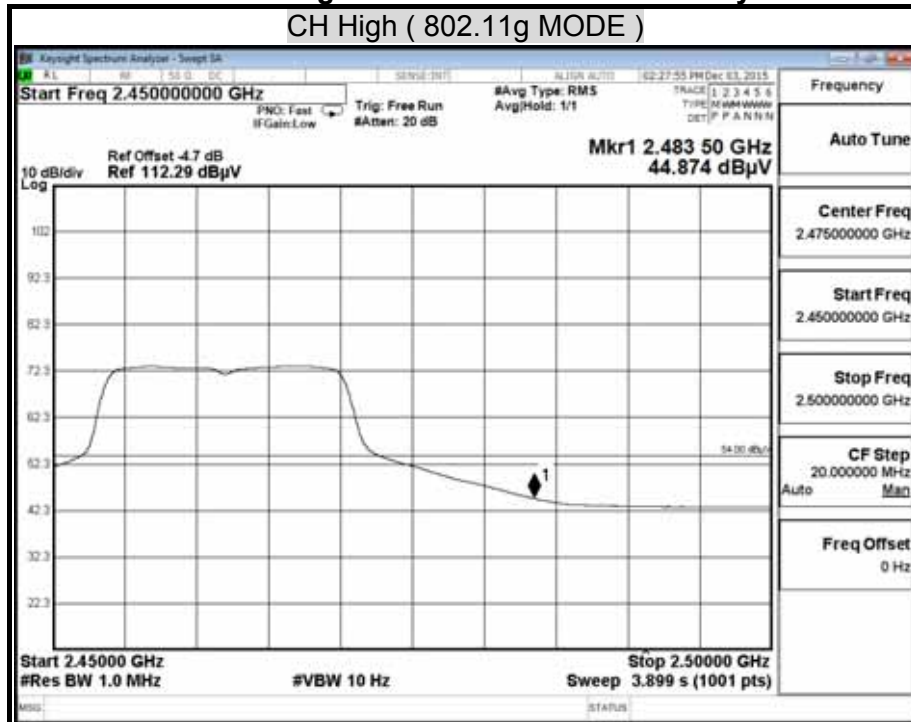

Detector mode : Peak

Polarity : Horizontal

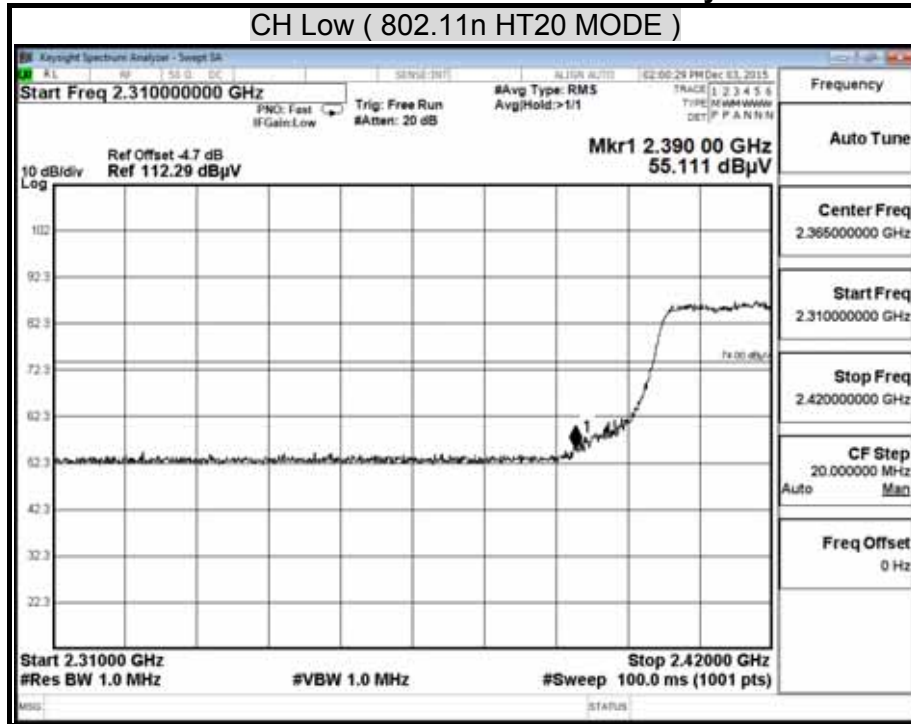

Detector mode : Average

Polarity : Horizontal

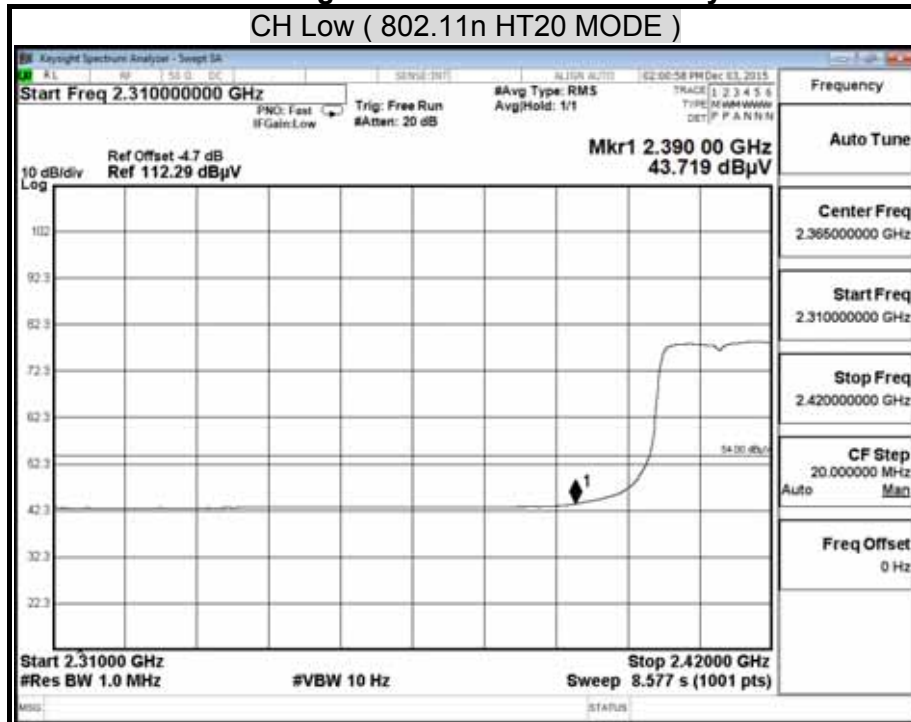

Detector mode : Peak

Polarity : Vertical

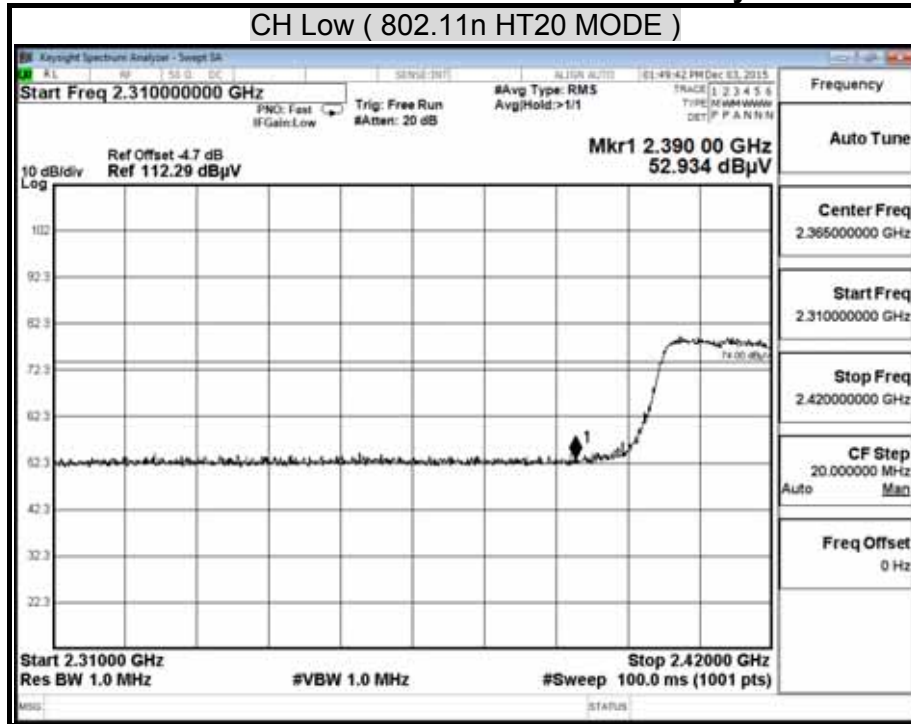

Detector mode : Average

Polarity : Vertical

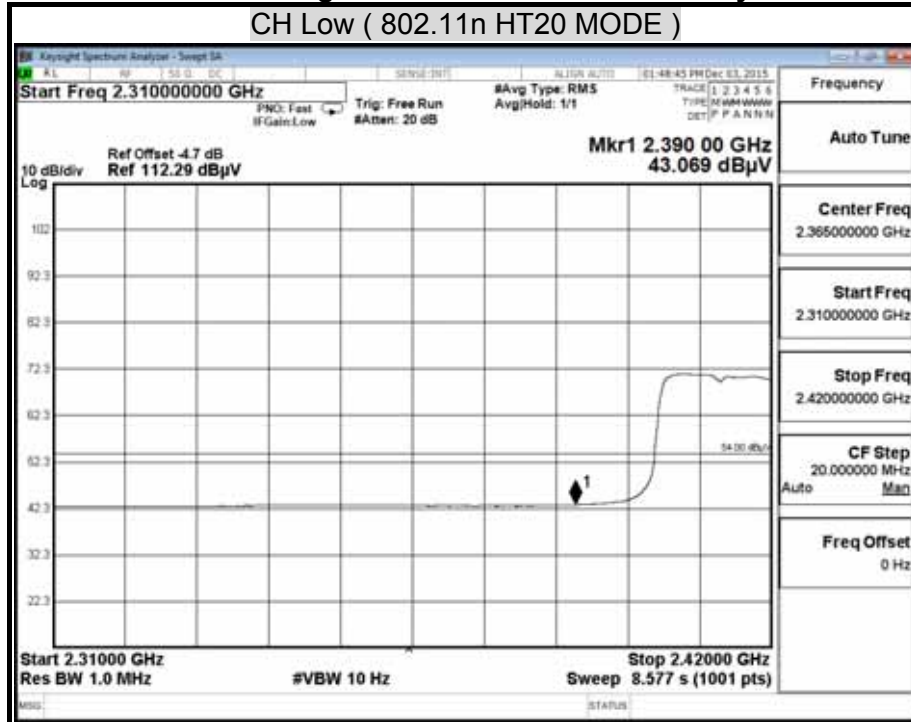

Detector mode : Peak

Polarity : Horizontal

CH High (802.11n HT20 MODE)

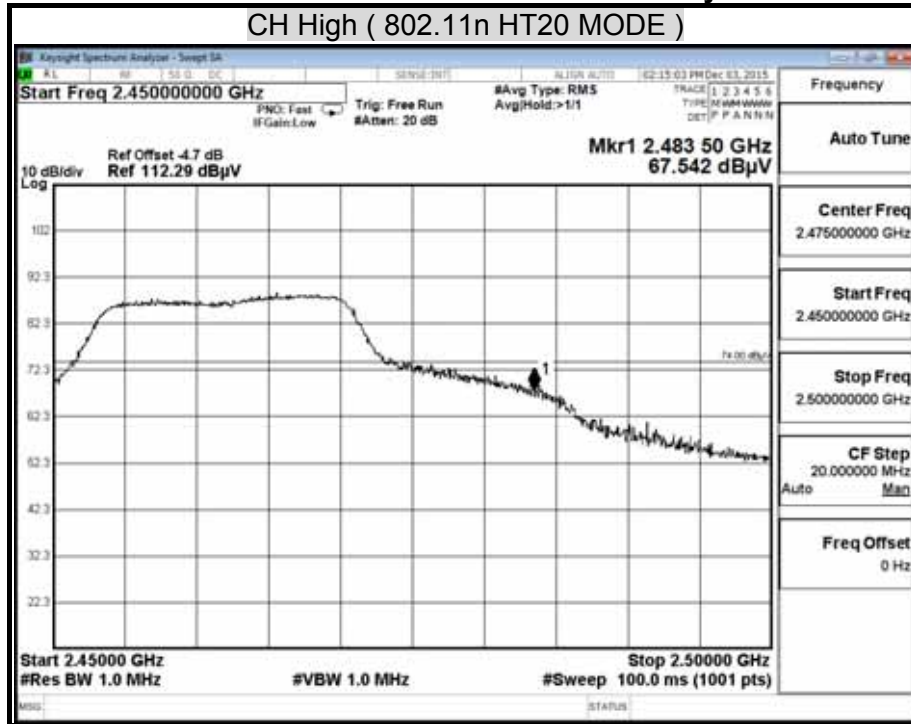

Detector mode : Average

Polarity : Horizontal

CH High (802.11n HT20 MODE)

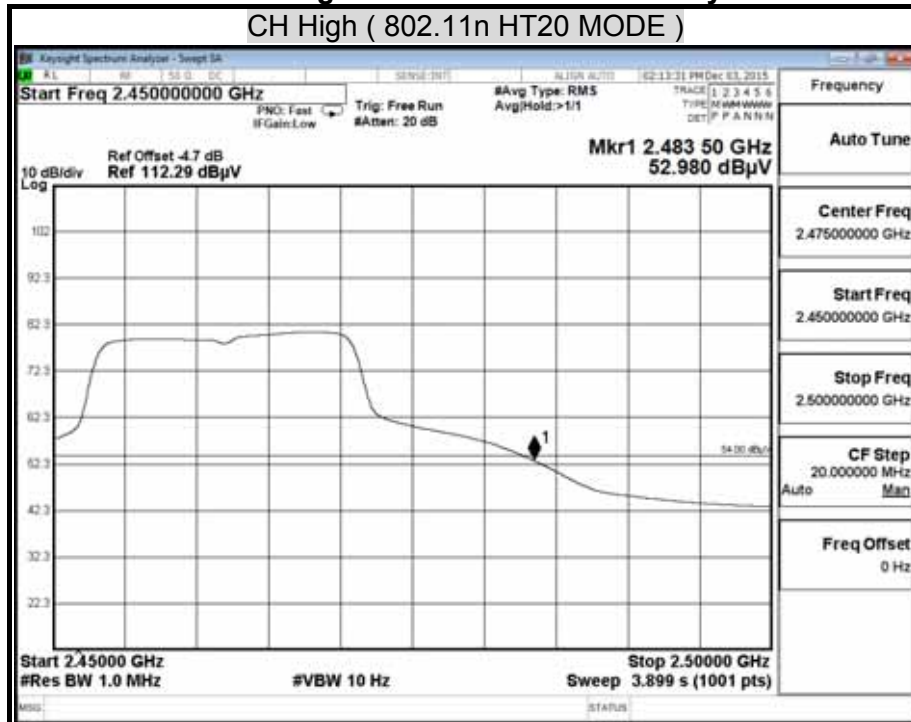

Detector mode : Peak

Polarity : Vertical

CH High (802.11n HT20 MODE)

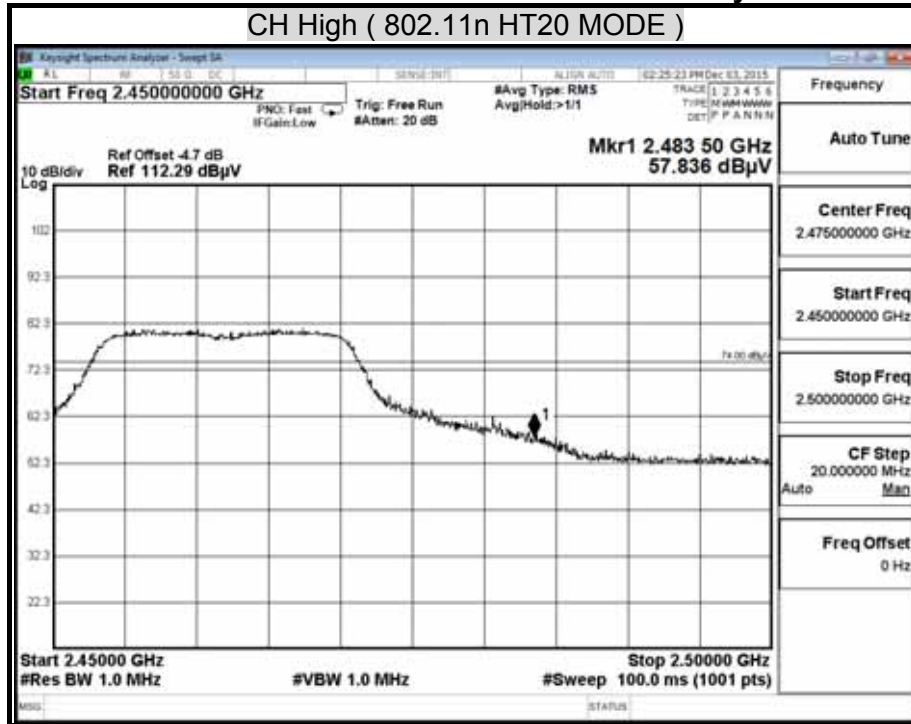

Detector mode : Average

Polarity : Vertical

CH High (802.11n HT20 MODE)

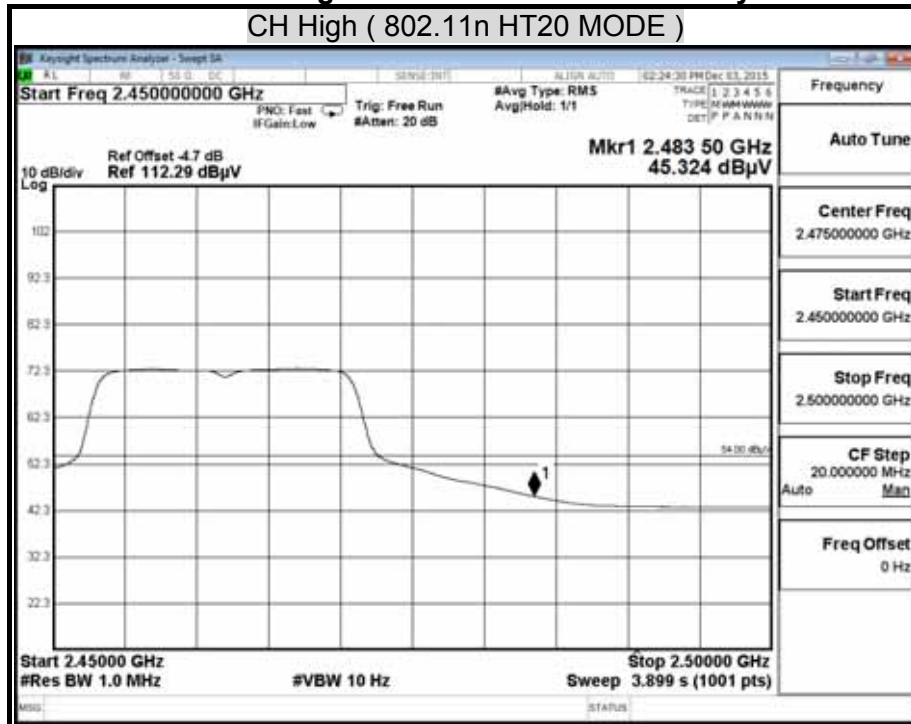

Detector mode : Peak

Polarity : Horizontal

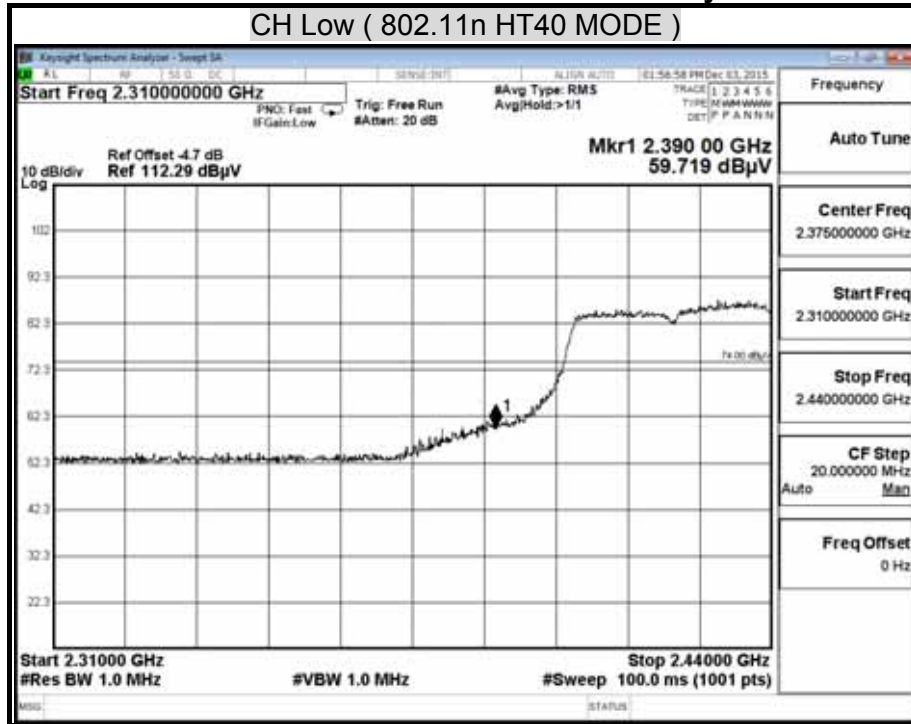

Detector mode : Average

Polarity : Horizontal

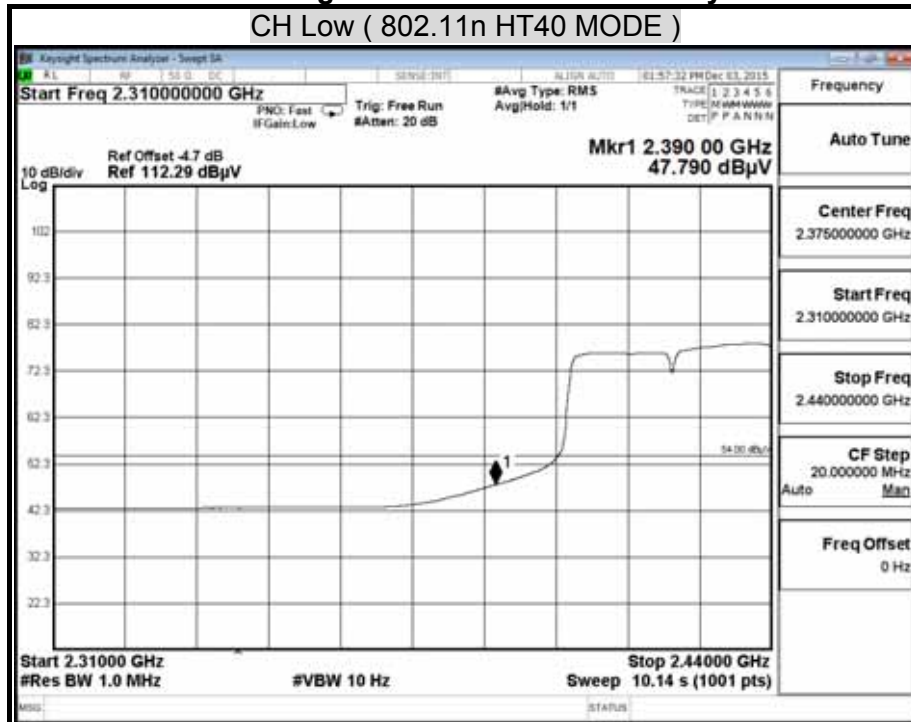

Detector mode : Peak

Polarity : Vertical

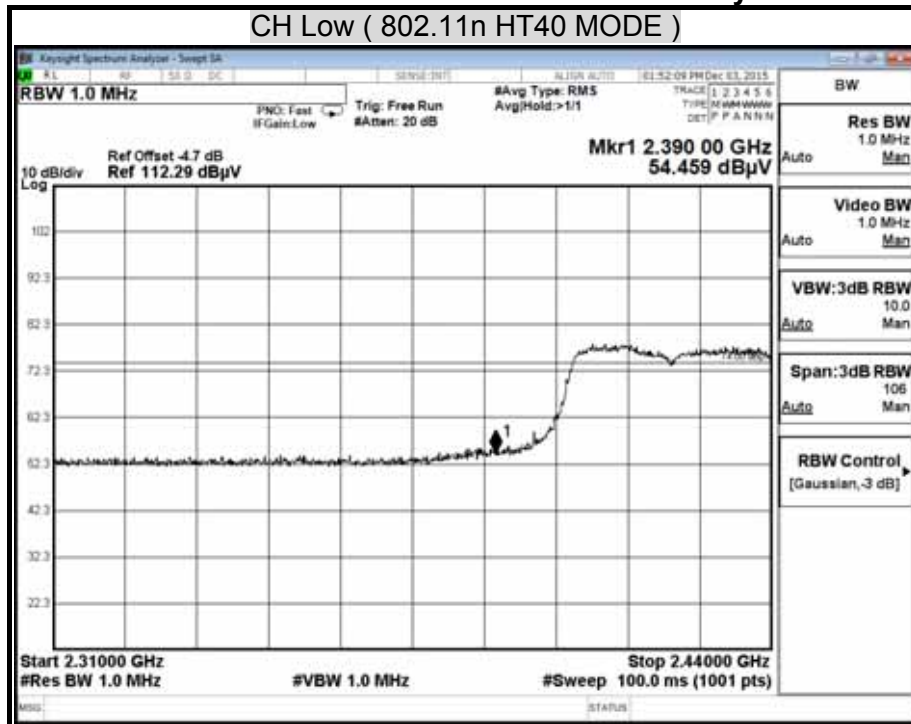

Detector mode : Average

Polarity : Vertical

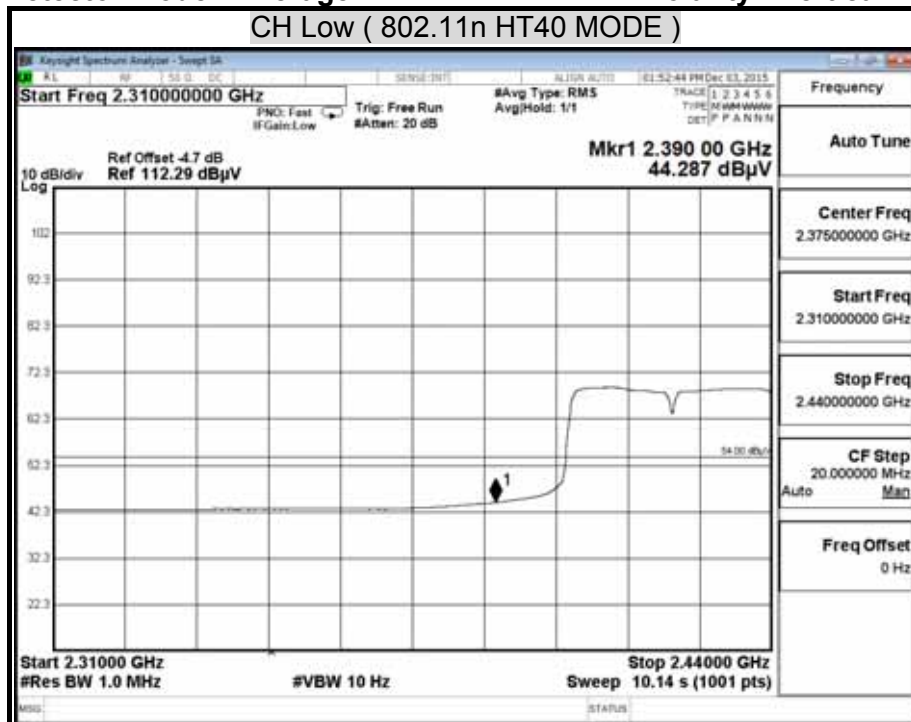

Detector mode : Peak

Polarity : Horizontal

CH High (802.11n HT40 MODE)

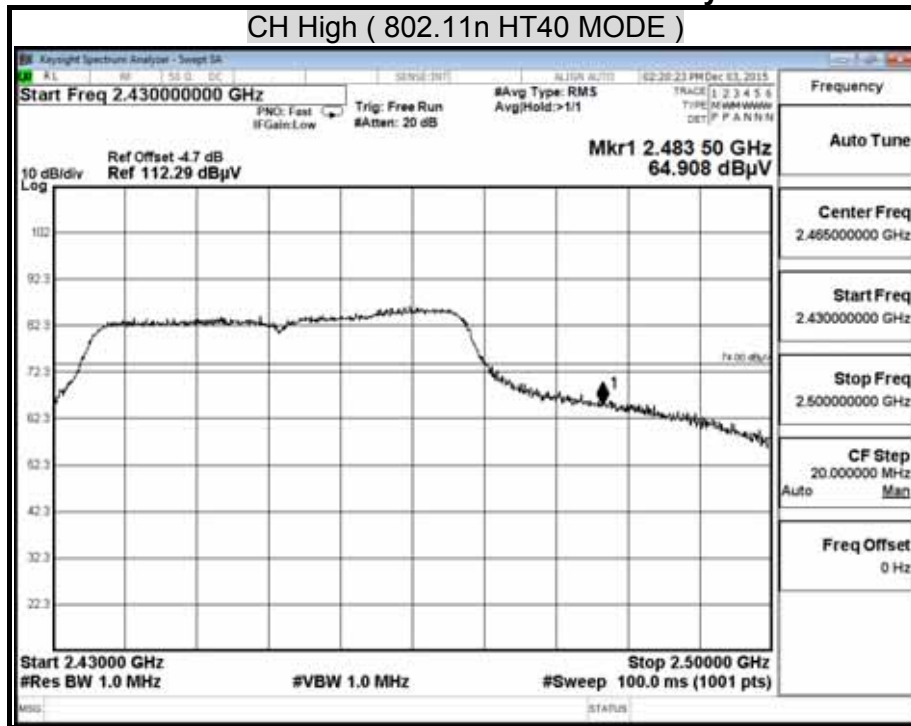

Detector mode : Average

Polarity : Horizontal

CH High (802.11n HT40 MODE)

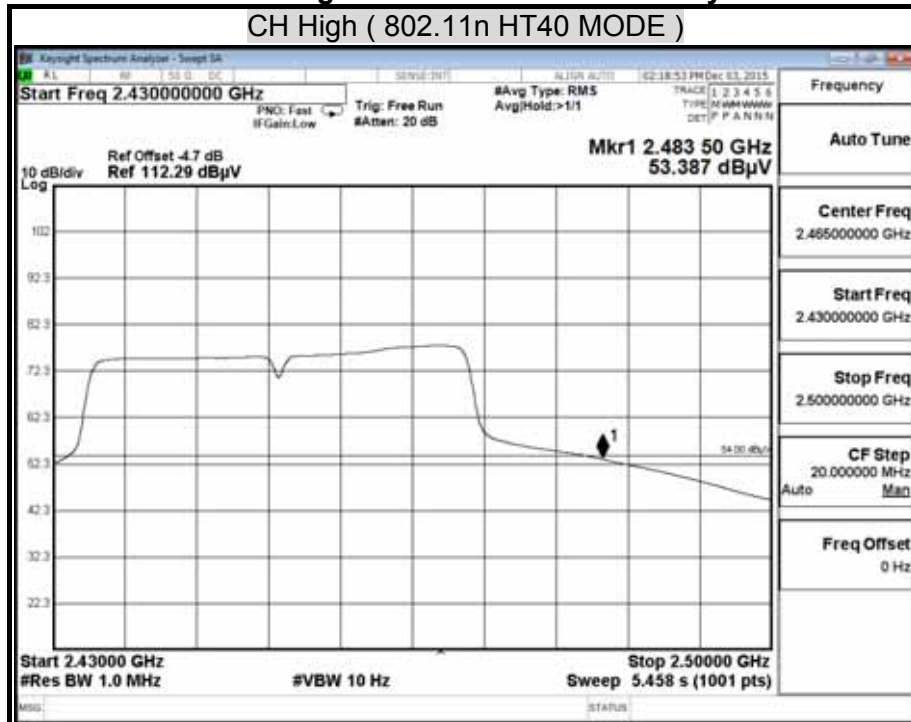

Detector mode : Peak

Polarity : Vertical

CH High (802.11n HT40 MODE)

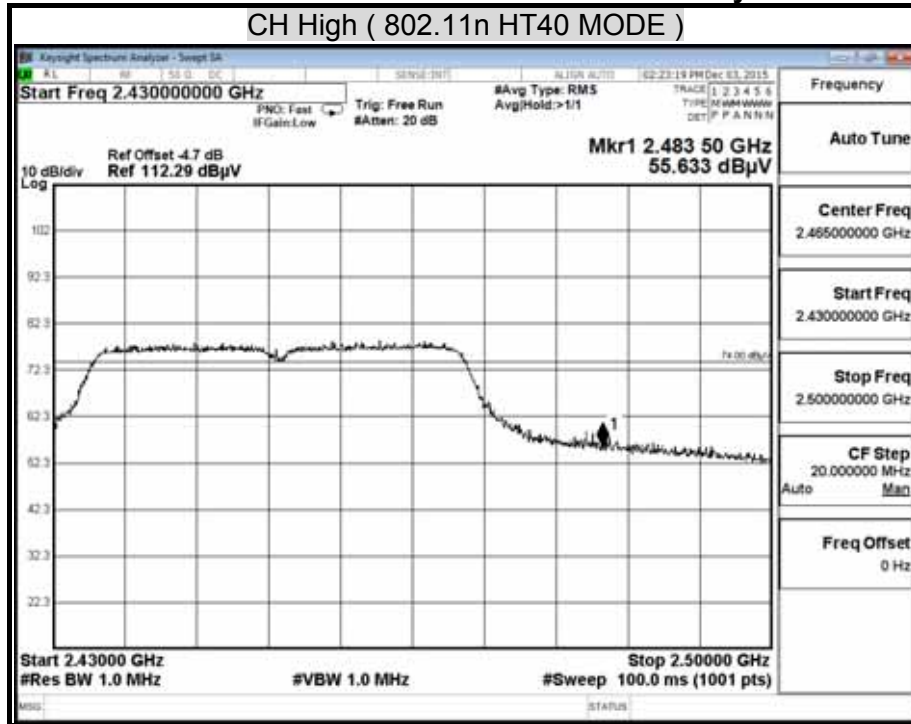

Detector mode : Average

Polarity : Vertical

CH High (802.11n HT40 MODE)

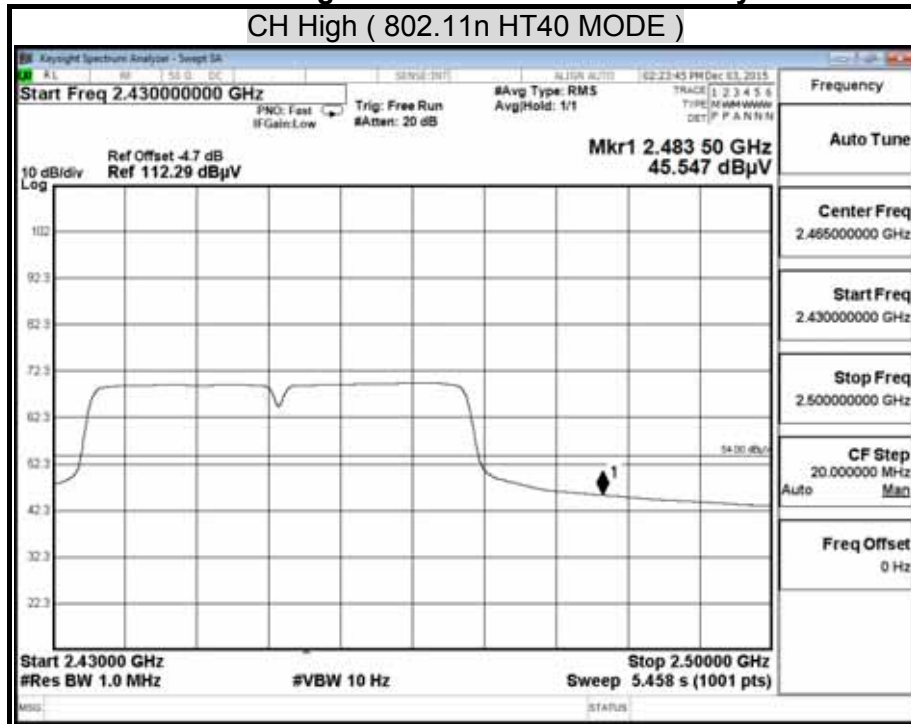

8.7 POWERLINE CONDUCTED EMISSIONS

LIMITS

§ 15.207 (a) Except as shown in paragraph (b) and (c) this section, for an intentional radiator that is designed to be connected to the public utility (AC) power line, the radio frequency voltage that is conducted back onto the AC power line on any frequency or frequencies within the band 150 kHz to 30 MHz shall not exceed the limits in the following table, as measured using a 50 µH/50 ohms line impedance stabilization network (LISN). Compliance with the provisions of this paragraph shall be based on the measurement of the radio frequency voltage between each power line and ground at the power terminal.

The lower limit applies at the boundary between the frequency ranges.

Frequency of Emission (MHz)	Conducted limit (dBµv)	
	Quasi-peak	Average
0.15 - 0.5	66 to 56	56 to 46
0.5 - 5	56	46
5 - 30	60	50

TEST EQUIPMENTS

The following test equipments are used during the conducted power line tests :

Conducted Emission room #1				
Name of Equipment	Manufacturer	Model	Serial Number	Calibration Due
L.I.S.N.	SCHWARZBECK	NNLK 8130	8130124	OCT. 27, 2016
	Rohde & Schwarz	ESH 3-Z5	893540/015	APR. 12, 2016
TEST RECEIVER	Rohde & Schwarz	ESCS 30	100348	DEC. 08, 2016
TYPE N COAXIAL CABLE	CCS	BNC50	11	DEC. 04, 2016
Test S/W	e-3 (5.04211c) R&S (2.27)			

TEST SETUP

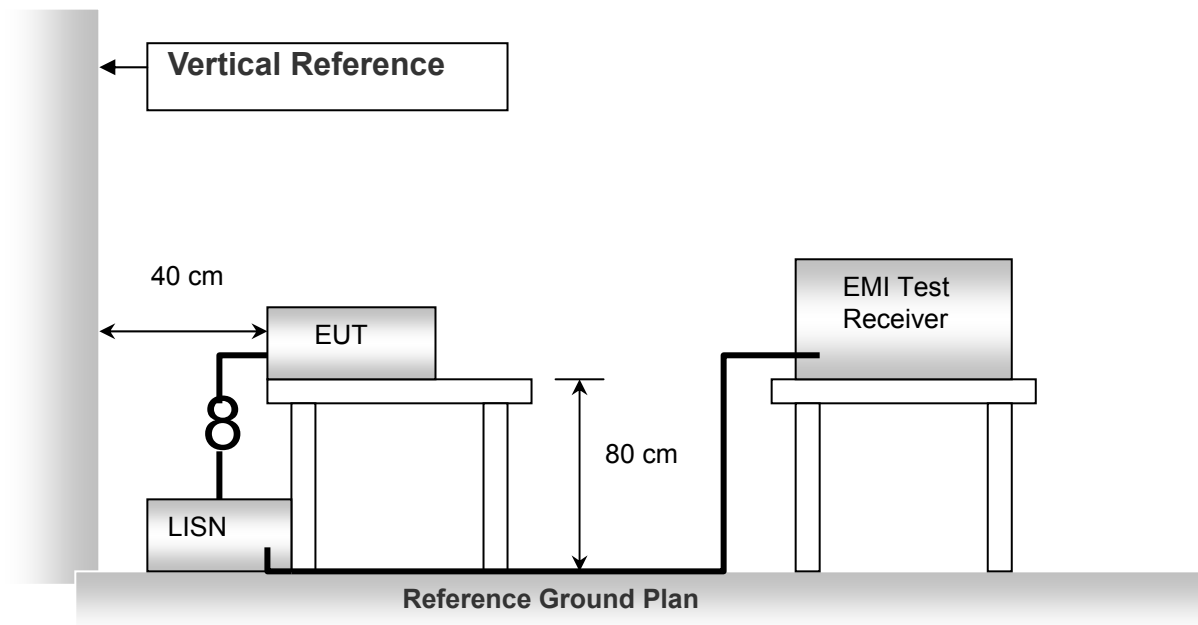

TEST PROCEDURE

The EUT is placed on a non-conducting table 40 cm from the vertical ground plane and 80cm above the horizontal ground plane. The EUT IS CONFIGURED IN ACCORDANCE WITH ANSI C63.10.

The resolution bandwidth is set to 9 kHz for both quasi-peak detection and average detection measurements.

Line conducted data is recorded for both NEUTRAL and LINE.

TEST RESULTS

No non-compliance noted.

Model No.	ZA1002US-5	Test Mode	Normal Operation
Environmental Conditions	24.4 , 56% RH	Resolution Bandwidth	9 kHz
Tested by	Ted Huang		

LINE

(The chart below shows the highest readings taken from the final data.)

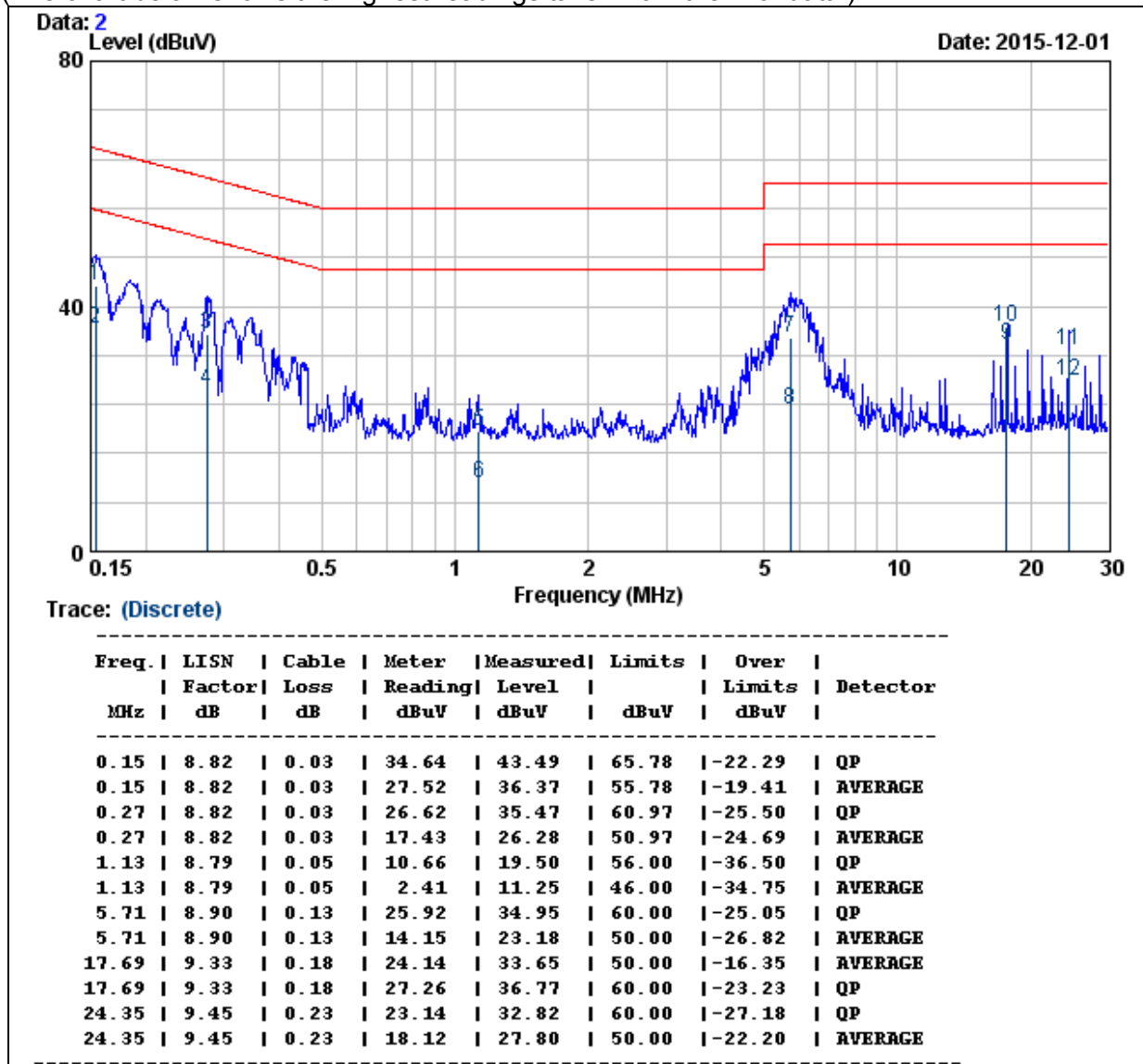

REMARKS : 1. Level (dBuV) = Read Level (dBuV) + LISN Factor (dB) + Cable Loss (dB)
 2. Over Limit (dBuV) = Measured Level (dBuV) – Limits (dBuV)

Model No.	ZA1002US-5	Test Mode	Normal Operation
Environmental Conditions	24.4 , 56% RH	Resolution Bandwidth	9 kHz
Tested by	Ted Huang		

NEUTRAL

(The chart below shows the highest readings taken from the final data.)

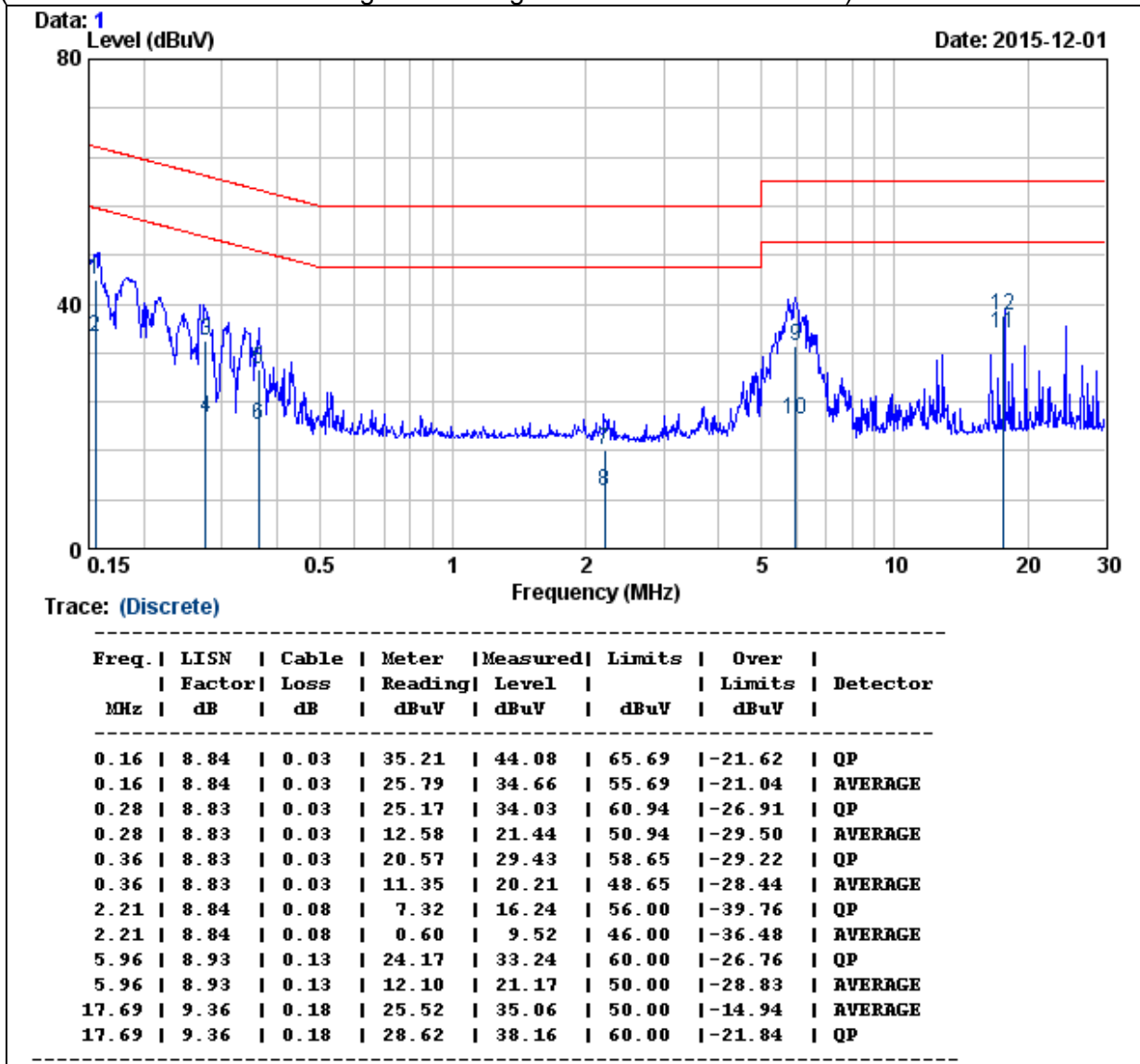

REMARKS : 1. Level (dBUV) = Read Level (dBUV) + LISN Factor (dB) + Cable Loss (dB)
 2. Over Limit (dBUV) = Measured Level (dBUV) – Limits (dBUV)

9. ANTENNA REQUIREMENT

9.1 STANDARD APPLICABLE

For intentional device, according to FCC 47 CFR Section 15.203, an intentional radiator shall be designed to ensure that no antenna other than that furnished by the responsible party shall be used with the device.

And according to FCC 47 CFR Section 15.247 (b), if transmitting antennas of directional gain greater than 6dBi are used, the power shall be reduced by the amount in dB that the directional gain of the antenna exceeds 6dBi.

9.2 ANTENNA CONNECTED CONSTRUCTION

Antenna (1TX1RX)

Type: PCB

Mode: AVA88

Gain : 5.3 dBi