

EXHIBIT C

User Manual



Installation Manual Street Smart Security

What Alarm System are You Using?

Choose the security system that the Code Encryptor is to be installed with:

- 1) Radionics, Caddx, F.B.I.I., DSC 832, Napco, Moose, C & K, and other alarms that offer a keyswitch Arm/Disarm as a "Zone Definition."

GO TO PAGE 4

- 2) Ademco 4110, 4120, and Vista 10, 20, and 30.

GO TO PAGE 7

- 3) DSC 1550, 2525, 2550, and 3000

GO TO PAGE 10

- 4) DSC 1575

GO TO PAGE 6

Code Encryptor

Location of the control module is the most important factor in range and reliability of your Code Encryptor. Select a location that is as centrally located as possible. Keep in mind that your customer will want to control the operation of the garage door from the driveway, and will also expect the use of the remote for On/Off in the area of entry and exit.

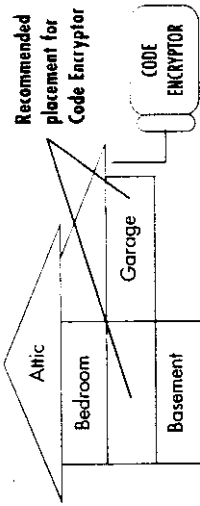

NOTE: If using any other wireless system, install the Code Encryptor in the Garage to avoid possible RF interference.

For optimal reception, make sure the antenna is extended in the highest possible position and away from other electrical wiring.

If you are using the Code Encryptor to operate the garage door, mount the receiver in the garage and run power. Ground and alarm wires to the panel. You can also mount the receiver of the alarm panel if it is not too far from the garage door. Ideally, the Code Encryptor should be mounted near the entry keypad, which is typically near the entry/exit point of the house. **DO NOT MOUNT THE CONTROL MODULE IN THE ALARM PANEL.**

1

Installation for Keyswitch Arming

(i.e., Caddx, Radionics, F.B.I.I., DSC 832, Napco, etc.)

- Red Aux +
- Black Aux -
- Brown/White Zone programmed for keyswitch arming
- Brown Common adjacent to zone

NOTE: For most Napco panels, you must use Zone 5 as the keyswitch arm/disarm zone.

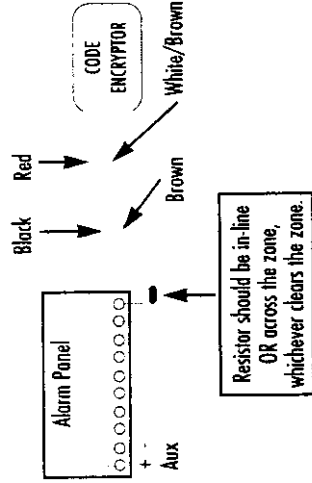

Connect Red and Black to Aux Negative and Positive.

Connect Brown and White/Brown to the zone programmed for a momentary

Wiring Diagram

Yellow	Data Out: Ademco & DSC
	1550, 2525, 2550, 3000
Green	Data In: Ademco & DSC
	1550, 2525, 2550, 3000
Gray	(-) Channel 3 Output
Red/White	Channel 2 Output (Garage Door Pushbutton)
White	Channel 2 Common (Garage Door Pushbutton)
Brown	Channel 1 Common
	(Keyswitch arm/disarm)
Brown/White	Channel 1 Output (Keyswitch arm/disarm)
Not Used	Reserved for future use
Red	+12VDC
Black	(-) Ground

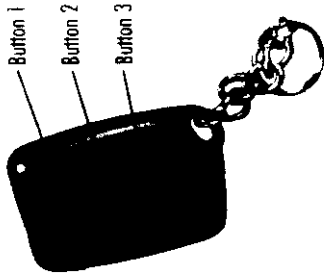

- Button 1 Alarm ON/OFF STAY**
- Button 2 Garage Door OPEN/CLOSE
- Button 3 PANIC OUTPUT
(Hold for 3 seconds)

**Press and hold for 3 seconds to activate "STAY" mode for most panels

2

Programming for Keyswitch Arming

The Code Encryptor's default programming is the keyswitch mode. If, after completing the installation, Button 1 does not arm/disarm the alarm, listen carefully to the Code Encryptor while pressing Button 1. If you hear the Code Encryptor "clicking" the alarm panel is not properly programmed. If you do not hear the "clicking", follow the steps below to re-enter the keyswitch mode.

- Step 1 Unplug the wire harness from the Code Encryptor
- Step 2 Press and HOLD the program button.
- Step 3 While HOLDING the program button, plug the Code Encryptor harness back in. The LED light located on the front will turn ON
- Step 4 Wait 2 seconds and release the program button, the light will turn OFF.
- Step 5 PRESS AND RELEASE the program button one time.
- Step 6 Watch the LED to confirm that it flashes once (it will take 3 seconds to confirm). If the LED stays ON continuously, start over at Step 1).

GO TO PAGE 12 (GARAGE DOOR INTERFACE)

WH DSC 1575

- Red Aux +
- Black Aux -
- Brown/White Aux +
- Brown PGM 2 with 2.2K resistor in series

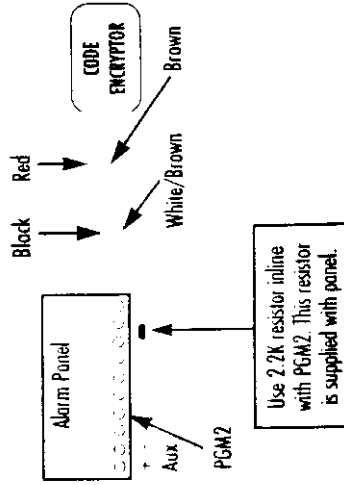

Programming the DSC 1575

Refer to the DSC 1575 Installation Manual for instructions on programming PGM2 for momentary keyswitch arming.

GO TO PAGE 5 (PROGRAMMING FOR KEYSWITCH ARMING)

Programming for Ademco (Continued)

- Step 7 Press and **HOLD** the program button on the receiver. The light will come **ON** and stay **ON** for 3 seconds then turn **OFF**. **RELEASE** the program button and then the light will begin to flash.
- Step 8 Using the keypad slowly and firmly, enter a valid four-digit User Code. This code has now been entered into the Code Encryptor's non-volatile memory. The Code Encryptor will remember this user code even in the event of a power failure. To change to a new User Code repeat steps 7 and 8 above.

NOTE: We recommend using a User Code that the customer cannot change. If the User Code that is programmed into the Code Encryptor is changed, the Code Encryptor will not disarm the alarm panel.

GO TO PAGE 12 (GARAGE DOOR INTERFACE)

WH DSC 1550, 2550, 3000

- Red Aux +
- Black Aux -
- Yellow Data Out
- Green Data In

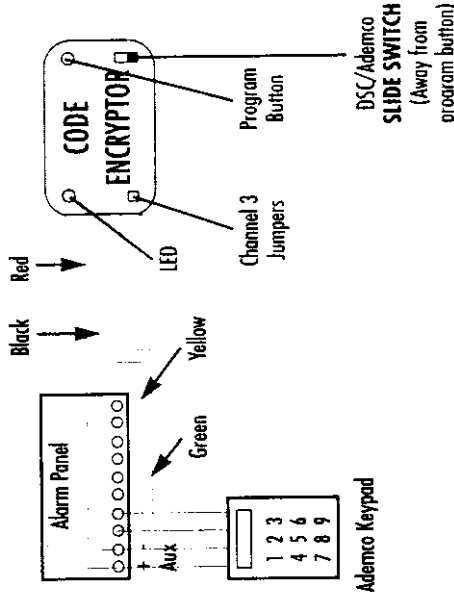

Installation for DSC 1550, 2525, 2550, and 3000

- Red Aux +
- Black Aux -
- Yellow Data Out
- Green Data In

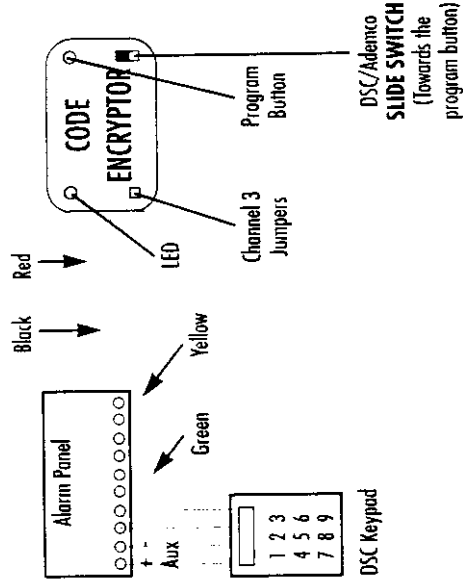

WH DSC 1550, 2550, 3000

...if you are using multiple keypads, they must be programmed for the default address setting of 31

...if you are using a 5881 wireless receiver or a 4285 voice/phone module you must install and program the user code into the Code Encryptor first. Ensure the 5881 and 4285 are programmed OFF before you install and program the Code Encryptor.

- Step 1 Unplug the wire harness from the Code Encryptor.
- Step 2 Press and **HOLD** the program button.
- Step 3 While **HOLDING** the program button, plug the Code Encryptor harness back in. The LED light located on the front will turn **ON**.
- Step 4 Wait 2 seconds and release the program button, the light will turn **OFF**.
- Step 5 **PRESS AND RELEASE** the program button 2 times.
- Step 6 Watch the LED to confirm that it flashes twice (it will take 3 seconds to confirm. If the LED stays **ON** continuously, start over at Step 1).

TO PROGRAM A USER CODE

Programming a User Code into the Code Encryptor is mandatory when using the Ademco Data bus Interface (Green and Yellow wires). This gives the Code Encryptor microprocessor a User Code to arm and disarm the panel. This code can be changed or re-programmed at any time.

Programming for DSC 1550, 2525, 2550, and 3000 (Continued)

- Step 1 Unplug the wire harness from the Code Encryptor.
- Step 2 Press and **HOLD** the program button.
- Step 3 While **HOLDING** the program button, plug the Code Encryptor harness back in. The LED light located on the front will turn **ON**.
- Step 4 Wait 2 seconds and release the program button, the light will turn **OFF**.
- Step 5 **PRESS AND RELEASE** the program button three times.
- Step 6 Watch the LED to confirm that it flashes three times. (If the LED stays **ON** continuously, start over at Step 1).

TO PROGRAM A USER CODE

Programming a User Code into the Code Encryptor is mandatory when using the DSC Data-bus Interface (Green and Yellow wires). This gives the Code Encryptor microprocessor a User Code to arm and disarm the panel. This code can be changed or re-programmed at any time.

- Step 7 Press and **HOLD** the program button on the receiver. The light will come **ON** and stay **ON** for 3 seconds then turn **OFF**. **RELEASE** the program button.
- Step 8 Using the keypad, slowly and firmly, enter a valid four-digit User Code. This code has now been entered into the Code Encryptor's non-volatile memory. The Code Encryptor will remember this user code even in the event of a power failure. To change to a new User Code repeat steps 7 and 8 above.

NOTE: We recommend using a User Code that the customer cannot change. If the User Code that is programmed into the Code Encryptor is changed, the Code Encryptor will not disarm the alarm panel.

All garage doors have a wall mounted push button that activates the door via a two-wire connection. Make your connection at the push button switch or at the garage door motor where these two wires terminate. The Code Encryptor will interface with this connection by attaching the Red, White and White wires from the Code Encryptor to these two wires. If you choose to connect to the motor, trace the wires from the push button to the motor to determine the proper connection point. Most garage doors (except MDM Crusader models) use terminals #1 and #2. For MDM Crusader models, use terminals #2 and #3.

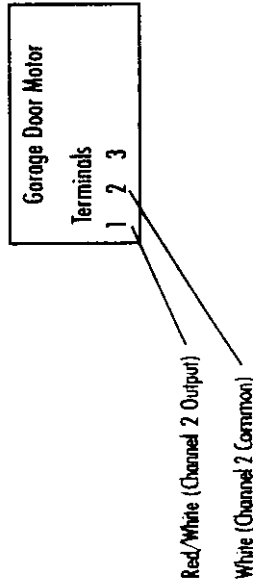

GO TO PAGE 13 (PANIC MODE SETUP)

12

To Add or Delete Remotes

TO ADD A NEW REMOTE

To add a remote to your Code Encryptor **PRESS AND RELEASE** the program button on the receiver. The light on the receiver will come **ON**. Immediately **PRESS** Button 1 (largest button) on the new remote control **THREE TIMES**. The light on the receiver should go **OFF**, indicating the remote has been learned. If the light on the receiver stays **ON**, the remote has not been learned. Remove and replace the harness, and follow these instructions again.

TO DELETE ALL REMOTES

To delete a lost or stolen remote from the Code Encryptor, you must purge the memory. This will delete all the current remotes in the non-volatile memory. You then have to add **ALL** the remotes back into memory. To purge the memory, **PRESS AND HOLD** the program button, the light will come **ON** for four seconds, then go **OFF**, and finally it will go **ON** again, indicating that all the remotes have been purged. Release the program button and follow the instructions above (To Add a New Remote).

To install the Code Encryptor with panic mode, select a free zone and program it for Panic. Programming instructions are found in the "Zone Definitions" section of the alarm installation manual. After the alarm panel and Code Encryptor have been powered up, attach the Gray wire to the zone programmed for panic. Pressing Button 3 (smallest button) for 3 SECONDS will cause the alarm to panic.

NOTE: If this wire is connected before the Code Encryptor is powered up, a signal may inadvertently be sent to the alarm panel causing triggering the panic mode on the zone you selected.

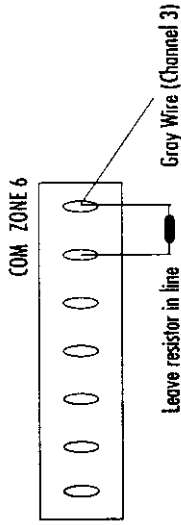

Example: Zone 6 programmed for Panic.

13

Optional Channel 3 Output

Occasionally, you may want to use Channel 3 for control of optional accessories (i.e., Maitbu lighting, sprinklers, X-10 automation). The Code Encryptor provides the ability to reconfigure Channel 3 to a variety of popular outputs using the onboard jumpers. Output/jumper configuration is as follows:

- Both jumpers in (default) Momentary output
- Jumper closest to the harness removed Latching (on/off) output
- Jumper farthest from the harness removed 75 second timed output
- Both jumpers out 150 second timed output

This output is a 12VDC/500 ma (-) transistor output. In most cases it will be necessary to add a 12VDC relay to this output in order to control high current accessories. Refer to page 17 (CHANNEL 3 RELAY WIRING) for assistance.

NOTE: When using the gray wire with a Powerflash module, it is not necessary to add a relay. Connect the gray wire to the (-) side of the Powerflash module and provide 12VDC to the (+) side.

14

Channel 3 Relay Wiring

Typical installation using a relay to switch power on and off to a low voltage accessory.

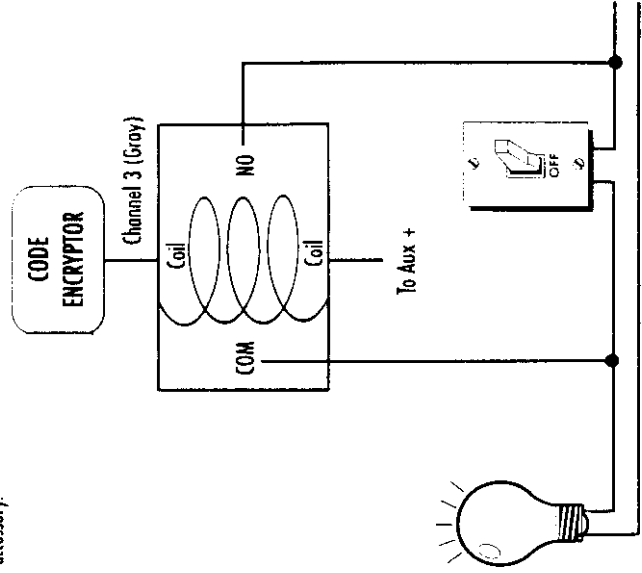

16

15

17

- 1) For troubleshooting problems using an alarm panel programmed for keyswitch arm, disarm
GO TO PAGE 19
- 2) For troubleshooting problems using an Ademco 4110, 4120 or Vista 10, 20, 30
GO TO PAGE 20
- 3) For troubleshooting problems using a DSC 1550, 2525, 2550, 3000
GO TO PAGE 21
- 4) For general troubleshooting problems (i.e., remotes, range, etc.)
GO TO PAGE 22

Panels with Keyswitch Arm/Disarm

- When I press Button 1, I hear the relay clicking but nothing happens.
1. Ensure the alarm panel is programmed for keyswitch arm/disarm.
 2. Ensure the Code Encryptor is connected to the zone you programmed.
 3. Ensure the resistor is connected (series or parallel) to the zone.

When I press Button 1, I do not hear the relay clicking.

1. Ensure the Code Encryptor is in the keyswitch mode (GO TO PAGE 5 - Steps 1 through 6).
2. Ensure the remote is programmed to the Code Encryptor's memory (GO TO PAGE 15).

4110, 4120 and Vista 10, 20, 30

- When I press Button 1, I hear the relay clicking but nothing happens.
- The Code Encryptor will not learn the User Code from the keypad.
1. Ensure the alarm panel is programmed for Ademco alarm. (GO TO PAGE 8).
 1. If you are using a 3881 or 4285, ensure the Code Encryptor is programmed before adding or programming these devices.
 2. Ensure the green and yellow wires are connected properly.
 3. Ensure the alarm keypad is programmed to the default address 31.

The Code Encryptor is programmed for Ademco, but does not arm/disarm.

1. Ensure you have completed the mandatory User Code programming.
2. Ensure the User Code you entered is a **VALID** User Code.
3. Ensure the slide switch is in the correct position (away from the program button).

Troubleshooting Problems for DSC 1550, 2525, 2550, 3000

- When I press Button 1, I hear the relay clicking but nothing happens.
- The Code Encryptor will not learn the User Code from the keypad.
1. The Code Encryptor is not programmed for DSC alarm panel (GO TO PAGE 11).
 1. Ensure you enter the User Code slowly and firmly.
 2. Ensure the green and yellow wires are connected properly.

The Code Encryptor is programmed for DSC, but does not arm/disarm.

1. Ensure you have completed the mandatory User Code programming (GO TO PAGE 11).
2. Ensure the User Code you entered is a **VALID** User Code.
3. Ensure the slide switch is in the correct position (away from the program button).
4. If you are using a DSC 1575 or Power 832, refer to programming for alarms using keyswitch arm/disarm (GO TO PAGE 3).

Troubleshooting for General Problems

- Code Encryptor does not seem to do anything when I press any remote button.
1. Check power and ground.
 2. Verify the remote is learned into the Code Encryptor's memory (GO TO PAGE 15).
 3. Ensure that the remote battery is good.
- The Code Encryptor arms the alarm panel, but does not panic.
1. Ensure the alarm panel is programmed for "end-of-the-line resistors on".
 2. Ensure you are holding Button 3 for approximately three seconds.

I can't seem to add more remotes to the Code Encryptor.

1. Delete all remotes from memory and add remotes back in one at a time (GO TO PAGE 15).
1. Ensure the Code Encryptor is mounted as high as possible.
2. Do not mount the Code Encryptor inside the metal alarm panel enclosure.

The remote does not seem to get very good range.

3. Extended the antenna, in a straight line, to the highest possible position. Do not coil or bundle the antenna.

Specifications

RECEIVER

- 12VDC Power Input
- Channels 1 and 2 relays onboard (2 Amp)
- Channel 3 Selectable Output. 12VDC 500 ma (-) transistor output. This output can be reconfigured from a pulsed output to a latching, 7.5 second timed or 150 second timed output.

Frequency: 303 Mhz
Stand by Power Consumption: 20 ma
Temperature Range: -5 F to 160 F Indoor use only.

REMOTE CONTROL

Battery: 12VDC Mini (Part #GP23A) Range: 80-120 feet
Replace battery at least once a year.

CHANNEL 3 OUTPUT

- Both jumpers in (default) Momentary output
- Jumper closest to the harness removed Latching (on/off) output
- Jumper farthest from the harness removed 7.5 second timed output
- Both jumpers out 150 second timed output

STREET SMART TECHNICAL can be reached:
Monday-Friday 9am-5pm PST at
(888) 768-2846 OR Fax (619) 513-9352