

PetSafe[®] Wireless Pet Containment System[™] Operating and Training Guide

Please read this entire guide before beginning

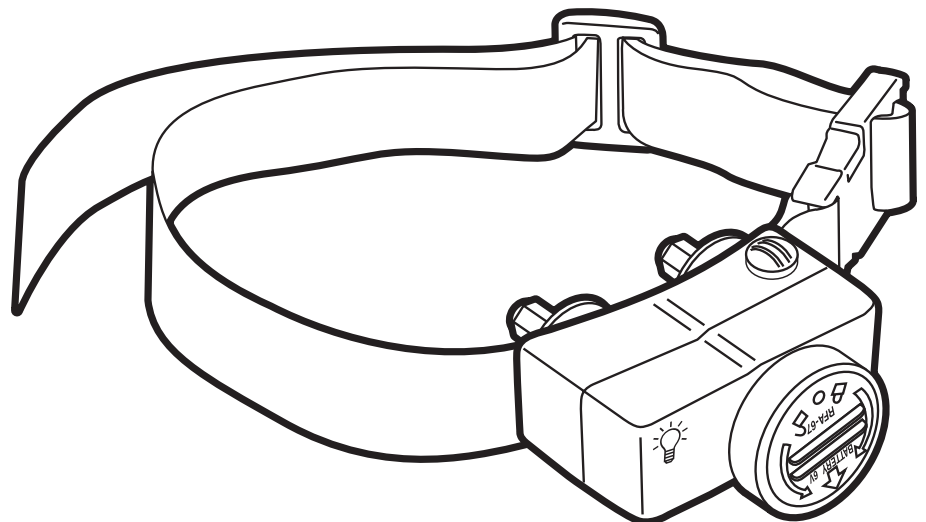
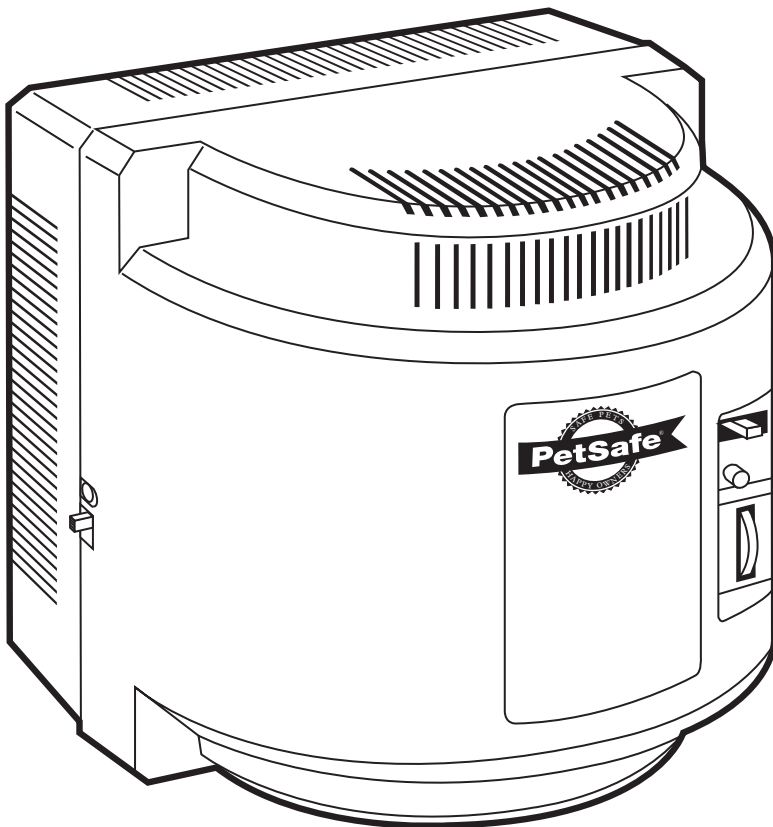

Thank you for choosing PetSafe®, the #1 selling brand of electronic training solutions in the world. Our mission is to ensure your pet's safety by providing you the tools and techniques to successfully train your pet. If you have any questions, please contact the Customer Care Center at 1-800-732-2677 or visit our website at www.petsafe.net.

Table of Contents

Components	3
Other Items You May Need.....	3
How the System Works	4
Key Definitions	4
Operating Guide	
Set Up the Transmitter.....	5
Prepare the Receiver Collar	5
Adjust the Pet Area to Desired Size	6
Transmitter Range Chart	7
Place the Boundary Zone Flags	7
Fit the Receiver Collar	8
Training Guide	
Be Patient With Your Pet	9
Day 1 – Boundary Flag Awareness.....	9
Days 2 thru 4 – Continue Boundary Flag Awareness	10
Days 5 thru 8 – Distraction Phase	10
Days 9 thru 14 – Unleashed Supervision.....	11
Taking Your Pet Out of the Pet Area	11
Wireless - To - Go	12
Accessories	12
Frequently Asked Questions	12
Troubleshooting.....	14
Test Light Instructions	15
Terms of Use and Limitation of Liability	15
FCC	16
Caution	16
Mounting Template	16

Components

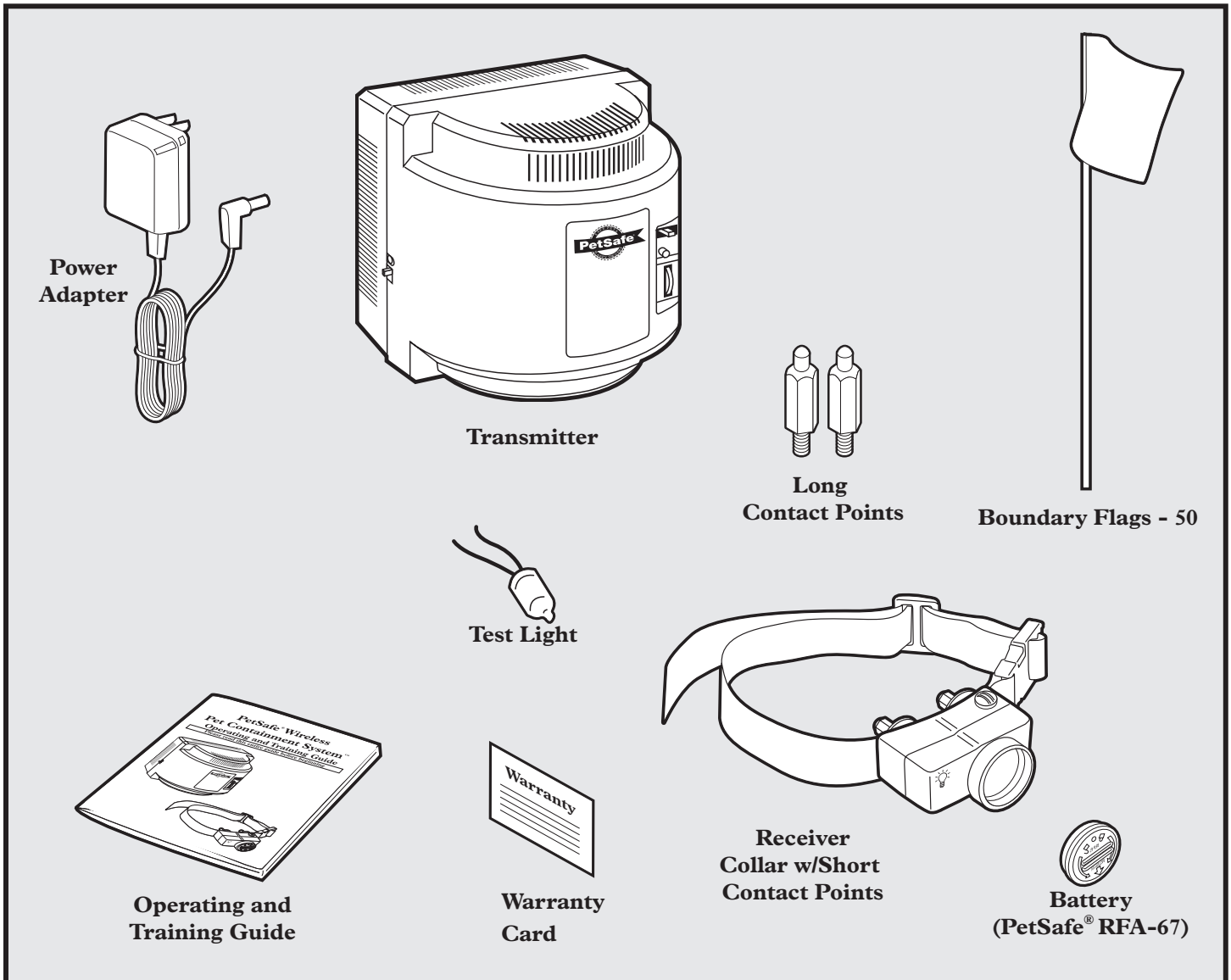

Other Items You May Need

- Pliers
- Scissors
- Lighter
- Drill & mounting hardware
- Tape measure
- Non-metallic collar and leash

How the System Works

The PetSafe Wireless Pet Containment System™ has been proven safe, comfortable, and effective for all pets over 8 pounds. The system works by transmitting a radio signal up to 90 feet in all directions. You temporarily define the Pet Area with Boundary Flags for a visual aid in training your pet. Your pet wears a Receiver Collar with Contact Points that touch his neck, and, once trained, is allowed to roam freely in the Pet Area. When your pet reaches the Boundary Zone, the Receiver Collar gives a warning beep before delivering a safe Static Correction through the Contact Points to get his attention until he returns to the Pet Area.

Key Definitions

Transmitter: Transmits the radio signal and is the center of the Pet Area.

Pet Area: Distance from the Transmitter where your pet can roam freely.

Boundary Zone: 2 to 3 foot wide area outside the Pet Area where your pet's Receiver Collar will begin to beep and then begin to deliver a Static Correction. The correction will start in the Boundary Zone and continue anywhere beyond the Pet Area. *Note: The Receiver Collar is equipped with a safety time-out feature that will stop correcting after 30 seconds if your pet remains outside the Pet Area.*

Receiver Collar: Receives the radio signal from the Transmitter.

Correction Level Button: Adjusts the level of Static Correction your pet receives outside the Pet Area.

Receiver Indicator Light: Indicates the level of correction at which the Receiver Collar is set. This light also serves as a low battery indicator.

Contact Points: Deliver the safe Static Correction when your pet moves into the Boundary Zone.

Power Jack: Where the Power Adapter plugs into the Transmitter. The Transmitter is powered by a standard 120-volt outlet.

Boundary Switch: Adjust according to the size of the Pet Area desired.

Power Light: Indicates when the Transmitter is on.

Boundary Control Dial: Adjusts the distance from the Transmitter to the Boundary Zone. *Note: Adjusting the dial does not change the level of Static Correction on the Receiver Collar.*

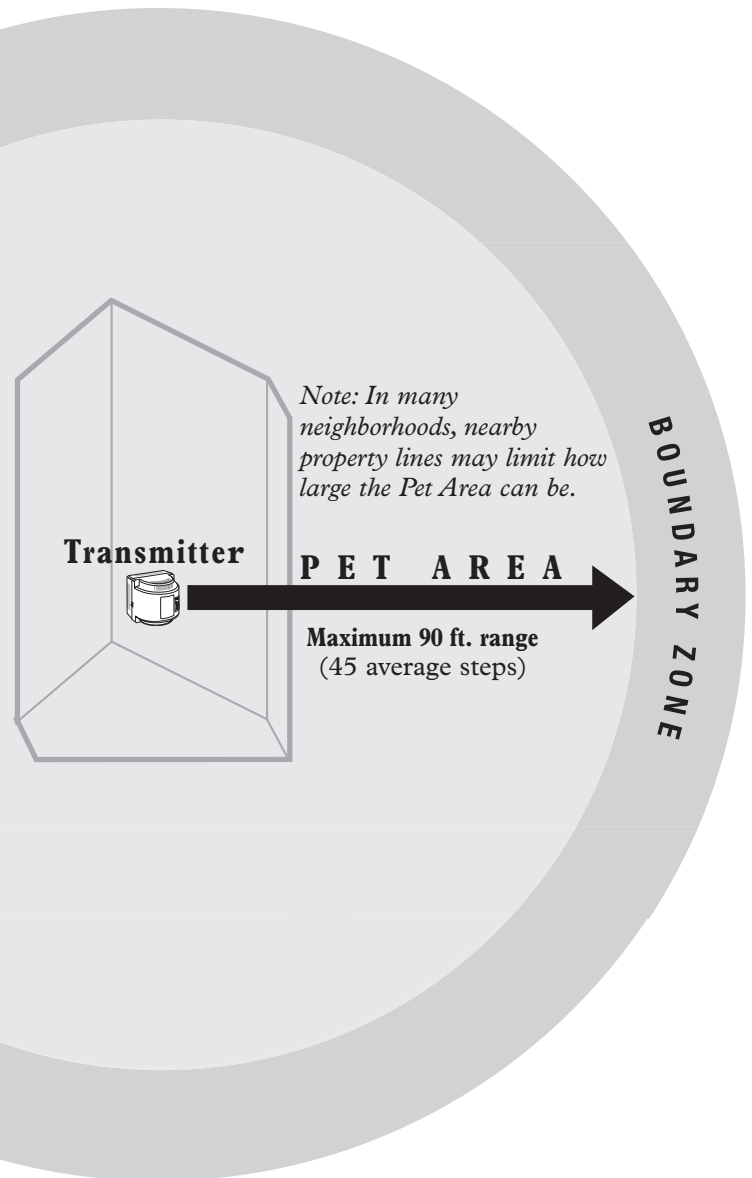

Receiver Collar

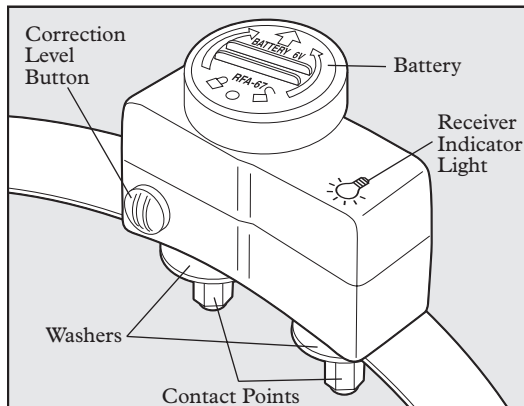

Transmitter

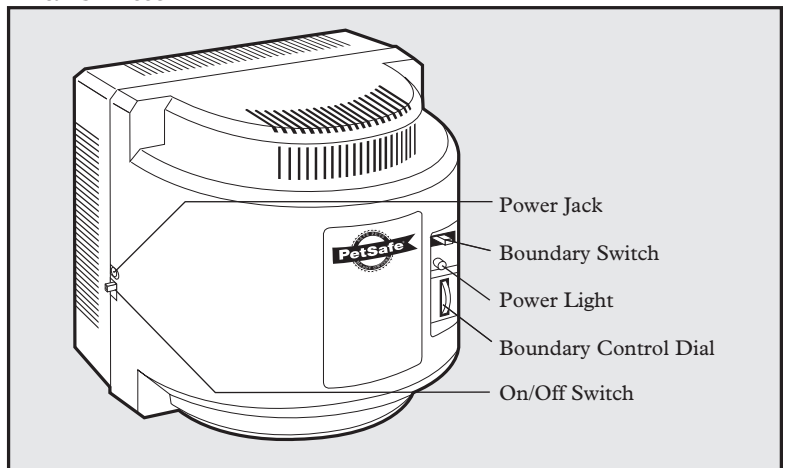

Operating Guide

Step 1 Set Up the Transmitter

Important: You may need to move the Transmitter several times before determining the final location.

The Transmitter is located at the exact center of the Pet Area. Place the Transmitter:

- 2 to 4 feet above the floor.
- In a dry, well ventilated, protected area.
- In an area where temperatures do not fall below freezing (e.g., garage, basement, shed, closet).
- On a non-metal table or mount on a wall (1A). A mounting template is included on the back of this guide.
- At least 3 feet from large metal objects, as these items may reduce the size and shape of your Pet Area (1B).

To maximize your Pet Area, make sure the Boundary Switch is on “High” and the Boundary Control Dial is set to “8” (1C). Plug Power Adapter into Power Jack and standard 120-volt outlet. Turn the Transmitter on.

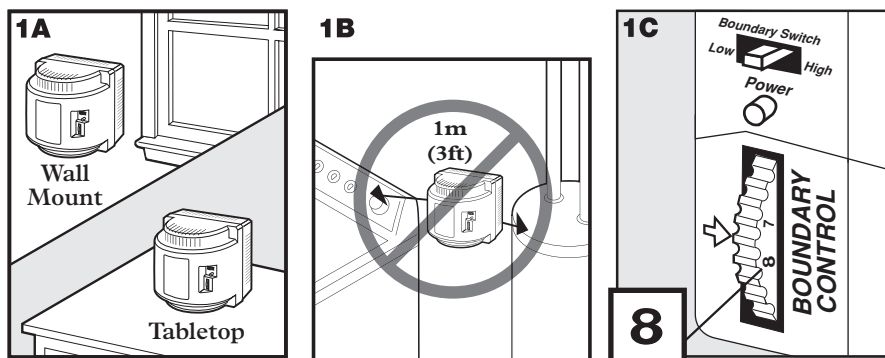

Step 2 Prepare the Receiver Collar

Your Receiver Collar comes with short Contact Points installed. Use the long Contact Points for pets with long or thick hair. Tighten the Contact Points with pliers one-half turn beyond finger tight (2A). Check the tightness weekly.

To Insert and Remove the Battery

Note: Do not install the battery while the Receiver Collar is on your pet.

This Receiver Collar utilizes a replaceable PetSafe® battery (RFA-67). This unique battery is designed to make battery replacement easier and increase water protection.

To insert the battery, align the symbols on the battery (arrow) and Receiver Collar (triangle) (2B). Use a large coin to turn the battery clockwise until the arrow lines up with the lock symbol on the housing (2C).

To remove the battery, turn the battery counter-clockwise using a large coin (2D, 2E). DO NOT attempt to cut into or pry open the battery. Be sure to discard the used battery properly.

A replacement PetSafe® battery (RFA-67) can be found at many retailers. Contact the Customer Care Center at 1-800-732-2677 or visit our web site at www.petsafe.net to locate a retailer near you.

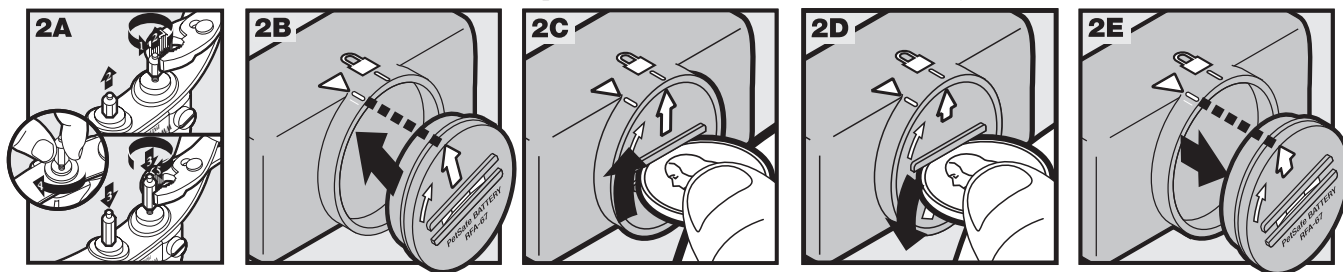

To Set the Static Correction Level

Note: Your receiver collar has been factory-set to Beep Only.

Read all steps before attempting to set the Static Correction Level.

1. Remove the clear plastic cover with a coin to expose the Correction Level Button (2F).
2. With the battery installed, press the Correction Level Button and release when the Receiver LED Indicator Light lights up (2G).
3. The Receiver LED Indicator Light will emit a series of flashes representing the Static Correction Level.
4. Increase the Static Correction Level by pressing and releasing the Correction Level Button within 5 seconds of the previous series of flashes.
5. After setting the Static Correction Level, replace the cover to protect the Correction Level Button.

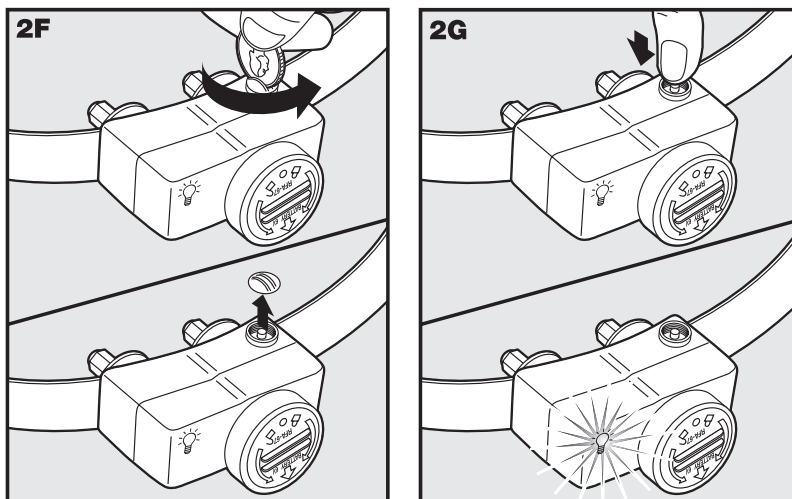

The Static Correction levels increase in strength from 1 to 4. Pushing the Correction Level Button while the Receiver Collar is on level 4 will cause the Receiver Collar to revert to level 1. Refer to the Function and Response Table to choose the Static Correction level that best fits your pet.

The Receiver LED Indicator Light acts as a low battery indicator, flashing every 4 to 5 seconds when replacement is required.

Function and Response Table

Indicator Light Response	Static Correction Level	Receiver Collar Function	Temperament of Pet
1 Flash	1	No Static Correction, Beep Only	
2 Flashes	2	Low Static Correction	Timid
3 Flashes	3	Medium Static Correction	Timid or Average
4 Flashes	4	High Static Correction	Average or High Energy
Flashes once every 4 to 5 seconds		Indicates Low Battery	

Note: Begin training with Static Correction Level 2 and only increase if your pet does not respond to the Static Correction.

Step 3 Adjust the Pet Area to Desired Size

Make sure the entire Pet Area lies within your property boundaries (3A). Always start determining the Boundary Zone at the shortest distance from Transmitter. Place the Boundary Switch on “Low” if the Boundary Zone will be less than 45 feet from the Transmitter.

Two-Person Method

Hold the Receiver Collar at your pet’s neck height (3B) with logo side facing away from the Transmitter (3C). Walk to the edge of the desired Pet Area. Facing away from the Transmitter, hold the Receiver Collar at the edge of the desired Pet Area (3D).

Starting with the Boundary Control Dial set to “8”, have a second person turn the dial down SLOWLY. When the Receiver Collar starts to beep, tell the person to stop turning the Boundary Control Dial. Record your settings below for future reference.

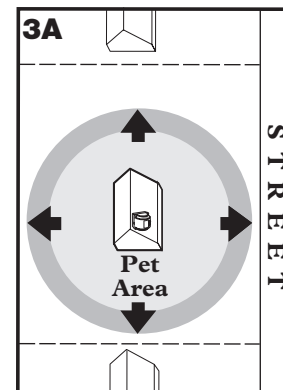

One-Person Method

Measure the shortest distance from the desired Boundary Zone to the Transmitter. Find the distance on the Transmitter Range Chart below and set the Boundary Switch and Boundary Control Dial. Take the Receiver Collar to the Boundary Zone with the Receiver Collar at your pet's neck height (3B) with logo side facing away from the Transmitter (3C).

Determine where the Receiver Collar begins to beep. If the Receiver Collar beeps before or after the desired Boundary Zone, return to the Transmitter and adjust the Boundary Control Dial. Repeat this process until the Receiver Collar is beeping at the desired location. Record your settings below for future reference.

Note: If you cannot hear the beep, refer to the "Test Light Instructions" section.

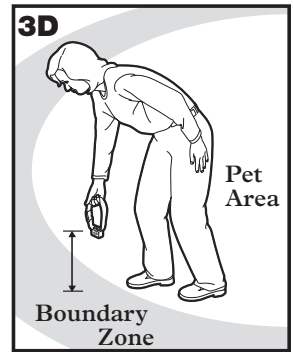
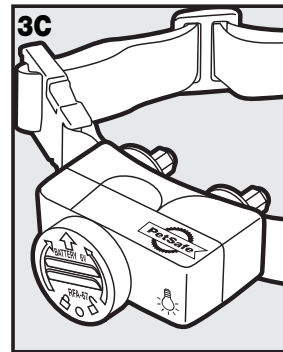
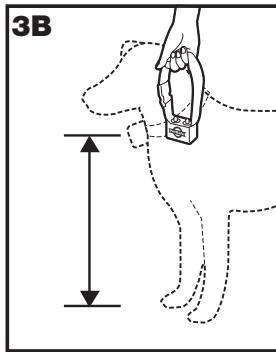

Transmitter Range Chart

Boundary Control Dial Position	Boundary Switch LOW	Boundary Switch HIGH
1	5-10 ft	5-10 ft
2	5-10 ft	5-10 ft
3	15-20 ft	25-35 ft
4	20-25 ft	42-55 ft
5	25-30 ft	55-65 ft
6	35-40 ft	75-85 ft
7	40-45 ft	85-90 ft
8	40-45 ft	85-90 ft

Note: These distances are approximate.

Record Your Settings

	Final Boundary Switch Setting (HIGH or LOW)	Final Boundary Control Dial Position (1-8)	Receiver Static Correction Level (1-4)
Home			
Camping			
Vacation			
Other			

Step 4 Place the Boundary Flags

The Boundary Flags are visual reminders for your pet of where the Boundary Zone is located. The Receiver Collar will activate within 2 to 3 feet of the Boundary Flags.

1. Hold the Receiver Collar at your pet's neck height with logo side facing away from the Transmitter.
2. Walk towards the Boundary Zone until the Receiver Collar beeps (4A).
3. Place a Boundary Flag in the ground (4B).
4. Walk back into the Pet Area until the beeping stops.
5. Repeat this process around the Boundary Zone until it is marked with Boundary Flags every 10 feet.

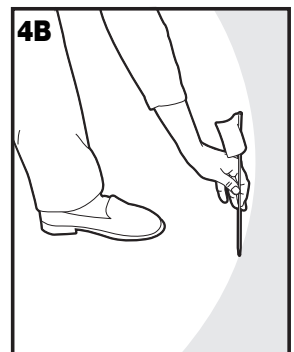

The Boundary Flags may be in different parts of the Boundary Zone and may not be in a line. The Boundary Zone is 2 to 3 feet wide.

Note: If you cannot hear the beep, refer to the "Test Light Instructions" section.

Step 5 Fit the Receiver Collar

5

Important: The proper fit and placement of your Receiver Collar is important for effective training. The Contact Points must have direct contact with your pet's skin on the underside of his neck.

To assure a proper fit, please follow these steps:

1. Make sure that the battery is not installed in the Receiver Collar.
2. Start with your pet standing comfortably (5A).
3. To make it easier to hear the warning beep, place the Receiver Collar on your pet with the logo side of Receiver facing up.
4. Center the Contact Points underneath your pet's neck, touching the skin. If your pet has a long or thick coat, use the enclosed long Contact Points to reach through the hair. *Note: It is sometimes necessary to trim the hair around the Contact Points to make sure that contact is consistent.*
5. Check the tightness of the Receiver Collar by inserting one finger between the end of a Contact Point and your pet's neck. The fit should be snug but not constricting (5B).
6. Allow your pet to wear the collar for several minutes then recheck the fit. Check the fit again as your pet becomes more comfortable with the Receiver Collar.
7. Trim the collar as follows (5C):
 - a. Mark the desired length of the Receiver Collar with a pen. Allow for growth if your pet is young or grows a thick winter coat.
 - b. Remove the Receiver Collar from your pet and cut off the excess.
 - c. Before placing the Receiver Collar back onto your pet, seal the edge of the cut collar by applying a flame along the frayed edge.

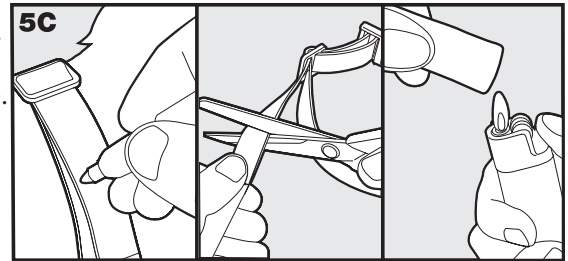
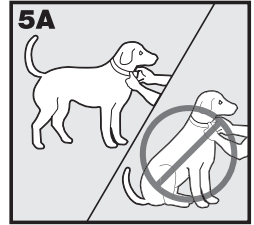

Important: For comfort, safety and effectiveness of product, please ensure the following:

- During the first 2 weeks of training, do not use the training device on your pet without direct supervision.
- Check the fit to prevent excessive pressure by being able to insert one finger between the Contact Point and your pet's skin.
- Your pet must be carefully examined daily for any signs of a rash or sore.
- If a rash or sore is observed, discontinue the use of the Receiver Collar for a few days.
- If the condition persists beyond 48 hours, see your veterinarian.
- Your pet's neck and the Contact Points must be washed weekly with a wash cloth and mild hand soap, then rinsed thoroughly.

A condition called Pressure Necrosis, which is a devitalization of the skin due to excessive and prolonged contact against the Contact Points, may occur if the steps above are not followed.

To Re-Thread the Collar

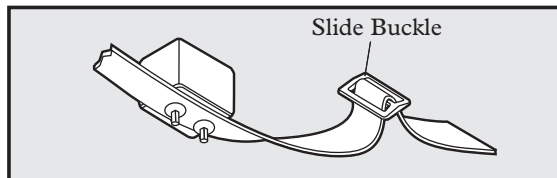

The slide buckle prevents the collar from becoming loose around your pet's neck.

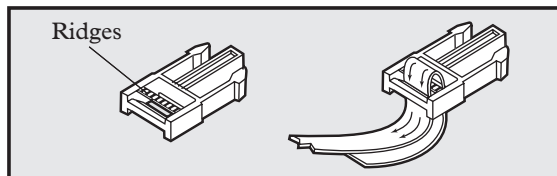

The ridges must be facing up; the collar will slip if it is not properly threaded.

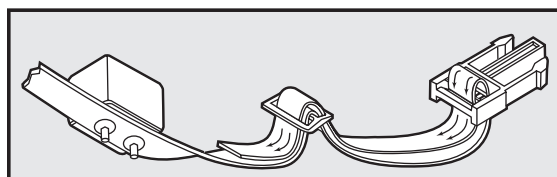

Training Guide

Be Patient With Your Pet

Important: Proper training of your pet is essential to the success of the PetSafe Wireless Pet Containment System™. Read this section completely before beginning to train your pet. Remember that the PetSafe Wireless Pet Containment System™ is not a solid barrier.

- Have fun with your pet throughout the training process. Training should be fun, fair, firm and consistent.
- Train for 10 to 15 minutes at a time. Don't try to do too much too quickly. More-frequent short sessions are better than less-frequent longer sessions.
- We suggest a minimum of 14 days of training. Depending on your pet and how he learns, the training could take more or less time.
- If your pet shows signs of stress, slow down the training schedule, add additional days of training, or increase the amount of play time with your pet in the Pet Area. Common stress signals include:
 - Pet pulling on leash toward the house
 - Ears tucked
 - Tail down
 - Body lowered
 - Nervous / frantic movement or stiffening of pet's body
- Your pet must be completely comfortable near the Boundary Flags at the end of every training session. Spend at least 5 minutes of "play time" at the completion of each session within 10 feet of the Boundary Flags.
- Finish each training session on a positive note with lots of praise and play.
- Remove the Receiver Collar after each training session.
- Be sure to contain your pet by another means during the training period (e.g. pen, tie-out, leash, etc.).
- During training, if you need to take your pet out of the Pet Area, remove the Receiver Collar and either pick your pet up or put him in the car to pass out of the Pet Area.
- Even if you think your pet is responding well to the training, complete the entire training. Reinforcement is important!

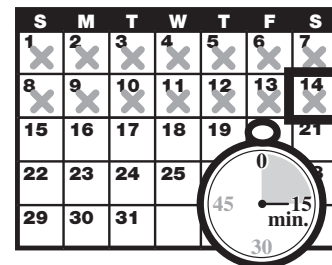

Phase

1

Day 1 - Boundary Flag Awareness

Perform three sessions on day 1, each training session lasting 10-15 minutes.

Goal:

To have your pet learn that the Boundary Flags and warning beep from the Receiver Collar define the new Pet Area.

Setup:

- Program the Static Correction Level on the Receiver Collar depending on the size and temperament of your pet.
- Put a separate non-metallic collar on your pet's neck ABOVE the Receiver Collar and attach a leash. *Note: Be sure the extra collar does not put pressure on the Contact Points.*
- Have tiny pieces of treats that your pet will find desirable available (hot dogs or lunch meat work well).
- Have your pet's favorite play toy available.

Steps:

1. Begin by walking your pet on a leash in the Pet Area. Calmly praise and talk to your pet, occasionally giving treats.
2. Move toward the Boundary Flags (1A). Keep your mood happy and throw treats to the ground.
3. With full control of your pet on a leash, toss a treat on the outside edge of the flags. As your pet enters the Boundary Zone to receive the treat, the receiver collar will begin to beep (1B). As your pet remains in the Boundary Zone, he will receive a mild Static Correction. Allow your pet to stay in the Boundary Zone for 2 seconds then gently help him back into the Pet Area (1C). Immediately praise and offer your pet a treat as he enters the Pet Area, even if you have helped with the leash. Wiggle a Boundary Flag to help your pet understand that the discomfort of the Static Correction happens around the flags.
4. Repeat this process at several different Boundary Flags. Your pet should start to resist going after the treat in the Boundary Zone. If your pet continues to enter the Boundary Zone, check the fit of his Receiver Collar and allow him 2-3 seconds in the zone before pulling him back to the Pet Area.

Note: Never allow your pet to eat the treat in the Boundary Zone.

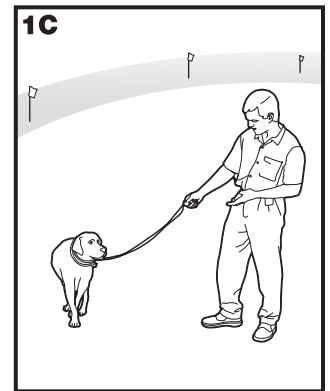
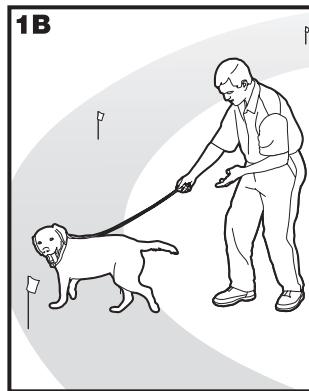
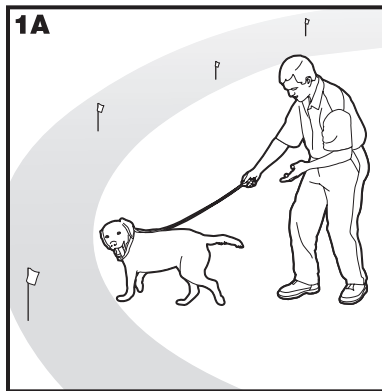

Phase 2 Days 2 thru 4 - Continue Boundary Flag Awareness

Perform three sessions per day, each lasting 10-15 minutes.

Goal:

To train your pet to stay in the Pet Area and respect the boundary while you are outside of it.

Setup:

- Program the Static Correction Level on the Receiver Collar depending on the size and temperament of your pet.
- Put a separate non-metallic collar on your pet's neck ABOVE the Receiver Collar and attach a leash. *Note: Be sure the extra collar does not put pressure on the Contact Points.*
- Have tiny pieces of treats available (hot dogs or lunch meat work well).
- Have your pet's favorite play toy available.

Steps:

1. Repeat steps 1-4 in Phase One
2. Drop the leash, leaving your pet in the Pet Area.
3. Walk outside the boundary and wiggle the Boundary Flags facing your pet.
4. Continue around the entire boundary doing this, tossing treats to your pet in the Pet Area and praising him.
5. If your pet does not respond to the Static Correction, increase the Static Correction Level by 1.

Phase 3 Days 5 thru 8 - Distraction Phase

Perform three training sessions per day, each lasting 10 to 15 minutes.

Goal:

To train your pet to stay within the Pet Area with distractions outside of the Pet Area.

Setup:

- Program the Static Correction Level on the Receiver Collar depending on the size and temperament of your pet.

- Put a separate non-metallic collar on your pet's neck ABOVE the Receiver Collar and attach a leash. *Note: Be sure the extra collar does not put pressure on the Contact Points.*
- Have tiny pieces of treats available (hot dogs or lunch meat work well).
- Have your pet's favorite play toy available.
- Create distractions to tempt your pet to enter the Boundary Zone, such as:
 - Have a family member cross from inside the Pet Area to outside of it.
 - Throw a ball outside of the Pet Area.
 - Have a neighbor walk their pet outside of the Pet Area.

Steps:

1. With full control of your pet on a leash, have the distraction presented.
2. If your pet does not move toward the distraction, praise and offer a treat.
3. If your pet does react to the distraction, allow him to go into the Boundary Zone.
4. Help your pet back into the Pet Area if he does not turn back after 3 seconds.
5. Treat and praise your pet anytime he comes back into the Pet Area with or without help.
6. Repeat this process with other distractions. Use other family members during this process.
7. If your pet does not respond to the Static Correction, increase the Static Correction Level by 1.

Phase 4 Days 9 thru 14 - Unleashed Supervision

4

Training sessions should start at 10-15 minutes, gradually increasing to over an hour.

Your pet is ready for this step only when he clearly avoids the entire Boundary Zone, regardless of any distractions or temptations. During this step, do not leave your pet unattended.

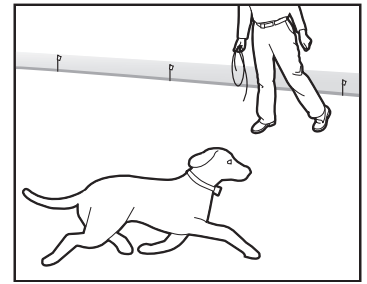

Goal:

To give your pet free run of the Pet Area off the leash.

Setup:

Adjust the Receiver Collar to the permanent setting appropriate for your pet depending on his size and temperament.

Steps:

1. Enter the Pet Area with your pet wearing the Receiver Collar.
2. Walk around the yard and play with your pet, staying within the Pet Area at all times.
3. Preoccupy yourself with another task in the yard while watching your pet.
4. Should your pet escape, take the Receiver Collar off or turn the system off at the Fence Transmitter and lead him back into the Pet Area.

Taking Your Pet Out of the Pet Area

Important: Remove the Receiver Collar and leave it in the Pet Area.

Once your pet learns the Boundary Zone, he will be reluctant to cross it for walks or car rides.

Option 1: Replace the Receiver Collar with a regular collar. Put your pet in a car that is within the Pet Area and drive him out of the Pet Area.

Option 2: Replace the Receiver Collar with a regular collar and leash. Walk your pet out of the Pet Area while giving a command such as "OK" at a specific place of the Boundary Zone (the end of your driveway, sidewalk, etc.). Always leave the Pet Area with a leash at this place and your pet will associate leaving the Pet Area only on a leash, only at this place, and only with a person. You may initially need to convince your pet to leave the Pet Area with a food treat and lots of praise.

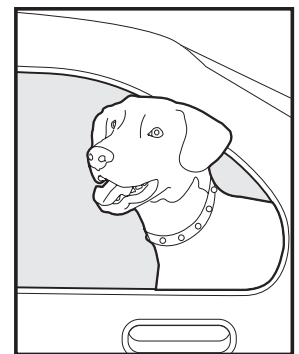

Note: You may also carry your pet out of the Pet Area.

Wireless - To - Go

Your PetSafe Wireless Pet Containment System™ is completely portable. Follow the set-up procedures (steps 1 through 4) wherever you wish to have containment of your pet. Reestablish the Pet Area and mark it with Boundary Flags so your pet knows his Boundary Zone. *Note: If setting up in a metal building or vehicle, the maximum size of the Pet Area may be reduced.* Be sure to remove the Receiver Collar battery before turning off the Transmitter. If you want to power the Transmitter from a car or other DC source, use an inverter rated for 50 watts or more.

Accessories

To purchase additional accessories for your PetSafe Wireless Pet Containment System™, contact the Customer Care Center at 1-800-732-2677 or visit our website at www.petsafe.net to locate a retailer near you.

Component	Part Number
Battery - two pack	RFA-67D-11
Extra Receiver Collar	IF-275
Power Adapter	300-089
Replacement Collar	RFA-48
Extra Flags	RFA-2
Extra Wireless Transmitter	IF-100
Accessory Pack	RFA-135
Battery Back-up	RFA-157

Frequently Asked Questions

Is the Receiver Collar waterproof?	<ul style="list-style-type: none">• Yes. When changing the battery, be sure to keep the battery area free from dirt and debris.
Will the PetSafe Wireless Pet Containment System™ cover a larger circle than 180 feet across?	<ul style="list-style-type: none">• You can use another Wireless Transmitter with overlapping boundaries of at least 5-10 feet to get a larger Pet Area.
Will a sloping yard affect the Pet Area?	<ul style="list-style-type: none">• The Transmitter signal extends 90 feet in all directions. A sloping yard can cause the Pet Area to appear less or more than expected. Consider repositioning the Transmitter to maximize your Pet Area.
Can I use more than one Receiver Collar with the Wireless System?	<ul style="list-style-type: none">• Yes. There is no limit to the number of pets you can contain with the Wireless System. You must purchase an additional Receiver Collar for each pet. Contact the Customer Care Center at 1-800-732-2677 or visit our website at www.petsafe.net to locate a retailer near you.
Will the Wireless System keep other pets out of my yard?	<ul style="list-style-type: none">• No. The Wireless System is only effective on pets who wear the Receiver Collar.
Is there a hand-held remote Transmitter that will work with the Wireless System Receiver Collar?	<ul style="list-style-type: none">• No. You would need to purchase a separate Remote Training System. Contact the Customer Care Center at 1-800-732-2677 or visit our website at www.petsafe.net to locate a retailer near you.
Is there a smaller Receiver Collar or another compatible Receiver Collar that I can use with the Wireless Transmitter?	<ul style="list-style-type: none">• No. Contact the Customer Care Center at 1-800-732-2677 or visit our website at www.petsafe.net for additional ideas or solutions.
If I have a question about my Wireless System or need replacement parts, where can I get answers or service?	<ul style="list-style-type: none">• Contact the Customer Care Center at 1-800-732-2677 or visit our website at www.petsafe.net.

Can I use the Wireless System on an aggressive pet?	<ul style="list-style-type: none"> • We do not recommend using any electronic training devices on aggressive pets. If you are unsure if your dog is aggressive, please consult your veterinarian or a certified trainer.
Can I use the Wireless System on a cat?	<ul style="list-style-type: none"> • The Wireless System can be used as long as the cat can comfortably wear the Receiver Collar.
What happens if the power goes out?	<ul style="list-style-type: none"> • The Wireless System is designed to recognize power outages and shuts down without activating the Receiver Collar. However, if your pet is near the Boundary Zone during the power failure, he may receive a Static Correction. To lessen this chance, you may consider an RFA-157 battery back-up device for the Transmitter if your area experiences frequent power outages. Contact the Customer Care Center at 1-800-723-2677 or visit our website at www.petsafe.net to locate a retailer near you.
What if I lose the clear plastic cover for the Correction Level Button?	<ul style="list-style-type: none"> • The clear plastic cover prohibits the Static Correction Level from accidentally being changed and also helps keep the Receiver waterproof. Contact the Customer Care Center at 1-800-732-2677 for a replacement.
If my pet leaves the Pet Area, how long will he be corrected?	<ul style="list-style-type: none"> • Your pet will receive Static Correction as long as he is outside the Pet Area, for up to 30 seconds. The Receiver Collar has a safety time-out to stop correcting and beeping after 30 seconds until it is returned to the Pet Area.
How often do I need to replace the Receiver Collar battery?	<ul style="list-style-type: none"> • Battery life depends on how frequently your pet tests the Boundary Zone. The Receiver Indicator Light acts as a low battery indicator, flashing every 4 to 5 seconds when replacement is required.
Can I place the Receiver on another collar?	<ul style="list-style-type: none"> • Yes, any non-metallic collar. Make 2 holes in the collar to attach the Receiver. Use the collar in the kit as a template to locate the holes on the new collar.
Do I need to perform maintenance on my Wireless System?	<ul style="list-style-type: none"> • Check your pet's neck daily for irritation from the Contact Points. • Check the Contact Points on the Receiver Collar weekly to make sure they are tight and clean. • Check the fit of the Receiver Collar weekly. • The Receiver Indicator Light acts as a low battery indicator, flashing every 4 to 5 seconds when replacement is required.
How do I know the battery in the Receiver Collar is still working?	<ul style="list-style-type: none"> • Take the Receiver Collar off your pet and walk into the Boundary Zone. The Receiver Collar should beep. If not, replace the battery.
Will buildings and landscape features (trees, shrubs, etc.) affect the performance of the Wireless System?	<ul style="list-style-type: none"> • No. However, placing the Transmitter inside a metal building or vehicle can reduce the maximum range of the Wireless System.
What do I do if my pet's neck becomes red and irritated?	<ul style="list-style-type: none"> • This condition is due to the Contact Points irritating the skin. Discontinue use of the Receiver Collar for a few days. If the condition persists beyond 48 hours, see your veterinarian. Once the skin returns to normal, replace the Receiver Collar and monitor the skin condition closely.
Can I attach a leash to the Receiver Collar?	<ul style="list-style-type: none"> • No. This can result in pulling the Contact Points too tightly against your pet's neck. Attach a leash to a separate, non-metallic collar positioned above the Receiver Collar.
Why does my Receiver Collar have a beep only mode?	<ul style="list-style-type: none"> • The beep only mode can be used in training your pet to his boundary or for well-trained pets that no longer require Static Correction.

Troubleshooting

<p>The Receiver Collar is not beeping when setting up the Boundary Zone.</p>	<ul style="list-style-type: none"> • The beep may be difficult to hear in a noisy environment. • Install Test Light as explained in the “Test Light Instructions” section, and use it to determine the location of Boundary Zone. • Check that the Transmitter is set up according to directions and install a new battery within 5 feet of the Transmitter.
<p>The Receiver Collar is not beeping or administering a Static Correction.</p>	<ul style="list-style-type: none"> • Check that the Transmitter is plugged into a working 120-volt outlet, turned on, the Power Light is on, and the Transmitter controls are set at your desired settings. • Check Receiver battery to make sure it is installed properly. • When replacing the battery, do so within 5 feet of the Transmitter.
<p>The Receiver Collar is beeping everywhere.</p>	<ul style="list-style-type: none"> • Check that the Transmitter is plugged into a working standard 120-volt outlet, turned on, the Power Light is on, and the Transmitter controls are set at your desired settings. • Bring Receiver Collar within 5 feet of the Transmitter to reset.
<p>The Receiver Collar is beeping inside the house.</p>	<ul style="list-style-type: none"> • Make sure the Transmitter is on and set up according to the directions. • Ensure the entire house is within the Pet Area. The Transmitter may need to be moved to adjust the Pet Area to include the entire house. • If relocating the Transmitter, remove the Receiver Collar from your pet before turning the Transmitter off.
<p>The Boundary Zone seems to fluctuate.</p>	<ul style="list-style-type: none"> • This is normal for the electro-magnetic field of the Wireless System. The field may be affected by surrounding “electronic noise,” which can cause it to fluctuate up to 5%. • Where the Receiver Collar activates is influenced by the speed and orientation of the Receiver Collar as your pet enters the Boundary Zone.
<p>The Receiver Collar activates in the middle of the yard.</p>	<ul style="list-style-type: none"> • The Receiver Collar activates when it loses the Transmitter signal. This sometimes occurs if a large metal object is between the Receiver Collar and Transmitter, if the orientation of the Receiver Collar changes near the Boundary Zone, or if the surrounding “electronic noise” interferes with the signal. If this continues to occur, consider relocating the Transmitter and resetting the Pet Area.
<p>The Receiver Collar is beeping but my pet is not responding to the Static Correction.</p>	<ul style="list-style-type: none"> • Make sure the Static Correction Level is set at 2 or above. • Test the Receiver Collar with the Test Light. • If the Test Light flashes, check the fit of the Receiver Collar. • Trim your pet’s fur where the Contact Points touch the neck and/or switch to the longer Contact Points. • Increase the Static Correction Level. • Repeat training steps to reinforce training.
<p>My pet reacts strongly to the Static Correction and has become fearful.</p>	<ul style="list-style-type: none"> • Lower the Static Correction Level. • Make sure you are in control of the situation when your pet receives his first Static Corrections (have him on a leash attached to a separate, non-metallic collar) and lead him into the Pet Area and praise him. If your pet remains fearful, suspend training and start again the next day. Make sure to end all training sessions on a positive note with lots of praise and play.
<p>The Power Light is not on.</p>	<ul style="list-style-type: none"> • Make sure the Transmitter On/Off Switch is on and the Power Adapter is plugged into the Transmitter and a working standard 120-volt outlet.
<p>I was setting up the Pet Area and after I turned down the Boundary Control Dial, the Receiver Collar would no longer beep or correct.</p>	<ul style="list-style-type: none"> • You may have turned the Boundary Control Dial down too quickly, causing the Receiver Collar to go into power-fail mode. This is a safety feature designed to protect your pet when power to the Transmitter goes out. With the Receiver Collar within 5 feet of the Transmitter, turn the Boundary Control Dial to “8” and reset the Boundary Zone, making sure to turn the dial down slowly.

Test Light Instructions

Important: Remove Test Light before placing Receiver Collar on your pet.

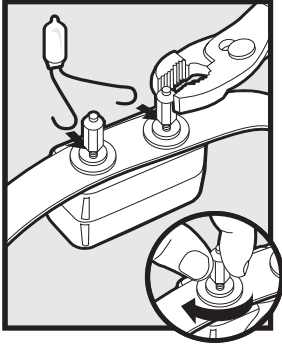

1. Set Receiver Collar to Static Correction Level 4.
2. Remove the battery.
3. Loosen the Contact Points with pliers.
4. Bend the leads around the base of each Contact Point.
5. Hand tighten the Contact Points, making sure that the leads stay in contact with the bases of the Contact Points.
6. Replace the battery.
7. The Test Light will flash in the Boundary Zone if the Receiver Collar is working properly.
8. Remove the Test Light and tighten the Contact Points with pliers one-half turn beyond finger tight. Save the Test Light for future testing.

Note: If the Test Light does not flash, install a new battery and re-test. If Test Light still does not flash, contact the Customer Care Center at 1-800-732-2677.

Terms of Use and Limitation of Liability

1. Terms of Use

This Product is offered to you conditioned upon your acceptance without modification of the terms, conditions and notices contained herein. Usage of this Product implies acceptance of all such terms, conditions, and notices.

2. Proper Use

This Product is designed for use with pets where training is desired. The specific temperament of your pet may not work with this Product. We recommend that you not use this Product if your pet is less than 8 pounds or if your pet is aggressive. If you are unsure whether this is appropriate for your pet please consult your veterinarian or certified trainer.

Proper use includes reviewing the entire Guide provided with your Product and any specific Caution statements.

3. No Unlawful or Prohibited Use

This Product is designed for use with pets only. This pet training device is not intended to harm, injure or provoke. Using this Product in a way that is not intended could result in violation of Federal, State or local laws.

4. Limitation of Liability

In no event shall Radio Systems Corporation be liable for any direct, indirect, punitive, incidental, special or consequential damages, or any damages whatsoever arising out of or connected with the use or misuse of this Product. Buyer assumes all risks and liability from the use of this Product.

5. Modification of Terms and Conditions

Radio Systems Corporation reserves the right to change the terms, conditions and notices under which this Product is offered.

FCC

NOTE: This equipment has been tested and found to comply with the limits for a Class B digital device, pursuant to Part 15 of the FCC Rules. These limits are designed to provide reasonable protection against harmful interference in a residential installation. This equipment generates, uses and can radiate radio frequency energy and, if not installed and used in accordance with the instructions, may cause harmful interference to radio communications.

However, there is no guarantee that interference will not occur in a particular installation. If this equipment does cause harmful interference to radio or television reception, which can be determined by turning the equipment off and on, the user is encouraged to try to correct the interference by one or more of the following measures:

- Reorient or relocate the receiving antenna.
- Increase the separation between the equipment and receiver.
- Connect the equipment into an outlet on a circuit different from that to which the receiver is connected.
- Consult the dealer or an experienced radio/TV technician for help.

Changes or modifications not expressly approved by the PetSafe could void the user's authority to operate the equipment.

Electro Magnetic Field Warning Statement

The Wireless System Transmitter emits an electro magnetic field (EMF) similar to many household appliances. The Transmitter emits EMF at 3 feet equivalent to a television at 1 foot. While there are no laws or conclusive studies on EMF, Radio Systems Corporation recommends taking the following precaution: We advise consumers to place the Transmitter away from places where they would be within 3 feet of the unit for prolonged periods, such as next to a bed. Recommended locations include closets or a garage.

Caution

The PetSafe Wireless Pet Containment System™ is NOT a solid barrier. The system is designed to act as a deterrent to remind pets by Static Correction to remain in the boundary established. It is important that you reinforce training with your pet on a regular basis. Since the tolerance level to Static Correction varies from pet to pet, Radio Systems Corporation CANNOT guarantee that the system will, in all cases, keep a pet within the established boundary. Not all pets can be trained to avoid crossing the boundary! Therefore, if you have reason to believe that your pet may pose a danger to others or harm himself if he is not kept from crossing the boundaries, you should NOT rely solely upon the PetSafe Wireless Pet Containment System™ to confine your pet. Radio Systems Corporation shall NOT be liable for any property damage, economic loss or any consequential damages, sustained as a result of any animal crossing the boundary.

Radio Systems Corporation
10427 Electric Avenue
Knoxville, TN 37932
1-800-732-2677
www.petsafe.net
400-650/2

©Copyright 2004

Radio Systems Corporation

Mounting Template

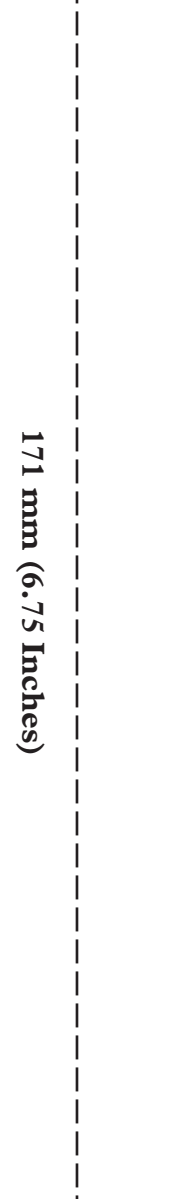

171 mm (6.75 Inches)