



Hermon Laboratories Ltd.
P.O. Box 23, Binyamina 3055001, Israel
Tel. +972 4628 8001
Fax. +972 4628 8277
E-mail: mail@hermonlabs.com

TEST REPORT

ACCORDING TO: FCC CFR 47 Part 15 subpart C, section 15.231;
RSS-210 issue 9 Annex A

FOR:

Paradox Security Systems Ltd.
Wireless Expansion Module
Model:RTX3
FCC ID:KDYRTX3
IC:2438A-RTX3

This report is in conformity with ISO/IEC 17025. The "A2LA Accredited" symbol endorsement applies only to the tests and calibrations that are listed in the scope of Hermon Laboratories accreditation. The test results relate only to the items tested. This test report shall not be reproduced in any form except in full with the written approval of Hermon Laboratories Ltd.

Table of contents

1	Applicant information	3
2	Equipment under test attributes	3
3	Manufacturer information	3
4	Test details	3
5	Tests summary	4
6	EUT description	5
6.1	General information	5
6.2	Ports and lines	5
6.3	Test configuration	5
6.4	Changes made in EUT	5
6.5	Transmitter characteristics	6
7	Transmitter tests according to 47CFR part 15 subpart C requirements	7
7.1	Periodic operation requirements	7
7.2	Field strength of emissions	11
7.3	Occupied bandwidth test	23
7.4	Conducted emissions	26
7.5	Antenna requirements	29
8	APPENDIX A Test equipment and ancillaries used for tests	30
9	APPENDIX B Measurement uncertainties	31
10	APPENDIX C Test laboratory description	32
11	APPENDIX D Specification references	32
12	APPENDIX E Test equipment correction factors	33
13	APPENDIX F Abbreviations and acronyms	39
14	APPENDIX G Manufacturer's declaration about periodic operation	40

1 Applicant information

Client name: Paradox Security Systems Ltd.
Address: 780 Industrial Boulevard St.Eustache, Quebec J7R 5V3 Canada
Telephone: 450-491-7444
Fax: 450-497-1095
E-mail: alexc@paradox.com
Contact name: Mr. Alex Chaplik

2 Equipment under test attributes

Product name: Wireless Expansion Module
Product type: Transceiver
Model(s): RTX3
Serial number: 3B301229
Hardware version: 333-7007-030
Software release: V6.20
Receipt date: 14-Dec-18

3 Manufacturer information

Manufacturer name: Paradox Security Systems Ltd.
Address: 780 Industrial Boulevard St.Eustache, Quebec J7R 5V3 Canada
Telephone: 450-491-7444
Fax: 450-497-1095
E-Mail: alexc@paradox.com
Contact name: Mr. Alex Chaplik



4 Test details

Project ID: 31843
Location: Primary: Hermon Laboratories Ltd. P.O. Box 23, Binyamina 3055001, Israel
Satellite: Hermon Laboratories Ltd. Hefetz-Haim 10, Tel Aviv 6744124, Israel
Test started: 14-Dec-18
Test completed: 28-Feb-19
Test specification(s): FCC 47CFR part 15, subpart C, §15.231;
RSS-210 issue 9 Annex A

5 Tests summary

Test	Status
Transmitter characteristics	
FCC Part 15, Section 231(a) / RSS-210, Section A1.1, Periodic operation requirements	Pass
FCC Part 15, Section 231(a) / RSS-210, Section A1.2, Field strength of emissions	Pass
FCC Part 15, Section 231(c) / RSS-210, Section A1.3, Occupied bandwidth	Pass
FCC Part 15, Section 207 / RSS-Gen, Section 8.8, Conducted emission	Pass
FCC Part 15, Section 203 / RSS-Gen, Section 6.8, Antenna requirements	Pass

Testing was completed against all relevant requirements of the test standard. The results obtained indicate that the product under test complies in full with the requirements tested.
The test results relate only to the items tested. Pass/ fail decision was based on nominal values.

	Name and Title	Date	Signature
Tested by:	Mrs. E.Pitt, test engineer	February 28, 2019	
Reviewed by:	Mrs. M. Cherniavsky, certification engineer	April 3, 2019	
Approved by:	Mr. K. Zushchuk, Projects & Customer Manager, EMC & Radio	April 10, 2019	



6 EUT description

6.1 General information

The EUT, RTX3, is a 2-way, 32 zone wireless expansion module which enables EVO and SP Series control panels to support wireless hardware such as sirens, motion detectors, water detectors, and remote controls.

The RTX3 is designed to be powered by 12 VDC from the control panel. It has 4 terminals connector (RED/BLK/GRN/YEL) and connected to control panel by Paradox BUS.

6.2 Ports and lines

Port type	Port description	Connected from	Connected to	Qty.	Cable type	Cable length, m
Signal	Data	EUT	Control panel	4	Unshielded	3

6.3 Test configuration

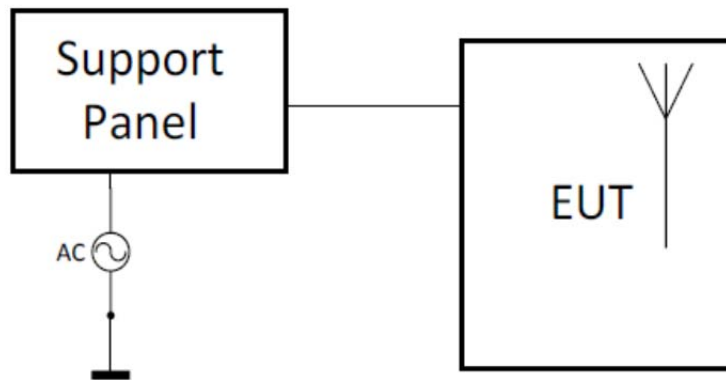

6.4 Changes made in EUT

No changes were implemented in the EUT during testing.



6.5 Transmitter characteristics

Type of equipment				
X	Stand-alone (Equipment with or without its own control provisions)			
	Combined equipment (Equipment where the radio part is fully integrated within another type of equipment)			
	Plug-in card (Equipment intended for a variety of host systems)			
Operating frequency		433.92 MHz		
Maximum rated output power		At transmitter 50 Ω RF output connector		
		Field strength at 3 m distance	86.86 dB(μV/m) – peak 75.49 dB(μV/m) -average	
Is transmitter output power variable?		X	No	
		Yes	continuous variable	
			stepped variable with stepsize	dB
			minimum RF power	dBm
	maximum RF power	dBm		
Antenna connection				
unique coupling	standard connector	X	integral	
			with temporary RF connector	
			X without temporary RF connector	
Antenna/s technical characteristics				
Type	Manufacturer	Model number	Gain	
Integral	FORESIGHT INT. Ltd.	125-0433-405	0 dBi	
Transmitter aggregate data rate/s		1.66 kbps		
Type of modulation		OOK		
Modulating test signal (baseband)		ID code		
Transmitter power source				
	Battery	Nominal rated voltage	VDC	
X	DC	Nominal rated voltage	12 VDC (obtained from Control Panel connected to 120 VAC)	
	AC mains	Nominal rated voltage	Frequency	
Common power source for transmitter and receiver		X	yes	
			no	



Test specification: FCC Part 15, Section 231(a) / RSS-210, Section A1.1, Periodic operation requirements			
Test procedure: Supplier declaration			
Test mode: Compliance		Verdict: PASS	
Date(s): 28-Feb-19			
Temperature: 23 °C	Relative Humidity: 43 %	Air Pressure: 1010 hPa	Power: 12 VDC
Remarks:			

7 Transmitter tests according to 47CFR part 15 subpart C requirements

7.1 Periodic operation requirements

7.1.1 General

The EUT was verified for compliance with periodic operation requirements listed below:

- Continuous transmissions such as voice, video and the radio control of toys are not permitted;
- A manually operated transmitter shall employ switch that will automatically deactivate the transmitter within not more than 5 seconds of being released;
- A transmitter activated automatically shall cease transmission within 5 seconds after activation;
- Periodic transmissions, excluding polling or supervision transmissions, at regular predetermined intervals are not permitted;
- Total duration of polling or supervision transmissions, including data, to determine system integrity in security or safety applications shall not exceed 2 seconds per hour;
- Transmission of set-up information for security systems may exceed the transmission duration limits of 5 seconds, provided such transmissions are under the control of a professional installer and do not exceed ten seconds after a manually operated switch is released or a transmitter is activated automatically. Such set-up information may include data.

The rationale for compliance with the above requirements was either test results or supplier declaration. The summary of results is provided in Table 7.1.1.

7.1.2 Test procedure for transmitter shut down test

7.1.2.1 The EUT was set up as shown in Figure 7.1.1.

7.1.2.2 The spectrum analyzer center frequency was adjusted to the EUT carrier, span set to zero and video triggered for transmission.

7.1.2.3 The transmitter was activated either manually or automatically. Once manually operated transmitter was activated, the switch was immediately released.

7.1.2.4 The transmission time was captured and shown in Plot 7.1.1.

7.1.3 Test procedure for measurements of polling / supervision transmission duration

7.1.3.1 The EUT was set up as shown in Figure 7.1.1.

7.1.3.2 The spectrum analyzer center frequency was adjusted to the EUT carrier, span set to zero and video triggered for transmission.

7.1.3.3 The transmission time was captured and shown in Plot 7.1.2, Plot 7.1.3.

Figure 7.1.1 Setup for transmitter shut down test





Test specification: FCC Part 15, Section 231(a) / RSS-210, Section A1.1, Periodic operation requirements			
Test procedure: Supplier declaration			
Test mode: Compliance		Verdict: PASS	
Date(s): 28-Feb-19			
Temperature: 23 °C	Relative Humidity: 43 %	Air Pressure: 1010 hPa	Power: 12 VDC
Remarks:			

Table 7.1.1 Periodic operation requirements

Requirement	Rationale	Verdict
Continuous transmissions are not permitted	Supplier declaration*	Comply
A manually operated transmitter shall be deactivated within not more than 5 seconds of switch being released	NA	NA
Transmitter activated automatically shall cease transmission within 5 seconds	Plot 7.1.1	Comply
Periodic transmissions at regular predetermined intervals are not permitted	Supplier declaration*	Comply
Total duration of polling or supervision transmissions shall not exceed 2 seconds per hour	Plot 7.1.2, Plot 7.1.3	Comply
Transmission of set-up information for security systems may exceed the transmission duration limits of 5 seconds, provided such transmissions are under the control of a professional installer and do not exceed ten seconds after a manually operated switch is released or a transmitter is activated automatically. Such set-up information may include data.	Supplier declaration	Comply

* Provided in Appendix G.

Plot 7.1.1 Transmission duration

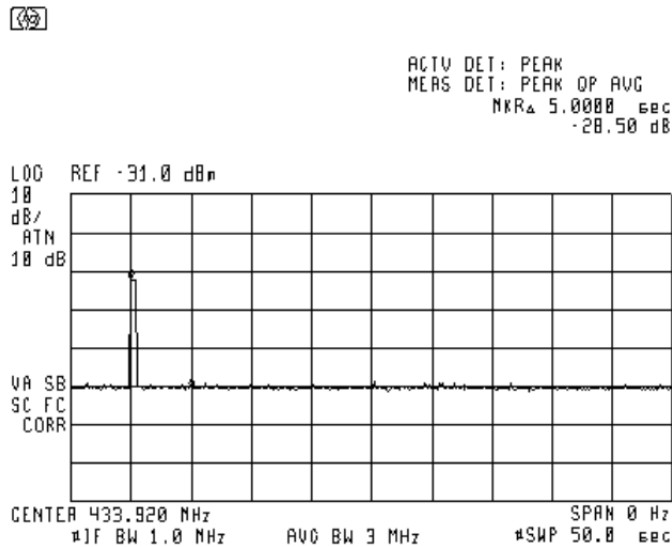



HERMON LABORATORIES

Test specification: FCC Part 15, Section 231(a) / RSS-210, Section A1.1, Periodic operation requirements			
Test procedure: Supplier declaration			
Test mode: Compliance		Verdict: PASS	
Date(s): 28-Feb-19			
Temperature: 23 °C	Relative Humidity: 43 %	Air Pressure: 1010 hPa	Power: 12 VDC
Remarks:			

Plot 7.1.2 Polling / supervision transmission duration

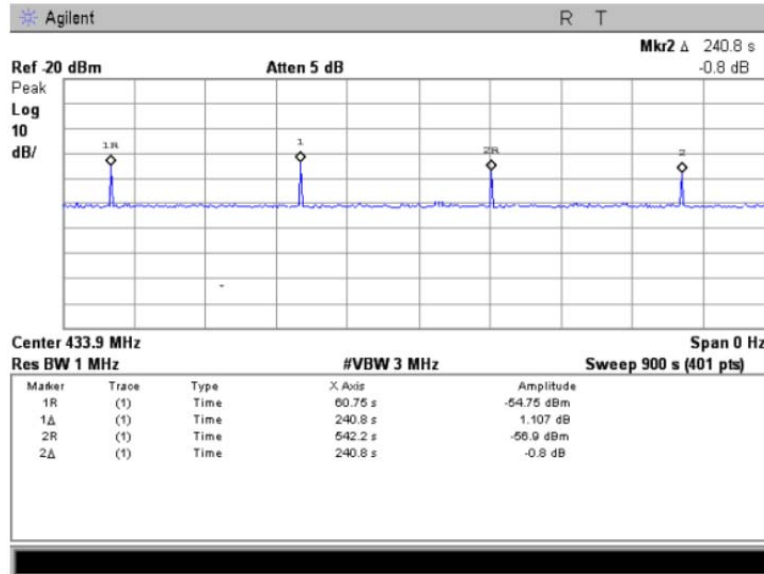

Plot 7.1.3 Polling / supervision pulse duration



ACTV DET: PEAK
MERS DET: PEAK QP AVG
MKRΔ 28.250 mSEC
.05 dB

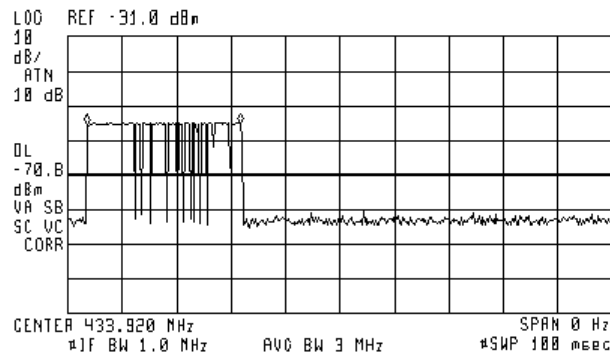



Test specification:	FCC Part 15, Section 231(a) / RSS-210, Section A1.1, Periodic operation requirements		
Test procedure:	Supplier declaration		
Test mode:	Compliance	Verdict:	PASS
Date(s):	28-Feb-19		
Temperature: 23 °C	Relative Humidity: 43 %	Air Pressure: 1010 hPa	Power: 12 VDC
Remarks:			

Table 7.1.2 Total duration of polling / supervision transmissions

Duration, ms	Repetition period, s	Maximum number of transmissions within 1 hour	Total duration within 1 hour, ms
28.25	240	15	423.75

Reference numbers of test equipment used

HL 4778							
---------	--	--	--	--	--	--	--

Full description is given in Appendix A.



Test specification: FCC Part 15, Section 231(b) / RSS-210, Section A1.2, Field strength of emissions			
Test procedure: ANSI C63.10 sections 6.5, 6.6			
Test mode: Compliance		Verdict: PASS	
Date(s): 14-Dec-18			
Temperature: 23 °C	Relative Humidity: 45 %	Air Pressure: 1008 hPa	Power: 12 VDC
Remarks:			

7.2 Field strength of emissions

7.2.1 General

This test was performed to measure field strength of fundamental and spurious emissions from the EUT. Specification test limits are given in Table 7.2.1 and Table 7.2.2.

Table 7.2.1 Radiated fundamental emission limits

Fundamental frequency, MHz	Field strength at 3 m, dB(μV/m)	
	Peak	Average
433.9185	100.8	80.8

Table 7.2.2 Radiated spurious emissions limits

Frequency, MHz	Field strength at 3 m, dB(μV/m)				
	Within restricted bands			Outside restricted bands	
	Peak	Quasi Peak	Average	Peak	Average
0.009 – 0.090	148.5 – 128.5	NA	128.5 – 108.5**	80.8	60.8
0.090 – 0.110	NA	108.5 – 106.8**	NA		
0.110 – 0.490	126.8 – 113.8	NA	106.8 – 93.8**		
0.490 – 1.705	NA	73.8 – 63.0**	NA		
1.705 – 30.0*		69.5			
30 – 88		40.0			
88 – 216		43.5			
216 – 960		46.0			
960 - 1000		54.0			
Above 1000	74.0	NA	54.0		

*- The limit for 3 m test distance was calculated using the inverse square distance extrapolation factor as follows:

$$Lim_{S_2} = Lim_{S_1} + 40 \log (S_1/S_2),$$

where S₁ and S₂ – standard defined and test distance respectively in meters.

** - The limit decreases linearly with the logarithm of frequency.

Note 1: The fundamental emission limit in dB(μV/m) was calculated as follows:

$$Lim_{AVR} = 20 \times \log(41.6667 \times F - 7083.3333) - \text{within } 260 - 470 \text{ MHz band,}$$

where F is the carrier frequency in MHz.

The limit for spurious emissions was 20 dB lower than fundamental emission limit.

The above limits provided in terms of average values, peak limit was 20 dB above the average limit.

Note 2: The above field strength limits applied from the lowest radio frequency generated in the device, without going below 9 kHz up to the tenth harmonic of the highest fundamental frequency.



Test specification: FCC Part 15, Section 231(b) / RSS-210, Section A1.2, Field strength of emissions			
Test procedure: ANSI C63.10 sections 6.5, 6.6			
Test mode: Compliance		Verdict: PASS	
Date(s): 14-Dec-18			
Temperature: 23 °C	Relative Humidity: 45 %	Air Pressure: 1008 hPa	Power: 12 VDC
Remarks:			

7.2.2 Test procedure for spurious emission field strength measurements in 9 kHz to 30 MHz band

7.2.2.1 The EUT was set up as shown in Figure 7.2.1, energized and the performance check was conducted.

7.2.2.2 The specified frequency range was investigated with antenna connected to spectrum analyzer/ EMI receiver. To find maximum radiation the turntable was rotated 360° and the measuring antenna was rotated around its vertical axis.

7.2.2.3 The worst test results (the lowest margins) were recorded in Table 7.2.3, Table 7.2.4, Table 7.2.5, Table 7.2.7 and shown in the associated plots.

7.2.3 Test procedure for spurious emission field strength measurements above 30 MHz

7.2.3.1 The EUT was set up as shown in Figure 7.2.2, Figure 7.2.3, energized and the performance check was conducted.

7.2.3.2 The specified frequency range was investigated with antenna connected to spectrum analyzer/ EMI receiver. To find maximum radiation the turntable was rotated 360°, the measuring antenna height was changed from 1 to 4 m, its polarization was switched from vertical to horizontal.

7.2.3.3 The worst test results (the lowest margins) were recorded in Table 7.2.3, Table 7.2.4, Table 7.2.5, Table 7.2.7 and shown in the associated plots.

Figure 7.2.1 Setup for spurious emission field strength measurements below 30 MHz

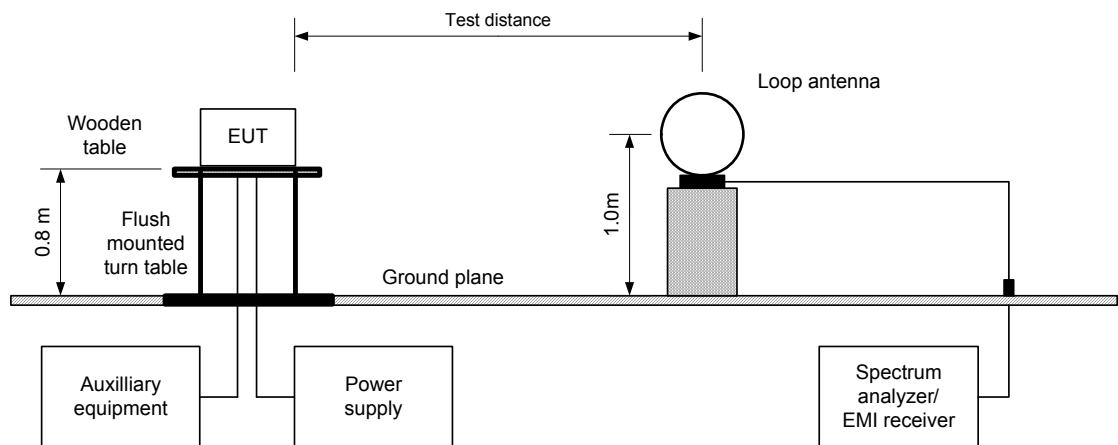



Test specification: FCC Part 15, Section 231(b) / RSS-210, Section A1.2, Field strength of emissions			
Test procedure: ANSI C63.10 sections 6.5, 6.6			
Test mode: Compliance		Verdict: PASS	
Date(s): 14-Dec-18			
Temperature: 23 °C	Relative Humidity: 45 %	Air Pressure: 1008 hPa	Power: 12 VDC
Remarks:			

Figure 7.2.2 Setup for spurious emission field strength measurements in 30 -1000 MHz

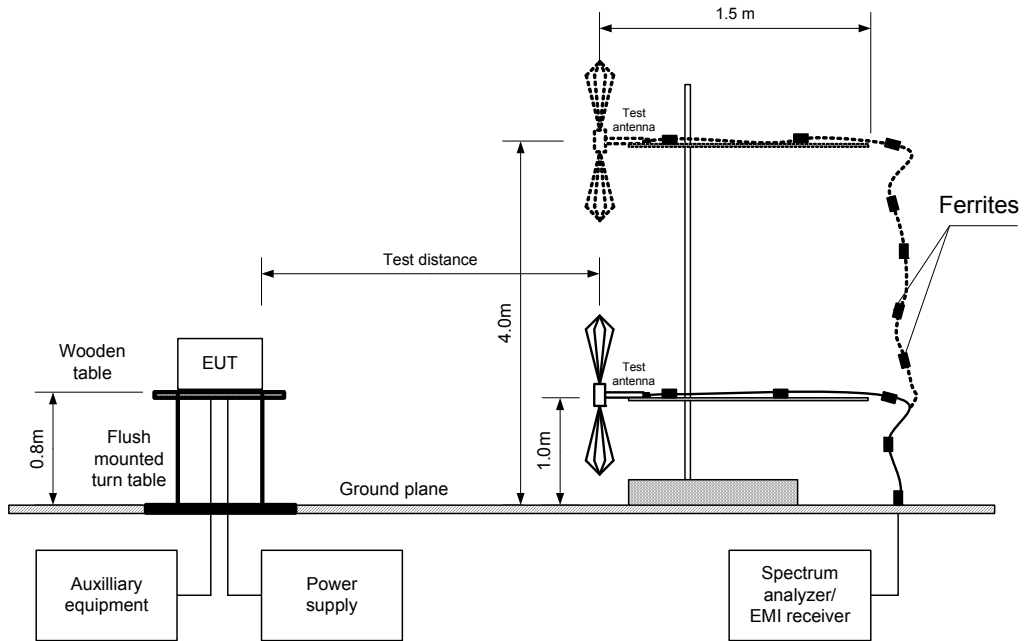
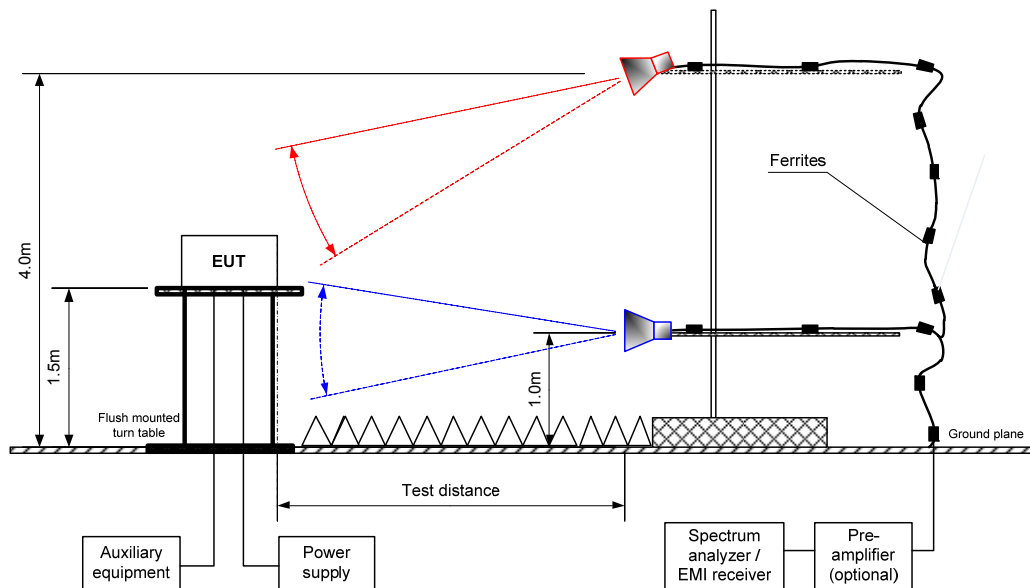

Figure 7.2.3 Setup for spurious emission field strength measurements above 1000 MHz





Test specification: FCC Part 15, Section 231(b) / RSS-210, Section A1.2, Field strength of emissions			
Test procedure: ANSI C63.10 sections 6.5, 6.6			
Test mode: Compliance		Verdict: PASS	
Date(s): 14-Dec-18			
Temperature: 23 °C	Relative Humidity: 45 %	Air Pressure: 1008 hPa	Power: 12 VDC
Remarks:			

Table 7.2.3 Field strength of fundamental emission, spurious emissions outside restricted bands below 1 GHz

TEST DISTANCE: 3 m
 EUT POSITION: Typical (Vertical)
 MODULATION: OOK
 BIT RATE: 1.66 kbps
 INVESTIGATED FREQUENCY RANGE: 0.009 – 4500 MHz
 DETECTOR USED: Peak
 RESOLUTION BANDWIDTH: 1.0 kHz (9 kHz – 150 kHz)
 9.0 kHz (150 kHz – 30 MHz)
 120 kHz (30 MHz – 1000 MHz)
 1.0 MHz (above 1000 MHz)
 VIDEO BANDWIDTH: ≥ Resolution bandwidth
 TEST ANTENNA TYPE: Active loop (9 kHz – 30 MHz)
 Biconilog (30 MHz – 1000 MHz)

F, MHz	Antenna		Azimuth, degrees*	Peak field strength			Average field strength				Verdict
	Pol.	Height, m		Measured, dB(μV/m)	Limit, dB(μV/m)	Margin, dB**	Measured, dB(μV/m)	Calculated, dB(μV/m)	Limit, dB(μV/m)	Margin, dB**	
Fundamental emission***											
433.92	V	1.0	-130	86.86	100.8	-13.94	86.86	75.49	80.8	-5.31	Pass
Spurious emissions											
36.29	V	1.0	-180	38.99	80.8	-41.81	35.80	35.80	60.8	-25.00	Pass
61.31	V	1.0	-180	26.61	80.8	-54.19	25.44	25.44	60.8	-35.36	
867.9	V	1.0	-150	32.70	80.8	-48.10	32.70	21.72	60.8	-39.08	

*- EUT front panel refers to 0 degrees position of turntable.
 **- Margin, dB =Measured (calculated) value, dB(μV/m)-Limit, dB(μV/m)

Table 7.2.4 Field strength of spurious emissions outside restricted bands above 1 GHz

TEST DISTANCE: 3 m
 EUT POSITION: Typical
 MODULATION: OOK
 BIT RATE: 1.66 kbps
 INVESTIGATED FREQUENCY RANGE: 0.009 – 4500 MHz
 DETECTOR USED: Peak
 RESOLUTION BANDWIDTH: 1.0 kHz (9 kHz – 150 kHz)
 9.0 kHz (150 kHz – 30 MHz)
 120 kHz (30 MHz – 1000 MHz)
 1.0 MHz (above 1000 MHz)
 VIDEO BANDWIDTH: ≥ Resolution bandwidth
 TEST ANTENNA TYPE: Double ridged guide (above 1000 MHz)

F, MHz	Antenna		Azimuth, degrees*	Peak field strength			Average field strength				Verdict
	Pol.	Height, m		Measured, dB(μV/m)	Limit, dB(μV/m)	Margin, dB**	Measured, dB(μV/m)	Calculated, dB(μV/m)	Limit, dB(μV/m)	Margin, dB**	
1735.69	V	1.1	-160	36.71	80.8	-44.09	36.71	25.34	60.8	-35.46	Pass
3471.45	H	1.8	-146	44.96	80.8	-35.84	44.96	33.59	60.8	-27.21	

*- EUT front panel refers to 0 degrees position of turntable.
 **- Margin, dB =Measured (calculated) value, dB(μV/m)-Limit, dB(μV/m)



Test specification: FCC Part 15, Section 231(b) / RSS-210, Section A1.2, Field strength of emissions			
Test procedure: ANSI C63.10 sections 6.5, 6.6			
Test mode: Compliance		Verdict: PASS	
Date(s): 14-Dec-18			
Temperature: 23 °C	Relative Humidity: 45 %	Air Pressure: 1008 hPa	Power: 12 VDC
Remarks:			

Table 7.2.5 Spurious emissions within restricted bands at frequencies above 1 GHz

TEST DISTANCE: 3 m
 EUT POSITION: Typical
 MODULATION: OOK
 BIT RATE: 1.66 kbps
 INVESTIGATED FREQUENCY RANGE: 0.009 – 4500 MHz
 DETECTOR USED: Peak
 RESOLUTION BANDWIDTH: 1.0 kHz (9 kHz – 150 kHz)
 9.0 kHz (150 kHz – 30 MHz)
 120 kHz (30 MHz – 1000 MHz)
 1.0 MHz (above 1000 MHz)
 VIDEO BANDWIDTH: ≥ Resolution bandwidth
 TEST ANTENNA TYPE: Double ridged guide (above 1000 MHz)

F, MHz	Antenna		Azimuth, degrees*	Peak field strength			Average field strength				Verdict
	Pol.	Height, m		Measured, dB(μV/m)	Limit, dB(μV/m)	Margin, dB**	Measured, dB(μV/m)	Calculated, dB(μV/m)	Limit, dB(μV/m)	Margin, dB**	
1301.77	V	1.0	-157	35.76	74.00	-38.24	35.76	24.78	54.0	-29.22	Pass
4354.35	H	2.6	12	42.79	74.00	-31.21	42.79	31.81	54.0	-22.19	

*- EUT front panel refers to 0 degrees position of turntable.

** - Margin, dB = Measured (calculated) value, dB(μV/m) - Limit, dB(μV/m)

Table 7.2.6 Average factor calculation

Transmission pulse		Transmission burst		Transmission train duration, ms	Average factor, dB
Duration, ms	Period, ms	Duration, ms	Period, ms		
28.25	100	NA	NA	NA	-10.98

AVR Factor = 20 Log (28.25/100) = -10.98 dB



Test specification: FCC Part 15, Section 231(b) / RSS-210, Section A1.2, Field strength of emissions			
Test procedure: ANSI C63.10 sections 6.5, 6.6			
Test mode: Compliance		Verdict: PASS	
Date(s): 14-Dec-18			
Temperature: 23 °C	Relative Humidity: 45 %	Air Pressure: 1008 hPa	Power: 12 VDC
Remarks:			

Table 7.2.7 Field strength of emissions below 1 GHz within restricted bands

TEST DISTANCE: 3 m
 EUT POSITION: Typical
 MODULATION: OOK
 BIT RATE: 1.66 kbps
 INVESTIGATED FREQUENCY RANGE: 0.009 – 1000 MHz
 DETECTOR USED: Peak
 RESOLUTION BANDWIDTH: 1.0 kHz (9 kHz – 150 kHz)
 9.0 kHz (150 kHz – 30 MHz)
 120 kHz (30 MHz – 1000 MHz)
 VIDEO BANDWIDTH: ≥ Resolution bandwidth
 TEST ANTENNA TYPE: Active loop (9 kHz – 30 MHz)
 Biconilog (30 MHz – 1000 MHz)

Frequency, MHz	Peak emission, dB(µV/m)	Quasi-peak			Antenna polarization	Antenna height, m	Turn-table position**, degrees	Verdict
		Measured emission, dB(µV/m)	Limit, dB(µV/m)	Margin, dB*				
All signals below limit at least 20 dB								Pass

*- Margin = Measured emission - specification limit.
 **- EUT front panel refer to 0 degrees position of turntable.

Reference numbers of test equipment used

HL 0446	HL 4360	HL 4933	HL 5288	HL 5405	HL 3903	HL 3339	HL 4339
---------	---------	---------	---------	---------	---------	---------	---------

Full description is given in Appendix A.



Test specification: FCC Part 15, Section 231(b) / RSS-210, Section A1.2, Field strength of emissions			
Test procedure: ANSI C63.10 sections 6.5, 6.6			
Test mode: Compliance		Verdict: PASS	
Date(s): 14-Dec-18			
Temperature: 23 °C	Relative Humidity: 45 %	Air Pressure: 1008 hPa	Power: 12 VDC
Remarks:			

Table 7.2.8 Restricted bands according to FCC 15, Section 205

MHz	MHz	MHz	MHz	MHz	GHz
0.09 - 0.11	8.37625 - 8.38675	73 - 74.6	399.9 - 410	2690 - 2900	10.6 - 12.7
0.495 - 0.505	8.41425 - 8.41475	74.8 - 75.2	608 - 614	3260 - 3267	13.25 - 13.4
2.1735 - 2.1905	12.290 - 12.293	108 - 121.94	960 - 1240	3332 - 3339	14.47 - 14.5
4.125 - 4.128	12.51975 - 12.52025	123 - 138	1300 - 1427	3345.8 - 3358	15.35 - 16.2
4.17725 - 4.17775	12.57675 - 12.57725	149.9 - 150.05	1435 - 1626.5	3600 - 4400	17.7 - 21.4
4.20725 - 4.20775	13.36 - 13.41	156.52475 - 156.52525	1645.5 - 1646.5	4500 - 5150	22.01 - 23.12
6.215 - 6.218	16.420 - 16.423	156.7 - 156.9	1660 - 1710	5350 - 5460	23.6 - 24
6.26775 - 6.26825	16.69475 - 16.69525	162.0125 - 167.17	1718.8 - 1722.2	7250 - 7750	31.2 - 31.8
6.31175 - 6.31225	16.80425 - 16.80475	167.72 - 173.2	2200 - 2300	8025 - 8500	36.43 - 36.5
8.291 - 8.294	25.5 - 25.67	240 - 285	2310 - 2390	9000 - 9200	Above 38.6
8.362 - 8.366	37.5 - 38.25	322 - 335.4	2483.5 - 2500	9300 - 9500	

Table 7.2.9 Restricted bands according to RSS-Gen, Table 3

MHz	MHz	MHz	MHz	MHz	GHz
0.09 - 0.11	8.291 - 8.294	16.80425 - 16.80475	399.9 - 410	3260 - 3267	10.6 - 12.7
2.1735 - 2.190	8.362 - 8.366	25.5 - 25.67	608 - 614	3332 - 3339	13.25 - 13.4
3.020 - 3.026	8.37625 - 8.38675	37.5 - 38.25	960 - 1427	3345.8 - 3358	14.47 - 14.5
4.125 - 4.128	8.41425 - 8.41475	73 - 74.6	1435 - 1626.5	3500 - 4400	15.35 - 16.2
4.17725 - 4.17775	12.290 - 12.293	74.8 - 75.2	1645.5 - 1646.5	4500 - 5150	17.7 - 21.4
4.20725 - 4.20775	12.51975 - 12.52025	108 - 138	1660 - 1710	5350 - 5460	22.01 - 23.12
5.677 - 5.683	12.57675 - 12.57725	156.52475 - 156.52525	1718.8 - 1722.2	7250 - 7750	23.6 - 24.0
6.215 - 6.218	13.36 - 13.41	156.7 - 156.9	2200 - 2300	8025 - 8500	31.2 - 31.8
6.26775 - 6.26825	16.42 - 16.423	240 - 285	2310 - 2390	9000 - 9200	36.43 - 36.5
6.31175 - 6.31225	16.69475 - 16.69525	322 - 335.4	2655 - 2900	9300 - 9500	Above 38.6



Test specification: FCC Part 15, Section 231(b) / RSS-210, Section A1.2, Field strength of emissions			
Test procedure: ANSI C63.10 sections 6.5, 6.6			
Test mode: Compliance		Verdict: PASS	
Date(s): 14-Dec-18			
Temperature: 23 °C	Relative Humidity: 45 %	Air Pressure: 1008 hPa	Power: 12 VDC
Remarks:			

Plot 7.2.1 Radiated emission measurements at the fundamental frequency

TEST SITE: Semi anechoic chamber
TEST DISTANCE: 3 m
ANTENNA POLARIZATION: Vertical & Horizontal
EUT POSITION: Typical

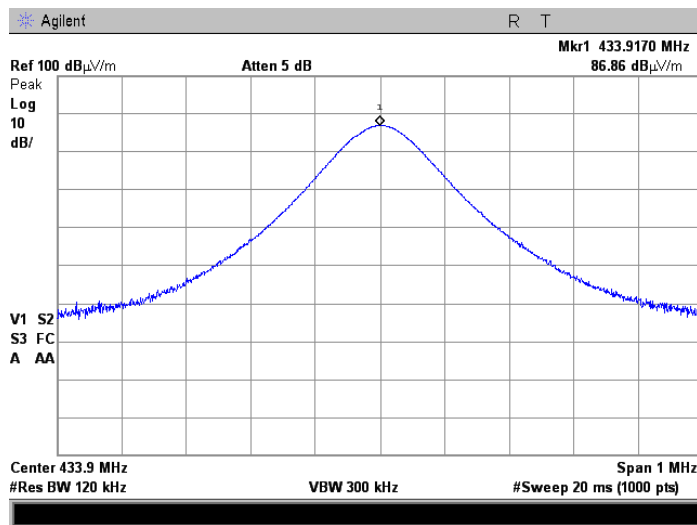

Plot 7.2.2 Radiated emission measurements from 9 kHz to 150 kHz

TEST SITE: Semi anechoic chamber
TEST DISTANCE: 3 m
ANTENNA POLARIZATION: Vertical

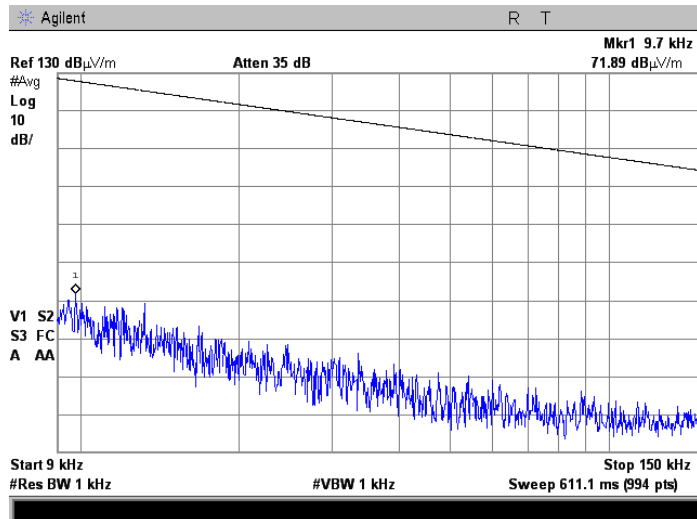



Test specification: FCC Part 15, Section 231(b) / RSS-210, Section A1.2, Field strength of emissions			
Test procedure: ANSI C63.10 sections 6.5, 6.6			
Test mode: Compliance		Verdict: PASS	
Date(s): 14-Dec-18			
Temperature: 23 °C	Relative Humidity: 45 %	Air Pressure: 1008 hPa	Power: 12 VDC
Remarks:			

Plot 7.2.3 Radiated emission measurements from 150 kHz to 30 MHz

TEST SITE: Semi anechoic chamber
TEST DISTANCE: 3 m
ANTENNA POLARIZATION: Vertical

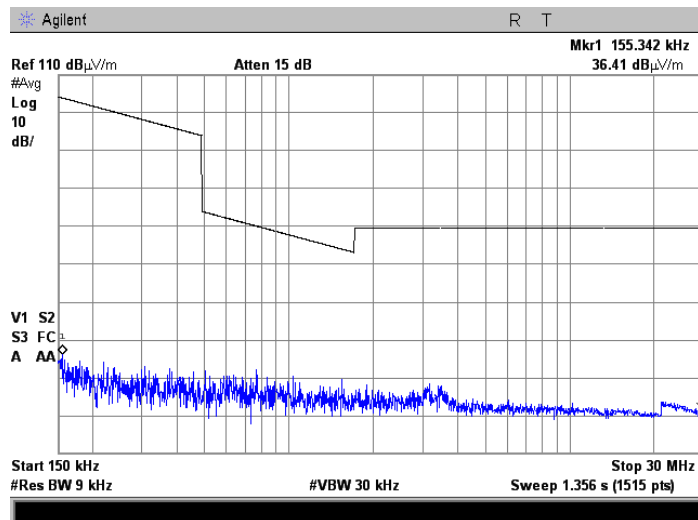

Plot 7.2.4 Radiated emission measurements from 30 to 400 MHz

TEST SITE: Semi anechoic chamber
TEST DISTANCE: 3 m
ANTENNA POLARIZATION: Vertical and Horizontal
EUT POSITION: Typical

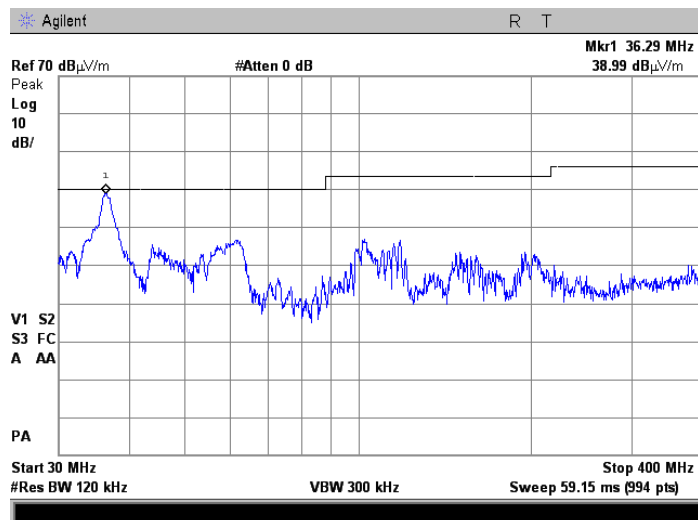



Test specification: FCC Part 15, Section 231(b) / RSS-210, Section A1.2, Field strength of emissions			
Test procedure: ANSI C63.10 sections 6.5, 6.6			
Test mode: Compliance		Verdict: PASS	
Date(s): 14-Dec-18			
Temperature: 23 °C	Relative Humidity: 45 %	Air Pressure: 1008 hPa	Power: 12 VDC
Remarks:			

Plot 7.2.5 Radiated emission measurements from 400 to 600 MHz

TEST SITE: Semi anechoic chamber
TEST DISTANCE: 3 m
ANTENNA POLARIZATION: Vertical and Horizontal
EUT POSITION: Typical

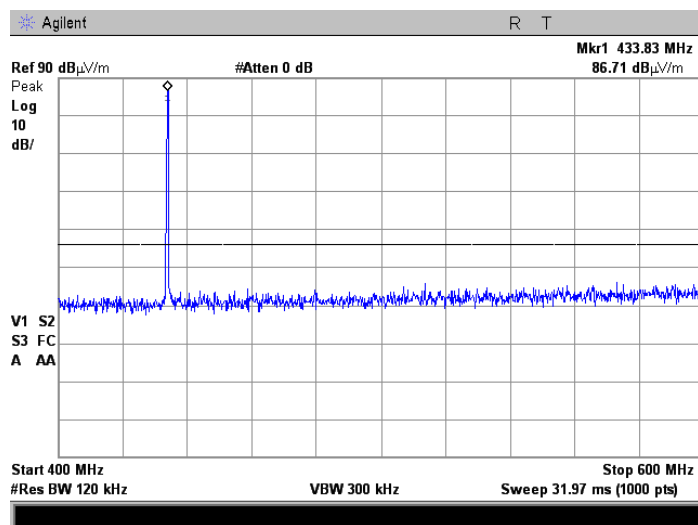

Plot 7.2.6 Radiated emission measurements from 600 to 1000 MHz

TEST SITE: Semi anechoic chamber
TEST DISTANCE: 3 m
ANTENNA POLARIZATION: Vertical and Horizontal
EUT POSITION: Typical

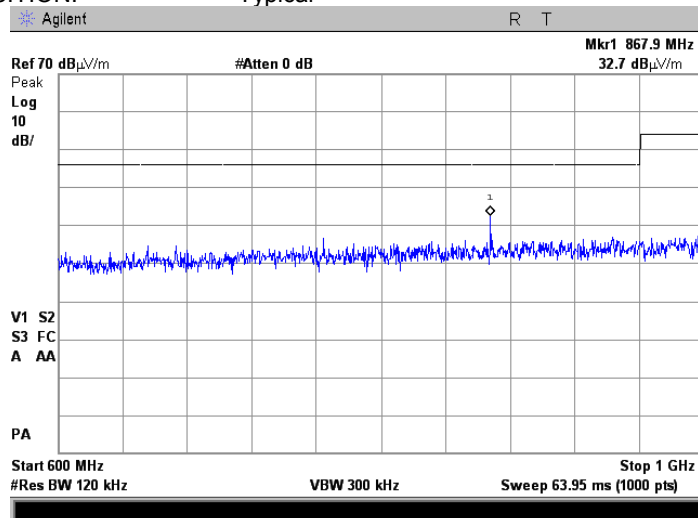



Test specification: FCC Part 15, Section 231(b) / RSS-210, Section A1.2, Field strength of emissions			
Test procedure: ANSI C63.10 sections 6.5, 6.6			
Test mode: Compliance		Verdict: PASS	
Date(s): 14-Dec-18			
Temperature: 23 °C	Relative Humidity: 45 %	Air Pressure: 1008 hPa	Power: 12 VDC
Remarks:			

Plot 7.2.7 Radiated emission measurements from 1000 to 4500 MHz

TEST SITE: Semi anechoic chamber
TEST DISTANCE: 3 m
ANTENNA POLARIZATION: Vertical and Horizontal
EUT POSITION: Typical

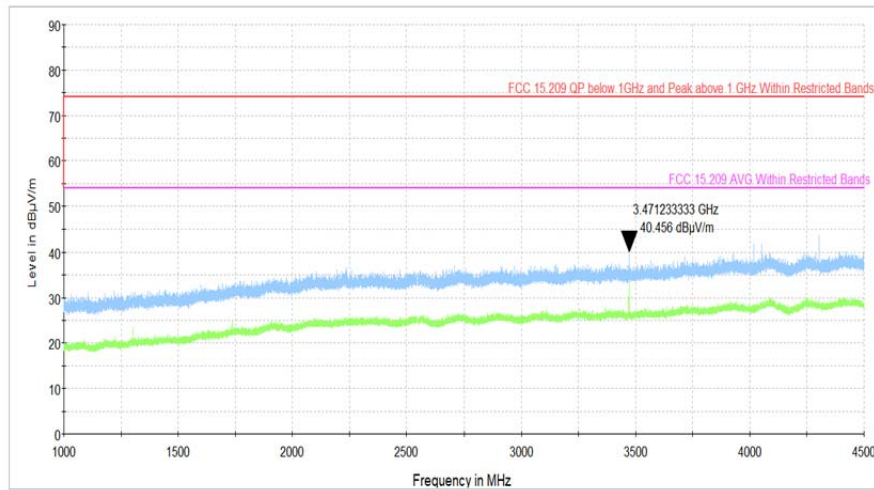



HERMON LABORATORIES

Test specification: FCC Part 15, Section 231(b) / RSS-210, Section A1.2, Field strength of emissions			
Test procedure: ANSI C63.10 sections 6.5, 6.6			
Test mode: Compliance		Verdict: PASS	
Date(s): 14-Dec-18			
Temperature: 23 °C	Relative Humidity: 45 %	Air Pressure: 1008 hPa	Power: 12 VDC
Remarks:			

Plot 7.2.8 Transmission duration

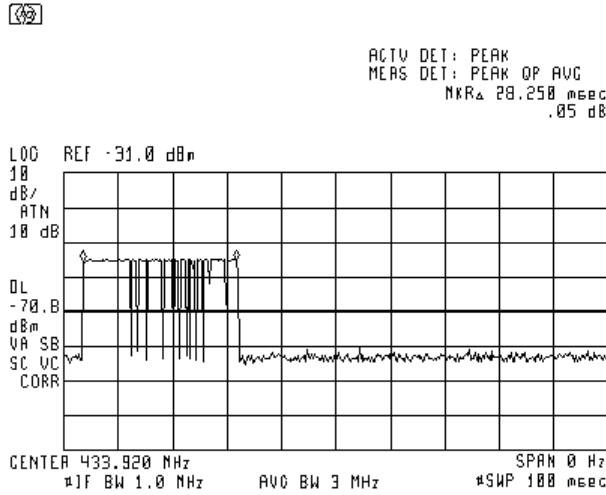

Plot 7.2.9 Transmission period

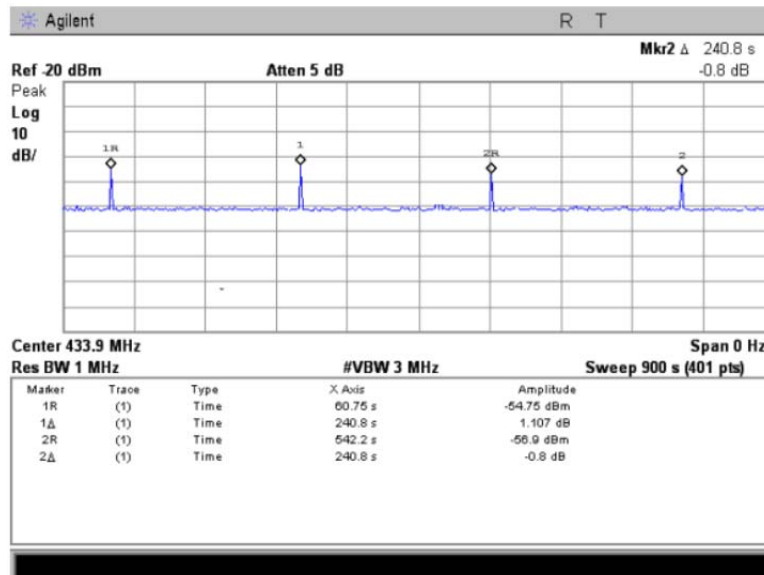



Test specification: FCC Part 15, Section 231(c) / RSS-210, Section A1. 3, Occupied bandwidth			
Test procedure: ANSI C63.10 section 6.9.2			
Test mode: Compliance		Verdict: PASS	
Date(s): 14-Dec-18			
Temperature: 23 °C	Relative Humidity: 55 %	Air Pressure: 1008 hPa	Power: 12 VDC
Remarks:			

7.3 Occupied bandwidth test

7.3.1 General

This test was performed to measure transmitter occupied bandwidth. Specification test limits are given in Table 7.3.1.

Table 7.3.1 Occupied bandwidth limits

Assigned frequency, MHz	Modulation envelope reference points*, dBc	Maximum allowed bandwidth, % of the carrier frequency
70 - 900	20.0	0.25
Above 900		0.50

*- Modulation envelope reference points provided in terms of attenuation below modulated carrier.

7.3.2 Test procedure

7.3.2.1 The EUT was set up as shown in Figure 7.3.1, energized and its proper operation was checked.

7.3.2.2 The EUT was set to transmit modulated carrier.

7.3.2.3 The transmitter occupied bandwidth was measured with spectrum analyzer as frequency delta between reference points on modulation envelope and provided in Table 7.3.2 and associated plot.

Figure 7.3.1 Occupied bandwidth test setup





Test specification: FCC Part 15, Section 231(c) / RSS-210, Section A1. 3, Occupied bandwidth			
Test procedure: ANSI C63.10 section 6.9.2			
Test mode: Compliance		Verdict: PASS	
Date(s): 14-Dec-18			
Temperature: 23 °C	Relative Humidity: 55 %	Air Pressure: 1008 hPa	Power: 12 VDC
Remarks:			

Table 7.3.2 Occupied bandwidth test results according to RSS 210

DETECTOR USED: Peak hold
 RESOLUTION BANDWIDTH: 1kHz
 VIDEO BANDWIDTH: 3kHz
 MODULATION: OOK
 BIT RATE: 1.66 kbps

MODULATION ENVELOPE REFERENCE POINTS: 20 dBc

Carrier frequency, MHz	Occupied bandwidth, kHz	Limit		Margin, kHz	Verdict
		% of the carrier frequency	kHz		
433.9	3.425	0.25	1082.5	1079.075	Pass

MODULATION ENVELOPE REFERENCE POINTS: 99%

Carrier frequency, MHz	Occupied bandwidth, kHz	Limit		Margin, kHz	Verdict
		% of the carrier frequency	kHz		
433.92	3.0474	0.25	1082.5	1079.4526	Pass

Reference numbers of test equipment used

HL 2909	HL 5288	HL 3903						
---------	---------	---------	--	--	--	--	--	--

Full description is given in Appendix A.



HERMON LABORATORIES

Test specification: FCC Part 15, Section 231(c) / RSS-210, Section A1. 3, Occupied bandwidth			
Test procedure: ANSI C63.10 section 6.9.2			
Test mode: Compliance		Verdict: PASS	
Date(s): 14-Dec-18			
Temperature: 23 °C	Relative Humidity: 55 %	Air Pressure: 1008 hPa	Power: 12 VDC
Remarks:			

Plot 7.3.1 Occupied bandwidth test result

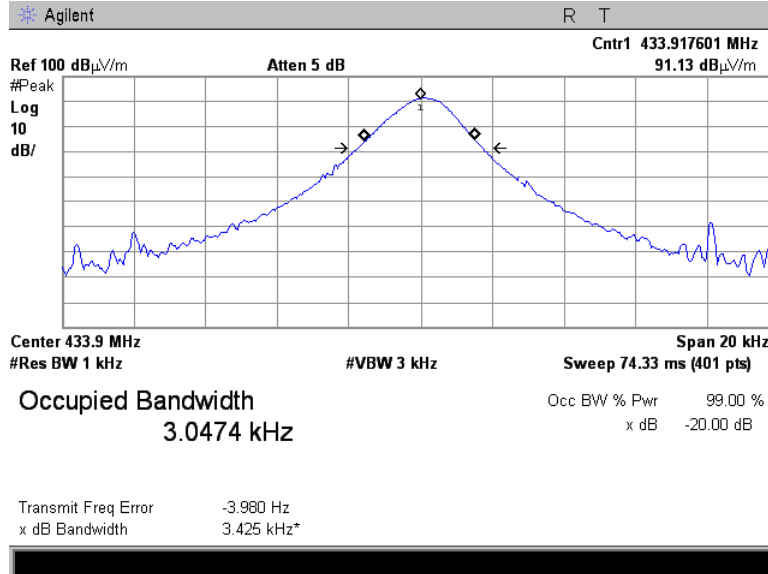



Test specification: FCC Part 15, Section 207 / RSS-Gen, Section 8.8, Conducted emission			
Test procedure: ANSI C63.4, Sections 7.3 and 12.2.4			
Test mode: Compliance		Verdict: PASS	
Date(s): 17-Dec-18			
Temperature: 25 °C	Relative Humidity: 46 %	Air Pressure: 1017 hPa	Power: 120 VAC, 60 Hz
Remarks:			

7.4 Conducted emissions

7.4.1 General

This test was performed to measure common mode conducted emissions at the power port. Specification test limits are given in Table 7.4.1.

Table 7.4.1 Limits for conducted emissions

Frequency, MHz	Class B limit, dB(μV)	
	QP	AVRG
0.15 - 0.5	66 - 56*	56 - 46*
0.5 - 5.0	56	46
5.0 - 30	60	50

* - The limit decreases linearly with the logarithm of frequency.

7.4.2 Test procedure

7.4.2.1 The EUT was set up as shown in Figure 7.4.1 and associated photographs, energized and the performance check was conducted.

7.4.2.2 The measurements were performed at power terminals with the LISN, connected to a spectrum analyzer while unused coaxial connector of the LISN was terminated with 50 Ohm.

7.4.2.3 The position of the device cables was varied to determine maximum emission level.

7.4.2.4 The worst test results (the lowest margins) were recorded in Table 7.4.2 and shown in the associated plots.

Figure 7.4.1 Setup for conducted emission measurements, table-top equipment

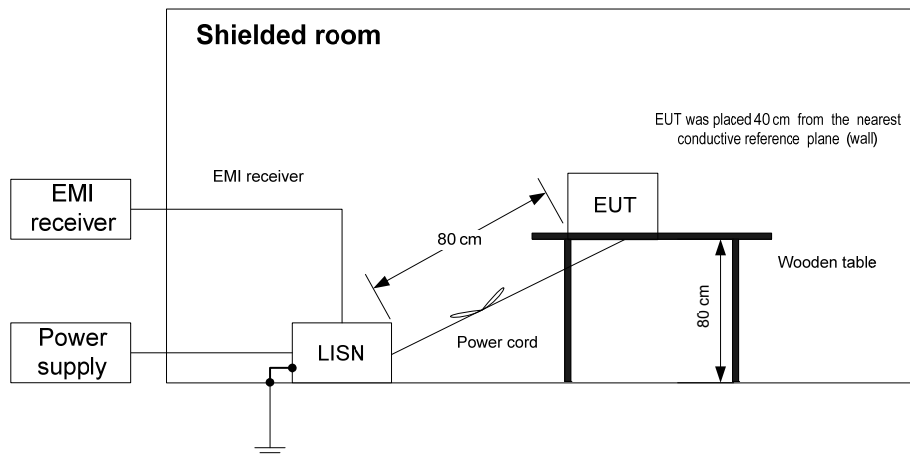



Test specification: FCC Part 15, Section 207 / RSS-Gen, Section 8.8, Conducted emission			
Test procedure: ANSI C63.4, Sections 7.3 and 12.2.4			
Test mode: Compliance		Verdict: PASS	
Date(s): 17-Dec-18			
Temperature: 25 °C	Relative Humidity: 46 %	Air Pressure: 1017 hPa	Power: 120 VAC, 60 Hz
Remarks:			

Table 7.4.2 Conducted emission test results

LINE: AC mains at Control panel input
EUT OPERATING MODE: Transmit
EUT SET UP: TABLE-TOP
TEST SITE: SHIELDED ROOM
FREQUENCY RANGE: 150 kHz - 30 MHz
RESOLUTION BANDWIDTH: 9 kHz

Frequency, MHz	Peak emission, dB(μV)	Quasi-peak			Average			Line ID	Verdict
		Measured emission, dB(μV)	Limit, dB(μV)	Margin, dB*	Measured emission, dB(μV)	Limit, dB(μV)	Margin, dB*		
0.151	45.6	39.3	66.0	-26.7	12.3	56.0	-43.7	L1	Pass
0.184	45.0	38.8	64.3	-25.5	11.4	54.3	-42.9		
16.525	34.3	31.1	60.0	-28.9	18.0	50.0	-32.0		
17.976	35.3	32.3	60.0	-27.7	24.4	50.0	-25.6		
19.674	35.2	32.0	60.0	-28.0	24.6	50.0	-25.4		
0.168	45.5	38.8	65.1	-26.3	10.4	55.1	-44.7	L2	Pass
0.193	45.1	38.7	64.0	-25.3	9.5	54.0	-44.5		
3.999	28.3	26.6	56.0	-29.4	25.3	46.0	-20.7		
19.681	34.8	31.5	60.0	-28.5	22.4	50.0	-27.6		
29.873	34.9	31.5	60.0	-28.5	25.5	50.0	-24.5		

*- Margin = Measured emission - specification limit.

Reference numbers of test equipment used

HL 0787	HL 1500	HL 3016	HL 4778				
---------	---------	---------	---------	--	--	--	--

Full description is given in Appendix A.



Test specification: FCC Part 15, Section 207 / RSS-Gen, Section 8.8, Conducted emission			
Test procedure: ANSI C63.4, Sections 7.3 and 12.2.4			
Test mode: Compliance		Verdict: PASS	
Date(s): 17-Dec-18			
Temperature: 25 °C	Relative Humidity: 46 %	Air Pressure: 1017 hPa	Power: 120 VAC, 60 Hz
Remarks:			

Plot 7.4.1 Conducted emission measurements

LINE: L1
EUT OPERATING MODE: Transmit
LIMIT: QUASI-PEAK, AVERAGE
DETECTOR: PEAK



ACTV DET: PEAK
MERS DET: PEAK OP AVG
NRK 160 kHz
45.25 dBµV

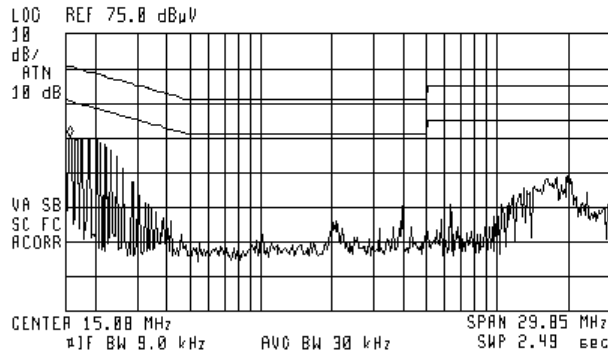

Plot 7.4.2 Conducted emission measurements

LINE: L2
EUT OPERATING MODE: Transmit
LIMIT: QUASI-PEAK, AVERAGE
DETECTOR: PEAK



ACTV DET: PEAK
MERS DET: PEAK OP AVG
NRK 160 kHz
44.61 dBµV

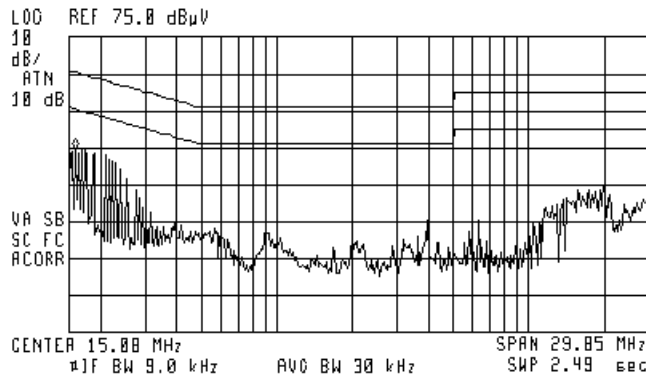



Test specification: FCC Part 15, Section 203 / RSS-Gen, Section6.8, Antenna requirements			
Test procedure: Visual inspection / supplier declaration			
Test mode: Compliance		Verdict: PASS	
Date(s): 14-Dec-18			
Temperature: 23 °C	Relative Humidity: 55 %	Air Pressure: 1008 hPa	Power: 12 VDC
Remarks:			

7.5 Antenna requirements

The EUT was verified for compliance with antenna requirements. A transmitter shall be designed to ensure that no antenna other than that furnished by the responsible party will be used with the device. It may be either permanently attached or employs a unique antenna connector for every antenna proposed for use with the EUT. This requirement does not apply to professionally installed transmitters. The rationale for compliance with the above requirements was either visual inspection results or supplier declaration. The summary of results is provided in Table 7.5.1.

Table 7.5.1 Antenna requirements

Requirement	Rationale	Verdict
The transmitter antenna is permanently attached	Visual inspection	Comply
The transmitter employs a unique antenna connector	NA	
The transmitter requires professional installation	NA	

**8 APPENDIX A Test equipment and ancillaries used for tests**

HL No	Description	Manufacturer	Model	Ser. No.	Last Cal./ Check	Due Cal./ Check
0446	Antenna, Loop, Active, 10 kHz - 30 MHz	EMCO	6502	2857	24-Feb-19	24-Feb-20
0787	Transient Limiter 9 kHz-200 MHz	Hewlett Packard	11947A	3107A018 77	08-Oct-18	08-Oct-19
1500	Cable RF, 15 m, N/N-type	Suhner Switzerland	RG 214/U	1500	11-Feb-19	11-Feb-20
2909	Spectrum analyzer, ESA-E, 100 Hz to 26.5 GHz	Agilent Technologies	E4407B	MY414447 62	27-Mar-18	27-Apr-19
3016	LISN, Two-line V-network, 9 kHz to 30 MHz, (50 uH+5 Ohm), CISPR16-1, MIL-461E	Rohde & Schwarz	ESH 3-Z5	892239/00 2	27-Jan-19	27-Jan-20
3339	High Pass Filter, 50 Ohm, 600 to 3000 MHz.	Mini-Circuits	SHP-600+	NA	17-May-18	17-May-19
3903	Microwave Cable Assembly, 40.0 GHz, 1.5 m, SMA/SMA	Huber-Suhner	SUCOFLE X 102A	1226/2A	07-Feb-18	07-Apr-19
4339	High pass Filter, 50 Ohm, 1000 to 18000 MHz, SMA-FM / SMA-M	Micro-Tronics	HPM5011 5-02	001	14-May-17	14-Mar-19
4360	EMI Test Receiver, 20 Hz to 40 GHz.	Rohde & Schwarz	ESU40	100322	31-Dec-18	31-Dec-19
4778	EMI Receiver, 9 kHz - 2.9 GHz, System: HL1431, HL4777	Hewlett Packard	8542E	30807A00 262, 3427A001 23	28-Oct-18	28-Oct-19
4933	Active Horn Antenna, 1 GHz to 18 GHz	Com-Power Corporation	AHA-118	701046	06-Jan-19	06-Jan-20
5288	Trilog Antenna, 25 MHz - 8 GHz, 100W	Frankonia	ALX- 8000E	00809	08-Feb-19	08-Feb-22
5405	RF cable, 18 GHz, N-N, 6 m	Huber-Suhner	SF118/11 N(x2)	500023/11 8	01-Aug-18	01-Aug-19

9 APPENDIX B Measurement uncertainties

Expanded uncertainty at 95% confidence in Hermon Labs EMC measurements

Test description	Expanded uncertainty
Conducted emissions with LISN	9 kHz to 150 kHz: ± 3.9 dB 150 kHz to 30 MHz: ± 3.8 dB
Radiated emissions at 10 m measuring distance Horizontal polarization Vertical polarization	Biconilog antenna: ± 5.0 dB Biconical antenna: ± 5.0 dB Log periodic antenna: ± 5.1 dB Double ridged horn antenna: ± 5.3 dB Biconilog antenna: ± 5.5 dB Biconical antenna: ± 5.5 dB Log periodic antenna: ± 5.6 dB Double ridged horn antenna: ± 5.8 dB
Radiated emissions at 3 m measuring distance Horizontal polarization Vertical polarization	Biconilog antenna: ± 5.3 dB Biconical antenna: ± 5.0 dB Log periodic antenna: ± 5.3 dB Double ridged horn antenna: ± 5.3 dB Biconilog antenna: ± 6.0 dB Biconical antenna: ± 5.7 dB Log periodic antenna: ± 6.0 dB Double ridged horn antenna: ± 6.0 dB
Conducted emissions at RF antenna connector	9 kHz to 2.9 GHz: ± 2.6 dB 2.9 GHz to 6.46 GHz: ± 3.5 dB 6.46 GHz to 13.2 GHz: ± 4.3 dB 13.2 GHz to 22.0 GHz: ± 5.0 dB 22.0 GHz to 26.8 GHz: ± 5.5 dB 26.8 GHz to 40.0 GHz: ± 4.8 dB
Duty cycle, timing (Tx ON / OFF) and average factor measurements	± 1.0 %
Occupied bandwidth	± 8.0 %

Hermon Laboratories is accredited by A2LA for calibration according to present requirements of ISO/IEC 17025 and NCSL Z540-1. The accreditation is granted to perform calibration of parameters that are listed in the Scope of Hermon Laboratories Accreditation.

Hermon Laboratories calibrates its reference and transfer standards by calibration laboratories accredited to ISO/IEC 17025 by a mutually recognized Accreditation Body or by a recognized national metrology institute. All reference and transfer standards used in the calibration system are traceable to national or international standards.

In-house calibration of all test and measurement equipment is performed on a regular basis according to Hermon Laboratories calibration procedures, manufacturer calibration/verification procedures or procedures defined in the relevant standards. The Hermon Laboratories test and measurement equipment is calibrated within the tolerances specified by the manufacturers and/or by the relevant standards.

10 APPENDIX C Test laboratory description

Tests were performed at Hermon Laboratories Ltd., which is a fully independent, private, EMC, Radio, Safety, Environmental and Telecommunication testing facility.

Hermon Laboratories is recognized and accredited by the Federal Communications Commission (USA) for relevant parts of Code of Federal Regulations 47 (CFR 47), Test Firm Registration Number is 927748, Designation Number is IL1001; Recognized by Innovation, Science and Economic Development Canada for wireless and terminal testing (ISED), ISED #2186A, CAB identifier is IL1001; Certified by VCCI, Japan (the registration numbers are R-10808 for OATS, R-1082 for anechoic chamber, G-10869 for RE measurements above 1 GHz, C-10845 for conducted emissions site and T-11606 for conducted emissions at telecommunication ports).

The laboratory is accredited by American Association for Laboratory Accreditation (USA) according to ISO/IEC 17025 for electromagnetic compatibility, product safety, telecommunications testing, environmental simulation and calibration (for exact scope please refer to Certificate No. 839.01, 839.03 and 839.04).

Address: P.O. Box 23, Binyamina 3055001, Israel.
Telephone: +972 4628 8001
Fax: +972 4628 8277
e-mail: mail@hermonlabs.com
website: www.hermonlabs.com

Person for contact: Mr. Michael Nikishin, EMC&Radio group manager

11 APPENDIX D Specification references

47CFR part 15:2018	Radio Frequency Devices.
ANSI C63.10: 2013	American National Standard of Procedures for Compliance Testing of Unlicensed Wireless Devices
ANSI C63.4: 2014	American National Standard for Methods of Measurement of Radio-Noise Emissions from Low-Voltage Electrical and Electronic Equipment in the Range of 9 kHz to 40 GHz.
RSS-210 Issue 9:2016	Licence- Exempt Radio Apparatus:Category I Equipment
RSS-Gen Issue 5: 2018	General Requirements for Compliance of Radio Apparatus



12 APPENDIX E Test equipment correction factors

Antenna factor
Active loop antenna
Model 6502, S/N 2857, HL 0446

Frequency, MHz	Magnetic antenna factor, dB	Electric antenna factor, dB
0.009	-32.8	18.7
0.010	-33.8	17.7
0.020	-38.3	13.2
0.050	-41.1	10.4
0.075	-41.3	10.2
0.100	-41.6	9.9
0.150	-41.7	9.8
0.250	-41.6	9.9
0.500	-41.8	9.8
0.750	-41.9	9.7
1.000	-41.4	10.1
2.000	-41.5	10.0
3.000	-41.4	10.2
4.000	-41.4	10.1
5.000	-41.5	10.1
10.000	-41.9	9.6
15.000	-41.9	9.6
20.000	-42.2	9.3
25.000	-42.8	8.7
30.000	-44.0	7.5

Antenna factor in dB(1/m) is to be added to receiver meter reading in dB(μ V) to convert it into field strength in dB(μ V/m).



Antenna factor
Trilog antenna
Model ALX-8000E, Frankonia, S/N 00809, HL 5288, 30-1000 MHz

Frequency, MHz	Antenna factor, dB/m		
	Vert Up	Vert Down	Delta
30	-51.19	-51.28	0.09
35	-44.03	-44.12	0.09
40	-43.07	-43.12	0.05
45	-39.61	-39.79	0.18
50	-37.84	-38.14	0.3
60	-34.93	-34.9	0.03
70	-29.76	-29.66	0.1
80	-27.69	-27.82	0.13
90	-29.05	-29.07	0.02
100	-31.19	-31.19	0
120	-31.61	-31.6	0.01
140	-28.13	-28.06	0.07
160	-27.71	-27.75	0.04
180	-26.19	-26.15	0.04
200	-28.2	-28.15	0.05
250	-27.45	-27.47	0.02
300	-29.61	-29.63	0.02
400	-31.77	-31.78	0.01
500	-32.81	-32.81	0
600	-33.64	-33.61	0.03
700	-34.21	-34.21	0
800	-35.66	-35.66	0
900	-36.99	-36.91	0.08
1000	-38	-37.91	0.09

Antenna factor in dB(1/m) is to be added to receiver meter reading in dB(μ V) to convert it into field intensity in dB(μ V/m).



Antenna factor
Active Horn Antenna,
Com-Power Corporation, model: AHA-118, s/n 701046, HL 4933

Frequency, MHz	Measured antenna factor (with preamplifier), dB/m
1000	-16.1
1500	-15.1
2000	-10.9
2500	-11.9
3000	-11.1
3500	-10.6
4000	-8.6
4500	-8.3
5000	-5.9
5500	-5.7
6000	-3.3
6500	-4.0
7000	-2.2
7500	-1.7
8000	1.1
8500	-0.8
9000	-1.5
9500	-0.2

Frequency, MHz	Measured antenna factor (with preamplifier), dB/m
10000	1.8
10500	1.0
11000	0.3
11500	-0.5
12000	3.1
12500	1.4
13000	-0.3
13500	-0.4
14000	2.5
14500	2.2
15000	1.9
15500	0.5
16000	2.1
16500	1.2
17000	0.6
17500	3.1
18000	4.2

The antenna factor shall be added to receiver reading in dB μ V to obtain field strength in dB μ V/m.



Correction factor
Line impedance stabilization network
Model ESH 3-Z5, Rhode&Schwarz, HL 3016

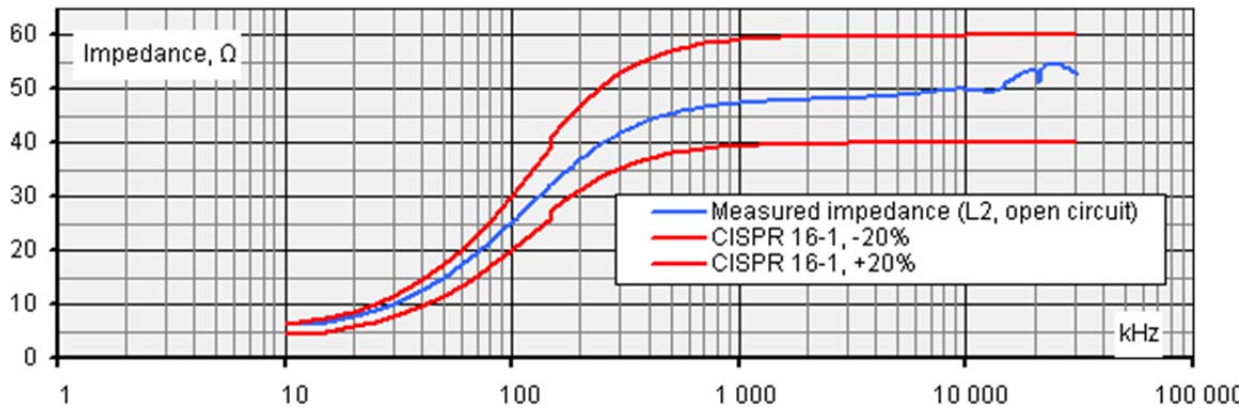
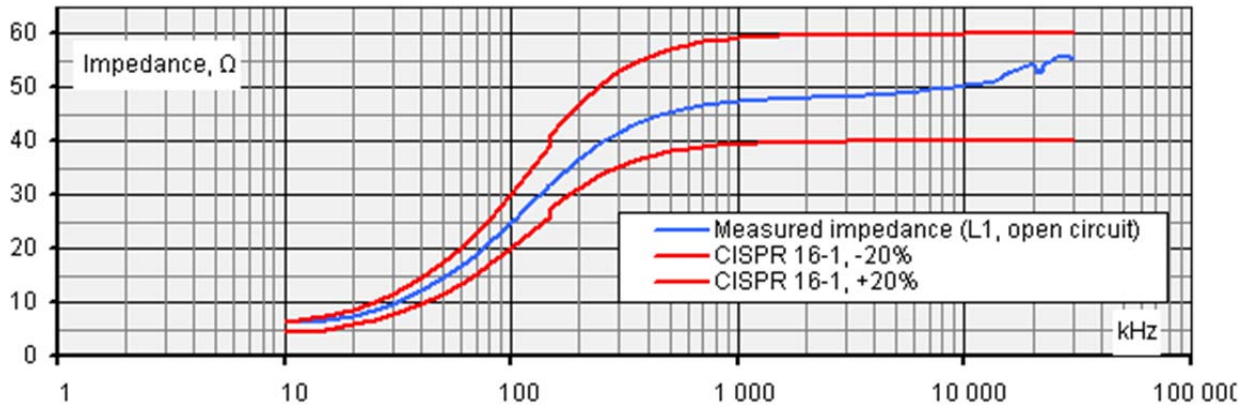



Cable loss
Microwave Cable Assembly, Huber-Suhner, 40 GHz, 1.5 m, SMA-SMA, S/N 1226/2A
HL 3903

Frequency, MHz	Cable loss, dB	Frequency, MHz	Cable loss, dB	Frequency, MHz	Cable loss, dB
10	-0.02	9500	1.84	21000	2.98
100	0.15	10000	1.86	22000	3.07
500	0.38	10500	1.93	23000	3.13
1000	0.56	11000	1.99	24000	3.21
1500	0.69	11500	2.04	25000	3.26
2000	0.82	12000	2.10	26000	3.48
2500	0.90	12500	2.15	27000	3.44
3000	0.98	13000	2.21	28000	3.53
3500	1.06	13500	2.25	29000	3.59
4000	1.11	14000	2.29	30000	3.66
4500	1.17	14500	2.34	31000	3.70
5000	1.24	15000	2.36	32000	3.79
5500	1.32	15500	2.40	33000	3.88
6000	1.40	16000	2.45	34000	3.94
6500	1.50	16500	2.48	35000	3.91
7000	1.56	17000	2.56	36000	4.05
7500	1.62	17500	2.58	37000	4.22
8000	1.68	18000	2.60	38000	4.25
8500	1.74	19000	2.84	39000	4.27
9000	1.78	20000	2.88	40000	4.33



Cable loss
RF Cable, Huber-Suhner, 18 GHz, 6 m,
SF118/11N(x2), S/N 500023/118
HL 5405

5405

Specific Test Report



Frequency Range [GHz]	IL min S21 [dB]	IL min S12 [dB]	RL max S11 [dB]	RL max S22 [dB]
0.040 - 1.836	-1.431	-1.431	-37.037	-37.704
1.836 - 3.632	-2.062	-2.066	-33.573	-32.848
3.632 - 5.428	-2.576	-2.576	-28.548	-29.602
5.428 - 7.224	-3.013	-3.014	-30.738	-32.523
7.224 - 9.020	-3.415	-3.416	-33.728	-32.257
9.020 - 10.816	-3.772	-3.772	-29.302	-30.735
10.816 - 12.612	-4.138	-4.138	-28.768	-26.255
12.612 - 14.408	-4.456	-4.462	-27.109	-26.151
14.408 - 16.204	-4.786	-4.786	-26.056	-27.116
16.204 - 18.000	-5.113	-5.111	-27.762	-28.508

Type: SF118/11N/11N/6000MM
Sales no.: 10497130
Serial no.: 500023 /118
PA no.: 1956306
Ring no.:
Cable length: 6 m
Test length:
Connector 1: SF_11_N-656
Connector 2: SF_11_N-656
Cable: SUCOFLEX_118
Meas. System: N5230C,MY49001834,A.09.42.22

Time: 7:04:21 AM
Date: 6/6/2018
Inspected by: AZ /111

Start Freq.: 0.04000 GHz
Stop Freq.: 18.00000 GHz
Meas Points: 801
Source Power: -5 dBm



13 APPENDIX F Abbreviations and acronyms

A	ampere
AC	alternating current
A/m	ampere per meter
AM	amplitude modulation
AVRG	average (detector)
cm	centimeter
dB	decibel
dBm	decibel referred to one milliwatt
dB(μ V)	decibel referred to one microvolt
dB(μ V/m)	decibel referred to one microvolt per meter
dB(μ A)	decibel referred to one microampere
DC	direct current
EIRP	equivalent isotropically radiated power
ERP	effective radiated power
EUT	equipment under test
F	frequency
GHz	gigahertz
GND	ground
H	height
HL	Hermon laboratories
Hz	hertz
k	kilo
kHz	kilohertz
LO	local oscillator
m	meter
MHz	megahertz
min	minute
mm	millimeter
ms	millisecond
μ s	microsecond
NA	not applicable
NB	narrow band
OATS	open area test site
Ω	Ohm
PM	pulse modulation
PS	power supply
ppm	part per million (10^{-6})
QP	quasi-peak
RE	radiated emission
RF	radio frequency
rms	root mean square
Rx	receive
s	second
T	temperature
Tx	transmit
V	volt
WB	wideband

END OF TEST REPORT

14 APPENDIX G Manufacturer's declaration about periodic operation



April 03rd, 2019

To: Hermon Laboratories

Attention: Mr. Michael Nikishin and Ms. Ella Pitt

Manufacturer's Declaration

We, Paradox Security Systems Ltd. located in 780 Industrial Boulevard St-Eustache, Quebec J7R 5V3, Canada declare under our sole responsibility that the product Wireless Expansion Module RTX3 is operate on 433.92 MHz and designed to comply and satisfy periodic operational requirements.

Wireless Expansion Module RTX3 does not allow continuous transmitting (such as voice, video and radio control).

The Wireless Expansion Module RX3 are not manually operated devices.

The transmissions of RTX3 are not periodical and occur upon intrusion only.

RTX3 module is an intrusion alarm system device and will send automatically its synchronization message to control panel in a certain interval (once in 4 minutes).

Since, there is no periodical behavior except synchronization transmissions, there are no predetermined intervals of any kind included in device's algorithm.

A handwritten signature in black ink, appearing to read 'Alex'.

Alex Chaplik
Certification Manager

END OF DOCUMENT