



# Nemko

**Test Report:** 5W39803.2

**Applicant:** Paradox Security Systems  
780 Industrial Blvd  
St-Eustache, Quebec  
J7R 5V3

**Apparatus:** Spectra 1759MG

**FCC ID:** KDY1759MG

**In Accordance With:** FCC Part 15 Subpart B, 15.107 and 15.109  
Unintentional Radiators

**Tested By:** Nemko Canada Inc.  
303 River Road  
Ottawa, Ontario  
K1V 1H2

**Authorized By:**   
Sim Jagpal, Resource Manager

**Date:** 18 March 2005

**Total Number of Pages:** 19

## Report Summary

These tests were conducted on a sample of the equipment for the purpose of demonstrating compliance with Part 15, Subpart B. Radiated tests were conducted in accordance with ANSI C63.4-2003. Radiated emissions are made on an open area test site. A description of the test facility is on file with the FCC.

The assessment summary is as follows:

<b>Apparatus Assessed:</b>	Spectra 1759MG
<b>Specification:</b>	FCC Part 15 Subpart B, 15.107 and 15.109
<b>Compliance Status:</b>	Complies
<b>Exclusions:</b>	None
<b>Non-compliances:</b>	None
<b>Report Release History:</b>	Original Release

Author: Jason Nixon, Telecom Specialist

Note that the results contained in this report relate only to the items tested and were obtained in the period between the date of initial receipt of samples and the date of issue of the report.

This test report has been completed in accordance with the requirements of ISO/IEC 17025.

Nemko Canada Inc. authorizes the applicant to reproduce this report provided it is reproduced in its entirety and for use by the company's employees only.

Any use which a third party makes of this report, or any reliance on or decisions to be made based on it, are the responsibility of such third parties. Nemko Canada Inc. accepts no responsibility for damages, if any, suffered by any third party as a result of decisions made or actions based on this report.

## TABLE OF CONTENTS

**Report Summary** ..... 2

**Section 1 : Equipment Under Test**..... 4

    1.1 Product Identification .....4

    1.2 Samples Submitted for Assessment.....4

    1.3 Theory of Operation .....4

    1.4 Technical Specifications of the EUT .....5

**Section 2 : Test Conditions**..... 6

    2.1 Specifications .....6

    2.2 Deviations From Laboratory Test Procedures .....6

    2.3 Test Environment .....6

    2.4 Test Equipment.....6

**Section 3 : Observations** ..... 7

    3.1 Modifications Performed During Assessment .....7

    3.2 Record Of Technical Judgements .....7

    3.3 EUT Parameters Affecting Compliance .....7

    3.4 Test Deleted.....7

**Section 4 : Results Summary** ..... 8

    4.1 FCC Part 15 Subpart C : Test Results .....9

**Appendix A : Test Results**..... 10

**Appendix B : Setup Photographs** ..... 18

**Appendix C : Block Diagram of Test Setups**..... 19

## Section 1 : Equipment Under Test

### 1.1 Product Identification

The Equipment Under Test was identified as follows:

Spectra 1759MG

### 1.2 Samples Submitted for Assessment

The following samples of the apparatus have been submitted for type assessment:

Sample No.	Description	Serial No.
1	Euro Cabinet	_____
3	Spectra 1759MG	050221B
4	Antenna	_____
5	Antenna	_____
15	20VA Power Transformer (P/N RT-1620SL/M)	_____
16	40VA Power Transformer (M/N UB1640W)	_____

The first samples were received on: February 28, 2005

### 1.3 Theory of Operation

The Spectra 1759MG is a security control panel. The apparatus has a 433MHz receiver for communications from different sensors placed around the house.

## **1.4 Technical Specifications of the EUT**

<b>Manufacturer:</b>	Paradox Security Systems
<b>Receive Frequency:</b>	433.92MHz (Fixed)
<b>Antenna Data:</b>	Two 7" solid conductor antenna's
<b>Antenna Connection type:</b>	Screw block terminal

## Section 2 : Test Conditions

### 2.1 Specifications

The apparatus was assessed against the following specifications:

FCC Part 15 Subpart B, 15.107 and 15.109  
Unintentional Radiators

### 2.2 Deviations From Laboratory Test Procedures

No deviations were made from laboratory test procedures.

### 2.3 Test Environment

All tests were performed under the following environmental conditions:

Temperature range : 15 – 30 °C  
Humidity range : 20 - 75 %  
Pressure range : 86 - 106 kPa  
Power supply range : +/- 5% of rated voltages

### 2.4 Test Equipment

Equipment	Manufacturer	Model No.	Asset/Serial No.	Last Cal.	Next Cal.
Spectrum Analyzer	Hewlett-Packard	8566B	FA001309	May 28/04	May 28/05
Spectrum Analyzer Display	Hewlett-Packard	85662A	FA001309	May 28/04	May 28/05
Receiver	Hewlett-Packard	8591EM	3536A00621	Nov. 29/04	Nov. 29/05
Transient Limiter	Hewlett-Packard	1194 7A	FA000975	June 10/04	June 10/05
LISN	EMCO	4825/2	FA001545	Jan. 13/05	Jan. 13/06
Receiver	Rohde & Schwarz	ESVS-30	FA001437	July 26/04	July 26/05
Biconical (2) Antenna	EMCO	3109	FA000904	Aug. 03/04	Aug. 03/05
Log Periodic Antenna #1	EMCO	LPA-25	FA000477	Aug. 26/04	Aug. 26/05
1.0 – 2.0 GHz Amplifier	JCA	12-400	FA001498	June 18/04	June 18/05
Horn Antenna #1	EMCO	3115	FA000649	Dec. 22/04	Dec. 22/05

## **Section 3 : Observations**

### **3.1 Modifications Performed During Assessment**

No modifications were performed during assessment.

### **3.2 Record Of Technical Judgements**

No technical judgements were made during the assessment.

### **3.3 EUT Parameters Affecting Compliance**

The user of the apparatus could not alter parameters that would affect compliance.

### **3.4 Test Deleted**

No Tests were deleted from this assessment.

## **Section 4 : Results Summary**

This section contains the following:

FCC Part 15 Subpart B : Test Results

The column headed 'Required' indicates whether the associated clauses were invoked for the apparatus under test. The following abbreviations are used:

- N No : not applicable / not relevant.
- Y Yes : Mandatory i.e. the apparatus shall conform to these tests.
- N/T Not Tested, mandatory but not assessed. (See section 3.4 Test deleted)

The results contained in this section are representative of the operation of the apparatus as originally submitted.



**4.1 FCC Part 15 Subpart C : Test Results**

Part 15	Test Description	Required	Result
15.107(a)	Conducted Emissions for Class B	Y	Pass
15.109(a)	Radiated Emissions for Class B	Y	Pass

Notes:

None

## Appendix A : Test Results

### Criteria: Clause 15.107(a) Conducted Emissions

Frequency of Conducted limit (dBmV)		
Emission (MHz)	Quasi-peak	Average
0.15-0.5	66 to 56*	56 to 46*
0.5-5	56	46
5-30	60	50
* Decreases with the logarithm of the frequency.		

### Test Conditions:

<b>Sample Number:</b>	3	<b>Temperature:</b>	22
<b>Date:</b>	March 3, 2005	<b>Humidity:</b>	12
<b>Modification State:</b>	0	<b>Tester:</b>	Jason Nixon
		<b>Laboratory:</b>	Shielded Room

**Test Results:** See Attached Plots and Tables.

### Block Diagram of Test Setup:

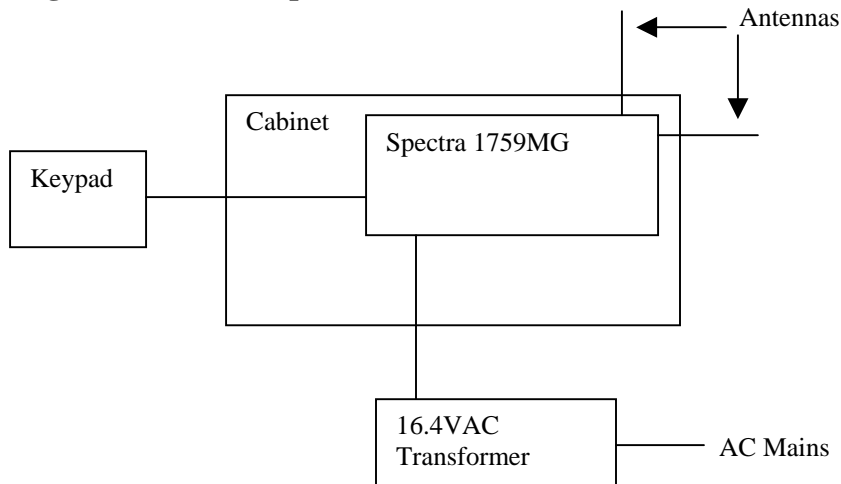

### Additional Observations:

- 1) The apparatus was able of using 2 different power transformers. The difference was the VA ratings. Testing was performed on both.
- 2) Plots are taken using a peak detector and compared to the Quasi-peak and average limits. At points over the limit the values in the Tables are measured using Quasi-peak and average detectors to show compliance.

**40VA Transformer**

Conductor	Frequency (MHz)	Detector	Emission Level (dBuV)	LISN Loss (dB)	Cable Loss (dB)	Result (dBuV)	Limit (dBuV)	Margin (dB)	
1	Phase	0.1639	Quasi Peak	48.6	0.00	0.01	48.61	65.3	16.7
			Average	19.9	0.00	0.01	19.91	55.3	35.4
2	Phase	0.1515	Quasi Peak	48.0	0.00	0.15	48.15	65.9	17.8
			Average	19.6	0.00	0.15	19.75	55.9	36.2
3	Phase	0.1860	Quasi Peak	47.0	0.00	0.10	47.10	64.2	17.1
			Average	18.1	0.00	0.10	18.20	54.2	36.0
4	Neutral	0.1556	Quasi Peak	49.3	0.00	0.12	49.42	65.7	16.3
			Average	19.6	0.00	0.12	19.72	55.7	36.0
5	Neutral	0.1614	Quasi Peak	49.0	0.00	0.20	49.20	65.4	16.2
			Average	20.1	0.00	0.20	20.30	55.4	35.1
6	Neutral	0.1780	Quasi Peak	48.2	0.00	0.00	48.20	64.6	16.4
			Average	18.9	0.00	0.00	18.90	54.6	35.7

**20VA Transformer**

Conductor	Frequency (MHz)	Detector	Emission Level (dBuV)	LISN Loss (dB)	Cable Loss (dB)	Result (dBuV)	Limit (dBuV)	Margin (dB)	
1	Phase	0.1506	Quasi Peak	46.9	0.00	0.06	46.96	66.0	19.0
			Average	18.1	0.00	0.06	18.16	56.0	37.8
2	Phase	0.1553	Quasi Peak	46.2	0.00	0.06	46.26	65.7	19.5
			Average	17.3	0.00	0.06	17.36	55.7	38.4
3	Phase	0.1616	Quasi Peak	45.2	0.00	0.20	45.40	65.4	20.0
			Average	17.5	0.00	0.20	17.70	55.4	37.7
4	Neutral	0.1532	Quasi Peak	46.0	0.00	0.18	46.18	65.8	19.6
			Average	17.3	0.00	0.18	17.48	55.8	38.3
5	Neutral	0.1558	Quasi Peak	45.8	0.00	0.16	45.96	65.7	19.7
			Average	17.1	0.00	0.16	17.26	55.7	38.4
6	Neutral	0.1592	Quasi Peak	45.3	0.00	0.02	45.32	65.5	20.2
			Average	17.2	0.00	0.02	17.22	55.5	38.3

Phase with 40VA Transformer

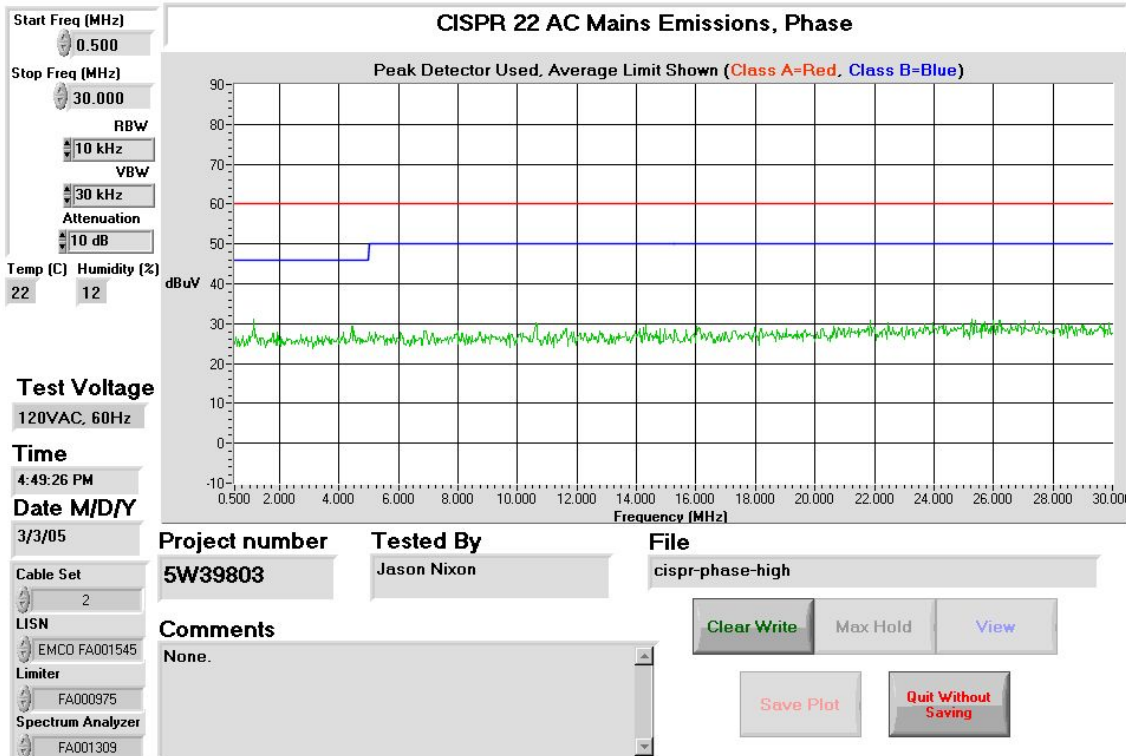
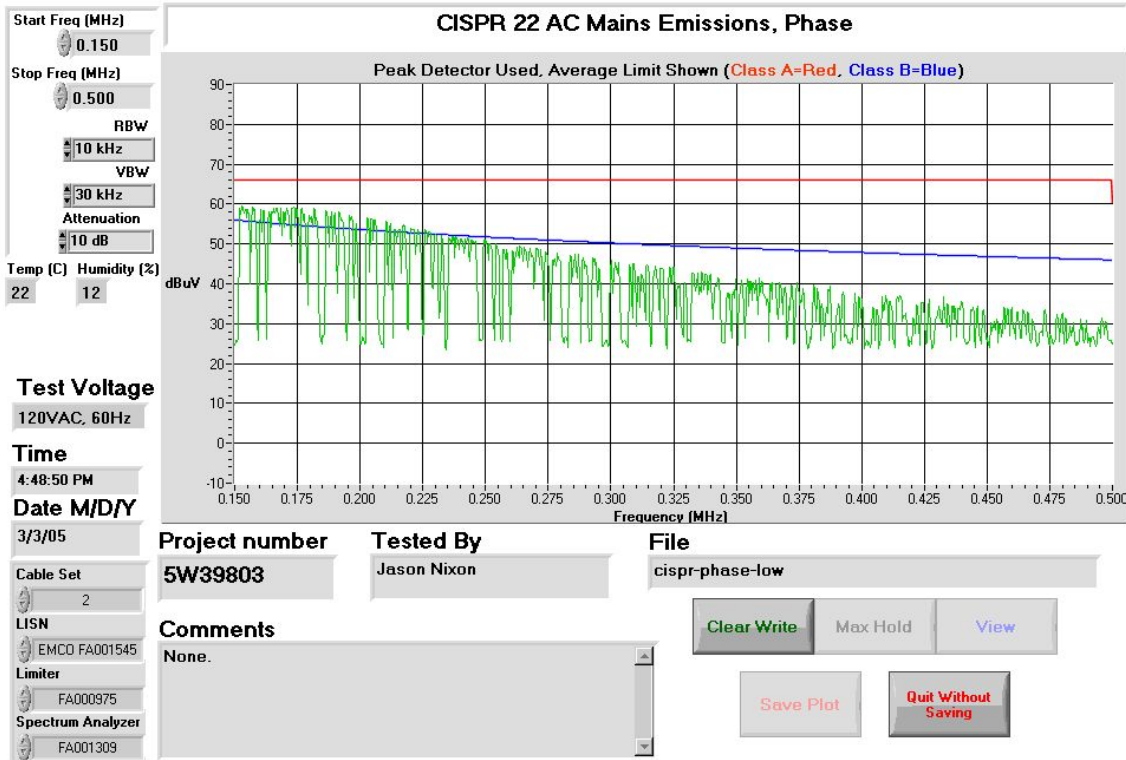

### Neutral with 40VA Transformer

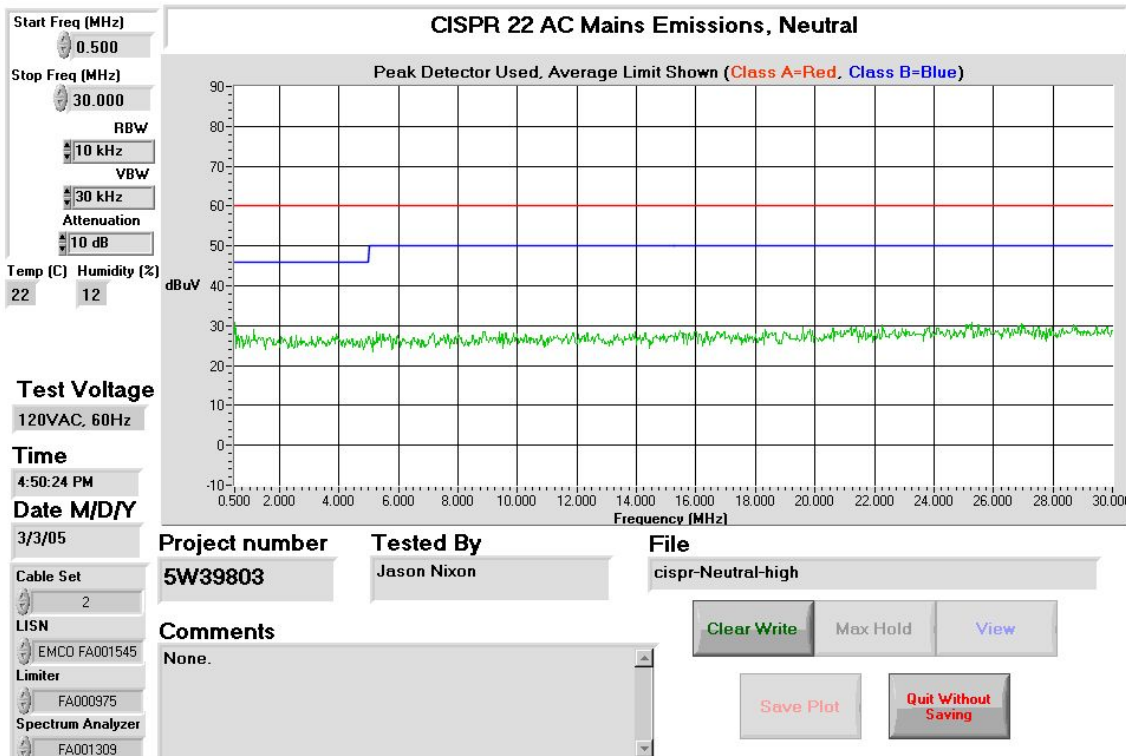
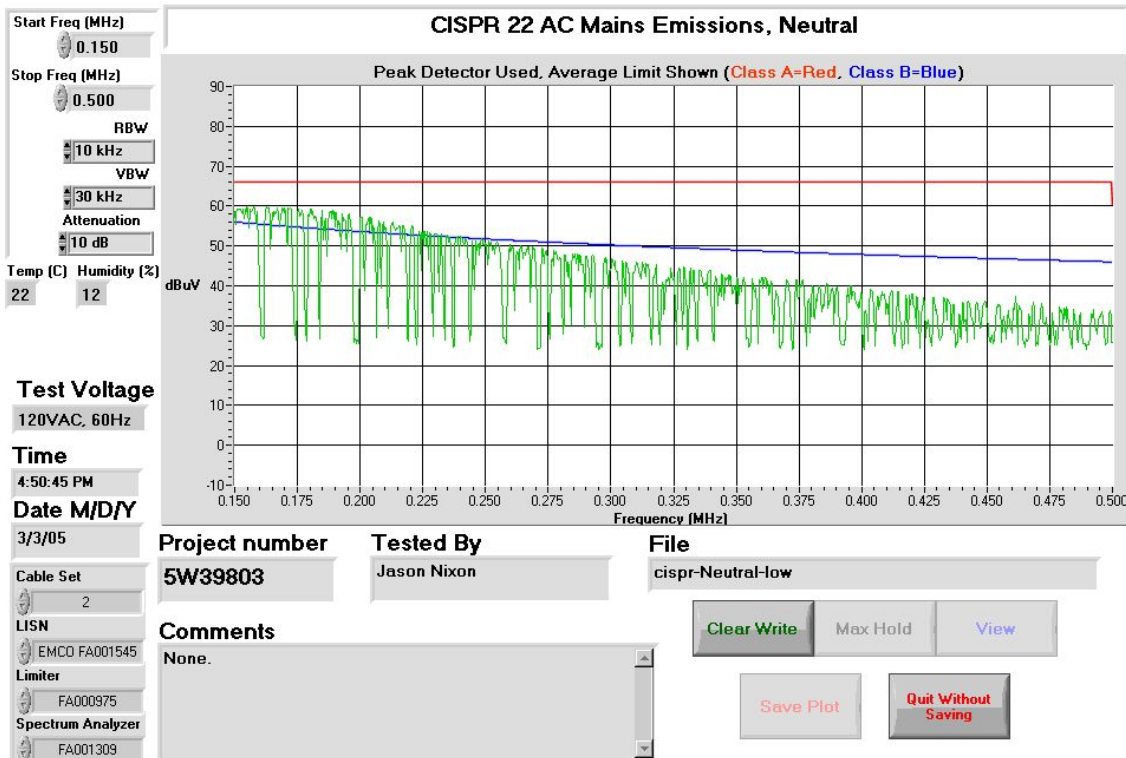

Phase with 20VA Transformer

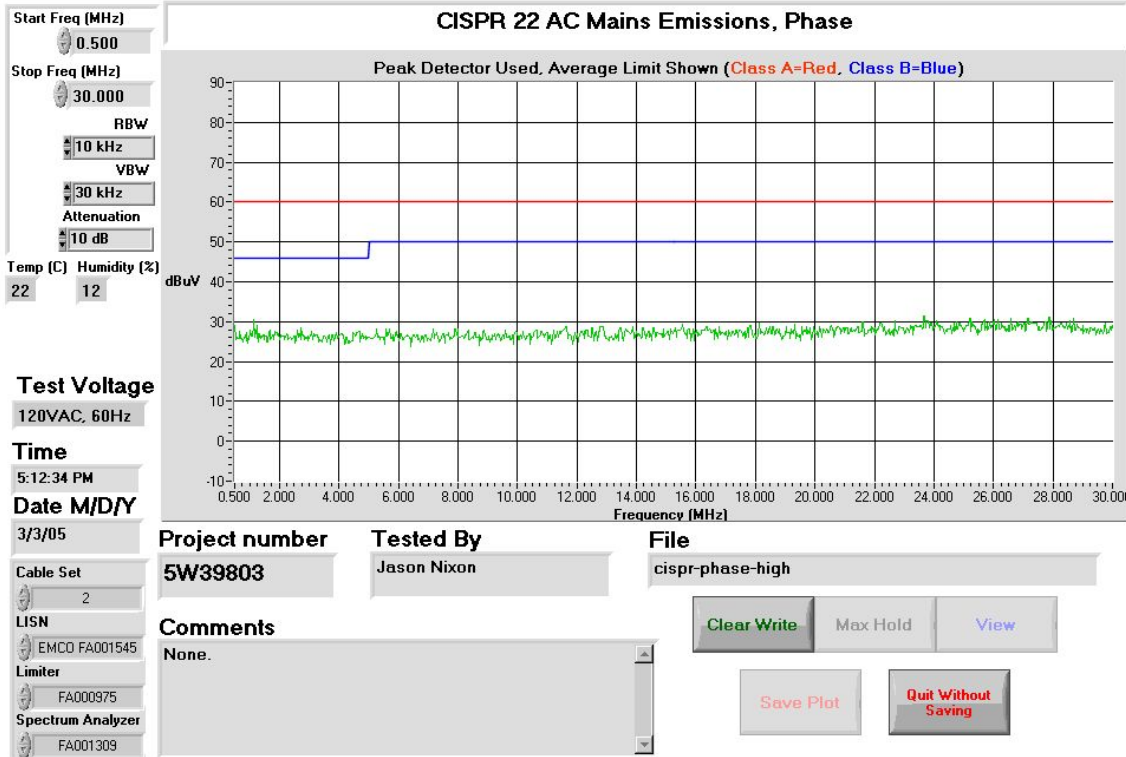
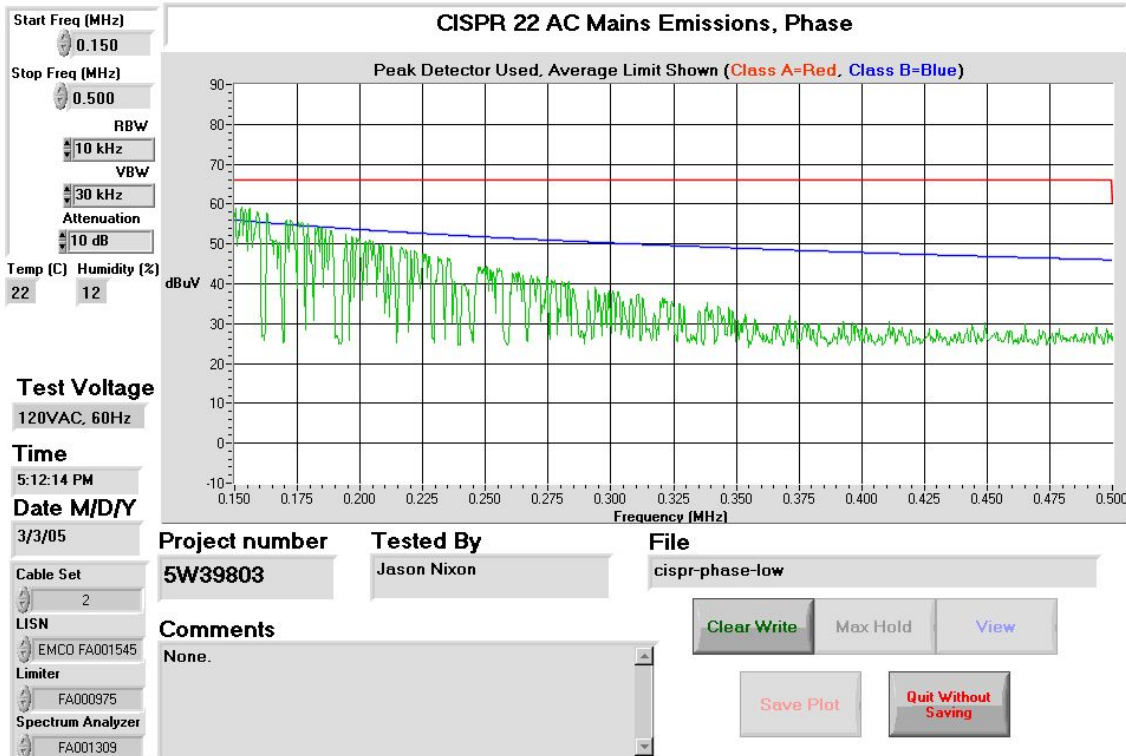

Neutral with 20VA Transformer

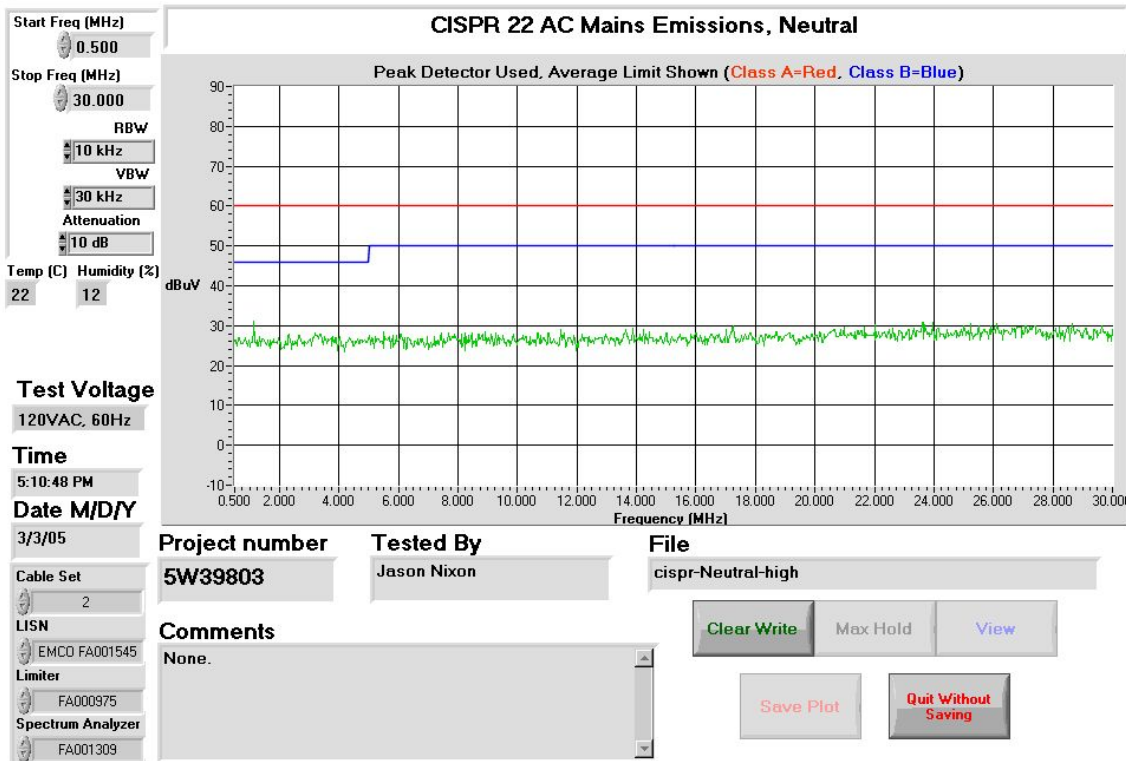
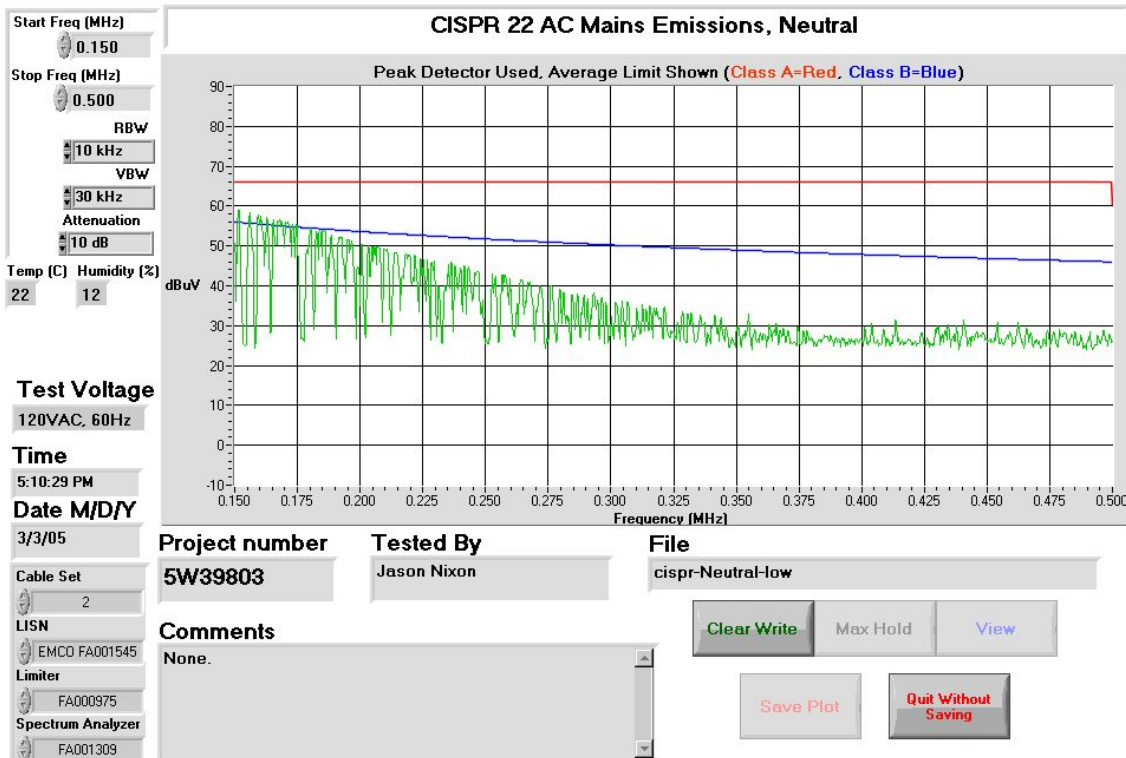

**Criteria: Clause 15.109(a) Radiated Emissions**

Except for Class A digital devices, the field strength of radiated emissions from unintentional radiators at a distance of 3 meters shall not exceed the following values:

Frequency of Emission (MHz)	Field Strength (microvoltsmeter)
30 - 88	100
88 - 216	150
216 - 960	200
Above 960	500

**Test Conditions:**

<b>Sample Number:</b>	3	<b>Temperature:</b>	10
<b>Date:</b>	March 5, 2005	<b>Humidity:</b>	61
<b>Modification State:</b>	0	<b>Tester:</b>	Jason Nixon
		<b>Laboratory:</b>	OATS

**Test Results:**

See Attached Table for Results

**Additional Observations:**

The Spectrum was searched from 30MHz to 2GHz.

The EUT was measured in the standard wall mount position.

Measurement equipment setup was 120kHz Quasi-peak detector for measurements below 1GHz and 1MHz RBW/VBW peak detector above 1GHz.



Freq. (MHz)	Ant	Pol. V/H	RCVD Signal (dBμV)	Ant. Factor (dB)	Amp. Gain (dB)	Duty Cycle Corr. (dB)	Cable Loss (dB)	Level (dBuV)	Limit (dBuV)	Margin (dB)
423.2202	LP1	V	10.8	16.1	-	-	2.6	29.5	46.0	16.5
423.2202	LP1	H	9.7	16.5	-	-	2.6	28.8	46.0	17.2
564.2935	LP1	V	12.8	18.5	-	-	3.1	34.4	46.0	11.6
564.2935	LP1	H	11.5	19.0	-	-	3.1	33.6	46.0	12.4
80.0000	BC2	V	23.0	7.6	-	-	1.0	31.6	40.0	8.4
80.0000	BC2	H	23.8	7.6	-	-	1.0	32.4	40.0	7.6
31.9999	BC2	V	20.7	11.9	-	-	0.7	33.3	40.0	6.7
31.9999	BC2	H	17.2	13.2	-	-	0.7	31.1	40.0	8.9
48.0001	BC2	V	22.3	10.0	-	-	0.8	33.1	40.0	6.9
48.0001	BC2	H	22.9	11.0	-	-	0.8	34.7	40.0	5.3
56.0000	BC2	V	19.1	8.9	-	-	0.9	28.9	40.0	11.1
56.0000	BC2	H	23.5	9.5	-	-	0.9	33.9	40.0	6.1
119.9995	BC2	V	23.1	12.1	-	-	1.4	36.6	43.5	6.9
119.9995	BC2	H	21.3	11.5	-	-	1.4	34.2	43.5	9.3
111.9994	BC2	V	20.3	11.5	-	-	1.3	33.1	43.5	10.4
111.9994	BC2	H	22.4	11.0	-	-	1.3	34.7	43.5	8.8
95.9992	BC2	V	17.9	10.0	-	-	1.2	29.1	43.5	14.4
95.9992	BC2	H	27.8	9.1	-	-	1.2	38.0	43.5	5.5
295.9992	BC2	V	9.3	18.8	-	-	2.3	30.4	46.0	15.6
295.9992	BC2	H	9.3	19.9	-	-	2.3	31.5	46.0	14.5
136.4501	BC2	V	18.3	13.3	-	-	1.5	33.1	43.5	10.4
136.4501	BC2	H	17.1	12.8	-	-	1.5	31.4	43.5	12.1
247.9992	BC2	V	9.2	17.1	-	-	2.0	28.3	46.0	17.7
247.9992	BC2	H	9.2	16.7	-	-	2.0	27.9	46.0	18.1

Note 1: Antenna Legend: BC = Biconical, BL = Bilog, LP = Log-Periodic, Horn = Horn, ED = EMCO Dipole

## Appendix B : Setup Photographs

### Conducted Emissions Setup:

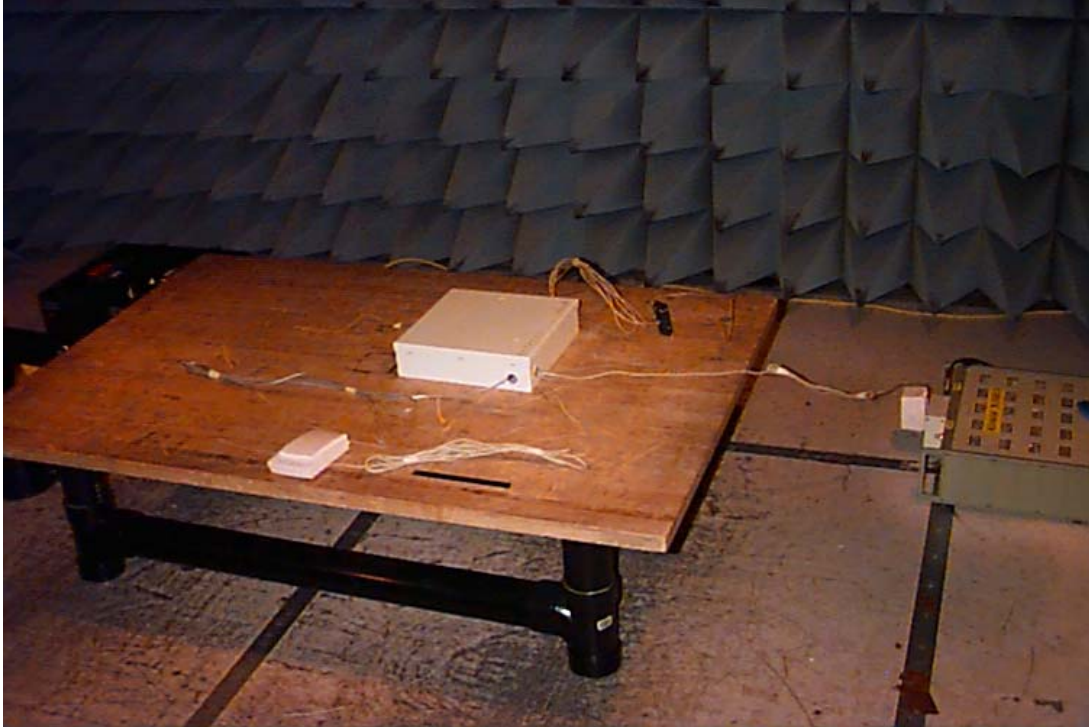

### Spurious Emissions Setup:



### Appendix C : Block Diagram of Test Setups

#### Test Site For Radiated Emissions

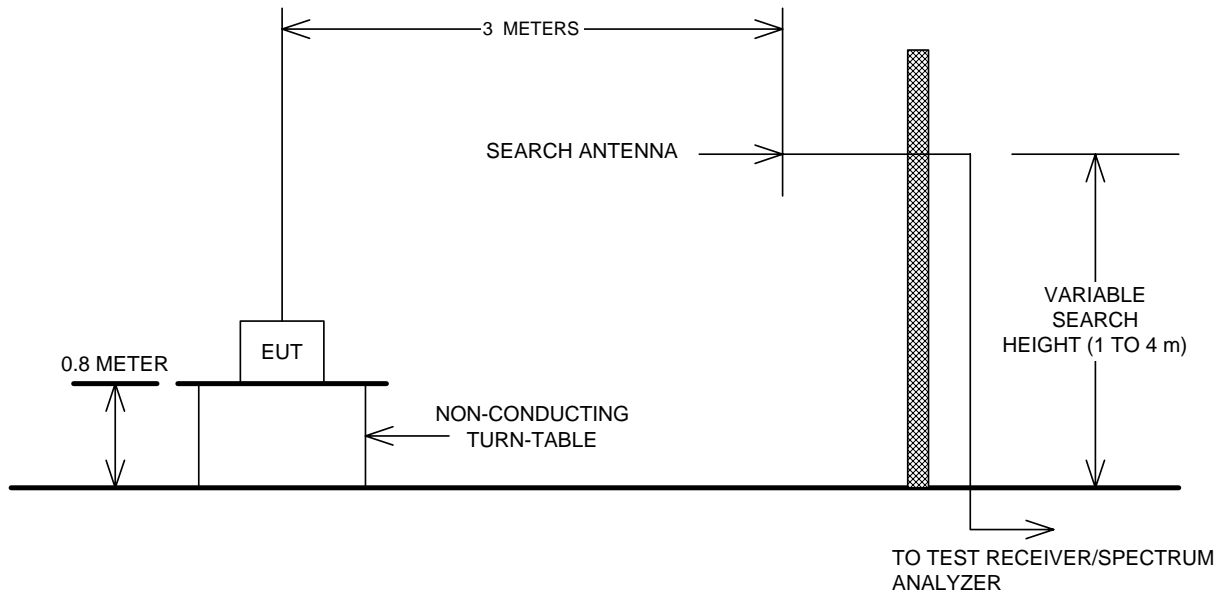

#### Conducted Emissions

