

**APPLICATION FOR
TYPE ACCEPTANCE**

Sierra Wireless Inc.

FCC ID: EA93837

MODEL: SB320 Modem Integrated into the XC6250

Prepared by:
Sierra Wireless Inc.

#150 - 13575 Commerce Parkway
Richmond, B.C.
V6V 2L1
Canada

Apr. 26, 1999

Table Of Contents

<i>Table Of Contents</i> _____	2
<i>Letter of Submittal and Compliance</i> _____	3
<i>Applicant Introduction</i> _____	4
Operational Modes _____	4
<i>Expository Statement 2.983 – Modem Detailed Circuit Description</i> _____	5
Description of Terminology _____	5
SB320 Logic Detail Circuit Description _____	5
SB320 Radio General Description _____	11
SB320 Radio Electrical Specifications _____	12
SB320 Radio Block Diagram _____	13
<i>User Manual Pages With FCC Disclaimers</i> _____	16
<i>Calculation of Necessary Bandwidth for FCC ID: EA93837</i> _____	19
For CDPD 19.2Kbps Transmission (emission type FXW) _____	19
For AMPS Wideband Data Mode (emission type F1D) _____	19
For AMPS Voice Channel Transmission for Modem Signaling (emission type F9W) _____	19
<i>Performance Test Data</i> _____	20
RF Output Power (2.985) _____	20
Occupied Bandwidth (2.989) _____	21
Spurious Emissions at Antenna Terminals (2.991) _____	27
Field Intensity Measurements of Spurious Radiation (2.993) _____	32
Operation Stability Performance (2.995) _____	33
<i>Test Equipment List</i> _____	35
<i>FCC Sample Label</i> _____	36
Finished Product Label: _____	36
Finished Product Label Location: _____	37
 <i>Owners Manual</i> _____	 <i>Enclosed</i>
<i>Equipment Photographs</i> _____	<i>Enclosed</i>
<i>Schematics</i> _____	<i>Enclosed</i>

Letter of Submittal and Compliance



Apr. 26, 1999

Federal Communications Commission
Authorization and Standards Division
7435 Oakland Mills Rd.
Columbia, M.D. 21046

Sir/Madam,

Sierra Wireless Incorporated has tested this transmitter in accordance with the requirements contained in the appropriate Commission Regulations. To the best of my knowledge, these tests were performed using measurement procedures consistent with the Industry or Commission standards and demonstrates that the equipment complies with the published standard. We are unable to warrant against unpublished changes in requirements. The applicable rules are listed in the following test report.

Sincerely

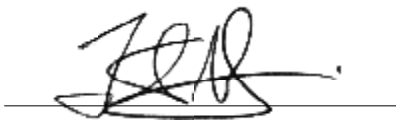

Trent McKeen
RF Engineer

Applicant Introduction

Sierra Wireless, Inc., located in Richmond, B.C., Canada, designs and manufactures wireless data modems for use on Cellular networks. The company was incorporated in May of 1993 around a core engineering staff with special expertise in development of products for use in commercial mobile data systems.

The SB320, is a multimode cellular data modem. It offers the capability of data communications using either CDPD (Cellular Digital Packet Data) or circuit switched cellular. It also has the capability of analog voice communication over AMPS cellular.

Operational Modes

Data Over Circuit Switched Cellular:

The modem is capable of data transmission over the standard AMPS voice channel. For establishing a conventional AMPS cellular call, cellular control channel FSK signaling is used at 10kbps per cellular system requirements. Once the call is established, computer modem signaling is sent over the "voice" channel along with SAT. This computer signaling varies in type depending on data rate used, but is filtered so that it always fits within a 300 to 3000Hz baseband bandwidth and the deviation is factory adjusted to be less than 12kHz peak. The spectrum occupancy of transmissions in this mode are characterized by testing at the highest data rate commonly achievable on the cellular infrastructure, 16.8kbps, to generate the worst case spectrum occupancy.

CDPD

In addition to the analog cellular mode, the modem also can transmit using CDPD signaling. The modulation used in this case is GMSK at a single data rate of 19.2kbps. Deviation in this mode is factory adjusted to 4.8kHz peak $\pm 5\%$. Test results for all of these modulation types are included in this report.

Expository Statement 2.983 – Modem Detailed Circuit Description

The SB320 modem is a wireless modem, which operates on both the AMPS and CDPD networks. The product operates as a stand alone modem which may connect to host device (such as a personal computer) through an available serial port.

The SB320 modem consists of 2 different subcircuits which are packaged together in a PCMCIA Type III housing. These circuits are

1. Modem Logic
2. Radio

Each subcircuit is discussed separately in the subsequent sections.

Description of Terminology

CDPD	Cellular Digital Packet Data
DSP	Digital Signal Processor
EEPROM	Electrically Erasable Programmable Read Only Memory
MCU	Micro Controller Unit

SB320 Logic Detail Circuit Description

The logic board can be divided into various subsystems: MCU, Memory, DSP, Radio Interface, Data Access Arrangement, Codec, and AMPS Data Processor. Figure 2-1 shows a block diagram of the whole system.

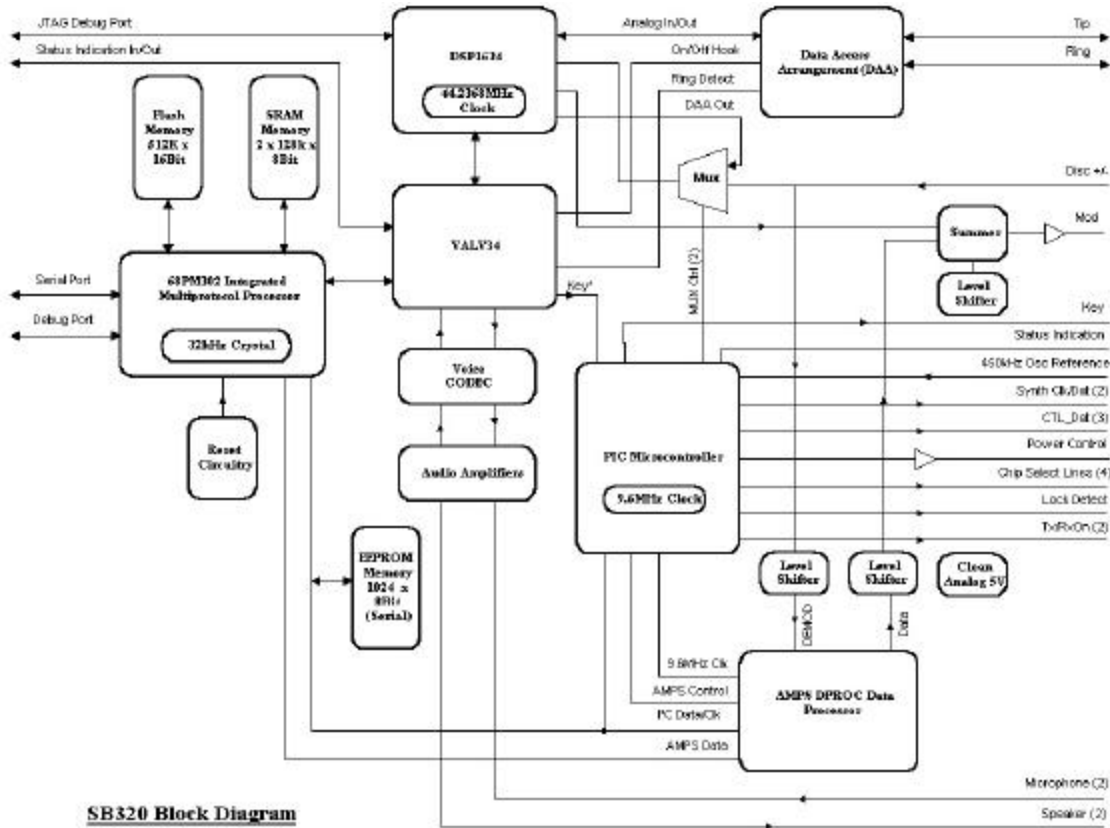

Figure 2-1: Logic Board Block Diagram

MCU

The MCU subsystem is responsible for communicating with the host and running application and diagnostic software. It talks to the DSP through the VALV34 interface. The processor used is a MC68PM302 Integrated Multiprotocol MCU.

The MC68PM302 has an MC68000 core with two independent serial communication controllers (SCC) and various general parallel port pins. The first serial port is used as a debug port and the second is used for the host interface. The CPU has a 16-bit bus to access 16 bit flash memory and the 2 x 8 bit SRAM. The CPU has 20 address lines and 4 chip select lines that allow it to address up to 4 Mbytes. Address line A0 is used as WEH (Write Enable High) in 16 bit wide data bus mode.

The system clock is derived from a phase locked loop (PLL) circuit built into the MCU. The PLL utilizes a 32.768kHz external crystal. The PLL multiplies this frequency by a multiplication factor (MF) to obtain the system clock.

The MCU also monitors 4 status lines from the external connector monitored by software.

Memory

The MCU accesses three types of memory: SRAM, FLASH, and EEPROM. The RAM and the FLASH memory are connected directly to the MCU bus while the EEPROM is connected to an I²C interface.

The SRAM is used to store program data variables. It consists of two 128k x 8-bit devices connected for high and low addressing to create a 16 bit address bus. The devices are addressed with !WEH and !WEL for high and low addresses respectively.

The FLASH memory allows for field reprogramming (upgrade) of system software. It is used to store the program code and constants. It is made up of one 512k x 16-bit device.

The EEPROM is used as non-volatile storage. The MCU communicates through two wires that make up the I²C interface. There are other devices on the I²C interface and each is identified with a unique address. Its size is 1024 x 8-bit.

DSP and VALV Chipset

The DSP subsystem is responsible for performing all of the DSP functions. It consists of an AT&T DSP1634 DSP and a VALV34 interface device.

The DSP1634 has a DSP16A core with built in address decoding, wait states generator, baseband codec and JTAG port. The built in address decoding and wait states generator within the DSP 1634 simplifies memory interfacing.

The VALV34 is responsible for providing an interface between the MCU and the DSP. Internally, the VALV34 contains 8 mailboxes which is the primary means of communication between the MCU and DSP. It also provides serial ports and general purpose I/O for the radio interface.

The VALV also provides 2 status lines, one of which is available to the external connector, the other drives the on-board LED. The status lines are under the control of software.

Radio Interface

The radio interface subsystem provides the hardware and software interface to the radio. A Microchip PIC microcontroller is the primary device used in this subsystem.

The PIC is programmed to perform housekeeping functions (such as monitor the KEY request line from the DSP and monitor the I²C interface lines) in the usual running mode but can also be controlled by the MCU via the I²C interface for other functions.

The clock source for the PIC is a 9.6MHz crystal which also supplies the clock for the AMPS data processor (DPROC) subsystem.

The PIC is one-time-programmable and is usually programmed before insertion into the board. Provision has been made however for in-circuit programming if desired.

Functions performed by the PIC/Radio Interface subsystem:

- Monitor the KEY request from the DSP, decide if appropriate, if so – Key the radio
- Control TXON (Transmitter subsystem) and RXON (Receiver subsystem) on the radio
- Interrogate the A/D converter on the radio and obtain RSSI and temperature readings
- Control the radio synthesizer
- Provide an adjustable power source for the transmitter which is also switchable through a RAMP control line.
- Detect if the radio is locked onto the desired frequency
- Control of a status line to reflect the status of the KEY line

Data Access Arrangement

The Data Access Arrangement (DAA) subsystem is the wireline interface (conventional connection to the telephone line Tip and Ring). The DAA employed in this design is transformer based.

Analog data is sent and received through direct connection to the DSP. There is a control line called !OH_VALV and is used to send the DAA on and off hook. There is a monitor line called !RING_DET that signals that the line is ringing. The !RING_DET line will monitor the ring status whether the modem is on or off hook.

!OH_VALV is controlled by the VALV34 and the !RING_DET can be monitored by either the VALV34 or the MCU (for wake up purposes).

Voice Codec

The codec subsystem provides audio communication to/from the modem. The codec device is a Lucent T7527 High-Precision PCM Codec.

Communication is made through the VALV34/DSP chipset. A control line (SW_VCODEC) is used to power down the device controlled by the VALV34.

The audio interface available on the 13pin ITT-Cannon connector consists of a differential microphone input and a differential microphone output.

Additional circuitry has been added for debug purposes to allow audible indication of AMPS signalling. This is achieved by a control line (SPKR_CTL) switchable through the VALV34 which will feed either the DAA or DISC+ analog data to the speaker output.

The microphone input is a capacitively connected differential input with an input impedance greater than 10kohm. Microphone signals should be 90 mVp-p nominal. Software volume control is available. If a single-ended drive is desired, the MIC- input may be connected to ground.

The Speaker output is a differential signal. This signal is used to interface to a speaker amplifier. Output signal is (AC-coupled) 2Vp-p nominal into a 150 ohm load.

Voice functionality is not a supported feature at this time.

AMPS Data Processor (DPROC)

The AMPS data processor utilizes a UMA1002 Data processor for cellular radio (DPROC2) device. This device handles the front end data transceiving, data processing, and SAT functions for an AMPS circuit switched call. The 9.6MHz clock is supplied from the radio interface (PIC) clock. Control is achieved by the I²C interface under the control of the MCU. Additional control and status lines are also fed into the MCU.

Power for this device is supplied from the RXON (Radio receiver subsystem) line which is controlled by the radio interface (PIC). This means that the device will only be operational when the radio receiver is switched on. RESET/MUTE/TXCTRL control lines are also controlled by the radio interface (PIC).

The radio signal into the DPROC is derived from the DISC+ line which is DC coupled and then level shifted by a potential divider. The radio signal out of the DPROC is level shifted through the I²C control of a digital potentiometer and then summed with the DSP output. This resulting signal is further level shifted through a separate channel on the digital potentiometer and the result creates the MO

Electrical Specifications

Parameter	Specification
Power Supply	+5 ± 5% VDC
Current Drain (Logic only)	maximum noise DC to 100KHz 10mVpp Wireline Inactive – 20mA Wireline Data/Fax Active – 220mA Wireline Voice Active – 250mA CSC Monitor – 60mA CSC Data/Fax Active – Full Power – 250mA CSC Voice Active – 250mA CDPD Sleep – 20mA CDPD Monitor – 150mA CDPD Active – Full Power – 160mA
Operating Temperature Range	-30 to +60°C
Storage Temperature Range	-40 to +85°C
Input High Voltage	2.5 V Min
Input Low Voltage	0.8 V Max
Output High Voltage	4.0 V Min
Output Low Voltage	0.5 V Max
MCU Frequency	Min: DC Max: 22.1184 MHz
SRAM Speed	70 ns
FLASH Speed	90 ns

SB320 Radio General Description

The TAZ! radio architecture is a cost reduced, bear bones refinement of the AirCard (aka Tomcat) radio architecture (FCC ID LL9ACRD1). This new radio platform shares the same frequency plan and virtually the same level budget as AirCard.

Key features of this narrow band FM transceiver include:

- capable of full duplex operation in the North American 800MHz cellular band (forward 869 – 894MHz; reverse 824 – 849MHz),
- supports CDPD GMSK, V.34 AMPS, voice and wideband control data modulation and demodulation,
- 30kHz channel spacing with mixture of synthesized and crystal based frequency generation,
- 600mW transmit power with six programmable power output steps (28dBm, 24dBm, 20dBm, 16dBm, 12dBm, 8dBm),

We learned a great deal about making PCMCIA cellular radios during the AirCard development and were able to use this knowledge for another kick at the development can. The principal intent behind this design was to lower material and assembly cost and improve defect rates for high volume production. To achieve the lowest possible parts cost, we eliminated all custom components and selected only high volume stable parts that were well down on their cost curves. We also placed a restriction on the power supply requirements that eliminated four voltage regulators from the original AirCard DataPhone design.

So with this basic introduction, here we go. The following sections provide sufficient detail to understand this simple radio's architecture and operation.

SB320 Radio Electrical Specifications

The TAZ! radio meets or exceeds all specification requirements of CDPD 1.1, RSS-128, and FCC Parts 15 & 22.

Table 1. Transceiver Specifications at standard temperature and pressure.

Supply Requirements	5V \pm 5% 10mVpp ripple DC to 100kHz
Current Consumption	Sleep: 1mA Receive: 45mA Transmit: 700mA
Transmit Frequency	824 to 849MHz
Receive Frequency	869 to 894MHz
Channel Spacing & Number of Channels	30kHz, 833 channels
Modes	Sleep, Receive (Standby), Full duplex transmit
Modulation	Direct FM, \pm 14kHz maximum
Modulation Frequency Response	Flat 10Hz to 10kHz (\pm 1dB)
Performance Bandwidth	25MHz
Temperature Compensated Reference Frequency & Stability	14.85MHz \pm 2.5ppm
Local Oscillator Frequency	926MHz \pm 12.5MHz
TX Output Power (Conducted)	28dBm to 8dBm in six programmable steps of 4dB
TX Spurious Outputs	Per FCC Part 22
TX ramp up/down	Per CDPD 1.1
TX Modulated LO	30MHz crystal oscillator, tripled to yield 90MHz
RX Sensitivity (Conducted)	-108dBm (CDPD 5% BLER) -116dBm (AMPS 12dB SINAD C-Message weighted, 750 μ s de-emphasis)
Receiver Intermediate Frequencies	1 ST IF 45MHz 2 ND IF 450kHz
Demodulation Frequency Response	Flat 10Hz to 10kHz (\pm 1dB)
RX Adjacent Channel Selectivity	16dB at \pm 30kHz 60dB at \pm 60kHz
RX Intermodulation Response Rejection	57dB (per CDPD 1.1) 65dB (per EIA 19-B)
RX Scan Time	60ms max band edge to band edge
RX Spurious Emissions	Per FCC Part 22
RX Unintended Emissions	Per FCC Part 15

SB320 Radio Block Diagram

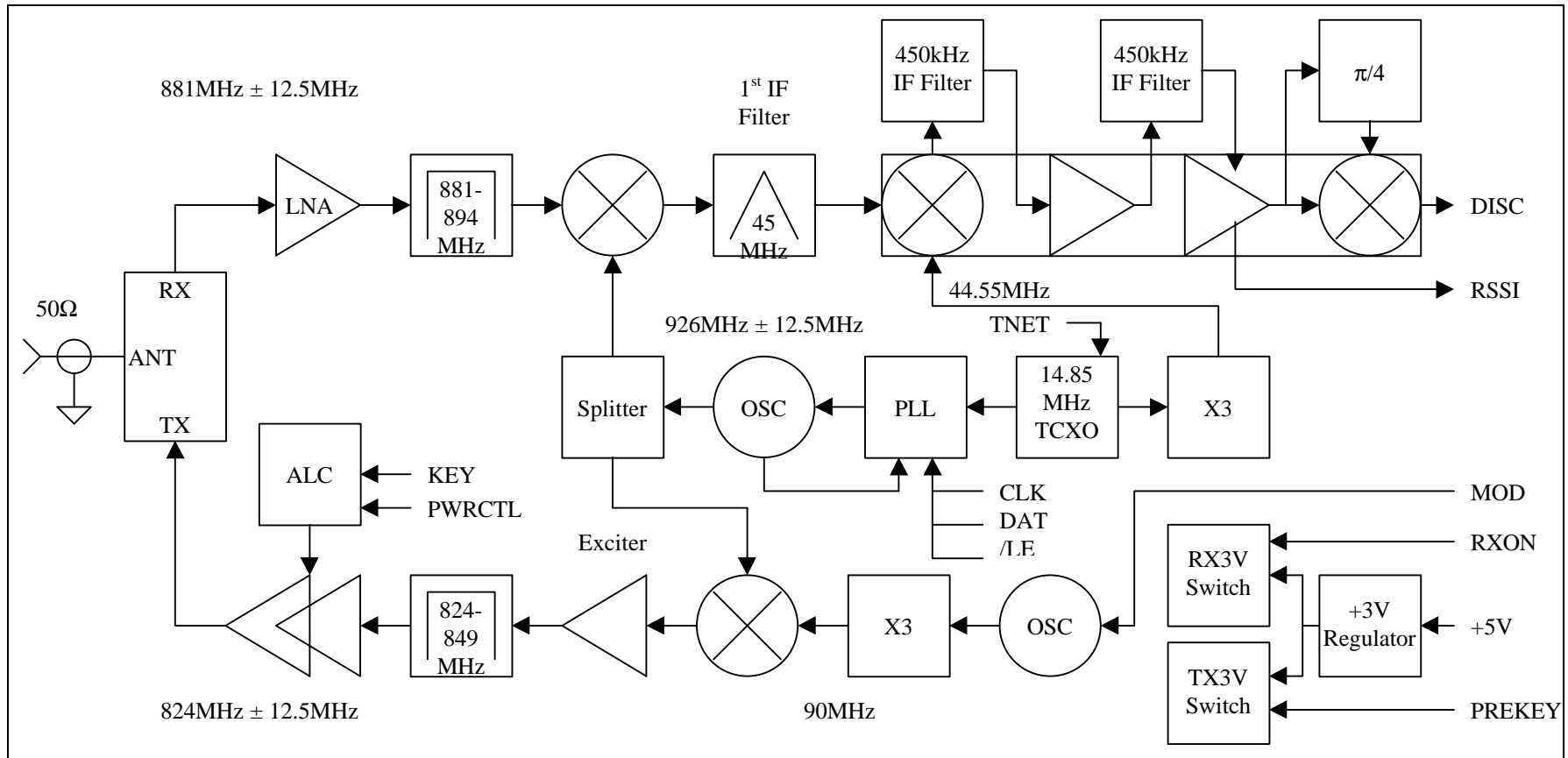

Figure 1. TAZ! Transceiver Block Diagram.

Power Supply

Consists of a single 3V linear regulator (TOKO TK11230BM) and two current switches (Zetex FMMT717 and Motorola MMBT3906LT1).

With an active high control signal from the logic (RXON) the regulator applies RX3V to the receiver, FGU, ADC, and DAC.

With an active low control signal from the logic (/PREKEY) TX3V is applied to the transmit modulator, upconverter, negative voltage generator, and PA automatic level control circuits.

Programming Interface

This is a dumb radio – there is no onboard microcontroller or memory. The radio is programmed for a desired channel through a three line SPI (Serial Peripheral Interface) port to the PLL (Phase Locked Loop).

Transmit power output is selected by a calibrated DC voltage applied to the PWRCTL line.

The RAMP signal prevents excess transient signal splatter during transmit state change. This feature is not required by any North American specification but is designed by Sierra Wireless to protect the congested electromagnetic spectrum.

Transceiver temperature and RSSI (Receiver Signal Strength Indicator) are measured by the ADC (Analog to Digital Converter; Burr-Brown ADS7841). This is also a three wire SPI programmable device.

The receiver discriminator quadrature circuit (QTUNE) and PLL reference oscillator (TNET) are both tuned by the DAC (Digital to Analog Converter, Micro Linear ML2330). This is also a three wire SPI programmable device

Frequency Generation Unit

Consists of a PLL (Phase Locked Loop, National LM1511 + Fujitsu Towa VC-3R0A20-0926-B VCO + Motorola Components KXN1398A TCXO) which generates the Receive and Transmit Local Oscillator signals (RXLO & TXLO) and a tripler circuit which generates the Receive 2ND LO from the reference oscillator (TCXO).

The PLL produces an LO at 926MHz \pm 12.5MHz. This signal is fed directly to the first down converter to produce a 45MHz 1ST IF (Intermediate Frequency). The LO is also fed to the TX mixer which when mixed with the 90MHz modulator output produces the reverse channel signal (836MHz \pm 12.5MHz).

The desired channel is selected by programming the PLL with the correct reference and main loop integer dividers. This one loop produces channel select signals for both receive and transmit paths simultaneously.

To simplify the architecture, we eliminated a 2ND LO synthesizer and generated this signal by tripling the 14.85MHz TCXO to produce 44.55MHz.

Receiver

Consists of half the duplex filter (Taiyo Yuden CFU7BA08360881 or equivalent), an LNA/MIXER GaAs front end (TriQuint TQ9223C), image filter (Murata SAFC881N5MA70N), 1st IF 45MHz crystal filter (Motorola KFN6121), and backend IF strip (Philips SA676DK).

Outputs from the receiver include: DISC+ & DISC-; and RSSI.

Transmitter

The desired reverse channel signal is produced by mixing the TXLO with a tripled output of a 30MHz crystal modulator. The crystal is modulated by the MOD signal. By its very nature a crystal has flat audio modulation response from near DC to well above 10kHz. Careful selection of this crystal was necessary to ensure both wide pullability and tight temperature stability.

The modulated sub-carrier is converted to the desired reverse channel through the upmixer (NEC UPC8106TB). The PA consists of an exciter (NEC UPC2710), noise limiter (Murata SAFC836N5MA70N), power amplifier (ITT GaAsTEK ITT3102BD), and the other half of the duplex filter.

User Manual Pages With FCC Disclaimers

Important Notice

Because of the nature of wireless communications, transmission and reception of data can never be guaranteed. Data may be delayed, corrupted (i.e., have errors) or be totally lost. Although significant delays or losses of data are rare when wireless devices such as the Sierra Wireless modem are used in a normal manner with a well-constructed network, the Sierra Wireless modem should not be used in situations where failure to transmit or receive data could result in damage of any kind to the user or any other party, including but not limited to personal injury, death, or loss of property. Sierra Wireless, Inc., accepts no responsibility for damages of any kind resulting from delays or errors in data transmitted or received using the Sierra Wireless modem, or for failure of the Sierra Wireless modem to transmit or receive such data.

©1998 Sierra Wireless, Inc. All rights reserved.

Printed in Canada.

No part of this publication may be reproduced, stored in a retrieval system, or transmitted in any form or by any means, without the prior permission of the publisher.

The Watcher software described in this manual is copyright 1996 Sierra Wireless, Inc. All rights reserved.

AT is a trademark of Hayes Microcomputer Products, Inc.

Hayes is a registered trademark of Hayes Microcomputer Products, Inc.

Windows is a trademark of Microsoft Corporation.

Microsoft is a registered trademark of Microsoft Corporation.

All other trademarks are owned by their respective companies.

The information in this manual is subject to change without notice and does not represent a commitment on the part of Sierra Wireless, Inc. Sierra Wireless, Inc. shall not be liable for incidental or consequential damages resulting from the furnishing, performance, or use of this manual.

Patents

"Portions of this product are covered by some or all of the following US patents: D367062; D372248; D372701; 5515013; 5617106; 5629960; other patents pending"

Regulatory Information

The equipment certifications appropriate to your device are marked on the device and the accompanying product specific information. Where appropriate, the use of the equipment is subject to the following conditions:

Caution

Unauthorized modifications or changes not expressly approved by Sierra Wireless, Inc. could void compliance with regulatory rules, and thereby your authority to use this equipment.

Warning (EMI) - United States

This equipment has been tested and found to comply with the limits pursuant to Part 15 of the FCC Rules. These limits are designed to provide reasonable protection against harmful interference in an appropriate installation. This equipment generates, uses, and can radiate radio frequency energy and, if not installed and used in accordance with the instructions, may cause harmful interference to radio communication. However, there is no guarantee that interference will not occur in a particular installation. If this equipment does cause harmful interference to radio or television reception, which can be determined by turning the equipment off and on, the user is encouraged to try to correct the interference by one or more of the following measures:

- Reorient or relocate the receiving antenna.
- Increase the separation between the equipment and receiver.
- Connect the equipment into an outlet on a circuit different from that to which the receiver is connected.
- Consult the dealer or an experienced radio/TV technician for help.

Warning (EMI) - Canada

This digital apparatus does not exceed the limits for radio noise emissions from digital apparatus set out in the radio interference regulations of the Canadian Department of Communications.

"Cet appareil numérique respecte les limites de bruits radioélectriques applicables aux appareils numériques de Classe B prescrites dans la norme sur le matériel brouilleur: 'Appareils Numériques', NHB-003 édictée par le ministre des Communications."

RSA Licensee



If you have purchased this product under a United States Government contract, it shall be subject to restrictions as set forth in subparagraph (c)(1)(ii) of Defense Federal Acquisitions Regulations (DFARs) Section 252.227-7013 for Department of Defense contracts and as set forth in Federal Acquisitions Regulations (FARs) Section 52.227-19 for civilian agency contracts or any successor regulations. If further government regulations apply, it is your responsibility to ensure compliance with such regulations.

Safety and Hazards

Do not operate the Sierra Wireless modem in areas where blasting is in progress, where explosive atmospheres may be present, near medical equipment, near life support equipment, or any equipment which may be susceptible to any form of radio interference. In such areas, the Sierra Wireless modem **MUST BE TURNED OFF**. The Sierra Wireless modem can transmit signals, which could interfere with this equipment.

Do not operate the Sierra Wireless modem in any aircraft, whether the aircraft is on the ground or in flight. In aircraft, the Sierra Wireless modem **MUST BE TURNED OFF**. The reason for this is that when operating in the CDPD or cellular circuit switched mode, the Sierra Wireless modem can transmit signals that could interfere with various onboard equipment systems.

The driver or operator of any vehicle should not operate the Sierra Wireless modem while in control of a vehicle. Doing so will detract from the driver or operator's control and operation of that vehicle. In some states and provinces, operating such communications devices while in control of a vehicle is an offence.

Calculation of Necessary Bandwidth for FCC ID: EA93837

For CDPD 19.2Kbps Transmission (emission type FXW)

The data rate is 19200 bits per second.

Necessary Bandwidth = $2M + 2DK$

$M = 10$ kHz

$D = 4.8$ kHz

$K = 1.2$

So necessary bandwidth = $2 \times 10 + 2 \times 4.8 \times 1.2 = 31.5$ kHz

For AMPS Wideband Data Mode (emission type F1D)

The data rate is 10,000 bits per second.

Necessary Bandwidth = $2M + 2DK$

$M = 10.4$ kHz

$D = 8.0$ kHz

$K = 1.2$

So necessary bandwidth = $2 \times 10.4 + 2 \times 8 \times 1.2 = 40$ kHz

For AMPS Voice Channel Transmission for Modem Signaling (emission type F9W)

The data rate is 14,400 bits per second. This is the highest data rate achievable in this mode of operation.

Necessary Bandwidth = $2M + 2DK$

$M = 6.0$ kHz (includes 300Hz to 3000Hz information bandwidth + SAT tone at 6kHz)

$D = 14.0$ kHz (12kHz for voice band information + 2kHz for SAT)

$K = 1$ (per 2.202(g) III 2)

So necessary bandwidth = $2 \times 6 + 2 \times 14 \times 1 = 40$ kHz

Performance Test Data

RF Output Power (2.985)

Name of Test:	RF Power Output
FCC ID:	EA93837
Grantee:	Sierra Wireless
Serial No.:	20600052674
Manufacturing Rating:	0.00631 to 0.631 Watt +8dBm to +28dBm in 4 dB steps (Controlled by Cell Base Station)
Equipment Authorization Procedure:	Para. 2.985(a)
Test Equipment:	HP8920B Communications Test Set HP3631A DC power supply Zegna 486 PC Computer
Duty Cycle:	Portable (intermittent)

Block Diagram of Test Set-up

The computer is used to select the channel and key the transmitter.

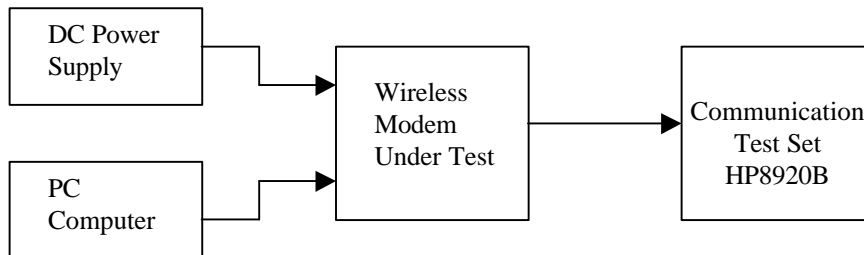

Final Radio Frequency Amplifying Device

ITT333102BD

ITT PA Module

	LOW POWER	HIGH POWER
Drain Current, (I_C) =	85 mA	445 mA
Drain Voltage, (V_C)=	4.8 V	4.8 V
Total Transmitter Load	105 mA	465 mA
DC Input Voltage	5.0 V	5.0 V
Power Input = (I_C)(V_C) = P_{in} =	0.408 W	2.14 W
Measured Power Output = P_{out} =	7.95 dBm	27.3 dBm
Rated Power Output	8.0 dBm	28.0 dBm

Occupied Bandwidth (2.989)

Name of Test:	Occupied Bandwidth
FCC ID:	EA93837
Grantee:	Sierra Wireless
Serial No.:	20600052674
Minimum Standard Specified	Para. 22.907 (b) and (d)
Test Results	Equipment is Compliant with Standard
Equipment Authorization Procedure	Para 2.989 (c)(1)
Test Equipment:	HP8593E Spectrum Analyzer HP3631A DC power supply Zegna 486 PC Computer

Test Setup Block Diagram

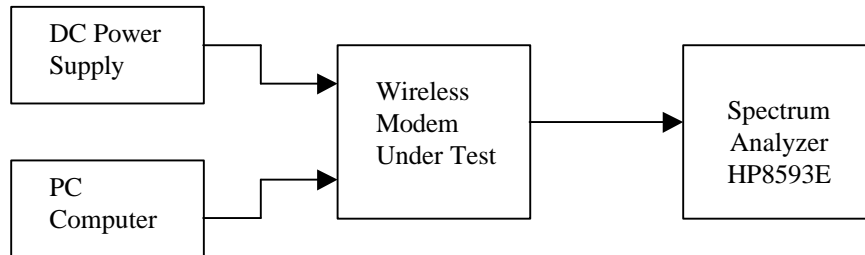

Measurement Data

Spectrum Analyzer:
Settings:

Hewlett Packard 8593E
 Resolution Bandwidth 300 Hz
 Video Filter 300 Hz
 Scan Time 3.33 sec
 Scan Width 100 kHz
 Center Frequency 837.00 MHz

Data Or Signaling Type

- 1) CDPD, Cellular Digital Packet Data (19.2 baud)
- 2) SAT, Supervisory Audio tone (6 kHz Tone)
- 3) ST, (10 kHz Tone)
- 4) Control Channel Wide Band Data
- 5) Voice Channel/Modem Signaling (14.4 baud)

Tx Deviation

4.8 kHz
 2.0 kHz
 8.0 kHz
 8.0 kHz
 14.0 kHz

Emission Designator

31K5FXW
 40K0F9W
 40K0F9W
 40K0F1D
 40K0F9W

CDPD - Low Power

CDPD (FXW) Occupied Spectrum - 2.989

12/03/98 SB300 serial# 0x9B356A5F 19.2kbps, 4.8kHz Deviation, 8dBm Output Power

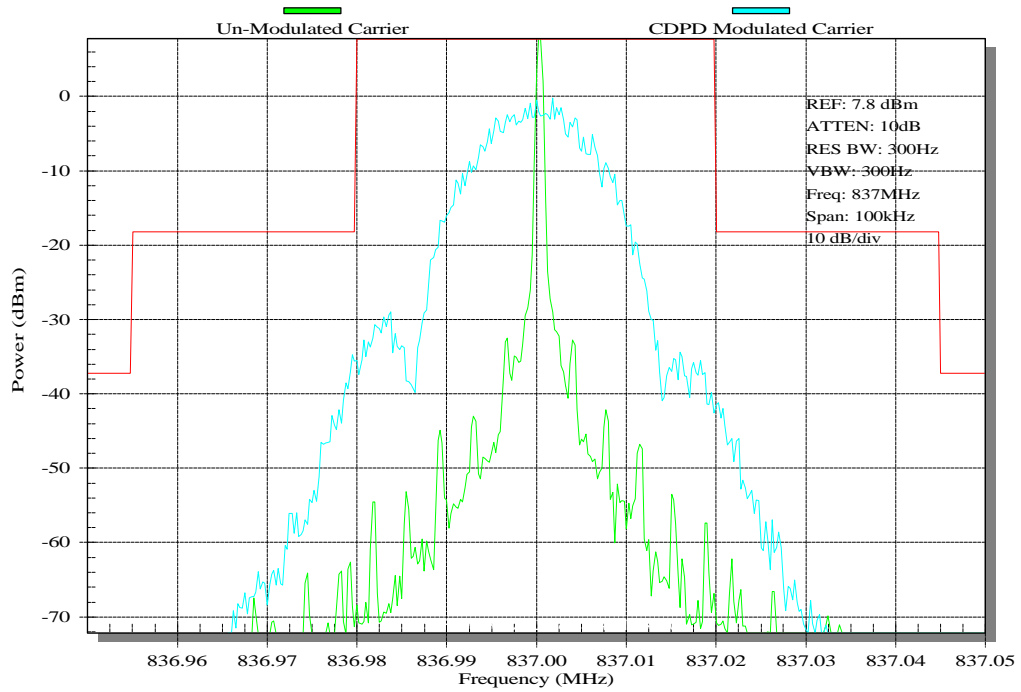

CDPD - High Power

CDPD (FXW) Occupied Spectrum - 2.989

12/03/98 SB300 serial# 0x9B356A5F 19.2kbps, 4.8kHz Deviation, 28dBm Output Power

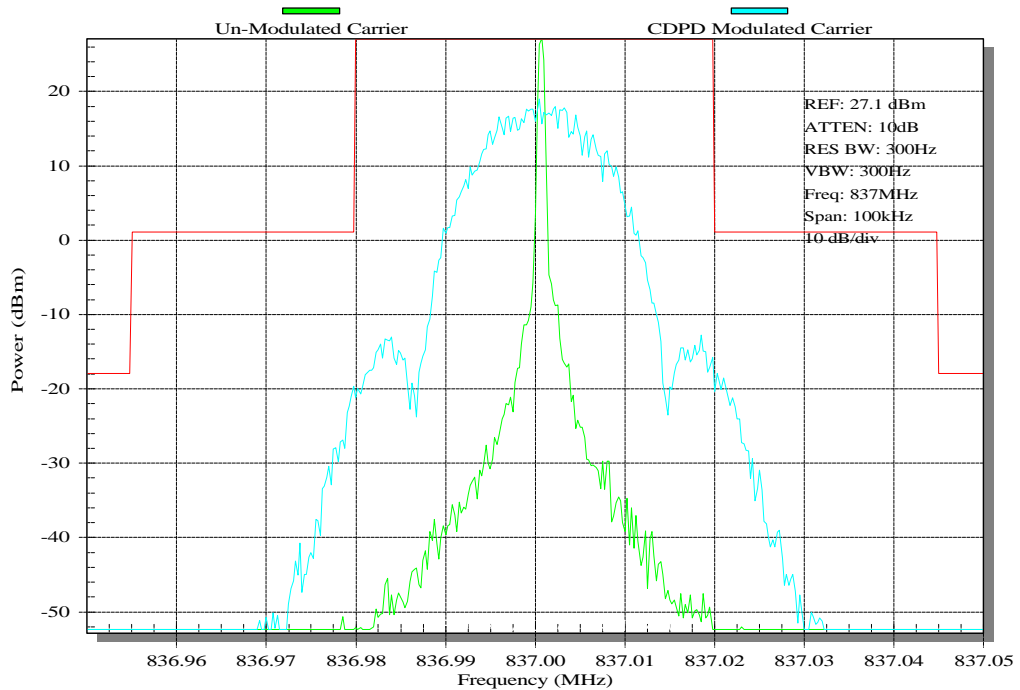

AMPS Voice - Low Power

AMPS (F9W) Occupied Spectrum - 2.989

12/03/98 SB320 serial# 0x9B3546AA 14.4kBaud, 8kHz Deviation, 8dBm Output Power

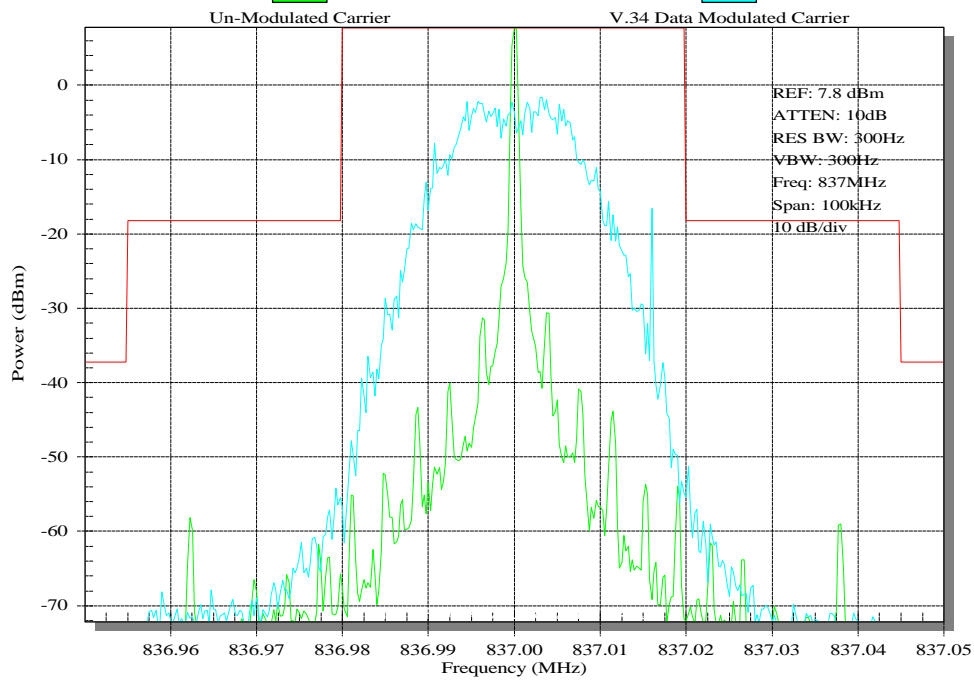

AMPS Voice - High Power

AMPS (F9W) Occupied Spectrum - 2.989

12/03/98 SB320 serial# 0x9B3546AA 14.4kBaud Data, 8kHz Deviation, 28dBm Output Power

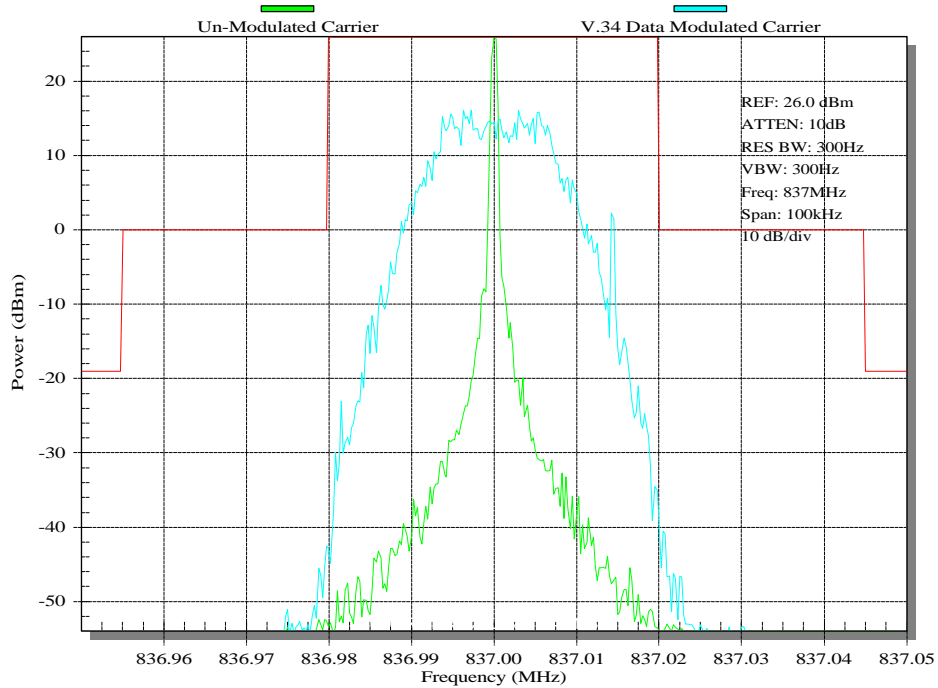

AMPS Signaling - Low Power

AMPS (F1D) Occupied Spectrum - 2.989

12/03/98 SB320 serial# 0x9B3546AA 10kBaud Data, 8kHz Deviation, 8dBm Output Power

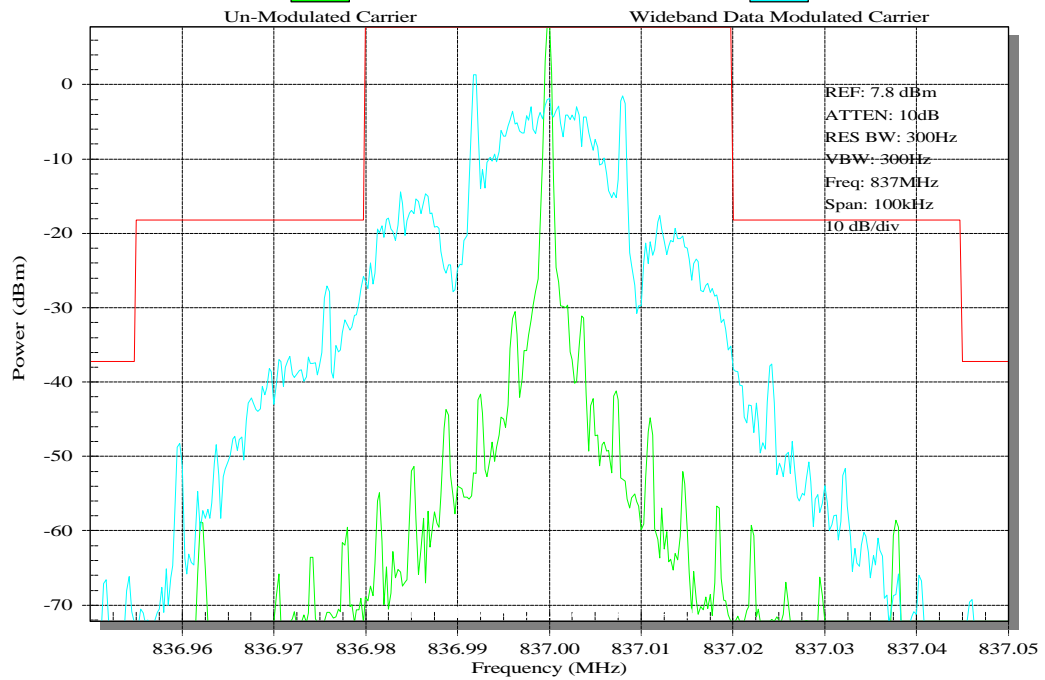

AMPS Signaling - High Power

AMPS (F1D) Occupied Spectrum - 2.989

12/03/98 SB320 serial# 0x9B3546AA 10kBaud Data, 8kHz Deviation, 28dBm Output Power

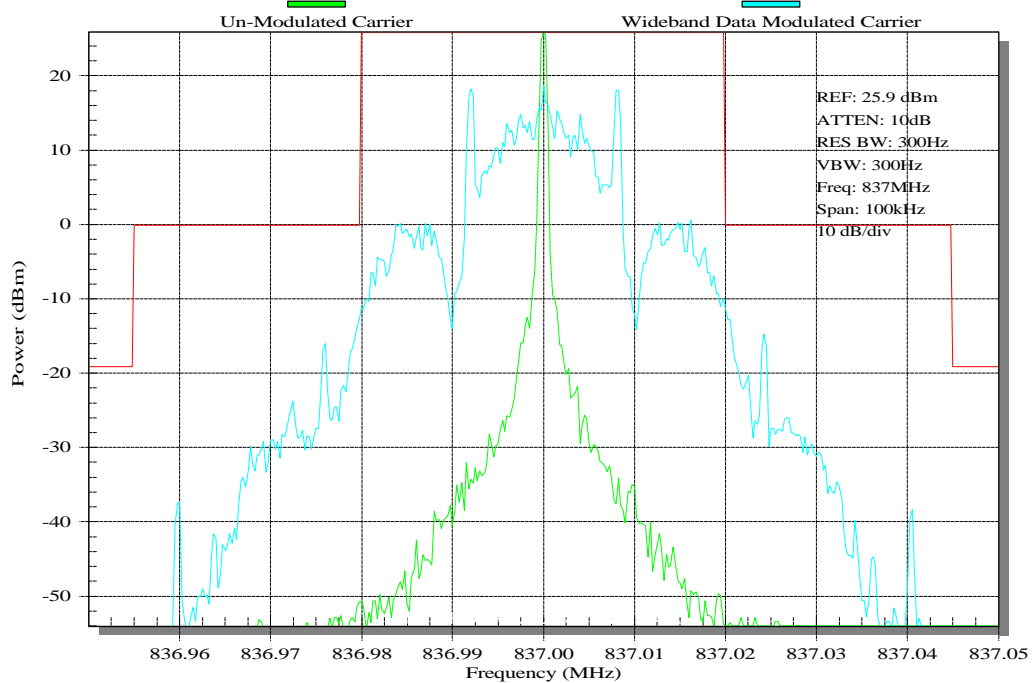

AMPS SAT - Low Power

AMPS SAT Tone Occupied Spectrum - 2.989

12/03/98 SB320 serial# 0x9B3546AA 6kHz Tone, 2kHz Deviation, 28dBm Output Power

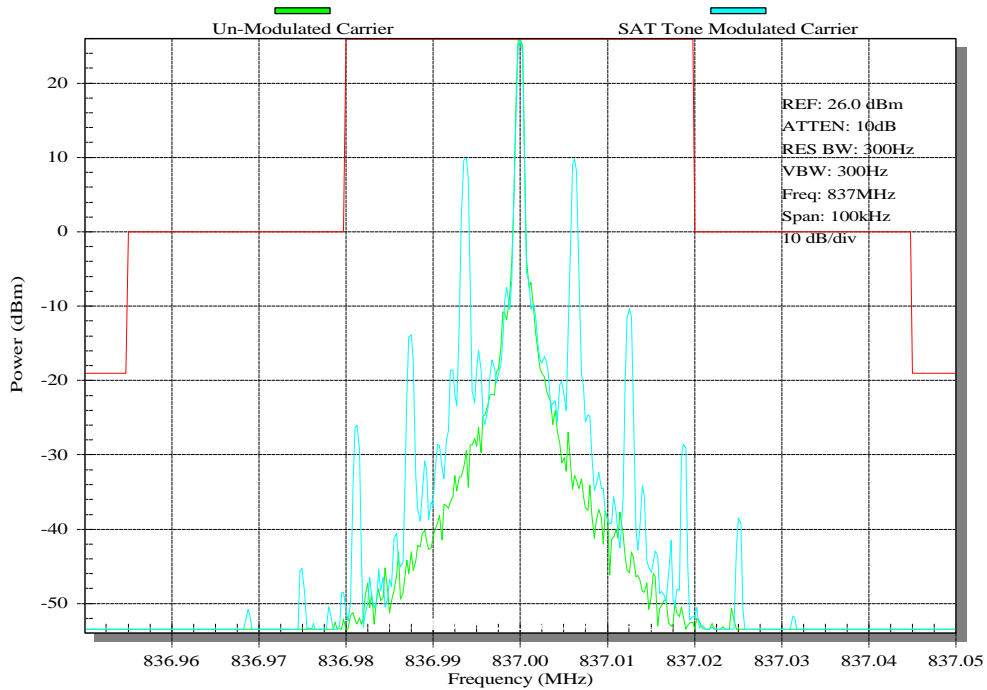

AMPS SAT – High Power

AMPS SAT Tone Occupied Spectrum - 2.989

12/03/98 SB320 serial# 0x9B3546AA 6kHz Tone, 2kHz Deviation, 8dBm Output Power

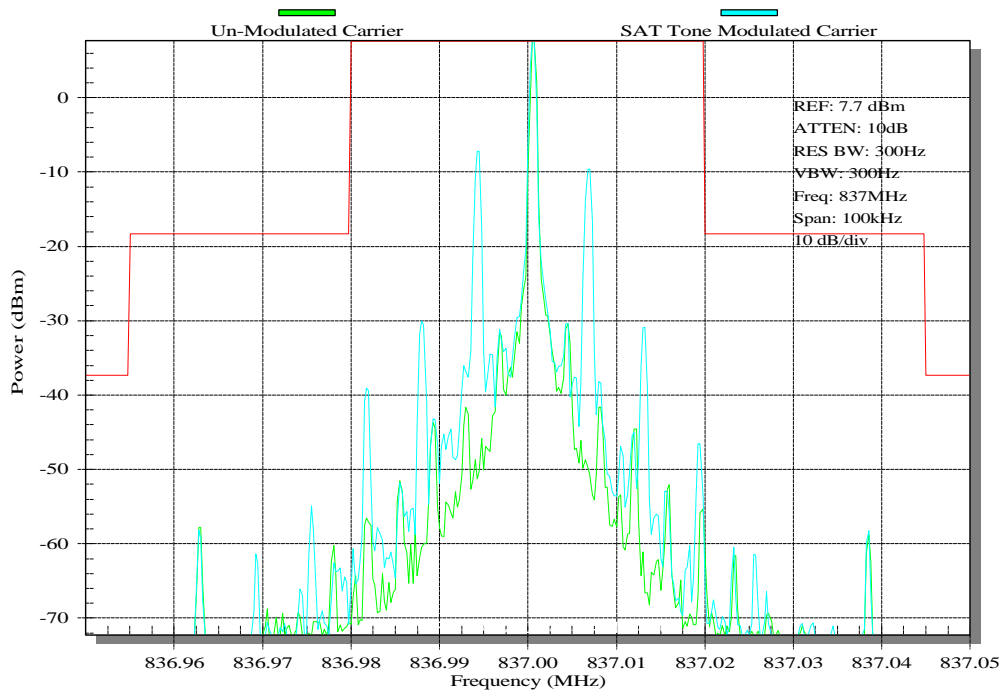

ST Tone – Low Power

AMPS ST Tone Occupied Spectrum - 2.989

12/03/98 SB320 serial# 0x9B3546AA 10kHz Tone, 8kHz Deviation, 8dBm Output Power

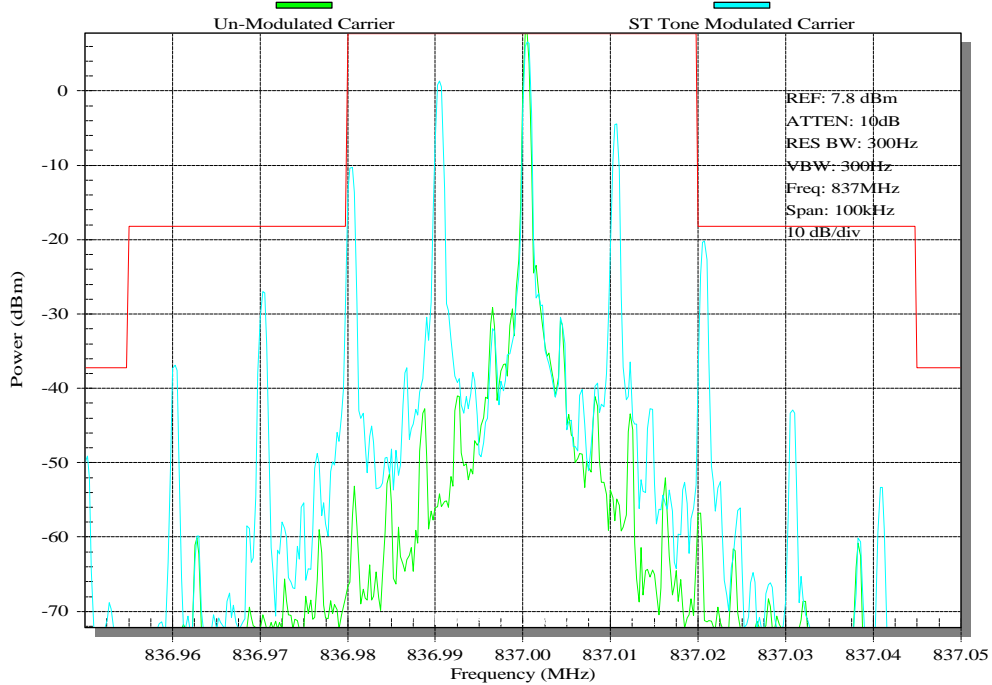

ST Tone – High Power

AMPS ST Tone Occupied Spectrum - 2.989

12/03/98 SB320 serial# 0x9B3546AA 10kHz Tone, 8kHz Deviation, 28dBm Output Power

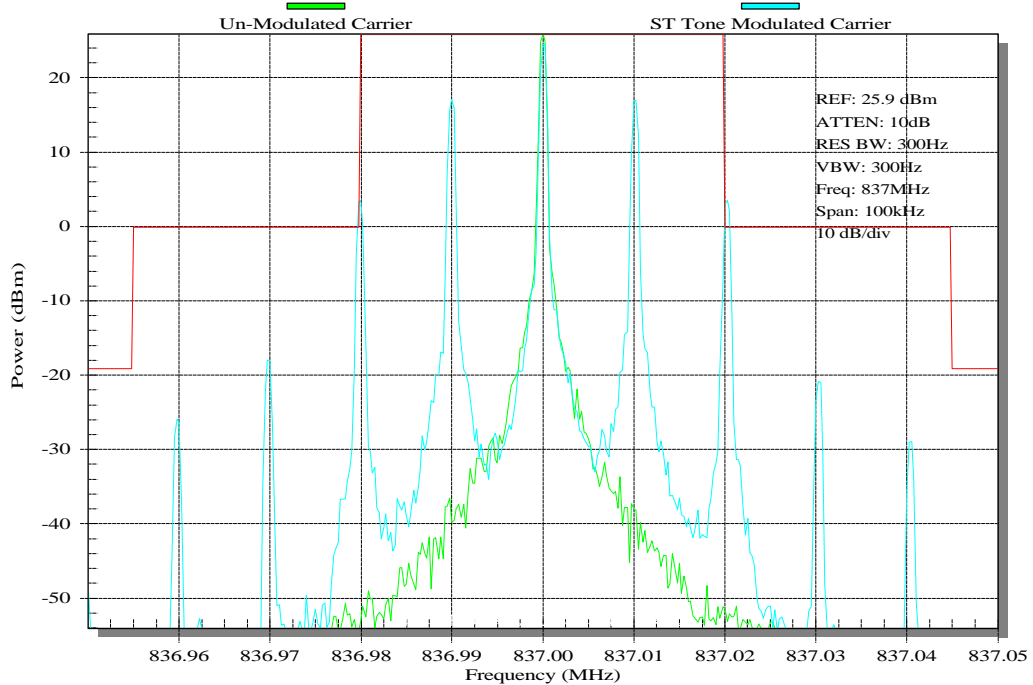

Spurious Emissions at Antenna Terminals (2.991)

Name of Test:	Spurious Emissions at Antenna Terminals
FCC ID:	EA93837
Grantee:	Sierra Wireless
Serial No.:	20600052674
Minimum Standard Specified	Para. 22.106
Test Results	Equipment Compliant with Standard
Equipment Authorization Procedure	Para. 2.993
Frequency Range Observed	0 to 9 GHz
Operating Frequency	837.000 MHz
Crystal Frequency	14.85 MHz TCXO
Power Output	0.00631 to 4.0 Watt (8 to 36 dBm) in 4 dB steps
Spurious Limit = 43dB + 10Log₁₀ (P_O)	-21 to -41 dBm
=	

Test Setup Block Diagram

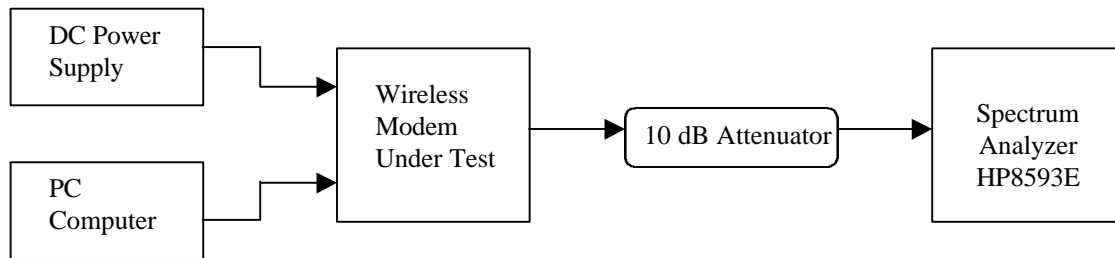

Measurement Data

Formula	Frequency (MHz)	Level (dB below carrier)	
		Low Power	High Power
f _o	837.0	- 0 -	- 0 -
2f _o	1647.0	-	-
3f _o	2511.0	-	-
4f _o	3348.0	-	-
7f _o	5859.0	-	-
8f _o	6696.0	-	-

Note: All emissions were greater than 20dB below the spurious limit. Plots of the spurs reported in the table can be seen on the following 2 pages.

Low Power (8dBm Nominal)

Spurious Emissions at Antenna Terminals - 2.991

12/03/98 SB320 serial# 0x9B3546AA 19.2kbps, 4.8kHz Deviation, 8dBm Output Power

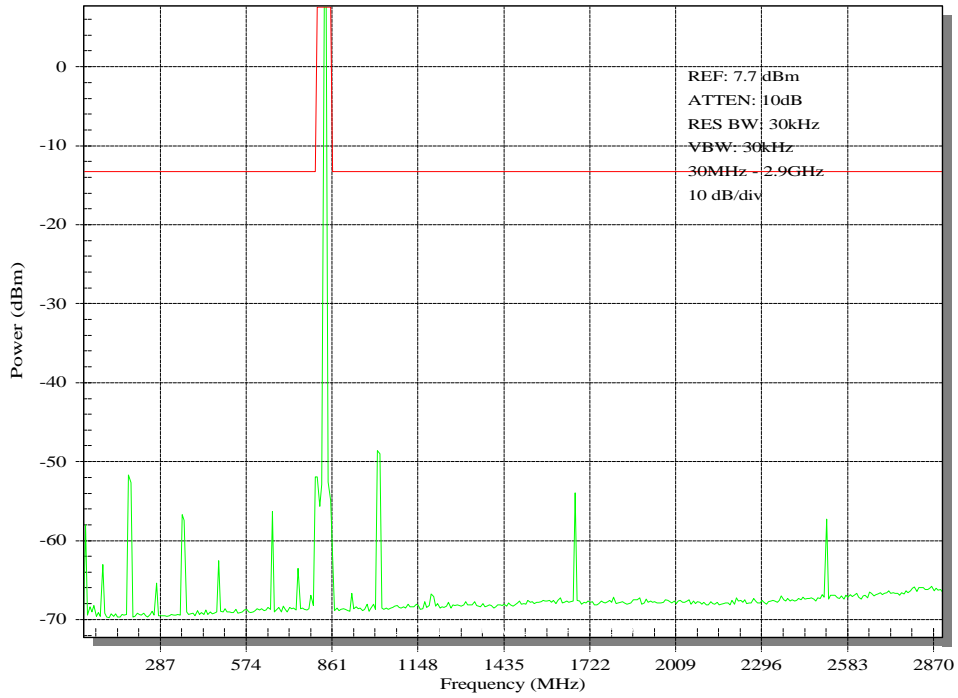

Spurious Emissions at Antenna Terminals - 2.991

12/03/98 SB320 serial# 0x9B3546AA 19.2kbps, 4.8kHz Deviation, 8dBm Output Power

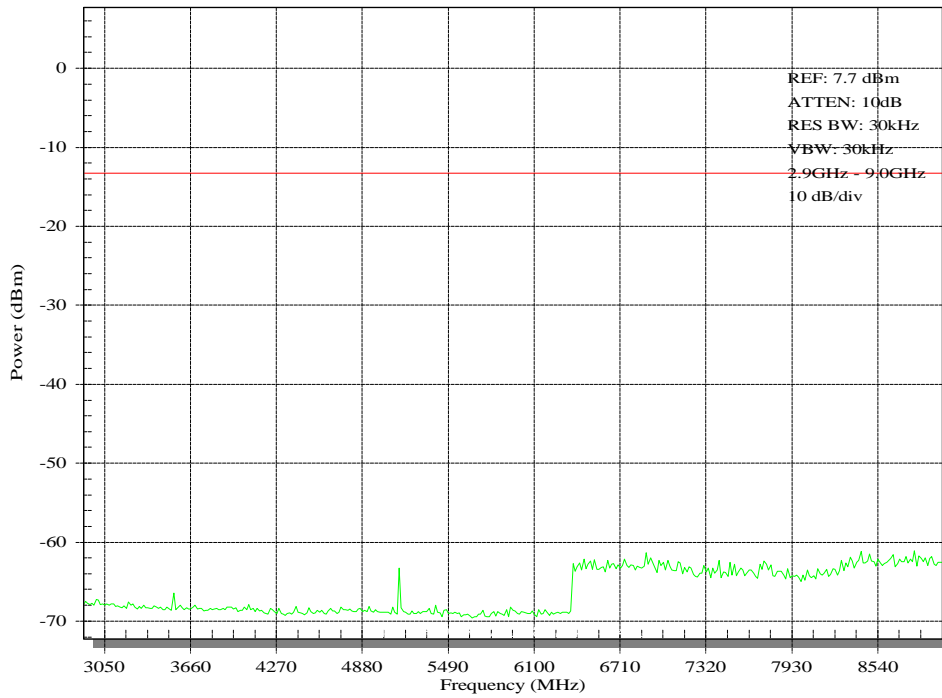

Spurious Emissions at Antenna Terminals - 2.991

12/08/98 SB320 serial# 0x9B3546AA 19.2kbps, 4.8kHz Deviation, 8dBm Output Power

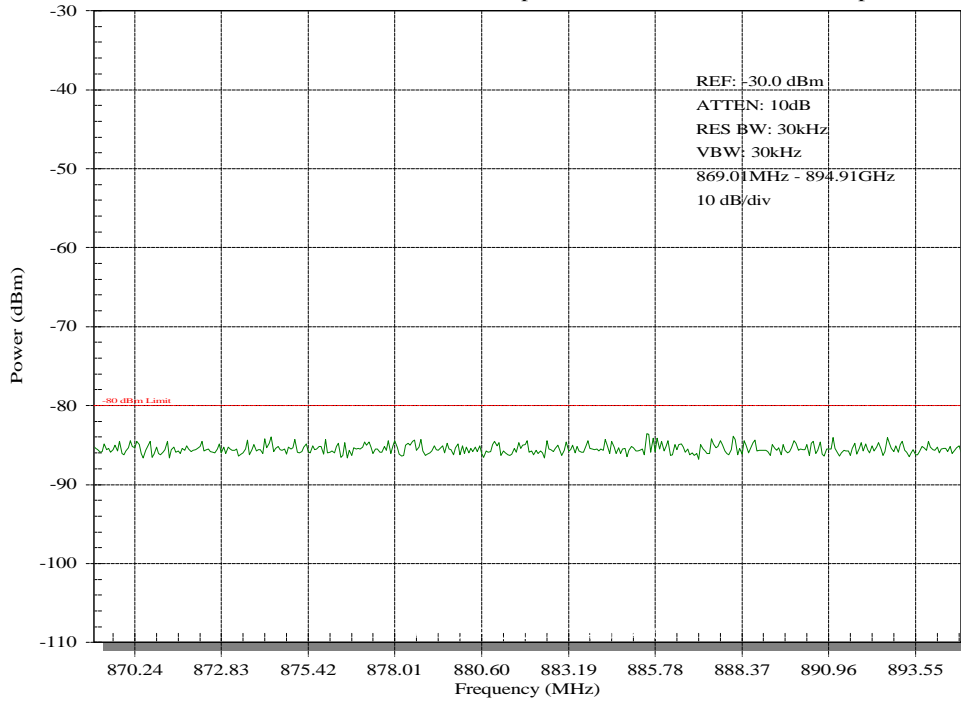

High Power (28dBm Nominal)

Spurious Emissions at Antenna Terminals - 2.991

12/03/98 SB320 serial# 0x9B3546AA 19.2kbps, 4.8kHz Deviation, 28dBm Output Power

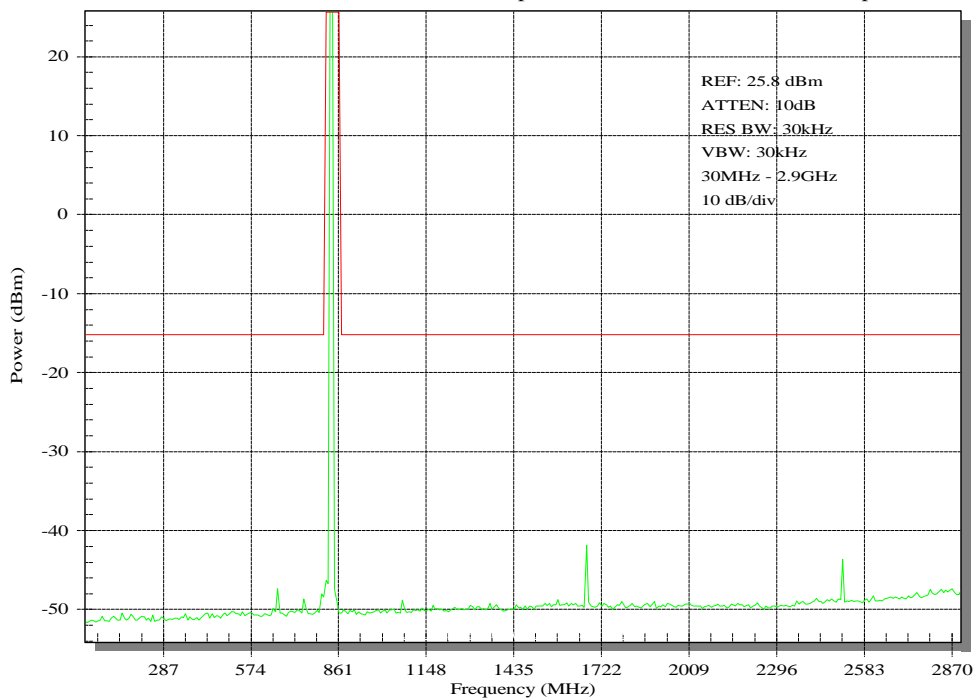

Spurious Emissions at Antenna Terminals - 2.991

12/08/98 SB320 serial# 0x9B3546AA 19.2kbps, 4.8kHz Deviation, 28dBm Output Power

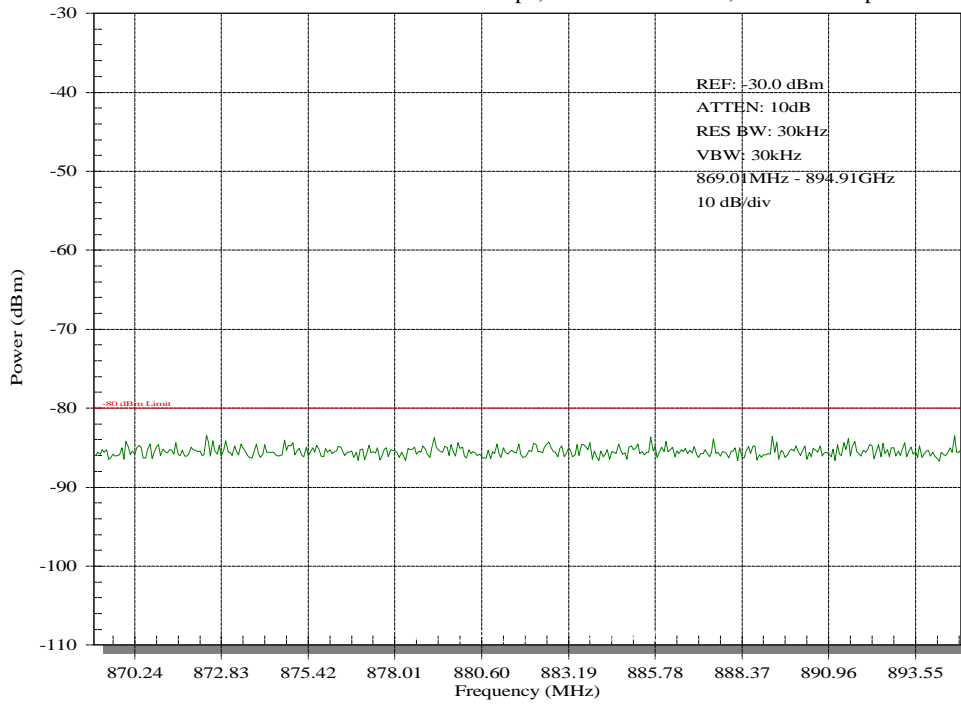

Spurious Emissions at Antenna Terminals - 2.991

12/03/98 SB320 serial# 0x9B3546AA 19.2kbps, 4.8kHz Deviation, 28dBm Output Power

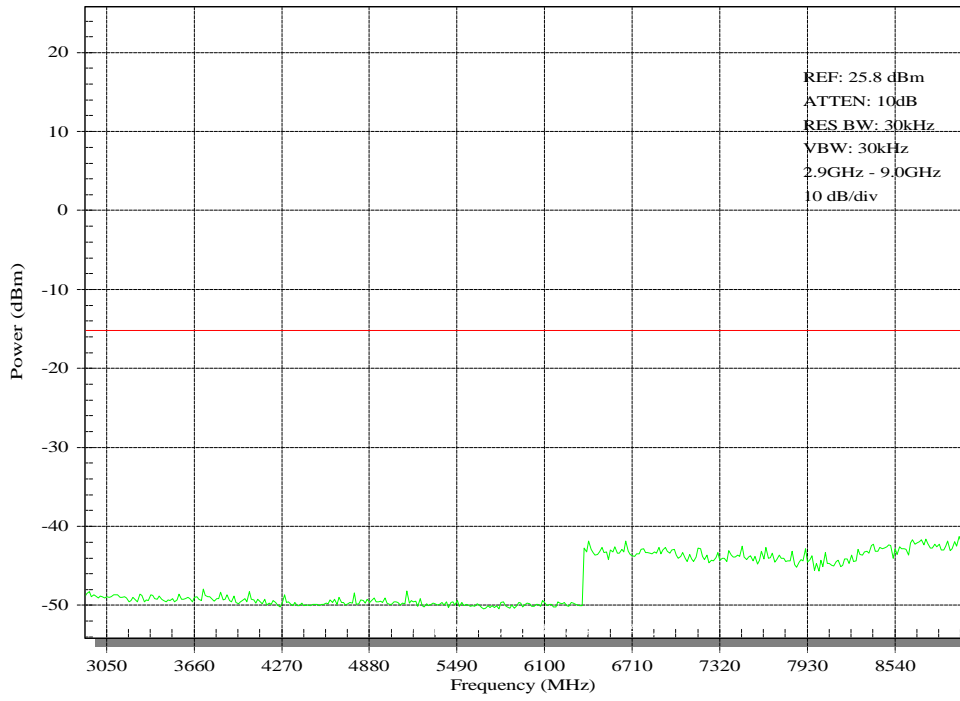

Field Intensity Measurements of Spurious Radiation (2.993)

Name of Test:	Field Intensity Measurements of Spurious Radiation
FCC ID:	EA93837
Grantee:	Sierra Wireless
Serial No.:	20600052674
Minimum Standard Specified	Para. 22.106
Test Results	Equipment is Compliant with Standard
Equipment Authorization Procedure	Para. 2.993
Frequency Range Observed	0 MHz to 9 GHz
Spurious Limit = $43\text{dB} + 10\text{Log}_{10} P_{\text{O}}$	-21 to -49 dB

Note: This test was performed at:

**Intertek Testing Services NA Inc.
1365 Adams Court
Menlo Park, CA 94025**

Operation Stability Performance (2.995)

Name of Test:	Operational Stability Performance
FCC ID:	EA93837
Grantee:	Sierra Wireless
Serial No.:	20600052674
Minimum Standard Specified	Para. 22.101 (a)
Equipment Authorization Procedure	Para. 2.995
Test Results	Equipment is Compliant with Standard
Test Equipment	HP8920B Cell Site Test Set Tenney Jr environmental chamber HP3631A DC power supply Zegna 486 PC Computer
Standard Test Frequency	837.00 MHz

Notes : Tolerance = +/- 2091 Hz or 2.5 ppm

Block Diagram of Test Set-up

Measurements were performed using an automated test facility which includes a switch matrix to route transmitter power to the test set. Path loss is accounted for automatically in our test software.

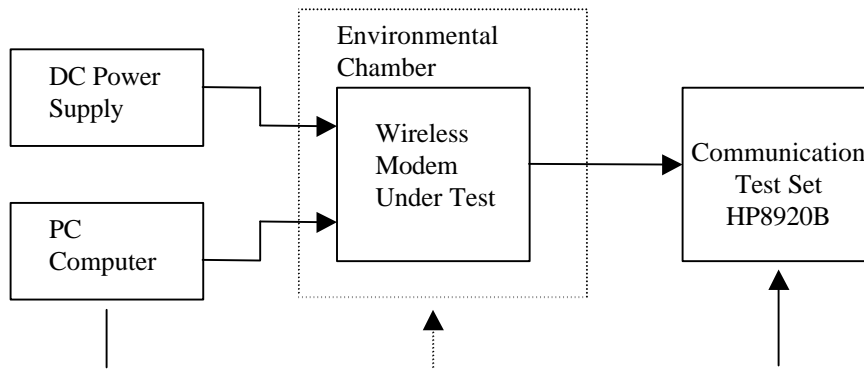

EUT set up in test chamber with temperature probe located adjacent to EUT in chamber center to observe ambient.

NOTE: The EUT has an internal voltage detector which disables the modem if power supply deviates more the 0.25V from nominal. Testing was therefore performed at nominal voltage (5.0V) and the upper and lower threshold of operability permitted by the voltage supervisor, 5.25V and 4.75V respectively.

Measurement Data

Table 1: Tx Stability Varying +5V Supply

Temp (°C)	Freq. Stability (rated voltage 5.0V) (ppm)	Freq. Stability (max voltage 5.25V) (ppm)	Freq. Stability (min. voltage 4.75V) (ppm)	Worst Case Relative to Rated Freq. Stability (ppm)
-30	-0.50	-0.53	-0.52	-0.53
-20	-0.75	-0.76	-0.75	-0.76
-10	-0.64	-0.64	-0.65	-0.65
0	-0.51	-0.49	-0.49	-0.51
10	-0.03	-0.04	-0.03	-0.04
20	0.31	0.31	0.31	0.31
30	0.86	0.87	0.86	0.87
40	1.22	1.23	1.22	1.23
50	1.59	1.59	1.58	1.59
60	1.86	1.85	1.86	1.86
70	2.00	2.01	2.01	2.01
80	1.43	1.43	1.43	1.43

Worst case frequency error found was 2.01 ppm which falls within the minimum standard of +/- 2.5 ppm.

Frequency Stability over Temperature and Voltage - 2.995

12/10/98 SB320 serial# 0x9B3546AA

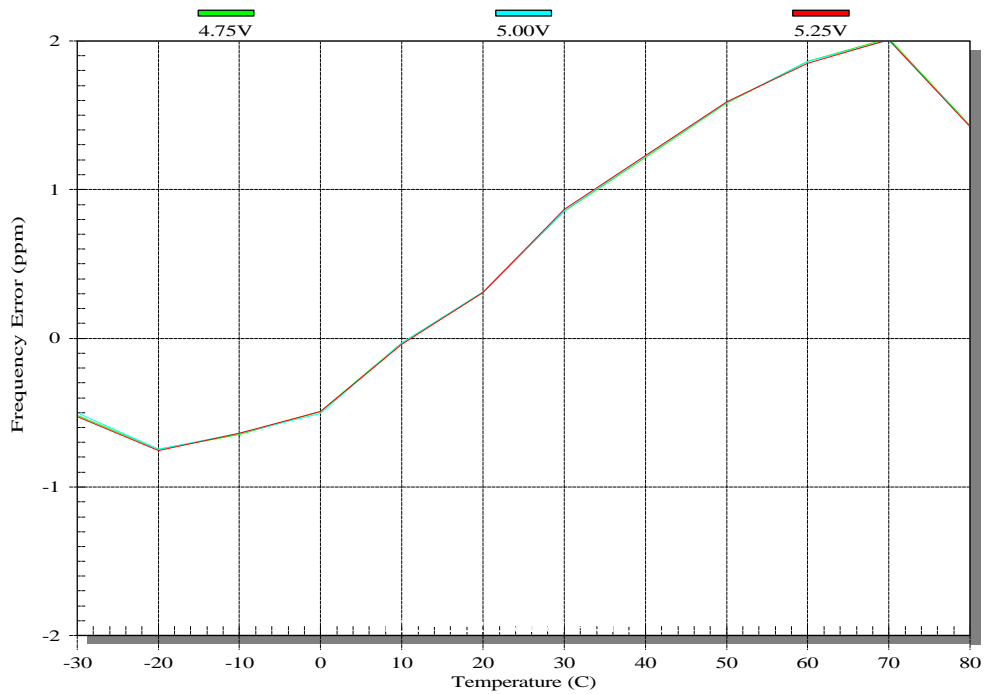

Test Equipment List

Sierra Wireless, Inc.

<u>Type</u>	<u>Manufacturer and Model No.</u>	<u>Serial no.</u>	<u>Accuracy</u>
Spectrum Analyzer	Hewlett Packard HP8593E Opt. 041, 101, 130	3801A03362	
Cell Site Test Set	Hewlett Packard HP8920B Opt. 001, 004, 006, 013, 102	US37423716	0.05PPM +/-1Hz, +/- 5% +/-0.01mW
Power Supply	Hewlett Packard HP3631A	KR53600263	DCV +/- 0.1% +5mV
Multimeter	Hewlett Packard HP3457A	3114A14978	
Attenuators	Mini-Circuits CAT-10	9406 13	
Thermometer	Fluke 52	3965185	+/- (0.1% reading +/-0.7 deg C)

FCC Sample Label

Finished Product Label:

See the photos accompanying this report for the layout and positioning of the FCC label.

Finished Product Label Location:

See the photos accompanying this report for the layout and positioning of the FCC label.