



MiniCard 8765 Partial Test Report

For

Industry Canada and FCC Certification

IC: 2417C-MC8765
FCC ID: N7NMC8765

Prepared by
SIERRA WIRELESS INC.
13811 WIRELESS WAY
RICHMOND, BC V6V 3A4
CANADA

Test Date(s): November 9, 2005

© 2004 Sierra Wireless, Inc.

This document contains information which is proprietary and confidential to Sierra Wireless, Inc. Disclosure to persons other than the officers, employees, agents, or subcontractors of the Company or licensee of this document without the prior written permission of Sierra Wireless, Inc. is strictly prohibited.

Table of Contents

1	Introduction and Purpose	3
2	Test Summary	3
3	Description of Device Under Test	4
4	RF Power Output	5
4.1	<i>Test Procedure</i>	5
4.2	<i>Test Equipment</i>	5
4.3	<i>Test Results GSM/EDGE</i>	6
4.4	<i>Test Results UMTS</i>	6
5	Occupied Bandwidth	7
5.1	<i>Test Procedure</i>	7
5.2	<i>Test Results</i>	7
5.3	<i>Test Plots</i>	8
6	Out of Band Emissions at Antenna Terminals	17
6.1	<i>Test Procedure</i>	17
6.2	<i>Test Equipment</i>	17
6.3	<i>Test Results</i>	18
6.4	<i>Test Plots</i>	19
7	Block Edge Compliance	55
7.1	<i>Test Procedure</i>	55
7.2	<i>Test Equipment</i>	55
7.3	<i>Test Results</i>	55
7.4	<i>Test Plots</i>	56
8	Frequency Stability Versus Temperature	62
8.1	<i>Summary of Results</i>	62
8.2	<i>Test Procedure</i>	62
8.3	<i>Test Equipment</i>	62
8.4	<i>Test Results</i>	63
9	Frequency Stability Versus Voltage	69
9.1	<i>Summary of Results</i>	69
9.2	<i>Test Procedure</i>	69
9.3	<i>Test Equipment</i>	69
9.4	<i>Test Results</i>	70

SIERRA WIRELESS, INC.

FCC Part 22 & 24 Test Report	MC8765	Nov. 9, 2005	Page 3 of 72
------------------------------	--------	--------------	--------------

1 Introduction and Purpose

This document provides the FCC test data for the MC8765 wireless modem. The tests included in this report are limited to all conducted tests required. The radiated tests were performed at an external test facility.

2 Test Summary

FCC RULE	DESCRIPTION OF TEST	RESULT	PAGE
2.1046	RF Power Output	Complies	5
2.1049	Occupied Bandwidth	Complies	7
2.1051, 22.901(d) 22.917, 24.238(a)	Out of Band Emissions at Antenna Terminals	Complies	17
FCC part 22H/24E	Block Edge Requirements	Complies	43
2.1053	Field Strength of Spurious Radiation	Complies	See CCS Report
2.1055	Frequency Stability versus Temperature	Complies	61
2.1055	Frequency Stability versus Voltage	Complies	66

The tests described in this report were performed by Mr. Philip Wright at:

Sierra Wireless, Inc.
13811 Wireless Way
Richmond, B.C. V6V 3A4
Canada

SIERRA WIRELESS, INC.

FCC Part 22 & 24 Test Report	MC8765	Nov. 9, 2005	Page 4 of 72
------------------------------	--------	--------------	--------------

3 Description of Device Under Test

The Sierra Wireless Inc. model MiniCard MC8765 is a quad-band USB wireless modem operating on the GSM/GPRS/EDGE/UMTS network. In the US and Canada, only cellular and PCS bands are used for GSM/GPRS operation, so this test report only contains data for these two bands (850MHz and 1900MHz). The DUT was tested in all modes of operation: GMSK modulation, 8-PSK, and WCDMA modulation. The DUT is a production sample and the serial number is: S2128751015E2

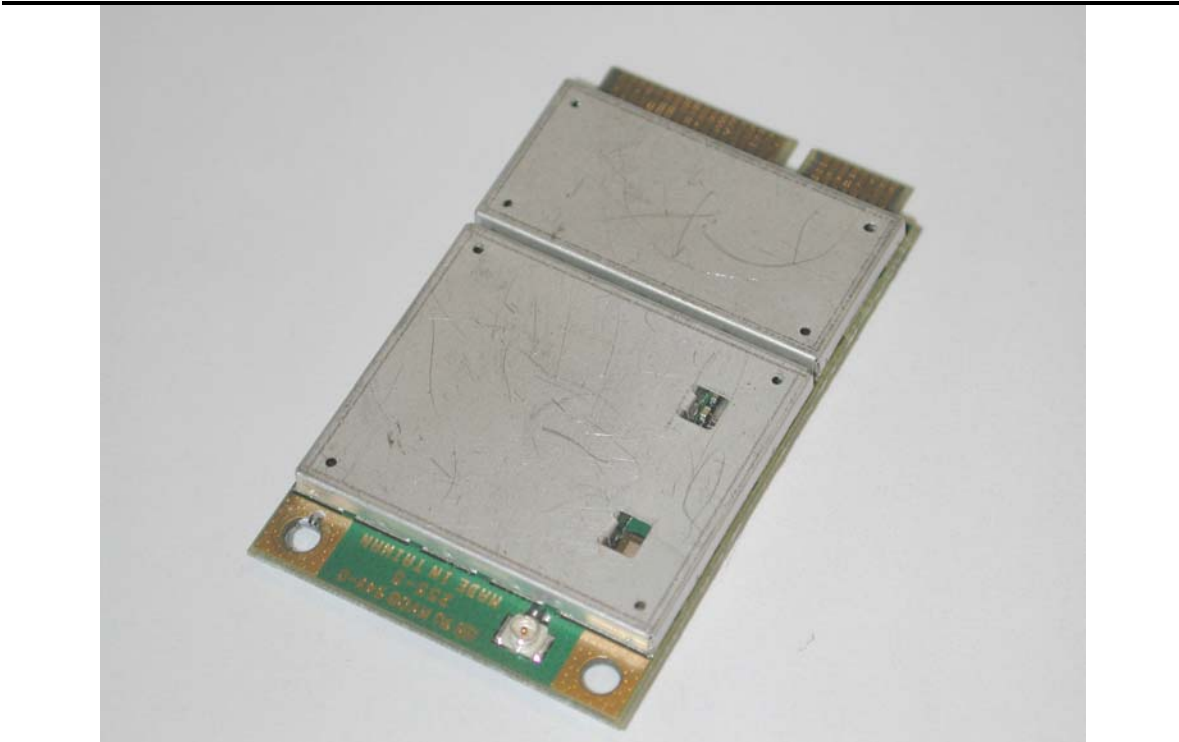

SIERRA WIRELESS, INC.

4 RF Power Output

FCC 2.1046

4.1 Test Procedure

The transmitter output was connected to a Rohde & Schwarz CMU200 Test Set and configured to operate at maximum power in a call. The power was measured using the spectrum analyzer at three equally spaced operating frequencies for each band. The RBW was set to 300 KHz for the GSM and EDGE measurements, and 5MHz for the WCDMA measurements. The spectrum analyzer was set to measure the RF output power with the cable and coupler losses accounted for.

Test Setup

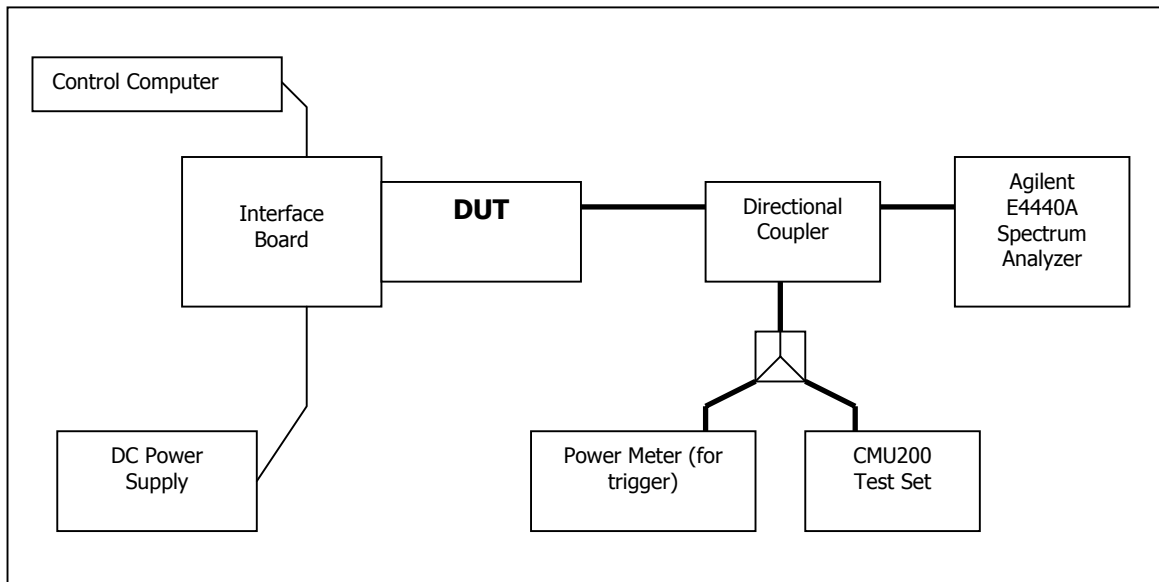

4.2 Test Equipment

Instrument List

EQUIPMENT	MANUFACTURER	MODEL NO.	SERIAL NO.	CAL. DATE
Control Computer	TC	Generic PC	100488	N/A
Wireless Test Set	Rohde & Schwarz	CMU200	836766/030	N/A
Spectrum Analyzer	Agilent	PSA E4440A	US41421268	Sept. 29, 2004
DC Power Supply	HP	6632A	3530A	N/A
Interface Board	Shop built	Minnow	N/A	N/A
Directional Coupler	Mini-Circuits	ZA3PD-2	N/A	N/A

SIERRA WIRELESS, INC.

FCC Part 22 & 24 Test Report	MC8765	Nov. 9, 2005	Page 6 of 72
------------------------------	--------	--------------	--------------

4.3 Test Results GSM/EDGE

Frequency (MHz)	Channel	Power (dBm)	
		GMSK Mode	8-PSK Mode
824.2	128	31.93	26.75
837.0	192	32.07	26.77
848.8	251	31.78	26.91
1850.2	512	29.12	26.01
1880.0	661	28.95	25.65
1909.8	810	28.90	25.44

4.4 Test Results UMTS

Frequency (MHz)	Channel	Power (dBm)
826.4	4132	22.55
836.4	4182	22.92
846.6	4233	23.19
1852.4	9262	22.85
1880.0	9400	23.05
1907.6	9538	22.56

5 Occupied Bandwidth

FCC 2.1049

5.1 Test Procedure

The transmitter output was connected to a calibrated coaxial cable and coupler, the other end of which was connected to a spectrum analyzer. The occupied bandwidth (defined as the 99% Power Bandwidth) was measured with the spectrum analyzer at the 3 frequencies in each band. The -26dB bandwidth was also measured and recorded. All results were obtained while in a call.

Test Setup

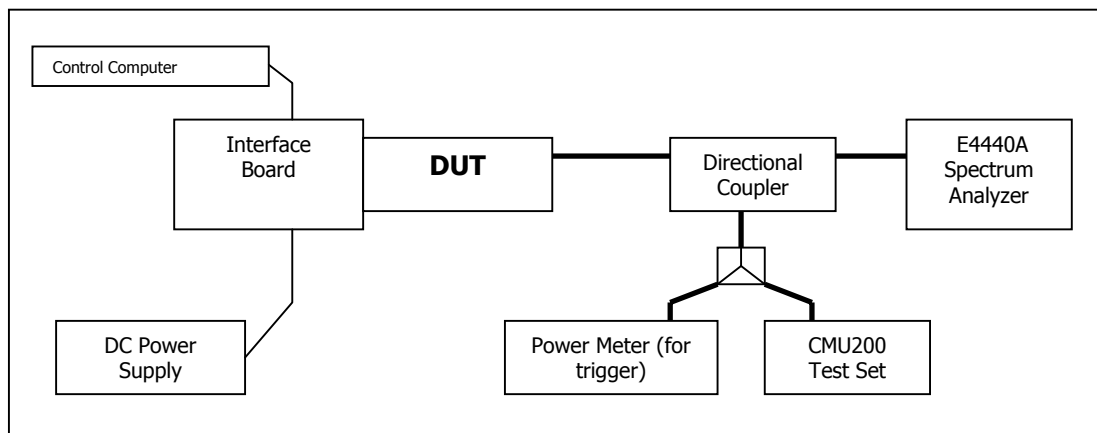

5.2 Test Results

The performance of the GSM 850 MHz cellular band is shown in plots 5.3.1 to 5.3.6.

Performance of the GSM 1900 MHz PCS band is shown in plots 5.3.7 to 5.3.12.

Performance of the UMTS 850 cellular band is shown in plots 5.3.13 to 5.3.15

Performance of the UMTS 1900 PCS band is shown in plots 5.3.16 to 5.3.18

Frequency (MHz)	Channel	99% Occupied Bandwidth (kHz)		-26dBc Occupied Bandwidth (kHz)	
		GMSK Mode	8-PSK Mode	GMSK Mode	8-PSK Mode
824.2	128	243	244	312	305
837.0	192	244	246	312	297
848.8	251	240	246	307	302
1850.2	512	242	243	315	305
1880.0	661	244	243	314	307
1909.8	810	243	243	316	310
Frequency (MHz)	Channel	99% Occupied Bandwidth (MHz)		-26dBc Occupied Bandwidth (MHz)	
826.4	4132	4.15		4.61	
836.4	4182	4.14		4.62	
846.6	4233	4.15		4.60	
1852.4	9262	4.13		4.62	
1880.0	9400	4.13		4.61	
1907.5	9538	4.15		4.60	

SIERRA WIRELESS, INC.

5.3 Test Plots

5.3.1) GMSK Occupied Bandwidth, Cellular Low channel, 824.2 MHz, 99% bandwidth

Agilent 14:41:40 Nov 7, 2005

L

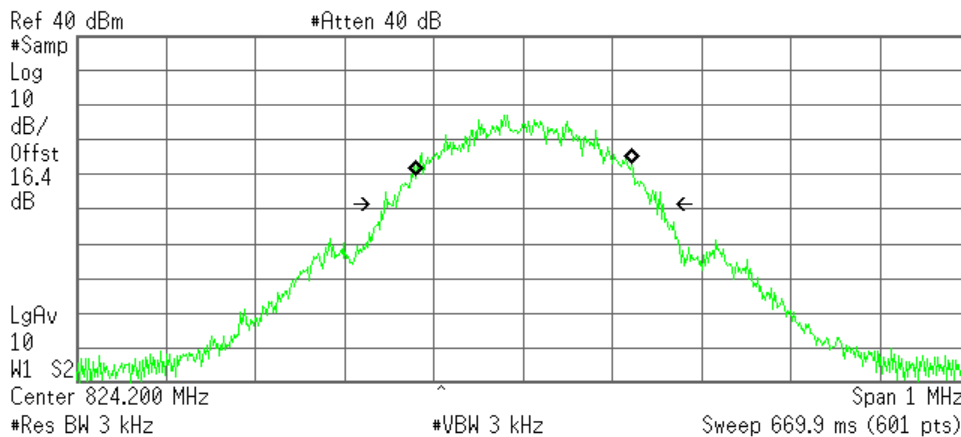

Occupied Bandwidth
243.9929 kHz

Occ BW % Pwr 99.00 %
x dB -26.00 dB

Transmit Freq Error 979.384 Hz
x dB Bandwidth 312.896 kHz*

5.3.2) GMSK Occupied Bandwidth, Middle channel, 837 MHz, 99% bandwidth

Agilent 14:47:58 Nov 7, 2005

L

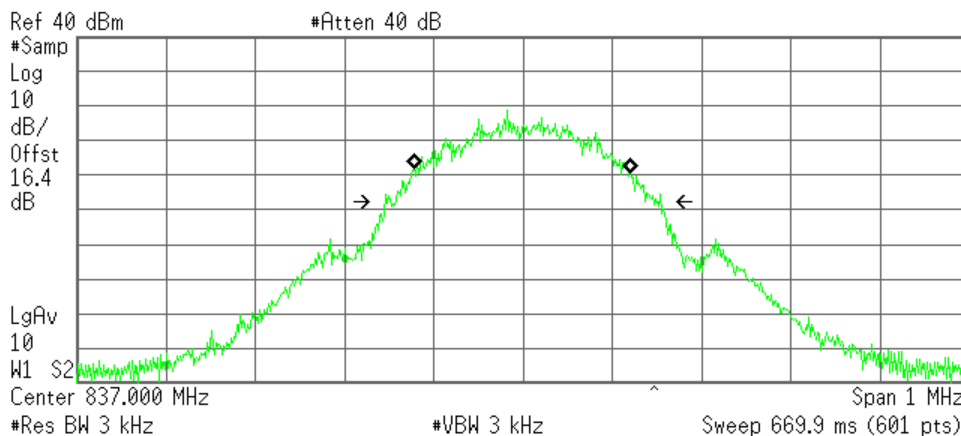

Occupied Bandwidth
244.7068 kHz

Occ BW % Pwr 99.00 %
x dB -26.00 dB

Transmit Freq Error -920.458 Hz
x dB Bandwidth 312.232 kHz*

SIERRA WIRELESS, INC.

5.3.3) GMSK Occupied Bandwidth, High channel, 848.8 MHz, 99% bandwidth

✱ Agilent 14:45:00 Nov 7, 2005

L

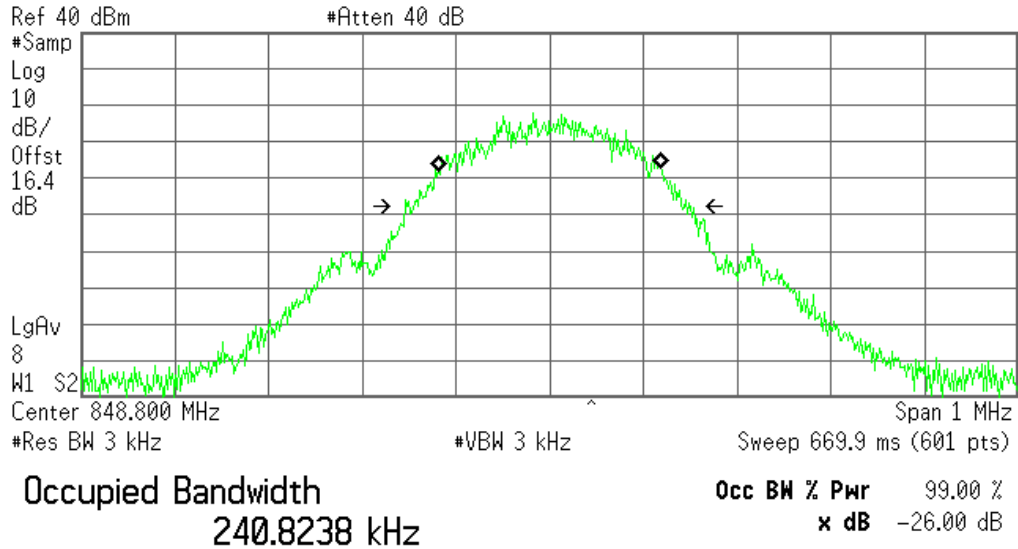

Transmit Freq Error 134.204 mHz
x dB Bandwidth 307.739 kHz*

5.3.4) 8-PSK Occupied Bandwidth, Cellular Low channel, 824.2 MHz, 99% bandwidth

✱ Agilent 15:02:09 Nov 7, 2005

L

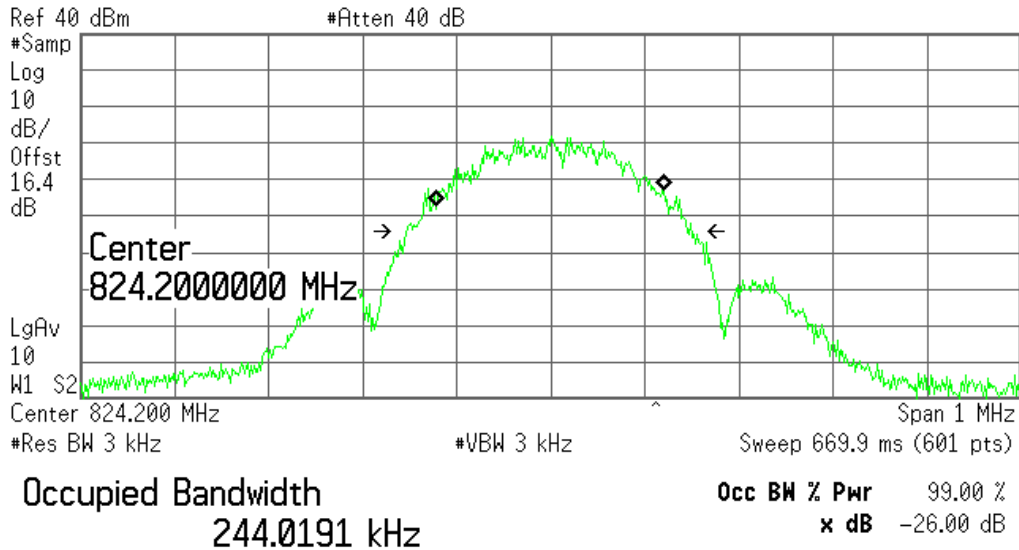

Transmit Freq Error -679.958 Hz
x dB Bandwidth 305.857 kHz*

SIERRA WIRELESS, INC.

5.3.5) 8-PSK Occupied Bandwidth, Middle channel, 837 MHz, 99% bandwidth

Agilent 16:27:21 Nov 9, 2005

L

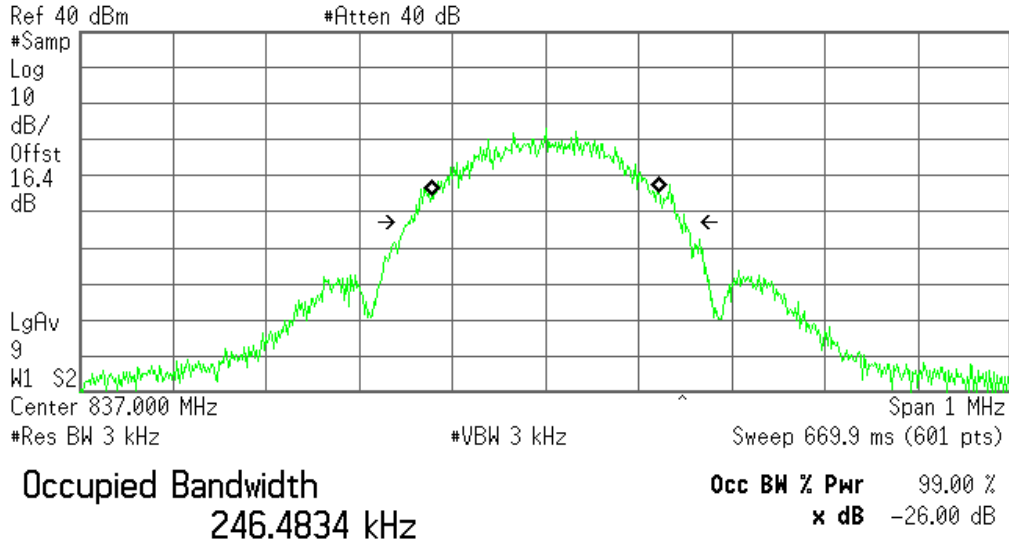

Transmit Freq Error -85.790 Hz
x dB Bandwidth 297.313 kHz*

5.3.6) 8-PSK Occupied Bandwidth, High channel, 848.8 MHz, 99% bandwidth

Agilent 15:05:09 Nov 7, 2005

L

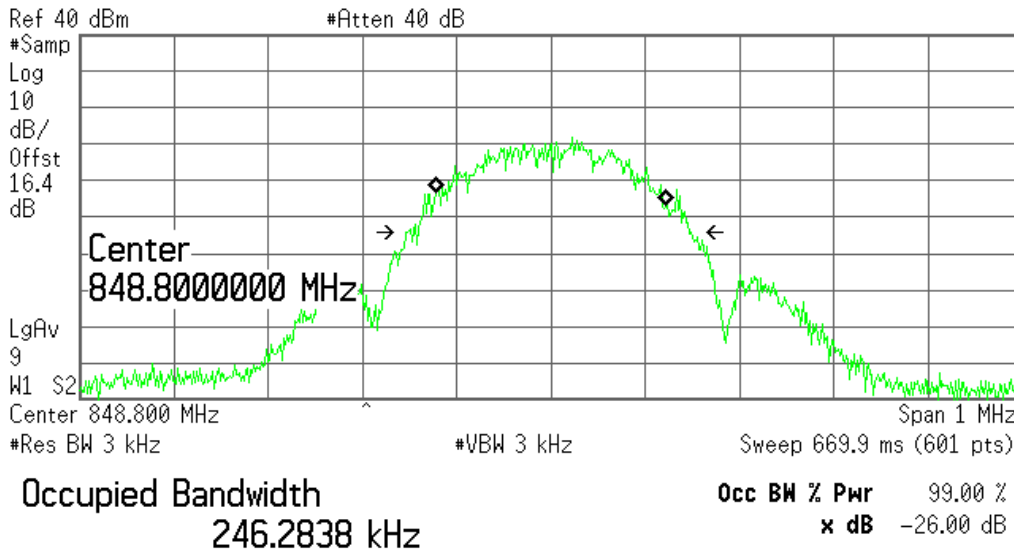

Transmit Freq Error 73.418 Hz
x dB Bandwidth 302.443 kHz*

5.3.7) GSMK Occupied Bandwidth, PCS Low channel, 1850.2 MHz, 99% bandwidth

Agilent 16:08:10 Nov 7, 2005

L

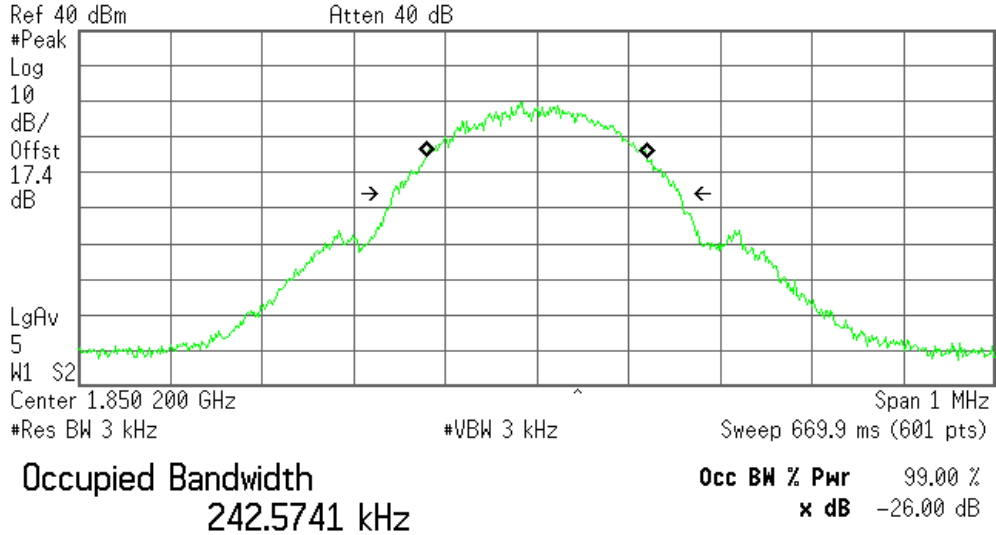

Transmit Freq Error -584.465 Hz
x dB Bandwidth 315.587 kHz*

5.3.8) GSMK Occupied Bandwidth, PCS Middle channel, 1880.0 MHz, 99% bandwidth

Agilent 16:09:04 Nov 7, 2005

L

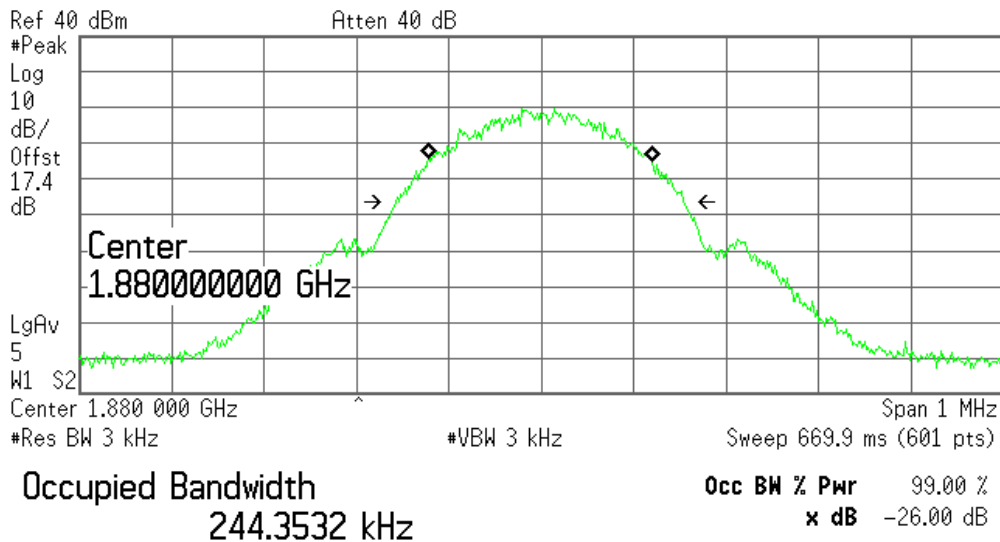

Transmit Freq Error -1.301 kHz
x dB Bandwidth 314.786 kHz*

SIERRA WIRELESS, INC.

5.3.9) GMSK Occupied Bandwidth, PCS High channel, 1909.8 MHz, 99% bandwidth

Agilent 16:20:44 Nov 7, 2005

L

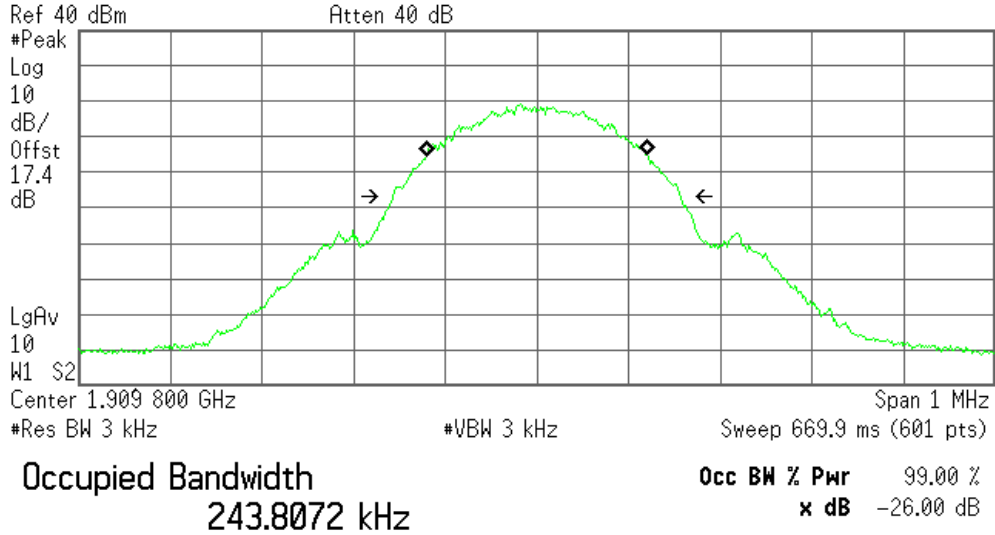

Transmit Freq Error -87.452 Hz
x dB Bandwidth 316.538 kHz*

5.3.10) 8-PSK Occupied Bandwidth, PCS Low channel, 1850.2 MHz, 99% bandwidth

Agilent 16:28:25 Nov 7, 2005

L

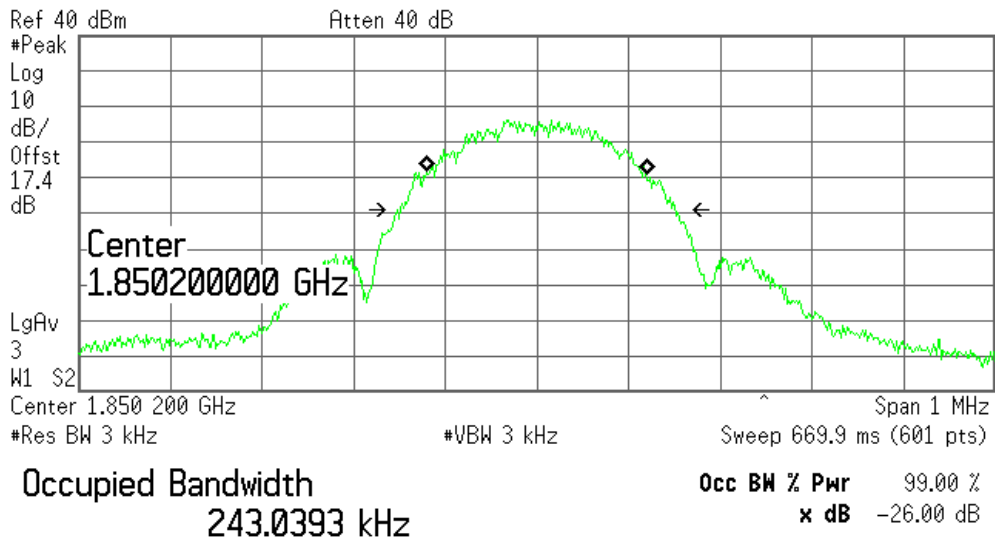

Transmit Freq Error -565.361 Hz
x dB Bandwidth 305.130 kHz*

SIERRA WIRELESS, INC.

5.3.11) 8-PSK Occupied Bandwidth, PCS Middle channel, 1880.0 MHz, 99% bandwidth

Agilent 16:27:18 Nov 7, 2005

L

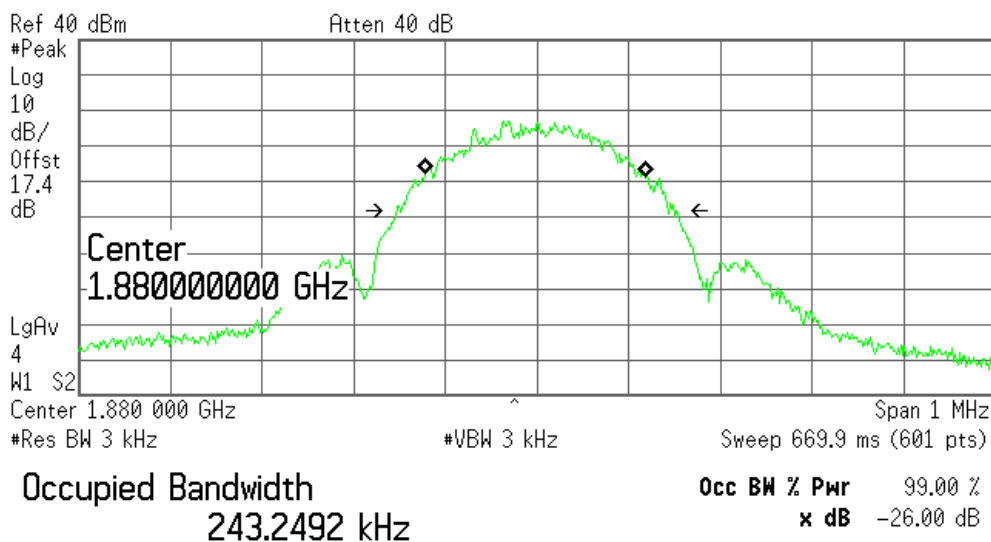

Transmit Freq Error -1.326 kHz
x dB Bandwidth 307.527 kHz*

5.3.12) 8-PSK Occupied Bandwidth, PCS High channel, 1909.8 MHz, 99% bandwidth

Agilent 16:25:27 Nov 7, 2005

L

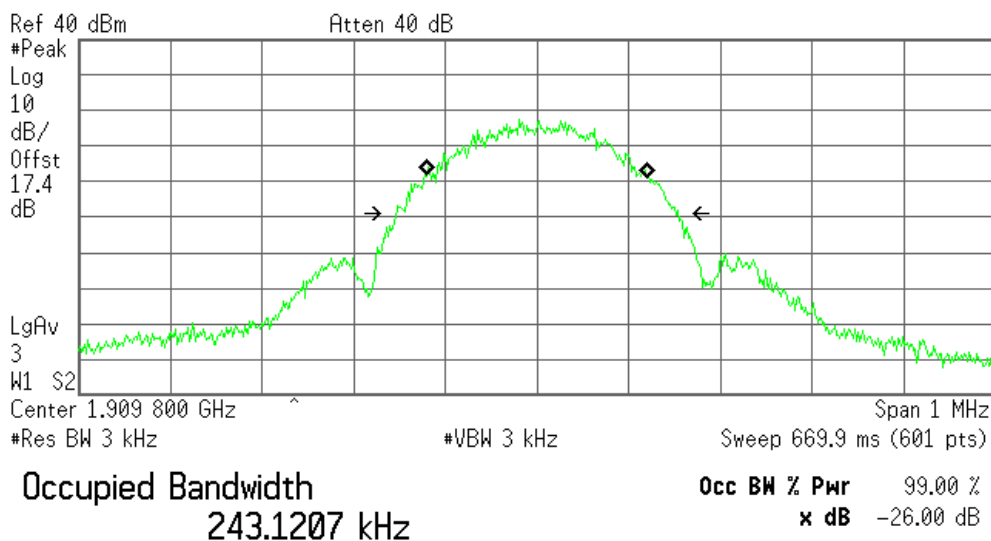

Transmit Freq Error 483.148 Hz
x dB Bandwidth 310.748 kHz*

SIERRA WIRELESS, INC.

5.3.13) WCDMA Occupied Bandwidth, Cellular Low channel, 826.4 MHz, 99% bandwidth

Agilent 15:38:45 Nov 7, 2005

L

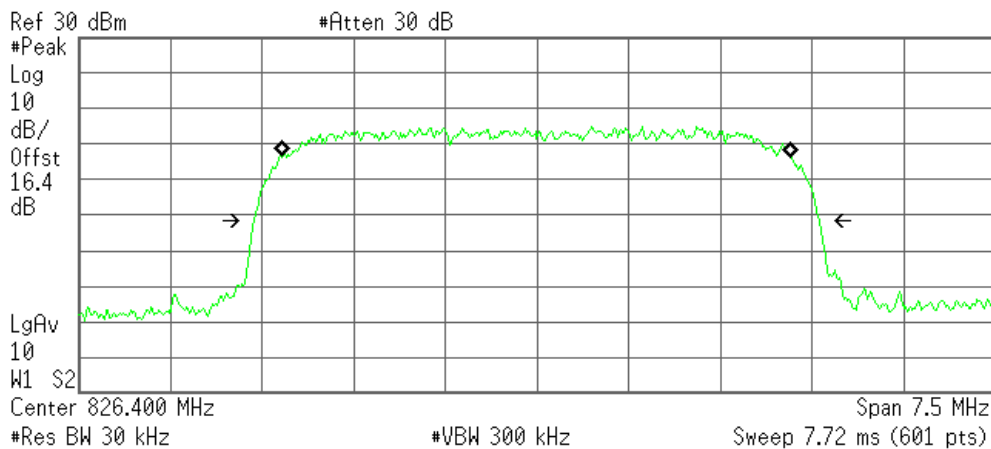

Occupied Bandwidth
4.1545 MHz

Occ BW % Pwr 99.00 %
x dB -26.00 dB

Transmit Freq Error -4.003 kHz
x dB Bandwidth 4.619 MHz*

5.3.14) WCDMA Occupied Bandwidth, Cellular Middle channel, 836.4 MHz, 99% bandwidth

Agilent 15:39:56 Nov 7, 2005

L

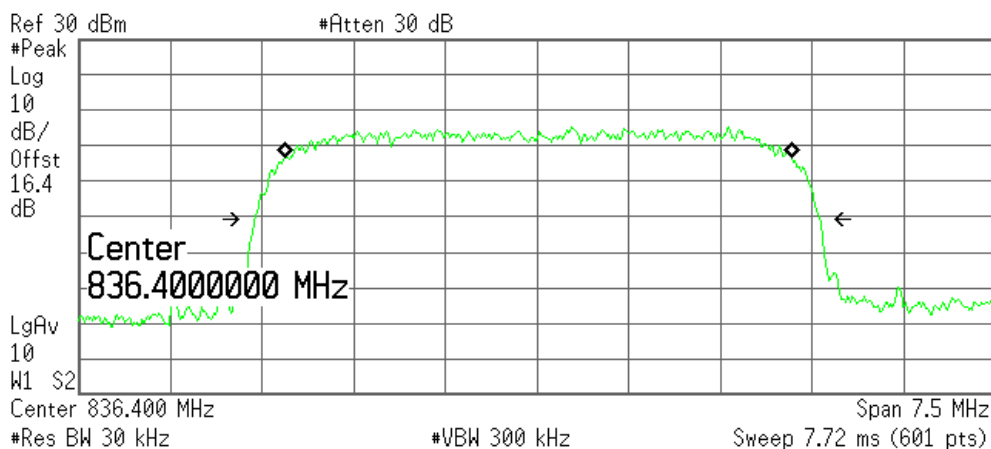

Occupied Bandwidth
4.1490 MHz

Occ BW % Pwr 99.00 %
x dB -26.00 dB

Transmit Freq Error 9.395 kHz
x dB Bandwidth 4.622 MHz*

5.3.15) WCDMA Occupied Bandwidth, Cellular High channel, 846.6 MHz, 99% bandwidth

Agilent 16:42:38 Nov 9, 2005

L

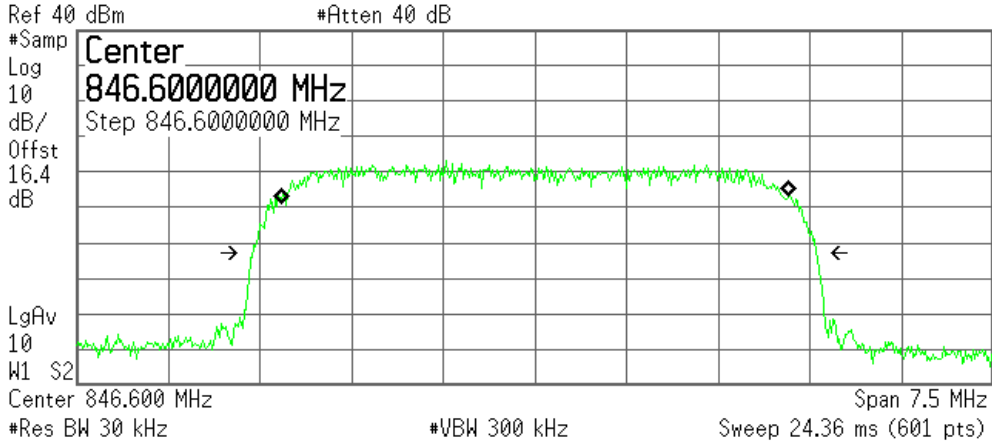

Occupied Bandwidth
4.1563 MHz

Occ BW % Pwr 99.00 %
x dB -26.00 dB

Transmit Freq Error -149.398 Hz
x dB Bandwidth 4.608 MHz*

5.3.16) WCDMA Occupied Bandwidth, PCS Low channel, 1852.4 MHz, 99% bandwidth

Agilent 15:55:54 Nov 7, 2005

L

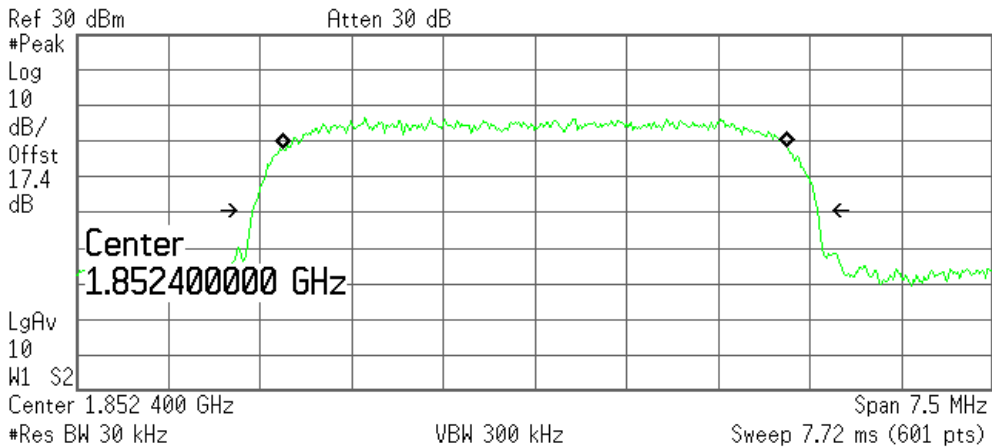

Occupied Bandwidth
4.1346 MHz

Occ BW % Pwr 99.00 %
x dB -26.00 dB

Transmit Freq Error -286.427 Hz
x dB Bandwidth 4.622 MHz*

SIERRA WIRELESS, INC.

5.3.17) WCDMA Occupied Bandwidth, PCS Middle channel, 1880 MHz, 99% bandwidth

Agilent 15:57:01 Nov 7, 2005

L

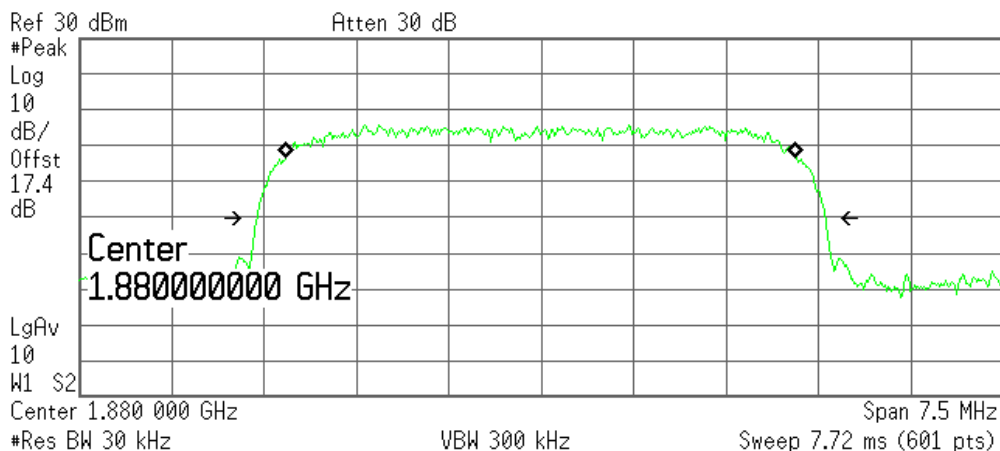

Occupied Bandwidth
4.1356 MHz

Occ BW % Pwr 99.00 %
x dB -26.00 dB

Transmit Freq Error -3.051 kHz
x dB Bandwidth 4.614 MHz*

5.3.18) WCDMA Occupied Bandwidth, PCS High channel, 1907.6 MHz, 99% bandwidth

Agilent 16:00:30 Nov 7, 2005

L

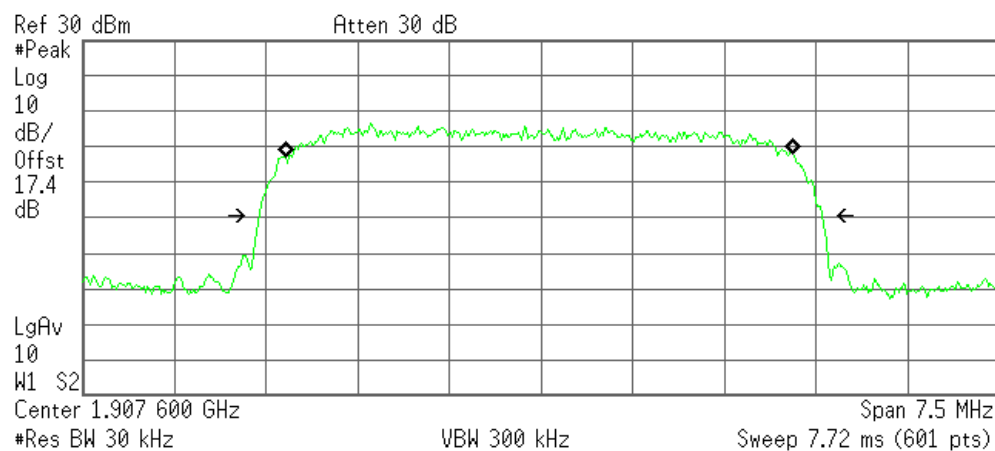

Occupied Bandwidth
4.1542 MHz

Occ BW % Pwr 99.00 %
x dB -26.00 dB

Transmit Freq Error -16.623 kHz
x dB Bandwidth 4.605 MHz*

SIERRA WIRELESS, INC.

6 Out of Band Emissions at Antenna Terminals

FCC 22.901(d), 22.917, 24.238(a)

Out of Band Emissions:

The mean power of emissions must be attenuated below the mean power of the unmodulated carrier (P) on any frequency outside the frequency band by at least $(43 + 10 \log P)$ dB, in this case, -13dBm.

6.1 Test Procedure

The RF output of the transmitter was connected to a spectrum analyzer through a calibrated coaxial cable. Sufficient scans were taken to show the out-of-band Emissions, if any, up to 10th harmonic. The DUT was scanned for spurious emissions from 1MHz to 20GHz with sufficient bandwidth and video resolution. Data plots are included. The measurement cable path loss varies since the coupler used has different loss at higher frequencies when compared to lower frequencies. To be conservative, the worst-case path loss was always chosen. While the unit was in a call, multiple sweeps were recorded in maximum hold mode using a peak detector to ensure that the worst-case emissions were caught.

Test Setup

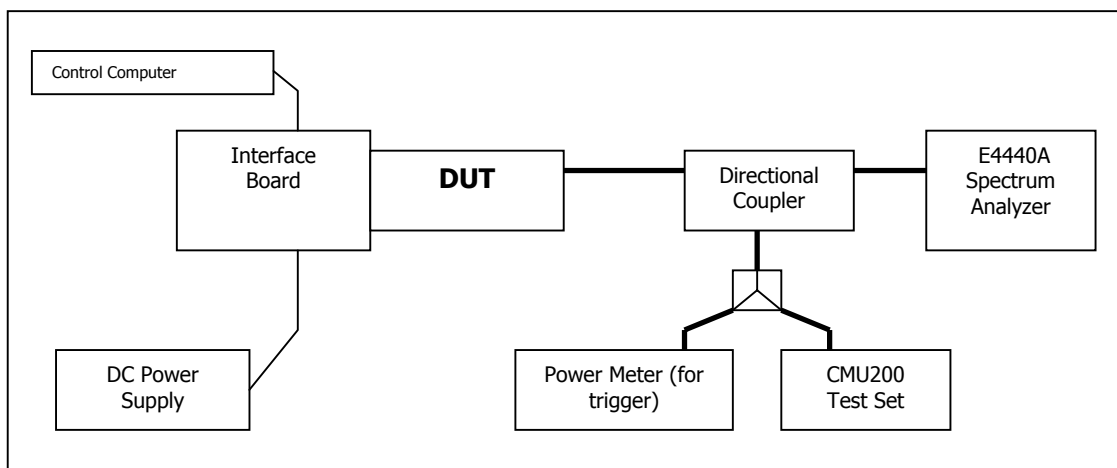

6.2 Test Equipment

EQUIPMENT	MANUFACTURER	MODEL NO.	SERIAL NO.	CAL. DATE
Control Computer	TC	Generic PC	100488	N/A
Wireless Test Set	Rohde & Schwarz	CMU200	836766/030	N/A
Spectrum Analyzer	Agilent	PSA E4440A	US41421268	Sept. 29, 2004
DC Power Supply	HP	6632A	3530A	N/A
Interface Board	Shop built	Minnow	N/A	N/A
Directional Coupler	Mini-Circuits	ZA3PD-2	N/A	N/A

SIERRA WIRELESS, INC.

FCC Part 22 & 24 Test Report	MC8765	Nov. 9, 2005	Page 18 of 72
------------------------------	--------	--------------	---------------

6.3 Test Results

Refer to the following plots.

- **Cellular Band**

Plot Number	Description
6.4.1 – 6.4.3	GMSK Mode, Low channel, 824.20 MHz
6.4.4 – 6.4.6	GMSK Mode, Middle Channel, 837 MHz
6.4.7 – 6.4.9	GMSK Mode, High Channel, 848.8 MHz
6.4.10 – 6.4.12	8-PSK Mode, Low channel, 824.20 MHz
6.4.13 – 6.4.15	8-PSK Mode, Middle Channel, 837 MHz
6.4.16 – 6.4.18	8-PSK Mode, High Channel, 848.8 MHz

- **PCS Band**

Plot Number	Description
6.4.19 – 6.4.21	GMSK Mode, Low Channel, 1850.2 MHz
6.4.22 – 6.4.24	GMSK Mode, Middle Channel, 1880.0 MHz
6.4.25 – 6.4.27	GMSK Mode, High Channel, 1909.8 MHz
6.4.28 – 6.4.30	8-PSK, Mode, Low Channel, 1850.2 MHz
6.4.31 – 6.4.33	8-PSK Mode, Middle Channel, 1880.0 MHz
6.4.34 – 6.4.36	8-PSK Mode, High Channel, 1909.8 MHz

- **UMTS Cellular Band**

Plot Number	Description
6.4.37 – 6.4.39	WCDMA Mode, Low Channel, 826.4 MHz
6.4.40 – 6.4.42	WCDMA Mode, Middle Channel, 836.4 MHz
6.4.43 – 6.4.45	WCDMA Mode, High Channel, 846.6 MHz

- **UMTS PCS Band**

Plot Number	Description
6.4.46 – 6.4.48	WCDMA Mode, Low Channel, 1852.4 MHz
6.4.49 – 6.4.51	WCDMA Mode, Middle Channel, 1880.0 MHz
6.4.52 – 6.4.54	WCDMA Mode, High Channel, 1907.6 MHz

These plots show that the conducted emission limits requirements are met.

6.4 Test Plots

Plot 6.4.1) Out of Band Emissions at Antenna Terminals

GMSK, Low channel, 824.200 MHz, 1 MHz to 1 GHz

Agilent 10:29:23 Nov 8, 2005

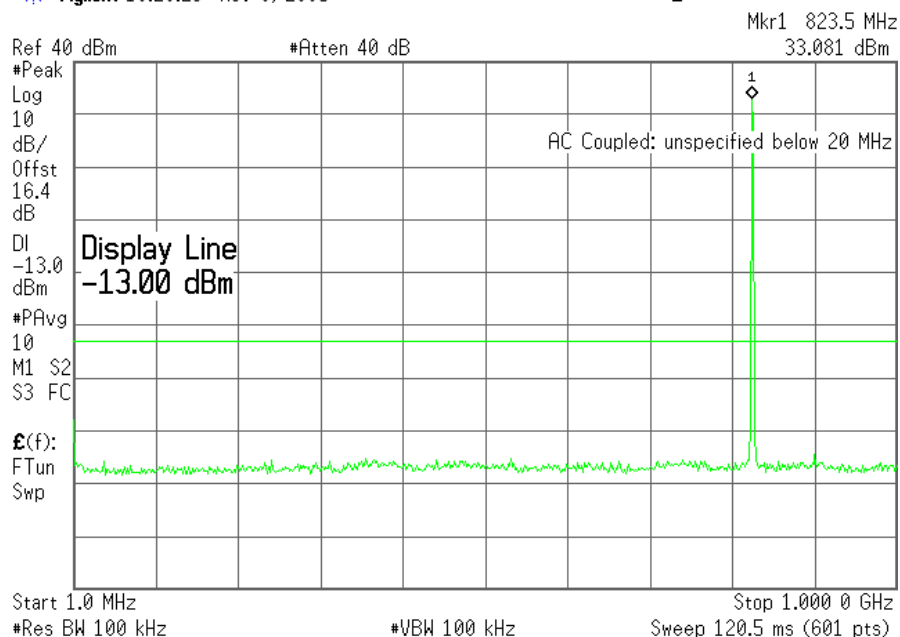

Plot 6.4.2) Out of Band Emissions at Antenna Terminals

GMSK, Low channel, 824.200 MHz, TX signal +/- 20 MHz

Agilent 10:23:59 Nov 9, 2005

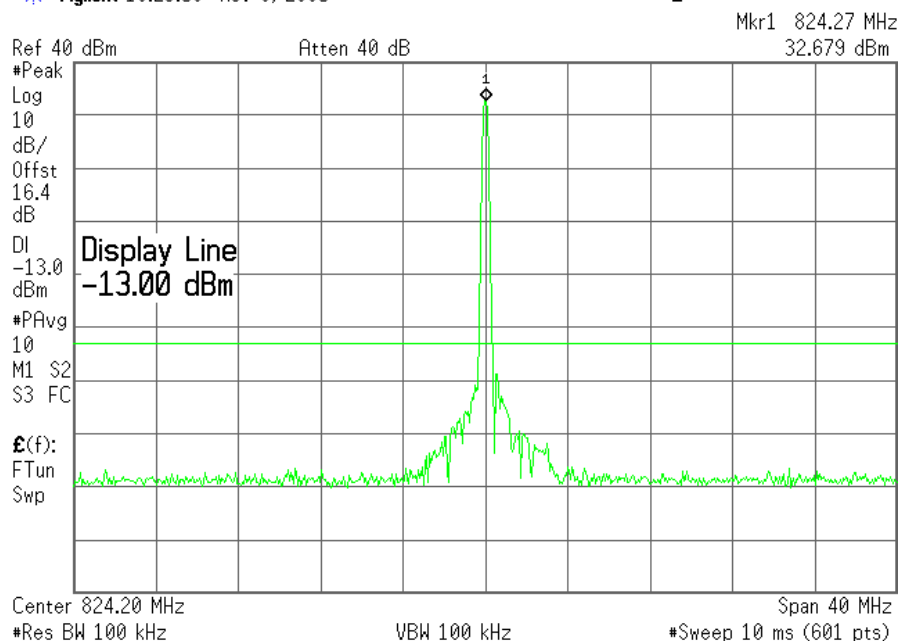

The strong emission shown in each case is the carrier signal.

SIERRA WIRELESS, INC.

Plot 6.4.3) Out of Band Emissions at Antenna Terminals

GMSK, Low channel, 824.200 MHz, 1 GHz to 20 GHz

Agilent 11:03:56 Nov 9, 2005

L

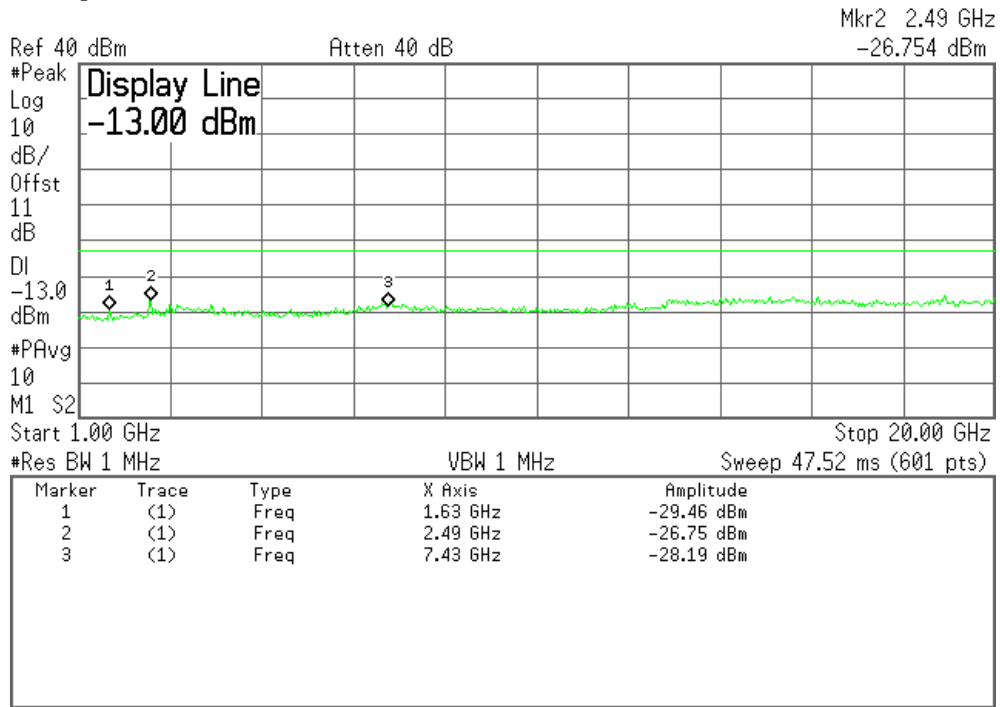

Cellular Harmonics for Ch. 128 (824.2 MHz)	Level (dBm)
Second	-29 dBm
Third	-26 dBm
All others	< -30dBm up to 20GHz

SIERRA WIRELESS, INC.

Plot 6.4.4) Out of Band Emissions at Antenna Terminals GMSK, Mid Channel, 837 MHz, 1 MHz to 1 GHz

Agilent 10:30:37 Nov 8, 2005

L

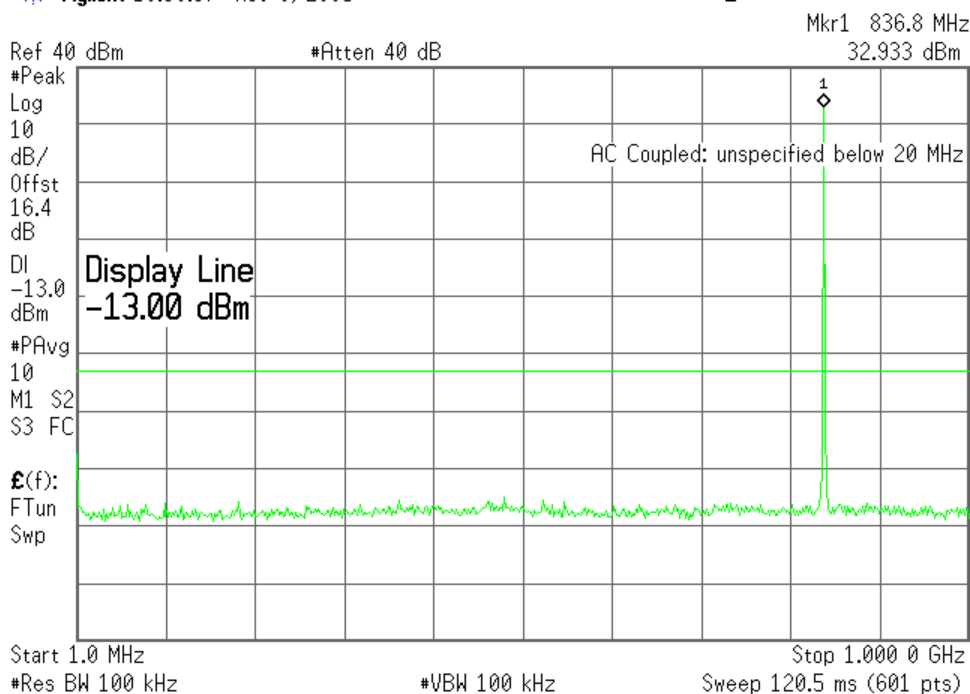

Plot 6.4.5) Out of Band Emissions at Antenna Terminals GMSK, Mid Channel, 837 MHz, TX signal +/- 20 MHz

Agilent 10:25:20 Nov 9, 2005

L

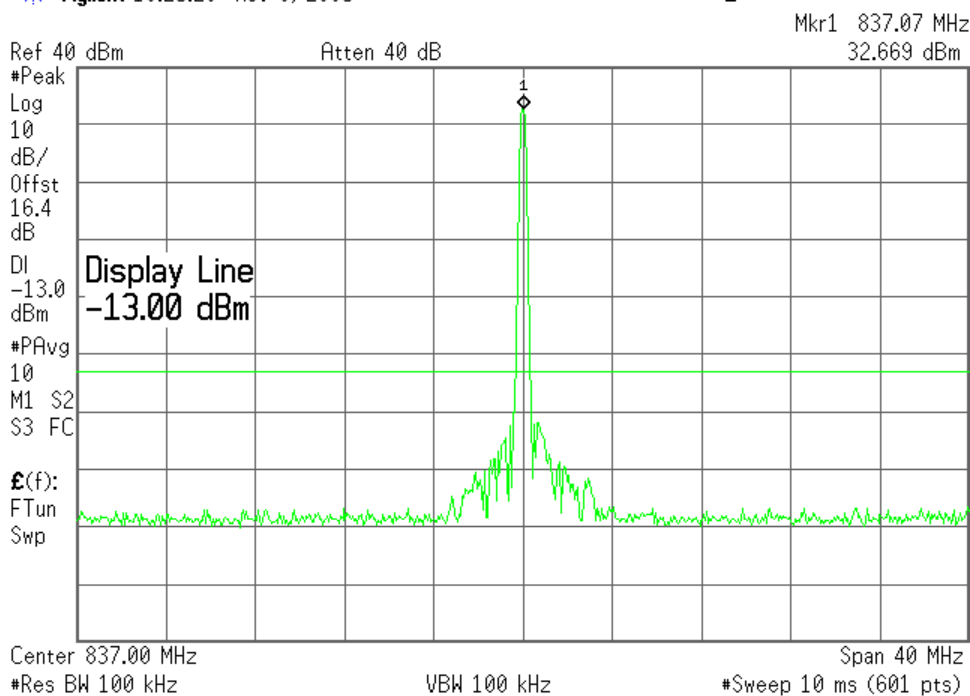

The strong emission shown in each case is the carrier signal.

SIERRA WIRELESS, INC.

Plot 6.4.6) Out of Band Emissions at Antenna Terminals

GMSK, Mid Channel, 837 MHz, 1 GHz to 20 GHz

Agilent 11:05:17 Nov 9, 2005

L

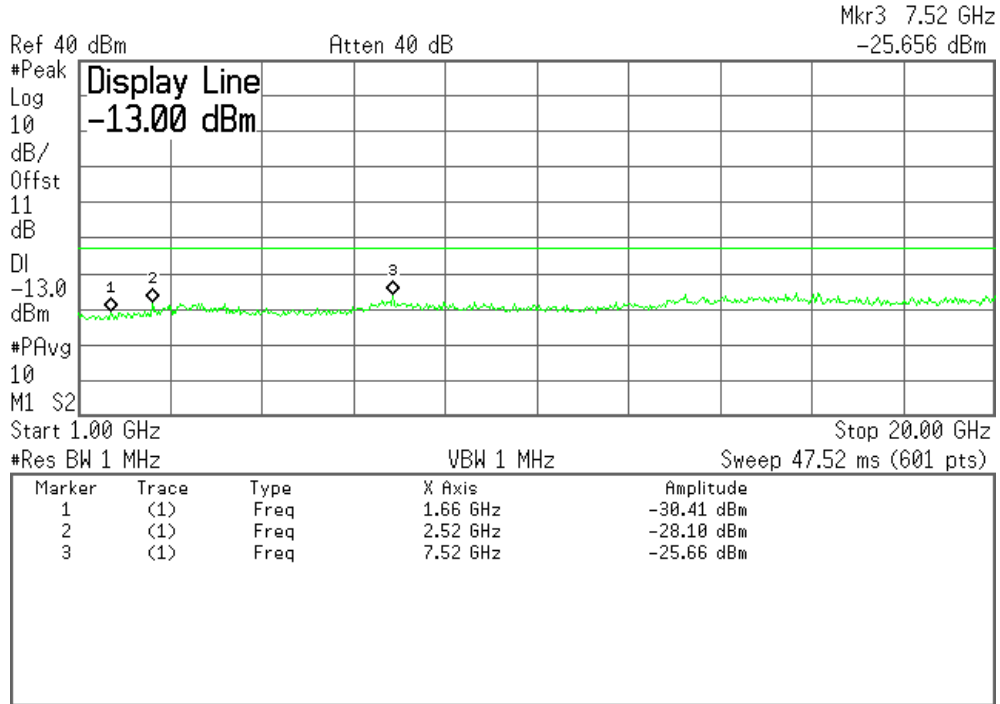

Cellular Harmonics for Ch. 190 (836.6 MHz)	Level (dBm)
Second	-30 dBm
Third	-28 dBm
All others	< -30dBm up to 20GHz

Plot 6.4.7) Out of Band Emissions at Antenna Terminals
 GMSK, High Channel, 848.8 MHz, 1 MHz to 1 GHz

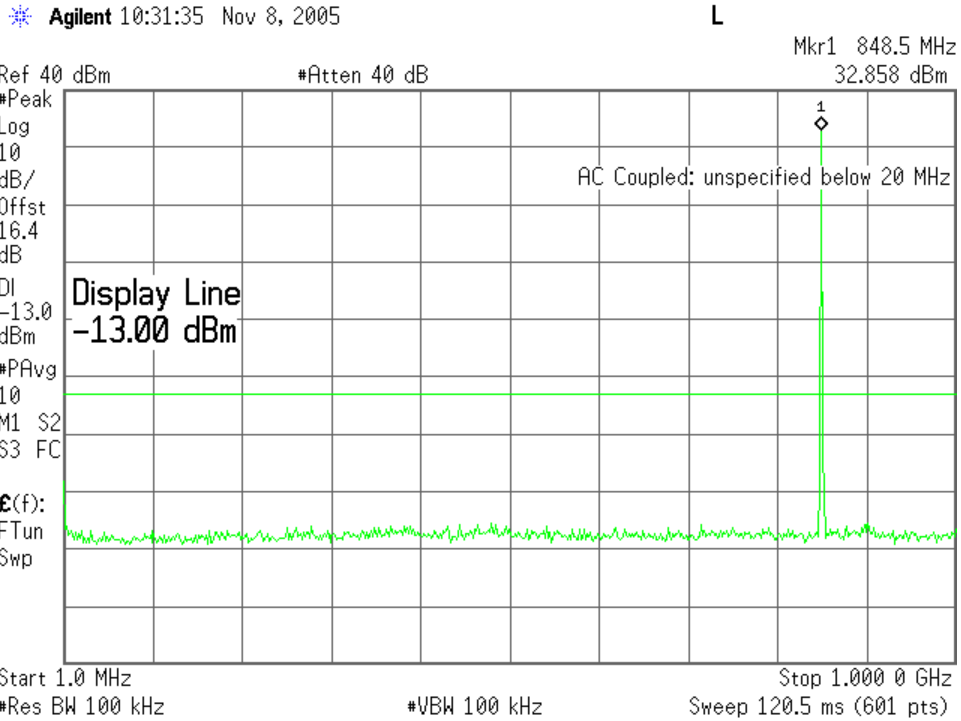

Plot 6.4.8) Out of Band Emissions at Antenna Terminals
 GMSK, High Channel, 848.8 MHz, TX signal +/- 20 MHz

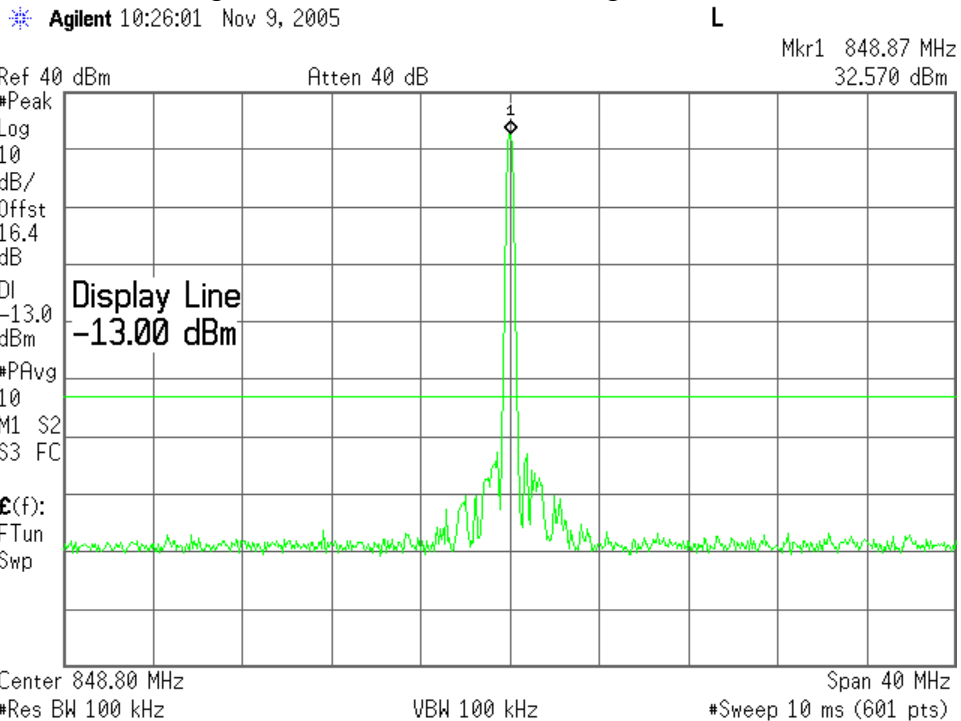

The strong emission shown in each case is the carrier signal.

SIERRA WIRELESS, INC.

Plot 6.4.9) Out of Band Emissions at Antenna Terminals

GMSK, High Channel, 848.8 MHz, 1 GHz to 20 GHz

Agilent 11:07:48 Nov 9, 2005

L

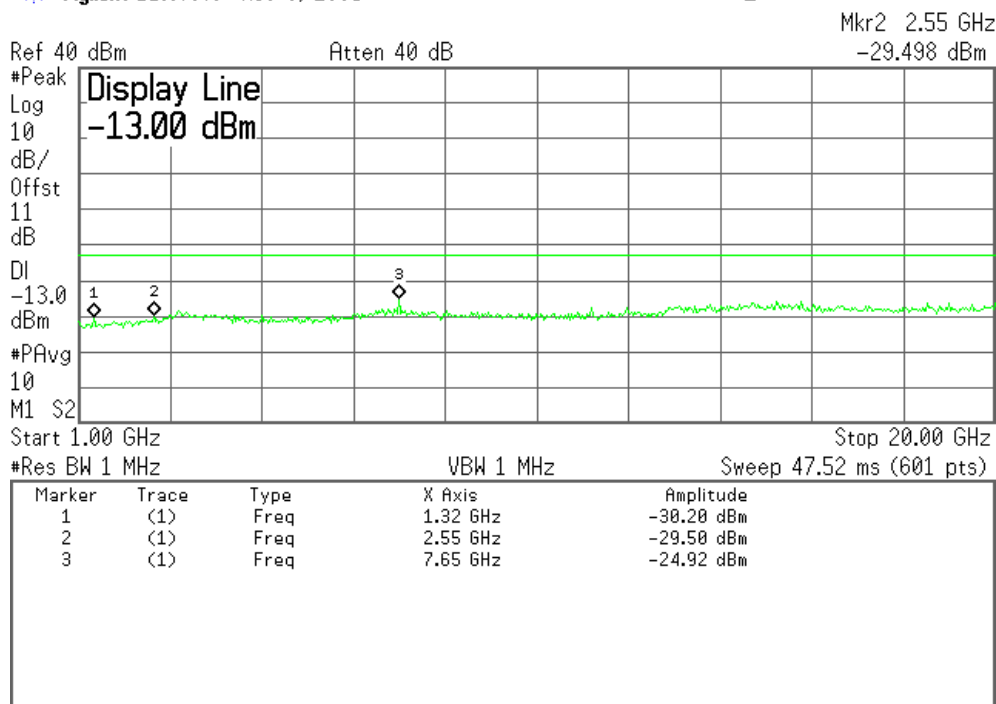

Cellular Harmonics for Ch. 251 (848.8 MHz)	Level (dBm)
Second	-30 dBm
Third	-29 dBm
All others	< -30dBm up to 20GHz

Plot 6.4.10) Out of Band Emissions at Antenna Terminals

8-PSK, Low channel, 824.200 MHz, 1 MHz to 1 GHz

Agilent 10:34:45 Nov 8, 2005

L

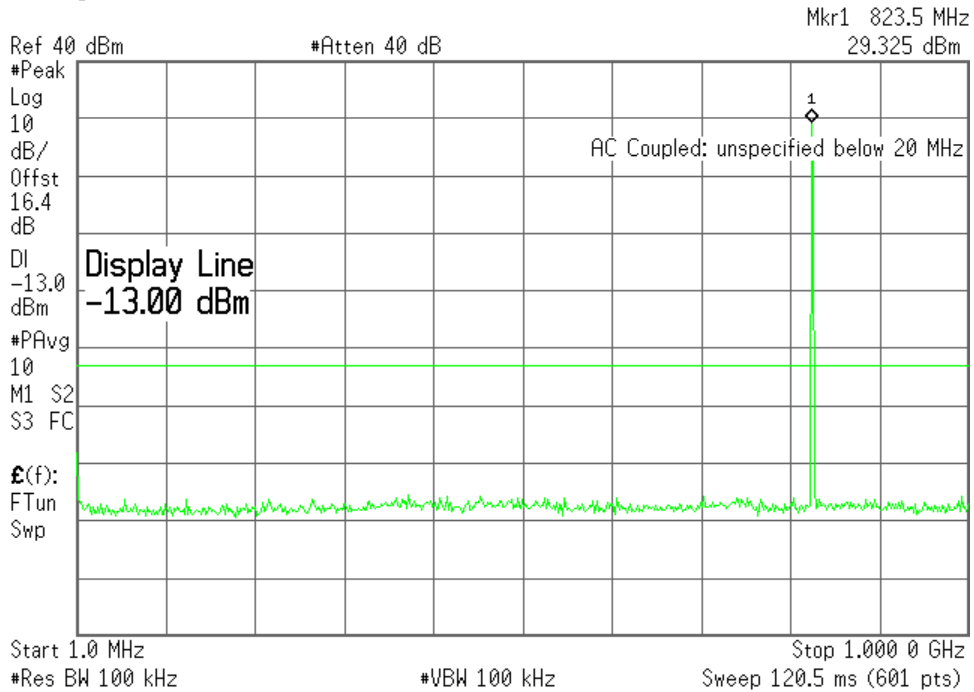

Plot 6.4.11) Out of Band Emissions at Antenna Terminals

8-PSK, Low channel, 824.200 MHz, TX signal +/- 20 MHz

Agilent 10:31:07 Nov 9, 2005

L

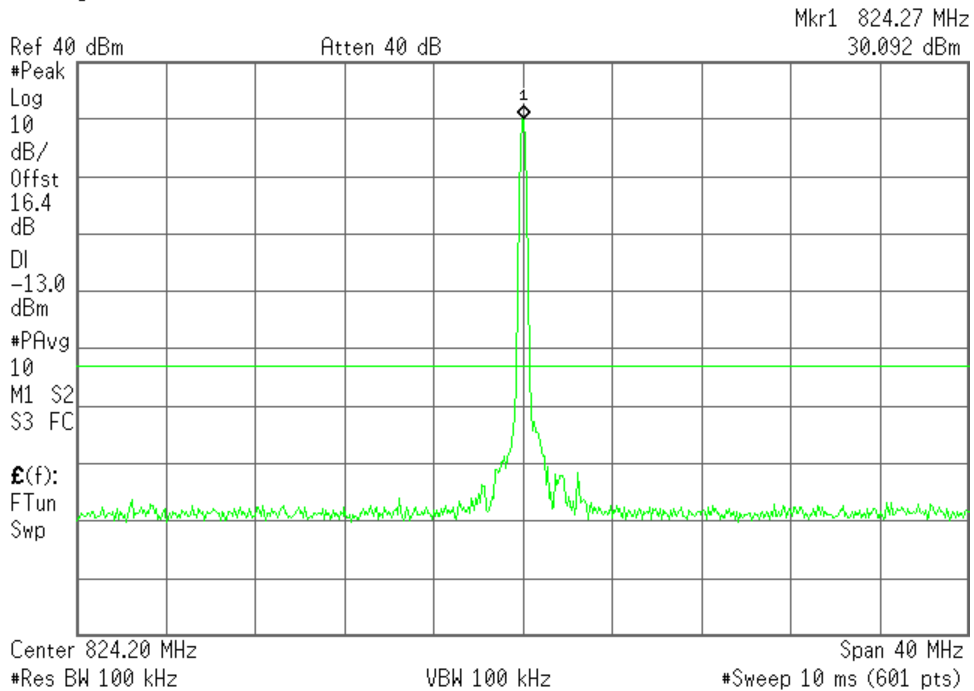

The strong emission shown in each case is the carrier signal.

SIERRA WIRELESS, INC.

Plot 6.4.12) Out of Band Emissions at Antenna Terminals

8-PSK, Low channel, 824.200 MHz, 1 GHz to 20 GHz

Agilent 11:09:20 Nov 9, 2005

L

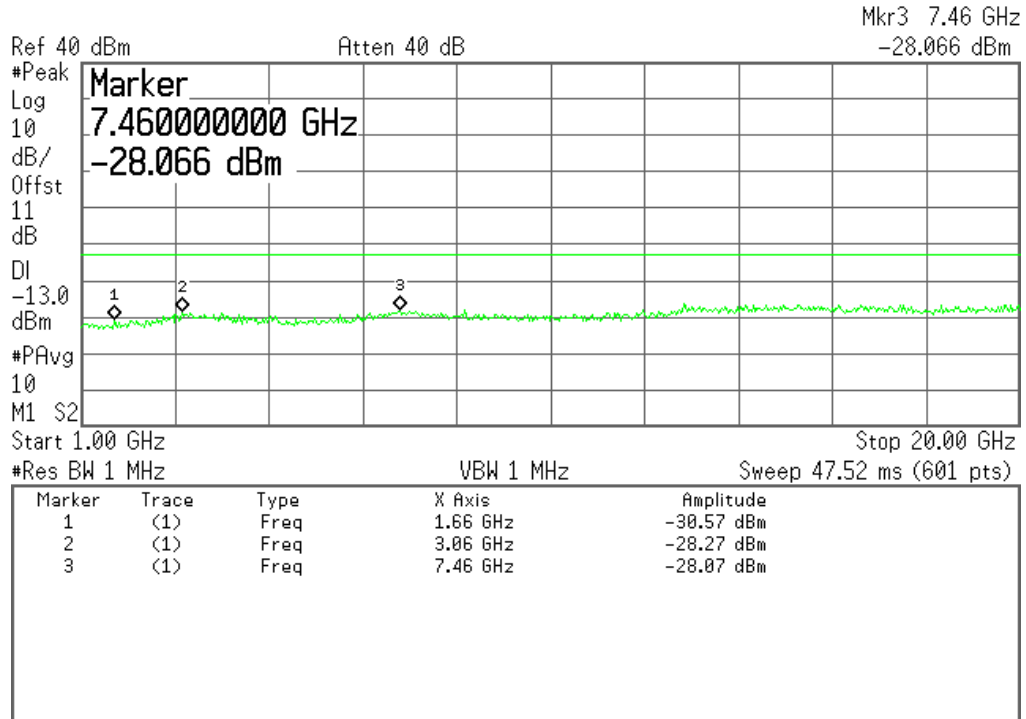

Cellular Harmonics for Ch. 128 (824.2 MHz)	Level (dBm)
Second	-30dBm
Third	-28dBm
All others	< -30dBm up to 20GHz

Plot 6.4.13) Out of Band Emissions at Antenna Terminals

8-PSK, Mid Channel, 837 MHz, 1 MHz to 1 GHz

Agilent 10:33:48 Nov 8, 2005

L

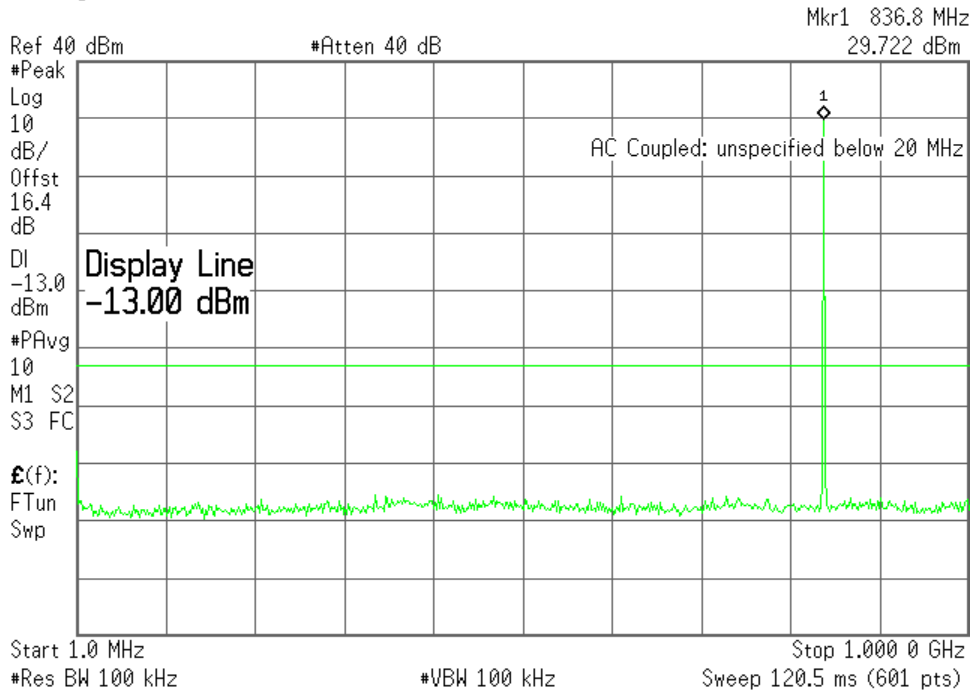

Plot 6.4.14) Out of Band Emissions at Antenna Terminals

8-PSK, Mid Channel, 837 MHz, TX signal +/- 20 MHz

Agilent 10:28:09 Nov 9, 2005

L

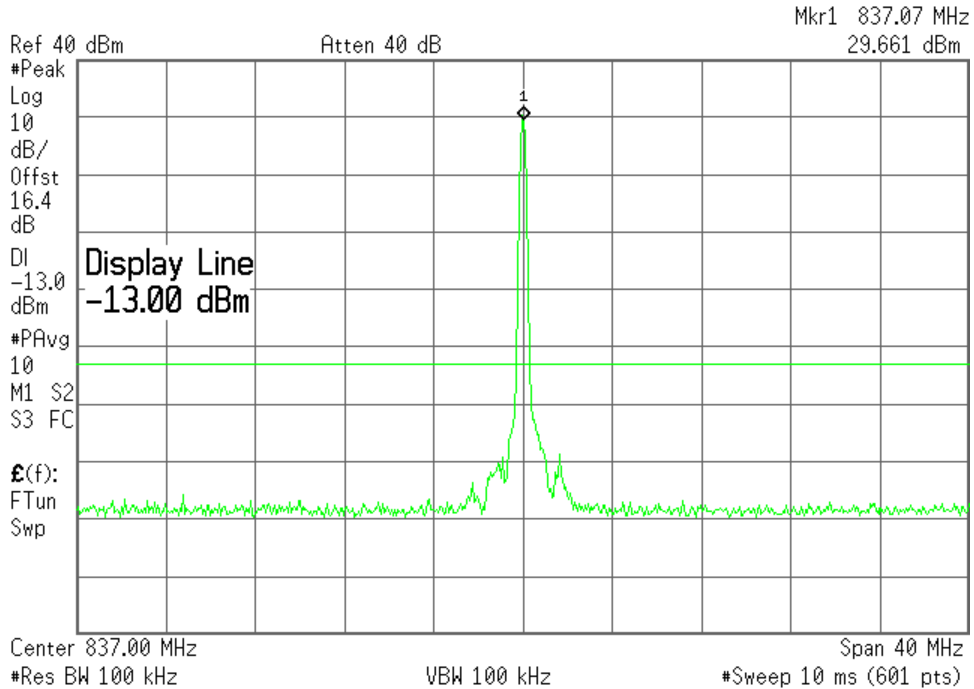

The strong emission shown in each case is the carrier signal.

SIERRA WIRELESS, INC.

Plot 6.4.15) Out of Band Emissions at Antenna Terminals

8-PSK, Mid Channel, 836.6 MHz, 1 GHz to 20 GHz

Agilent 11:11:22 Nov 9, 2005

L

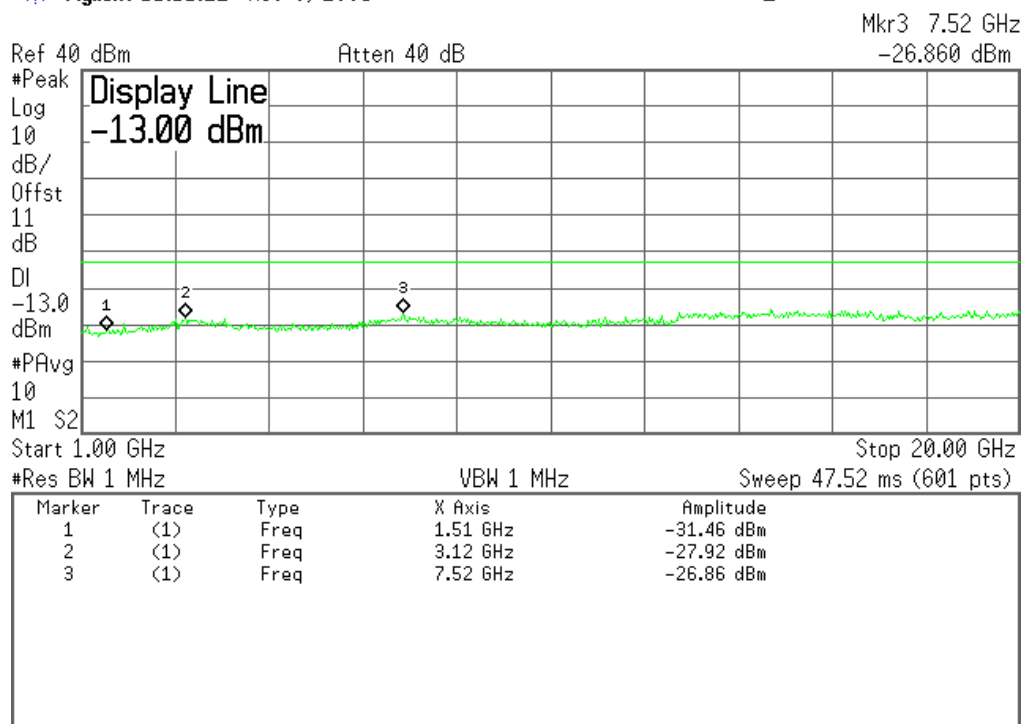

Cellular Harmonics for Ch. 190 (836.6 MHz)	Level (dBm)
Second	--
Third	--
All others	< -30dBm up to 20GHz

Plot 6.4.16) Out of Band Emissions at Antenna Terminals
 8-PSK, High Channel, 848.8 MHz, 1 MHz to 1 GHz

Agilent 10:32:36 Nov 8, 2005

L

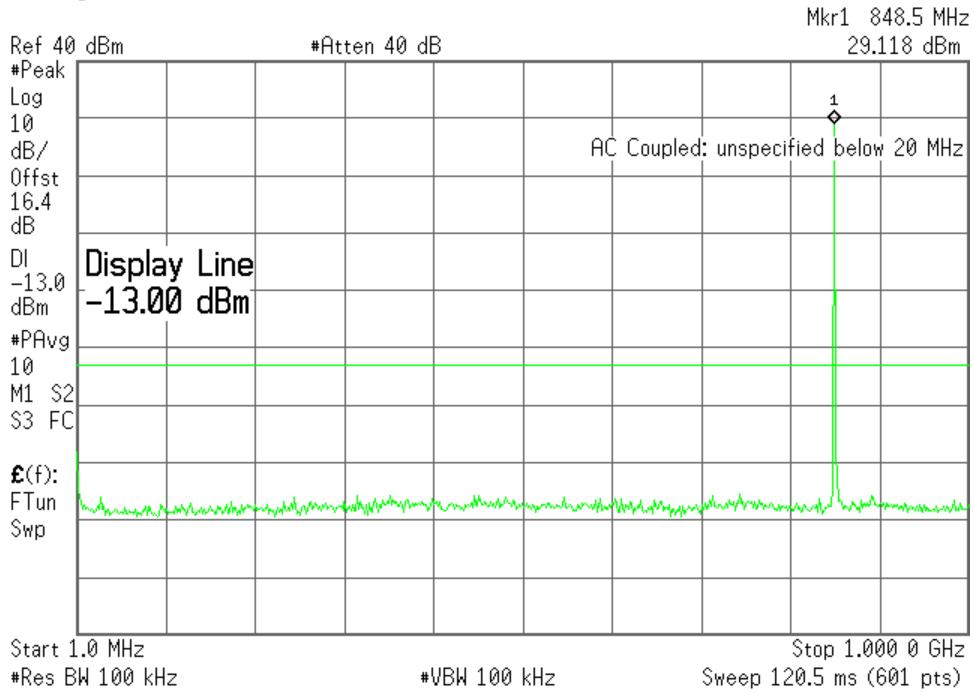

Plot 6.4.17) Out of Band Emissions at Antenna Terminals
 8-PSK, High Channel, 848.8 MHz, TX signal +/- 20 MHz

Agilent 10:29:48 Nov 9, 2005

L

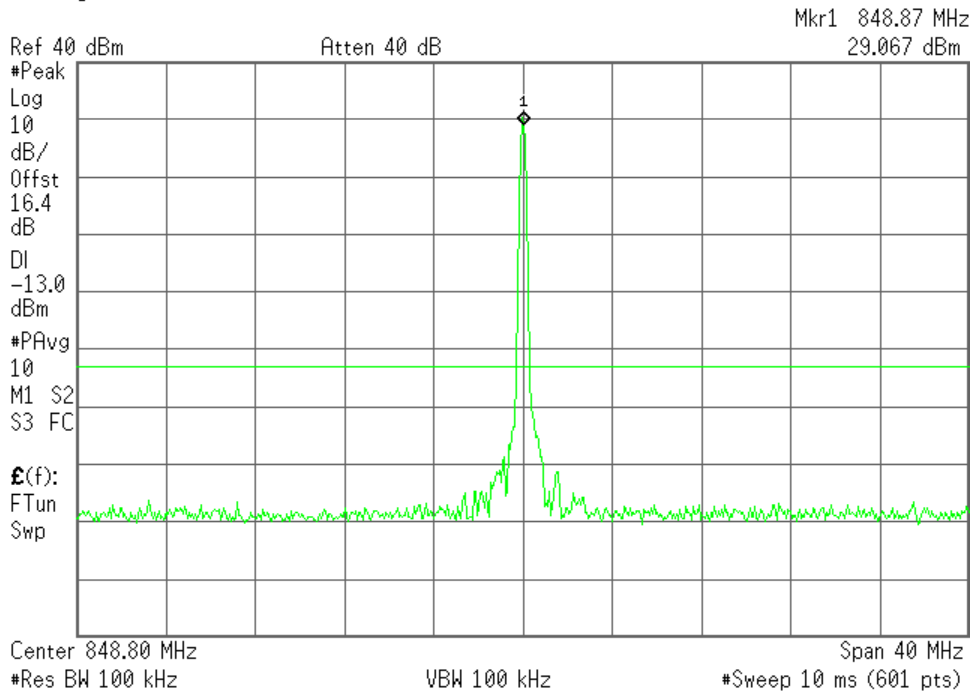

The strong emission shown in each case is the carrier signal.

SIERRA WIRELESS, INC.

Plot 6.4.18) Out of Band Emissions at Antenna Terminals

8-PSK, High Channel, 848.8 MHz, 1 GHz to 20 GHz

Agilent 11:12:15 Nov 9, 2005

L

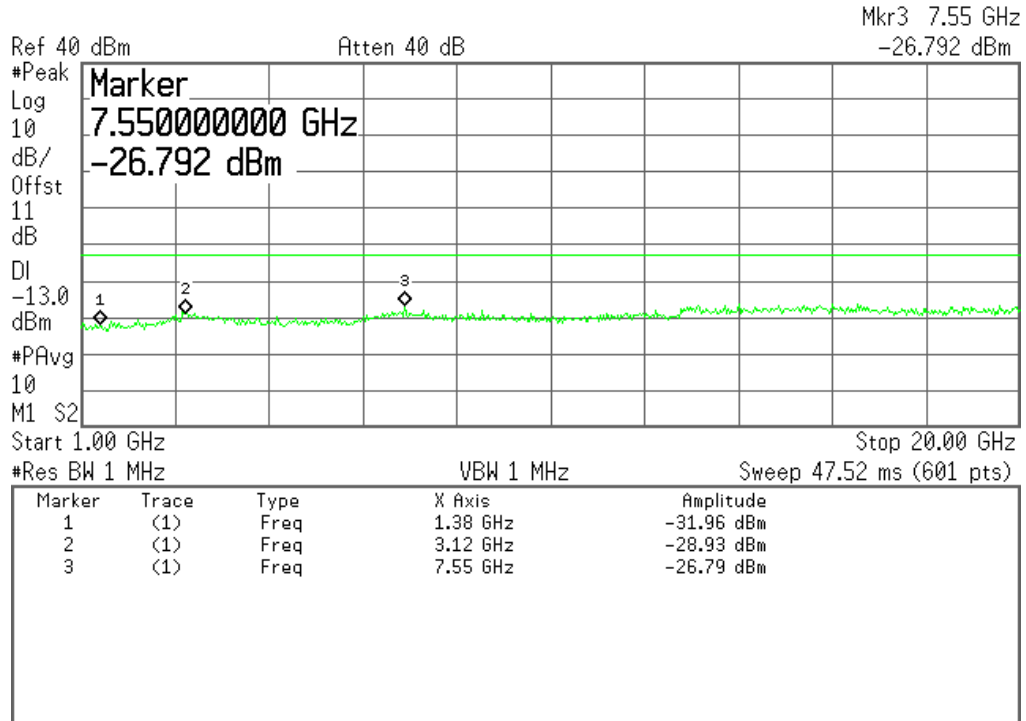

Cellular Harmonics for Ch. 251 (848.8 MHz)	Level (dBm)
Second	--
Third	--
All others	< -30dBm up to 20GHz

Plot 6.4.19) Out of Band Emissions at Antenna Terminals

GMSK, Low channel, 1850.2 MHz, 1 MHz to 1 GHz

Agilent 10:20:44 Nov 8, 2005

L

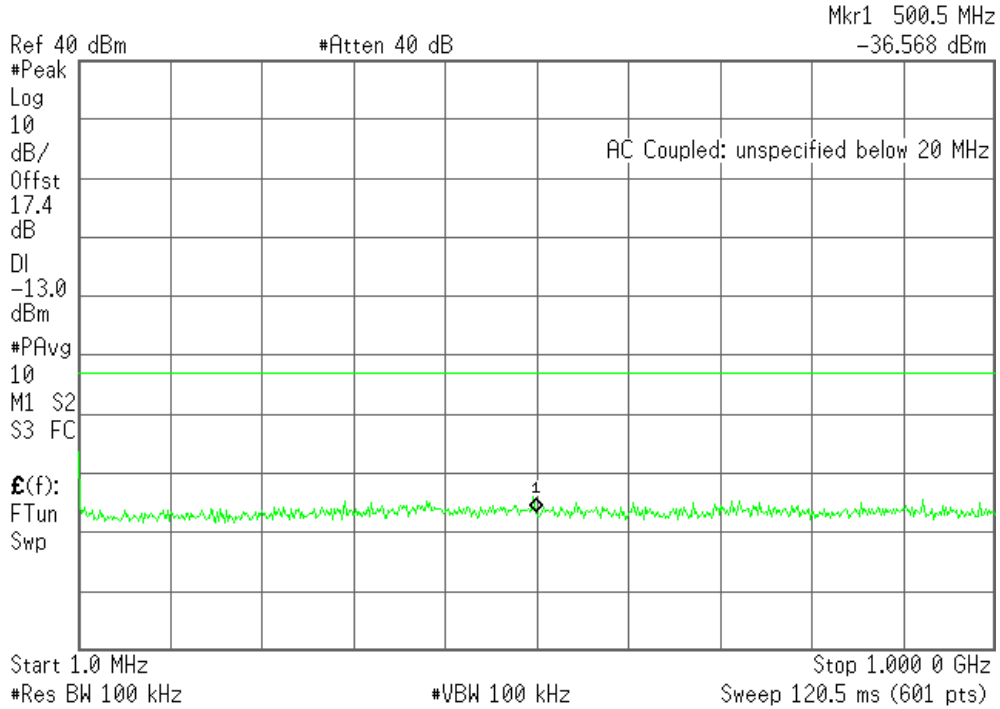

Plot 6.4.20) Out of Band Emissions at Antenna Terminals

GMSK, Low channel, 1850.2 MHz, TX signal +/- 20 MHz

Agilent 11:45:39 Nov 9, 2005

L

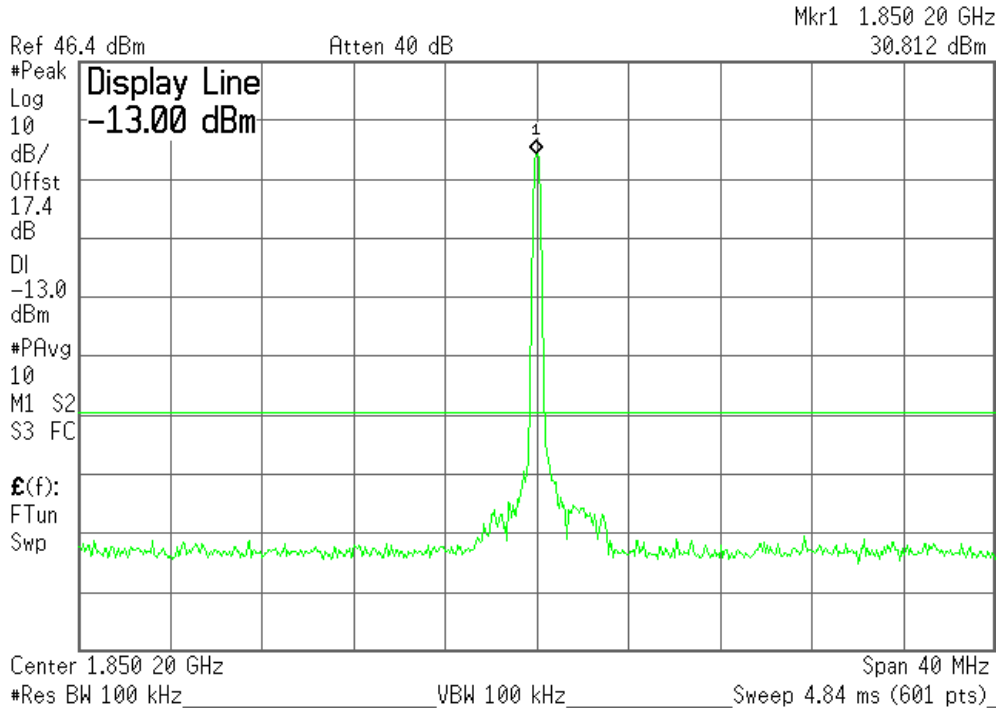

SIERRA WIRELESS, INC.

Plot 6.4.21) Out of Band Emissions at Antenna Terminals

GMSK, Low channel, 1850.2 MHz, 1 GHz to 20 GHz

Agilent 11:16:58 Nov 9, 2005

L

Mkr3 17.02 GHz

-25.050 dBm

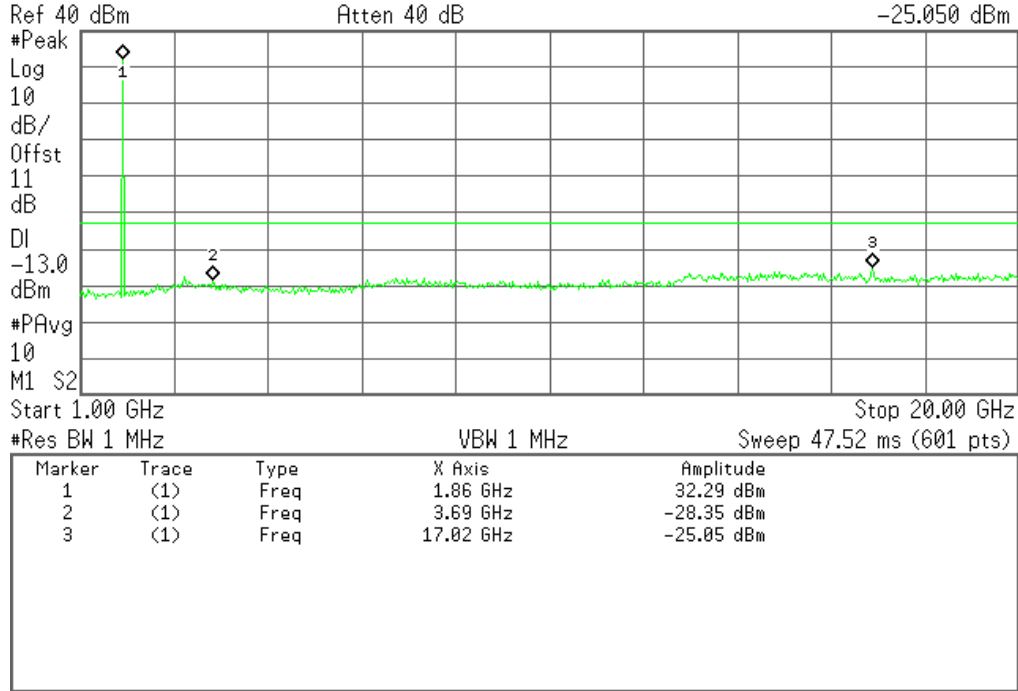

The strong emission shown is the carrier signal.

SIERRA WIRELESS, INC.

Plot 6.4.22) Out of Band Emissions at Antenna Terminals

GMSK, Middle channel, 1880.0 MHz, 1 MHz to 1 GHz

Agilent 10:21:58 Nov 8, 2005

L

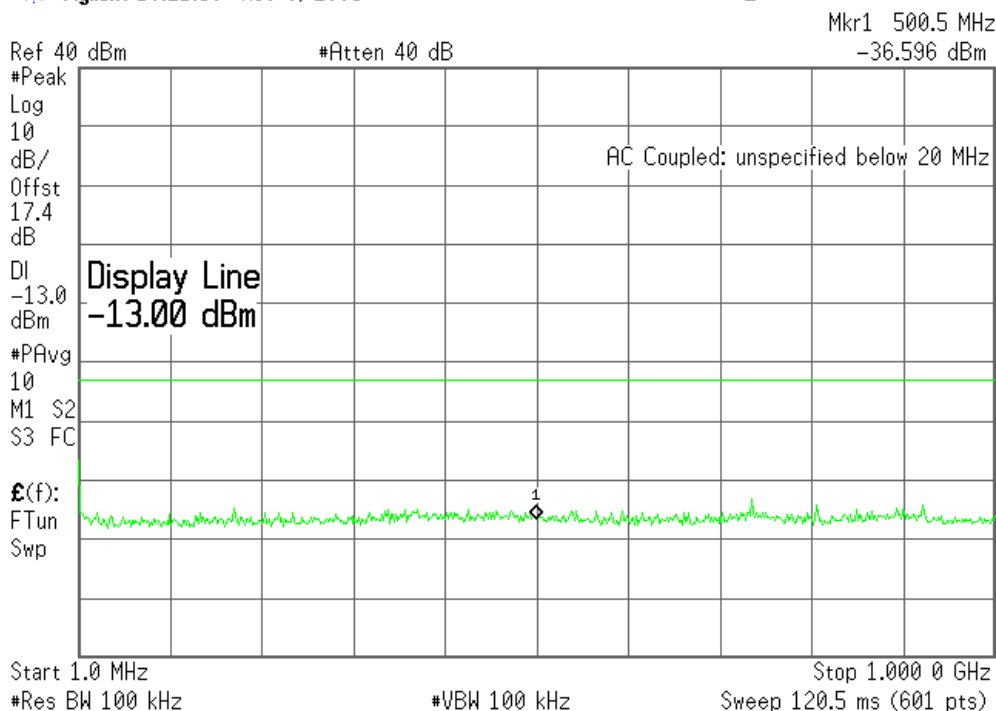

Plot 6.4.23) Out of Band Emissions at Antenna Terminals

GMSK, Middle channel, 1880.0 MHz, TX signal +/- 20 MHz

Agilent 11:47:15 Nov 9, 2005

L

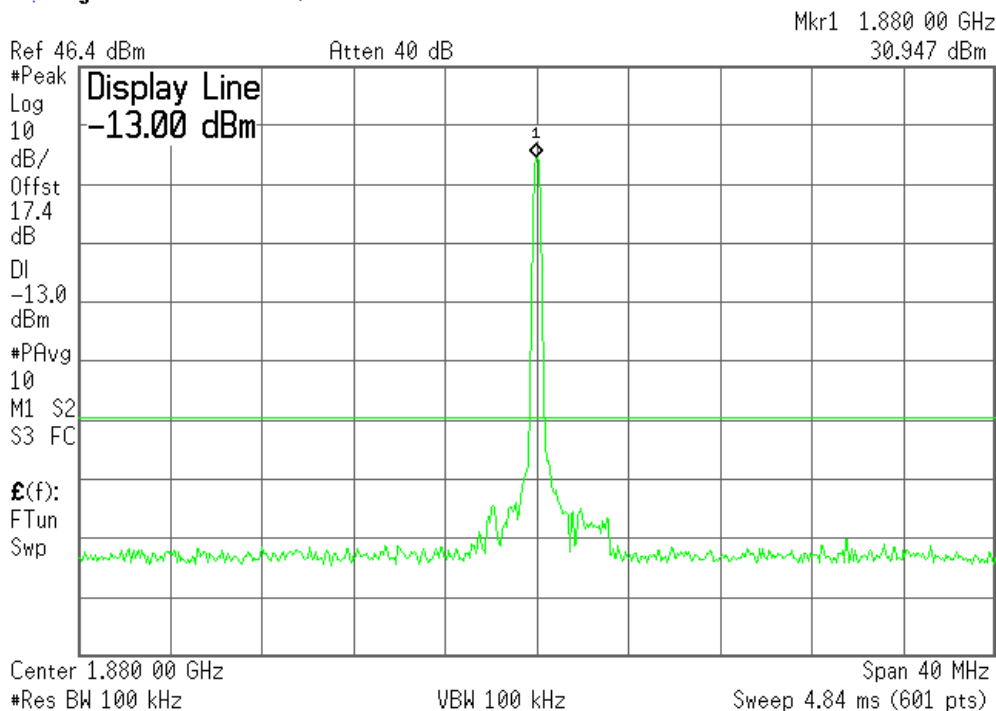

SIERRA WIRELESS, INC.

Plot 6.4.24) Out of Band Emissions at Antenna Terminals

GMSK, Middle channel, 1880.0 MHz, 1 GHz to 20 GHz

Agilent 11:18:17 Nov 9, 2005

L

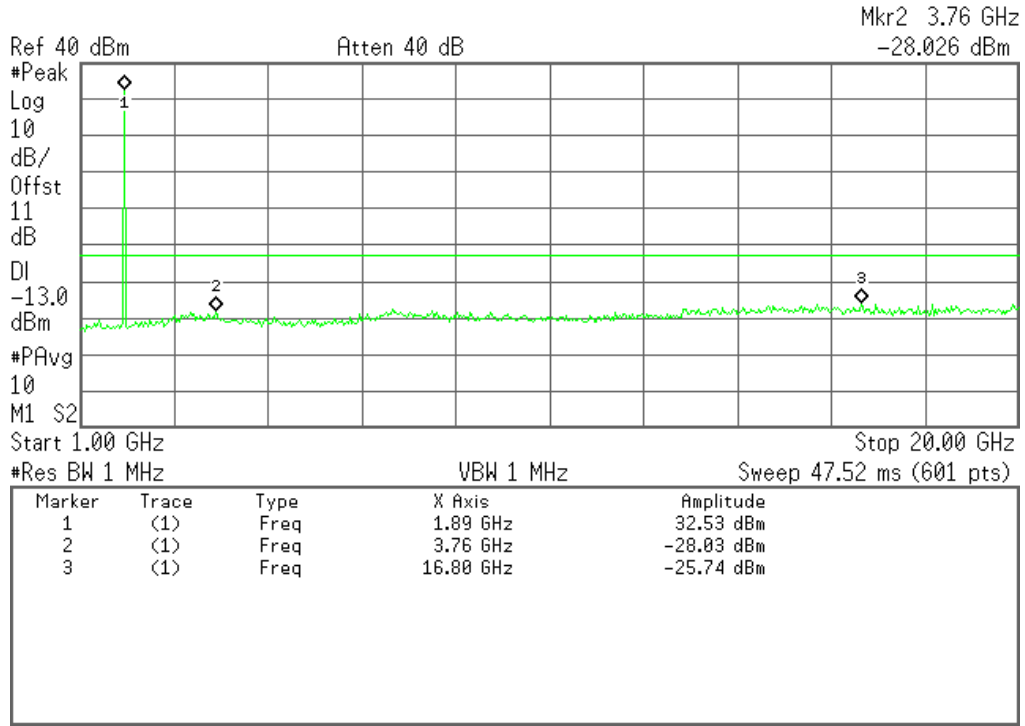

The strong emission shown is the carrier signal.

Plot 6.4.25) Out of Band Emissions at Antenna Terminals

GMSK, High channel, 1909.8 MHz, 1 MHz to 1 GHz

Agilent 10:23:26 Nov 8, 2005

L

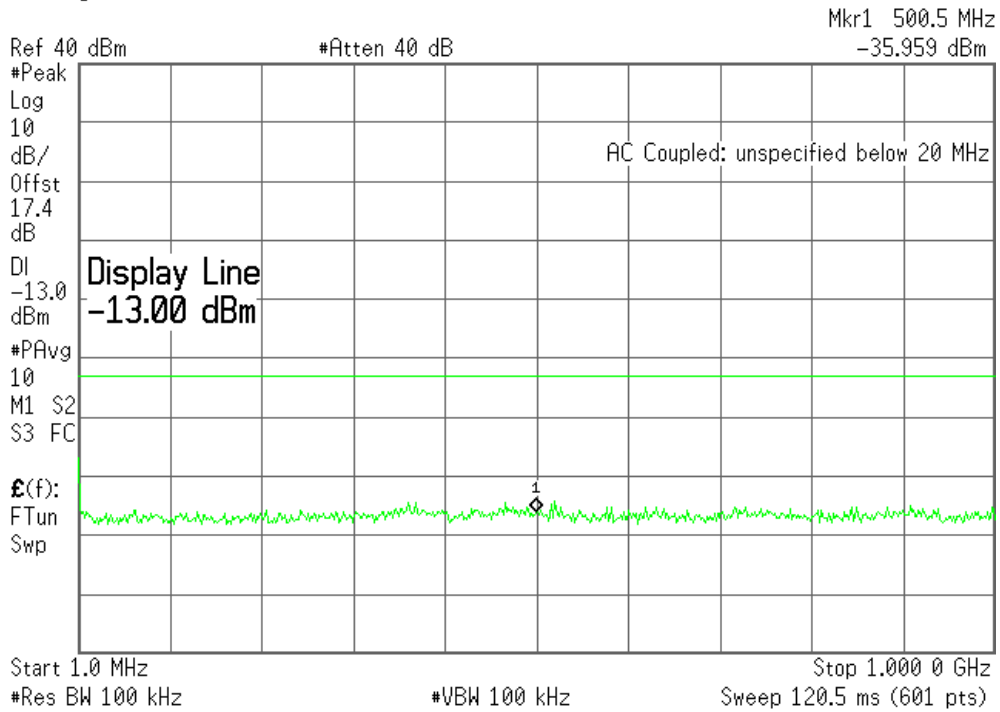

Plot 6.4.26) Out of Band Emissions at Antenna Terminals

GMSK, High channel, 1909.8 MHz, TX signal +/- 20 MHz

Agilent 10:35:57 Nov 9, 2005

L

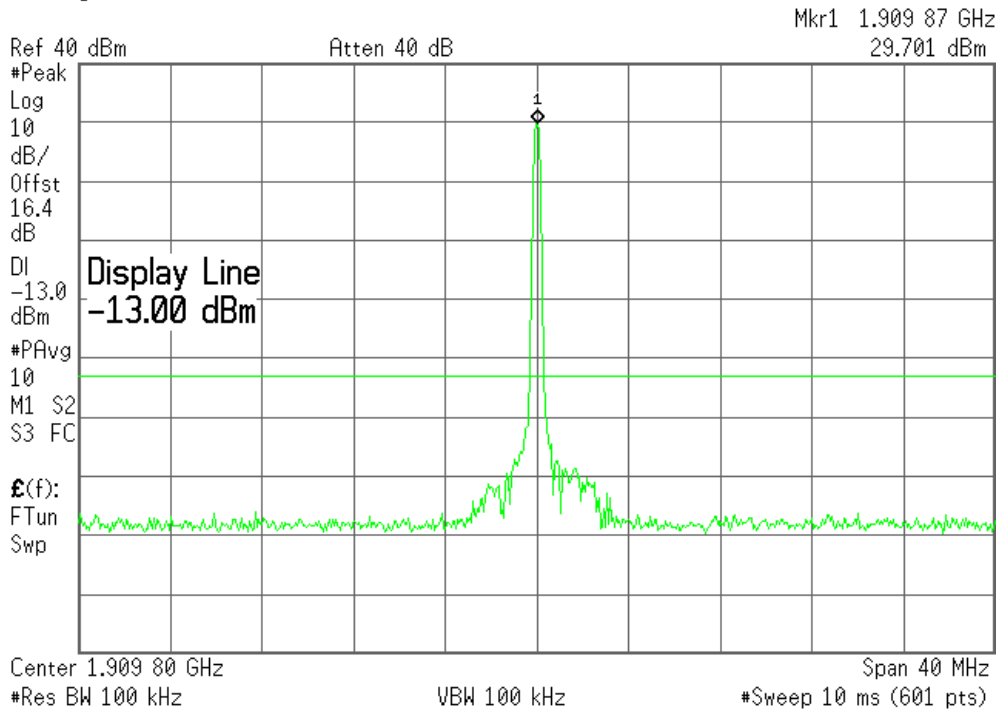

SIERRA WIRELESS, INC.

Plot 6.4.27) Out of Band Emissions at Antenna Terminals

GMSK, High channel, 1909.8 MHz, 1 GHz to 20 GHz

Agilent 11:19:26 Nov 9, 2005

L

Mkr3 13.32 GHz

-24.622 dBm

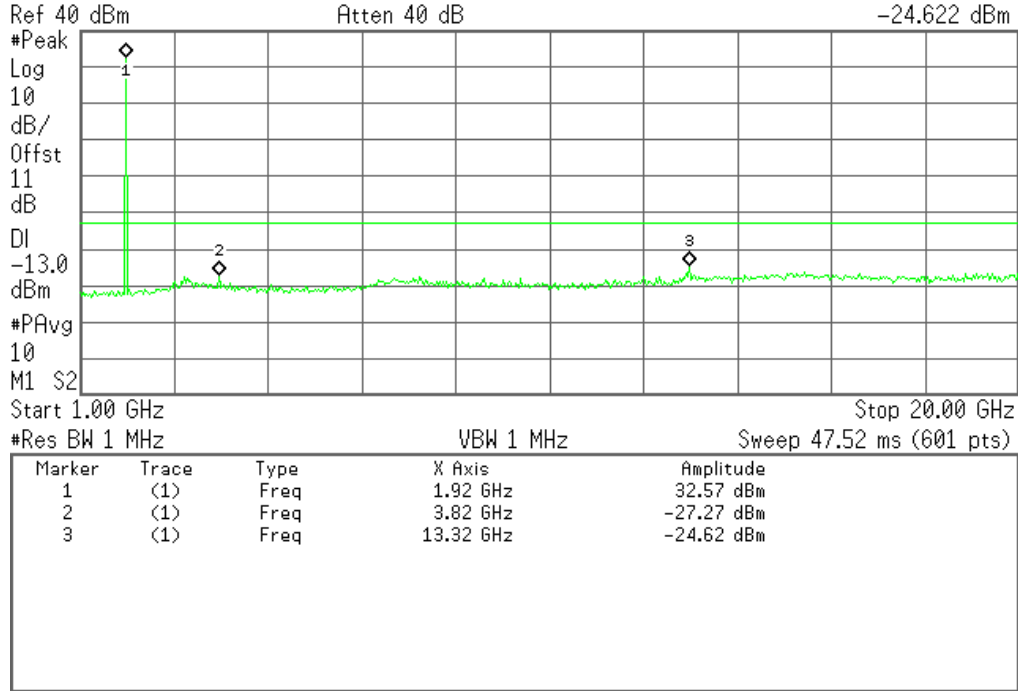

The strong emission shown is the carrier signal.

Plot 6.4.28) Out of Band Emissions at Antenna Terminals

8-PSK, Low channel, 1850.2 MHz, 1 MHz to 1 GHz

Agilent 10:24:50 Nov 8, 2005

L

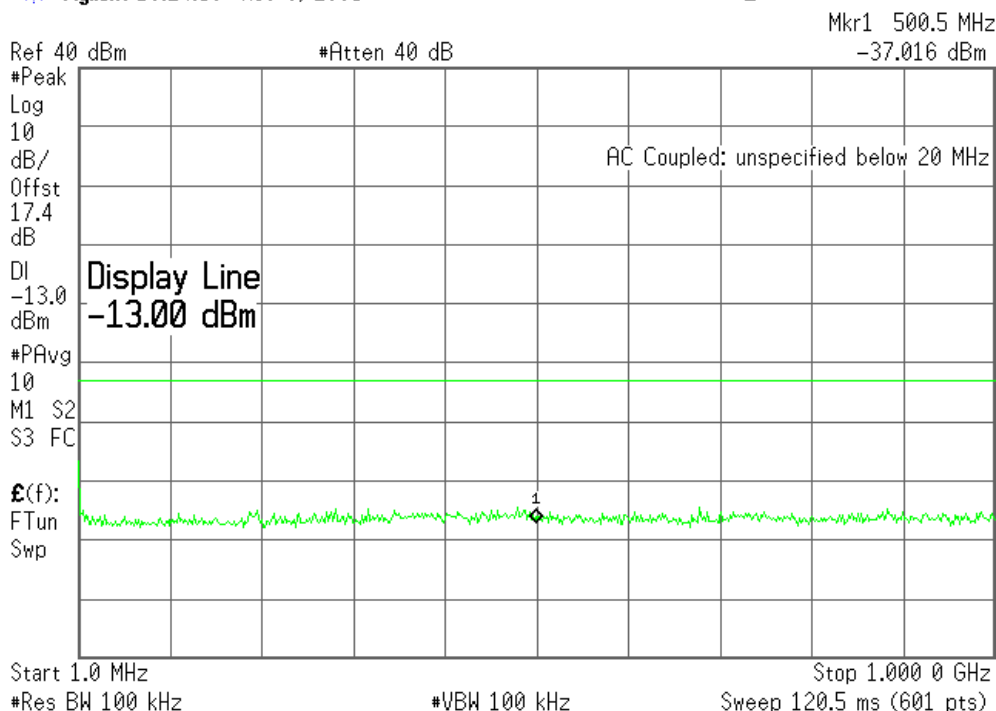

Plot 6.4.29) Out of Band Emissions at Antenna Terminals

8-PSK, Low channel, 1850.2 MHz, TX signal +/- 20 MHz

Agilent 11:48:39 Nov 9, 2005

L

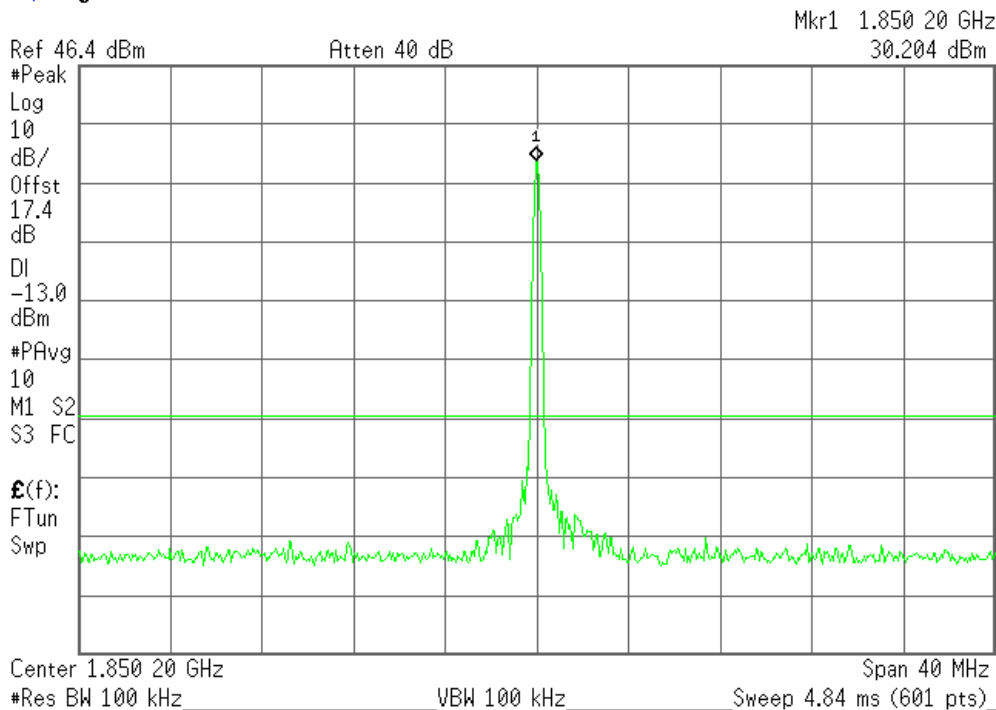

SIERRA WIRELESS, INC.

Plot 6.4.30) Out of Band Emissions at Antenna Terminals

8-PSK, Low channel, 1850.2 MHz, 1 GHz to 20 GHz

Agilent 11:21:29 Nov 9, 2005

L

Mkr3 15.25 GHz

-25.680 dBm

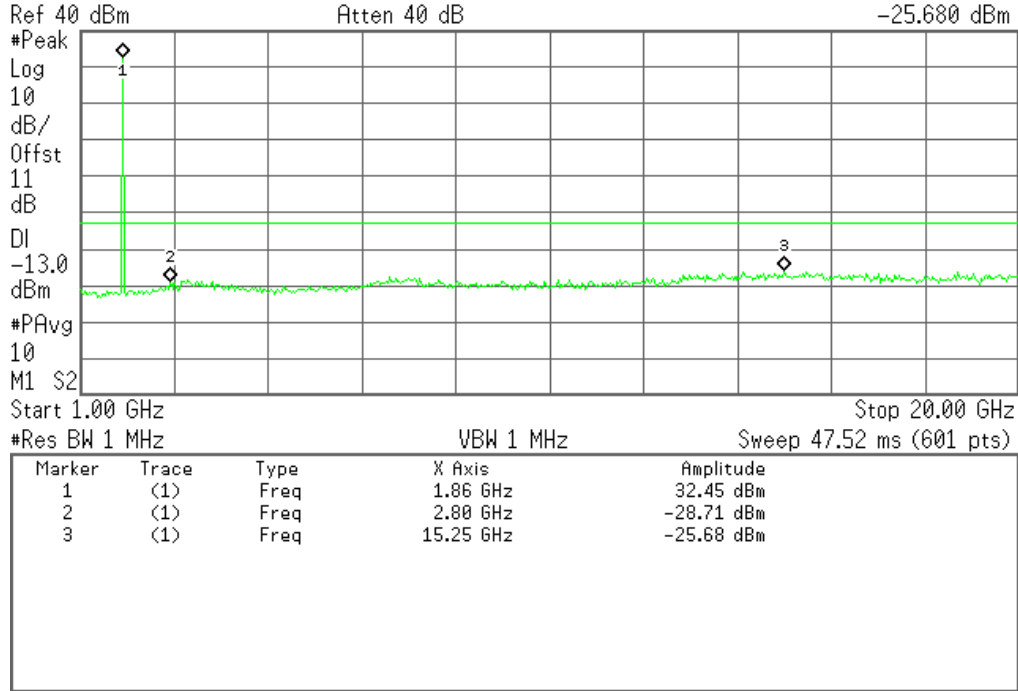

The strong emission shown is the carrier signal.

SIERRA WIRELESS, INC.

Plot 6.4.31) Out of Band Emissions at Antenna Terminals

8-PSK, Middle channel, 1880.0 MHz, 1 MHz to 1 GHz

Agilent 10:25:44 Nov 8, 2005

L

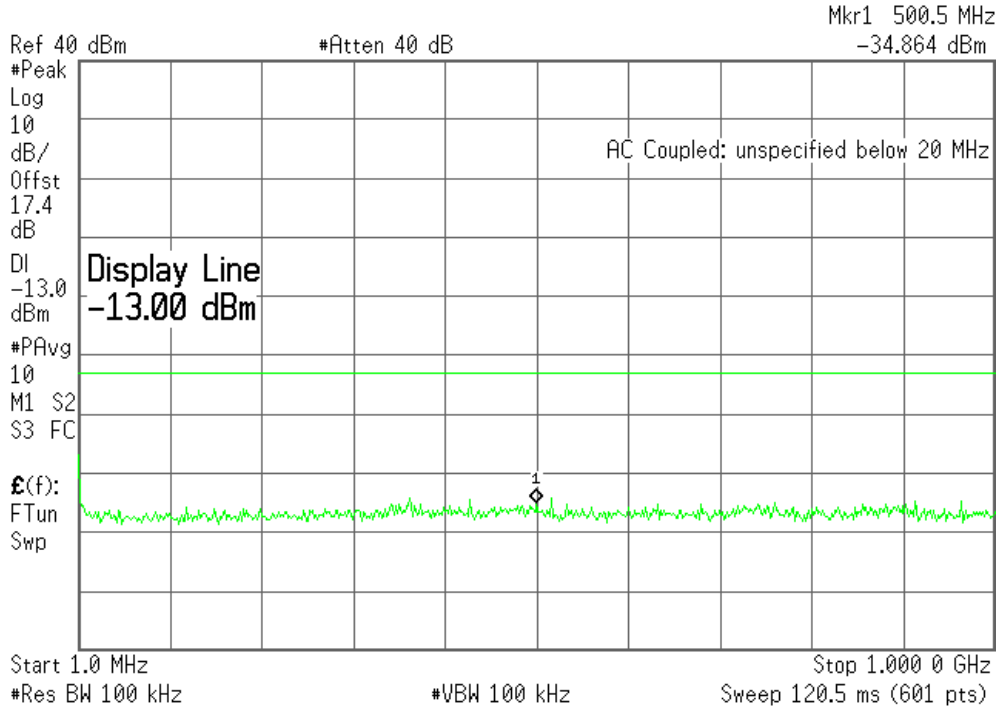

Plot 6.4.32) Out of Band Emissions at Antenna Terminals

8-PSK, Middle channel, 1880.0 MHz, TX signal +/- 20 MHz

Agilent 11:49:27 Nov 9, 2005

L

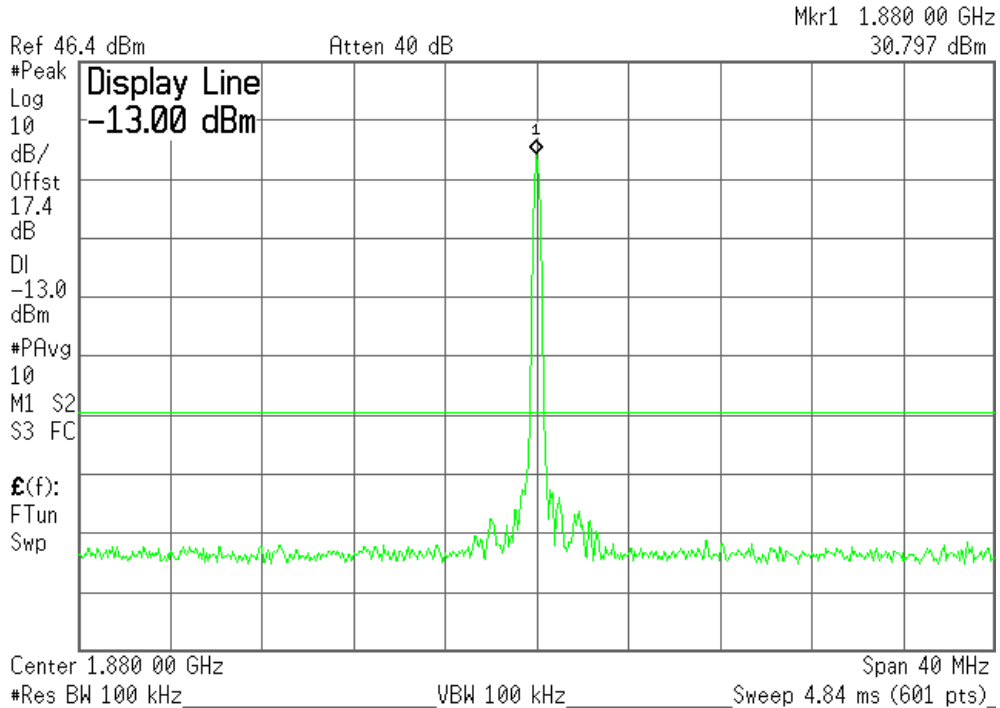

SIERRA WIRELESS, INC.

Plot 6.4.33) Out of Band Emissions at Antenna Terminals

8-PSK, Middle channel, 1880.0 MHz, 1 GHz to 20 GHz

Agilent 11:22:54 Nov 9, 2005

L

Mkr3 10.22 GHz
-27.914 dBm

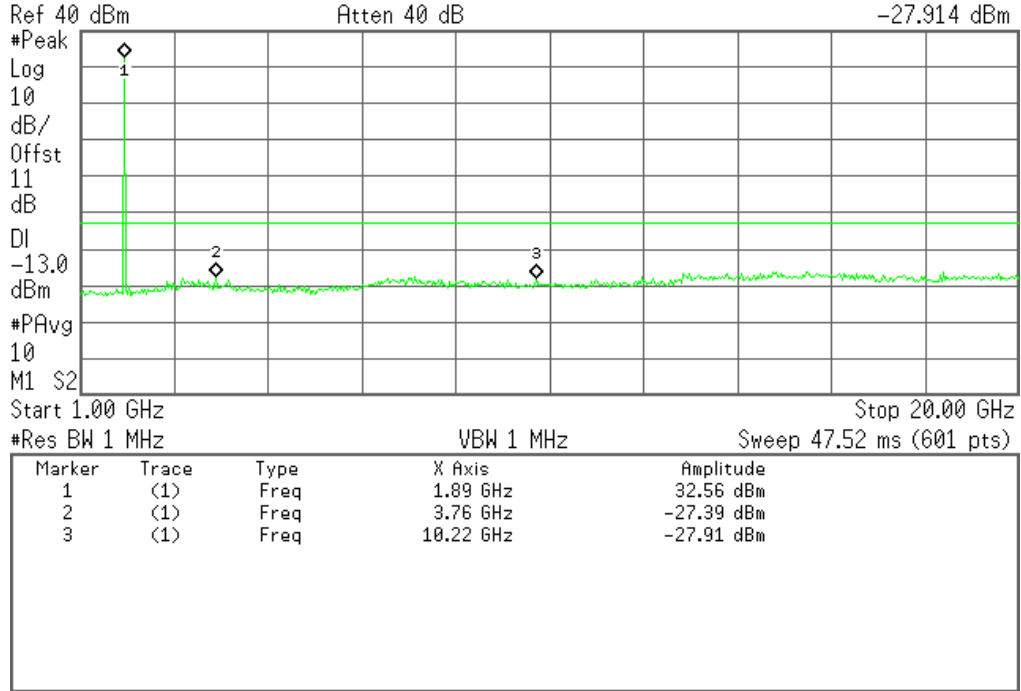

The strong emission shown is the carrier signal.

Plot 6.4.34) Out of Band Emissions at Antenna Terminals

8-PSK, High channel, 1909.8 MHz, 1 MHz to 1 GHz

Agilent 10:26:32 Nov 8, 2005

L

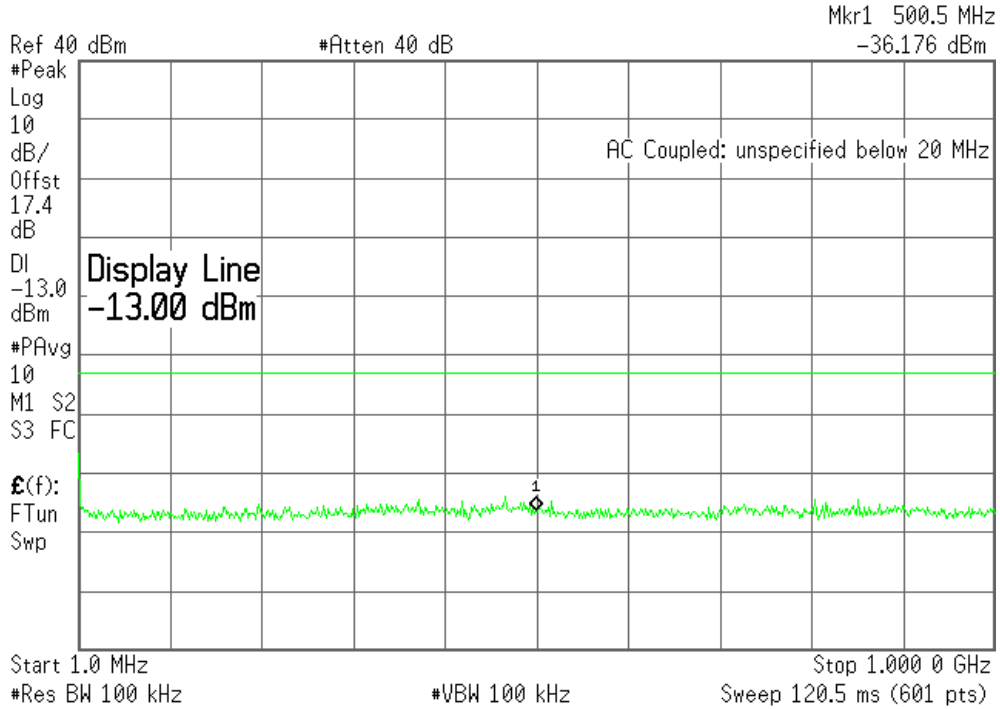

Plot 6.4.35) Out of Band Emissions at Antenna Terminals

8-PSK, High channel, 1909.8 MHz, TX signal +/- 20 MHz

Agilent 11:50:52 Nov 9, 2005

L

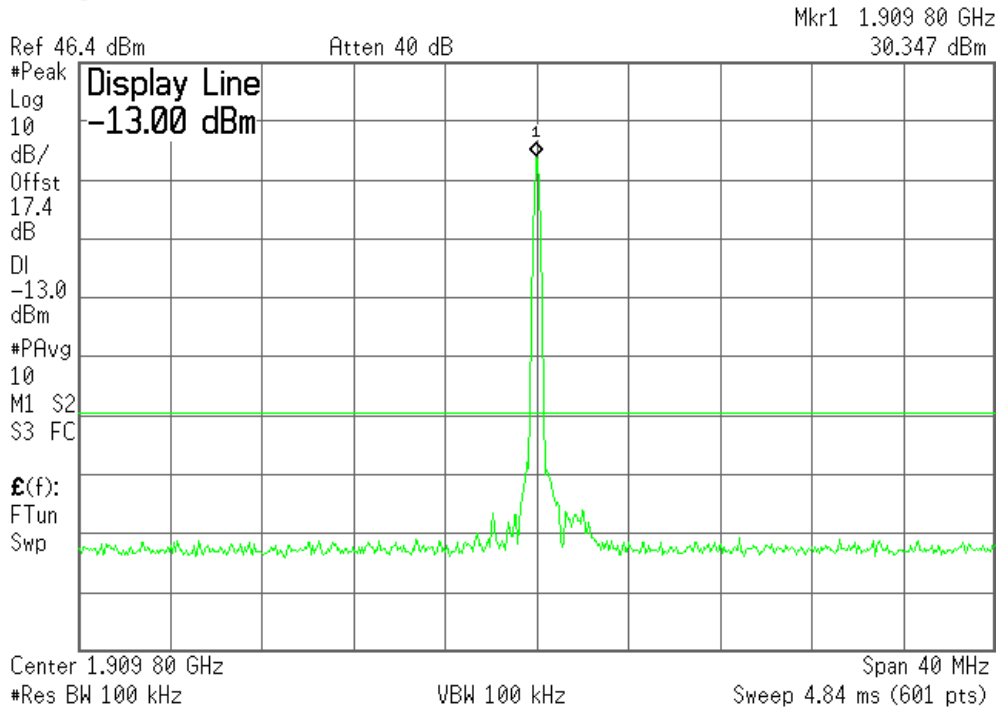

SIERRA WIRELESS, INC.

Plot 6.4.36) Out of Band Emissions at Antenna Terminals

8-PSK, High channel, 1909.8 MHz, 1 GHz to 20 GHz

Agilent 11:24:03 Nov 9, 2005

L

Mkr3 13.70 GHz

-26.222 dBm

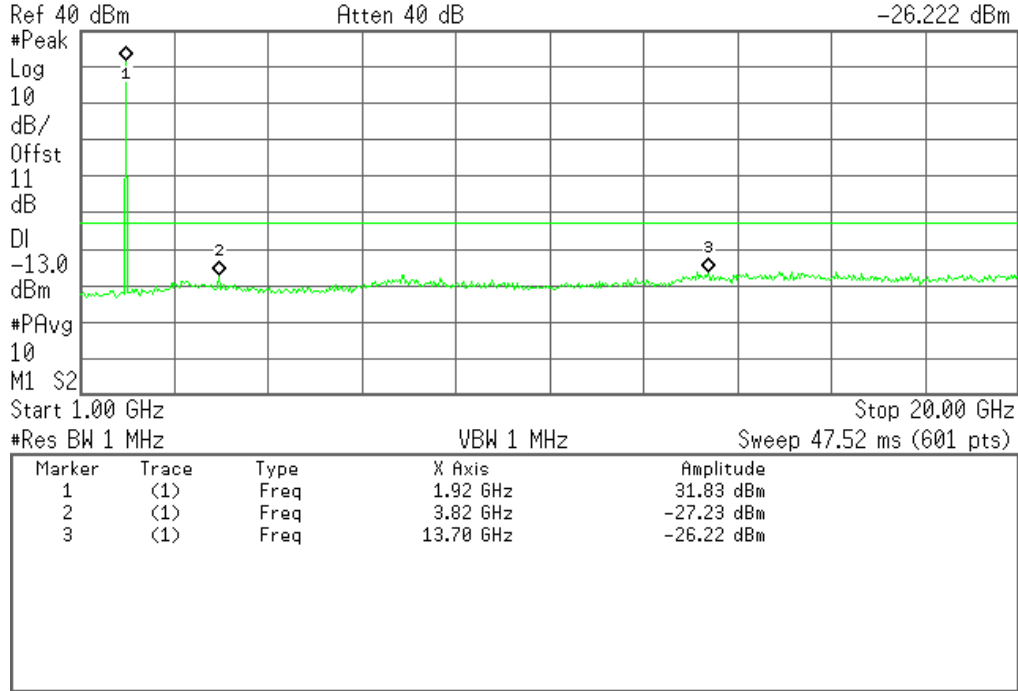

The strong emission shown is the carrier signal.

Plot 6.4.37) Out of Band Emissions at Antenna Terminals

WCDMA, Low channel, 826.4 MHz, 1 MHz to 1 GHz

Agilent 10:42:03 Nov 8, 2005

L

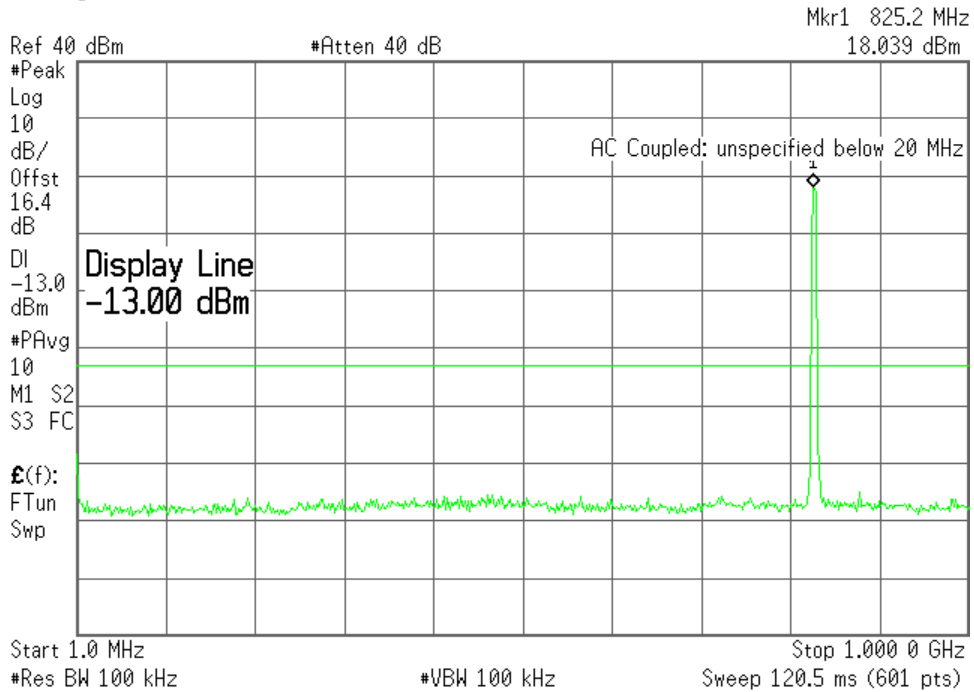

Plot 6.4.38) Out of Band Emissions at Antenna Terminals

WCDMA, Low channel, 826.4 MHz, TX signal +/- 20 MHz

Agilent 12:16:40 Nov 9, 2005

L

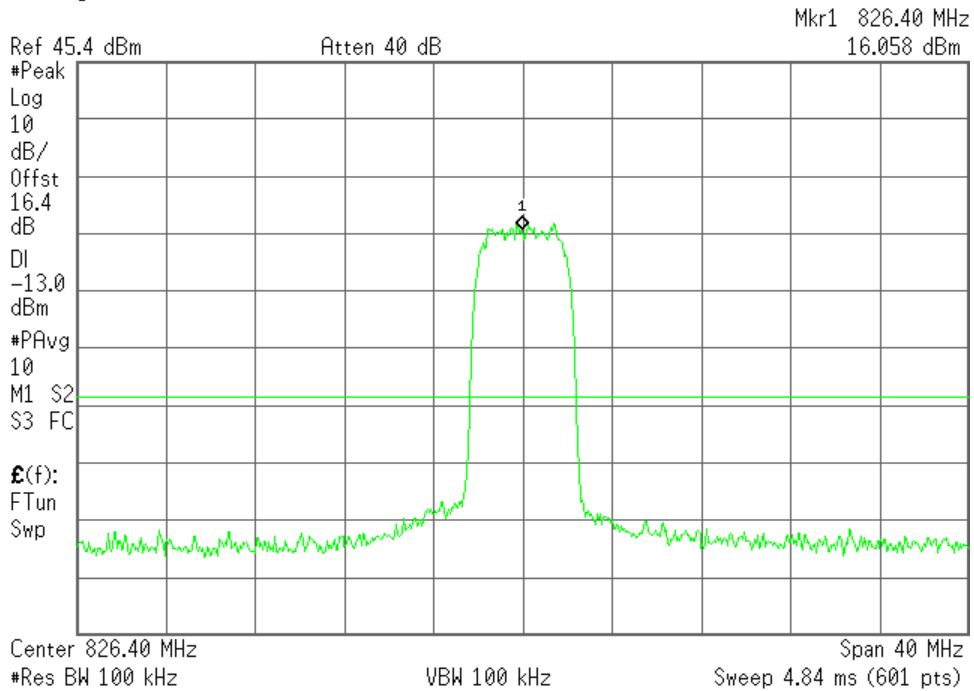

The strong emission shown in each case is the carrier signal.

SIERRA WIRELESS, INC.

Plot 6.4.39) Out of Band Emissions at Antenna Terminals

WCDMA, Low channel, 826.4 MHz, 1 GHz to 20 GHz

Agilent 11:26:54 Nov 9, 2005

L

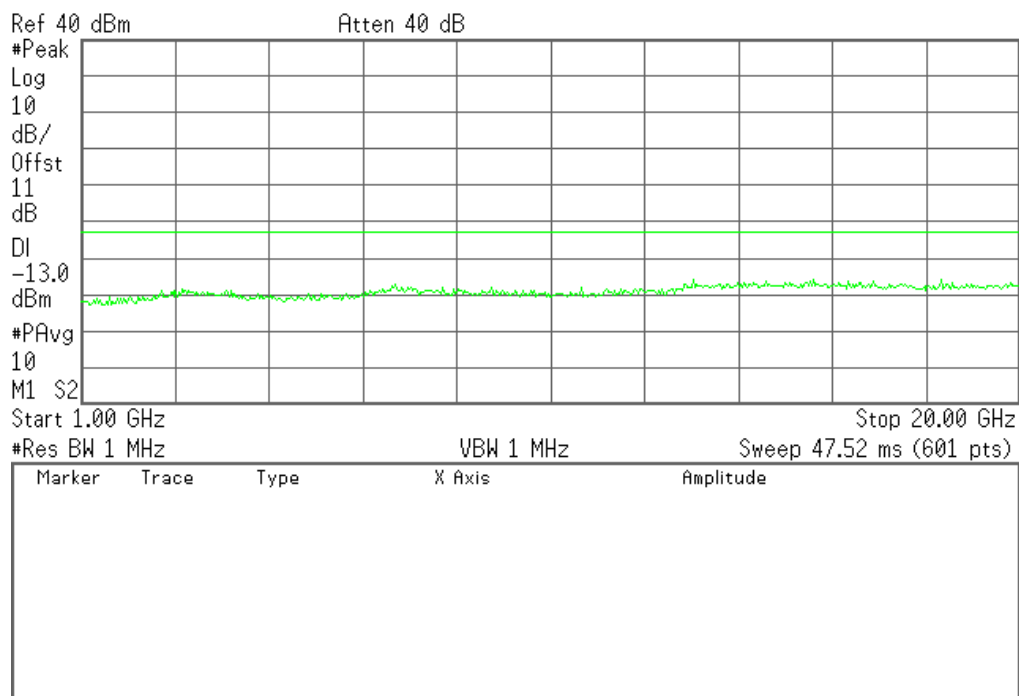

Cellular Harmonics for Ch. 128 (824.2 MHz)	Level (dBm)
Second	--
Third	--
All others	< -30dBm up to 20GHz

Plot 6.4.40) Out of Band Emissions at Antenna Terminals

WCDMA, Middle channel, 836.4 MHz, 1 MHz to 1 GHz

Agilent 10:43:14 Nov 8, 2005

L

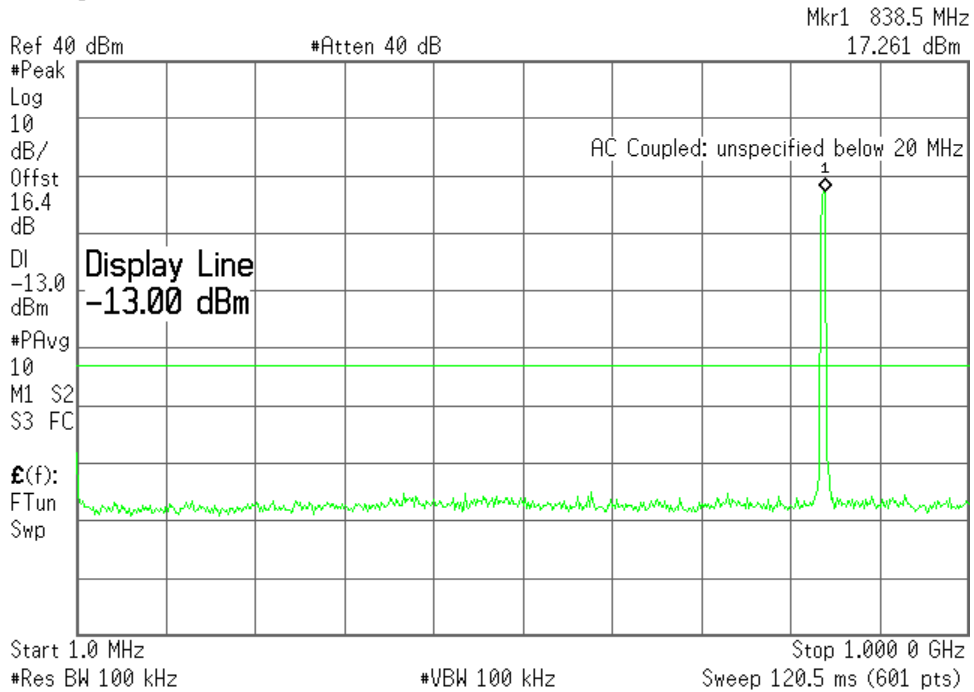

Plot 6.4.41) Out of Band Emissions at Antenna Terminals

WCDMA, Middle channel, 836.4 MHz, TX signal +/- 20 MHz

Agilent 09:57:40 Nov 9, 2005

L

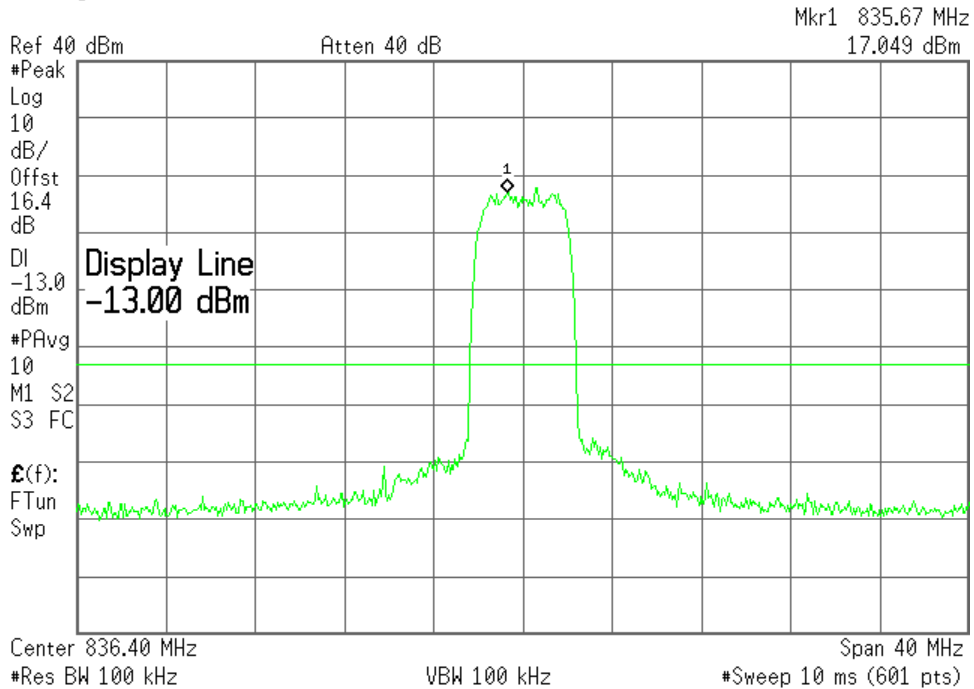

The strong emission shown in each case is the carrier signal.

SIERRA WIRELESS, INC.

Plot 6.4.42) Out of Band Emissions at Antenna Terminals

WCDMA, Middle channel, 836.4 MHz, 1 GHz to 20 GHz

Agilent 11:28:31 Nov 9, 2005

L

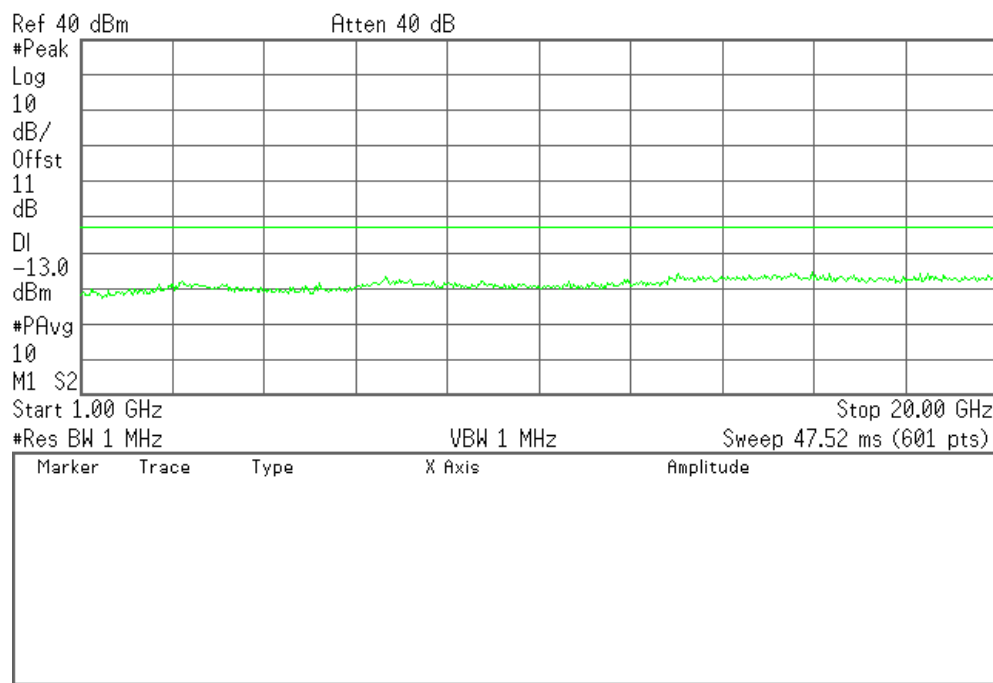

Cellular Harmonics for Ch. 190 (836.6 MHz)	Level (dBm)
Second	--
Third	--
All others	< -30dBm up to 20GHz

SIERRA WIRELESS, INC.

Plot 6.4.43) Out of Band Emissions at Antenna Terminals

WCDMA, High Channel, 846.6 MHz, 1 MHz to 1 GHz

Agilent 10:43:59 Nov 8, 2005

L

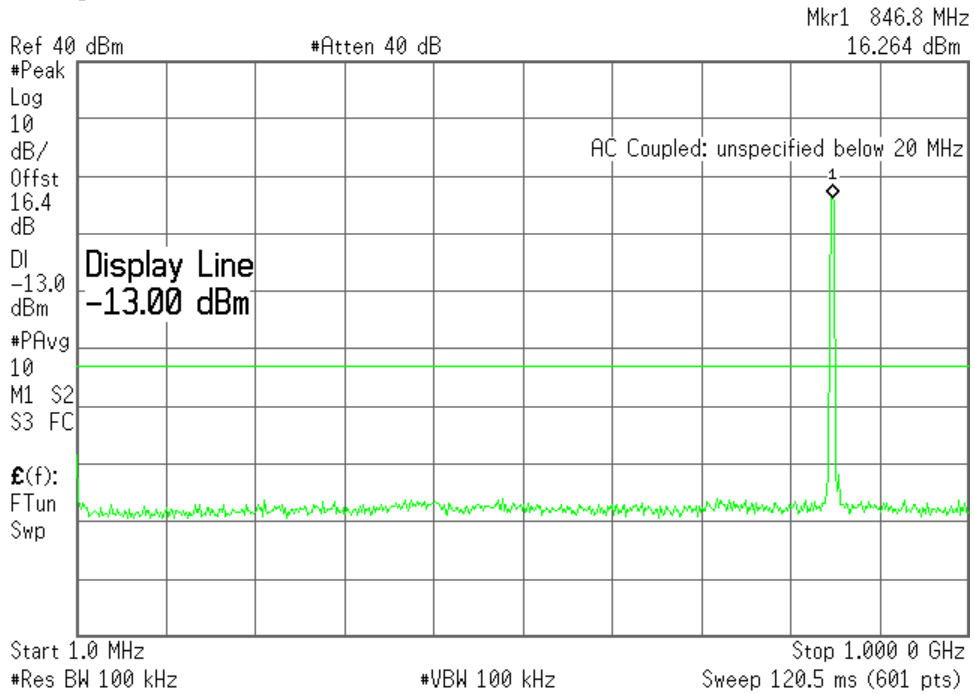

Plot 6.4.44) Out of Band Emissions at Antenna Terminals

WCDMA, High Channel, 846.6 MHz, TX signal +/- 20 MHz

Agilent 10:01:26 Nov 9, 2005

L

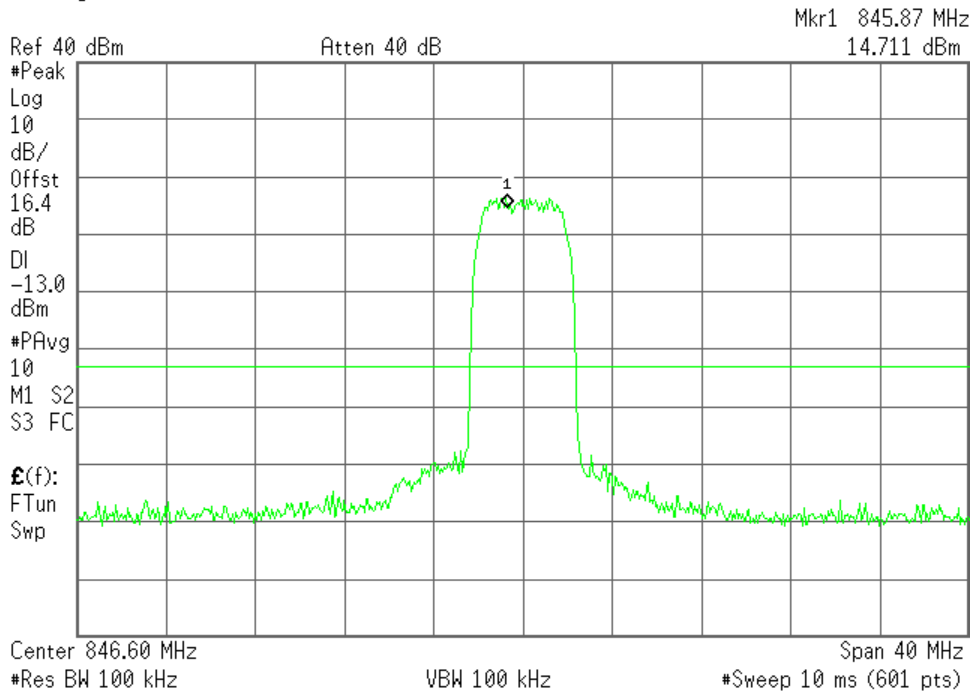

The strong emission shown in each case is the carrier signal.

SIERRA WIRELESS, INC.

Plot 6.4.45) Out of Band Emissions at Antenna Terminals

WCDMA, High Channel, 846.6 MHz, 1 GHz to 20 GHz

Agilent 11:29:01 Nov 9, 2005

L

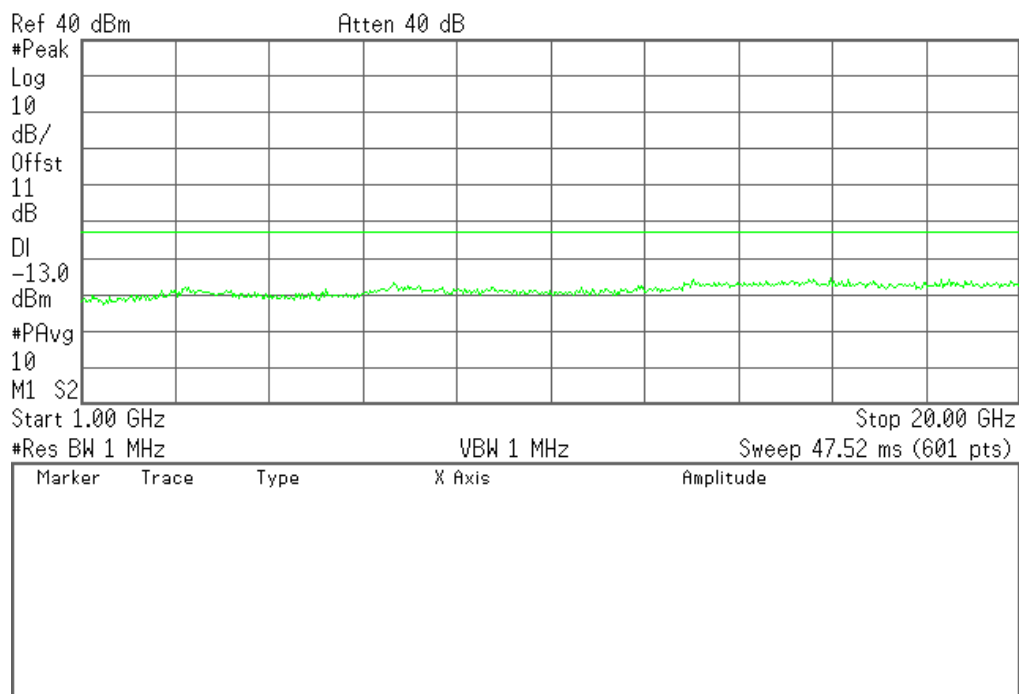

Cellular Harmonics for Ch. 251 (848.8 MHz)	Level (dBm)
Second	--
Third	--
All others	< -30dBm up to 20GHz

Plot 6.4.46) Out of Band Emissions at Antenna Terminals

WCDMA, Low channel, 1852.4 MHz, 1 MHz to 1 GHz

Agilent 09:54:48 Nov 8, 2005

L

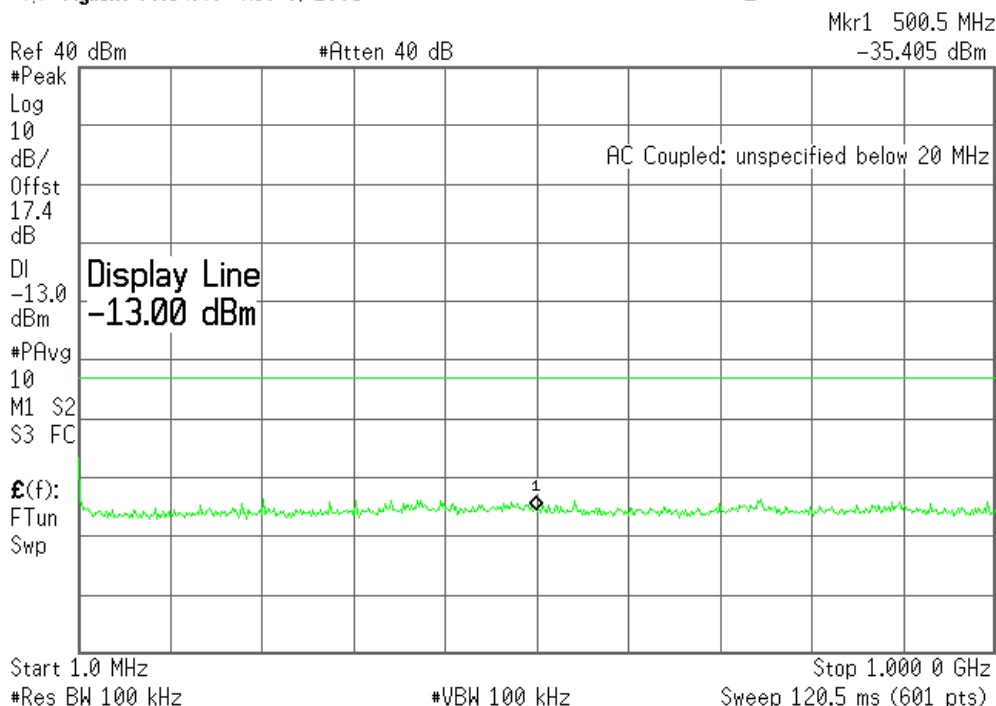

Plot 6.4.47) Out of Band Emissions at Antenna Terminals

WCDMA, Low channel, 1852.4 MHz, TX signal +/- 20 MHz

Agilent 10:05:01 Nov 9, 2005

L

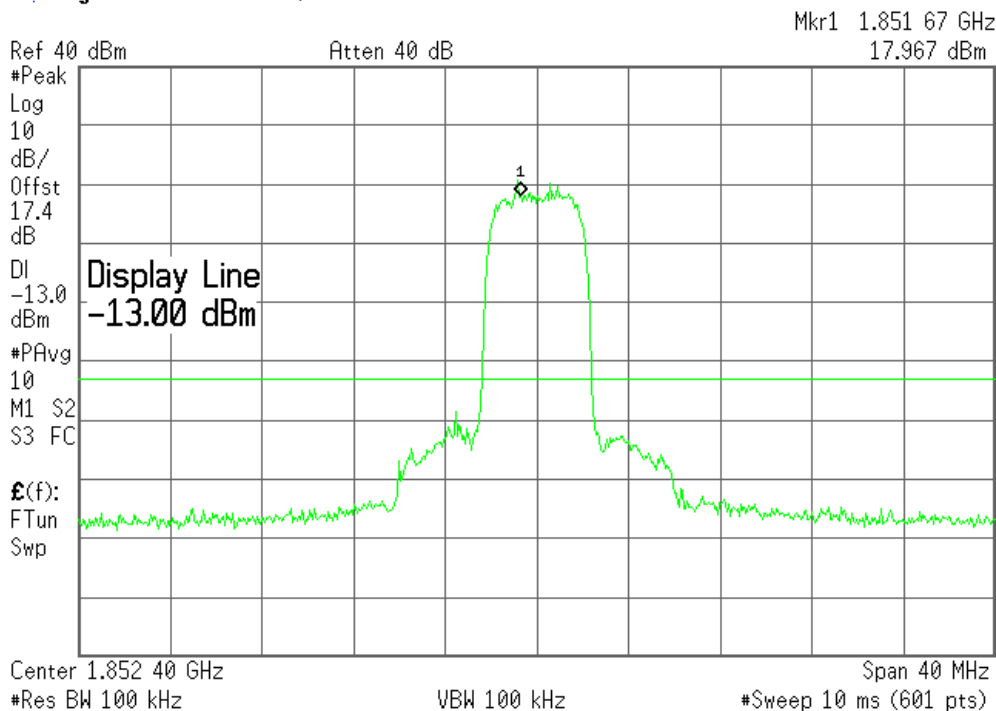

SIERRA WIRELESS, INC.

Plot 6.4.48) Out of Band Emissions at Antenna Terminals

WCDMA, Low channel, 1852.4 MHz, 1 GHz to 20 GHz

Agilent 11:33:29 Nov 9, 2005

L

Mkr3 15.79 GHz

-26.047 dBm

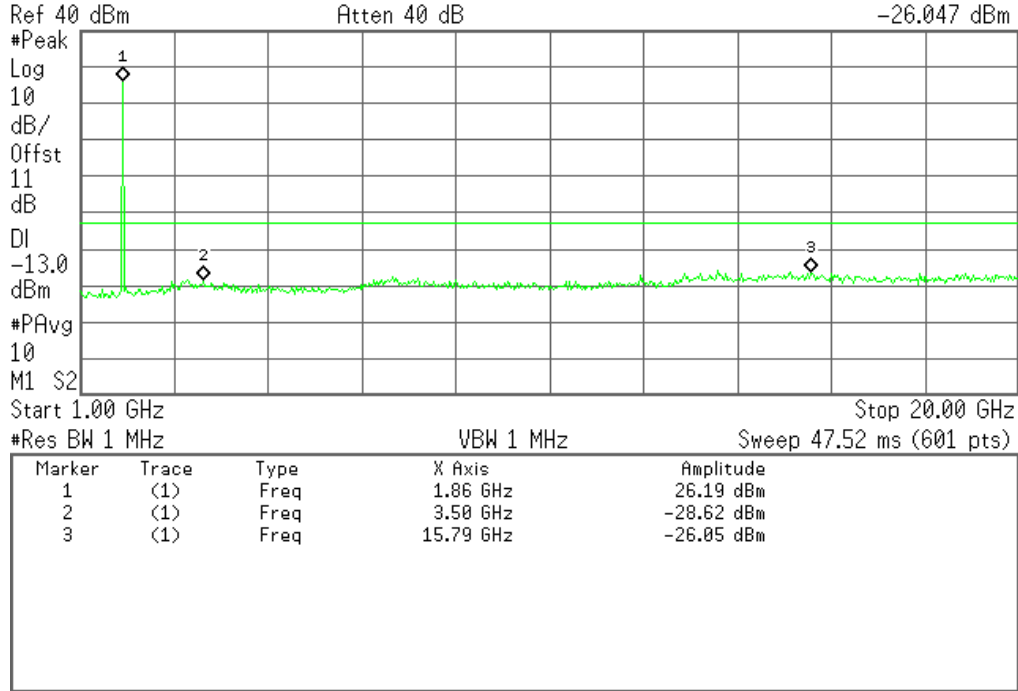

The strong emission shown is the carrier signal.

Plot 6.4.49) Out of Band Emissions at Antenna Terminals

WCDMA, Middle channel, 1880 MHz, 1 MHz to 1 GHz

Agilent 10:00:00 Nov 8, 2005

L

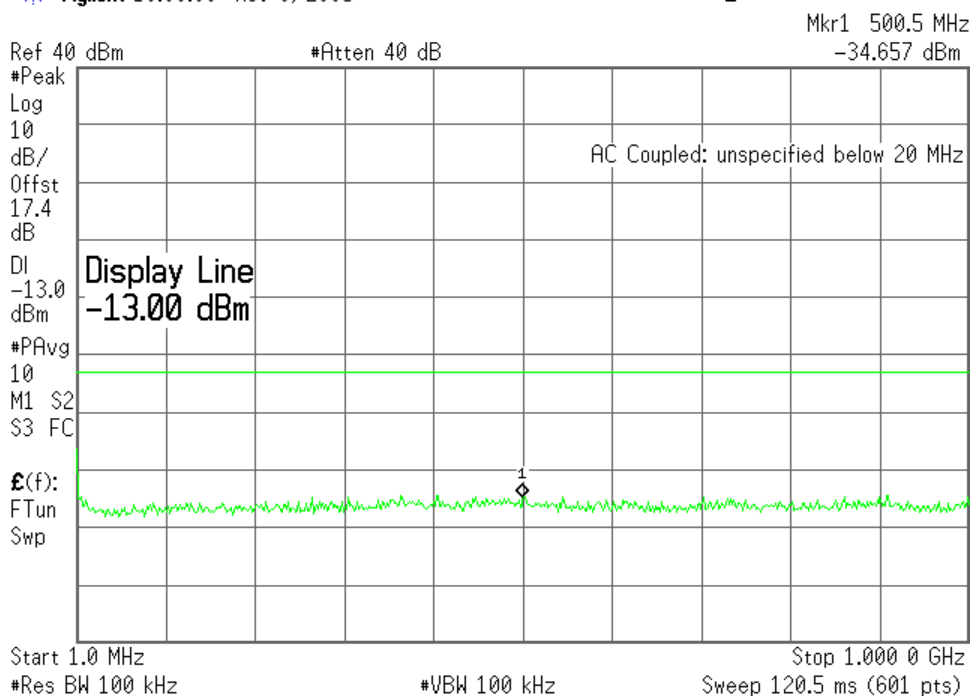

Plot 6.4.50) Out of Band Emissions at Antenna Terminals

WCDMA, Middle channel, 1880 MHz, TX signal +/- 20 MHz

Agilent 10:07:01 Nov 9, 2005

L

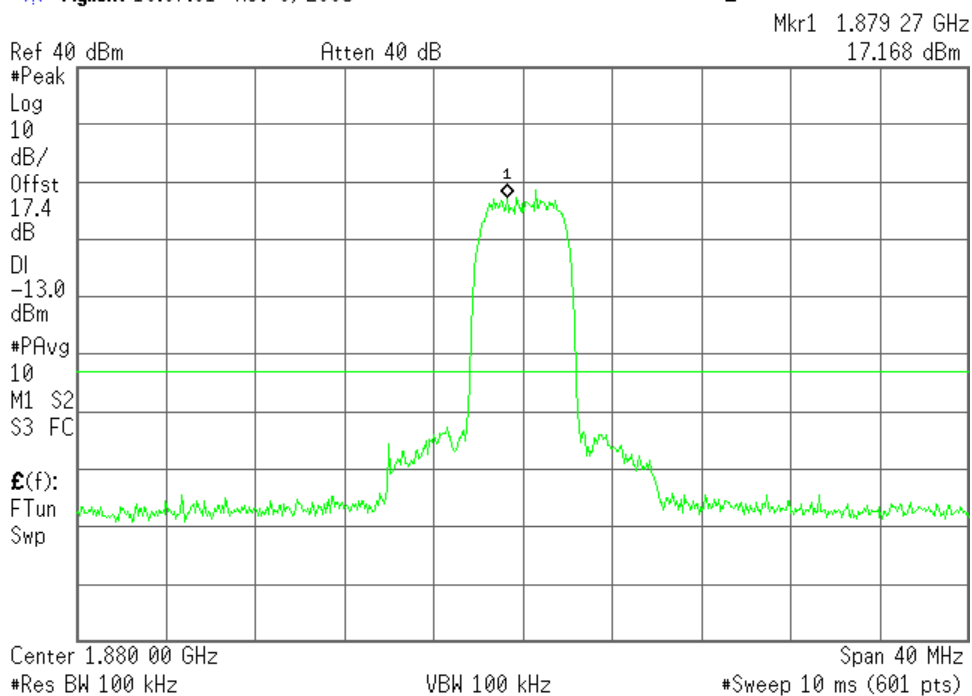

SIERRA WIRELESS, INC.

Plot 6.4.51) Out of Band Emissions at Antenna Terminals

WCDMA, Middle channel, 1880 MHz, 1 GHz to 20 GHz

Agilent 11:32:35 Nov 9, 2005

L

Mkr2 3.22 GHz
-28.028 dBm

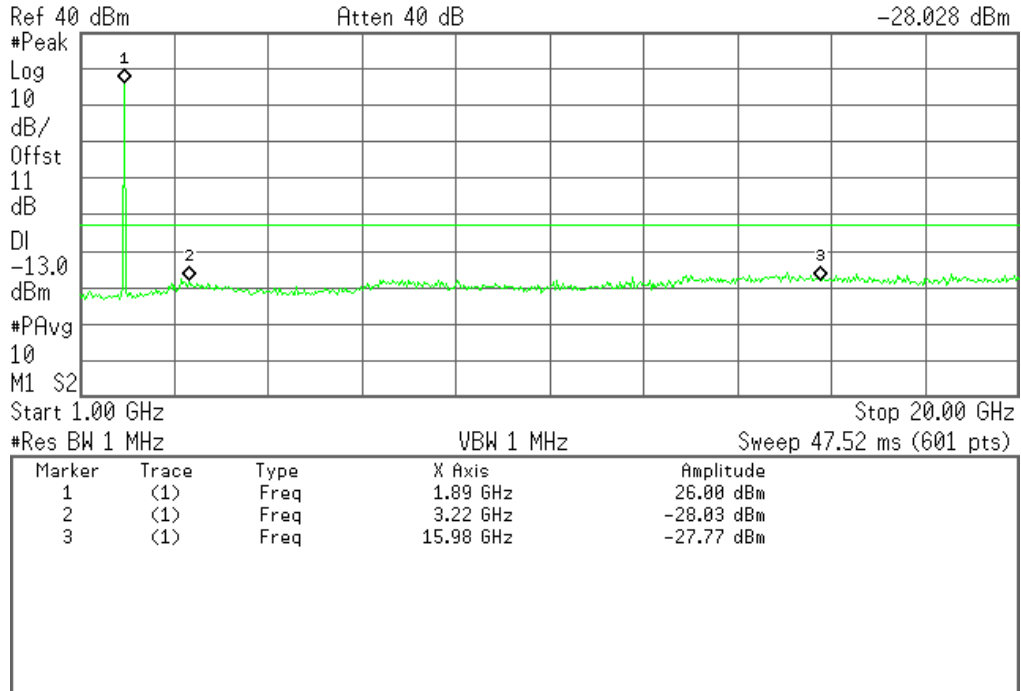

The strong emission shown is the carrier signal.

Plot 6.4.52) Out of Band Emissions at Antenna Terminals

WCDMA, High channel, 1907.6 MHz, 1 MHz to 1 GHz

Agilent 10:00:56 Nov 8, 2005

L

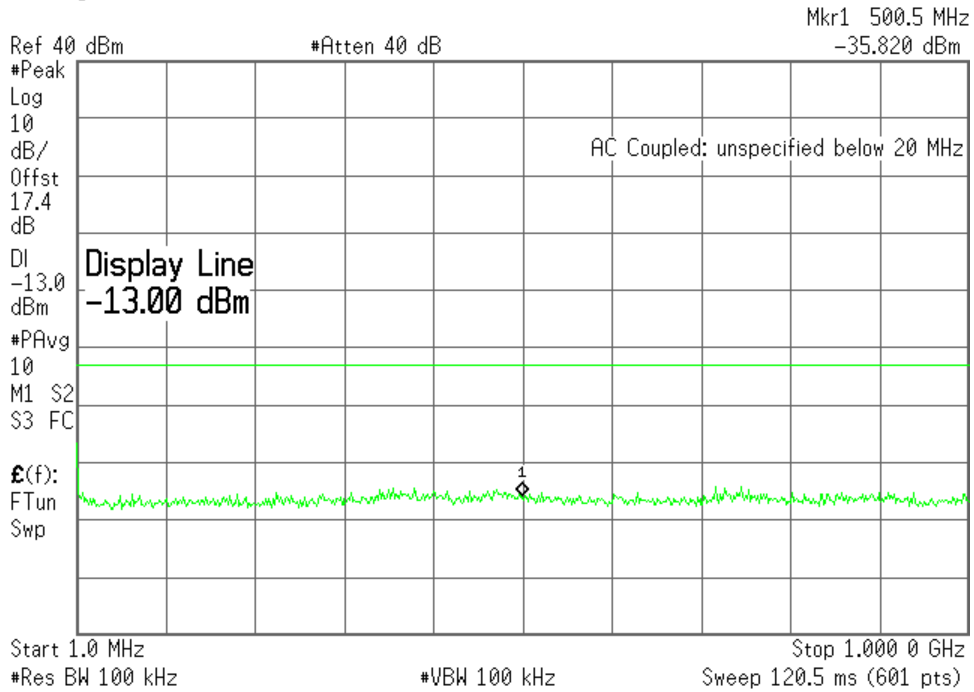

Plot 6.4.53) Out of Band Emissions at Antenna Terminals

WCDMA, High channel, 1907.6 MHz, TX signal +/- 20 MHz

Agilent 10:08:23 Nov 9, 2005

L

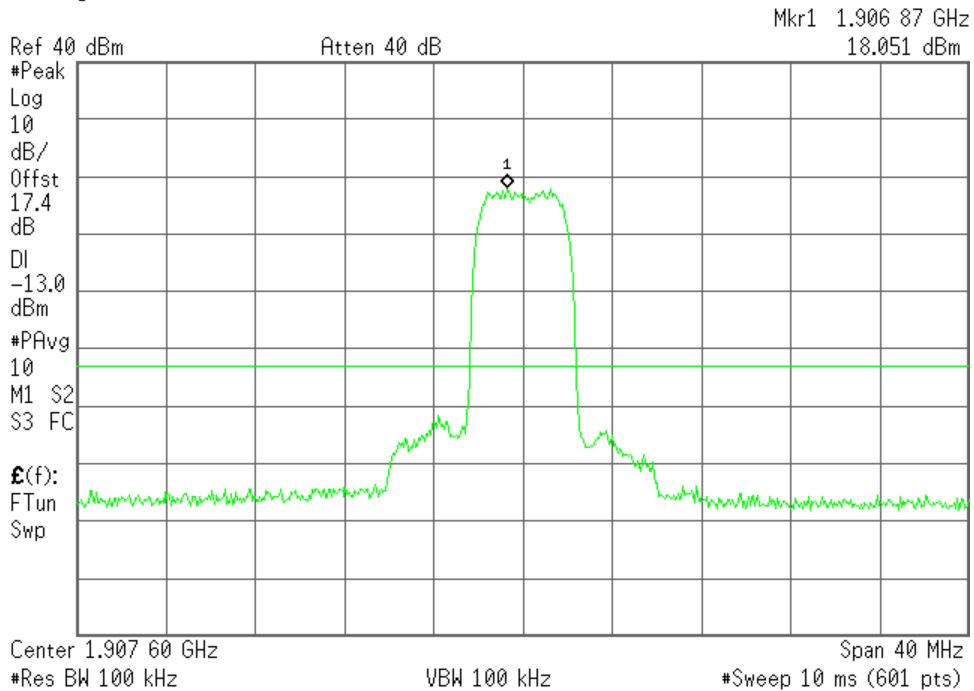

SIERRA WIRELESS, INC.

Plot 6.4.54) Out of Band Emissions at Antenna Terminals

WCDMA, High channel, 1907.6 MHz, 1 GHz to 20 GHz

Agilent 11:31:18 Nov 9, 2005

L

Mkr3 15.98 GHz

-25.633 dBm

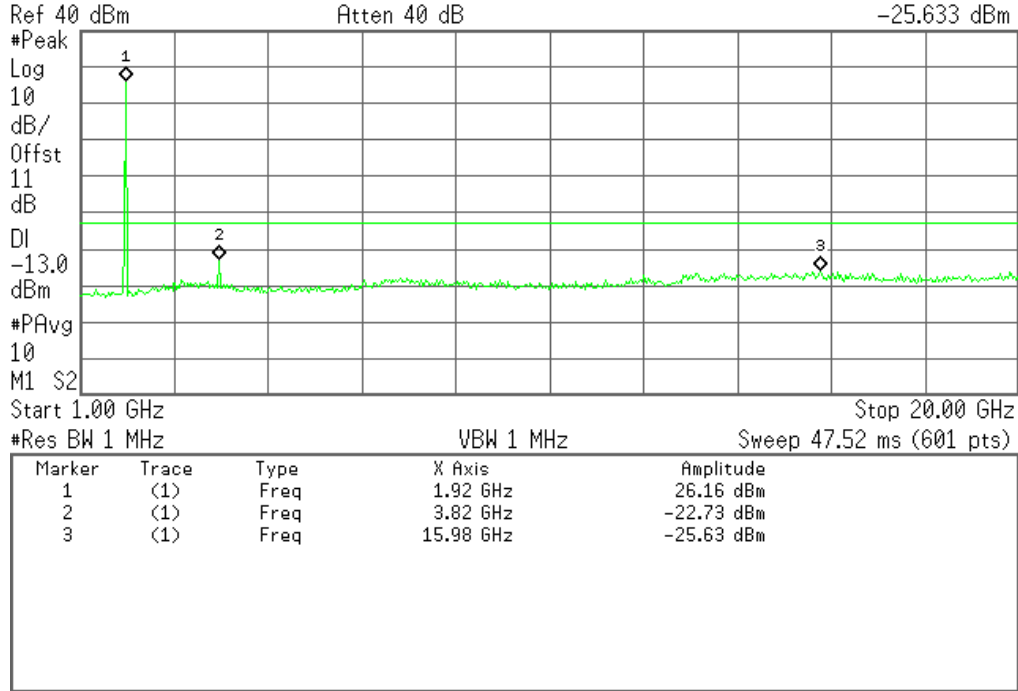

The strong emission shown is the carrier signal.

7 Block Edge Compliance

FCC part 22H/24E

7.1 Test Procedure

The transmitter output was connected to a Rohde & Schwarz CMU200 Test Set in a call and configured to operate at maximum power. The block edge emissions were measured at the required operating frequencies in each band on the Spectrum Analyzer.

Test Setup

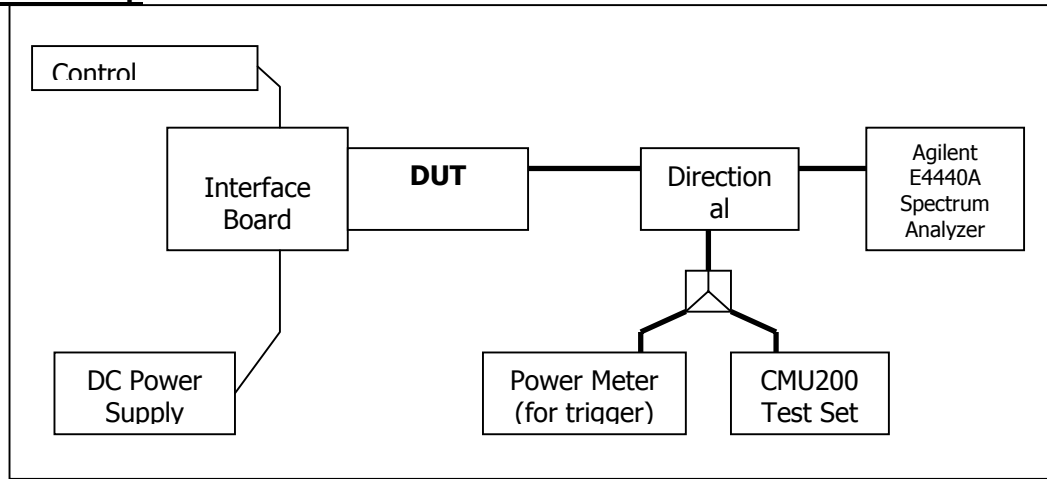

7.2 Test Equipment

Instrument List

EQUIPMENT	MANUFACTURER	MODEL NO.	SERIAL NO.	CAL. DATE
Control Computer	TC	Generic PC	100488	N/A
Wireless Test Set	Rohde & Schwarz	CMU200	836766/030	N/A
Spectrum Analyzer	Agilent	PSA E4440A	US41421268	Sept. 29, 2004
DC Power Supply	HP	6632A	3530A	N/A
Interface Board	Shop built	Minnow	N/A	N/A
Directional Coupler	Mini-Circuits	ZA3PD-2	N/A	N/A

7.3 Test Results

Block Test	Frequency Boundaries (MHz)	Channels Tested	Corresponding Plots	Result
1	GMSK: Below 824 MHz, above 849 MHz	128, 251	7.4.1, 7.4.2	Complies
2	8PSK: Below 824 MHz, above 849 MHz	128, 251	7.4.3, 7.4.4	Complies
3	GMSK: Below 1850MHz, above 1910MHz	512, 810	7.4.5, 7.4.6	Complies
4	8PSK: Below 1850MHz, above 1910MHz	512, 810	7.4.7, 7.4.8	Complies
Block Test	Frequency Boundaries (MHz)	Channels Tested	Corresponding Plots	Result
1	WCDMA: Below 824MHz, above 849MHz	4132, 4233	7.4.9, 7.4.10	Complies
2	WCDMA: Below 1850MHz, above 1910MHz	9262, 9538	7.4.11, 7.4.12	Complies

7.4 Test Plots

Plot 7.4.1) GSMK; Cellular low channel, below 824 MHz

Agilent 16:44:10 Nov 7, 2005

L

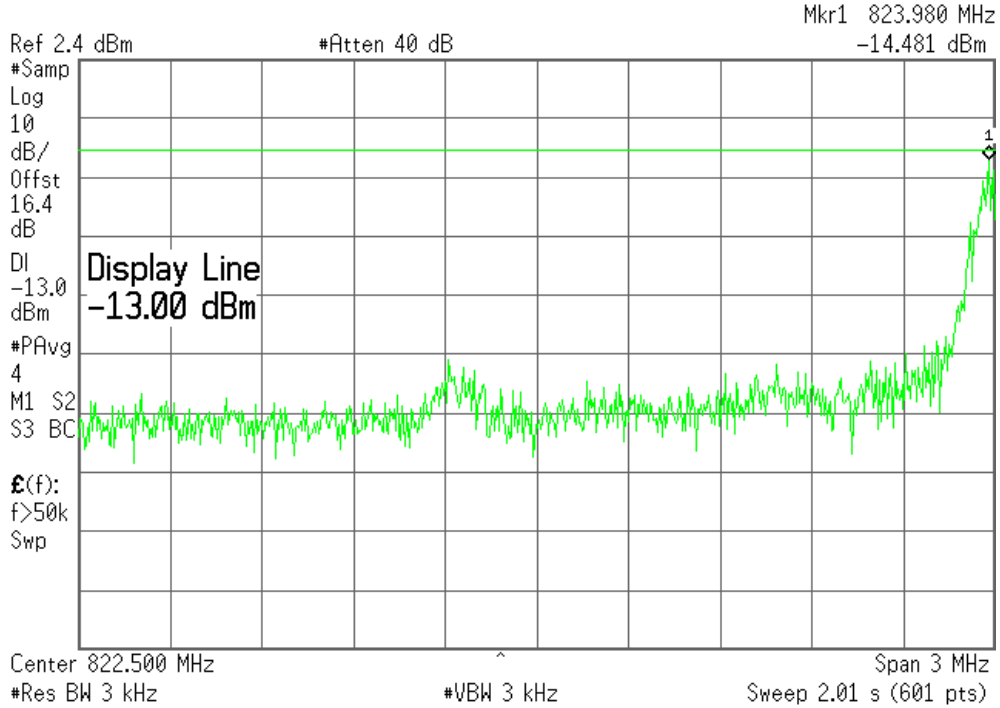

Plot 7.4.2) GSMK; Cellular high channel, above 849 MHz

Agilent 16:48:07 Nov 7, 2005

L

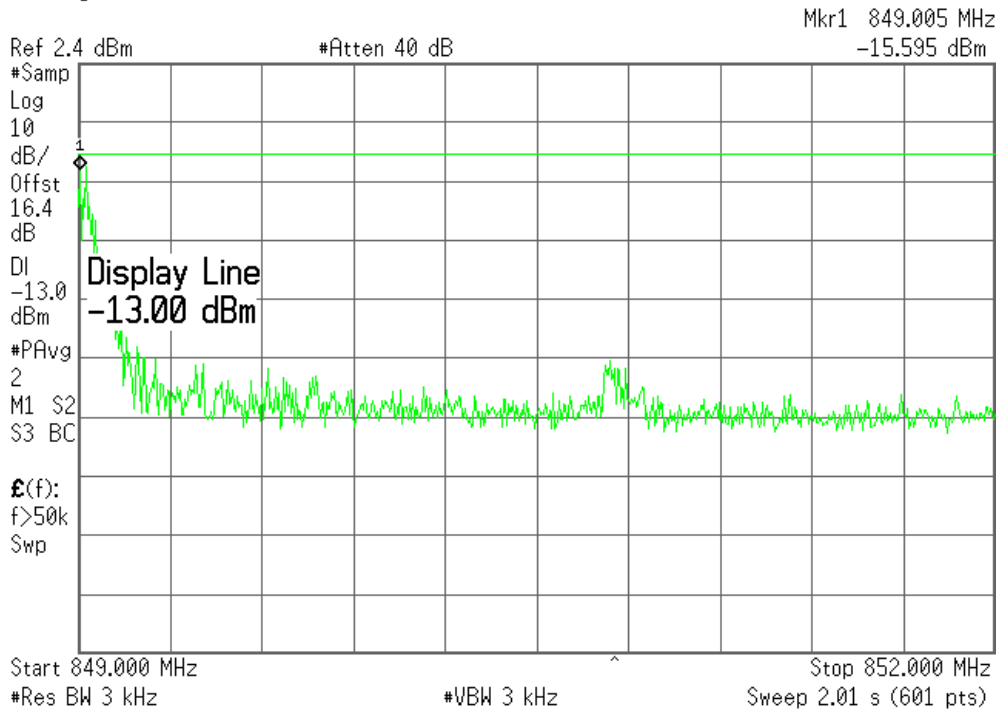

Plot 7.4.3) 8-PSK; Cellular low channel, below 824 MHz

* Agilent 16:52:46 Nov 7, 2005

L

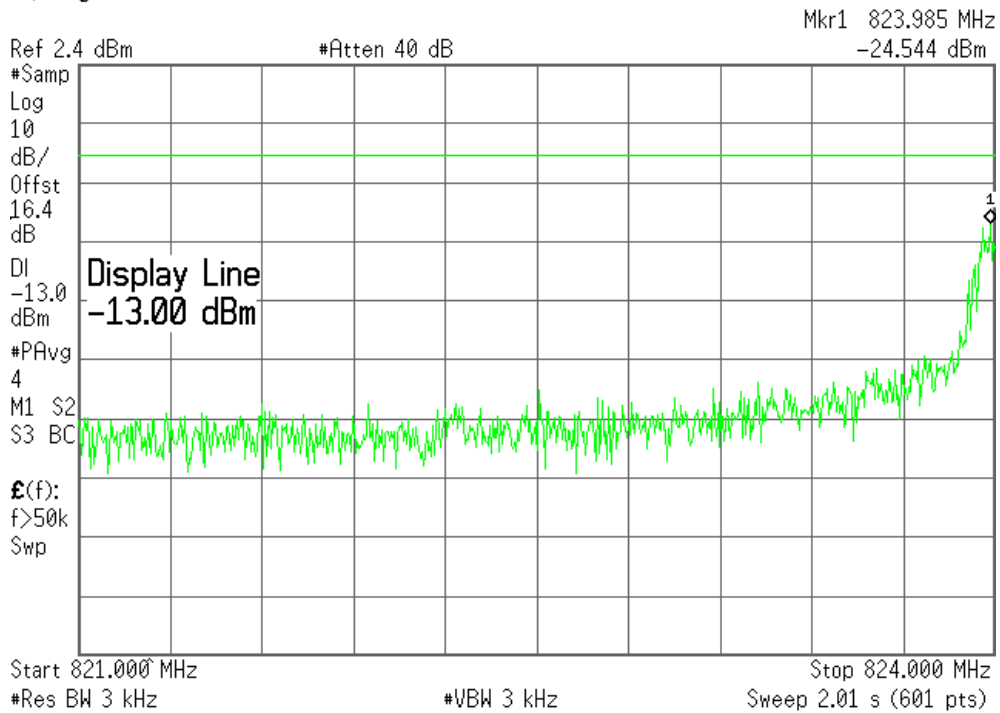

Plot 7.4.4) 8-PSK; Cellular high channel, above 849 MHz

* Agilent 16:50:35 Nov 7, 2005

L

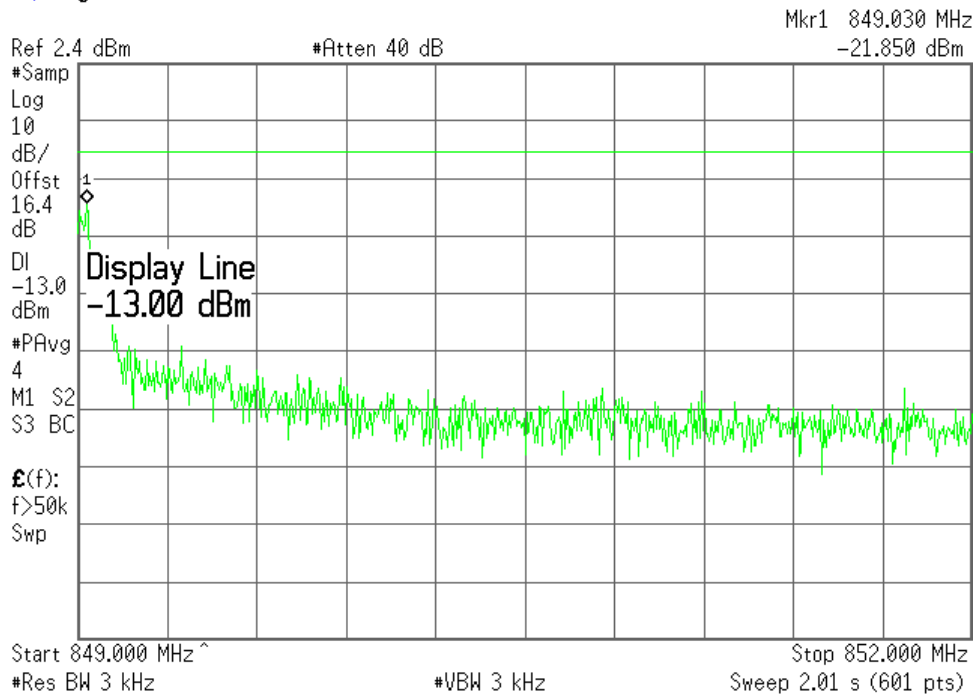

Plot 7.4.5) GMSK; PCS low channel, below 1850 MHz

Agilent 17:17:33 Nov 7, 2005

L

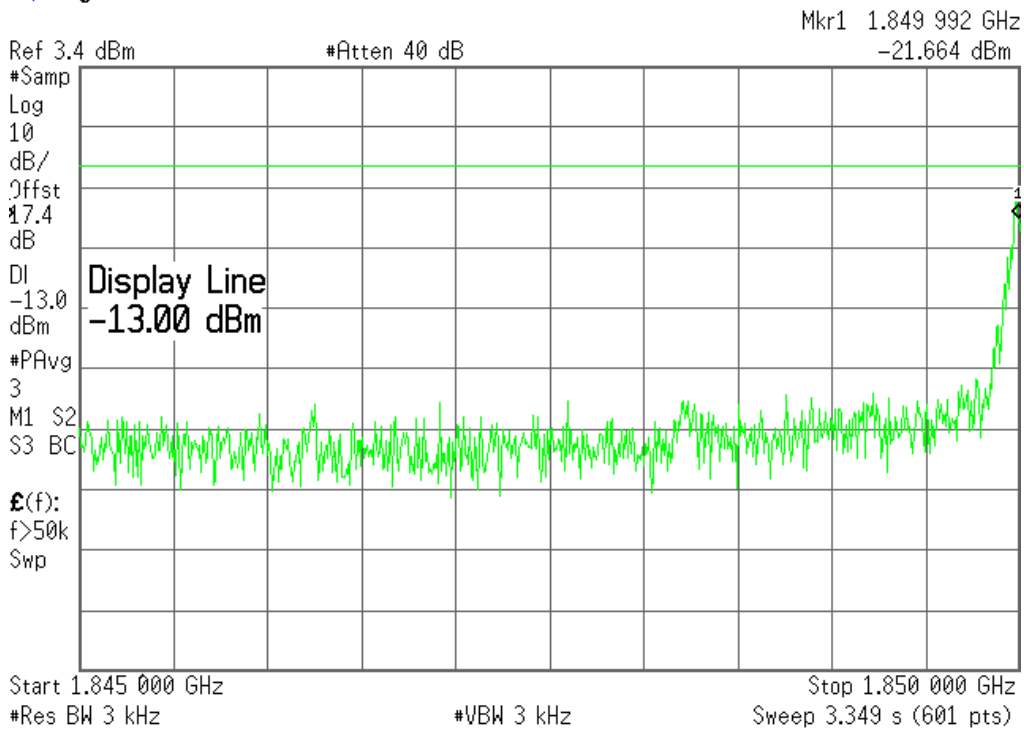

Plot 7.4.6) GMSK; PCS high channel, above 1910 MHz

Agilent 17:22:06 Nov 7, 2005

L

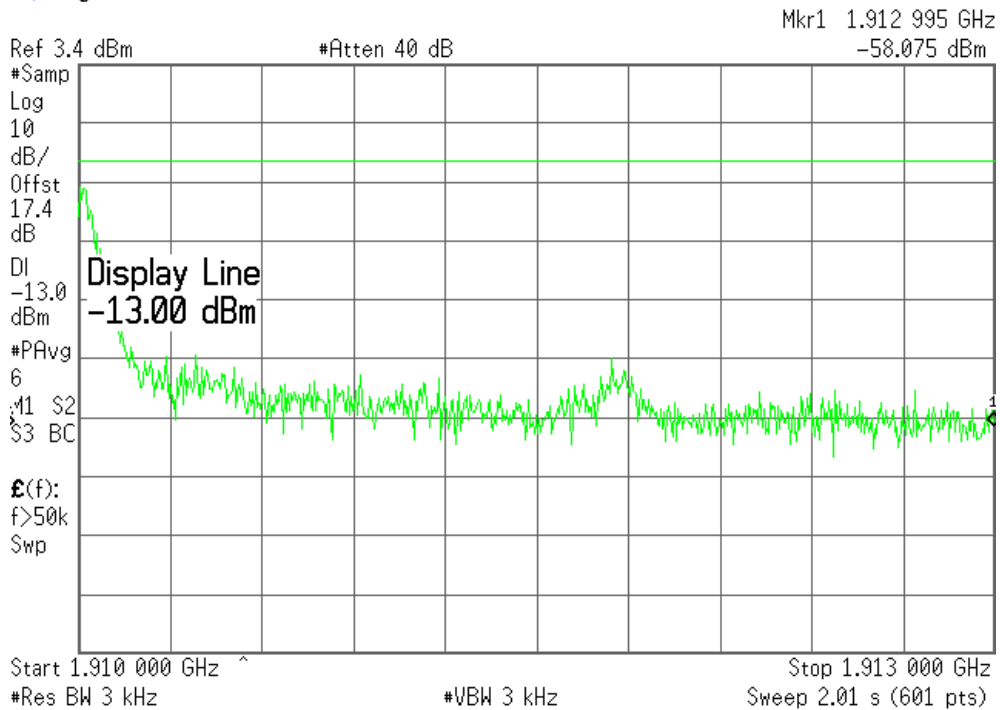

Plot 7.4.7) 8-PSK; PCS low channel, below 1850 MHz

Agilent 17:29:20 Nov 7, 2005

L

Mkr1 1.849 975 GHz
-24.478 dBm

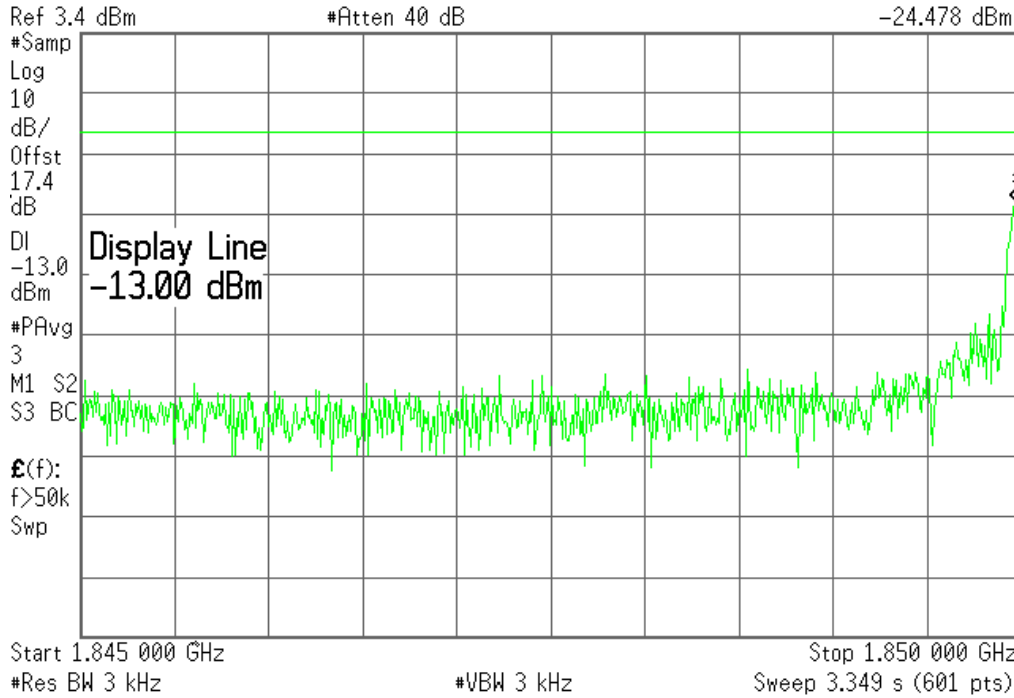

Plot 7.4.8) 8-PSK; PCS high channel, above 1910 MHz

Agilent 17:26:33 Nov 7, 2005

L

Mkr1 1.910 030 GHz
-21.040 dBm

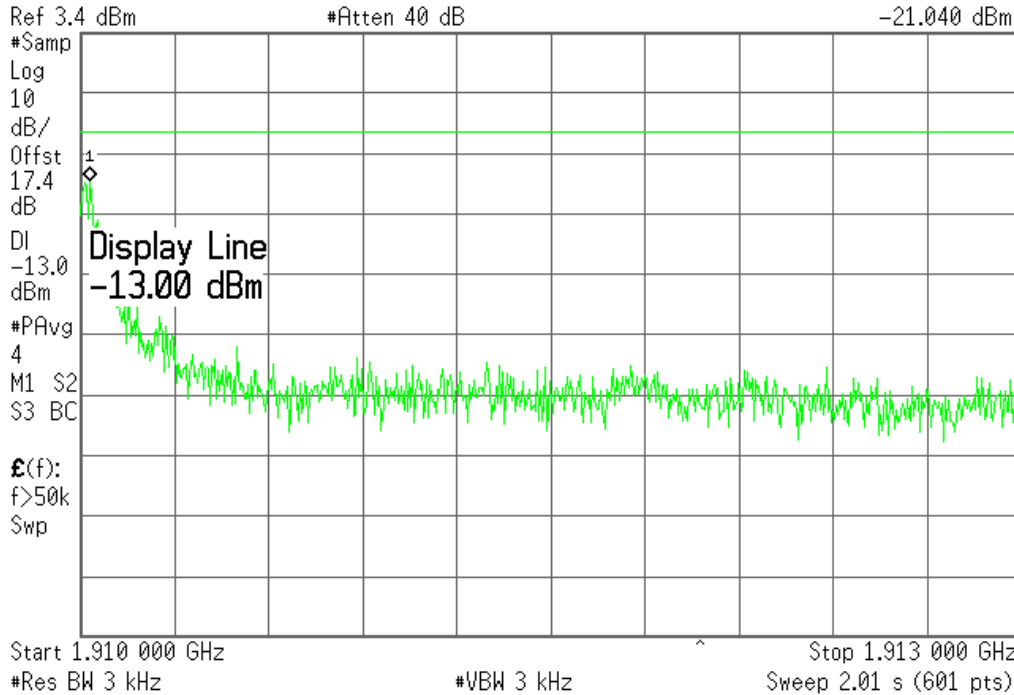

SIERRA WIRELESS, INC.

Plot 7.4.9) WCDMA; Cellular low channel, below 824 MHz

Agilent 09:19:37 Nov 8, 2005

L

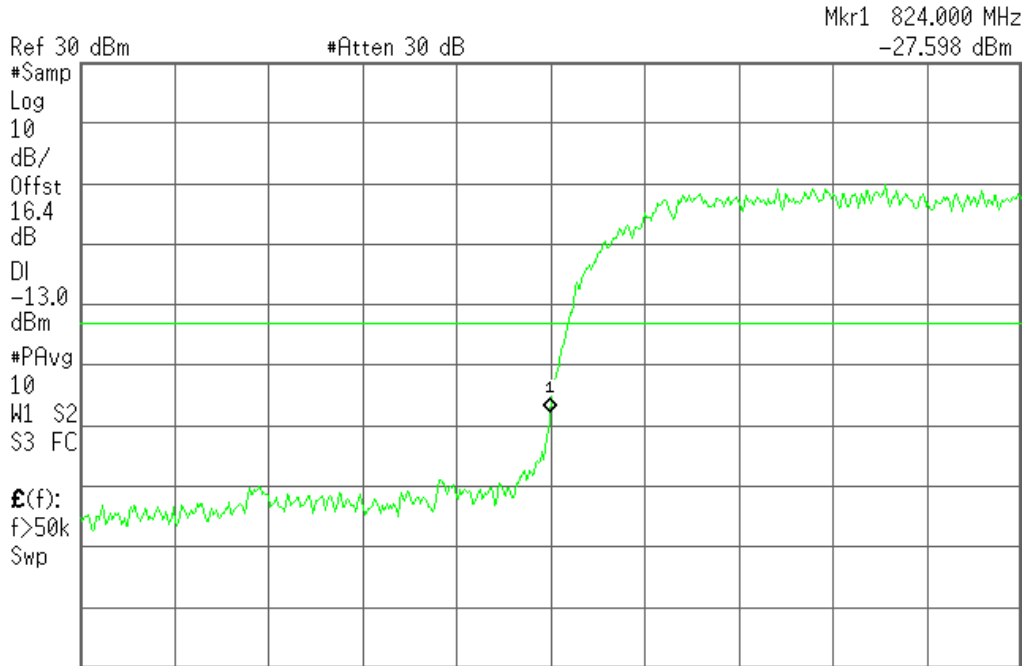

Mkr1 824.000 MHz
-27.598 dBm

Plot 7.4.10) WCDMA; Cellular high channel, above 849 MHz

Agilent 09:21:46 Nov 8, 2005

L

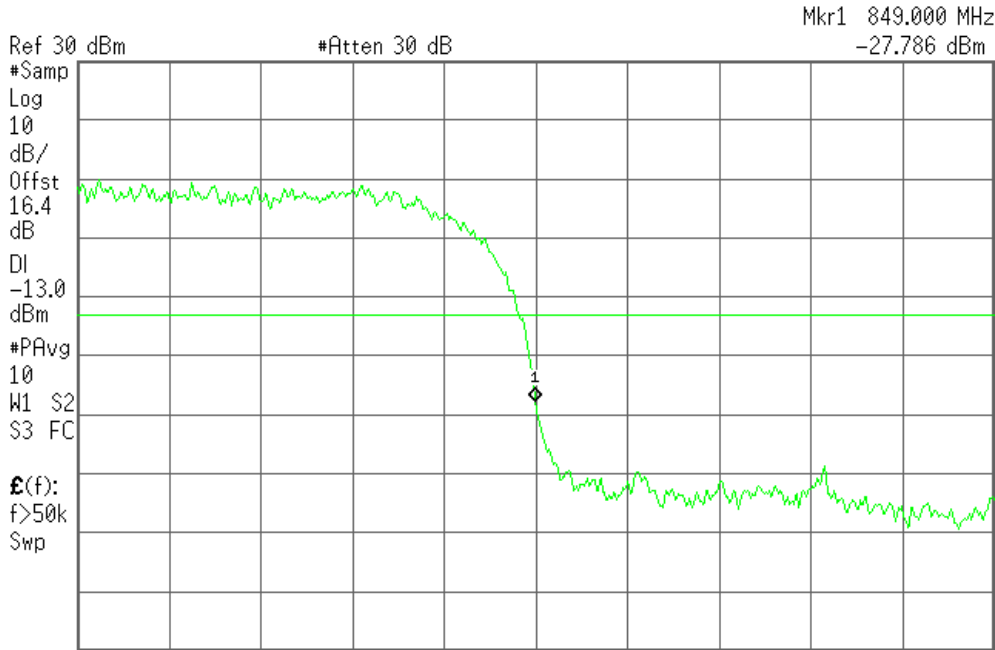

Mkr1 849.000 MHz
-27.786 dBm

Plot 7.4.11) WCDMA; PCS low channel, below 1850 MHz

Agilent 09:42:34 Nov 8, 2005

L

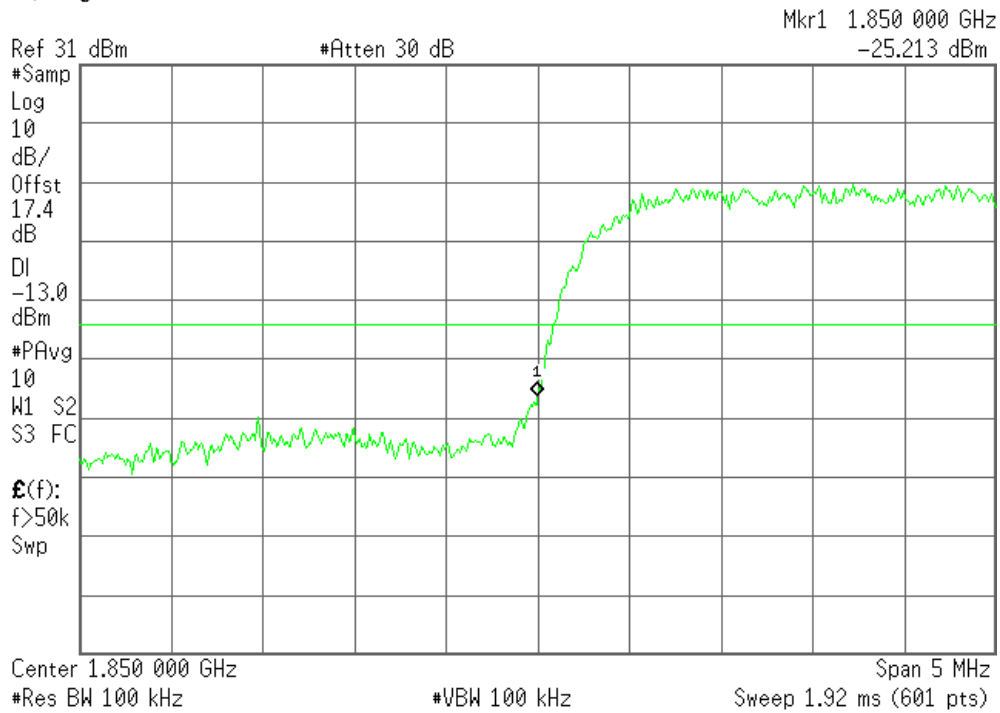

Plot 7.4.12) WCDMA; PCS high channel, above 1910 MHz

Agilent 09:45:30 Nov 8, 2005

L

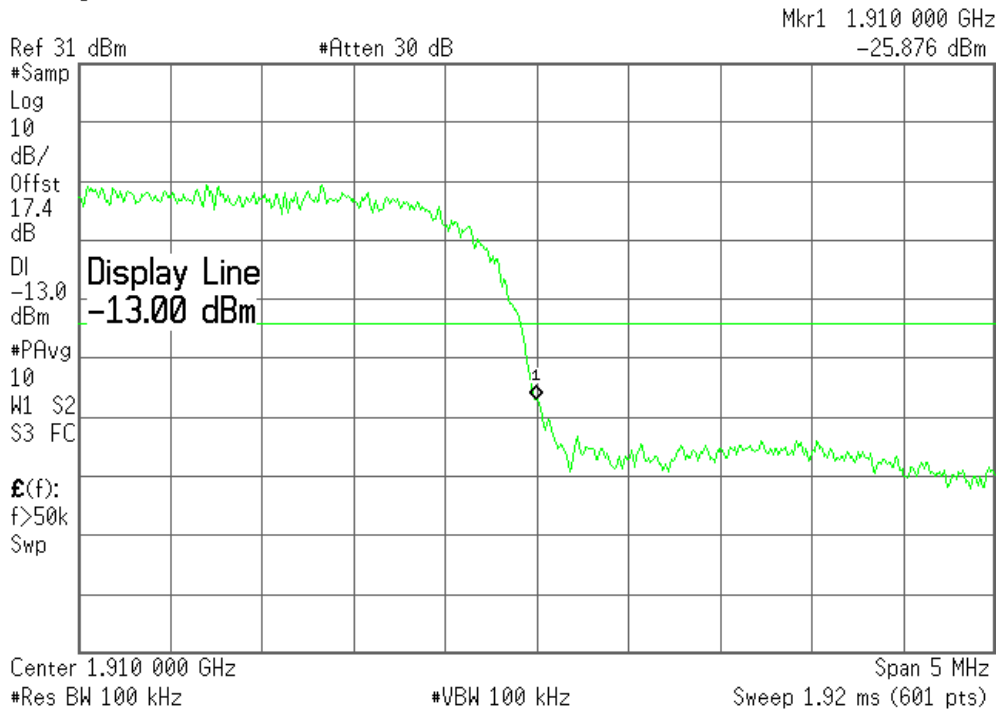

8 Frequency Stability Versus Temperature

FCC 2.1055

8.1 Summary of Results

The MC8765 Frequency Stability versus temperature meets the requirement of being within ± 0.1 ppm of the received base station frequency.

8.2 Test Procedure

The MC8765 was placed inside the temperature chamber. The transmitting frequency error is measured at 25 degrees C, then the temperature is set to +80 degrees C and allowed to stabilize. After sufficient soak time, the transmitting frequency offset is measured. The temperature is decreased by 10 degrees, allowed to stabilize and soak, then the measurement is repeated. This is repeated until -30 degrees C is completed. The process is then repeated back up to +80 degrees C. Frequency metering included internal averaging of the CMU200 to stabilize the reading. Reference power supply voltage for these tests is 3.3 volts.

Test Setup

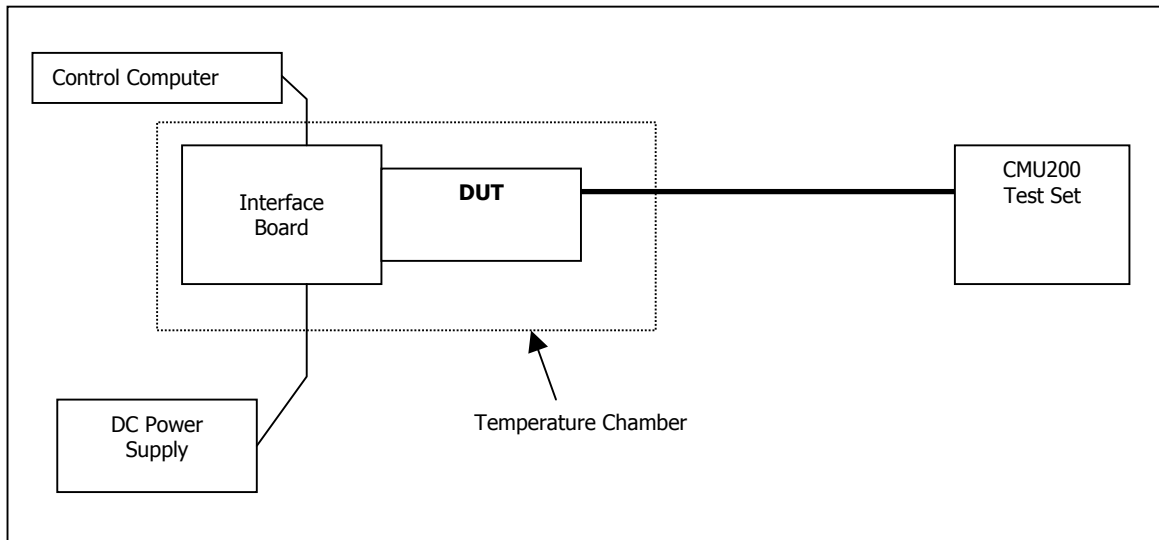

8.3 Test Equipment

EQUIPMENT	MANUFACTURER	MODEL NO.	SERIAL NO.	CAL. DATE
Control Computer	TC	Generic PC	100488	N/A
Wireless Test Set	Rohde & Schwarz	CMU200	836766/030	N/A
Spectrum Analyzer	Agilent	PSA E4440A	US41421268	Sept. 29, 2004
DC Power Supply	HP	6632A	3530A	N/A
Interface Board	Shop built	Minnow	N/A	N/A
Directional Coupler	Mini-Circuits	ZA3PD-2	N/A	N/A

SIERRA WIRELESS, INC.

8.4 Test Results

Low to High Temperature Frequency Offset: WCDMA Mode

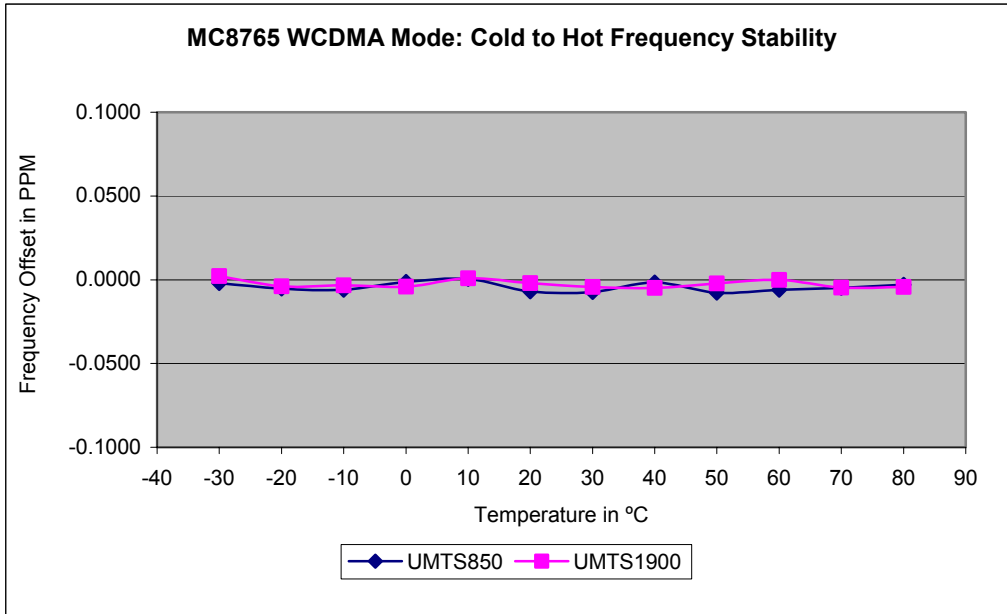

Low to High Temperature Tabular Readings: WCDMA Mode

Temp °C	WCDMA Mode - Band V - ULCH4182 (836.4 MHz)		WCDMA Mode - Band II - ULCH9400 (1880 MHz)	
	Hz	ppm	Hz	ppm
-30	-1.63	-0.0019	4.09	0.0022
-20	-4.39	-0.0052	-7.20	-0.0038
-10	-5.08	-0.0061	-6.12	-0.0033
0	-0.96	-0.0011	-7.87	-0.0042
10	0.40	0.0005	1.78	0.0009
20	-5.89	-0.0070	-3.95	-0.0021
30	-6.20	-0.0074	-8.18	-0.0044
40	-1.39	-0.0017	-9.19	-0.0049
50	-6.41	-0.0077	-4.06	-0.0022
60	-5.08	-0.0061	-0.20	-0.0001
70	-4.04	-0.0048	-8.70	-0.0046
80	-2.44	-0.0029	-8.04	-0.0043

SIERRA WIRELESS, INC.

Low to High Temperature Frequency Offset: GSM and 8PSK Modes

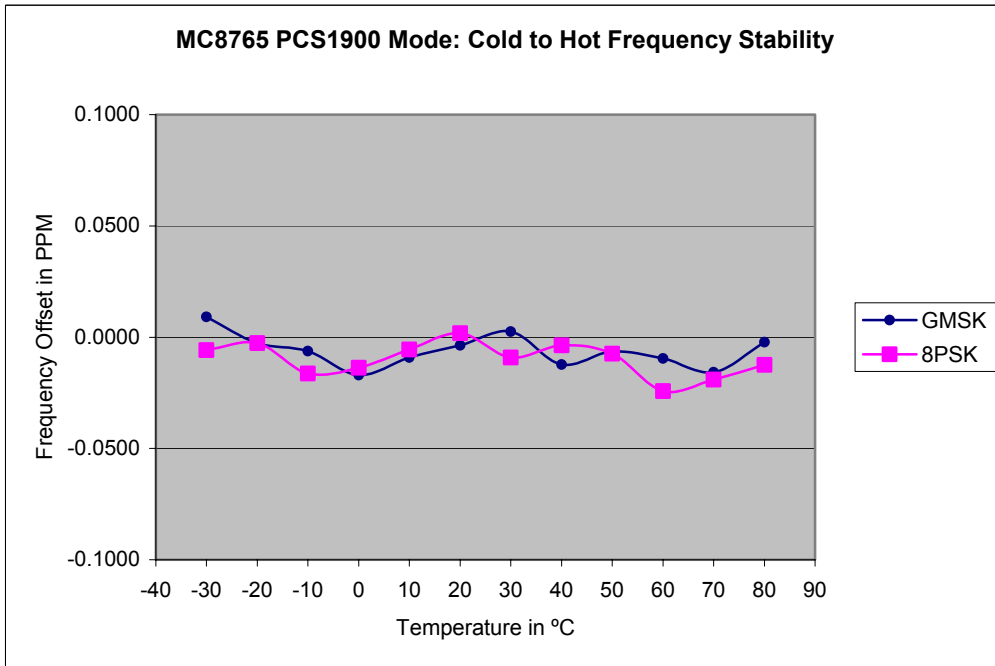
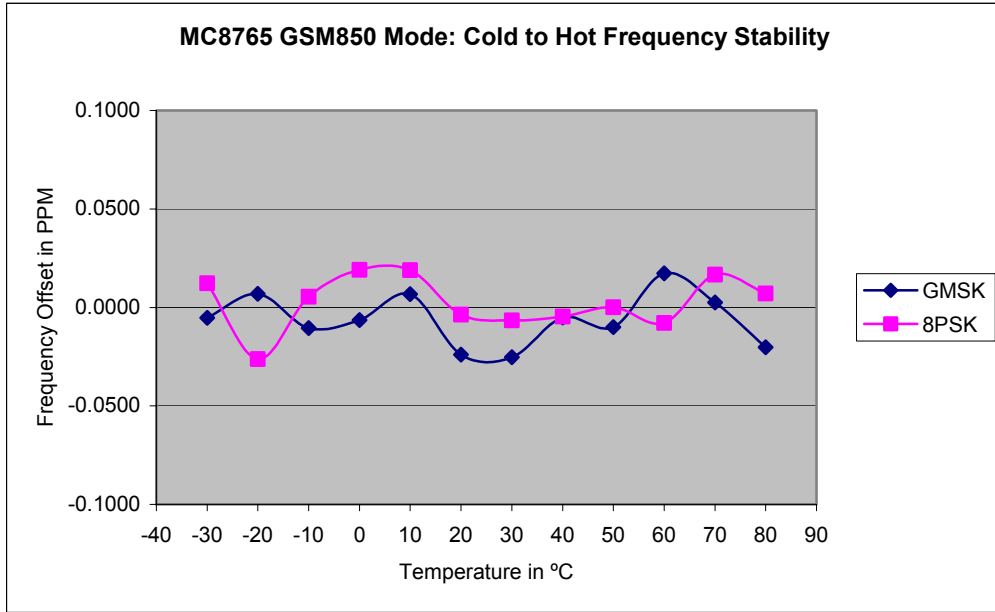

SIERRA WIRELESS, INC.

Low to High Temperature Tabular Readings: GSM and 8PSK Modes

Temp °C	Cellular Mode TCH192 (837 MHz)				PCS Mode TCH661(1880 MHz)			
	GMSK Mode		8-PSK Mode		GMSK Mode		8-PSK Mode	
	Hz	ppm	Hz	ppm	Hz	ppm	Hz	ppm
-30	-4.39	-0.0052	10.27	0.0123	17.24	0.0092	-10.88	-0.0058
-20	5.75	0.0069	-21.92	-0.0262	-5.04	-0.0027	-5.04	-0.0027
-10	-8.78	-0.0105	4.58	0.0055	-11.69	-0.0062	-30.74	-0.0164
0	-5.36	-0.0064	15.95	0.0191	-32.09	-0.0171	-25.73	-0.0137
10	5.68	0.0068	15.79	0.0189	-17.18	-0.0091	-10.49	-0.0056
20	-20.02	-0.0239	-3.00	-0.0036	-6.78	-0.0036	3.45	0.0018
30	-21.18	-0.0253	-5.46	-0.0065	4.71	0.0025	-17.24	-0.0092
40	-4.26	-0.0051	-3.94	-0.0047	-23.05	-0.0123	-6.91	-0.0037
50	-8.39	-0.0100	0.03	0.0000	-12.01	-0.0064	-13.88	-0.0074
60	14.53	0.0174	-6.55	-0.0078	-17.95	-0.0095	-45.62	-0.0243
70	2.13	0.0025	13.95	0.0167	-29.57	-0.0157	-35.93	-0.0191
80	-16.92	-0.0202	5.94	0.0071	-4.13	-0.0022	-23.31	-0.0124

SIERRA WIRELESS, INC.

High to Low Temperature Frequency Offset: WCDMA Mode

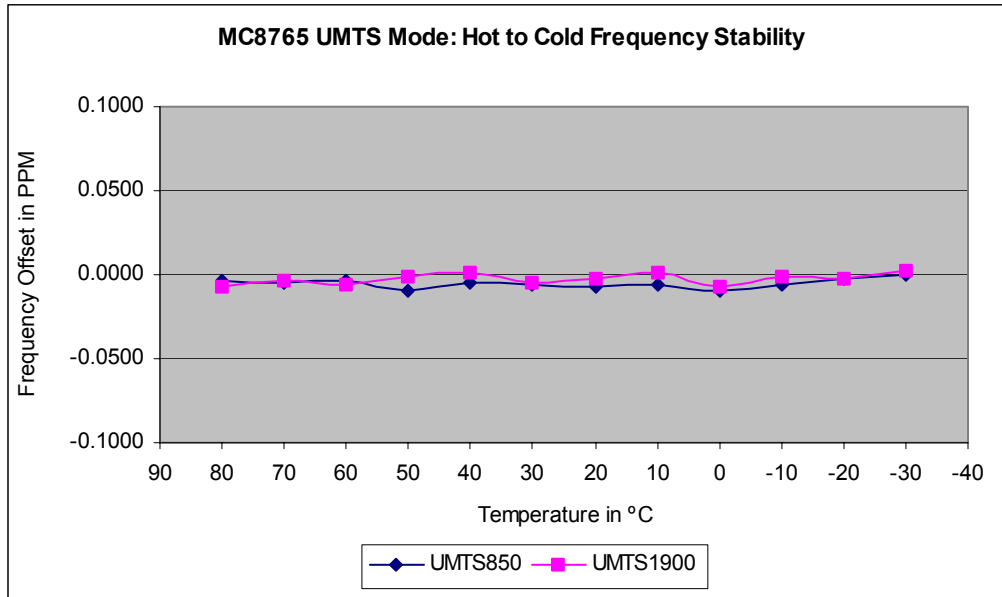

High to Low Temperature Tabular Readings: WCDMA Mode

Temp °C	WCDMA Mode - Band V - ULCH4182 (836.4 MHz)		WCDMA Mode - Band II - ULCH9400 (1880 MHz)	
	Hz	ppm	Hz	ppm
80	-3.04	-0.0036	-13.75	-0.0073
70	-4.03	-0.0048	-6.38	-0.0034
60	-3.13	-0.0037	-10.80	-0.0057
50	-7.92	-0.0095	-2.17	-0.0012
40	-3.80	-0.0045	1.71	0.0009
30	-5.16	-0.0062	-7.97	-0.0042
20	-5.69	-0.0068	-3.97	-0.0021
10	-5.48	-0.0065	1.16	0.0006
0	-7.64	-0.0091	-12.91	-0.0069
-10	-5.42	-0.0065	-1.71	-0.0009
-20	-1.89	-0.0023	-3.46	-0.0018
-30	-0.29	-0.0003	4.09	0.0022

SIERRA WIRELESS, INC.

High to Low Temperature Frequency Offset: GMSK and 8PSK Modes

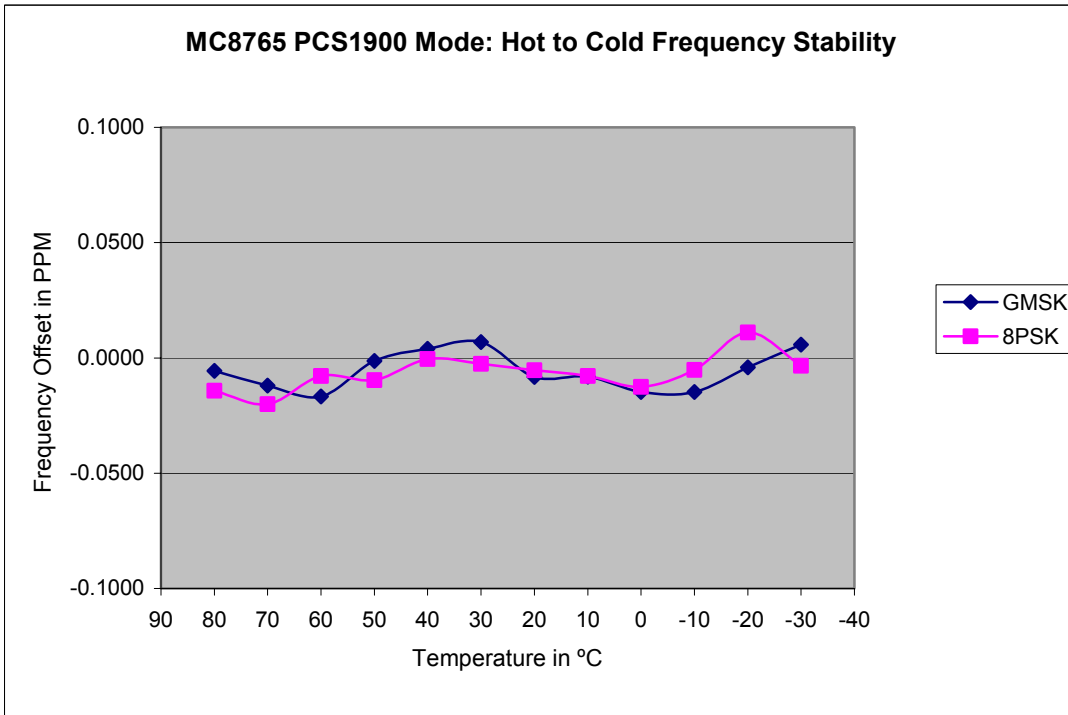
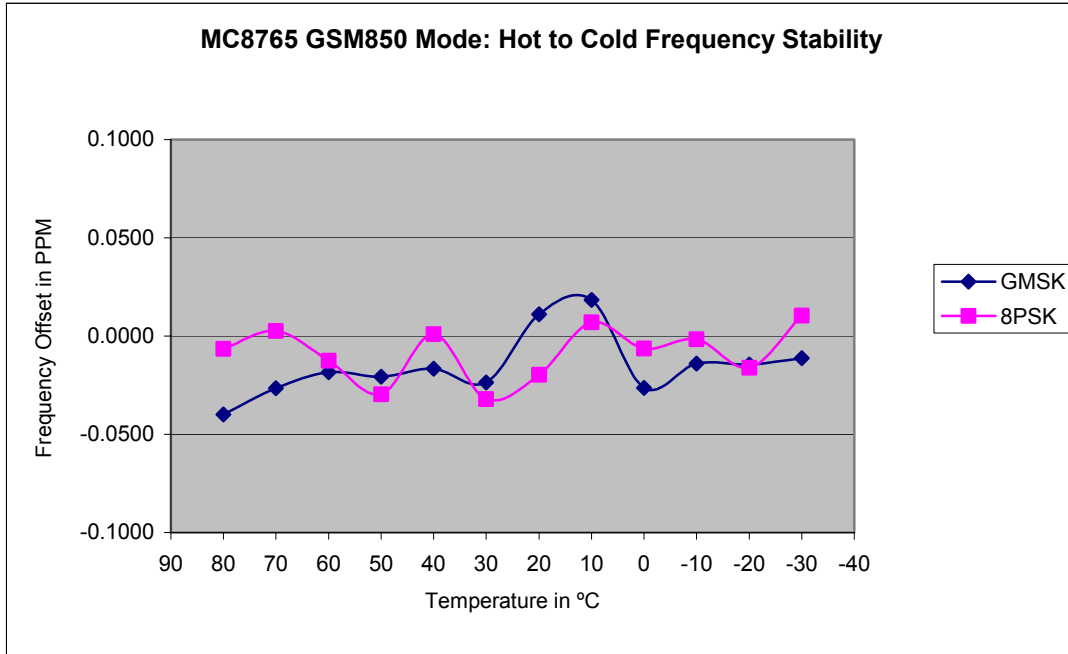

SIERRA WIRELESS, INC.

FCC Part 22 & 24 Test Report	MC8765	Nov. 9, 2005	Page 68 of 72
------------------------------	--------	--------------	---------------

High to Low Temperature Tabular Readings: GMSK and 8PSK Modes

Temp °C	Cellular Mode TCH192 (837 MHz)				PCS Mode TCH661(1880 MHz)			
	GMSK Mode		8-PSK Mode		GMSK Mode		8-PSK Mode	
	Hz	ppm	Hz	ppm	Hz	ppm	Hz	ppm
80	-33.45	-0.0400	-5.42	-0.0065	-10.53	-0.0056	-26.70	-0.0142
70	-22.28	-0.0266	2.20	0.0026	-22.66	-0.0121	-37.81	-0.0201
60	-15.43	-0.0184	-10.56	-0.0126	-31.45	-0.0167	-14.66	-0.0078
50	-17.31	-0.0207	-24.83	-0.0297	-2.45	-0.0013	-18.02	-0.0096
40	-13.95	-0.0167	0.81	0.0010	7.55	0.0040	-0.81	-0.0004
30	-19.76	-0.0236	-26.80	-0.0320	13.04	0.0069	-4.91	-0.0026
20	9.30	0.0111	-16.43	-0.0196	-15.43	-0.0082	-10.07	-0.0054
10	15.43	0.0184	5.88	0.0070	-15.17	-0.0081	-14.85	-0.0079
0	-22.02	-0.0263	-5.26	-0.0063	-27.89	-0.0148	-23.57	-0.0125
-10	-11.69	-0.0140	-1.39	-0.0017	-27.77	-0.0148	-9.88	-0.0053
-20	-12.14	-0.0145	-13.50	-0.0161	-7.75	-0.0041	20.79	0.0111
-30	-9.43	-0.0113	8.78	0.0105	10.91	0.0058	-6.30	-0.0034

9 Frequency Stability Versus Voltage

FCC 2.1055

9.1 Summary of Results

The unit meets the limit of less than 0.1ppm of frequency offset from center for 85% and 115% of the supply voltage for 3.3 volts.

9.2 Test Procedure

The MC8765 was connected to a DC Power Supply and a GSM test set (CMU 200) with frequency error measurement capability. The power supply output is adjusted to the test voltage as measured at the input terminals to the module while transmitting. A voltmeter was used to confirm the terminal voltage. The peak frequency offset is recorded (worst case).

The test voltages are 2.805 volts to 3.795 volts.

Test Setup

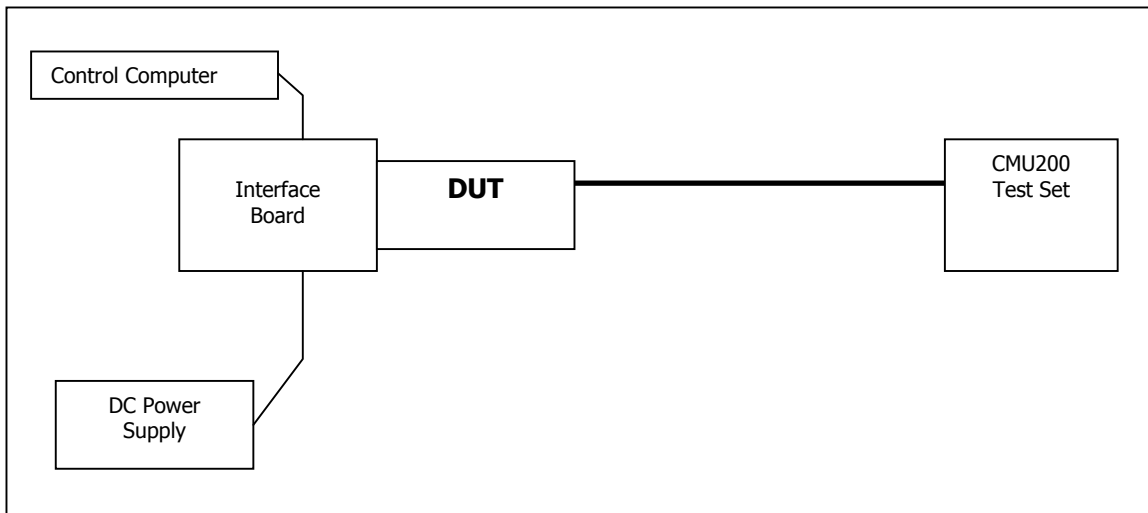

9.3 Test Equipment

EQUIPMENT	MANUFACTURER	MODEL NO.	SERIAL NO.	CAL. DATE
Control Computer	TC	Generic PC	100488	N/A
Wireless Test Set	Rohde & Schwarz	CMU200	836766/030	N/A
Spectrum Analyzer	Agilent	PSA E4440A	US41421268	Sept. 29, 2004
DC Power Supply	HP	6632A	3530A	N/A
Interface Board	Shop built	Minnow	N/A	N/A
Directional Coupler	Mini-Circuits	ZA3PD-2	N/A	N/A

SIERRA WIRELESS, INC.

9.4 Test Results

WCDMA Mode 85% to 115% of 3.3 Volts Frequency Offset, Tabular Data

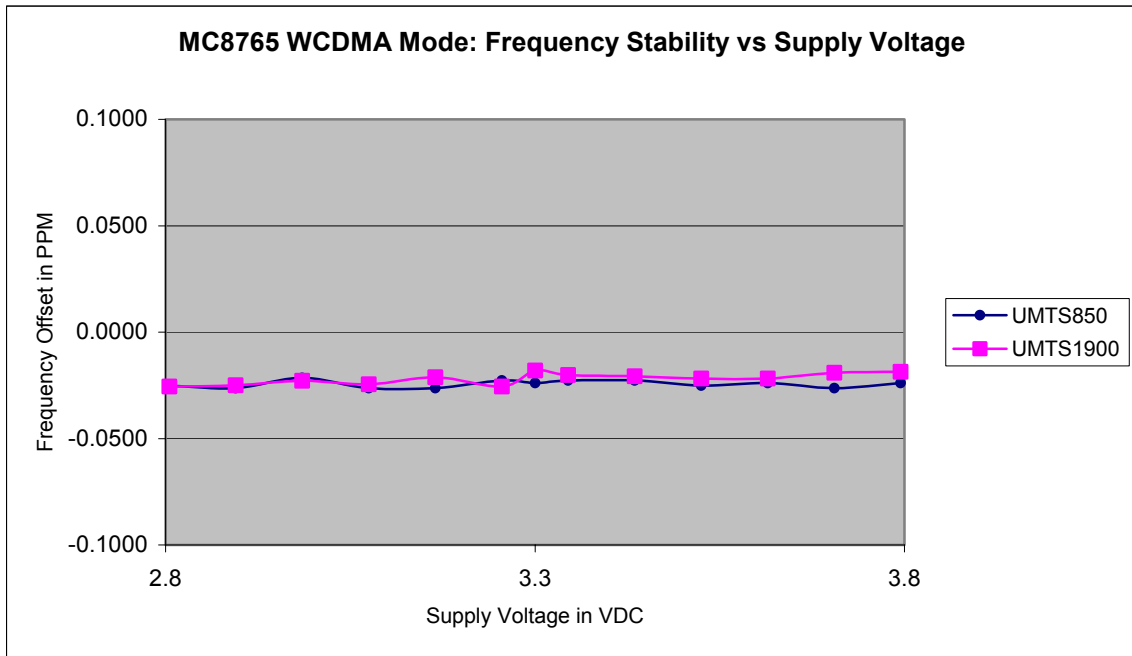

WCDMA Mode 85% to 115% of 3.3 Volts Frequency Offset, Tabular Data

Supply VDC	WCDMA Mode - Band V - ULCH4182 (836.4 MHz)		WCDMA Mode - Band II - ULCH 9400 (1880 MHz)	
	Peak Hz	ppm	Peak Hz	ppm
2.805	-21.00	-0.0251	-48.00	-0.0255
2.895	-22.00	-0.0263	-47.00	-0.0250
2.985	-18.00	-0.0215	-43.00	-0.0229
3.075	-22.00	-0.0263	-46.00	-0.0245
3.165	-22.00	-0.0263	-40.00	-0.0213
3.255	-19.00	-0.0227	-48.00	-0.0255
3.300	-20.00	-0.0239	-34.00	-0.0181
3.345	-19.00	-0.0227	-38.00	-0.0202
3.435	-19.00	-0.0227	-39.00	-0.0207
3.525	-21.00	-0.0251	-41.00	-0.0218
3.615	-20.00	-0.0239	-41.00	-0.0218
3.705	-22.00	-0.0263	-36.00	-0.0191
3.795	-20.00	-0.0239	-35.00	-0.0186

SIERRA WIRELESS, INC.

GMSK and 8PSK Modes 85% to 115% of 3.3 Volts Frequency Offset

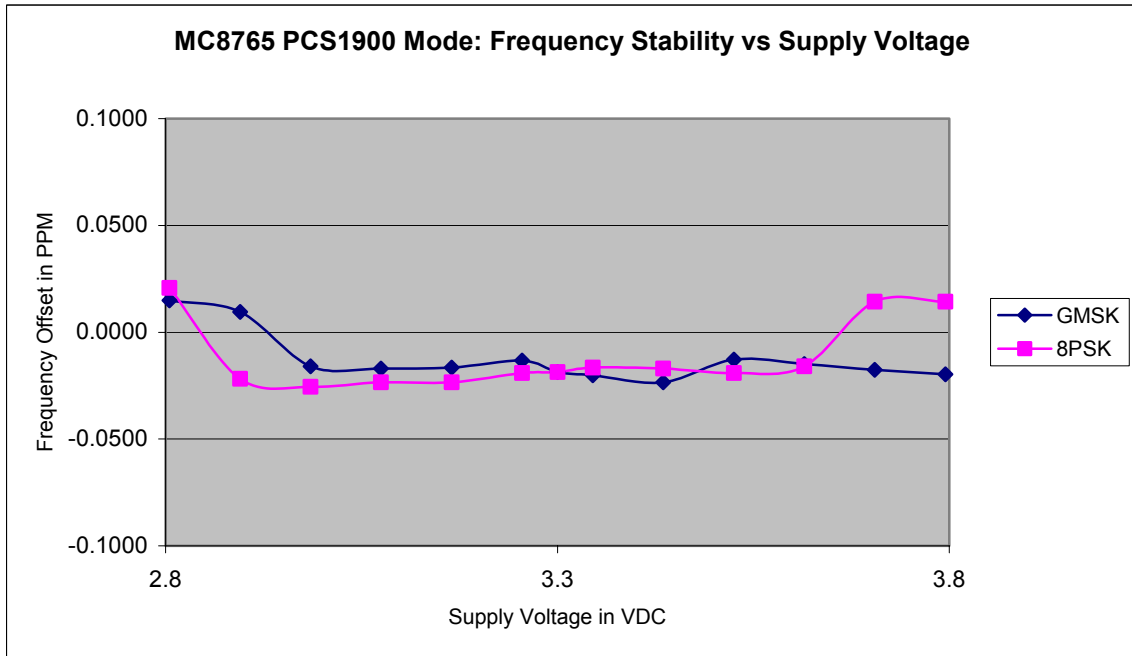
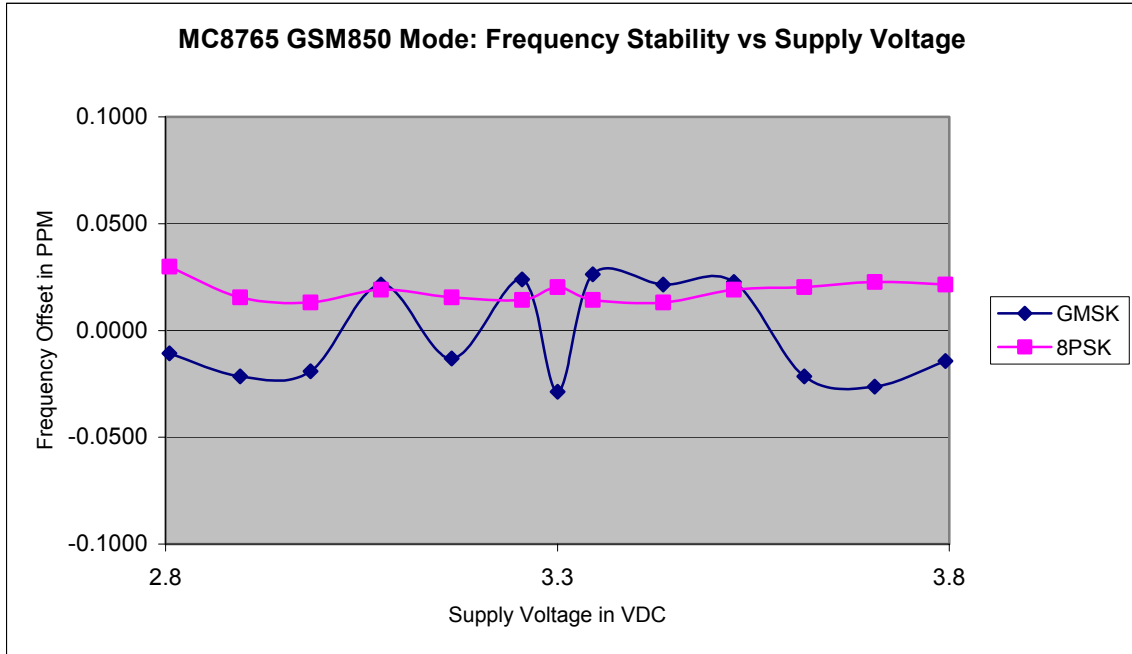

SIERRA WIRELESS, INC.

GMSK and 8PSK Modes 85% to 115% of 3.3 Volts Frequency Offset, Tabular Data

Supply VDC	Cellular Mode TCH192 (837 MHz)				PCS Mode TCH661(1880 MHz)			
	GMSK Mode		8-PSK Mode		GMSK Mode		8-PSK Mode	
	Peak Hz	ppm	Peak Hz	ppm	Peak Hz	ppm	Peak Hz	ppm
2.805	-9.00	-0.0108	25.00	0.0299	28.00	0.0149	39.00	0.0207
2.895	-18.00	-0.0215	13.00	0.0155	18.00	0.0096	-41.00	-0.0218
2.985	-16.00	-0.0191	11.00	0.0131	-30.00	-0.0160	-48.00	-0.0255
3.075	18.00	0.0215	16.00	0.0191	-32.00	-0.0170	-44.00	-0.0234
3.165	-11.00	-0.0131	13.00	0.0155	-31.00	-0.0165	-44.00	-0.0234
3.255	20.00	0.0239	12.00	0.0143	-25.00	-0.0133	-36.00	-0.0191
3.300	-24.00	-0.0287	17.00	0.0203	-35.00	-0.0186	-35.00	-0.0186
3.345	22.00	0.0263	12.00	0.0143	-38.00	-0.0202	-31.00	-0.0165
3.435	18.00	0.0215	11.00	0.0131	-44.00	-0.0234	-32.00	-0.0170
3.525	19.00	0.0227	16.00	0.0191	-24.00	-0.0128	-36.00	-0.0191
3.615	-18.00	-0.0215	17.00	0.0203	-28.00	-0.0149	-30.00	-0.0160
3.705	-22.00	-0.0263	19.00	0.0227	-33.00	-0.0176	27.00	0.0144
3.795	-12.00	-0.0143	18.00	0.0215	-37.00	-0.0197	27.00	0.0144