

Channel 1:

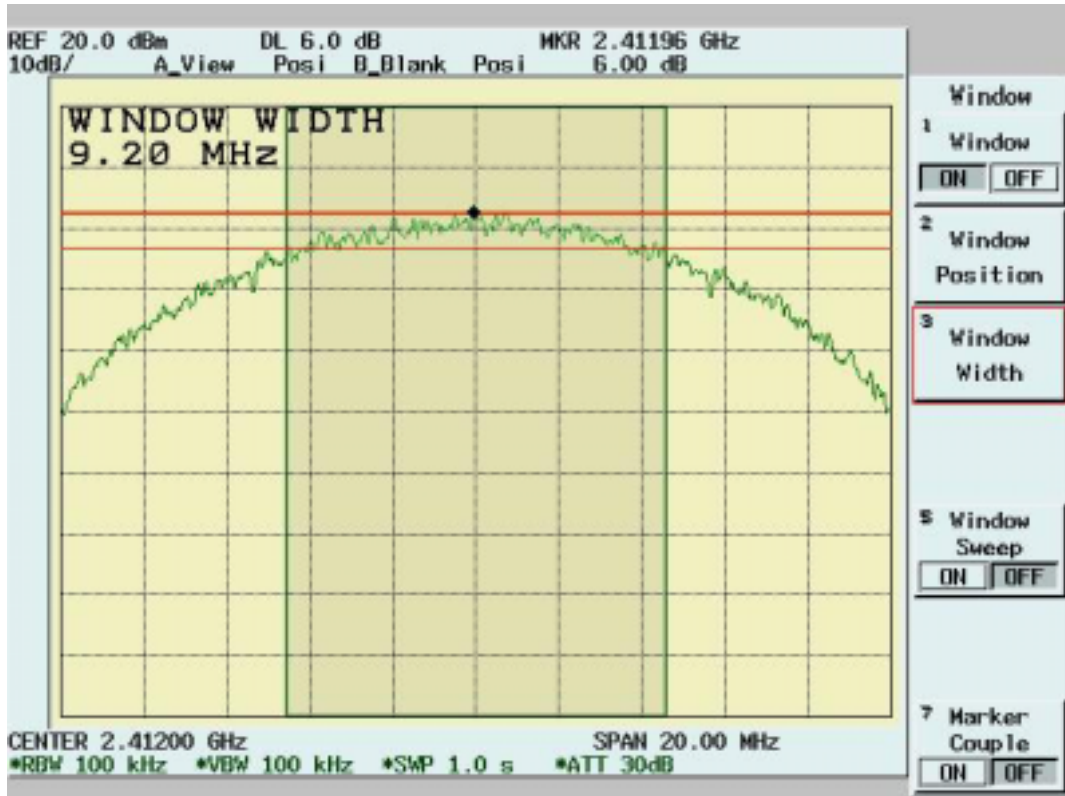

Channel 6:

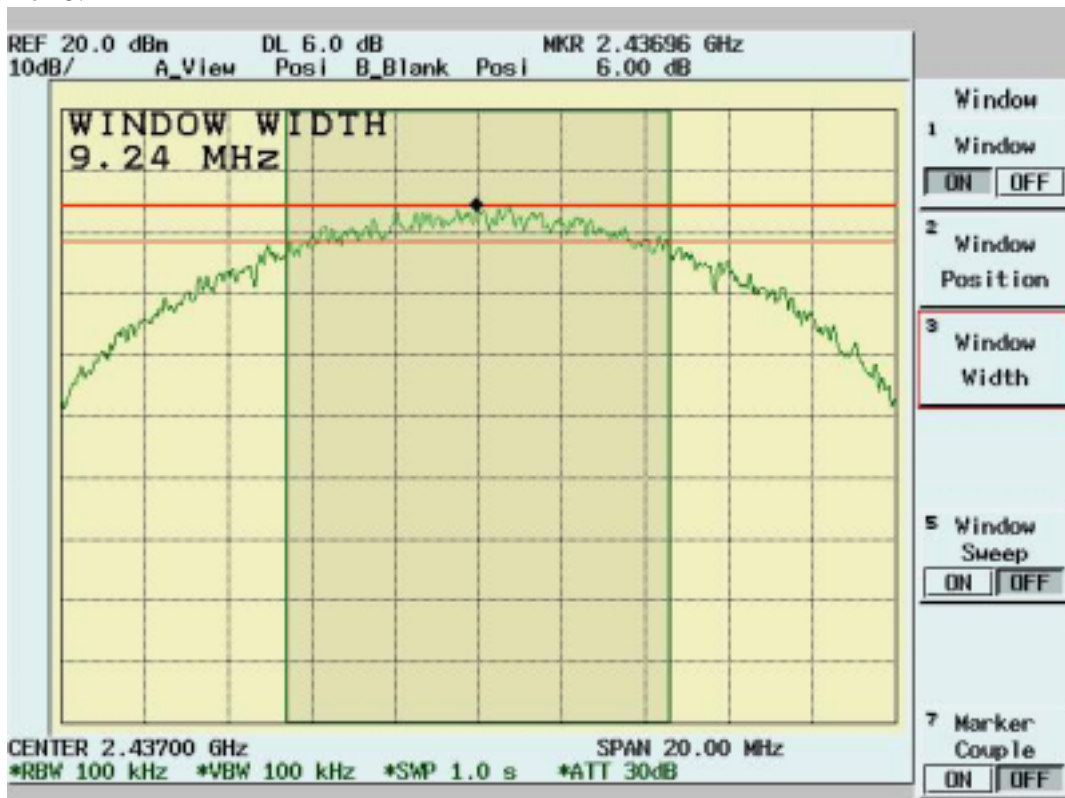

Channel 11:

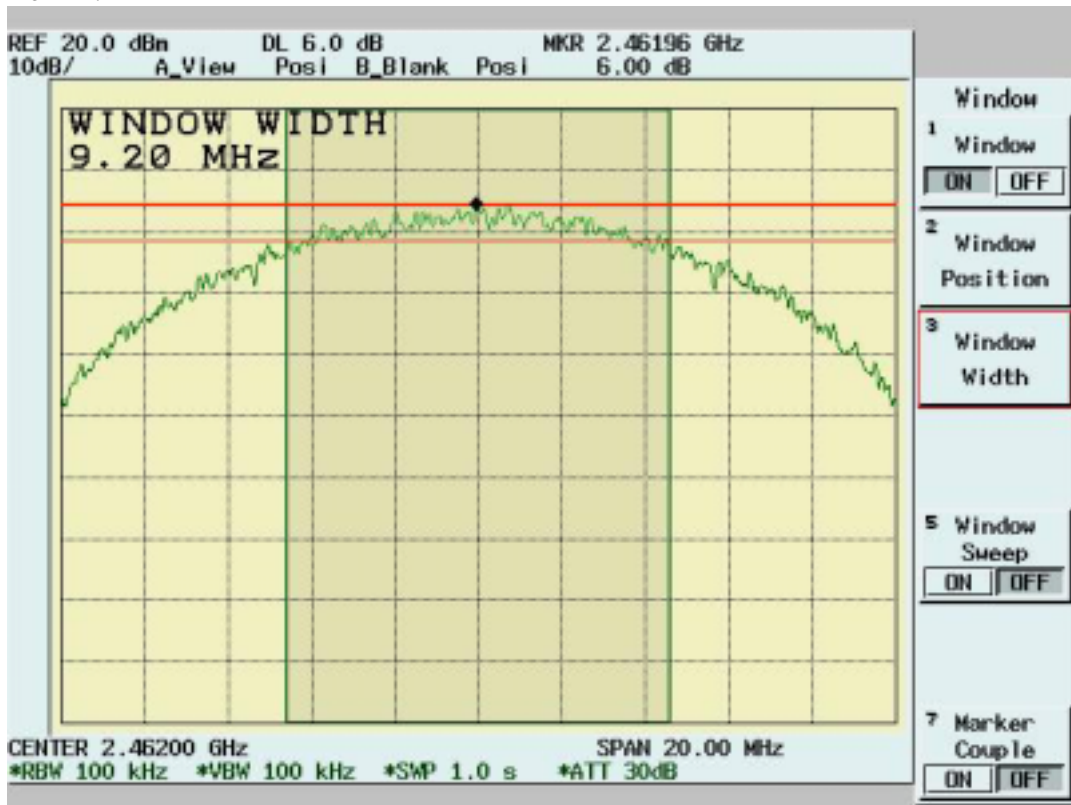

5.3 DSSS Maximum Peak Output Power [Section 15.247 (b)(1)]

5.3.1 Test Procedure

The Transmitter output of EUT was connected to the peak power analyzer.

5.3.2 Test Setup

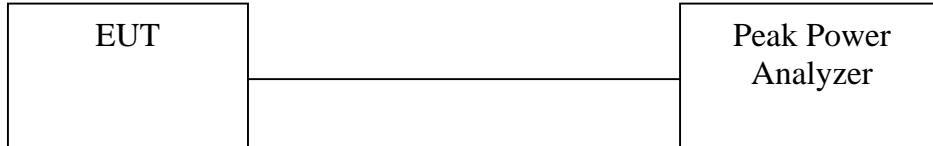

5.3.3 Test Data

Maximum Peak Output Power

Temperature ():24

Test Engineer:Mailes Hsieh

Humidity (%):54

Channel	Frequency (Mhz)	Analyzer Reading (dBm)	Cable Loss (dB)	Peak Power Output (mW)	Peak Power Output (dBm)	Limit (dBm)	Pass/Fail
1	2412	17.10	1.10	66.07	18.20	30	Pass
6	2437	18.24	1.10	85.90	19.34	30	Pass
11	2462	18.58	1.10	92.90	19.68	30	Pass

Note: Two RF output(MAIN & AUX) have been test,the worse data shown above.

5.4 Radiated Emission Measurement [Section [15.247(c)(4)]

5.4.1 EUT Configuration

The equipment under test was set up on the 10 meter chamber with measurement distance of 3 meters. The EUT was placed on a non-conductive table 80cm above ground.

Any changes made to the configuration, or modifications made to the EUT, during testing are noted in the following test record.

5.4.2 Test Procedure

The system was set up as described above, with the EMI diagnostic software running. We found the maximum readings by varying the height of antenna and then rotating the turntable. Both polarization of antenna, horizontal and vertical, are measured.

30M to 1GHz: The highest emissions between 30 MHz to 1000 MHz were also analyzed in details by operating the spectrum analyzer and/or EMI receiver in quasi-peak mode to determine the precise amplitude of the emissions. While doing so, the interconnecting cables and major parts of the system were moved around, the antenna height was varied between one and four meters, its polarization was varied between vertical and horizontal, and the turntable was slowly rotated, to maximize the emission.

1GHz – 25GHz: The highest emissions were also analyzed in details by operating the spectrum analyzer and/or EMI receiver in peak mode to determine the precise amplitude of the emission. While doing so, the interconnecting cables and major parts of the system were moved around, the antenna height was varied between one and four meters, its polarization was varied between vertical and horizontal, and the turntable was slowly rotated, to maximize the emission. During test the EMI receiver and spectrum was setup according to *EMI Receiver/Spectrum Analyzer Configuration*.

For the test of 2nd to 10th harmonics frequencies , the equipment setup was also refer to *EMI Receiver/Spectrum Analyzer Configuration*. The frequencies were tested using Peak mode first, if the test data is higher than the emissions limit, an additional measurement using Average mode will be performed and the average reading will be compared to the limit and record in test report.

5.4.3 EMI Receiver/Spectrum Analyzer Configuration (for the frequencies tested)

Frequency Range Tested:	30MHz~1000MHz
Detector Function:	Quasi-Peak Mode
Resolution Bandwidth (RBW):	120KHz
Video Bandwidth (VBW)	1MHz

Frequency Range Tested:	1GHz – 25 GHz
Detector Function:	Peak Mode
Resolution Bandwidth (RBW):	1MHz
Video Bandwidth (VBW)	3MHz

Frequency Range Tested:	1GHz – 25 GHz
Detector Function:	Average Mode
Resolution Bandwidth (RBW):	1MHz
Video Bandwidth (VBW)	10 Hz

5.4.4 Test Data (30MHz – 1GHz):

30M – 1GHz Open Field Radiated Emissions (Horizontal) Channel 1, 6, 11

Operator:MailesHsieh
 Temperature(C):24
 Humidity(%):47

Frequency	RxAmp.	AntFact	CableLoss	PreAmpGain	Corrct.Emi.	Limit	Margin	Ant.Pos.	TablePos
MHz	(dBuV)	(dB/m)	(dB)	(dB)	(dBuV/m)	(dBuV/m)	(dB)	(cm)	(deg)
231.76	23.23	9.21	2.95	0.00	35.39	46.00	-10.61	101.00	87.00
282.20	19.37	13.09	3.39	0.00	35.86	46.00	-10.14	101.00	54.00
306.45	18.27	13.69	3.68	0.00	35.64	46.00	-10.36	101.00	6.00
355.92	16.77	14.49	4.15	0.00	35.41	46.00	-10.59	101.00	349.00
364.65	21.14	14.77	4.20	0.00	40.11	46.00	-5.89	101.00	22.00
432.55	16.82	16.16	4.69	0.00	37.67	46.00	-8.33	101.00	22.00
629.46	7.07	18.96	6.15	0.00	32.18	46.00	-13.82	101.00	54.00
696.39	8.74	19.00	6.60	0.00	34.34	46.00	-11.66	101.00	333.00
766.23	3.98	20.10	7.07	0.00	31.15	46.00	-14.85	101.00	333.00
833.16	5.21	20.43	7.71	0.00	33.35	46.00	-12.65	101.00	22.00

30M – 1GHz Open Field Radiated Emissions (Vertical) Channel 1, 6, 11

Operator:MailesHsieh
 Temperature(C):24
 Humidity(%):47

Frequency	RxAmp.	AntFact	CableLoss	PreAmpGain	Corrct.Emi.	Limit	Margin	Ant.Pos.	TablePos
MHz	(dBuV)	(dB/m)	(dB)	(dB)	(dBuV/m)	(dBuV/m)	(dB)	(cm)	(deg)
282.20	17.24	13.09	3.39	0.00	33.72	46.00	-12.28	101.00	348.00
366.59	24.28	14.83	4.22	0.00	43.33	46.00	-2.67	101.00	84.00
432.55	20.41	16.16	4.69	0.00	41.26	46.00	-4.74	101.00	17.00
544.10	11.20	18.65	5.49	0.00	35.33	46.00	-10.67	101.00	299.00
566.41	10.32	18.83	5.65	0.00	34.81	46.00	-11.19	101.00	133.00
629.46	14.88	18.96	6.15	0.00	40.00	46.00	-6.00	101.00	348.00
686.69	10.55	19.00	6.53	0.00	36.08	46.00	-9.92	101.00	315.00
699.30	14.03	19.00	6.62	0.00	39.65	46.00	-6.35	101.00	315.00
715.79	8.05	19.35	6.76	0.00	34.16	46.00	-11.84	101.00	348.00
830.25	7.51	20.40	7.70	0.00	35.61	46.00	-10.39	101.00	315.00

NOTE:

- During the Pre-test, the EUT has been tested for Channel 1, 6, 11 transmit from Main and Aux antenna respectively to get all the critical emission frequencies. In the final test all the critical emission frequencies has been tested and the test data are listed above.
- Margin = Corrected Amplitude – Limit
 Corrected Amplitude = Radiated Amplitude + Antenna Correction Factor + Cable Loss - Pre-Amplifier Gain
 A margin of -8dB means that the emission is 8dB below the limit

All frequencies from 30MHz to 1GHz have been tested

5.4.5 Test Data (1GHz – 25 GHz) .

1GHz~ 25 GHz (Horizontal), Channel 1: 2412 MHz

Operator:MailesHsieh

RBW:1MHz
Humidity(%):47
Temperature(C):26

Frequency MHz	Rx_R. dBuV	Ant_F. dB/m	Cab_L. dB	PreAmpl dB	Emission dBuV/m	Limit dBuV/m	Margin dB	A.Tower cm	T.Table deg
1359.64	50.60pk	26.15	2.21	34.12	44.84pk	54.00av	-9.16	101	87
1399.60	51.81pk	26.34	2.22	34.15	46.22pk	54.00av	-7.78	101	84
2488.51	48.09pk	30.90	1.42	35.20	45.21pk	54.00av	-8.79	101	196
3357.64	49.42pk	31.39	1.64	35.53	46.91pk	54.00av	-7.09	103	265
6426.57	46.20pk	36.31	3.36	37.73	48.13pk	54.00av	-5.87	100	211

1GHz~ 25 GHz (Vertical), Channel 1: 2412 MHz

Operator:MailesHsieh

RBW:1MHz
Humidity(%):47
Temperature(C):26

Frequency MHz	Rx_R. dBuV	Ant_F. dB/m	Cab_L. dB	PreAmpl dB	Emission dBuV/m	Limit dBuV/m	Margin dB	A.Tower cm	T.Table deg
1064.94	54.80pk	24.80	2.18	33.97	47.81pk	54.00av	-6.19	102	108
1362.14	50.14pk	26.17	2.21	34.13	44.39pk	54.00av	-9.61	101	87
1841.66	49.18pk	29.67	2.48	34.87	46.46pk	54.00av	-7.54	100	54
2488.51	48.40pk	30.90	1.42	35.20	45.52pk	54.00av	-8.48	101	196
4872.01	47.51pk	35.55	2.17	37.89	47.33pk	54.00av	-6.67	100	1
6426.57	48.80pk	36.31	3.36	37.73	50.74pk	54.00av	-3.26	100	211

Note:

- According to the standards used, Where limits are specified by agencies for both average and peak (or quasi-peak) detection , if the peak (or quasi-peak) measured value complies with the average limit , it is unnecessary to perform an average measurement.
- “ * ”: Fundamental Frequency
- “***”: Not in the restricted band, Limit level=Fundamental Emission-20dB
- “ pk” : peak mode
- “av” : average mode
- “---“: No meter reading data due to the emission level is smaller than spectrum noise level.
- The Spectrum noise level+Correction Factor < Limit - 6 dB
- Margin=Corrected Amplitude – Limit
- Corrected Amplitude=Radiated Amplitude+Antenna Correction Factor+Cable Loss-Pre-Amplifier Gain
- A margin of -8dB means that the emission is 8dB below the limit.

All frequencies from 1GHz to 25 GHz have been tested.

1GHz~ 25 GHz (Horizontal) , Channel 6 : 2437 MHz

Operator:MailesHsieh

RBW:1MHz
Humidity(%):47
Temperature(C):26

Frequency MHz	Rx_R. dBuV	Ant_F. dB/m	Cab_L. dB	PreAmpl dB	Emission dBuV/m	Limit dBuV/m	Margin dB	A.Tower cm	T.Table deg
1064.94	52.23pk	24.80	2.18	33.97	45.24pk	54.00av	-8.76	102	108
1399.6	050.76pk	26.34	2.22	34.15	45.17pk	54.00av	-8.83	101	84
2488.51	47.45pk	30.90	1.42	35.20	44.57pk	54.00av	-9.43	101	196
3357.64	49.52pk	31.39	1.64	35.53	47.02pk	54.00av	-6.98	103	265
6493.01	49.39pk	36.39	3.40	37.68	51.50pk	54.00av	-2.50	100	199

1GHz~ 25 GHz (Vertical), Channel 6 : 2437 MHz

Operator:MailesHsieh

RBW:1MHz
Humidity(%):47
Temperature(C):26

Frequency MHz	Rx_R. dBuV	Ant_F. dB/m	Cab_L. dB	PreAmpl dB	Emission dBuV/m	Limit dBuV/m	Margin dB	A.Tower cm	T.Table deg
1329.67	50.63pk	26.02	2.21	34.11	44.74pk	54.00av	-9.26	101	89
1399.60	51.65pk	26.34	2.22	34.15	46.06pk	54.00av	-7.94	101	84
1841.66	49.84pk	29.67	2.48	34.87	47.13pk	54.00av	-6.87	100	54
2491.01	47.98pk	30.90	1.41	35.20	45.09pk	54.00av	-8.91	101	197
4972.03	46.78pk	35.49	2.16	37.88	46.56pk	54.00av	-7.44	100	3
6493.01	50.41pk	36.39	3.40	37.68	52.52pk	54.00av	-1.48	100	199

Note:

- According to the standards used, Where limits are specified by agencies for both average and peak (or quasi-peak) detection , if the peak (or quasi-peak) measured value complies with the average limit , it is unnecessary to perform an average measurement.
- “ * ”: Fundamental Frequency
- “***”: Not in the restricted band, Limit level=Fundamental Emission-20dB
- “ pk” : peak mode
- “ av” : average mode
- “ --- “: No meter reading data due to the emission level is smaller than spectrum noise level.
- The Spectrum noise level+Correction Factor < Limit - 6 dB
- Margin=Corrected Amplitude – Limit
- Corrected Amplitude=Radiated Amplitude+Antenna Correction Factor+Cable Loss-Pre-Amplifier Gain
- A margin of -8dB means that the emission is 8dB below the limit.

All frequencies from 1GHz to 25 GHz have been tested.

1GHz~ 25 GHz (Horizontal), Channel 11: 2462 MHz

Operator:MailesHsieh

RBW:1MHz
Humidity(%):47
Temperature(C):26

Frequency MHz	Rx_R. dBuV	Ant_F. dB/m	Cab_L. dB	PreAmpl dB	Emission dBuV/m	Limit dBuV/m	Margin dB	A.Tower cm	T.Table deg
1397.10	50.01pk	26.33	2.22	34.14	44.41pk	54.00av	-9.59	101	85
1794.21	46.38pk	29.27	2.45	34.78	43.32pk	54.00av	-10.68	100	57
2496.00	48.18pk	30.90	1.38	35.20	45.26pk	54.00av	-8.74	101	199
3357.64	49.24pk	31.39	1.64	35.53	46.73pk	54.00av	-7.27	103	265
6562.94	46.20pk	36.74	3.36	37.62	48.69pk	54.00av	-5.31	101	187

1GHz~ 25 GHz (Vertical), Channel 11 : 2462 MHz

Operator:MailesHsieh

RBW:1MHz
Humidity(%):47
Temperature(C):26

Frequency MHz	Rx_R. dBuV	Ant_F. dB/m	Cab_L. dB	PreAmpl dB	Emission dBuV/m	Limit dBuV/m	Margin dB	A.Tower cm	T.Table deg
1062.44	52.77pk	24.79	2.18	33.96	45.77pk	54.00av	-8.23	102	108
1399.60	52.01pk	26.34	2.22	34.15	46.42pk	54.00av	-7.58	101	84
1841.66	48.97pk	29.67	2.48	34.87	46.25pk	54.00av	-7.75	100	54
2491.01	48.91pk	30.90	1.41	35.20	46.02pk	54.00av	-7.98	101	197
4989.51	46.77pk	35.56	2.17	37.90	46.59pk	54.00av	-7.41	100	1
6559.44	49.02pk	36.72	3.36	37.62	51.49pk	54.00av	-2.51	101	187

Note:

- According to the standards used, Where limits are specified by agencies for both average and peak (or quasi-peak) detection , if the peak (or quasi-peak) measured value complies with the average limit , it is unnecessary to perform an average measurement.
- “ * ”: Fundamental Frequency
- “***”: Not in the restricted band, Limit level=Fundamental Emission-20dB
- “ pk” : peak mode
- “ av” : average mode
- “ --- “: No meter reading data due to the emission level is smaller than spectrum noise level.
- The Spectrum noise level+Correction Factor < Limit - 6 dB
- Margin=Corrected Amplitude – Limit
- Corrected Amplitude=Radiated Amplitude+Antenna Correction Factor+Cable Loss-Pre-Amplifier Gain
- A margin of -8dB means that the emission is 8dB below the limit.

All frequencies from 1GHz to 25 GHz have been tested.

5.5 Band Edge Measurement

5.5.1 Test Procedure (Conducted)

1. The transmitter output of EUT was connected to the spectrum analyzer.
 Equipment mode: Spectrum analyzer
 Detector function: Peak mode
 SPAN: 100MHz
 RBW: 100KHz
 VBW: 100KHz
 Center frequency: 2.4GHz, 2.4835GHz.
2. Using Peak Search to read the peak power of Carrier frequencies after Maximum Hold function is completed
3. Find the next peak frequency outside the operation frequency band

5.5.2 Test Setup (Conducted)

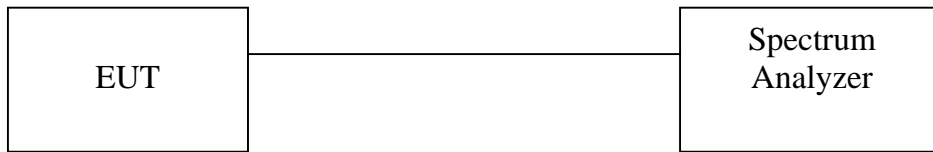

5.5.3 Test Data:

Table: Band Edge measurement (Conducted)

Temperature ():24

Test Engineer:Mailes Hsieh

Humidity (%):54

Channel	Frequency (MHz)	Spectrum Reading (dBuV)	Carrier - Outsideband Limit: >20dB (dB)	Pass/Fail
1	2411.9	108.52	---	---
Outside band	2399.0	74.63	33.89	Pass
11	2461.9	110.28	---	---
Outside band	2475.4	77.26	33.02	Pass

Note: Two RF output(MAIN & AUX) have been test,the worse data shown above.

Band Edge Conducted measurement

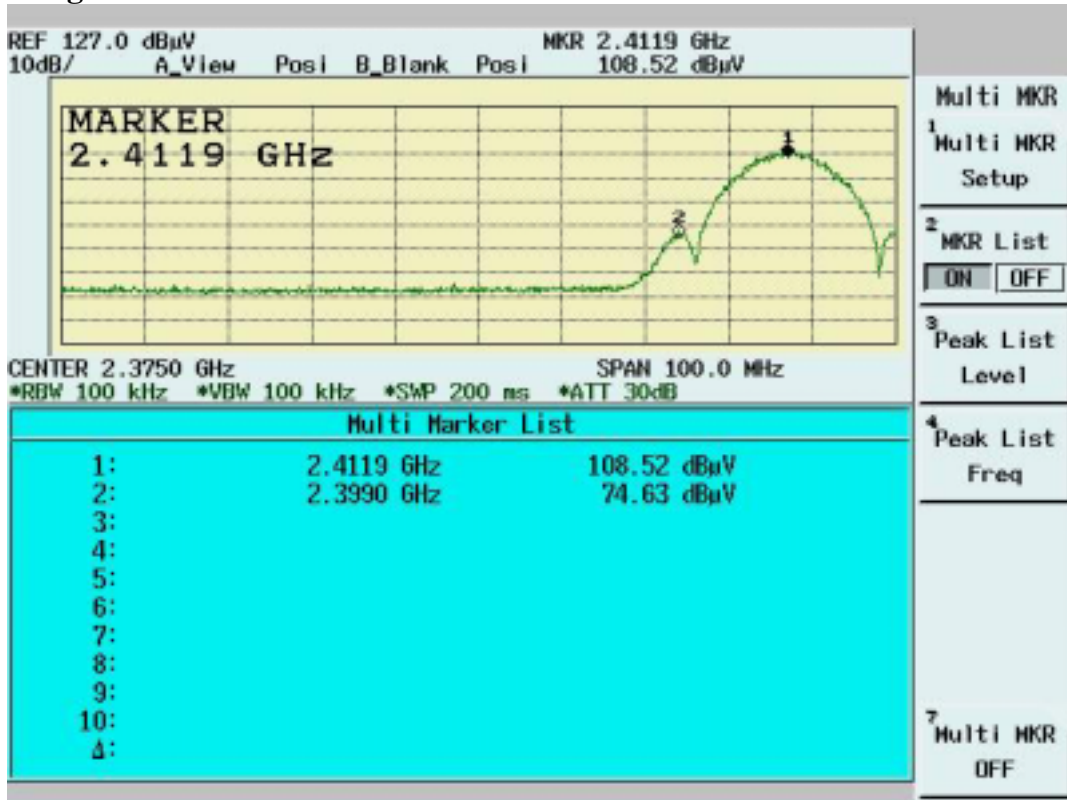

Band Edge Conducted Measurement

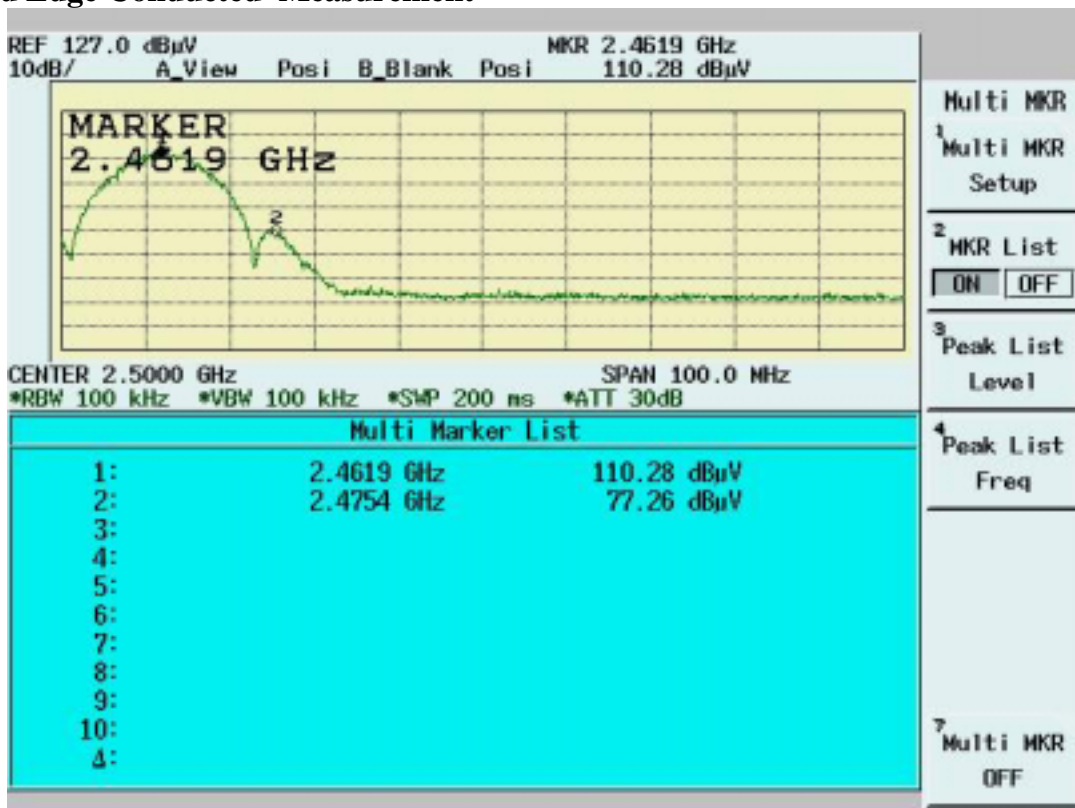

5.5.4 Test Procedure (Radiated)

1. Antenna and Turntable test procedure same as Radiated Emission Measurement.
Equipment mode: Spectrum analyzer
Detector function: Peak mode
SPAN: 100MHz
RBW: 1MHz
VBW: 3MHz
Center frequency: 2.395GHz, 2.48GHz.
2. Using Peak Search to read the peak power of Carrier frequencies after Maximum Hold function is completed.
3. Find the next peak frequency outside the operation frequency band
4. For peak frequency emission level measurement in Restricted Band ,
Change RBW: 1MHz
VBW: 10Hz
Span: 100MHz.
5. Get the spectrum reading after Maximum Hold function is completed.

5.5.5 Test Setup (Radiated)

Same as *Radiated Emission Measurement*

5.5.6 Test Data

Table Band Edge measurement (Radiated)

Temperature ():25

Humidity (%):44

Test Engineer:Mailes Hsieh

Description	Frequency (MHz)	Spectrum Reading (dBuV)	Correction Factor (dB/m)	Emission Level (dBuV/m)	dBc (Limit: > 20dBc)	Limit (dBuV/m)	Equip. Setup VBW	Pass or Fail
Channel_1 (average mode)	2411.4	39.42	35.48	74.90	---	---	10Hz	---
Channel_1 (peak mode)	2411.8	47.60	35.48	83.08	---	---	3MHz	---
Outside band (peak mode)	2398.8	19.09	35.48	54.57	28.51	---	3MHz	Pass
Channel_11 (average mode)	2462.7	36.64	35.50	72.14	---	---	10Hz	---
Channel_11 (peak mode)	2461.9	45.44	35.50	80.94	---	---	3MHz	---
Outside band (peak mode)	2475.0	19.48	35.51	54.99	25.95	---	3MHz	Pass
Channel_1 Restricted band (peak mode)	2383.2	16.61	35.47	52.08	---	74	3MHz	Pass
Restricted band (average mode)	2390.0	5.02	35.47	40.49	---	54	10Hz	Pass
Channel_11 Restricted band (peak mode)	2478.6	17.38	35.51	52.89	---	74	3MHz	Pass
Restricted band (average mode)	2483.5	5.80	35.51	41.31	---	54	10Hz	Pass

Note:

- The Spectrum plot of emission level measurement in Restricted band is attached.
- Emission Level=Spectrum Reading+Correction Factor
- Correction Factor=Antenna Factor+cable loss–amplifier gain
- Both Horizontal and Vertical polarizaion have been tested and the worst data is listed above.

Band Edge measurement for radiated emission in Restricted Band(Radiated) Peak Mode (Channel 1)

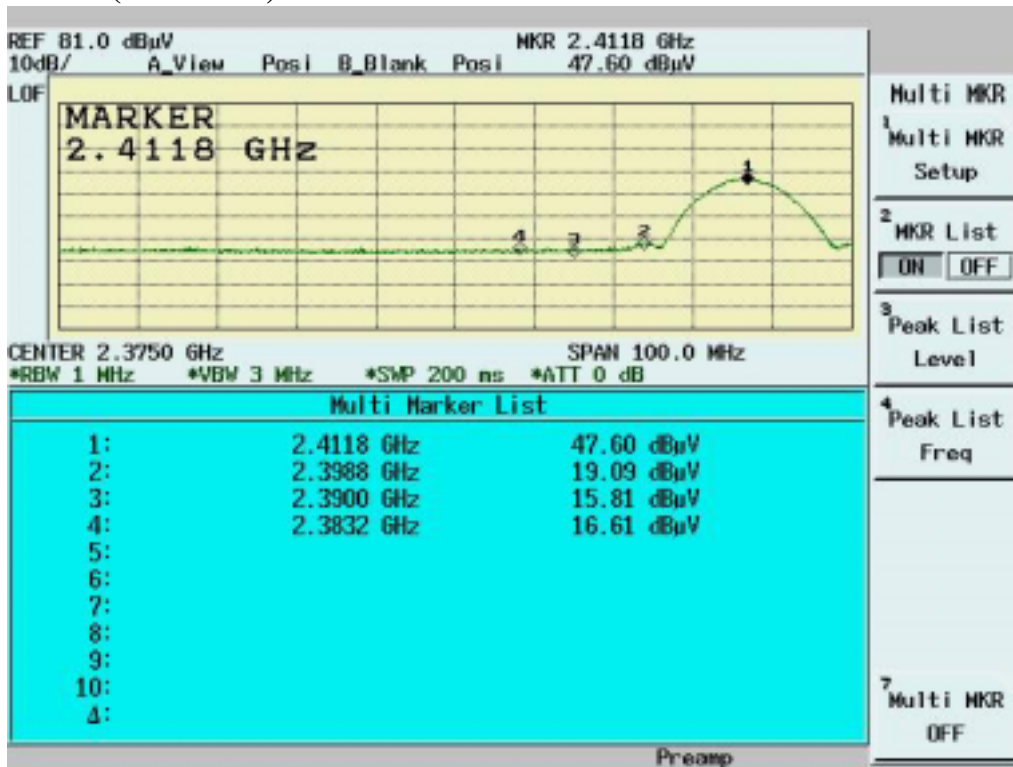

Band Edge measurement for radiated emission in Restricted Band(Radiated) Average Mode (Channel 1)

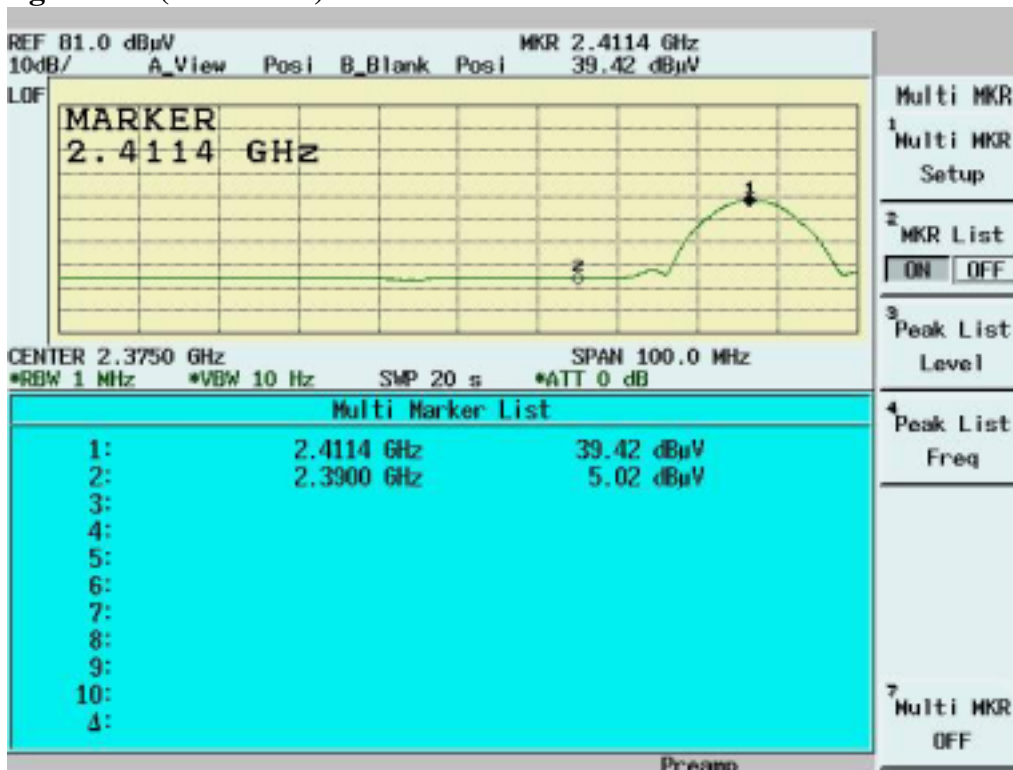

Band Edge measurement for radiated emission in Restricted Band(Radiated) Peak Mode (Channel 11)

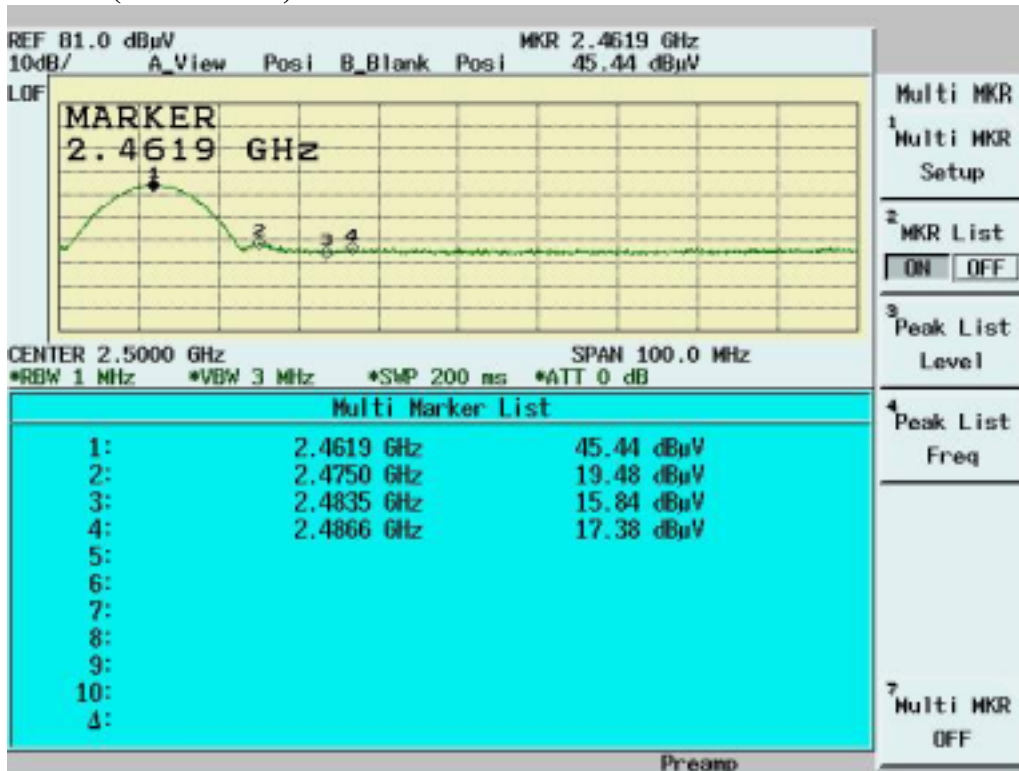

Band Edge measurement for radiated emission in Restricted Band(Radiated) Average Mode (Channel 11)

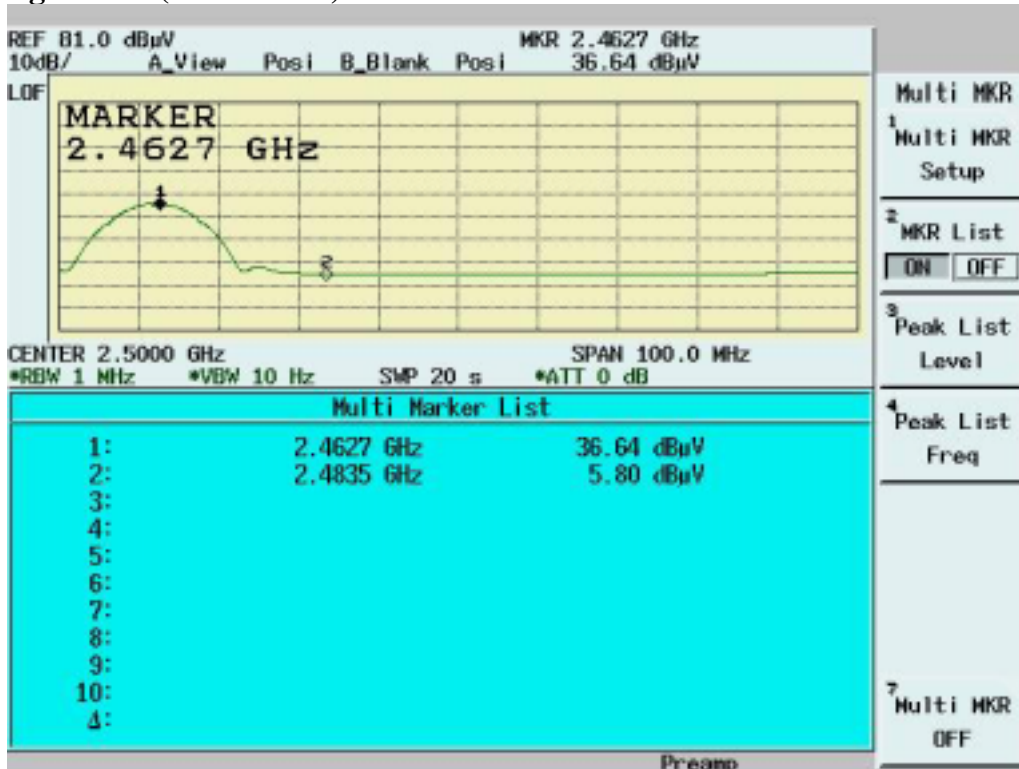

5.6 RF Exposure Measurement [Section 15.247(b)(4) & 1.1307(b)]

See MPE report

5.7 DSSS Peak Power Spectral Density [Section 15.247(d)]

5.7.1 Test Procedure

1. The Transmitter output of EUT was connected to the spectrum analyzer.
 Equipment mode: Spectrum analyzer
 Detector function: Peak mode
 SPAN:1.5MHz
 RBW: 3KHz
 VBW: 30KHz
 Center frequency: fundamental frequency tested.
 Sweep time= 500 sec.
2. Using Peak Search to read the peak power after Maximum Hold function is completed.

5.7.2 Test Setup



5.7.3 Test Data

Maximum Peak Output Power Density

Temperature ():24

Test Engineer:Mailes Hsieh

Humidity (%):54

Channel	Frequency (MHz)	Spectrum Reading (dBm/3KHz)	Cable Loss (dB)	Peak Power Output (dBm/3KHz)	Limit (dBm/3KHz)	Pass/Fail
1	2412	-10.84	1.10	-9.74	8	Pass
6	2437	-9.63	1.10	-8.53	8	Pass
11	2462	-9.27	1.10	-8.17	8	Pass

Note: Two RF output(MAIN & AUX) have been test,the worse data shown above.

Channel 1

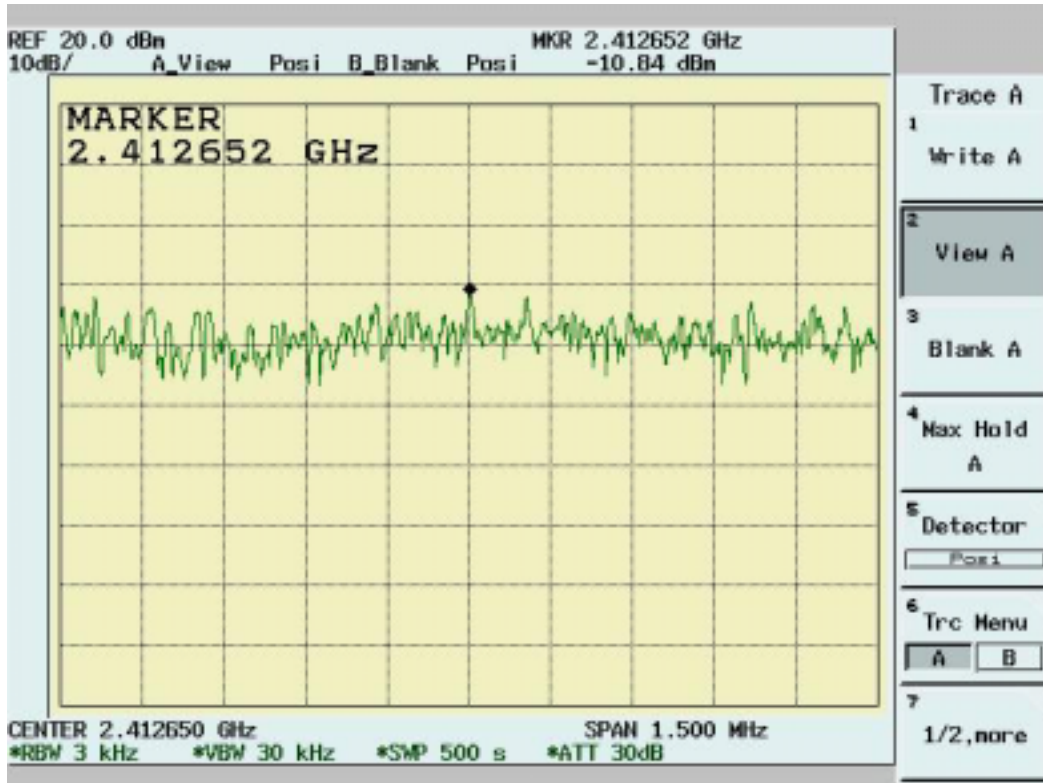

Channel 6

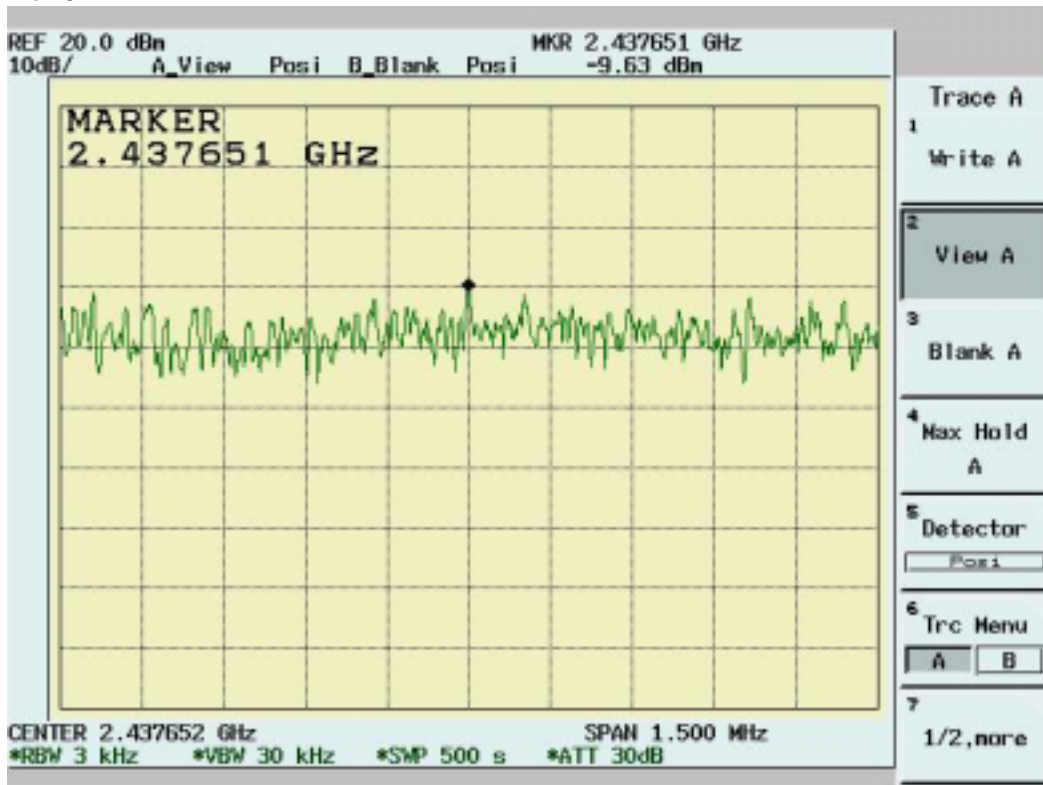

Channel 11

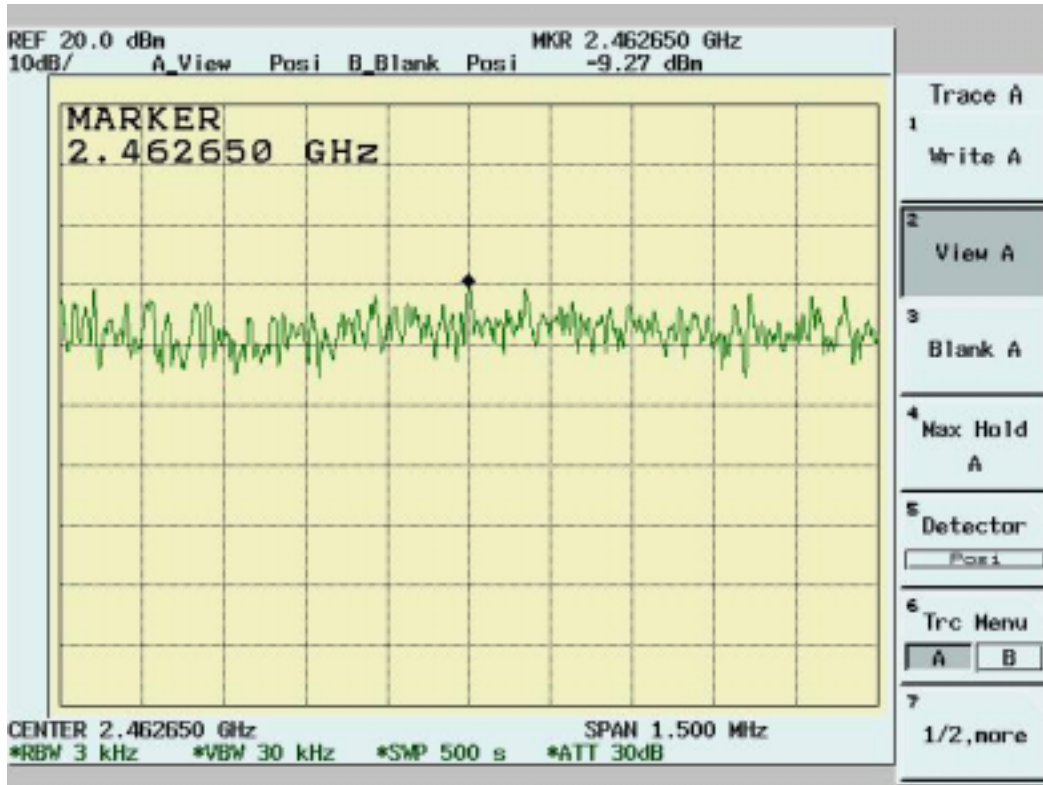

6. TEST RESULTS (802.11g)

6.1 Powerline Conducted Emissions [Section 15.207]

6.1.1 EUT Configuration

The EUT was set up on the non-conductive table that is 1.0 by 1.5 meter, 80cm above ground. The wall of the shielded room was located 40cm to the rear of the EUT.

Power to the EUT was provided through the LISN. The impedance vs. frequency characteristic of the LISN is complied with the limit used.

Both lines (neutral and hot) were connected to the LISN in series at testing. A coaxial-type connector which provides one 50 ohms terminating impedance was provided for connecting the test instrument. The excess length of the power cord was folded back and forth at the center of the lead so as to form a bundle not exceeding 40cm in length.

Any changes made to the configuration, or modifications made to the EUT, during testing are noted in the following test record.

If the EUT is a Personal Computer or a peripheral of personal computer, and the personal computer has an auxiliary AC outlet which can be used for providing power to an external monitor, then all measurements will be made with the monitor power from first the computer-mounted AC outlet and then a floor-mounted AC outlet.

6.1.2 Test Procedure

The system was set up as described above, with the EMI diagnostic software running. The main power line conducted EMI tests were run on the hot and neutral conductors of the power cord and the results were recorded. The effect of varying the position of the interface cables has been investigated to find the configuration that produces maximum emission.

At the frequencies where the peak values of the emissions were higher than 6dB below the applicable limits, the emissions were also measured with the quasi-peak detectors. At the frequencies where the quasi-peak values of the emissions were higher than 6dB below the applicable average limits, the emissions were also measured with the average detectors.

The highest emissions were analyzed in details by operating the spectrum analyzer in fixed tuned mode to determine the nature of the emissions and to provide information which could be useful in reducing their amplitude.

6.1.3 EMI Receiver/Spectrum Analyzer Configuration (for the frequencies tested)

Frequency Range	150 KHz--30MHz
Detector Function	Quasi-Peak/Average
Bandwidth (RBW)	9KHz

6.1.4 Test Data:

Power Line Conducted Emissions (Hot) Channel 1, 6, 11

Operator:MailesHsieh

Temperature(C):25

12:49:02PM,Tuesday,May03,2005

Humidity(%):57

Frequency	LISNLoss	CableLoss	QPCorrt.	QPLimit	QPMargin	AVECorrt.	AVELimit	AVEMargin
MHz	(dB)	(dB)	Amp.(dBuV)	(dBuV)	(dB)	Amp.(dBuV)	(dBuV)	(dB)
0.16241	0.10	0.03	48.01	65.65	-17.64	12.80	55.65	-42.85
0.19226	0.10	0.04	44.48	64.79	-20.31	10.21	54.79	-44.58
0.23383	0.10	0.06	39.79	63.60	-23.81	4.73	53.60	-48.87
0.25013	0.10	0.07	39.10	63.14	-24.04	4.57	53.14	-48.57
0.49978	0.12	0.07	31.92	56.01	-24.09	30.56	46.01	-15.45
2.50786	0.20	0.10	32.41	56.00	-23.59	24.60	46.00	-21.40
2.72201	0.20	0.11	33.58	56.00	-22.42	25.07	46.00	-20.93
2.86483	0.20	0.11	33.61	56.00	-22.39	23.18	46.00	-22.82
19.7087	0.78	0.34	37.39	60.00	-22.61	33.85	50.00	-16.15
22.569	0.85	0.33	48.33	60.00	-11.67	48.17	50.00	-1.83

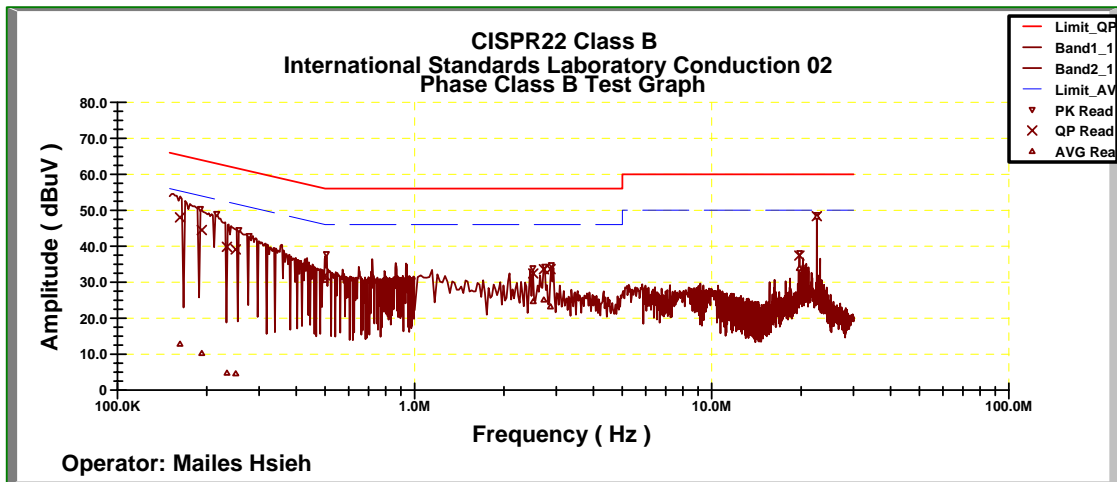

Power Line Conducted Emissions (Neutral) Channel 1, 6, 11

Operator:MailesHsieh

Temperature(C):25

Humidity(%):57

12:59:43PM,Tuesday,May03,2005

Frequency	LISNLoss	CableLoss	QPCorrt.	QPLimit	QPMargin	AVECorrt.	AVELimit	AVEMargin
MHz	(dB)	(dB)	Amp.(dBuV)	(dBuV)	(dB)	Amp.(dBuV)	(dBuV)	(dB)
0.50125	0.12	0.07	31.63	56.00	-24.37	30.01	46.00	-15.99
0.64423	0.14	0.07	28.52	56.00	-27.48	25.47	46.00	-20.53
0.718	0.15	0.07	28.55	56.00	-27.45	26.88	46.00	-19.12
0.85968	0.18	0.07	30.29	56.00	-25.71	28.19	46.00	-17.81
0.92983	0.19	0.07	27.29	56.00	-28.71	24.99	46.00	-21.01
2.29254	0.20	0.10	32.15	56.00	-23.85	24.08	46.00	-21.92
2.43605	0.20	0.10	31.69	56.00	-24.31	21.99	46.00	-24.01
2.72208	0.20	0.11	33.82	56.00	-22.18	25.82	46.00	-20.18
2.86588	0.20	0.11	34.86	56.00	-21.14	24.73	46.00	-21.27
22.5696	0.40	0.33	47.75	60.00	-12.25	47.60	50.00	-2.40

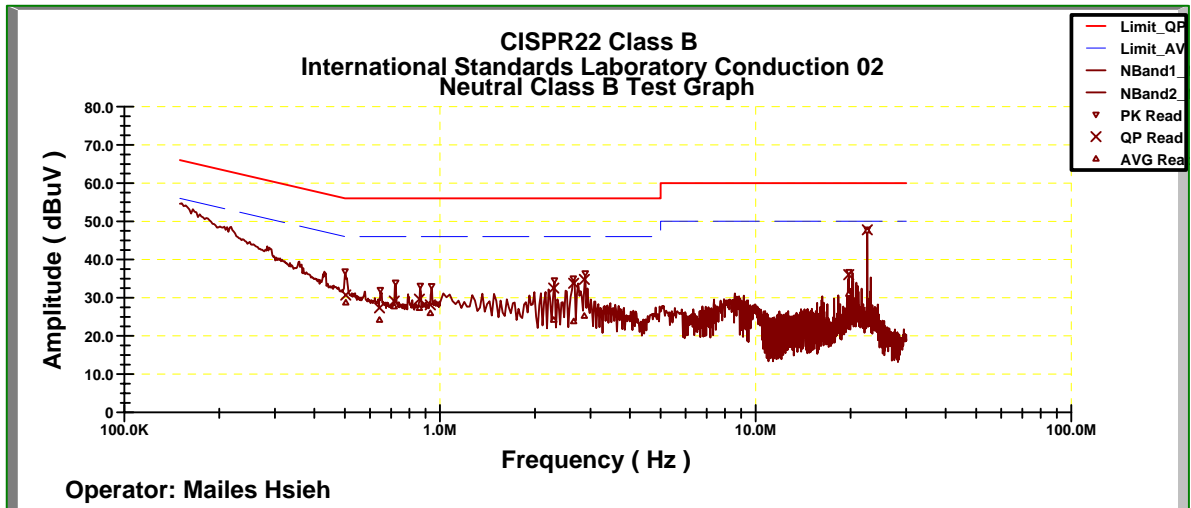

* NOTE: During the test, the EMI receiver was set to Max. Hold then switch the EUT Channel between 1 , 6, 11 to get the maximum reading of all these channels.
 Margin = Amplitude + Insertion Loss- Limit
 A margin of -8dB means that the emission is 8dB below the limit

6.2 Bandwidth for DSSS [Section 15.247 (a)(2)]

6.2.1 Test Procedure

The Transmitter output of EUT was connected to the spectrum analyzer. The 6 dB bandwidth of the fundamental frequency was measured. The setting of spectrum analyzer is as follows

Equipment mode	Spectrum analyzer
Detector function	Peak mode
RBW	100KHz
VBW	100KHz

6.2.2 Test Setup

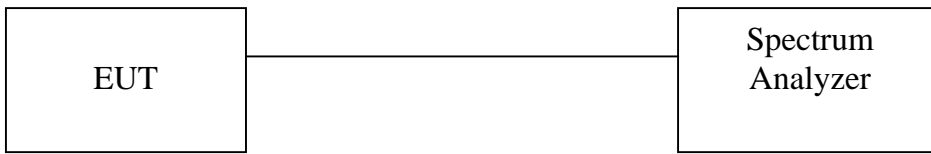

6.2.3 Test Data:

6dB Bandwidth

Temperature ():24

Humidity (%):54

Test Engineer:Mailes Hsieh

Channel	Frequency (MHz)	6dB Bandwidth (MHz)	Limit (MHz)	Pass/Fail
1	2412	16.52	0.5	Pass
6	2437	16.56	0.5	Pass
11	2462	15.28	0.5	Pass

Channel 1:

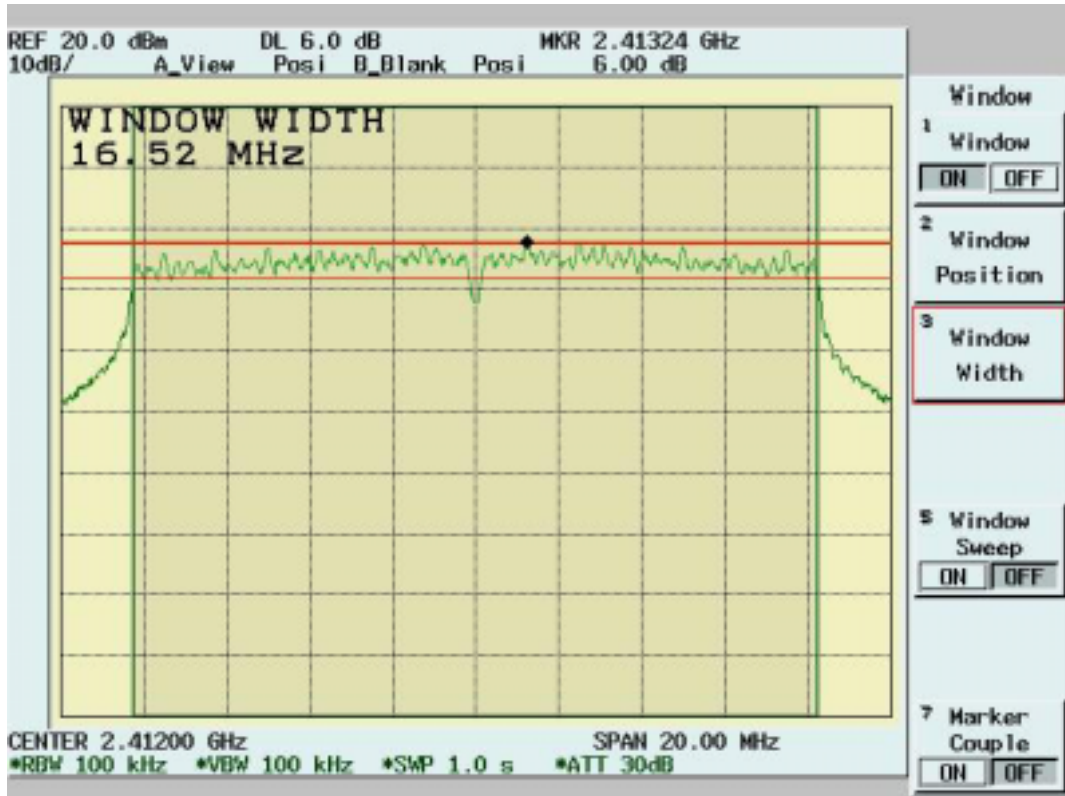

Channel 6:

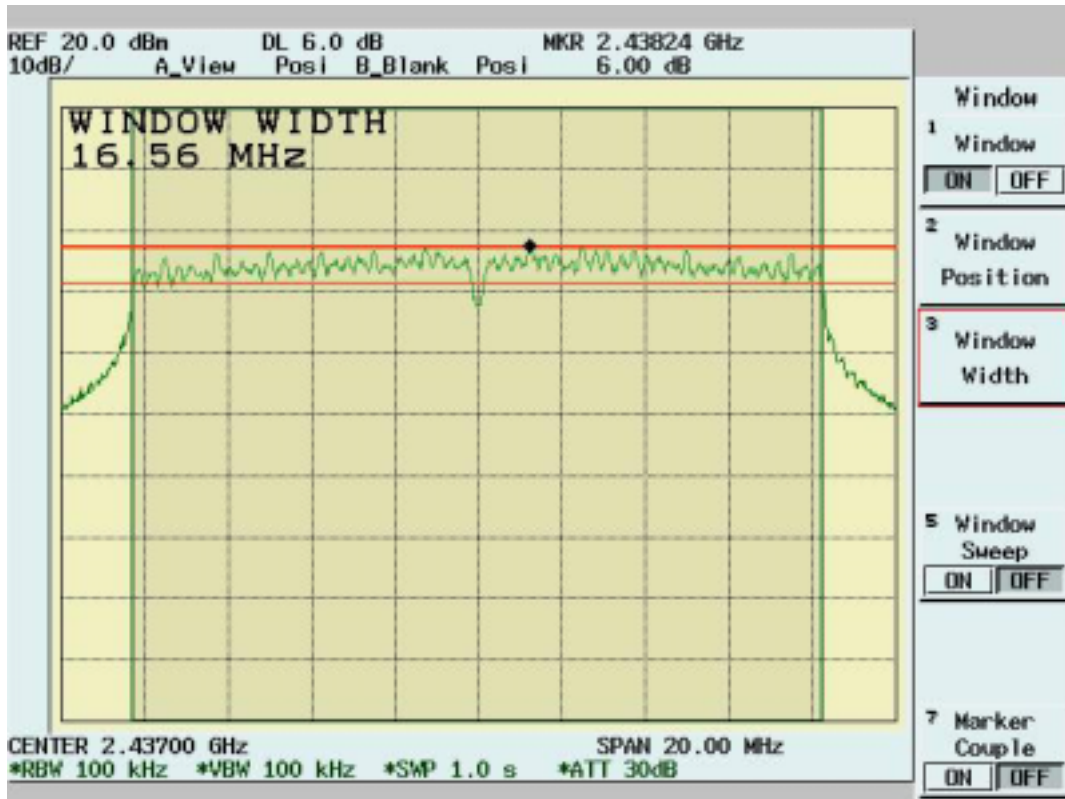

Channel 11:

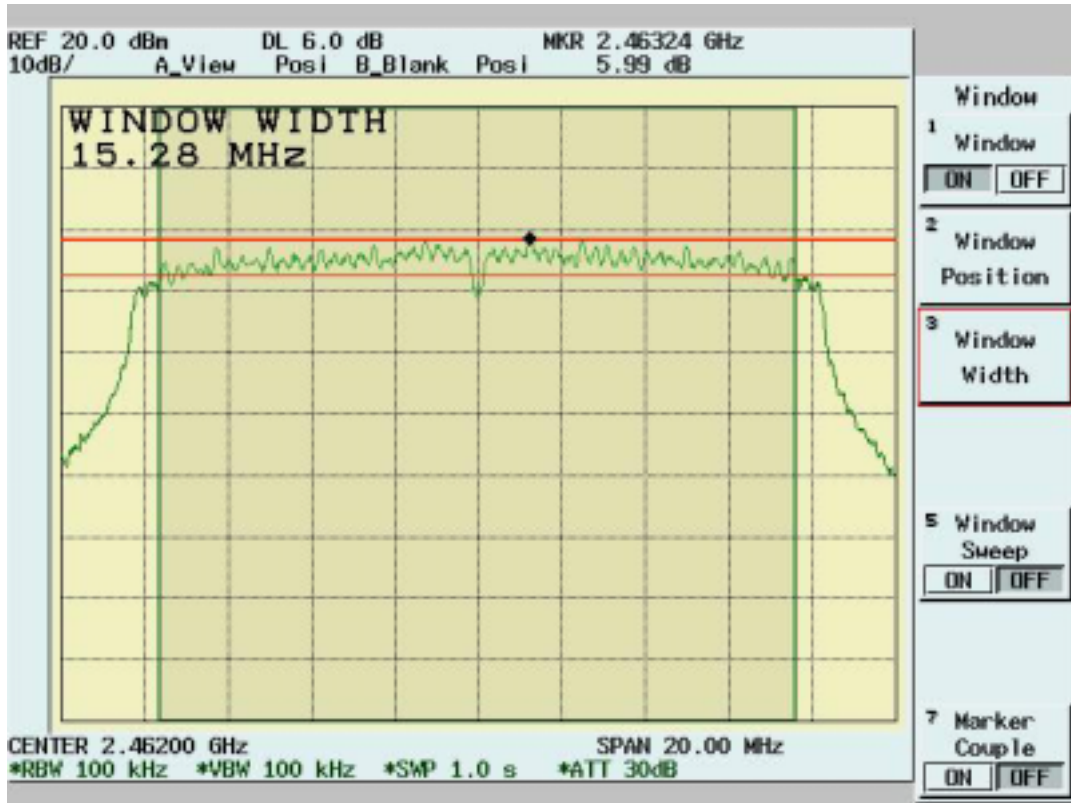

6.3 DSSS Maximum Peak Output Power [Section 15.247 (b)(1)]

6.3.1 Test Procedure

The Transmitter output of EUT was connected to the peak power analyzer.

6.3.2 Test Setup

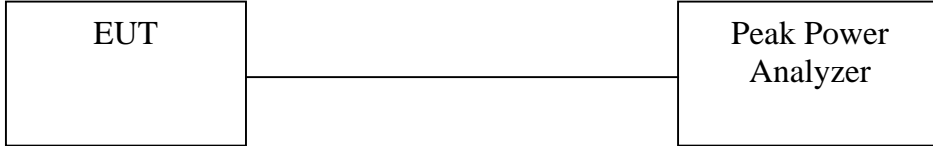

6.3.3 Test Data

Maximum Peak Output Power

Temperature ():24

Test Engineer:Mailes Hsieh

Humidity (%):54

Channel	Frequency (Mhz)	Analyzer Reading (dBm)	Cable Loss (dB)	Peak Power Output (mW)	Peak Power Output (dBm)	Limit (dBm)	Pass/Fail
1	2412	15.82	1.10	49.20	16.92	30	Pass
6	2437	15.94	1.10	50.58	17.04	30	Pass
11	2462	16.29	1.10	54.83	17.39	30	Pass

Note: Two RF output(MAIN & AUX) have been test,the worse data shown above.

6.4 Radiated Emission Measurement [Section [15.247(c)(4)]

6.4.1 EUT Configuration

The equipment under test was set up on the 10 meter chamber with measurement distance of 3 meters. The EUT was placed on a non-conductive table 80cm above ground.

Any changes made to the configuration, or modifications made to the EUT, during testing are noted in the following test record.

6.4.2 Test Procedure

The system was set up as described above, with the EMI diagnostic software running. We found the maximum readings by varying the height of antenna and then rotating the turntable. Both polarization of antenna, horizontal and vertical, are measured.

30M to 1GHz: The highest emissions between 30 MHz to 1000 MHz were also analyzed in details by operating the spectrum analyzer and/or EMI receiver in quasi-peak mode to determine the precise amplitude of the emissions. While doing so, the interconnecting cables and major parts of the system were moved around, the antenna height was varied between one and four meters, its polarization was varied between vertical and horizontal, and the turntable was slowly rotated, to maximize the emission.

1GHz – 25GHz: The highest emissions were also analyzed in details by operating the spectrum analyzer and/or EMI receiver in peak mode to determine the precise amplitude of the emission. While doing so, the interconnecting cables and major parts of the system were moved around, the antenna height was varied between one and four meters, its polarization was varied between vertical and horizontal, and the turntable was slowly rotated, to maximize the emission. During test the EMI receiver and spectrum was setup according to *EMI Receiver/Spectrum Analyzer Configuration*.

For the test of 2nd to 10th harmonics frequencies , the equipment setup was also refer to *EMI Receiver/Spectrum Analyzer Configuration*. The frequencies were tested using Peak mode first, if the test data is higher than the emissions limit, an additional measurement using Average mode will be performed and the average reading will be compared to the limit and record in test report.

6.4.3 EMI Receiver/Spectrum Analyzer Configuration (for the frequencies tested)

Frequency Range Tested:	30MHz~1000MHz
Detector Function:	Quasi-Peak Mode
Resolution Bandwidth (RBW):	120KHz
Video Bandwidth (VBW)	1MHz

Frequency Range Tested:	1GHz – 25 GHz
Detector Function:	Peak Mode
Resolution Bandwidth (RBW):	1MHz
Video Bandwidth (VBW)	3MHz

Frequency Range Tested:	1GHz – 25 GHz
Detector Function:	Average Mode
Resolution Bandwidth (RBW):	1MHz
Video Bandwidth (VBW)	10 Hz

6.4.4 Test Data (30MHz – 1GHz):

30M – 1GHz Open Field Radiated Emissions (Horizontal) Channel 1, 6, 11

Operator:MailesHsieh
Temperature(C):24
Humidity(%):47

Frequency	RxAmp.	AntFact	CableLoss	PreAmpGain	Corrct.Emi.	Limit	Margin	Ant.Pos.	TablePos
MHz	(dBuV)	(dB/m)	(dB)	(dB)	(dBuV/m)	(dBuV/m)	(dB)	(cm)	(deg)
129.91	18.45	11.40	2.16	0.00	32.01	43.50	-11.49	101.00	107.00
231.76	22.98	9.21	2.95	0.00	35.14	46.00	-10.86	101.00	22.00
282.20	17.90	13.09	3.39	0.00	34.38	46.00	-11.62	101.00	22.00
306.45	19.44	13.69	3.68	0.00	36.81	46.00	-9.19	101.00	303.00
331.67	16.41	14.04	3.94	0.00	34.40	46.00	-11.60	101.00	287.00
355.92	17.02	14.49	4.15	0.00	35.65	46.00	-10.35	101.00	287.00
366.59	22.98	14.83	4.22	0.00	42.03	46.00	-3.97	101.00	303.00
432.55	17.13	16.16	4.69	0.00	37.98	46.00	-8.02	101.00	352.00
700.27	6.66	19.01	6.62	0.00	32.28	46.00	-13.72	101.00	22.00
830.25	4.26	20.40	7.70	0.00	32.36	46.00	-13.64	101.00	287.00

30M – 1GHz Open Field Radiated Emissions (Vertical) Channel 1, 6, 11

Operator:MailesHsieh
Temperature(C):24
Humidity(%):47

Frequency	RxAmp.	AntFact	CableLoss	PreAmpGain	Corrct.Emi.	Limit	Margin	Ant.Pos.	TablePos
MHz	(dBuV)	(dB/m)	(dB)	(dB)	(dBuV/m)	(dBuV/m)	(dB)	(cm)	(deg)
129.91	22.40	11.40	2.16	0.00	35.96	43.50	-7.54	101.00	22.00
364.65	22.93	14.77	4.20	0.00	41.90	46.00	-4.10	101.00	55.00
431.58	19.02	16.15	4.68	0.00	39.85	46.00	-6.15	101.00	38.00
497.54	12.16	17.44	5.26	0.00	34.86	46.00	-11.14	101.00	38.00
544.10	11.38	18.65	5.49	0.00	35.51	46.00	-10.49	101.00	350.00
563.50	11.14	18.83	5.63	0.00	35.60	46.00	-10.40	101.00	219.00
629.46	14.70	18.96	6.15	0.00	39.81	46.00	-6.19	101.00	22.00
696.39	12.48	19.00	6.60	0.00	38.07	46.00	-7.93	101.00	6.00
829.28	7.07	20.39	7.70	0.00	35.16	46.00	-10.84	101.00	22.00
833.16	7.02	20.43	7.71	0.00	35.16	46.00	-10.84	101.00	203.00

NOTE:

- During the Pre-test, the EUT has been tested for Channel 1 , 6, 11 transmit from Main and Aux antenna respectively to get all the critical emission frequencies. In the final test all the critical emission frequencies has been tested and the test data are listed above.
- Margin = Corrected Amplitude – Limit
Corrected Amplitude = Radiated Amplitude + Antenna Correction Factor + Cable Loss - Pre-Amplifier Gain
A margin of -8dB means that the emission is 8dB below the limit

All frequencies from 30MHz to 1GHz have been tested

6.4.5 Test Data (1GHz – 25 GHz) .

1GHz~ 25 GHz (Horizontal), Channel 1: 2412 MHz

Operator:MailesHsieh

RBW:1MHz
Humidity(%):47
Temperature(C):26

Frequency MHz	Rx_R. dBuV	Ant_F. dB/m	Cab_L. dB	PreAmpl dB	Emission dBuV/m	Limit dBuV/m	Margin dB	A.Tower cm	T.Table deg
1332.17	49.41	26.03	2.21	34.11	43.53	54.00	-10.47	101	89
1397.10	50.09	26.33	2.22	34.14	44.49	54.00	-9.51	101	85
2488.51	47.12	30.90	1.42	35.20	44.24	54.00	-9.76	101	196
3357.64	48.97	31.39	1.64	35.53	46.46	54.00	-7.54	103	265
6426.57	46.03	36.31	3.36	37.73	47.97	54.00	-6.03	100	211

1GHz~ 25 GHz (Vertical), Channel 1: 2412 MHz

Operator:MailesHsieh

RBW:1MHz
Humidity(%):47
Temperature(C):26

Frequency MHz	Rx_R. dBuV	Ant_F. dB/m	Cab_L. dB	PreAmpl dB	Emission dBuV/m	Limit dBuV/m	Margin dB	A.Tower cm	T.Table deg
1064.94	53.02	24.80	2.18	33.97	46.03	54.00	-7.97	102	108
1392.11	51.70	26.30	2.22	34.14	46.07	54.00	-7.93	101	85
1841.66	48.46	29.67	2.48	34.87	45.74	54.00	-8.26	100	54
2486.01	47.47	30.90	1.44	35.20	44.61	54.00	-9.39	101	196
4986.01	46.69	35.55	2.17	37.89	46.51	54.00	-7.49	100	1
6426.57	49.02	36.31	3.36	37.73	50.96	54.00	-3.04	100	211

Note:

- According to the standards used, Where limits are specified by agencies for both average and peak (or quasi-peak) detection , if the peak (or quasi-peak) measured value complies with the average limit , it is unnecessary to perform an average measurement.
- “ * ”: Fundamental Frequency
- “***”: Not in the restricted band, Limit level=Fundamental Emission-20dB
- “ pk”: peak mode
- “av”: average mode
- “---“: No meter reading data due to the emission level is smaller than spectrum noise level.
- The Spectrum noise level+Correction Factor < Limit - 6 dB
- Margin=Corrected Amplitude – Limit
- Corrected Amplitude=Radiated Amplitude+Antenna Correction Factor+Cable Loss-Pre-Amplifier Gain
- A margin of -8dB means that the emission is 8dB below the limit.

All frequencies from 1GHz to 25 GHz have been tested.

1GHz~ 25 GHz (Horizontal) , Channel 6 : 2437 MHz

Operator:MailesHsieh

RBW:1MHz
Humidity(%):47
Temperature(C):26

Frequency MHz	Rx_R. dBuV	Ant_F. dB/m	Cab_L. dB	PreAmpl dB	Emission dBuV/m	Limit dBuV/m	Margin dB	A.Tower cm	T.Table deg
1399.60	49.41	26.34	2.22	34.15	43.82	54.00	-10.18	101	84
1994.01	43.91	30.95	2.60	35.17	42.29	54.00	-11.71	100	43
2493.51	46.41	30.90	1.40	35.20	43.51	54.00	-10.49	101	198
3357.64	48.84	31.39	1.64	35.53	46.33	54.00	-7.67	103	265
6493.01	48.41	36.39	3.40	37.68	50.53	54.00	-3.47	100	199

1GHz~ 25 GHz (Vertical), Channel 6 : 2437 MHz

Operator:MailesHsieh

RBW:1MHz
Humidity(%):47
Temperature(C):26

Frequency MHz	Rx_R. dBuV	Ant_F. dB/m	Cab_L. dB	PreAmpl dB	Emission dBuV/m	Limit dBuV/m	Margin dB	A.Tower cm	T.Table deg
1067.43	51.96	24.81	2.18	33.97	44.98	54.00	-9.02	102	107
1399.60	51.67	26.34	2.22	34.15	46.08	54.00	-7.92	101	84
1841.66	48.89	29.67	2.48	34.87	46.17	54.00	-7.83	100	54
2486.01	48.03	30.90	1.44	35.20	45.17	54.00	-8.83	101	196
4989.51	46.91	35.56	2.17	37.90	46.74	54.00	-7.26	100	1
6493.01	50.20	36.39	3.40	37.68	52.31	54.00	-1.69	100	199

Note:

- According to the standards used, Where limits are specified by agencies for both average and peak (or quasi-peak) detection , if the peak (or quasi-peak) measured value complies with the average limit , it is unnecessary to perform an average measurement.
- “ * ”: Fundamental Frequency
- “**”: Not in the restricted band, Limit level=Fundamental Emission-20dB
- “ pk” : peak mode
- “av”: average mode
- “---“: No meter reading data due to the emission level is smaller than spectrum noise level.
- The Spectrum noise level+Correction Factor < Limit - 6 dB
- Margin=Corrected Amplitude – Limit
- Corrected Amplitude=Radiated Amplitude+Antenna Correction Factor+Cable Loss-Pre-Amplifier Gain
- A margin of -8dB means that the emission is 8dB below the limit.

All frequencies from 1GHz to 25 GHz have been tested.

1GHz~ 25 GHz (Horizontal), Channel 11: 2462 MHz

Operator:MailesHsieh

RBW:1MHz
Humidity(%):47
Temperature(C):26

Frequency MHz	Rx_R. dBuV	Ant_F. dB/m	Cab_L. dB	PreAmpl dB	Emission dBuV/m	Limit dBuV/m	Margin dB	A.Tower cm	T.Table deg
1029.97	49.65	24.64	2.17	33.95	42.51	54.00	-11.49	102	110
1399.60	49.54	26.34	2.22	34.15	43.95	54.00	-10.05	101	84
2488.51	48.56	30.90	1.42	35.20	45.69	54.00	-8.31	101	196
3357.64	48.51	31.39	1.64	35.53	46.00	54.00	-8.00	103	265
6559.44	46.53	36.72	3.36	37.62	49.00	54.00	-5.00	101	187

1GHz~ 25 GHz (Vertical), Channel 11 : 2462 MHz

Operator:MailesHsieh

RBW:1MHz
Humidity(%):47
Temperature(C):26

Frequency MHz	Rx_R. dBuV	Ant_F. dB/m	Cab_L. dB	PreAmpl dB	Emission dBuV/m	Limit dBuV/m	Margin dB	A.Tower cm	T.Table deg
1064.94	51.70	24.80	2.18	33.97	44.71	54.00	-9.29	102	108
1399.60	50.49	26.34	2.22	34.15	44.90	54.00	-9.10	101	84
1839.16	47.84	29.65	2.48	34.86	45.10	54.00	-8.90	100	54
2491.01	47.22	30.90	1.41	35.20	44.33	54.00	-9.67	101	197
4996.50	46.06	35.59	2.17	37.91	45.91	54.00	-8.09	100	0
6688.81	41.70	37.42	3.29	37.51	44.90	54.00	-9.10	101	164

Note:

- According to the standards used, Where limits are specified by agencies for both average and peak (or quasi-peak) detection , if the peak (or quasi-peak) measured value complies with the average limit , it is unnecessary to perform an average measurement.
- “ * ”: Fundamental Frequency
- “**”: Not in the restricted band, Limit level=Fundamental Emission-20dB
- “ pk” : peak mode
- “av”: average mode
- “---“: No meter reading data due to the emission level is smaller than spectrum noise level.
- The Spectrum noise level+Correction Factor < Limit - 6 dB
- Margin=Corrected Amplitude – Limit
- Corrected Amplitude=Radiated Amplitude+Antenna Correction Factor+Cable Loss-Pre-Amplifier Gain
- A margin of -8dB means that the emission is 8dB below the limit.

All frequencies from 1GHz to 25 GHz have been tested.

6.5 Band Edge Measurement

6.5.1 Test Procedure (Conducted)

1. The transmitter output of EUT was connected to the spectrum analyzer.
Equipment mode: Spectrum analyzer
Detector function: Peak mode
SPAN: 100MHz
RBW: 100KHz
VBW: 100KHz
Center frequency: 2.4GHz, 2.4835GHz.
2. Using Peak Search to read the peak power of Carrier frequencies after Maximum Hold function is completed
3. Find the next peak frequency outside the operation frequency band

6.5.2 Test Setup (Conducted)

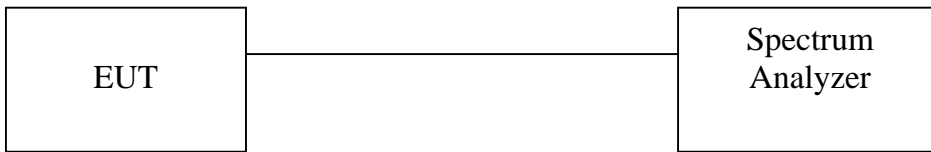

6.5.3 Test Data:

Table: Band Edge measurement (Conducted)

Temperature ():24

Test Engineer:Mailes Hsieh

Humidity (%):54

Channel	Frequency (MHz)	Spectrum Reading (dBuV)	Carrier - Outsideband Limit: >20dB (dB)	Pass/Fail
1	2414.5	104.84	---	---
Outside band	2400.0	72.93	31.91	Pass
11	2463.2	105.76	---	---
Outside band	2475.3	61.13	44.63	Pass

Note: Two RF output(MAIN & AUX) have been test,the worse data shown above.

Band Edge Conducted measurement

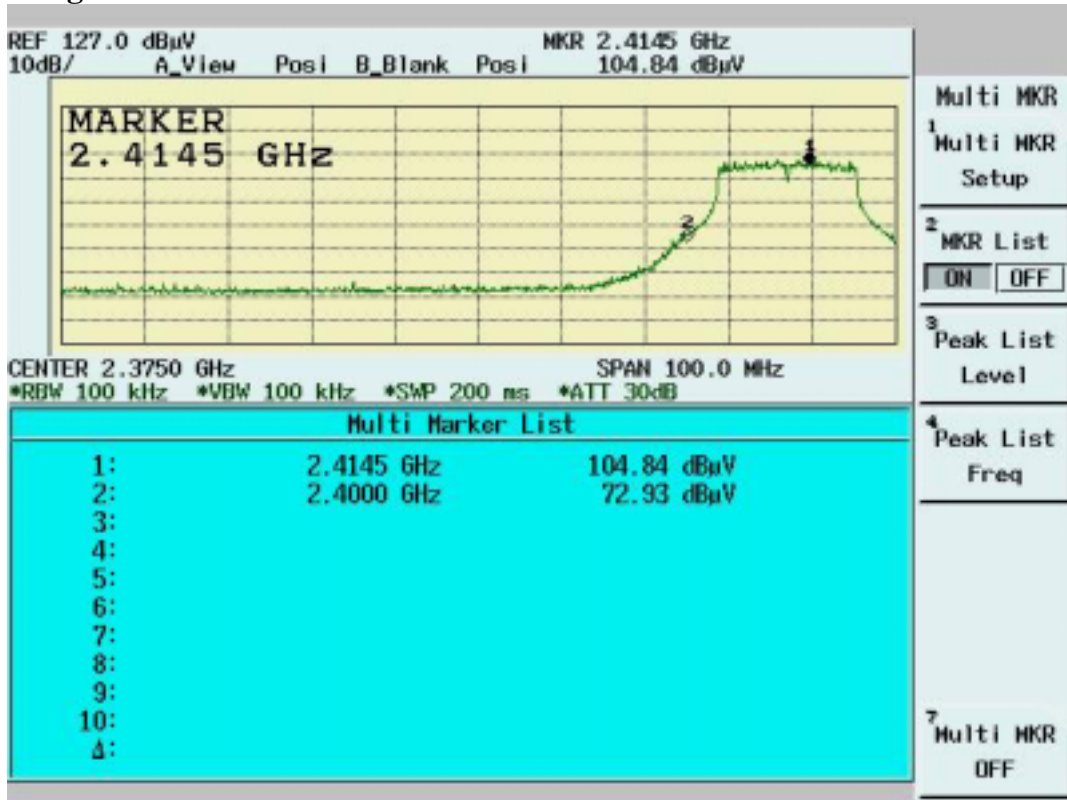

Band Edge Conducted Measurement

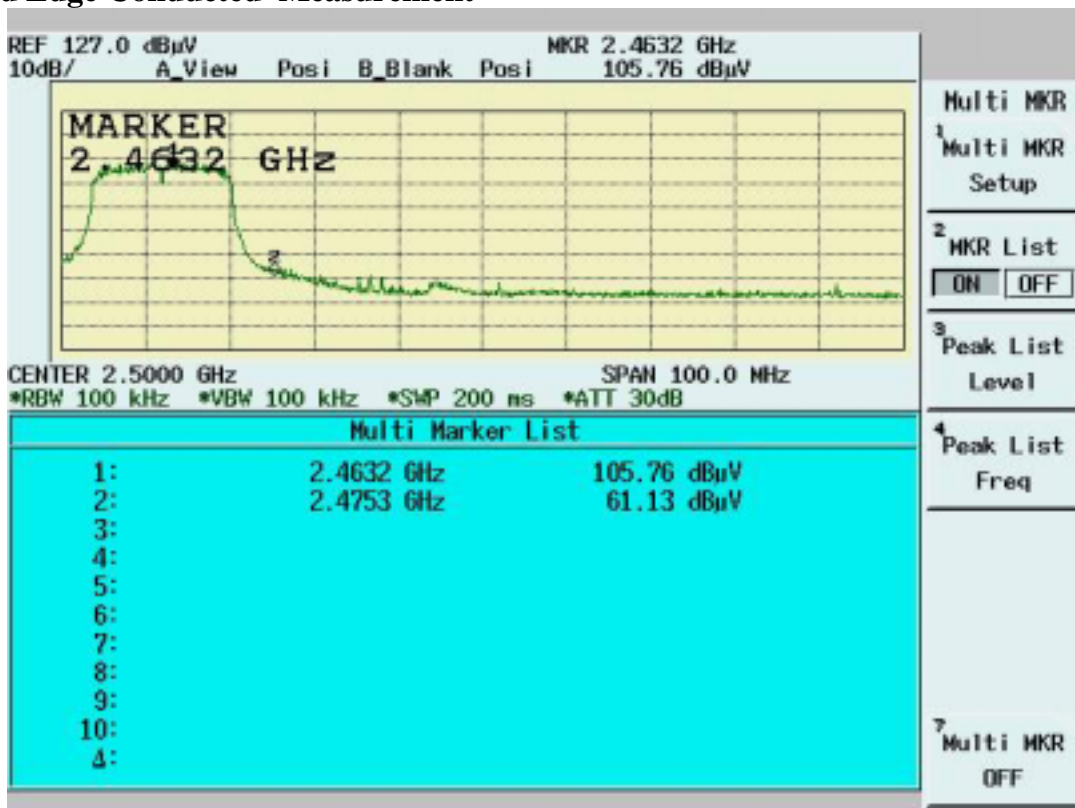

6.5.4 Test Procedure (Radiated)

1. Antenna and Turntable test procedure same as Radiated Emission Measurement.
Equipment mode: Spectrum analyzer
Detector function: Peak mode
SPAN: 100MHz
RBW: 1MHz
VBW: 3MHz
Center frequency: 2.395GHz, 2.48GHz.
2. Using Peak Search to read the peak power of Carrier frequencies after Maximum Hold function is completed.
3. Find the next peak frequency outside the operation frequency band
4. For peak frequency emission level measurement in Restricted Band ,
Change RBW: 1MHz
VBW: 10Hz
Span: 100MHz.
5. Get the spectrum reading after Maximum Hold function is completed.

6.5.5 Test Setup (Radiated)

Same as *Radiated Emission Measurement*

6.5.6 Test Data

Table Band Edge measurement (Radiated)

Temperature ():25

Test Engineer:Mailes Hsieh

Humidity (%):44

Description	Frequency (MHz)	Spectrum Reading (dBuV)	Correction Factor (dB/m)	Emission Level (dBuV/m)	dBc (Limit: > 20dBc)	Limit (dBuV/m)	Equip. Setup VBW	Pass or Fail
Channel_1 (average mode)	2410.8	31.92	35.48	67.40	---	---	10Hz	---
Channel_1 (peak mode)	2409.1	44.45	35.48	79.93	---	---	3MHz	---
Outside band (peak mode)	2400.0	22.88	35.48	58.36	21.57	---	3MHz	Pass
Channel_11 (average mode)	2463.2	30.18	35.50	65.68	---	---	10Hz	---
Channel_11 (peak mode)	2467.2	42.55	35.50	78.05	---	---	3MHz	---
Outside band (peak mode)	2473.5	16.73	35.51	52.24	25.81	---	3MHz	Pass
Channel_1 Restricted band (peak mode)	2389.7	15.96	35.47	51.43	---	74	3MHz	Pass
Restricted band (average mode)	2390.0	5.03	35.47	40.50	---	54	10Hz	Pass
Channel_11 Restricted band (peak mode)	2450.6	17.14	35.51	52.65	---	74	3MHz	Pass
Restricted band (average mode)	2483.5	5.80	35.51	41.31	---	54	10Hz	Pass

Note:

- The Spectrum plot of emission level measurement in Restricted band is attached.
- Emission Level=Spectrum Reading+Correction Factor
- Correction Factor=Antenna Factor+cable loss–amplifier gain
- Both Horizontal and Vertical polarizaion have been tested and the worst data is listed above.

Band Edge measurement for radiated emission in Restricted Band(Radiated) Peak Mode (Channel 1)

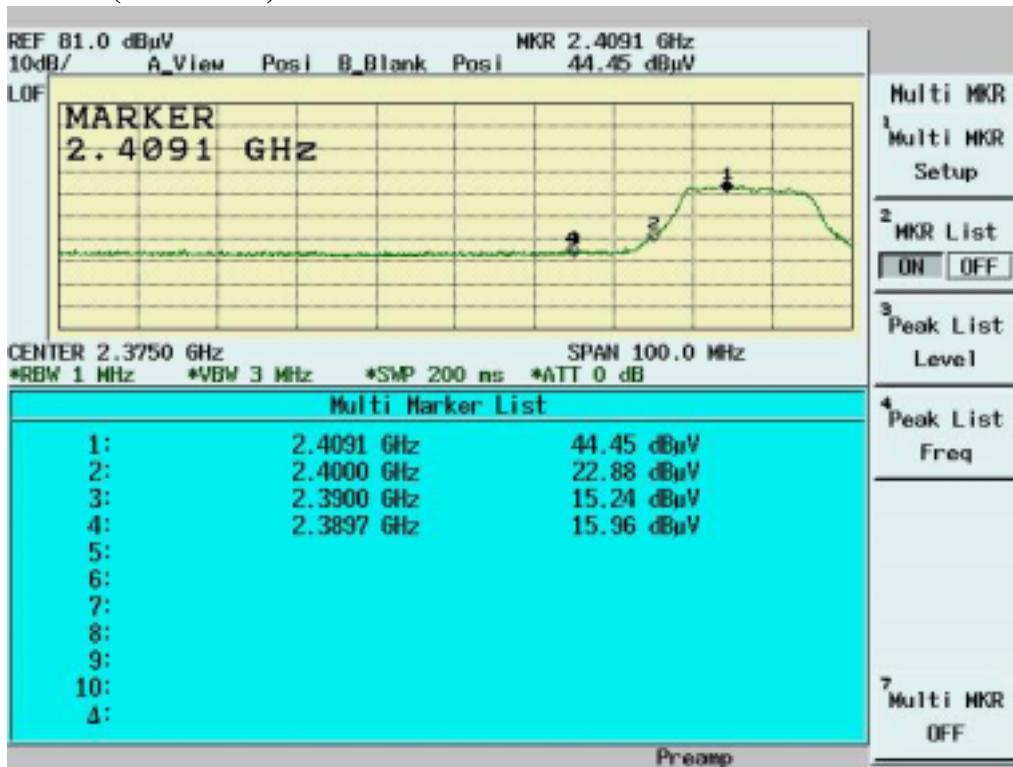

Band Edge measurement for radiated emission in Restricted Band(Radiated) Average Mode (Channel 1)

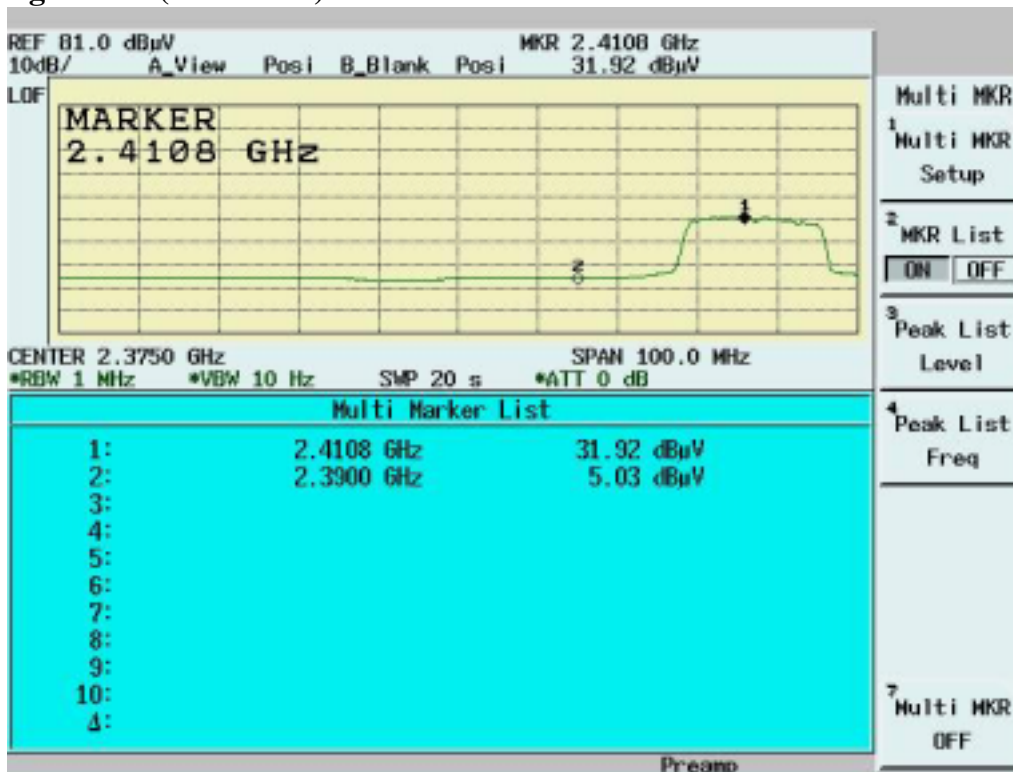

Band Edge measurement for radiated emission in Restricted Band(Radiated) Peak Mode (Channel 11)

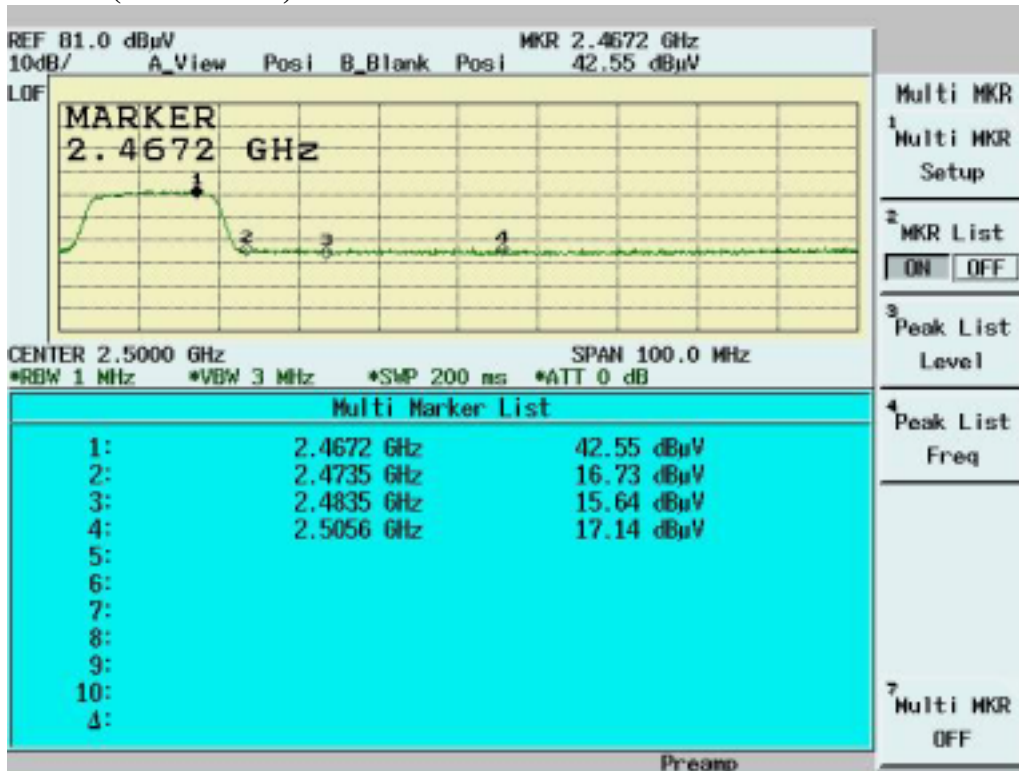

Band Edge measurement for radiated emission in Restricted Band(Radiated) Average Mode (Channel 11)

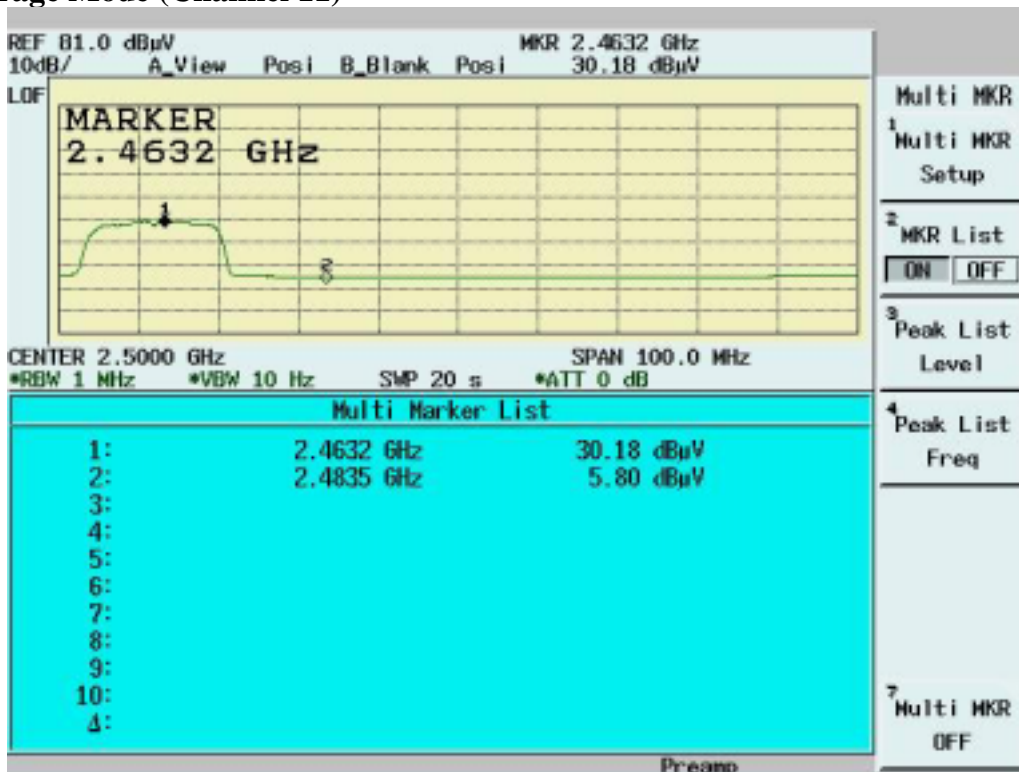

6.6 RF Exposure Measurement [Section 15.247(b)(4) & 1.1307(b)]

See MPE report

6.7 DSSS Peak Power Spectral Density [Section 15.247(d)]

6.7.1 Test Procedure

1. The Transmitter output of EUT was connected to the spectrum analyzer.
 Equipment mode: Spectrum analyzer
 Detector function: Peak mode
 SPAN:1.5MHz
 RBW: 3KHz
 VBW: 30KHz
 Center frequency: fundamental frequency tested.
 Sweep time= 500 sec.
2. Using Peak Search to read the peak power after Maximum Hold function is completed.

6.7.2 Test Setup

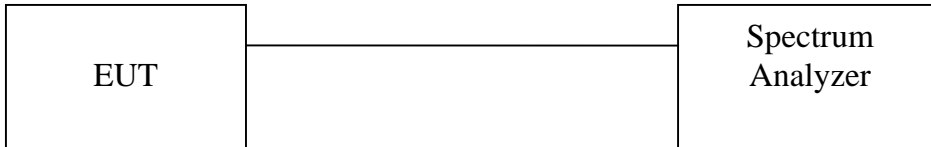

6.7.3 Test Data

Maximum Peak Output Power Density

Temperature ():24

Test Engineer:Mailes Hsieh

Humidity (%):54

Channel	Frequency (MHz)	Spectrum Reading (dBm/3KHz)	Cable Loss (dB)	Peak Power Output (dBm/3KHz)	Limit (dBm/3KHz)	Pass/Fail
1	2412	-15.07	1.10	-13.97	8	Pass
6	2437	-14.56	1.10	-13.46	8	Pass
11	2462	-14.10	1.10	-13.00	8	Pass

Note: Two RF output(MAIN & AUX) have been test,the worse data shown above.

Channel 1



Channel 6

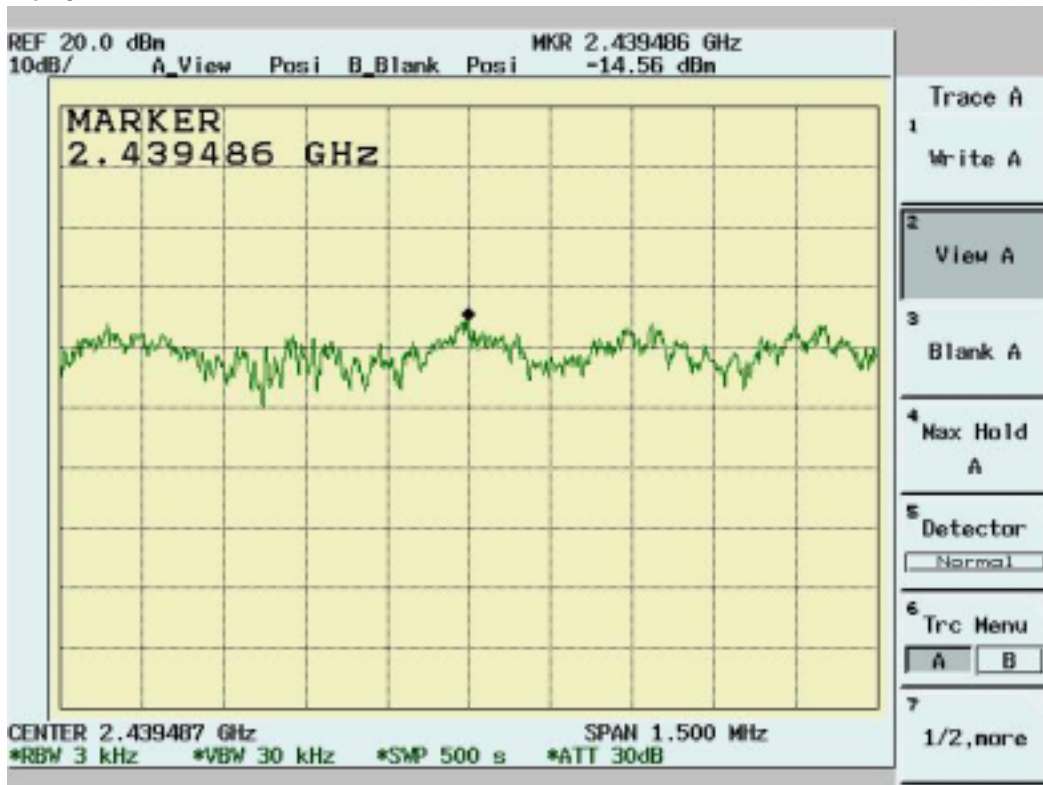

Channel 11

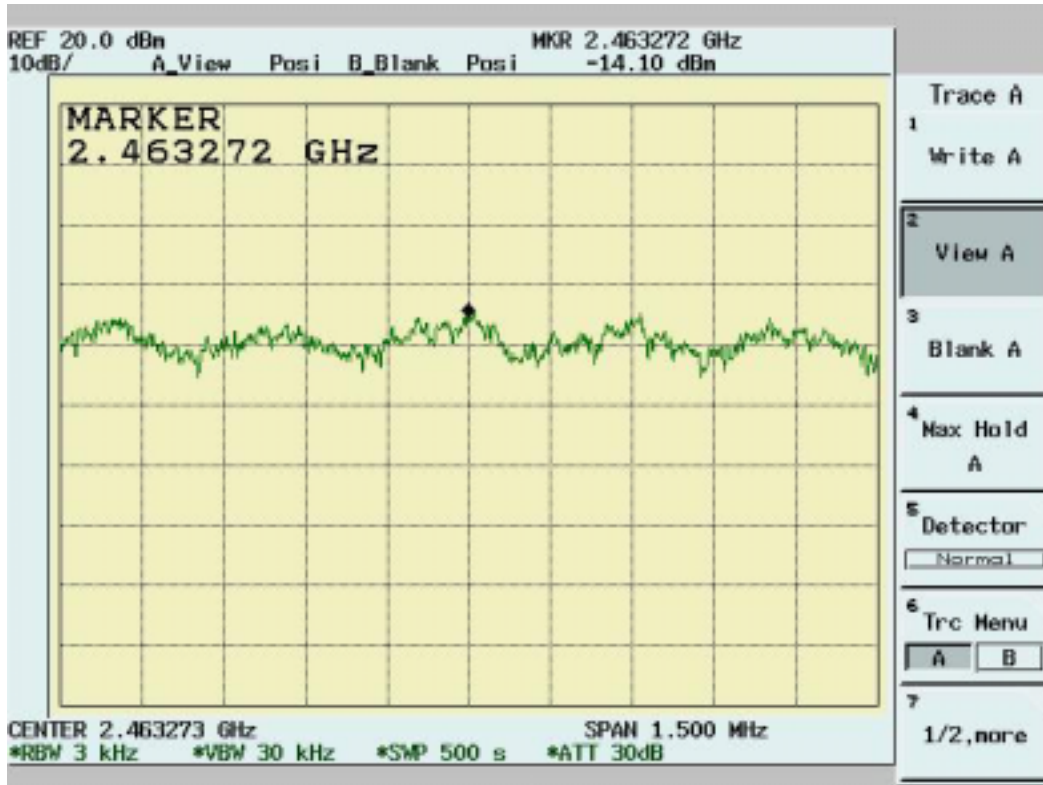

7. Appendix

7.1 Appendix A: Measurement Procedure for Power line Conducted Emissions

The measurements are performed in a 3.5m x 3.4m x 2.5m shielded room, which referred as Conduction 01 test site, or a 3m x 3m x 2.3m test site, which referred as Conduction 02 test site. The EUT was placed on non-conduction 1.0m x 1.5m table, which is 0.8 meters above an earth-grounded.

Power to the EUT was provided through the LISN which has the Impedance (50ohm/50uH) vs. Frequency Characteristic in accordance with the required standard. Power to the LISNs were filtered to eliminate ambient signal interference and these filters were bonded to the ground plane. Peripheral equipment required to provide a functional system (support equipment) for EUT testing was powered from the second LISN through a ganged, metal power outlet box which is bonded to the ground plane at the LISN.

If the EUT is supplied with a flexible power cord, the power cord length in excess of the distance separating the EUT from the LISN shall be folded back and forth at the center of the lead so as to form a bundle not exceeding 40cm in length. If the EUT is provided with a permanently coiled power cord, bundling of the cord is not required. If the EUT is supplied without a power cord, the EUT shall be connected to the LISN by a power cord of the type specified by the manufacturer which shall not be longer than 1 meter. The excess power cord shall be bundled as described above. If a non-flexible power cord is provided with the EUT, it shall be cut to the length necessary to attach the EUT to the LISN and shall not be bundled.

The interconnecting cables were arranged and moved to get the maximum emission. Both the line of power cord, hot and neutral, were measured.

The highest emissions were analyzed in details by operating the spectrum analyzer in fixed tuned mode to determine the nature of the emissions and to provide information which could be useful in reducing their amplitude.

7.2 Appendix B: Test Procedure for Radiated Emissions

Preliminary Measurements in the Anechoic Chamber

The radiated emissions are initially measured in the anechoic chamber at a measurement distance of 3 meters. Desktop EUT are placed on a wooden stand 0.8 meter in height. The measurement antenna is 3 meters from the EUT. The test setup in anechoic chamber is the same as open site. The turntable rotated 360°. The antenna height is varied from 1-2.5m. The primary objective of the radiated measurements in the anechoic chamber is to identify the frequency spectrum in the absence of the electromagnetic environment existing on the open test site. The frequencies can then be pre-selected on the open test site to obtain the corresponding amplitude. The initial scan is made with the spectrum analyzer in automatic sweep mode. The spectrum peaks are then measured manually to determine the exact frequencies.

Measurements on the Open Site or 10m EMC Chamber

The radiated emissions test will then be repeated on the open site or 10m EMC chamber to measure the amplitudes accurately and without the multiple reflections existing in the shielded room. The EUT and support equipment are set up on the turntable of one of the 3 or 10 meter open field sites. Desktop EUT are set up on a wooden stand 0.8 meter above the ground.

For the initial measurements, the receiving antenna is varied from 1-4 meter height and is changed in the vertical plane from vertical to horizontal polarization at each frequency. Both readings are recorded with the quasi-peak detector with 120KHz bandwidth. For frequency between 30 MHz and 1000MHz, the reading is recorded with peak detector or quasi-peak detector. For frequency above 1 GHz, the reading is recorded with peak detector or average detector with 1 MHz bandwidth.

At the highest amplitudes observed, the EUT is rotated in the horizontal plane while changing the antenna polarization in the vertical plane to maximize the reading. The interconnecting cables were arranged and moved to get the maximum emission. Once the maximum reading is obtained, the antenna elevation and polarization will be varied between specified limits to maximize the readings.

7.3 Appendix C: Test Equipment

7.3.1 Test Equipment List

Location	Equipment Name	Brand	Model	S/N	Last Cal. Date	Next Cal. Date
Conduction	Coaxial Cable 1F-C2	Harbourindustries	RG400	1F-C2	06/02/2004	06/02/2005
Conduction	Digital Hygro-Thermometer Conduct	MicroLife	HT-2126G	ISL-Conductio n02	11/30/2004	11/30/2005
Conduction	EMI Receiver 02	HP	85460A	3448A00183	10/01/2004	10/01/2005
Conduction	LISN 01	R&S	ESH2-Z5	890485/013	04/29/2004	04/29/2005
Conduction	LISN 06	R&S	ESH3-Z5	828874/009	12/18/2004	12/18/2005
Radiation	BILOG Antenna 08	Schaffner	CBL6112B	2756	06/02/2004	06/02/2005
Radiation	Coaxial Cable Chmb 02-10M	Belden	RG-8/U	Chmb 02-10M	11/16/2004	11/16/2005
Radiation	Digital Hygro-Thermometer Chmb 02	MicroLife	HT-2126G	Chmb 02	11/30/2004	12/30/2005
Radiation	EMI Receiver 03	HP	85460A	3448A00209	01/08/2005	01/08/2006
Radiation	Spectrum Analyzer 13	Advantest	R3132	121200411	02/16/2005	02/16/2006
Radiation	Horn Antenna 02	Com-Power	AH-118	10088	02/17/2005	02/17/2006
Radiation	Horn Antenna 04	Com-Power	AH-826	081-001	01/13/2005	01/13/2006
Radiation	Horn Antenna 05	Com-Power	AH-640	100A	09/22/2004	09/22/2005
Radiation	Microwave Cable RF SK-01	HUBER+SUHNERAG.	Sucoflex 102	22139 /2	07/07/2004	07/07/2005
Chamber 05	Peak Power Analyzer	HP	8990A	3621A01269	02/15/2005	02/15/2006
Chamber 05	Power Sensor Radar	HP	84815A	3318A01828	02/15/2005	02/15/2006
Radiation	Preamplifier 02	MITEQ	AFS44-00102 650-40-10P-44	728229	01/28/2005	01/28/2006
Radiation	Preamplifier 10	MITEQ	JS-26004000-2 7-5A	818471	02/28/2005	02/28/2006
Radiation	High Pass Filter 01	HEWLETT-PACKARD	84300-80038	001	N/A	N/A
Radiation	High Pass Filter 02	HEWLETT-PACKARD	84300-80039	005	N/A	N/A
Radiation	Spectrum Analyzer 14	Advantest	R3182	140600028	09/09/2004	09/09/2006

Note: Calibration is traceable to NIST or national or international standards.

7.3.2 Software for Controlling Spectrum/Receiver and Calculating Test Data

Radiation/Conduction	Filename	Version	Issued Date
Conduction	Tile.exe	1.12E	7/7/2000
Radiation	Tile.exe	1.12C	6/16/2000

7.4 Appendix D: Layout of EUT and Support Equipment

7.4.1 General Conducted Test Configuration

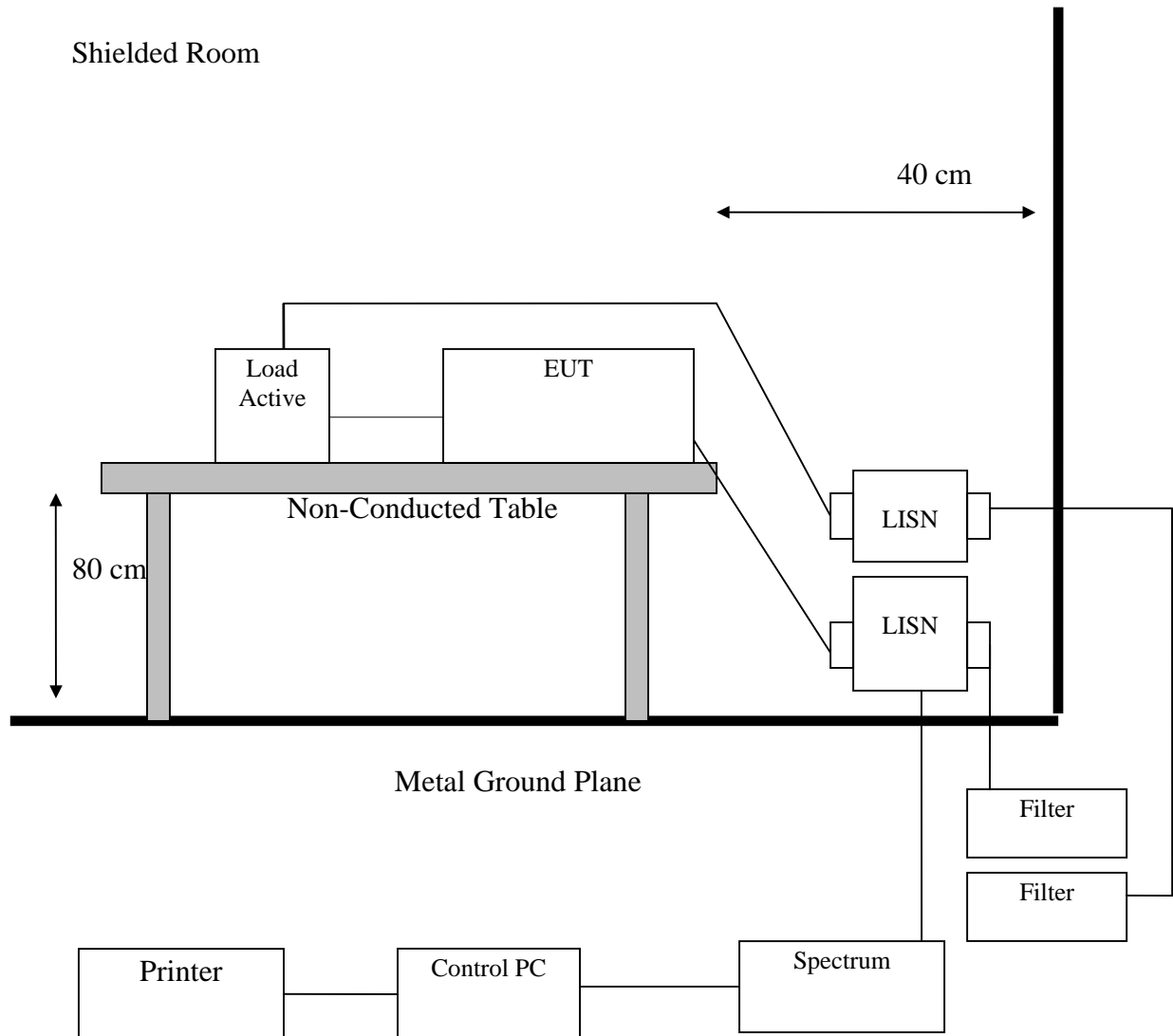

7.4.2 General Radiation Test Configuration

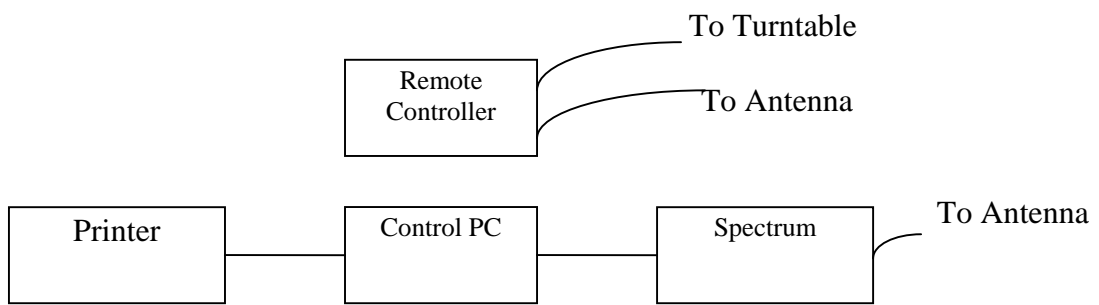
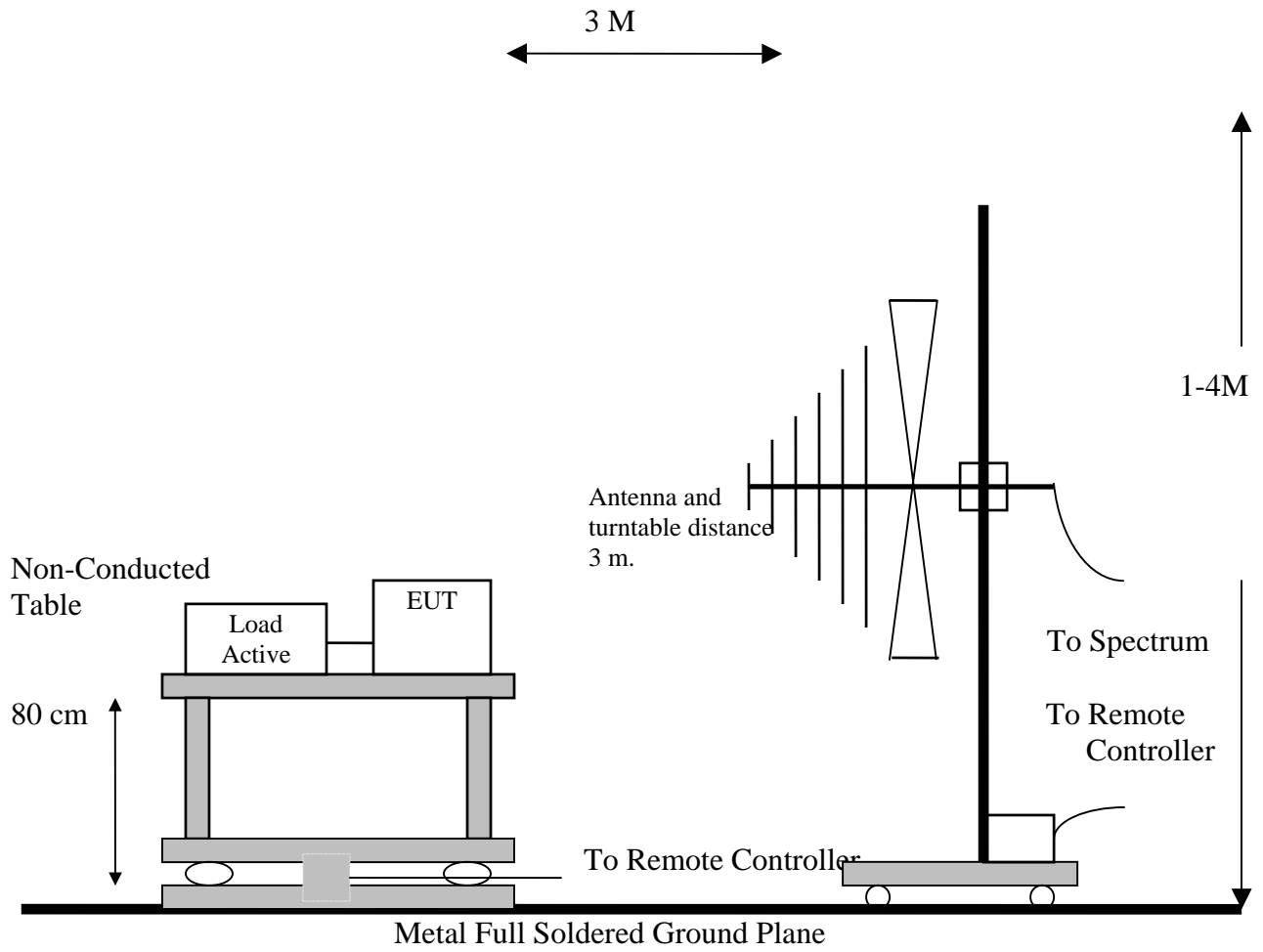

7.5 Appendix E: Description of Support Equipment

7.5.1 Description of Support Equipment

Support Unit 1.

Description:	DELL USB Mouse
Model Number:	M-UR69
Serial Number:	LNA24412741
Power Supply Type:	N/A
Power Cord:	N/A
FCC ID:	N/A (Comply with FCC DOC)

Support Unit 2.

Description:	Aceex Modem (for serial interface port)
Model Number:	DM1414
Serial Number:	0301000557
Power Supply Type:	Linear, Power Adapter (AC to AC Xfmr, Wall Mounted Type)
Power Cord:	Nonshielded, Without Grounding Pin
FCC ID:	IFAXDM1414

Support Unit 3.

Description:	Acer Monitor
Model:	G781
Serial Number:	999007101214400445T7AA31T
Power Cord:	Non-shielded, Detachable
FCC ID:	(Comply with FCC Standards)

7.5.2 Software for Controlling Support Unit

Test programs exercising various part of EUT were used. The programs were executed as follows:

- A. Read and write to the disk drives.
- B. Send H pattern to the serial port device (Modem).
- C. Send H pattern to the video port device (Monitor).
- D. The RF software makes the transmitter continuously sending RF signals
- E. Repeat the above steps.

	Filename	Issued Date
CRTU_ABG Rev3.2.15.0000	CRTU_ABG.exe	2004/07/01
Broadcom Bluetooth	Bluetool.exe	2005/03/24
Monitor	HH.bat	8/20/1991
Modem 1	Hm.bat	8/20/1991

7.5.3 I/O Cable Condition of EUT and Support Units

Description	Path	Cable Length	Cable Type	Connector Type
AC Power Cord	110V (~240V) to AC Power Cord Inlet (3-pin)	1.8M	Nonshielded, Detachable	Plastic Head
Monitor Data Cable	Monitor to PC VGA port	1.6M	Shielded, Un-detachable	Metal Head
Modem Data Cable	Modem to PC COM 1 port	1.5M	Shielded, Detachable	Metal Head
Mouse Data Cable	Mouse to PC Mouse port	1.8M	Shielded, Un-detachable	Metal Head

7.6 Appendix F: Accuracy of Measurement

Test Site: Conduction 02

Item	Source of Uncertainty	Probability Distribution	Total Uncertainties (dB)		Standard Uncertainty (dB)	
			k	Value	k	Value
1	Systematic Effects: (Assessment from 20 repeat observation; 1 reading on EUT)	Normal	k=2	0.104	k=1	0.052
2	Random Effects: (Assessment from 20 random observations; 1 reading on EUT)	Normal	k=2	0.330	k=1	0.165
3	Receiver Calibration	Rectangular	k=1.73	1.000	k=1	0.577
4	LISN Factor Calibration	Normal	k=2	1.200	k=1	0.600
5	Cable Loss Calibration	Normal	k=2	1.000	k=1	0.500
6	Combined Standard Uncertainty Uc(y)	Normal			k=1	0.850
7	Total Uncertainty @95% mim. Confidence Level	Normal	k=2	1.701		

Measurement Uncertainty Calculations:

$$Uc(y) = \text{square root} (u_1(y)^2 + u_2(y)^2 + \dots + u_n(y)^2)$$

$$U = 2 * Uc(y)$$

Note: The measurement Uncertainties mentioned above also refer to NIS 81-1994 of NAMAS :
The treatment of Uncertainty in EMC Measurement.

Test Site: Chamber 02-3M

Item	Source of Uncertainty	Probability Distribution	Total Uncertainties (dB)		Standard Uncertainty (dB)	
1	Systematic Effects: (Assessment from 20 repeat observation; 1 reading on EUT)	Normal	k=2	0.067	k=1	0.034
2	Random Effects: (Assessment from 20 random observations; 1 reading on EUT)	Normal	k=2	0.103	k=1	0.052
3	Receiver Calibration	Rectangular	k=1.73	1.000	k=1	0.577
4	Antenna Factor Calibration	Normal	k=2	1.700	k=1	0.850
5	Cable Loss Calibration	Normal	k=2	1.000	k=1	0.500
6	Combined Standard Uncertainty Uc(y)	Normal			k=1	1.029
7	Total Uncertainty @95% mim. Confidence Level	Normal	k=2	2.059		

Measurement Uncertainty Calculations:

$$U_c(y) = \text{square root} (u_1(y)^2 + u_2(y)^2 + \dots + u_n(y)^2)$$

$$U = 2 * U_c(y)$$

Note: The measurement Uncertainties mentioned above also refer to NIS 81-1994 of NAMAS :
The treatment of Uncertainty in EMC Measurement.

7.7 Appendix G: Photographs of EUT Configuration Test Set Up

The Front View of Highest Conducted Set-up For EUT

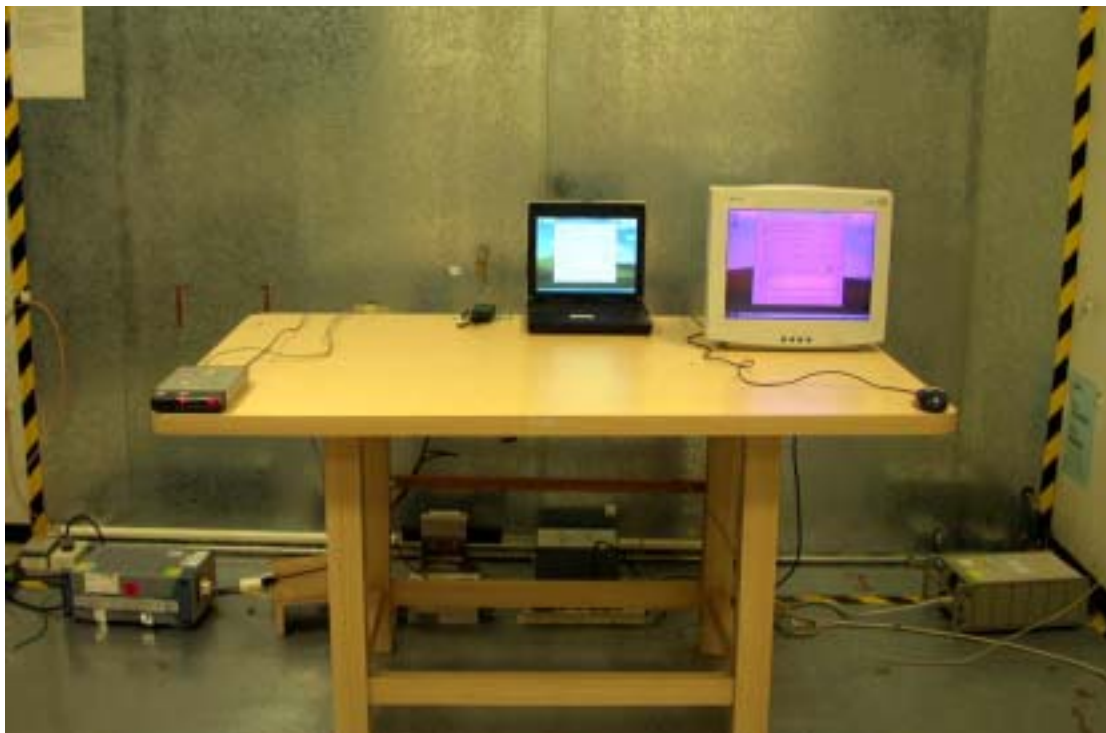

The Back View of Highest Conducted Set-up For EUT



The Front View of Highest Radiated Set-up For EUT

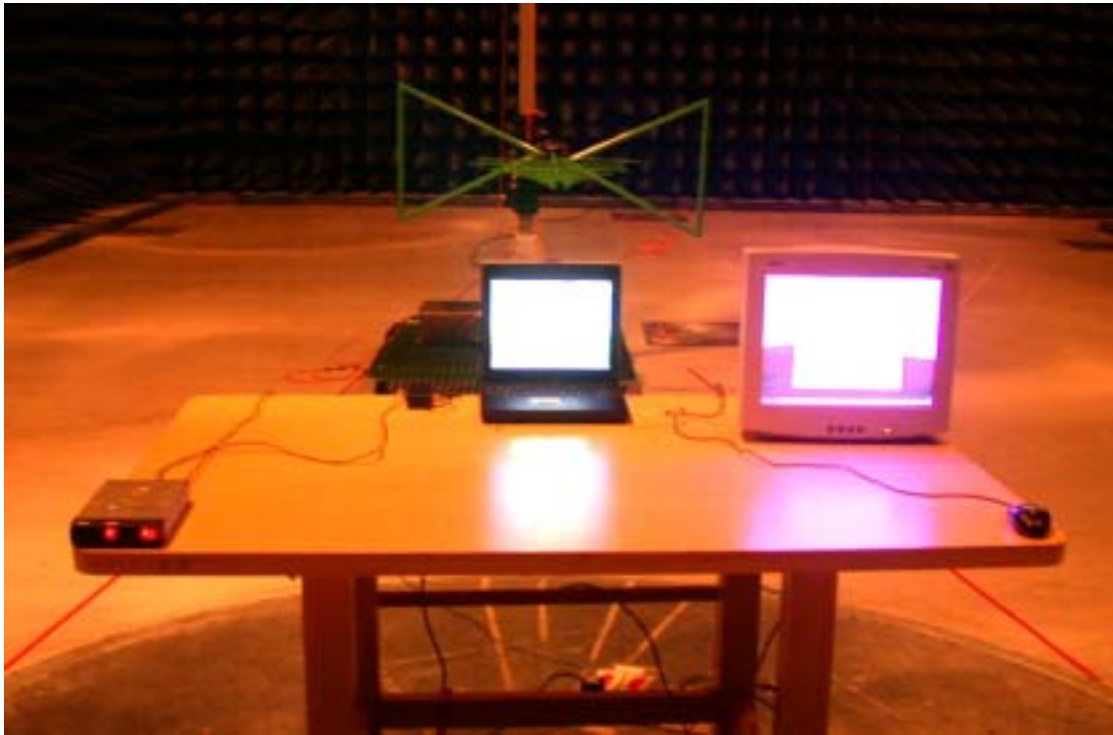

The Back View of Highest Radiated Set-up For EUT

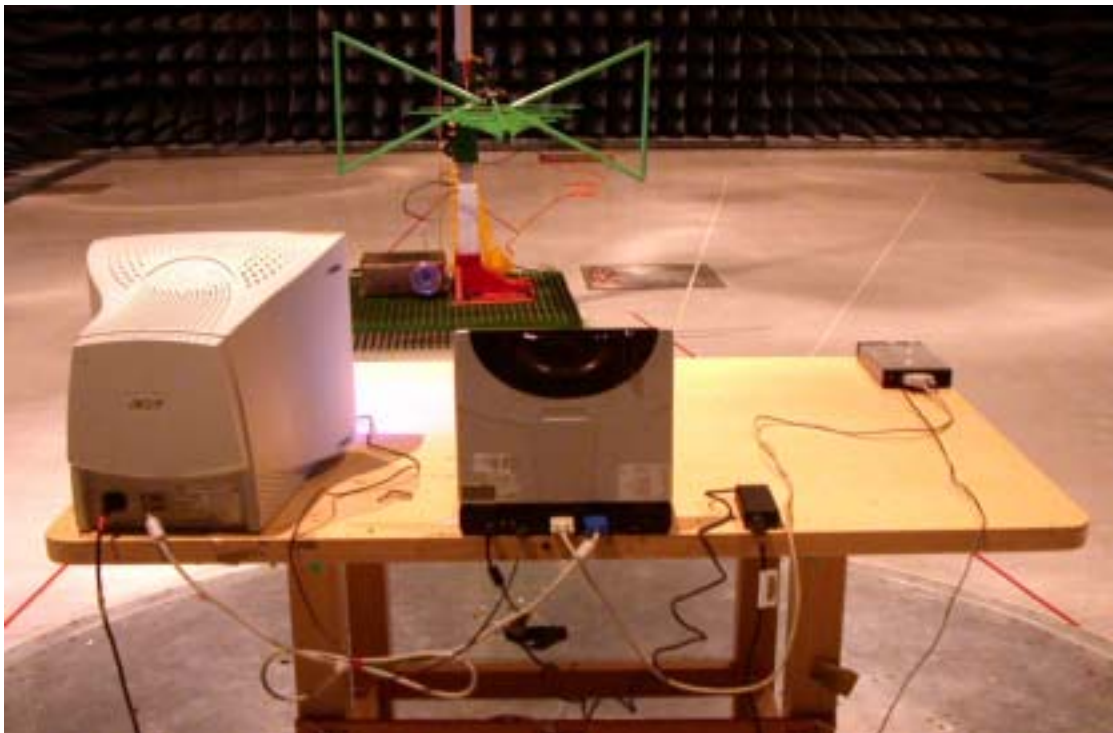

7.8 Appendix H: Antenna Spec.

Please refer to the attached file.