

PART 1 (for 802.11abg WLAN)

Test Report

for

FCC Part 15 Subpart B & C & E

of

Product Name

Notebook Personal Computer

(with Intel PRO/Wireless 2915ABG Network Connection
and USI USB Bluetooth Module BM-GD-BR-50 inside)

Model

IX600

(Brand: Itronix)

Applied by:

Itronix Corporation
801 South Stevens Street
Spokane Washington, 99204
U. S. A.

Test Performed by:

International Standards Laboratory

No. 120, Lane 180, San Ho Tsuen, Hsin Ho Rd.
Lung-Tan Hsiang, Tao Yuan County 325
Taiwan, R.O.C.
Tel:(03)407-1718 Fax:(03)407-1738

Report Number: ISL-05LR019FC

Issue Date: 2005/08/19

HC LAB:NVLAP:200234-0;VCCI: R-341,C-354;NEMKO:ELA 113a,113c;BSMI:SL2-IN-E-0037;SL2-R1-E-0037;CNLA:1178

LT LAB:NVLAP:200234-0;VCCI: R-1435,C-1440;NEMKO:ELA 113b,113d;BSMI:SL2-IN-E-0013;CNLA:0997

ISL-T10-R29-1

Contents of Report

1. General..... 1

1.1 Certification of Accuracy of Test Data 1

2. Test Results Summary 2

3. Description of Equipment Under Test (EUT) 3

4. TEST RESULTS (802.11a) 7

4.1 Maximum Peak Output Power [Section 15.407 (a)(1)(2)(3)] 7

4.1.1 Test Procedure 7

4.1.2 Test Setup 7

4.1.3 Test Data: (Normal Mode) 7

4.2 Peak Power Spectral Density [Section 15.407(a)(1)(2)(3)] 11

4.2.1 Test Procedure 11

4.2.2 Test Setup 11

4.2.3 Test Data: (Normal Mode) 11

4.3 Peak Power Excursion Measurement [Section 15.407(a)(6)] 15

4.3.1 Test Procedure 15

4.3.2 Test Setup 15

4.3.3 Test Data: (Normal Mode) 15

4.4 Powerline Conducted Emissions [Section 15.207 & 15.407 (b)(5)] 19

4.4.1 EUT Configuration 19

4.4.2 Test Procedure 19

4.4.3 EMI Receiver/Spectrum Analyzer Configuration (for the frequencies tested) 19

4.4.4 Test Data: 20

4.5 Radiated Emission Measurement [Section 15.209 & 15.407(b)(5)] 22

4.5.1 EUT Configuration 22

4.5.2 Test Procedure 22

4.5.3 EMI Receiver/Spectrum Analyzer Configuration 22

4.5.4 Test Data (30MHz – 1GHz) 23

4.5.5 Test Data (1GHz – 40 GHz, Transmitting) 24

4.6 Band Edge Measurement (Section 15.407 (b) (1) (2)) 30

4.6.1 Test Procedure (Conducted) 30

4.6.2 Test Setup (Conducted) 30

4.6.3 Test Data (conducted): 30

4.6.4 Bandedge Measurement Test Procedure (Radiated) 33

4.6.5 Test Setup (Radiated) 34

4.6.6 Test Data (Radiated): 35

4.7 RF Exposure Measurement [Section 15.407(f)(4) & 1.1307(b)] 40

4.8 Frequency Stability [Section 15.407(g)] 41

4.8.1 Limits of Frequency Stability Measurement 41

4.8.2 Test Procedure 41

4.8.3 Test Setup 41

4.8.4 Test Data 42

5. TEST RESULTS (802.11b) 43

5.1 Powerline Conducted Emissions [Section 15.207] 43

5.1.1 EUT Configuration 43

5.1.2 Test Procedure 43

5.1.3 EMI Receiver/Spectrum Analyzer Configuration (for the frequencies tested)43

5.1.4 Test Data:..... 44

5.2 Bandwidth for DSSS [Section 15.247 (a)(2)]..... 46

5.2.1 Test Procedure 46

5.2.2 Test Setup 46

5.2.3 Test Data:..... 46

5.3 DSSS Maximum Peak Output Power [Section 15.247 (b)(1)]..... 49

5.3.1 Test Procedure 49

5.3.2 Test Setup 49

5.3.3 Test Data 49

5.4 Radiated Emission Measurement [Section [15.247(c)(4)] 50

5.4.1 EUT Configuration 50

5.4.2 Test Procedure 50

5.4.3 EMI Receiver/Spectrum Analyzer Configuration (for the frequencies tested)50

5.4.4 Test Data (30MHz – 1GHz): 51

5.4.5 Test Data (1GHz – 25 GHz) 52

5.5 Band Edge Measurement..... 55

5.5.1 Test Procedure (Conducted) 55

5.5.2 Test Setup (Conducted) 55

5.5.3 Test Data:..... 55

5.5.4 Test Procedure (Radiated) 57

5.5.5 Test Setup (Radiated)..... 57

5.5.6 Test Data 58

5.6 RF Exposure Measurement [Section 15.247(b)(4) & 1.1307(b)]..... 61

5.7 DSSS Peak Power Spectral Density [Section 15.247(d)]..... 62

5.7.1 Test Procedure 62

5.7.2 Test Setup 62

5.7.3 Test Data 62

6. TEST RESULTS (802.11g)..... 65

6.1 Powerline Conducted Emissions [Section 15.207] 65

6.1.1 EUT Configuration 65

6.1.2 Test Procedure 65

6.1.3 EMI Receiver/Spectrum Analyzer Configuration (for the frequencies tested)65

6.1.4 Test Data:..... 66

6.2 Bandwidth for DSSS [Section 15.247 (a)(2)]..... 68

6.2.1 Test Procedure 68

6.2.2 Test Setup 68

6.2.3 Test Data:..... 68

6.3 DSSS Maximum Peak Output Power [Section 15.247 (b)(1)]..... 71

6.3.1 Test Procedure 71

6.3.2 Test Setup 71

6.3.3 Test Data 71

6.4 Radiated Emission Measurement [Section [15.247(c)(4)] 72

6.4.1 EUT Configuration 72

6.4.2 Test Procedure 72

6.4.3 EMI Receiver/Spectrum Analyzer Configuration (for the frequencies tested) 72

6.4.4 Test Data (30MHz – 1GHz): 73

6.4.5 Test Data (1GHz – 25 GHz) 74

6.5 Band Edge Measurement..... 77

6.5.1 Test Procedure (Conducted) 77

6.5.2 Test Setup (Conducted) 77

6.5.3 Test Data:..... 77

6.5.4 Test Procedure (Radiated) 79

6.5.5 Test Setup (Radiated)..... 79

6.5.6 Test Data 80

6.6 RF Exposure Measurement [Section 15.247(b)(4) & 1.1307(b)]..... 83

6.7 DSSS Peak Power Spectral Density [Section 15.247(d)]..... 84

6.7.1 Test Procedure 84

6.7.2 Test Setup 84

6.7.3 Test Data 84

7. Appendix 87

7.1 Appendix A: Measurement Procedure for Power line Conducted Emissions..... 87

7.2 Appendix B: Test Procedure for Radiated Emissions 88

7.3 Appendix C: Test Equipment 89

7.3.1 Test Equipment List..... 89

7.3.2 Software for Controlling Spectrum/Receiver and Calculating Test Data..... 89

7.4 Appendix D: Layout of EUT and Support Equipment 90

7.4.1 General Conducted Test Configuration 90

7.4.2 General Radiation Test Configuration 91

7.5 Appendix E: Description of Support Equipment..... 92

7.5.1 Description of Support Equipment 92

7.5.2 Software for Controlling Support Unit 93

7.5.3 I/O Cable Condition of EUT and Support Units..... 94

7.6 Appendix F: Accuracy of Measurement..... 95

7.7 Appendix G: Photographs of EUT Configuration Test Set Up 97

7.8 Appendix H: Antenna Spec. 100

1. General

1.1 Certification of Accuracy of Test Data

Standards: CFR 47 Part 15 Subpart B Class B
 CFR 47 Part 15 Subpart C (Section 15.247)
 CFR 47 Part 15 Subpart E (Section 15.407)

Test Procedure: ANSI C63.4:2003

Equipment Tested: Notebook Personal Computer

Model: IX600

Applied by: Itronix Corporation

Sample received Date: 2005/07/11

Final test Date : 2005/08/01-2005/08/17

Test Result PASS

Test Site: Chamber 02, Conduction 02

Temperature Refer to each site test data

Humidity: Refer to each site test data



Test Engineer: Mailes Hsieh

All the tests in this report have been performed and recorded in accordance with the standards described above and performed by an independent electromagnetic compatibility consultant, International Standards Laboratory.

The test results contained in this report accurately represent the measurements of the characteristics and the energy generated by sample equipment under test at the time of the test. The sample equipment tested as described in this report is in compliance with the limits of above standards.

Approve & Signature



 Eddy Hsiung/Director

Test results given in this report apply only to the specific sample(s) tested under stated test conditions. This report shall not be reproduced other than in full without the explicit written consent of ISL. This report totally contains 104 pages, including 1 cover page , 3 contents page, and 100 pages for the test description. This report must not be use to claim product endorsement by NVLAP or any agency of the U.S. Government.

This test data shown below is traceable to NIST or national or international standard. International Standards Laboratory certifies that no party to this application has been denied the FCC benefits pursuant to Section 5301 of the Anti-Drug Abuse Act of 1988, 21 U.S.C. 853(a).

2. Test Results Summary

The 802.11b functions of EUT has been tested according to the FCC regulations listed below:

Tested Standards: 47 CFR Part 15 Subpart C			
Standard Section	Test Type	Result	Remarks
15.207	AC Power Line Emissions	Pass	
15.247(a)(2)	Spectrum Bandwidth Of DSSS device	Pass	
15.247(b)	Max. Peak Output Power	Pass	
15.247(c)	Radiated Emissions 30MHz – 25 GHz	Pass	
15.247 (c)	Band Edge Measurement	Pass	
15.247(b)(4)	Radiation Exposure	Pass	MPE report attached
15.247 (d)	Power Spectral Density	Pass	

The 802.11g functions of EUT has been tested according to the FCC regulations listed below:

Tested Standards: 47 CFR Part 15 Subpart C			
Standard Section	Test Type	Result	Remarks
15.207	AC Power Line Emissions	Pass	
15.247(a)(2)	Spectrum Bandwidth Of DSSS device	Pass	
15.247(b)	Max. Peak Output Power	Pass	
15.247(c)	Radiated Emissions 30MHz – 25 GHz	Pass	
15.247 (c)	Band Edge Measurement	Pass	
15.247(b)(4)	Radiation Exposure	Pass	MPE report attached
15.247 (d)	Power Spectral Density	Pass	

The 802.11a functions of EUT has been tested to the FCC regulations listed below:

Tested Standards: 47 CFR Part 15 Subpart E			
Standard Section	Test Type	Result	Remarks
15.407 (a)(1)(2)(3)	Peak Transmit Power	Pass	
15.407 (a)(1)(2)(3)	Peak Power Spectral Density	Pass	
15.407 (a)(6)	Peak Power Excursion	Pass	
15.407 (b)(5)	AC Power Line Emissions	Pass	
15.407 (b)(5)	Radiated Emissions 30MHz – 40 GHz	Pass	
15.407(f)	Radiation exposure	Pass	MPE report attached
15.407 (g)	Frequency Stability	Pass	

3. Description of Equipment Under Test (EUT)

EUT

Description:	Notebook Personal Computer (with Intel PRO/Wireless 2915ABG Network Connection and USI USB Bluetooth Module BM-GD-BR-50 inside)
Condition:	Pre-Production
Model:	IX600
FCC ID:	KBCIX600-IWLBT
Serial Number:	N/A
Brand:	Itronix
Wireless LAN Module:	Intel, Model: WM3B2915ABG
Frequency Range 802.11a:	5150~5350 MHz, 5725~5825 MHz
Frequency Range 802.11b/g:	2400 - 2483.5 MHz
Support channel:	
802.11a Normal mode	12 Channels
802.11b	11 Channels
802.11g	11 Channels
Modulation Skill:	
802.11a Normal mode	OFDM (6 Mbps – 54 Mbps)
802.11b	DBPSK(1Mbps), DQPSK(2Mbps), CCK(5.5/11Mbps)
802.11g	OFDM (6M - 54Mbps)
Antennas Type:	
Main antenna	PIFA(P/N: 25.90215.001), made by Wistron NeWeb Corp.
Aux antenna	PIFA(P/N: 25.90216.001), made by Wistron NeWeb Corp.
Antenna Connected:	Connected to RF connector on the PCB of the 802.11a/b/g WLAN Adapter. The user is not possible to change the antenna without disassembling the notebook computer.
Antenna peak Gain:	
Main antenna	2.41 dBi (11b/g), 2.26 dBi (11a)
Aux antenna	1.53 dBi (11b/g), 0.59 dBi (11a)
Power Type of LAN module:	3.3V DC from Notebook PC

The channel and the operation frequency of 802.11b and 802.11g is listed below:

Channel	Frequency(MHz)	Channel	Frequency(MHz)
01	2412	07	2442
02	2417	08	2447
03	2422	09	2452
04	2427	10	2457
05	2432	11	2462
06	2437		

The channel and the operation frequency of 802.11a Normal Mode is listed below:

Channel	Frequency(MHz)	Channel	Frequency(MHz)
01	5180	07	5300
02	5200	08	5320
03	5220	09	5745
04	5240	10	5765
05	5260	11	5785
06	5280	12	5805

Bluetooth Module: USI, Model: BM-GD-BR-50

Frequency Range: 2402 ~ 2480 MHz

Support channel: 79 Channels

Modulation Skill: GFSK (1Mbps)

Antennas Type: AccuWave Antenna made by Etenna Corp.

Model No.: EA2400

Antenna Connected: The antenna is mounted to the PCB of the Bluetooth Module.
The user is not possible to change the antenna .

Antenna peak Gain: 3.0 dBi

Power Type of Bluetooth module: 3.3V DC from Notebook PC

The channels and the operation frequency of Bluetooth is listed below:

Channel	Frequency(MHz)	Channel	Frequency(MHz)
00	2402	01	2403
02	2404	03	2405
04	2406	05	2407
.....			
75	2477	76	2478
77	2479	78	2480

Power Supply Type: Auto Switching AC Adapter
Delta (Model: SADP-65KB D) or
Liteon(Model: PA-1700-02)

CPU Type: Pentium M Dothan 1.8GHz

Hard Disk Device: HGST (Model: HTS424040M9AT00)

DDR: 512MB
Hynix (Model: HYMP564S64P6-C4) or
Micron (Model: MT8HTF6464HDY-53EA3) or
1024 MB
Infineon (Model: HYS64T128021HDL-3.7-A)

DVD-Multi: TEAC (Model: DW-224E-B83)

DVD-RAM: TEAC(Model: DV-W28EA)

MDC modem: Liteon (Model: MDC-003#/A1A)

DC-In: one

VGA Port: one

USB2.0 Connector: two

LAN Connector: one

Modem Port: one

PCIMCIA Connector: one

Docking Connector: one

Line in: one

Line out: one

RS-232 Port: one

Smart Connector : one

Express Connector : one

Battery: Simplo 6 cell or Simplo 9 cell

LCD: Enhanced 14.1" XGA TFT (Model: LTD121EC5S)

Inverter: Sumida (Model : IV12087/T)

Maximum display Resolution: 1024X786 Non-interlaced

EMI Noise Source:
Crystal: 14.318M (X1),32.768M (X2),32.768M(X3), 24.576M(X4),25M(X5),24.576M(X6)
Clock Generator: U44

EMI Solution:
1. add two gaskets on heatsink
2. add seven gaskets on HDD's DOOR

4. TEST RESULTS (802.11a)

4.1 Maximum Peak Output Power [Section 15.407 (a)(1)(2)(3)]

4.1.1 Test Procedure

The transmitter output of EUT was connected to the peak power analyzer.

4.1.2 Test Setup

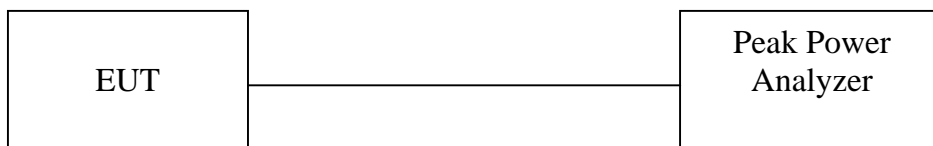

Frequency Band	Limit
5.15 – 5.25 GHz	The lesser of 50mW (17dBm) or 4dBm+10logB
5.25 – 5.35GHz	The lesser of 250mW (24dBm) or 11dBm+10logB
5.725-5.825GHz	The lesser of 1W (30dBm) or 17dBm+10logB

Note: B is the 26dB emission bandwidth in MHz

4.1.3 Test Data: (Normal Mode)

Maximum Peak Output Power

Temperature ():24

Test Engineer:Mailles Hsieh

Humidity (%):54

Chennel	Frequency (Mhz)	Peak Power Output (dBm)	26 dBc BW/Limit Mhz/dBm	The lesser Limit (dBm)	Pass/Fail
1	5180	12.72	24.12/ 17.82	17	Pass
4	5240	12.31	24.39/ 17.87	17	Pass
5	5260	18.38	25.02/ 24.98	24	Pass
8	5320	20.03	24.93/ 24.97	24	Pass
9	5745	17.34	24.48/ 30.89	30	Pass
12	5805	17.83	24.21/ 30.84	30	Pass

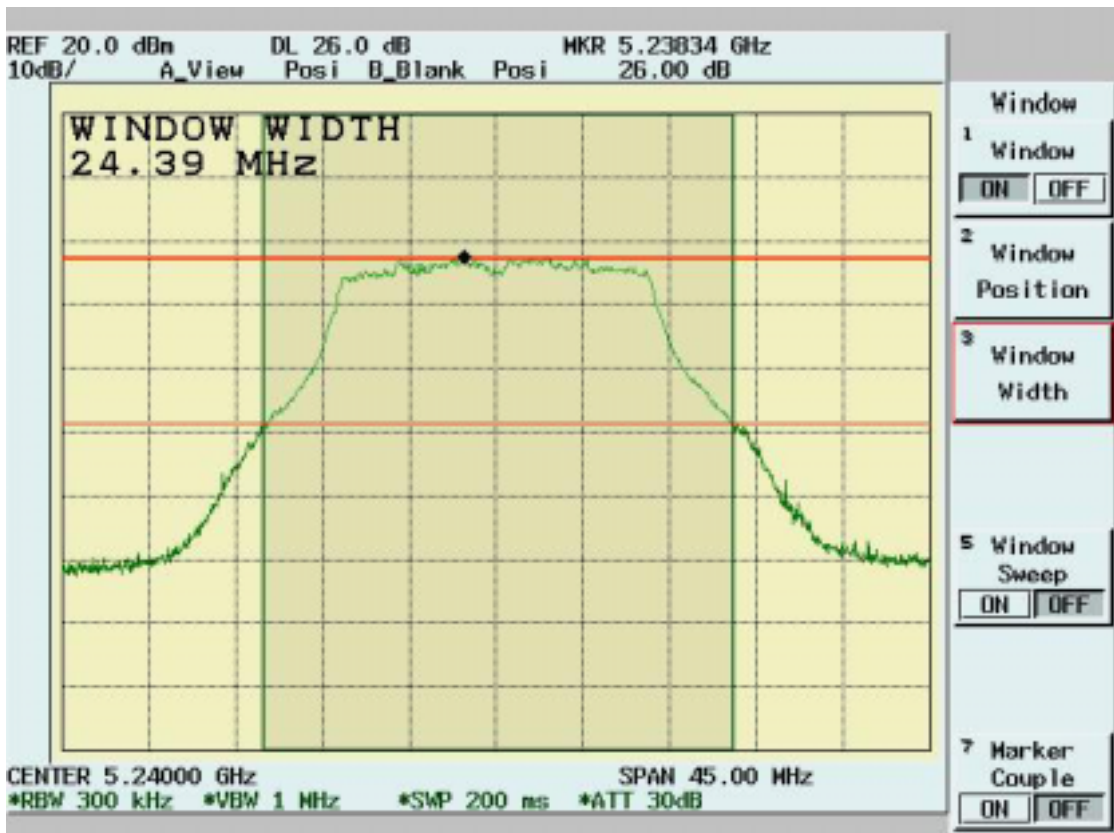
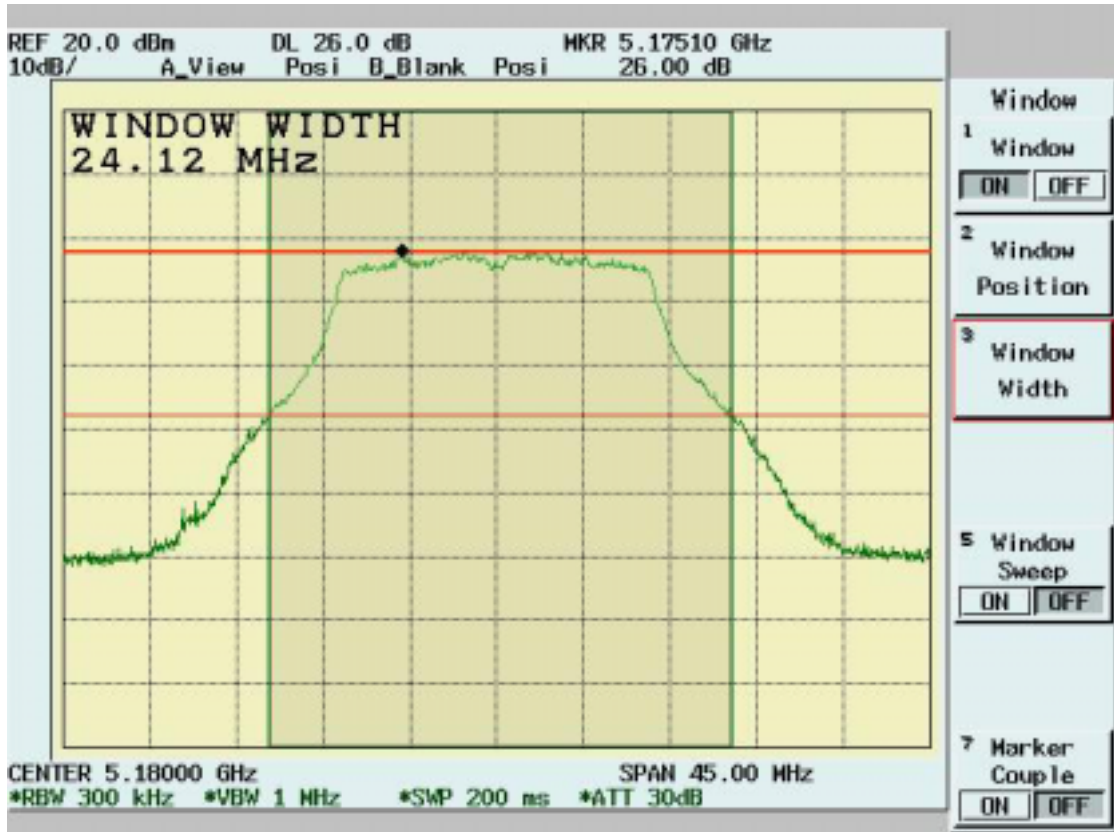

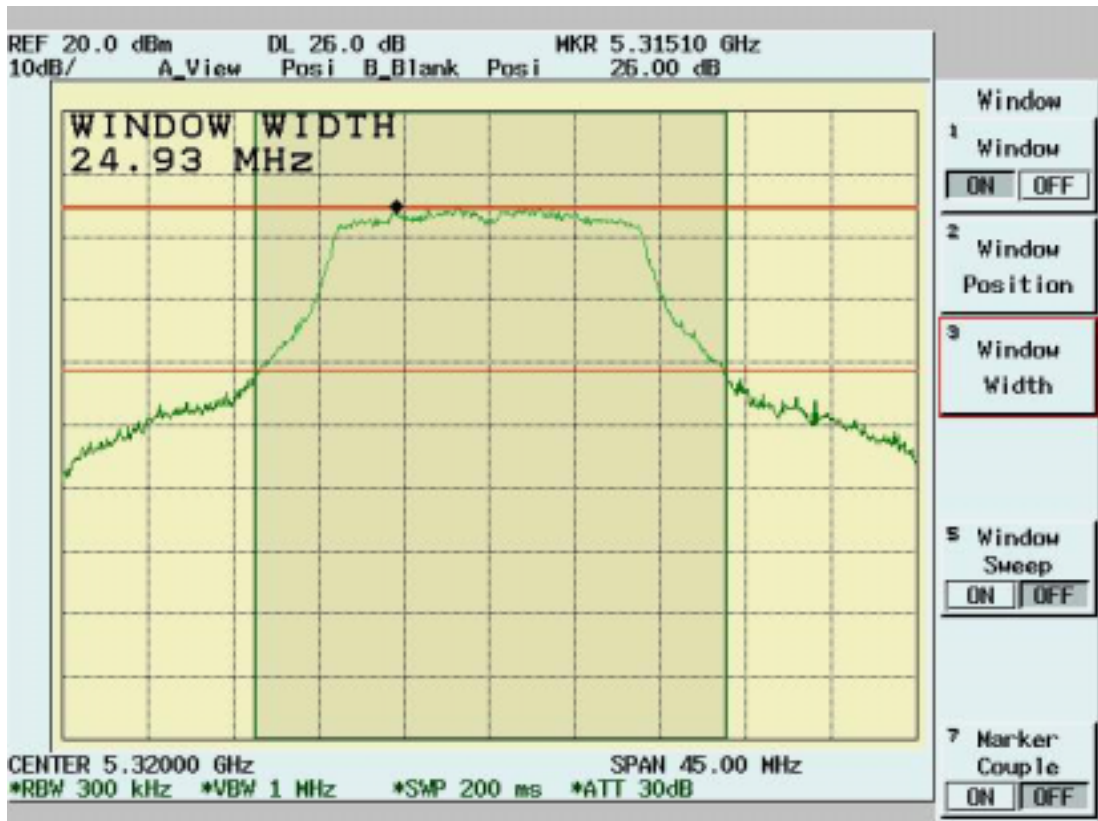
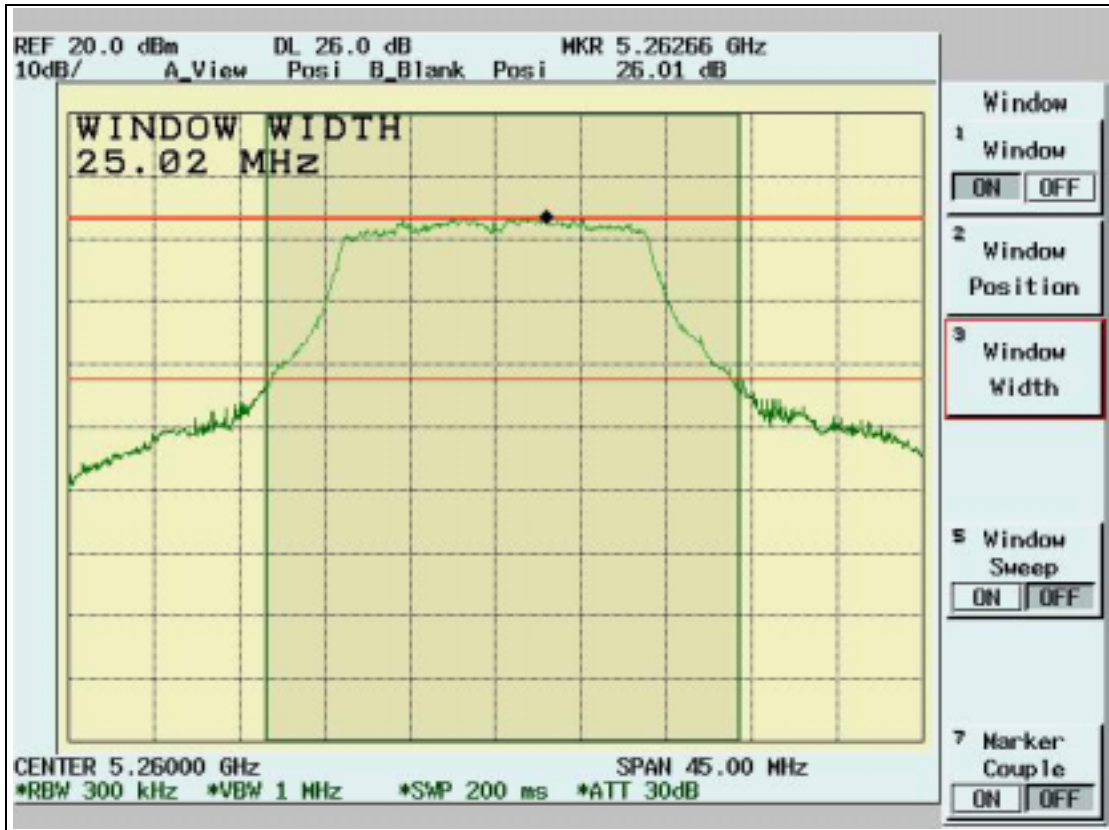

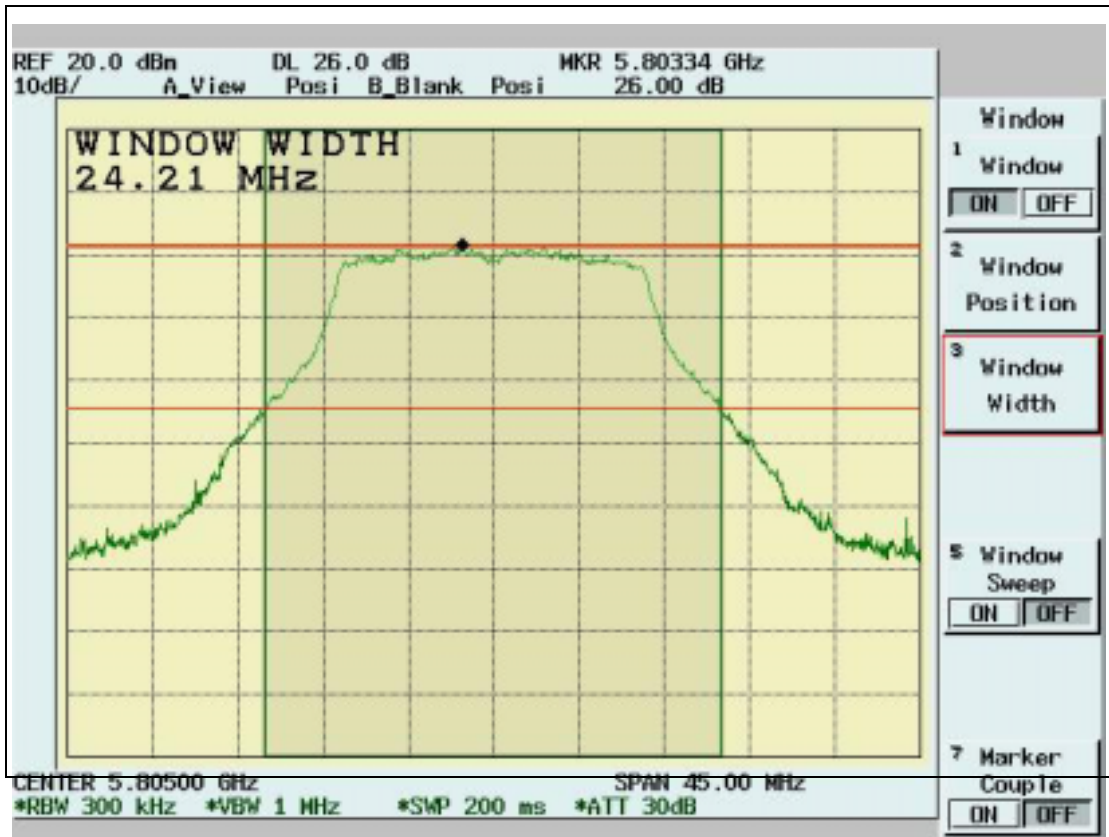

4.2 Peak Power Spectral Density [Section 15.407(a)(1)(2)(3)]

4.2.1 Test Procedure

1. The Transmitter output of EUT was connected to the spectrum analyzer.
 Equipment mode: Spectrum analyzer
 Detector function: Peak mode
 SPAN: 30MHz or 50MHz
 RBW: 1MHz
 VBW: 3MHz
 Sweep time: 30 or 50 sec.
 Center frequency: fundamental frequency tested
2. Peak search was read to the peak power after maximum hold function is completed.

4.2.2 Test Setup



4.2.3 Test Data: (Normal Mode)

Maximum Peak Output Power Density

Temperature ():24

Test Engineer:Mailles Hsieh

Humidity (%):54

Channel	Frequency (Mhz)	Spectrum Reading (dBm)	Cable Loss(dB)	Peak Power Output dBm/MHz)	Limit (dBm/Mhz)	Pass/Fail
1	5180	2.41	1.20	3.61	4	Pass
4	5240	2.34	1.20	3.54	4	Pass
5	5260	8.16	1.20	9.36	11	Pass
8	5320	9.49	1.20	10.69	11	Pass
9	5745	6.27	1.20	7.47	17	Pass
12	5805	6.51	1.20	7.71	17	Pass

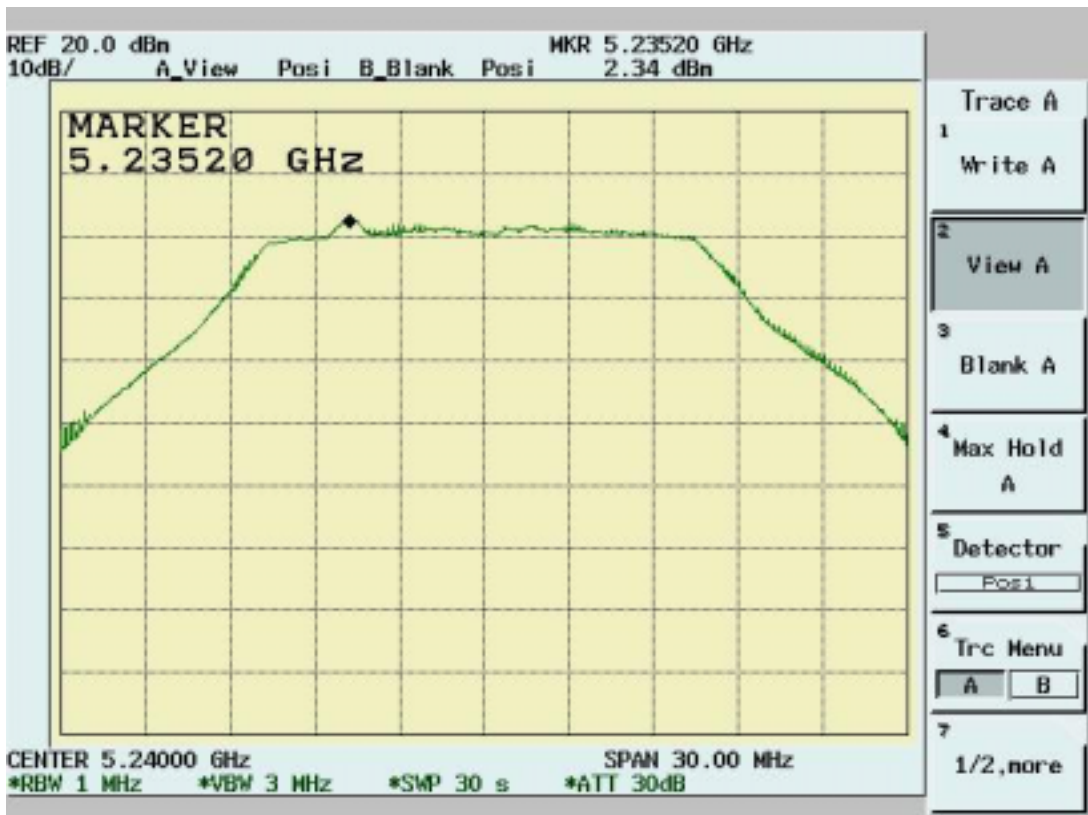

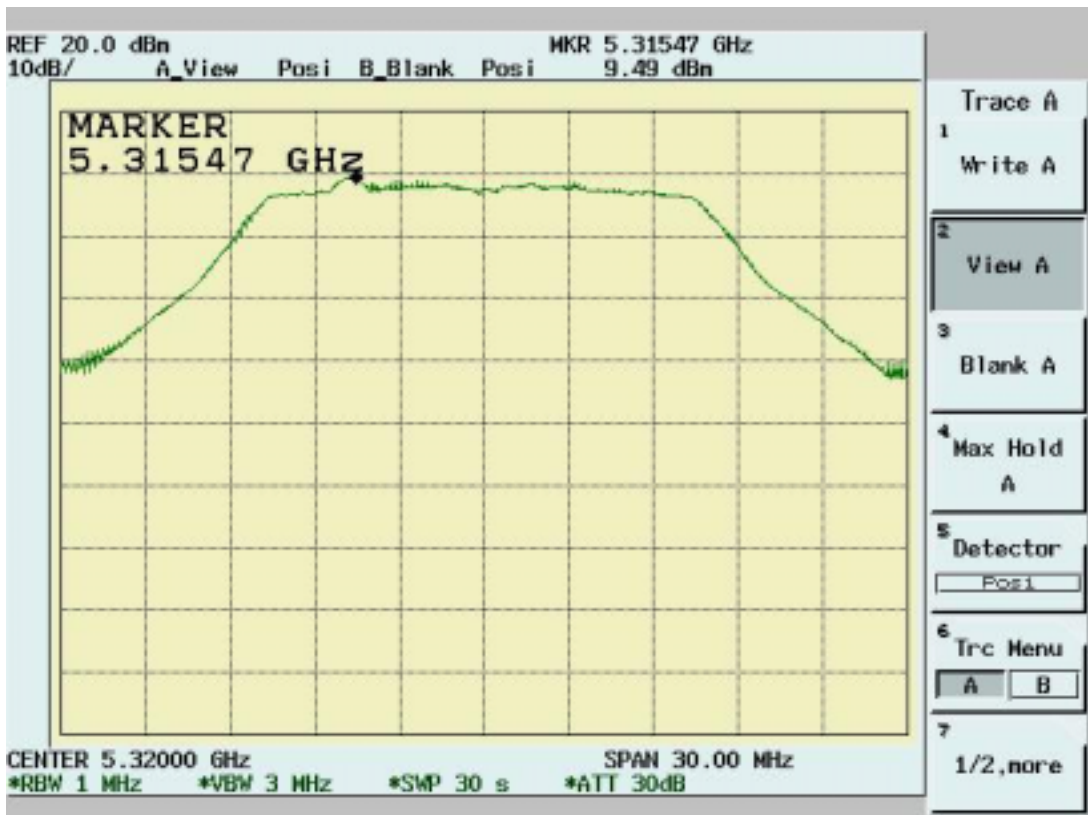



4.3 Peak Power Excursion Measurement [Section 15.407(a)(6)]

4.3.1 Test Procedure

1. The Transmitter output of EUT was connected to the spectrum analyzer.
1. Frequency SPAN of Spectrum: 30MHz or 50MHz.
2. Trace 1 : RBW: 1MHz, VBW: 3MHz. Using positive detector and Max -hold
3. Trace 2 : RBW: 1MHz, VBW: 3MHz. Using Sample detector and Max-hold
4. Record the largest difference between Trace 1 and Trace 2.

4.3.2 Test Setup

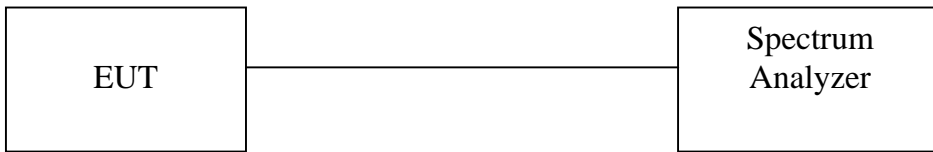

4.3.3 Test Data: (Normal Mode)

Peak Power Excursion

Temperature ():24

Test Engineer:Mailes Hsieh

Humidity (%):54

Channel	Frequency (Mhz)	Peak Power Excursion (dBm)	Limit (dBm)	Pass/Fail
1	5180	12.39	13	Pass
4	5240	12.70	13	Pass
5	5260	11.05	13	Pass
8	5320	12.09	13	Pass
9	5745	11.12	13	Pass
12	5805	11.77	13	Pass

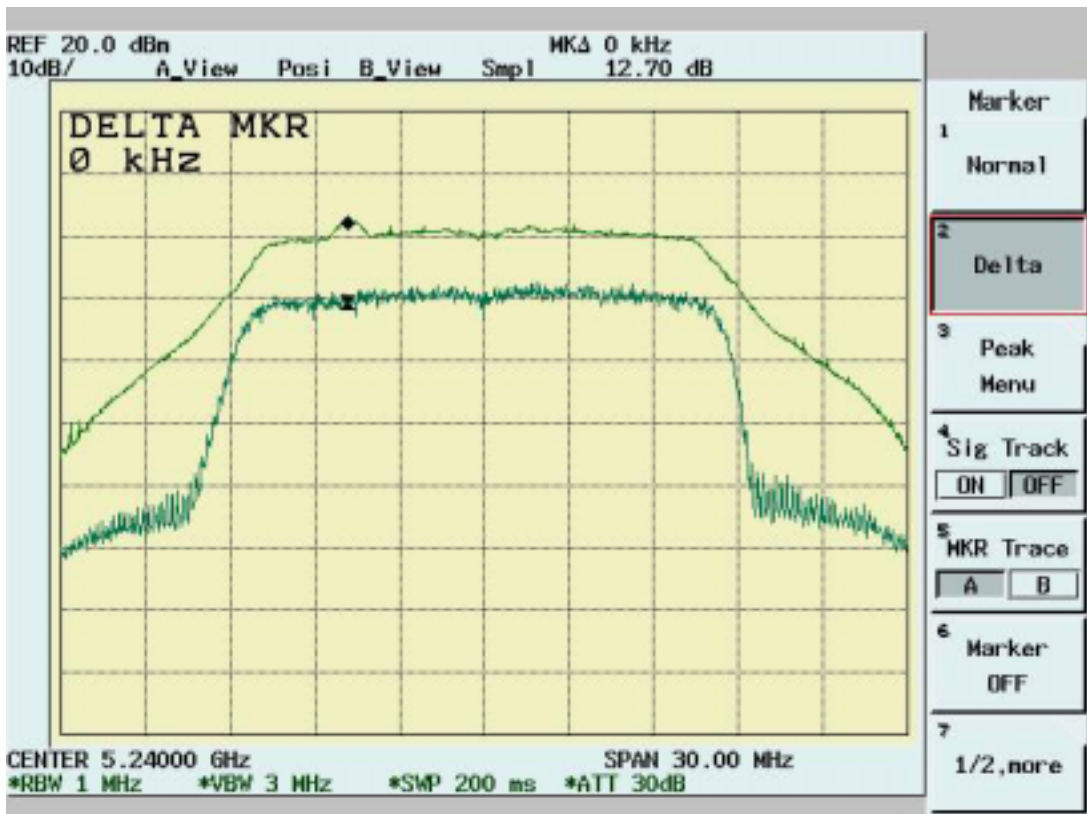
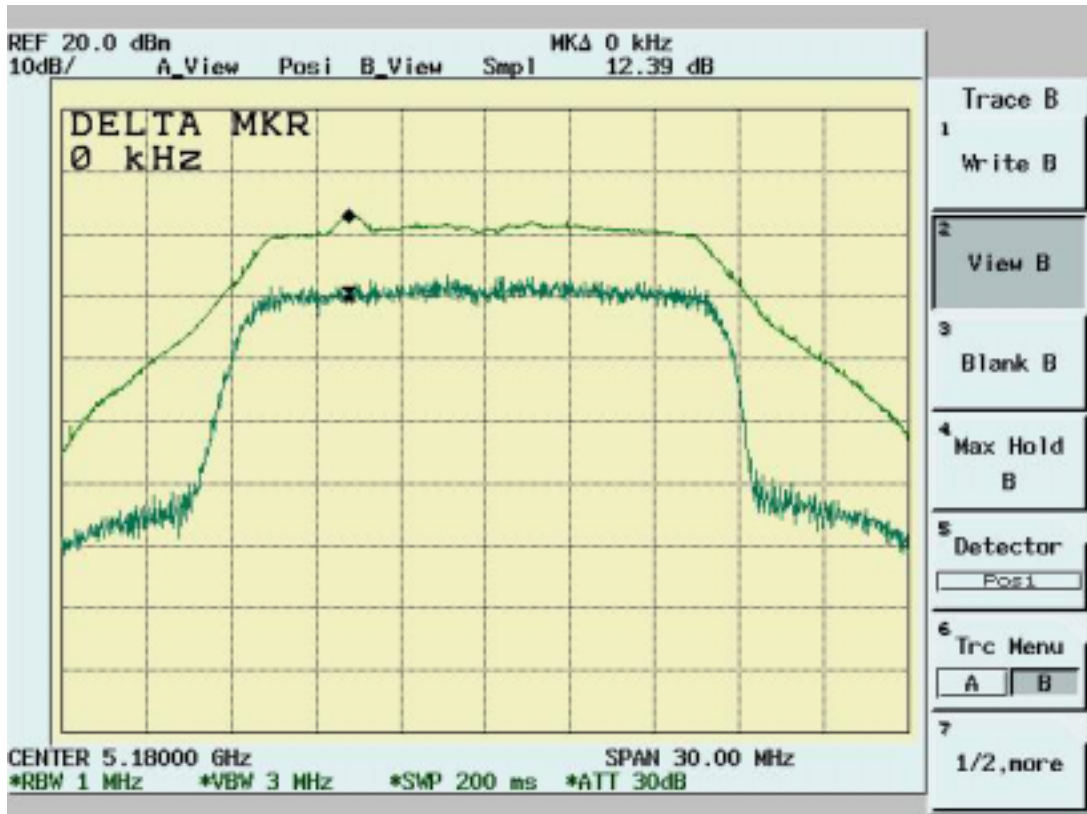

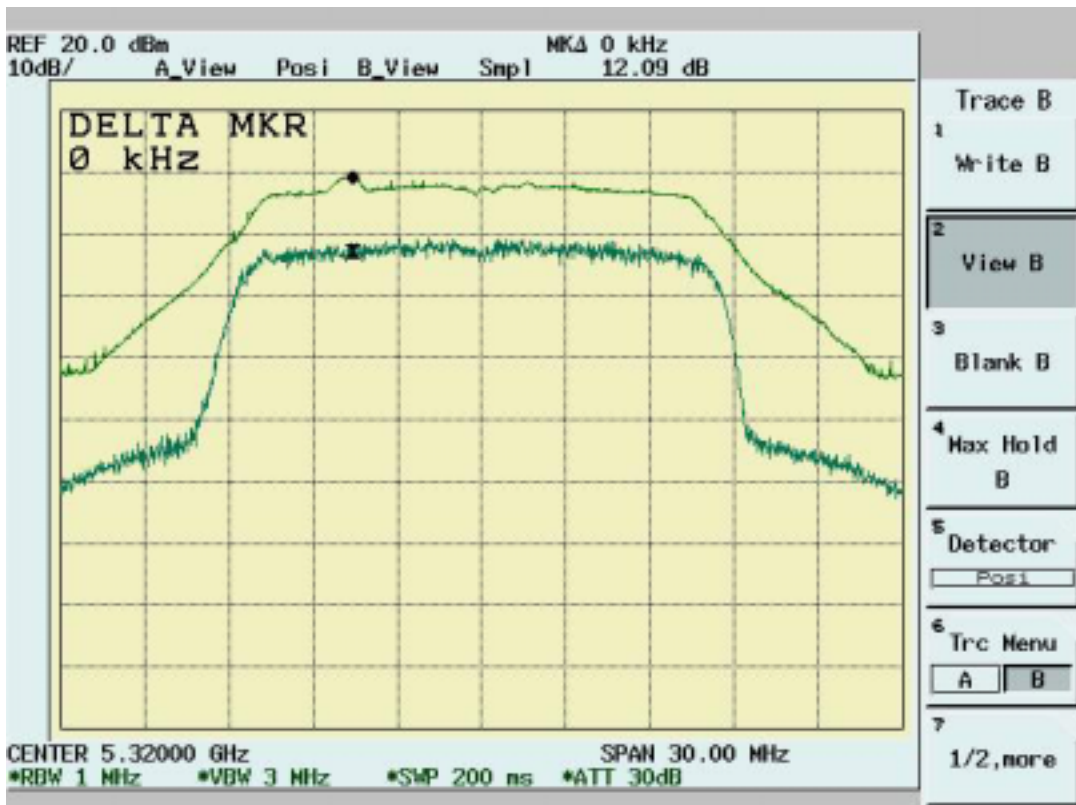

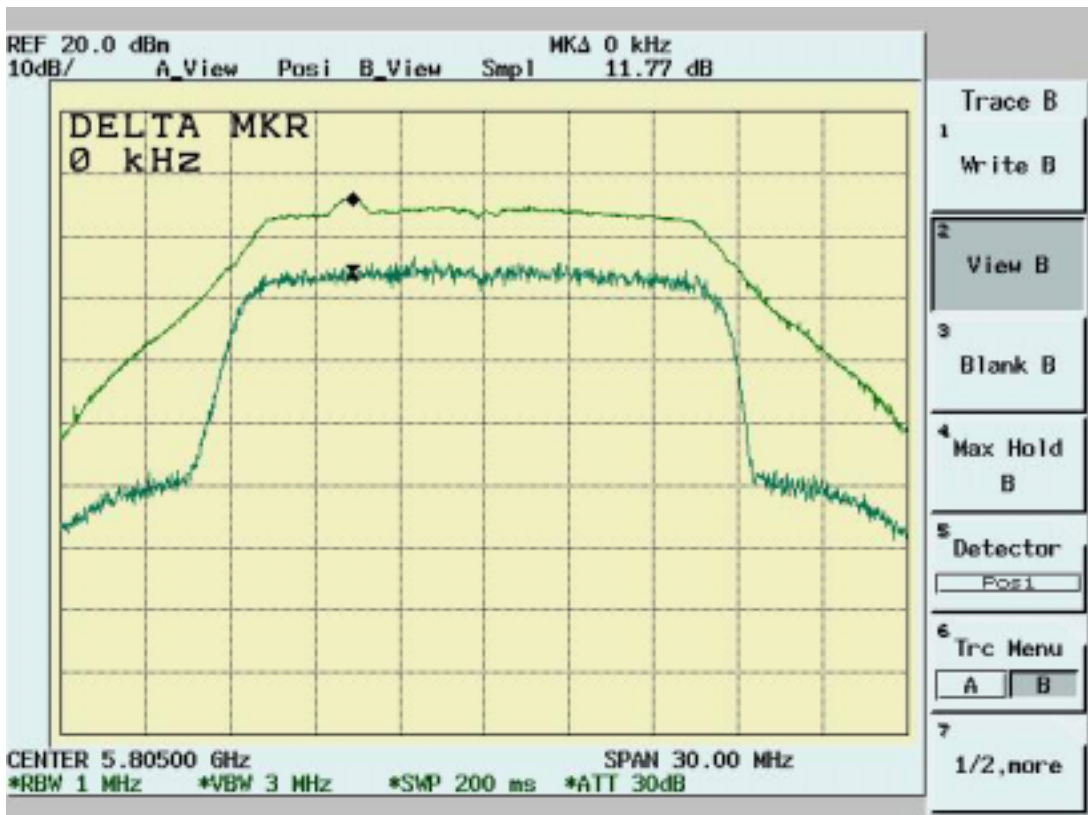
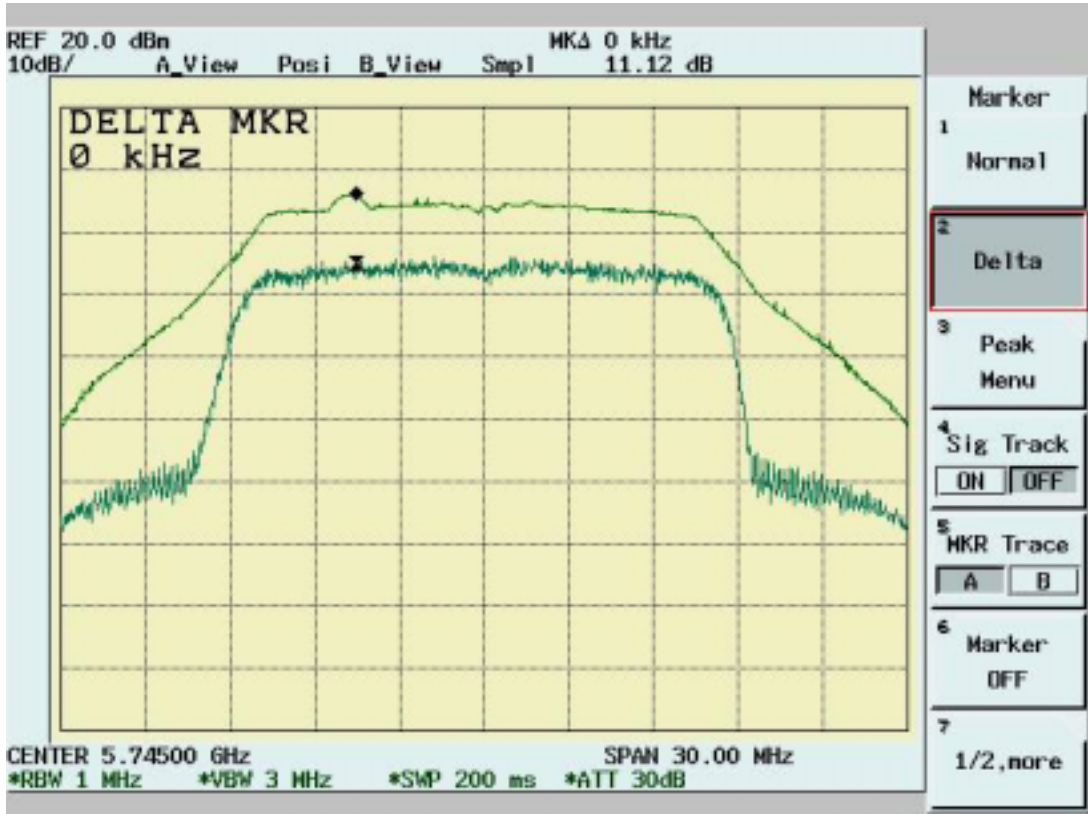

4.4 Powerline Conducted Emissions
[Section 15.207 & 15.407 (b)(5)]

4.4.1 EUT Configuration

The EUT was set up on the non-conductive table that is 1.0 by 1.5 meter, 80cm above ground. The wall of the shielded room was located 40cm to the rear of the EUT.

Power to the EUT was provided through the LISN. The impedance vs. frequency characteristic of the LISN is complied with the limit used.

Both lines (neutral and hot) were connected to the LISN in series at testing. A coaxial-type connector which provides one 50 ohms terminating impedance was provided for connecting the test instrument. The excess length of the power cord was folded back and forth at the center of the lead so as to form a bundle not exceeding 40cm in length.

Any changes made to the configuration, or modifications made to the EUT, during testing are noted in the following test record.

If the EUT is a Personal Computer or a peripheral of personal computer, and the personal computer has an auxiliary AC outlet which can be used for providing power to an external monitor, then all measurements will be made with the monitor power from first the computer-mounted AC outlet and then a floor-mounted AC outlet.

4.4.2 Test Procedure

The system was set up as described above, with the EMI diagnostic software running. The main power line conducted EMI tests were run on the hot and neutral conductors of the power cord and the results were recorded. The effect of varying the position of the interface cables has been investigated to find the configuration that produces maximum emission.

At the frequencies where the peak values of the emissions were higher than 6dB below the applicable limits, the emissions were also measured with the quasi-peak detectors. At the frequencies where the quasi-peak values of the emissions were higher than 6dB below the applicable average limits, the emissions were also measured with the average detectors.

The highest emissions were analyzed in details by operating the spectrum analyzer in fixed tuned mode to determine the nature of the emissions and to provide information which could be useful in reducing their amplitude.

4.4.3 EMI Receiver/Spectrum Analyzer Configuration (for the frequencies tested)

Frequency Range:	150 KHz--30MHz
Detector Function:	Quasi-Peak/Average
Bandwidth (RBW):	9KHz

4.4.4 Test Data:

Power Line Conducted Emissions (Hot)

Operator:MailesHsieh
 Temperature(C):25
 Humidity(%):57

Frequency	LISNLoss	CableLoss	QPCorrt.	QPLimit	QPMargin	AVECorrct.	AVELimit	AVEMargi n
MHz	(dB)	(dB)	Amp.(dBuV)	(dBuV)	(dB)	Amp.(dBuV)	(dBuV)	(dB)
0.50013	0.12	0.07	32.84	56.00	-23.16	31.55	46.00	-14.45
0.64341	0.14	0.07	30.95	56.00	-25.05	29.03	46.00	-16.97
0.7193	0.15	0.07	28.93	56.00	-27.07	27.08	46.00	-18.92
0.86178	0.18	0.07	31.40	56.00	-24.60	29.48	46.00	-16.52
0.9313	0.19	0.07	30.57	56.00	-25.43	28.07	46.00	-17.93
1.0779	0.29	0.07	29.58	56.00	-26.42	26.84	46.00	-19.16
1.11671	0.29	0.07	24.56	56.00	-31.44	2.85	46.00	-43.15
2.79315	0.20	0.11	31.82	56.00	-24.18	22.08	46.00	-23.92
2.86564	0.20	0.11	34.92	56.00	-21.08	24.94	46.00	-21.06
22.5697	0.85	0.33	48.32	60.00	-11.68	48.16	50.00	-1.84

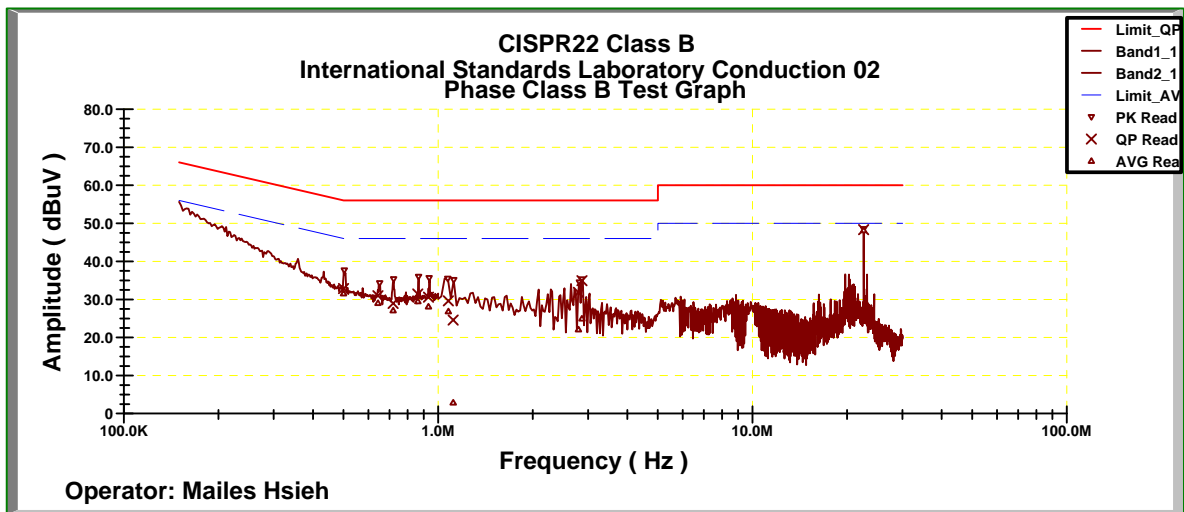

Power Line Conducted Emissions (Neutral)

Operator:MailesHsieh
 Temperature(C):25
 Humidity(%):57

Frequency	LISNLoss	CableLoss	QPCorrt.	QPLimit	QPMargin	AVECorrt.	AVELimit	AVEMargin
MHz	(dB)	(dB)	Amp.(dBuV)	(dBuV)	(dB)	Amp.(dBuV)	(dBuV)	(dB)
0.50155	0.12	0.07	31.96	56.00	-24.04	30.42	46.00	-15.58
0.64428	0.14	0.07	29.28	56.00	-26.72	26.81	46.00	-19.19
0.71793	0.15	0.07	28.54	56.00	-27.46	26.76	46.00	-19.24
0.85901	0.18	0.07	30.65	56.00	-25.35	28.42	46.00	-17.58
0.93126	0.19	0.07	28.28	56.00	-27.72	25.83	46.00	-20.17
1.07578	0.20	0.07	29.81	56.00	-26.19	27.51	46.00	-18.49
2.65024	0.20	0.11	34.55	56.00	-21.45	24.77	46.00	-21.23
2.78998	0.20	0.11	26.82	56.00	-29.18	16.97	46.00	-29.03
2.86603	0.20	0.11	35.56	56.00	-20.44	25.73	46.00	-20.27
22.5694	0.40	0.33	47.70	60.00	-12.30	47.55	50.00	-2.45

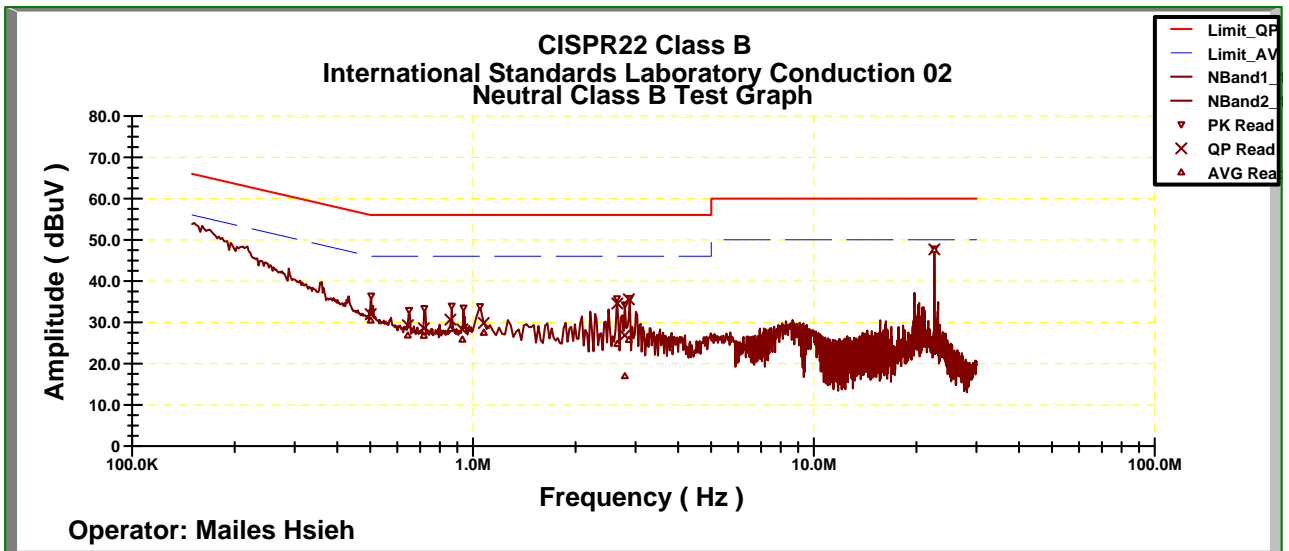

* NOTE: During the test, the EMI receiver was set to Max. Hold then switch the EUT between Main antenna , Aux antenna Channel 1 , 4, 5, 8, 9,12 of Normal Mode and Channel 1, 2, 3,4,5 of Turbo Mode to get the maximum reading of all these channels.
 Margin = Amplitude + Insertion Loss- Limit
 A margin of -8dB means that the emission is 8dB below the limit

4.5 Radiated Emission Measurement [Section 15.209 & 15.407(b)(5)]

4.5.1 EUT Configuration

The equipment under test was set up on the 10 meter chamber with measurement distance of 3 meters. The EUT was placed on a non-conductive table 80cm above ground.

Any changes made to the configuration, or modifications made to the EUT, during testing are noted in the following test record.

4.5.2 Test Procedure

The system was set up as described above, with the EMI diagnostic software running. We found the maximum readings by varying the height of antenna and then rotating the turntable. Both polarization of antenna, horizontal and vertical, are measured.

30M to 1GHz: The highest emissions between 30 MHz to 1000 MHz were also analyzed in details by operating the spectrum analyzer and/or EMI receiver in quasi-peak mode to determine the precise amplitude of the emissions. While doing so, the interconnecting cables and major parts of the system were moved around, the antenna height was varied between one and four meters, its polarization was varied between vertical and horizontal, and the turntable was slowly rotated, to maximize the emission.

1GHz – 40GHz: The highest emissions were also analyzed in details by operating the spectrum analyzer and/or EMI receiver in peak mode to determine the precise amplitude of the emission. While doing so, the interconnecting cables and major parts of the system were moved around, the antenna height was varied between one and four meters, its polarization was varied between vertical and horizontal, and the turntable was slowly rotated, to maximize the emission. During test the EMI receiver and spectrum was setup according to para. 6.5.3.

For the test of 2nd to 10th harmonics frequencies , the equipment setup was also refer to para.6.5.3. The frequencies were tested using Peak mode first, if the test data is higher than the emissions limit, an additional measurement using Average mode will be performed and the average reading will be compared to the limit and record in test report.

4.5.3 EMI Receiver/Spectrum Analyzer Configuration

Frequency Range Tested:	30MHz~1000MHz
Detector Function:	Quasi-Peak Mode
Resolution Bandwidth (RBW):	120KHz
Video Bandwidth (VBW)	1MHz
Frequency Range Tested:	1GHz – 40 GHz
Detector Function:	Peak Mode
Resolution Bandwidth (RBW):	1MHz
Video Bandwidth (VBW)	3MHz
Frequency Range Tested:	30MHz – 40 GHz
Detector Function:	Average Mode
Resolution Bandwidth (RBW):	1MHz
Video Bandwidth (VBW)	10 Hz

4.5.4 Test Data (30MHz – 1GHz) .

30M – 1GHz Open Field Radiated Emissions (Horizontal)

Operator:MailesHsieh
Temperature(C):24
Humidity(%):47

Frequency	RxAmp.	AntFact	CableLoss	PreAmpGain	Corrct.Emi.	Limit	Margin	Ant.Pos.	TablePos
MHz	(dBuV)	(dB/m)	(dB)	(dB)	(dBuV/m)	(dBuV/m)	(dB)	(cm)	(deg)
129.91	25.70	11.40	2.16	0.00	39.26	43.50	-4.24	101.00	352.00
231.76	23.14	9.21	2.95	0.00	35.30	46.00	-10.70	101.00	352.00
257.95	18.67	12.63	3.17	0.00	34.48	46.00	-11.52	101.00	53.00
282.20	19.49	13.09	3.39	0.00	35.97	46.00	-10.03	101.00	352.00
292.87	16.13	13.46	3.49	0.00	33.08	46.00	-12.92	101.00	352.00
331.67	16.97	14.04	3.94	0.00	34.95	46.00	-11.05	101.00	352.00
355.92	17.40	14.49	4.15	0.00	36.04	46.00	-9.96	101.00	302.00
432.55	18.47	16.16	4.69	0.00	39.32	46.00	-6.68	101.00	352.00
633.34	8.55	18.97	6.18	0.00	33.70	46.00	-12.30	101.00	352.00
699.30	9.98	19.00	6.62	0.00	35.59	46.00	-10.41	101.00	352.00

30M – 1GHz Open Field Radiated Emissions (Vertical)

Operator:MailesHsieh
Temperature(C):24
Humidity(%):47

Frequency	RxAmp.	AntFact	CableLoss	PreAmpGain	Corrct.Emi.	Limit	Margin	Ant.Pos.	TablePos
MHz	(dBuV)	(dB/m)	(dB)	(dB)	(dBuV/m)	(dBuV/m)	(dB)	(cm)	(deg)
129.91	24.45	11.40	2.16	0.00	38.01	43.50	-5.49	101.00	77.00
366.59	23.49	14.83	4.22	0.00	42.54	46.00	-3.46	101.00	127.00
430.61	20.55	16.14	4.67	0.00	41.36	46.00	-4.64	101.00	45.00
544.10	11.40	18.65	5.49	0.00	35.53	46.00	-10.47	101.00	28.00
563.50	11.69	18.83	5.63	0.00	36.15	46.00	-9.85	101.00	193.00
630.43	14.44	18.96	6.16	0.00	39.56	46.00	-6.44	101.00	12.00
686.69	8.55	19.00	6.53	0.00	34.08	46.00	-11.92	101.00	12.00
696.39	12.84	19.00	6.60	0.00	38.43	46.00	-7.57	101.00	28.00
699.30	14.62	19.00	6.62	0.00	40.23	46.00	-5.77	101.00	12.00
833.16	6.33	20.43	7.71	0.00	34.47	46.00	-11.53	101.00	209.00

* NOTE: During the pre-test, the EUT has been tested for Channel 1, 4, 5, 8, 9, 12 of Normal Mode and Channel 1, 2, 3, 4, 5 of Turbo mode and transmit from Main and Aux antenna respectively to get all the critical emission frequencies. In the final test all the critical emission frequencies has been tested and the test data are listed above.

Margin=Corrected Amplitude-Limit

Corrected Amplitude = Radiated Amplitude + Antenna Correction Factor + Cable Loss - Pre-Amplifier Gain

A margin of -8dB means that the emission is 8dB below the limit

All frequencies from 30MHz to 1GHz have been tested

International Standards Laboratory

Report Number: 05LR019FC

HC LAB:NVLAP:200234-0;VCCI: R-341,C-354;NEMKO:ELA 113a,113c;BSMI:SL2-IN-E-0037;SL2-R1-E-0037;CNLA:1178

LT LAB:NVLAP:200234-0;VCCI: R-1435,C-1440;NEMKO:ELA 113b,113d;BSMI:SL2-IN-E-0013;CNLA:0997

4.5.5 Test Data (1GHz – 40 GHz, Transmitting) .

1GHz~ 40 GHz (Horizontal), Normal Mode, Channel 1 : 5180 MHz

Operator:MailesHsieh

RBW:1MHz
Humidity(%):47
Temperature(C):26

Frequency MHz	Rx_R. dBuV	Ant_F. dB/m	Cab_L. dB	PreAmpl dB	Emission dBuV/m	Limit dBuV/m	Margin dB	A.Tower cm	T.Table deg
1791.21	48.05pk	29.25	2.45	34.77	44.97pk	54.00av	-9.03	100	57
2877.32	47.34pk	31.05	1.43	34.86	44.95pk	54.00av	-9.05	103	318
3017.58	47.56pk	31.11	1.46	34.79	45.35pk	54.00av	-8.65	103	352
3359.24	49.19pk	31.39	1.64	35.53	46.68pk	54.00av	-7.32	103	265

1GHz~ 40 GHz (Vertical), Normal Mode, Channel 1: 5180 MHz

Operator:MailesHsieh

RBW:1MHz
Humidity(%):47
Temperature(C):26

Frequency MHz	Rx_R. dBuV	Ant_F. dB/m	Cab_L. dB	PreAmpl dB	Emission dBuV/m	Limit dBuV/m	Margin dB	A.Tower cm	T.Table deg
1395.60	51.61pk	26.32	2.22	34.14	46.00pk	54.00av	-8.00	101	85
1837.96	49.75pk	29.64	2.48	34.86	47.01pk	54.00av	-6.99	100	54
2492.51	49.57pk	30.90	1.40	35.20	46.67pk	54.00av	-7.33	101	198
3355.64	47.91pk	31.38	1.63	35.53	45.40pk	54.00av	-8.60	103	266
7469.93	42.81pk	39.85	2.27	36.41	48.52pk	54.00av	-5.48	101	178

Note: “ * ”: Fundamental Frequency

“ pk ”: peak reading

“ av ”: average reading

The Spectrum noise level+Correction Factor<Limit-6 dB

Margin = Corrected Amplitude – Limit

Corrected Amplitude=Radiated Amplitude+Antenna Correction Factor+Cable Loss-Pre-Amplifier Gain

A margin of -8dB means that the emission is 8dB below the limit.

All frequencies from 1GHz to 40 GHz have been tested.

1GHz~ 40 GHz (Horizontal), Normal Mode, Channel 4: 5240 MHz

Operator:MailesHsieh

RBW:1MHz
Humidity(%):47
Temperature(C):26

Frequency	Rx_R.	Ant_F.	Cab_L.	PreAmpl	Emission	Limit	Margin	A.Tower	T.Table
MHz	dBuV	dB/m	dB	dB	dBuV/m	dBuV/m	dB	cm	deg
1399.20	51.16pk	26.34	2.22	34.15	45.56pk	54.00av	-8.44	101	84
1996.20	47.77pk	30.97	2.60	35.17	46.17pk	54.00av	-7.83	100	43
2488.91	49.21pk	30.90	1.42	35.20	46.33pk	54.00av	-7.67	101	197
3359.24	49.84pk	31.39	1.64	35.53	47.33pk	54.00av	-6.67	103	265

1GHz~ 40 GHz (Vertical), Normal Mode, Channel 4: 5240 MHz

Operator:MailesHsieh

RBW:1MHz
Humidity(%):47
Temperature(C):26

Frequency	Rx_R.	Ant_F.	Cab_L.	PreAmpl	Emission	Limit	Margin	A.Tower	T.Table
MHz	dBuV	dB/m	dB	dB	dBuV/m	dBuV/m	dB	cm	deg
1399.20	51.95pk	26.34	2.22	34.15	46.36pk	54.00av	-7.64	101	84
1841.56	48.96pk	29.67	2.48	34.87	46.24pk	54.00av	-7.76	100	54
2488.91	48.48pk	30.90	1.42	35.20	45.61pk	54.00av	-8.39	101	197
3488.71	48.54pk	31.49	1.70	35.82	45.92pk	54.00av	-8.08	103	231
7462.74	43.27pk	39.84	2.29	36.43	48.97pk	54.00av	-5.03	101	177

Note: “*” : Fundamental Frequency

“pk”: peak reading

“av”: average reading

The Spectrum noise level+Correction Factor<Limit-6 dB

Margin = Corrected Amplitude – Limit

Corrected Amplitude=Radiated Amplitude+Antenna Correction Factor+Cable Loss-Pre-Amplifier Gain

A margin of -8dB means that the emission is 8dB below the limit.

All frequencies from 1GHz to 40 GHz have been tested.

1GHz~ 40 GHz (Horizontal), Normal Mode, Channel 5 : 5260 MHz

Operator:MailesHsieh

RBW:1MHz
Humidity(%):47
Temperature(C):26

Frequency MHz	Rx_R. dBuV	Ant_F. dB/m	Cab_L. dB	PreAmpl dB	Emission dBuV/m	Limit dBuV/m	Margin dB	A.Tower cm	T.Table deg
1399.20	50.69pk	26.34	2.22	34.15	45.10pk	54.00av	-8.90	101	84
2938.46	47.93pk	31.08	1.44	34.81	45.64pk	54.00av	-8.36	103	338
3298.10	48.03pk	31.34	1.61	35.40	45.57pk	54.00av	-8.43	103	280
3355.64	49.20pk	31.38	1.63	35.53	46.69pk	54.00av	-7.31	103	266

1GHz~ 40 GHz (Vertical), Normal Mode, Channel 5 : 5260 MHz

Operator:MailesHsieh

RBW:1MHz
Humidity(%):47
Temperature(C):26

Frequency MHz	Rx_R. dBuV	Ant_F. dB/m	Cab_L. dB	PreAmpl dB	Emission dBuV/m	Limit dBuV/m	Margin dB	A.Tower cm	T.Table deg
1061.14	52.47pk	24.78	2.18	33.96	45.46pk	54.00av	-8.54	102	108
1395.60	51.16pk	26.32	2.22	34.14	45.55pk	54.00av	-8.45	101	85
1841.56	48.62pk	29.67	2.48	34.87	45.90pk	54.00av	-8.10	100	54
3503.10	48.76pk	31.50	1.71	35.85	46.13pk	54.00av	-7.87	102	228
7487.91	43.65pk	39.88	2.24	36.38	49.39pk	54.00av	-4.61	101	180

Note: “ * ”: Fundamental Frequency

“ pk ”: peak reading

“ av ”: average reading

The Spectrum noise level+Correction Factor<Limit-6 dB

Margin = Corrected Amplitude – Limit

Corrected Amplitude=Radiated Amplitude+Antenna Correction Factor+Cable Loss-Pre-Amplifier Gain

A margin of -8dB means that the emission is 8dB below the limit.

All frequencies from 1GHz to 40 GHz have been tested.

1GHz~ 40 GHz (Horizontal), Normal Mode, Channel 8: 5320 MHz

Operator:MailesHsieh

RBW:1MHz
Humidity(%):47
Temperature(C):26

Frequency MHz	Rx_R. dBuV	Ant_F. dB/m	Cab_L. dB	PreAmpl dB	Emission dBuV/m	Limit dBuV/m	Margin dB	A.Tower cm	T.Table deg
1953.05	46.63pk	30.61	2.57	35.09	44.71pk	54.00av	-9.29	100	46
2111.29	47.43pk	30.98	2.26	35.18	45.48pk	54.00av	-8.52	100	78
2499.70	49.34pk	30.90	1.36	35.20	46.41pk	54.00av	-7.59	101	200
3359.24	49.55pk	31.39	1.64	35.53	47.05pk	54.00av	-6.95	103	265

1GHz~ 40 GHz (Vertical), Normal Mode, Channel 8: 5320 MHz

Operator:MailesHsieh

RBW:1MHz
Humidity(%):47
Temperature(C):26

Frequency MHz	Rx_R. dBuV	Ant_F. dB/m	Cab_L. dB	PreAmpl dB	Emission dBuV/m	Limit dBuV/m	Margin dB	A.Tower cm	T.Table deg
1841.56	48.73pk	29.67	2.48	34.87	46.01pk	54.00av	-7.99	100	54
2197.60	47.54pk	30.96	2.00	35.19	45.31pk	54.00av	-8.69	101	105
2877.32	48.45pk	31.05	1.43	34.86	46.07pk	54.00av	-7.93	103	318
3355.64	47.59pk	31.38	1.63	35.53	45.09pk	54.00av	-8.91	103	266
7484.32	44.77pk	39.87	2.25	36.39	50.51pk	54.00av	-3.49	101	180

Note: “*” : Fundamental Frequency

“pk”: peak reading

“av”: average reading

The Spectrum noise level+Correction Factor<Limit-6 dB

Margin = Corrected Amplitude – Limit

Corrected Amplitude=Radiated Amplitude+Antenna Correction Factor+Cable Loss-Pre-Amplifier Gain

A margin of -8dB means that the emission is 8dB below the limit.

All frequencies from 1GHz to 40 GHz have been tested.

1GHz~ 40 GHz (Horizontal), Normal Mode, Channel 9: 5745 MHz

Operator:MailesHsieh

RBW:1MHz
Humidity(%):47
Temperature(C):26

Frequency	Rx_R.	Ant_F.	Cab_L.	PreAmpl	Emission	Limit	Margin	A.Tower	T.Table
MHz	dBuV	dB/m	dB	dB	dBuV/m	dBuV/m	dB	cm	deg
2485.31	48.97pk	30.90	1.44	35.20	46.11pk	54.00av	-7.89	101	195
3355.64	49.10pk	31.38	1.63	35.53	46.60pk	54.00av	-7.40	103	266
3826.77	49.76pk	31.96	1.97	36.83	46.85pk	54.00av	-7.15	102	145
4420.18	46.87pk	33.46	2.05	37.36	45.02pk	54.00av	-8.98	101	58

1GHz~ 40 GHz (Vertical), Normal Mode, Channel 9: 5745 MHz

Operator:MailesHsieh

RBW:1MHz
Humidity(%):47
Temperature(C):26

Frequency	Rx_R.	Ant_F.	Cab_L.	PreAmpl	Emission	Limit	Margin	A.Tower	T.Table
MHz	dBuV	dB/m	dB	dB	dBuV/m	dBuV/m	dB	cm	deg
1841.56	48.60pk	29.67	2.48	34.87	45.88pk	54.00av	-8.12	100	54
2190.41	47.23pk	30.96	2.02	35.19	45.03pk	54.00av	-8.97	101	103
2488.91	48.98pk	30.90	1.42	35.20	46.10pk	54.00av	-7.90	101	197
3826.77	53.27pk	31.96	1.97	36.83	50.36pk	54.00av	-3.64	102	145
7459.14	43.53pk	39.83	2.29	36.43	49.23pk	54.00av	-4.77	101	176

Note: “*” : Fundamental Frequency

“pk”: peak reading

“av”: average reading

The Spectrum noise level+Correction Factor<Limit-6 dB

Margin = Corrected Amplitude – Limit

Corrected Amplitude=Radiated Amplitude+Antenna Correction Factor+Cable Loss-Pre-Amplifier Gain

A margin of -8dB means that the emission is 8dB below the limit.

All frequencies from 1GHz to 40 GHz have been tested.

1GHz~ 40 GHz (Horizontal), Normal Mode, Channel 12 : 5805 MHz

Operator:MailesHsieh

RBW:1MHz
Humidity(%):47
Temperature(C):26

Frequency	Rx_R.	Ant_F.	Cab_L.	PreAmpl	Emission	Limit	Margin	A.Tower	T.Table
MHz	dBuV	dB/m	dB	dB	dBuV/m	dBuV/m	dB	cm	deg
2233.57	48.11pk	30.95	1.89	35.19	45.76pk	54.00av	-8.24	101	116
2496.10	48.02pk	30.90	1.38	35.20	45.11pk	54.00av	-8.89	101	199
3057.14	48.12pk	31.15	1.48	34.87	45.87pk	54.00av	-8.13	103	342
3355.64	49.58pk	31.38	1.63	35.53	47.07pk	54.00av	-6.93	103	266

1GHz~ 40 GHz (Vertical), Normal Mode, Channel 12 : 5805 MHz

Operator:MailesHsieh

RBW:1MHz
Humidity(%):47
Temperature(C):26

Frequency	Rx_R.	Ant_F.	Cab_L.	PreAmpl	Emission	Limit	Margin	A.Tower	T.Table
MHz	dBuV	dB/m	dB	dB	dBuV/m	dBuV/m	dB	cm	deg
1064.74	52.64pk	24.80	2.18	33.96	45.65pk	54.00av	-8.35	102	108
1837.96	48.01pk	29.64	2.48	34.86	45.26pk	54.00av	-8.74	100	54
2496.10	48.27pk	30.90	1.38	35.20	45.36pk	54.00av	-8.64	101	199
3866.33	49.74pk	32.01	2.00	36.95	46.80pk	54.00av	-7.20	102	134
7459.14	43.48pk	39.83	2.29	36.43	49.18pk	54.00av	-4.82	101	176

Note: “*” : Fundamental Frequency

“pk”: peak reading

“av”: average reading

The Spectrum noise level+Correction Factor<Limit-6 dB

Margin = Corrected Amplitude – Limit

Corrected Amplitude=Radiated Amplitude+Antenna Correction Factor+Cable Loss-Pre-Amplifier Gain

A margin of -8dB means that the emission is 8dB below the limit.

All frequencies from 1GHz to 40 GHz have been tested.

4.6 Band Edge Measurement (Section 15.407 (b) (1) (2))

4.6.1 Test Procedure (Conducted)

1. The Transmitter output of EUT was connected to the spectrum analyzer.
Equipment mode: Spectrum analyzer

Peak Mode:	
SPAN	100MHz
RBW	1MHz
VBW	1MHz
Sweep Time	200msec.

2. Using Peak Search to read the peak power of Carrier frequencies after Maximum Hold function is completed.
3. Find the next peak frequency outside the operation frequency band.

4.6.2 Test Setup (Conducted)

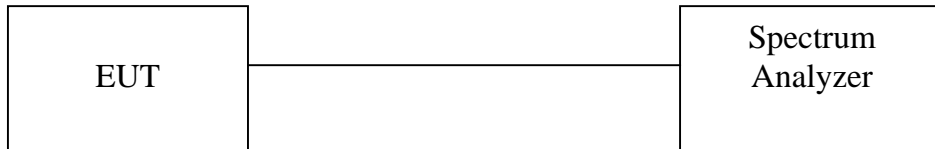

4.6.3 Test Data (conducted):

Band Edge measurement (Conducted)

Temperature ():24

Test Engineer:Mailes Hsieh

Humidity (%):54

Outside Channel Normal Mode	Frequency (MHz)	Spectrum Reading (dBuV)	Corrected Factor (dB)	Corrected Emissions (dBuV EIRP)	Limit: (dBuV EIRP)	Pass or Fail
1	5139.5	60.63	3.46	64.09	80	Pass
8	5350.1	67.13	3.46	70.59	80	Pass
9	5724.4	65.58	3.46	69.04	90	Pass
9	5704.7	63.14	3.46	66.60	80	Pass
12	5826.6	64.76	3.46	68.22	90	Pass
12	5836.7	63.13	3.46	66.59	80	Pass

Note: Corrected Emissions=Spectrum + Corrected Factor
 Corrected Factor=Cable Loss+Antenna Peak Gain (dBi)

Band Edge Conducted measurement (Normal Mode Channel 1)

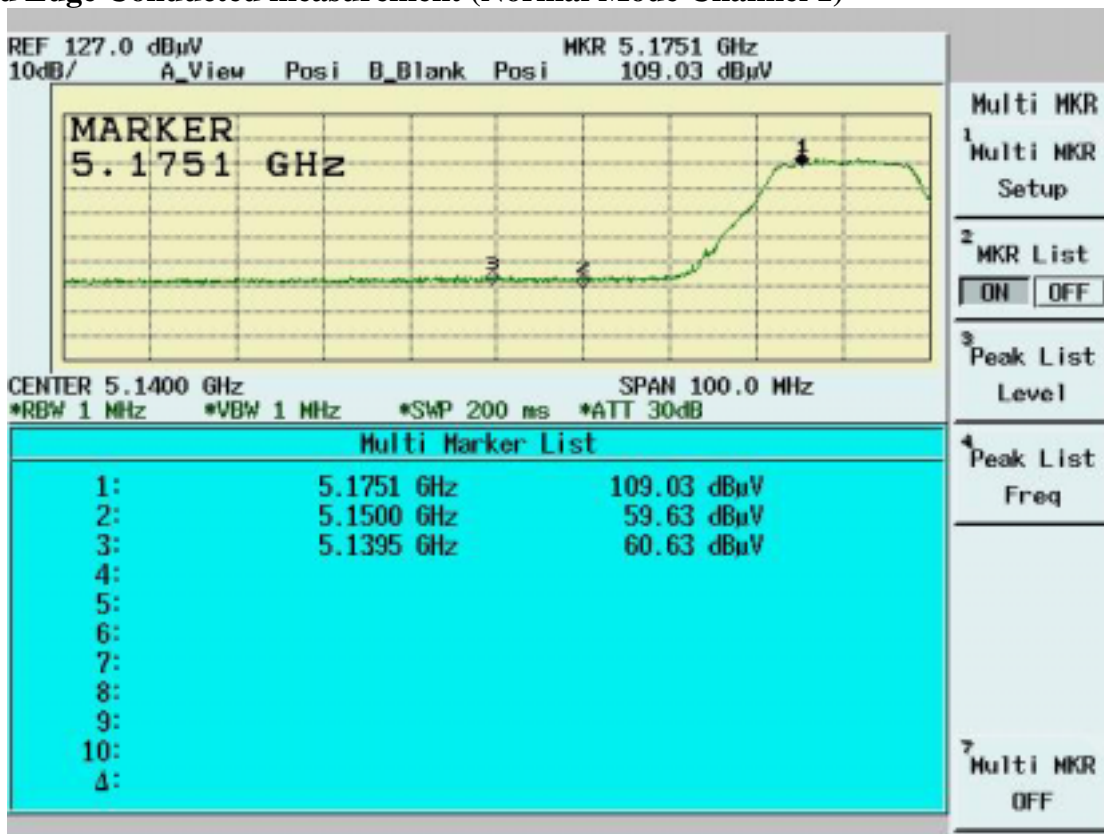

Band Edge Conducted Measurement (Normal Mode Channel 8)

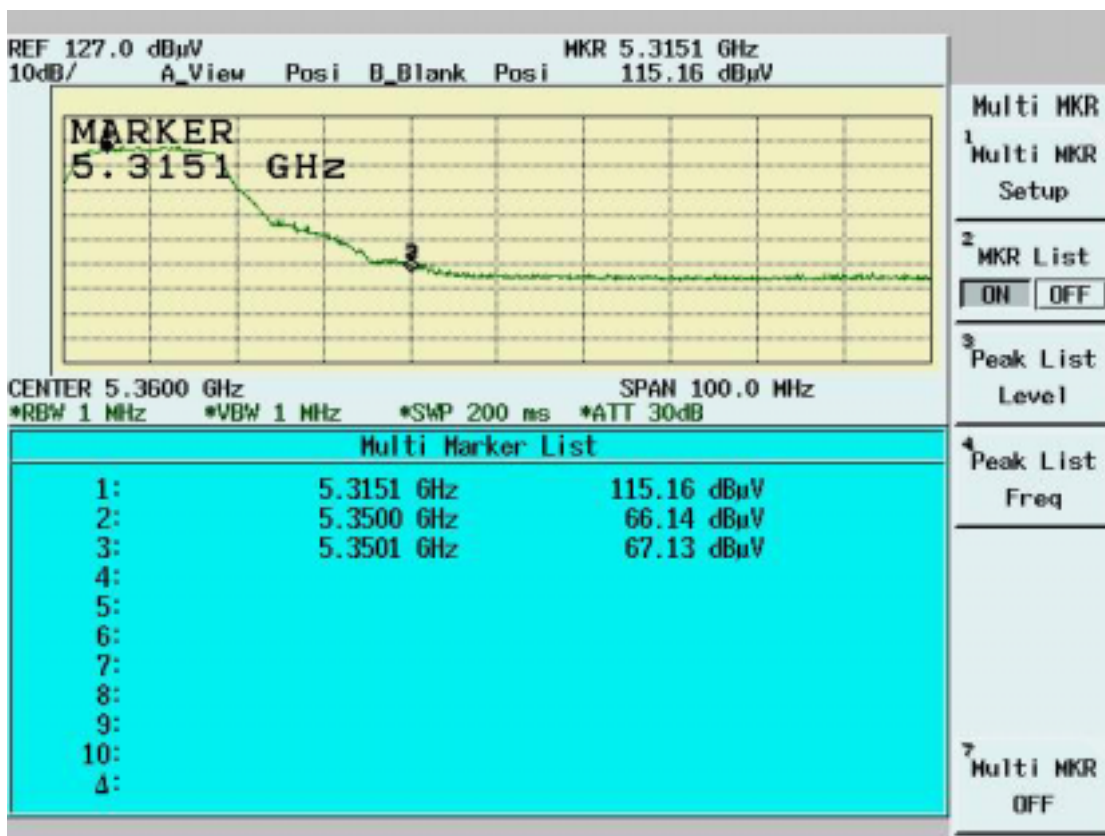

Band Edge Conducted measurement (Normal Mode Channel 9)

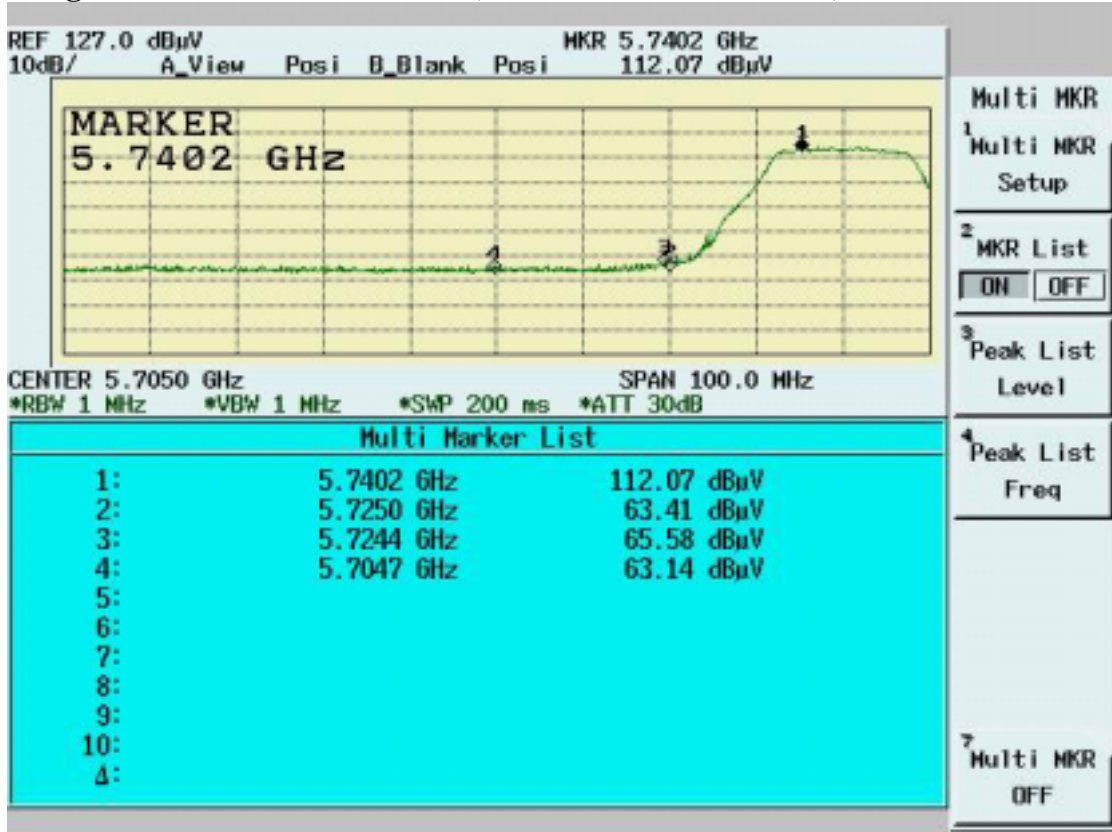

Band Edge Conducted Measurement (Normal Mode Channel 12)

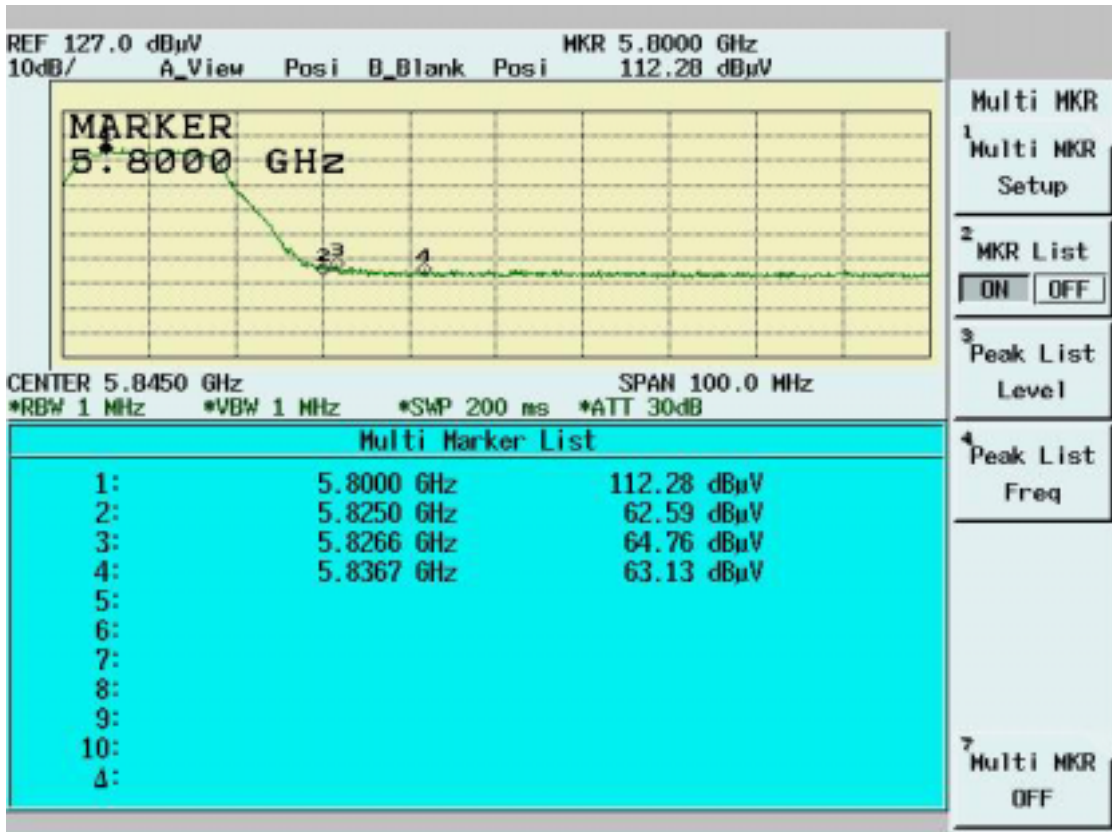

4.6.4 Bandedge Measurement Test Procedure (Radiated)

1. Antenna and Turntable test procedure same as Radiated Emissions measurement listed in Para. 6.5

Equipment mode: Spectrum analyzer

Peak Mode:	
SPAN	100MHz
RBW	1MHz
VBW	3MHz
Sweep Time	200msec.
AVE Mode:	
SPAN	100MHz
RBW	1MHz
VBW	10Hz
Sweep Time	20 sec.

2. Using Peak Search to read the peak power of Carrier frequencies after Maximum Hold function is completed.
3. Find the next peak frequency outside the operation frequency band.
4. Get the spectrum reading after Maximum Hold function is completed.

4.6.5 Test Setup (Radiated)

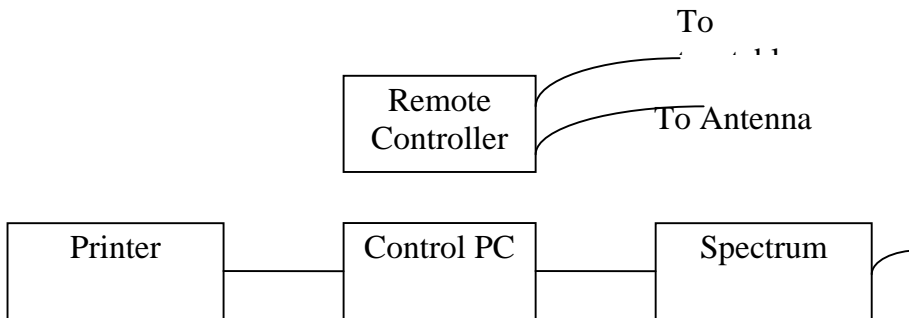
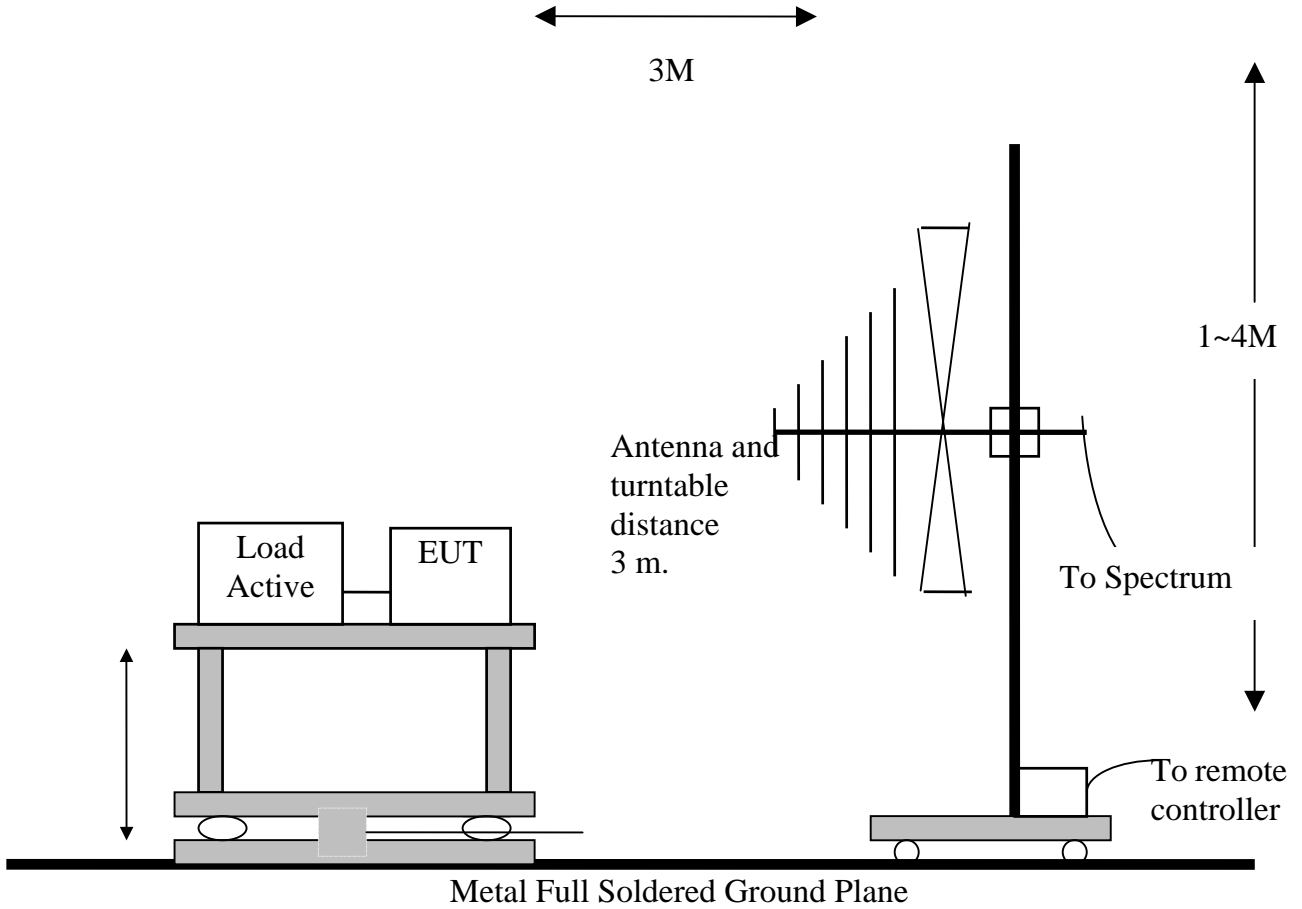

4.6.6 Test Data (Radiated):

Band Edge measurement (Radiated)

Temperature ():25

Test Engineer:Mailles Hsieh

Humidity (%):46

Outside Channel (Normal)	Frequency (MHz)	Spectrum Reading (dBuV)	Correction Factor (dB/m)	Emission Level (dBuV/m)	Limit (dBuV/m)	Pass/Fail
1 (Peak)	5145.0	23.55	39.03	62.58	74	Pass
1 (Average)	5150.0	9.16	39.03	48.19	54	Pass
8 (Peak)	5355.8	24.07	39.34	63.41	74	Pass
8 (Average)	5351.5	9.45	39.34	48.79	54	Pass
9 (Peak)	5710.4	23.88	39.41	63.29	74	Pass
9 (Average)	5715.0	9.72	39.41	49.13	54	Pass
12 (Peak)	5836.1	23.56	39.42	62.98	74	Pass
12 (Average)	5836.1	9.84	39.42	49.26	54	Pass

Note: "pk": peak reading
"av": average reading
Emission Level=Spectrum Reading+Correction Factor
Correction Factor =Antenna Factor+cable loss
Both Horizontal and Vertical polarization have been tested and the worst data is listed above.

Band Edge measurement for radiated emission in Restricted Band(Radiated) Normal Mode (Channel 1) Peak data

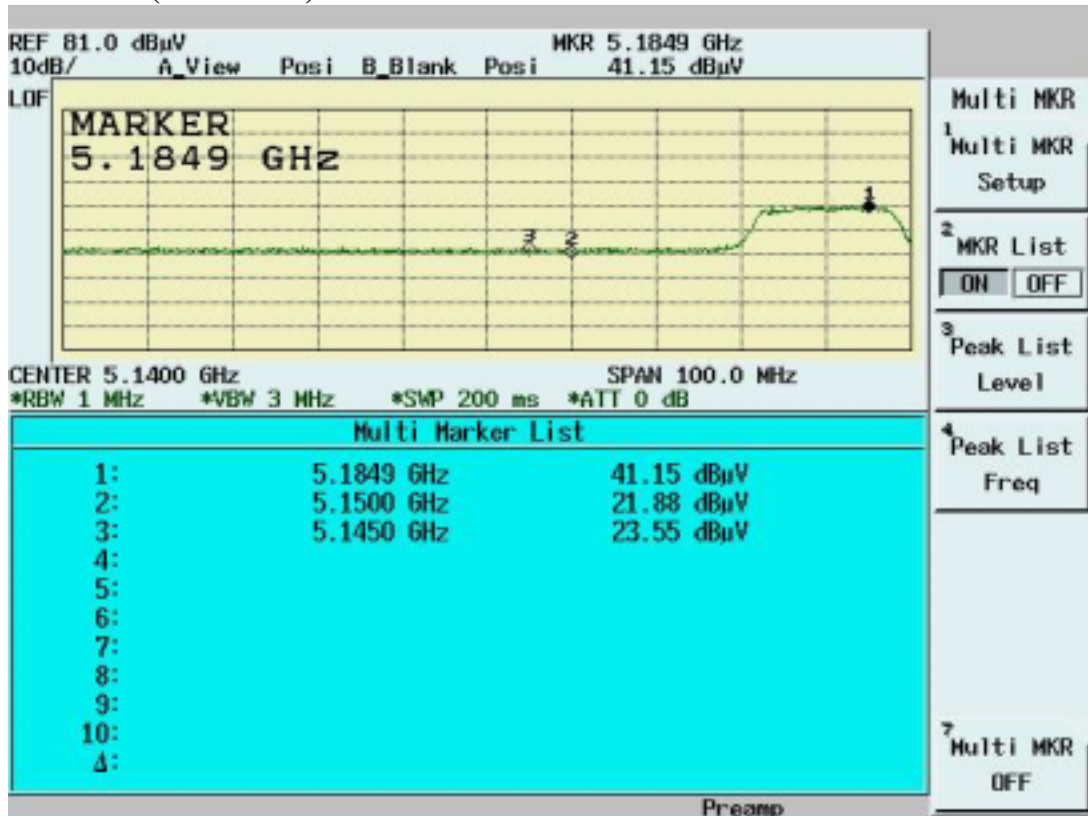

Normal Mode (Channel 1) Average Data

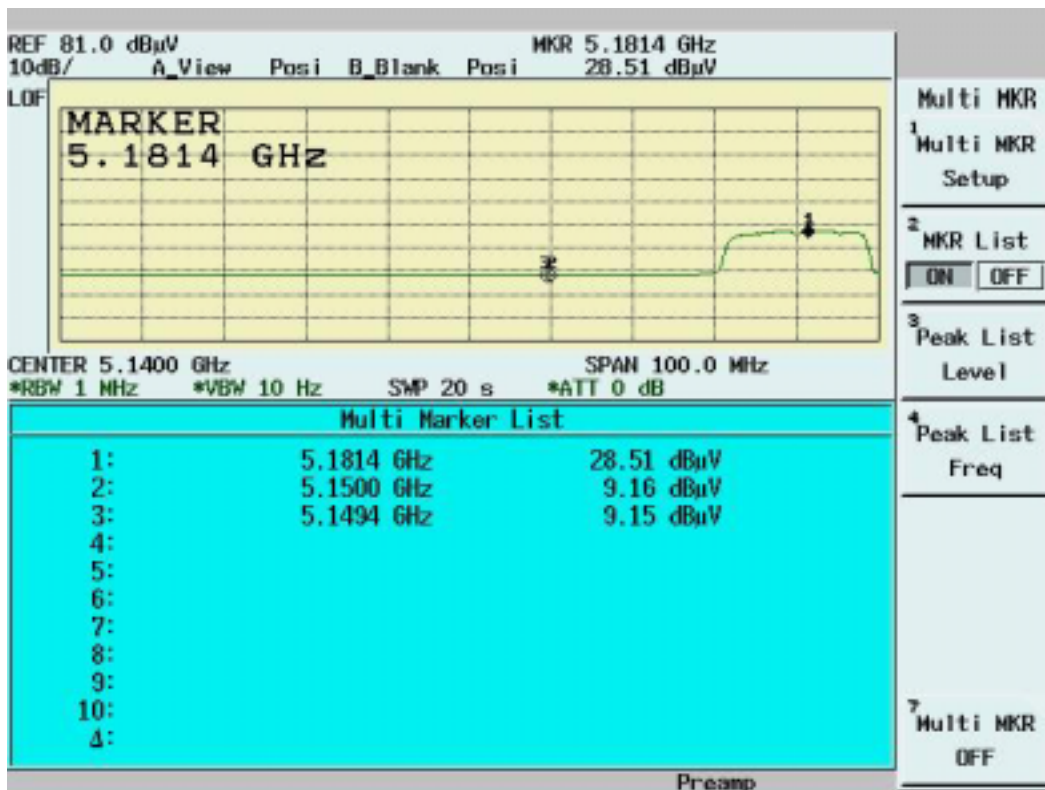

Normal Mode (Channel 8) Peak data

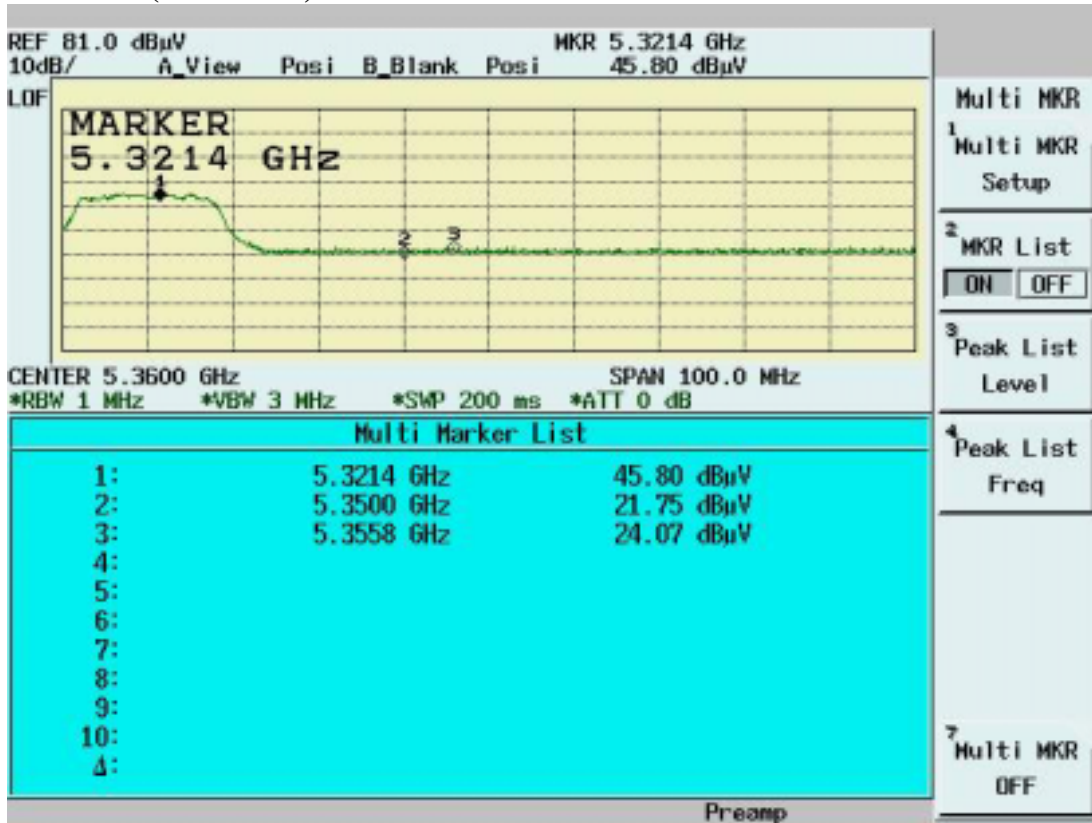

Normal Mode (Channel 8) Average data

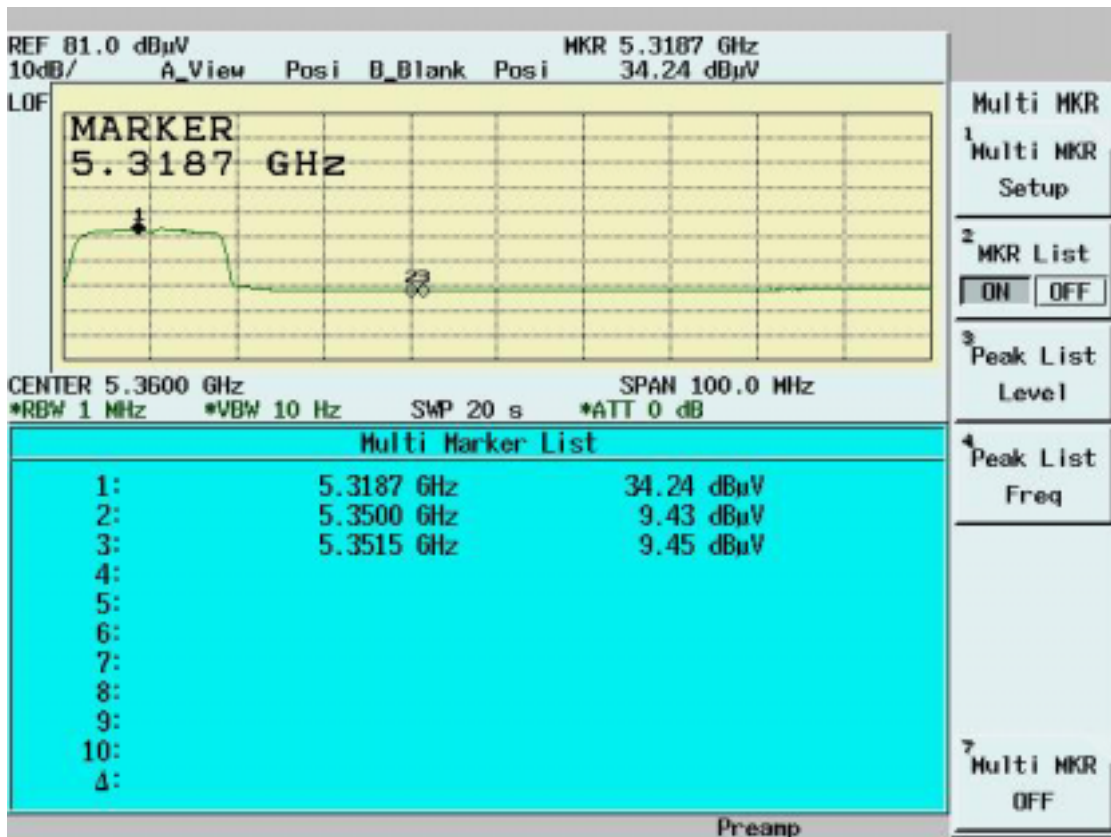

Normal Mode (Channel 9) Peak data

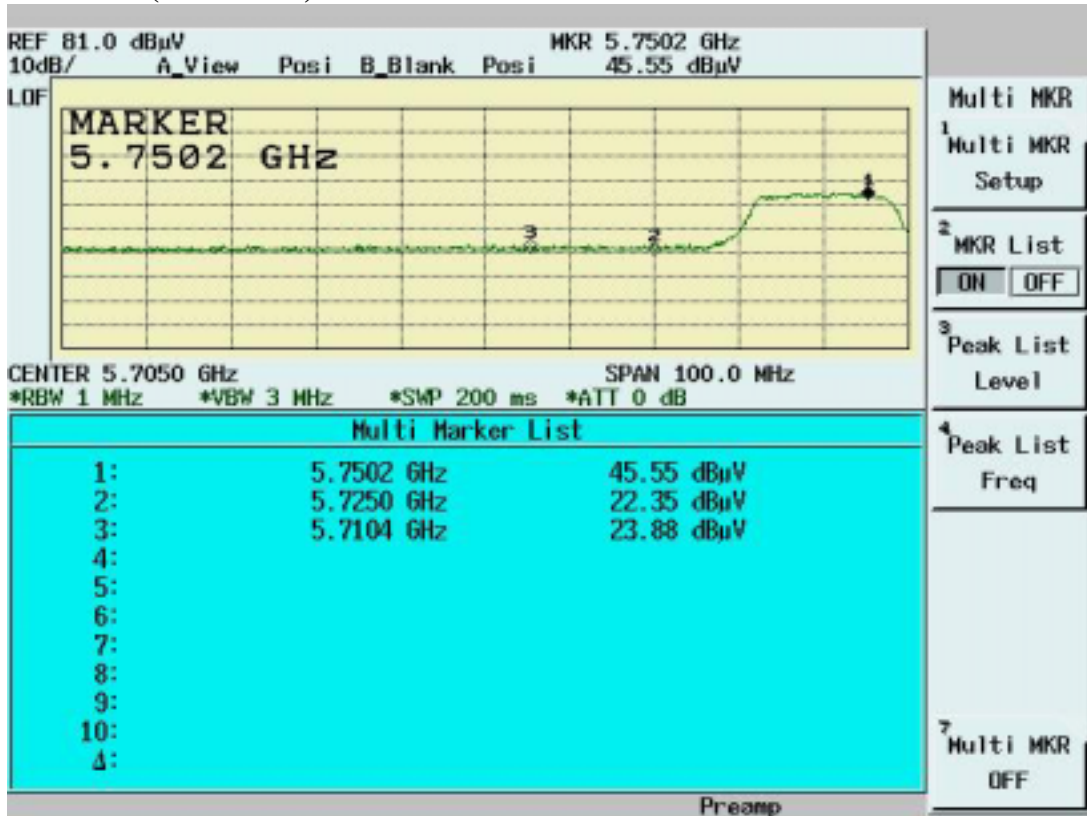

Normal Mode (Channel 9) Average Data

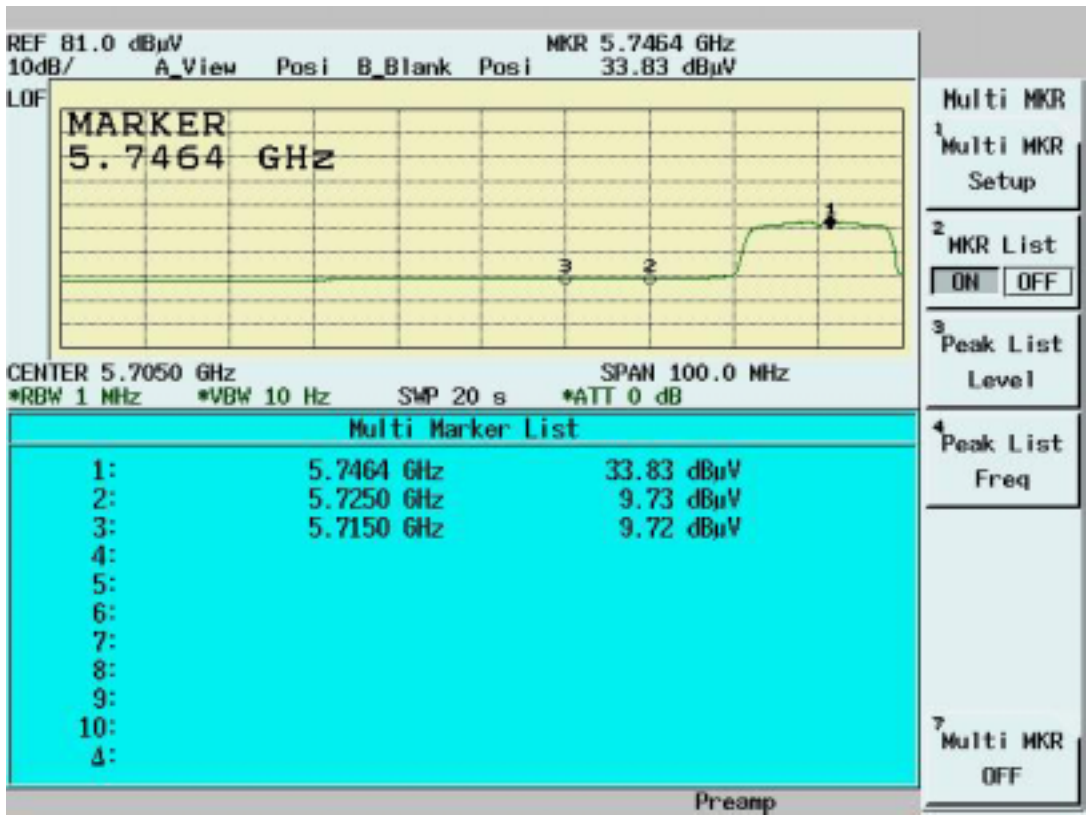

Normal Mode (Channel 12) Peak data

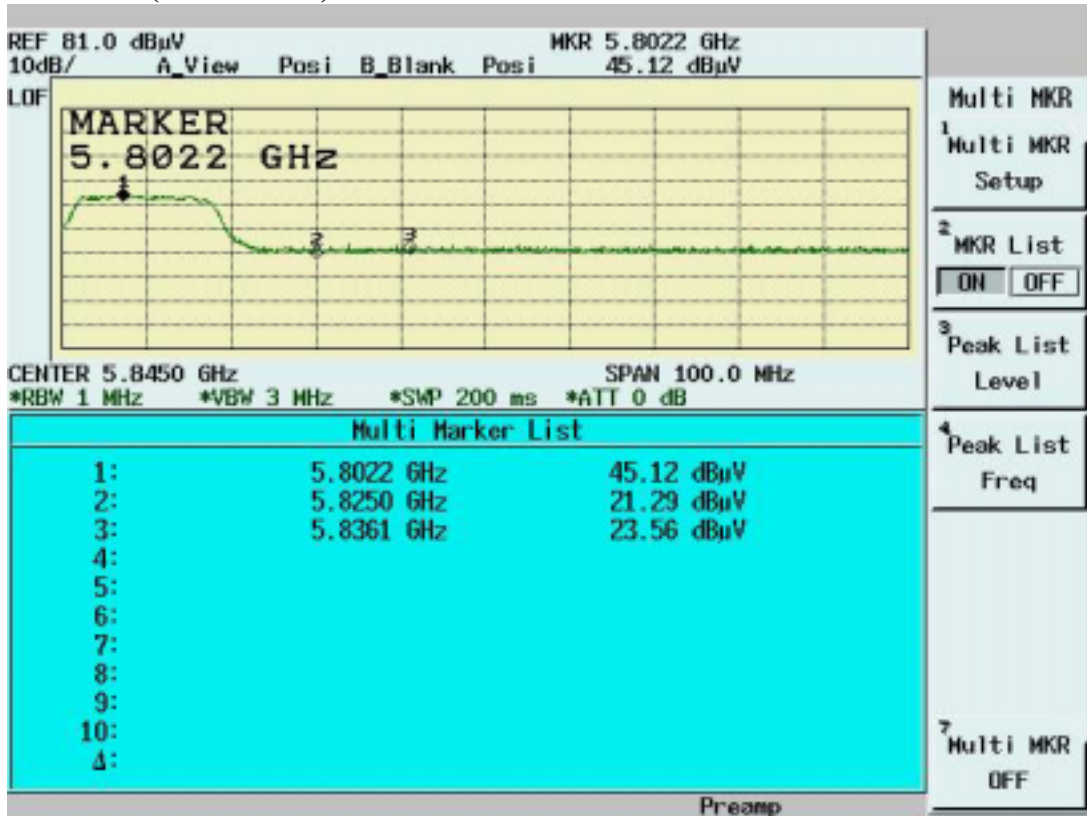

Normal Mode (Channel 12) Average Data

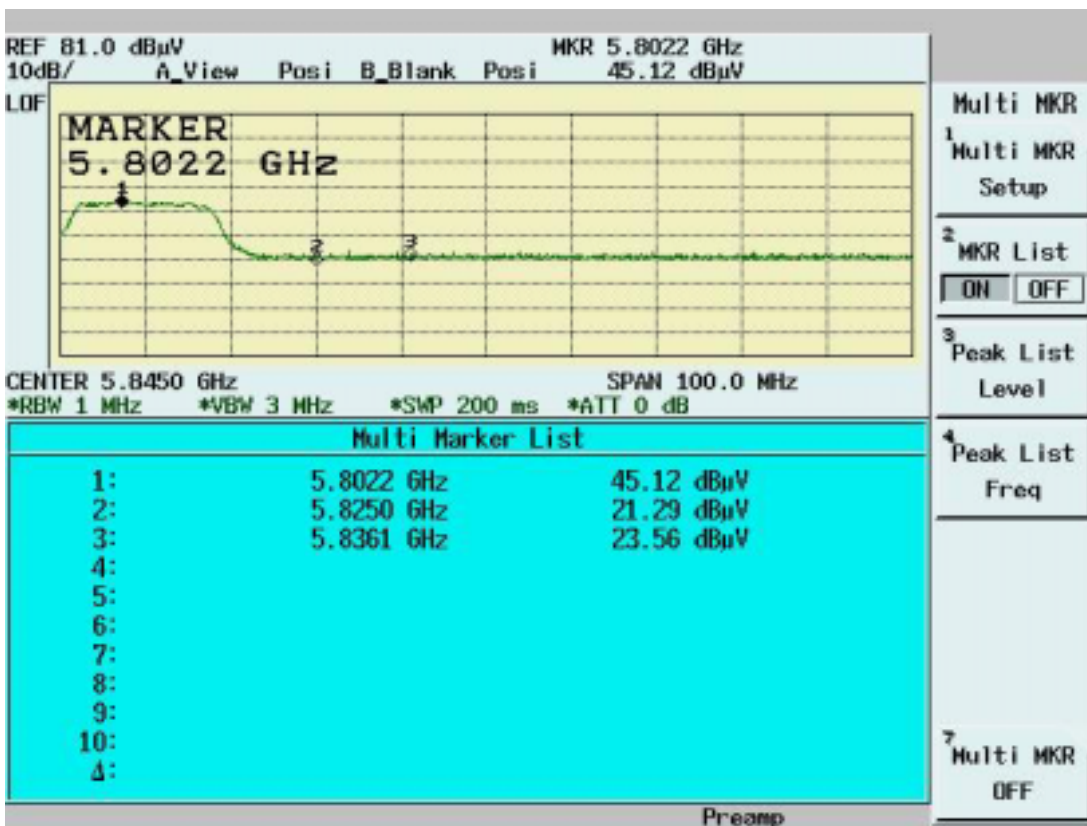

4.7 RF Exposure Measurement [Section 15.407(f)(4) & 1.1307(b)]

Refer to MPE Test Report

4.8 Frequency Stability [Section 15.407(g)]

4.8.1 Limits of Frequency Stability Measurement

The frequency tolerance of the carrier sing shall be maintained within +/- 0.02% of the operating frequency over the operation temperature range of EUT (0⁰C~35⁰C), and variation in the primary supply voltage from 85% to 115% of the rated supply voltage (115V AC) at 20⁰C.

4.8.2 Test Procedure

1. The EUT was placed in the Temperature/Humidity Chamber and powered by a Voltage/Frequency Power converter.
2. Connect the RF output of EUT to Spectrum. Turn on the EUT.
3. Turn the EUT off and set the chamber to the highest temperature specified.
4. Allow sufficient time (approximately 30 min) for the chamber temperature to stabilize. Turn the EUT on and measure the operating frequency after 2, 5, 10 minutes.
5. Set the Voltage/Frequency Power Converter to 85% and 115% of supply voltage, then repeat step 2, 3, 4 respectively.
6. Repeat step 2, 3, 4, 5 with the temperature of chamber set to the lowest temperature.
7. Repeat step 2, 3, 4, 5 with the temperature of chamber set to 20⁰C.

4.8.3 Test Setup

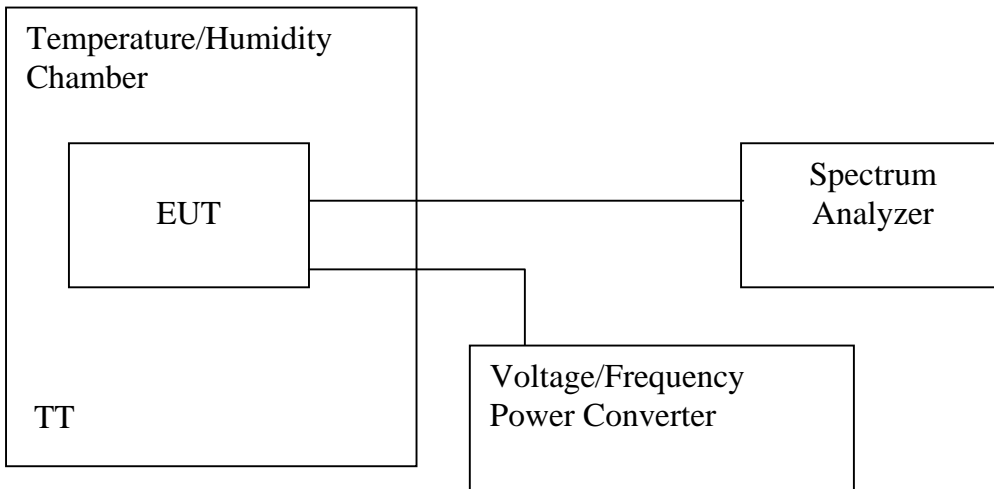

4.8.4 Test Data

Test Engineer:Mailes
Hsieh

Operating Frequency: 5180(Mhz)

Limit: +/- 0.02%

Temp. (°C)	Power Supply (V AC)	2 minutes		5 minutes		10 minutes	
		(MHz)	(%)	(MHz)	(%)	(MHz)	
35	132	5180.0018	0.0000	5180.0050	0.0001	5180.0208	0.0004
	115	5180.0050	0.0001	5180.0122	0.0002	5180.0212	0.0004
	97	5180.0036	0.0001	5180.0120	0.0002	5180.0013	0.0000
0	132	5180.0050	0.0001	5180.0155	0.0003	5180.0094	0.0002
	115	5180.0111	0.0002	5180.0233	0.0004	5180.0200	0.0004
	97	5180.0307	0.0006	5180.0193	0.0004	5180.0202	0.0004
20	132	5180.0043	0.0001	5180.0124	0.0002	5180.0087	0.0002
	115	5180.0108	0.0002	5180.0172	0.0003	5180.0121	0.0002
	97	5179.9932	-0.0001	5180.0249	0.0005	5179.9960	-0.0001

5. TEST RESULTS (802.11b)

5.1 Powerline Conducted Emissions [Section 15.207]

5.1.1 EUT Configuration

The EUT was set up on the non-conductive table that is 1.0 by 1.5 meter, 80cm above ground. The wall of the shielded room was located 40cm to the rear of the EUT.

Power to the EUT was provided through the LISN. The impedance vs. frequency characteristic of the LISN is complied with the limit used.

Both lines (neutral and hot) were connected to the LISN in series at testing. A coaxial-type connector which provides one 50 ohms terminating impedance was provided for connecting the test instrument. The excess length of the power cord was folded back and forth at the center of the lead so as to form a bundle not exceeding 40cm in length.

Any changes made to the configuration, or modifications made to the EUT, during testing are noted in the following test record.

If the EUT is a Personal Computer or a peripheral of personal computer, and the personal computer has an auxiliary AC outlet which can be used for providing power to an external monitor, then all measurements will be made with the monitor power from first the computer-mounted AC outlet and then a floor-mounted AC outlet.

5.1.2 Test Procedure

The system was set up as described above, with the EMI diagnostic software running. The main power line conducted EMI tests were run on the hot and neutral conductors of the power cord and the results were recorded. The effect of varying the position of the interface cables has been investigated to find the configuration that produces maximum emission.

At the frequencies where the peak values of the emissions were higher than 6dB below the applicable limits, the emissions were also measured with the quasi-peak detectors. At the frequencies where the quasi-peak values of the emissions were higher than 6dB below the applicable average limits, the emissions were also measured with the average detectors.

The highest emissions were analyzed in details by operating the spectrum analyzer in fixed tuned mode to determine the nature of the emissions and to provide information which could be useful in reducing their amplitude.

5.1.3 EMI Receiver/Spectrum Analyzer Configuration (for the frequencies tested)

Frequency Range	150 KHz--30MHz
Detector Function	Quasi-Peak/Average
Bandwidth (RBW)	9KHz

5.1.4 Test Data:

Power Line Conducted Emissions (Hot) Channel 1, 6, 11

Operator:MailesHsieh

Temperature(C):25

12:22:40PM,Tuesday,May03,2005

Humidity(%):57

Frequency	LISNLoss	CableLoss	QPCorrt.	QPLimit	QPMargin	AVECorrt.	AVELimit	AVEMargin
MHz	(dB)	(dB)	Amp.(dBuV)	(dBuV)	(dB)	Amp.(dBuV)	(dBuV)	(dB)
0.50148	0.12	0.07	33.31	56.00	-22.69	31.92	46.00	-14.08
0.64173	0.14	0.07	27.79	56.00	-28.21	25.48	46.00	-20.52
0.716	0.15	0.07	31.14	56.00	-24.86	29.21	46.00	-16.79
0.8614	0.18	0.07	31.63	56.00	-24.37	29.90	46.00	-16.10
0.93305	0.19	0.07	29.65	56.00	-26.35	26.94	46.00	-19.06
2.21976	0.20	0.10	30.53	56.00	-25.47	24.26	46.00	-21.74
2.64956	0.20	0.11	33.70	56.00	-22.30	23.72	46.00	-22.28
2.86506	0.20	0.11	34.66	56.00	-21.34	24.53	46.00	-21.47
19.7082	0.78	0.34	35.69	60.00	-24.31	31.07	50.00	-18.93
22.5695	0.85	0.33	48.32	60.00	-11.68	48.21	50.00	-1.79

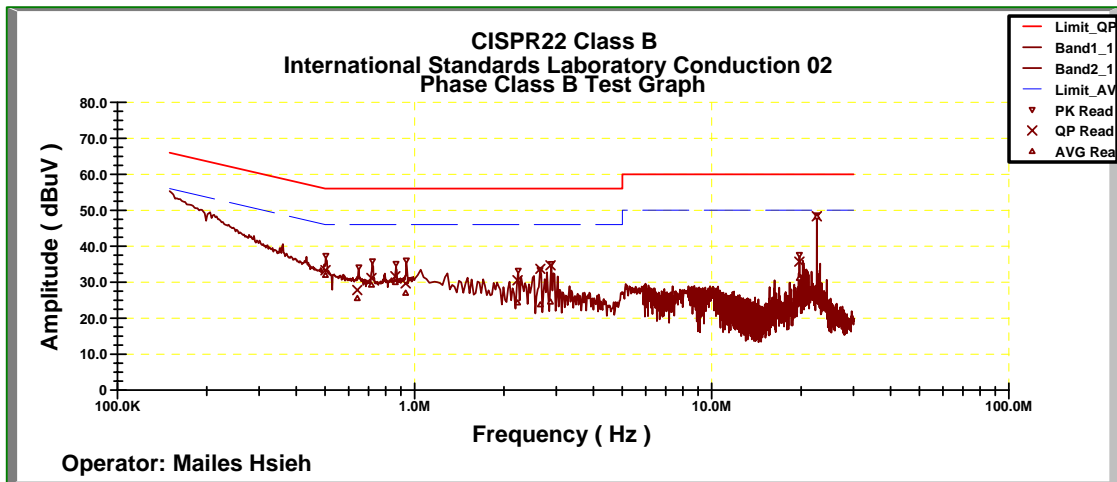

Power Line Conducted Emissions (Neutral) Channel 1, 6, 11

Operator:MailesHsieh

Temperature(C):25

Humidity(%):57

12:32:07PM,Tuesday,May03,2005

Frequency	LISNLoss	CableLoss	QPCorrt.	QPLimit	QPMargin	AVECorrt.	AVELimit	AVEMargin
MHz	(dB)	(dB)	Amp.(dBuV)	(dBuV)	(dB)	Amp.(dBuV)	(dBuV)	(dB)
0.50111	0.12	0.07	31.41	56.00	-24.59	29.79	46.00	-16.21
0.644	0.14	0.07	28.01	56.00	-27.99	25.18	46.00	-20.82
0.7187	0.15	0.07	27.88	56.00	-28.12	26.07	46.00	-19.93
0.86165	0.18	0.07	29.16	56.00	-26.84	26.79	46.00	-19.21
0.93216	0.19	0.07	29.56	56.00	-26.44	26.07	46.00	-19.93
2.2918	0.20	0.10	32.41	56.00	-23.59	25.16	46.00	-20.84
2.43456	0.20	0.10	32.14	56.00	-23.86	21.35	46.00	-24.65
2.65053	0.20	0.11	34.05	56.00	-21.95	23.73	46.00	-22.27
2.86483	0.20	0.11	34.91	56.00	-21.09	24.34	46.00	-21.66
22.5697	0.40	0.33	47.71	60.00	-12.29	47.55	50.00	-2.45

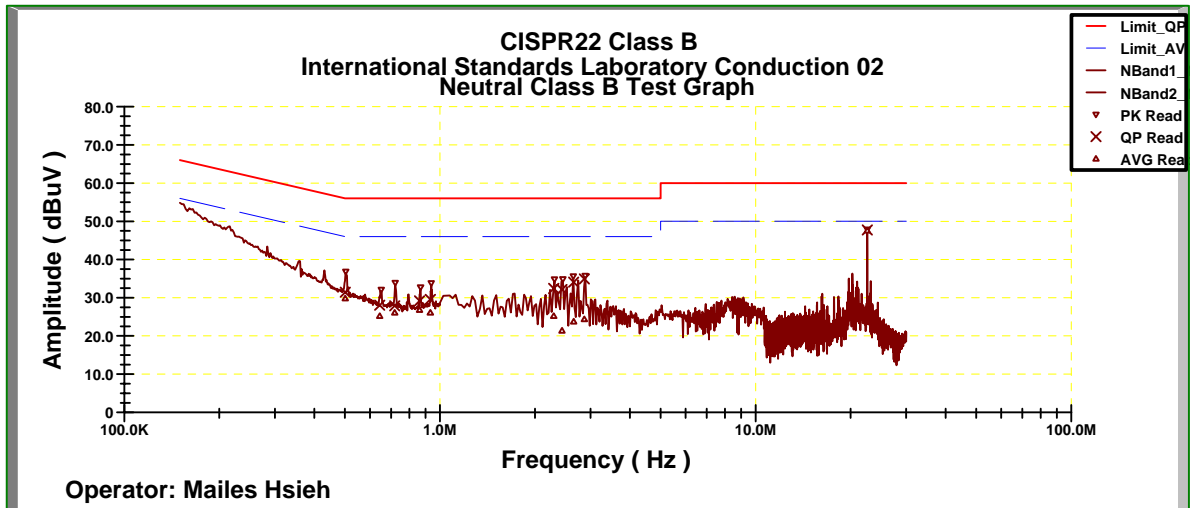

* NOTE: During the test, the EMI receiver was set to Max. Hold then switch the EUT Channel between 1 , 6, 11 to get the maximum reading of all these channels.
 Margin = Amplitude + Insertion Loss- Limit
 A margin of -8dB means that the emission is 8dB below the limit

5.2 Bandwidth for DSSS [Section 15.247 (a)(2)]

5.2.1 Test Procedure

The Transmitter output of EUT was connected to the spectrum analyzer. The 6 dB bandwidth of the fundamental frequency was measured. The setting of spectrum analyzer is as follows

Equipment mode	Spectrum analyzer
Detector function	Peak mode
RBW	100KHz
VBW	100KHz

5.2.2 Test Setup

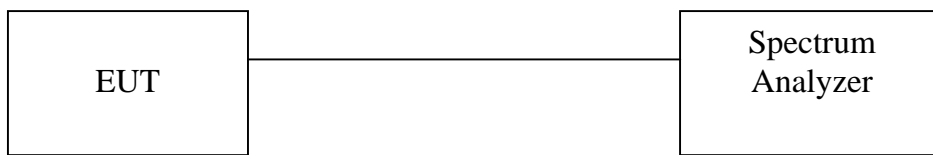

5.2.3 Test Data:

6dB Bandwidth

Temperature ():24

Humidity (%):54

Test Engineer:Mailes Hsieh

Channel	Frequency (MHz)	6dB Bandwidth (MHz)	Limit (MHz)	Pass/Fail
1	2412	9.20	0.5	Pass
6	2437	9.24	0.5	Pass
11	2462	9.20	0.5	Pass