	Test Report Serial No.:	042406KBC-T743-E15B	Report Revision No.:	Revision 1.0
	Test Date(s):	18May05 - 14Jul05	Report Issue Date:	November 07, 2006
	Test Standard(s):	FCC 47 CFR §15.247	Industry Canada RSS-210 Issue 5	
	Lab Registration(s):	FCC Lab Reg. # 714830	Industry Canada Lab File # IC 3874	

ELECTROMAGNETIC COMPATIBILITY

EMC TEST REPORT

FCC 47 CFR PART 15 SUBPART C

INDUSTRY CANADA RSS-210 ISSUE 5
(compliant with RSS-210 Issue 6, Sept. 2005)

FOR

ITRONIX CORPORATION

MODEL: IX325A860IWLBT

IX325 SERIES RUGGED TABLET PC

WITH

BLUETOOTH TRANSMITTER

AND

INTERNAL PIFA ANTENNA 3

FCC ID: KBCIX325A860IWLBT

IC: 1943A-IX325g

Test Report Serial No.

042406KBC-T743-E15B

Test Report Revision No.

Revision 1.0 (Initial Release)

Test Lab and Location

Celltech Compliance Testing & Engineering Lab
(Celltech Labs Inc.)
1955 Moss Court
Kelowna, BC
Canada
V1Y 9L3

	Test Report Serial No.:	042406KBC-T743-E15B	Report Revision No.:	Revision 1.0
	Test Date(s):	18May05 - 14Jul05	Report Issue Date:	November 07, 2006
	Test Standard(s):	FCC 47 CFR §15.247	Industry Canada RSS-210 Issue 5	
	Lab Registration(s):	FCC Lab Reg. # 714830	Industry Canada Lab File # IC 3874	



DECLARATION OF COMPLIANCE

Test Lab and Location	CELLTECH LABS INCORPORATED Testing and Engineering Services 1955 Moss Court Kelowna, B.C. Canada V1Y 9L3		Company Information	ITRONIX CORPORATION 12825 E. Mirabeau Parkway Spokane Valley, WA 99216 United States
Phone:	250-448-7047			
Fax:	250-448-7048			
E-mail:	info@celltechlabs.com			
web site:	www.celltechlabs.com			
Lab Registration No.(s):	FCC:	714830	IC:	3874
Rule Part(s):	FCC:	§15.247; §2.1091; §1.1310	IC:	RSS-210 Issue 5 - A1. 11/30/02
Device Classification:	FCC:	Spread Spectrum Transmitter (DSS)	IC:	Low Power Licence-Exempt Transmitter
Device Identification:	FCC ID:	KBCIX325A860IWLBT	IC:	1943A-IX325g
DUT Description:				
Model(s):	IX325A860IWLBT			
Device Type:	Rugged Tablet PC			
Internal Transmitter:	MSI MS-6837 Bluetooth			
Tx Frequency Range:	2402 - 2480 MHz			
Max. RF Output Power:	+3.96 dBm	0.0025 Watts	Maximum peak conducted power measured (2402 MHz)	
Mode(s) of Operation:	Frequency Hopping Spread Spectrum (FHSS)			
Modulation Type(s):	GFSK 1 Mbps 0.5 BT Gaussian			
Antenna Type(s):	Internal PIFA Bluetooth Antenna	Manufacturer: Green Well Technology Co., Ltd.		
Power Source(s):	Stationary: 75 Watt AC Power Adapter			
	11.1 V Internal Lithium-ion Battery, 3600 mAh (Model: T8M-E)			
	11.1 V External Second Lithium-ion Battery, 3600 mAh (Model: T8S-E)			

This device has demonstrated compliance with the applicable technical standards as indicated in the measurement report and was tested in accordance with the measurement procedures specified in FCC 47 CFR Part 15C and Industry Canada RSS-210 Issue 5.

I attest to the accuracy of the data. All measurements reported herein were performed by me or were under my supervision and are correct to the best of my knowledge and belief. I assume full responsibility for the completeness of these measurements and vouch for the qualifications of all persons taking them.

This test report shall not be reproduced partially, or in full, without the prior written approval of Celltech Labs Inc. The results and statements contained in this report pertain only to the device(s) evaluated.

 <hr/> Russell Pipe Senior Compliance Technologist Celltech Labs Inc.	 <hr/> Duane M. Friesen, C.E.T. EMC Manager Celltech Labs Inc.	
--	--	---

Company:	Itronix Corporation	Model:	IX325A860IWLBT	FCC ID:	KBCIX325A860IWLBT	IC ID:	1943A-IX325g
DUT Type:	IX325 Rugged Tablet PC with MSI MS-6837 Bluetooth & internal PIFA Antenna 3			2402 - 2480 MHz		ITRONIX <small>A GENERAL DYNAMICS COMPANY</small>	
2006 Celltech Labs Inc.	This document is not to be reproduced in whole or in part without the prior written permission of Celltech Labs Inc.						Page 2 of 62



	Test Report Serial No.:	042406KBC-T743-E15B	Report Revision No.:	Revision 1.0
	Test Date(s):	18May05 - 14Jul05	Report Issue Date:	November 07, 2006
	Test Standard(s):	FCC 47 CFR §15.247	Industry Canada RSS-210 Issue 5	
	Lab Registration(s):	FCC Lab Reg. # 714830	Industry Canada Lab File # IC 3874	

TABLE OF CONTENTS

1.0 SCOPE	6
2.0 REFERENCES	6
2.1 Normative References.....	6
3.0 TERMS AND DEFINITIONS.....	7
4.0 FACILITIES AND ACCREDITATIONS.....	8
5.0 GENERAL INFORMATION	8
5.1 Applicant Information	8
5.2 DUT Description.....	8
5.3 Co-Located Equipment.....	9
5.4 Cable Descriptions	9
5.5 Support Equipment	9
5.6 Clock Frequencies	10
5.7 Mode(s) of Operation Tested.....	10
5.8 Configuration Description	11
6.0 PASS/FAIL CRITERIA	11
APPENDICES	12
Appendix A - Photographs	13
Appendix B - Conducted Powerline Emissions Measurement.....	15
Appendix C - Peak Conducted RF Output Power Measurement	22
Appendix D - Adjacent Channel Separation.....	25
Appendix E - Number of Hopping Channels	29
Appendix F - Channel Dwell Time	33
Appendix G - 20 dB Bandwidth Measurement	37
Appendix H - Radiated Spurious Emissions Measurement	41
Appendix I - Restricted Band Emissions Measurement.....	49
END OF DOCUMENT	62

Company:	Itronix Corporation	Model:	IX325A860IWLBT	FCC ID:	KBCIX325A860IWLBT	IC ID:	1943A-IX325g
DUT Type:	IX325 Rugged Tablet PC with MSI MS-6837 Bluetooth & internal PIFA Antenna 3			2402 - 2480 MHz			
2006 Celltech Labs Inc.	This document is not to be reproduced in whole or in part without the prior written permission of Celltech Labs Inc.						Page 3 of 62

	Test Report Serial No.:	042406KBC-T743-E15B	Report Revision No.:	Revision 1.0
	Test Date(s):	18May05 - 14Jul05	Report Issue Date:	November 07, 2006
	Test Standard(s):	FCC 47 CFR §15.247	Industry Canada RSS-210 Issue 5	
	Lab Registration(s):	FCC Lab Reg. # 714830	Industry Canada Lab File # IC 3874	

FIGURES

Figure B.7-1 - Setup Drawing	18
Figure C.6-1 - Setup Drawing	23
Figure D.6-1 - Setup Drawing	26
Figure E.6-1 - Setup Drawing	30
Figure F.6-1 - Setup Drawing	34
Figure F.8-1 - List Repetition Rate.....	35
Figure F.8-2 - Pulse Width	35
Figure G.6-1 - Setup Drawing.....	38
Figure H.6-1 - Setup Drawing.....	42
Figure I.6-1 - Setup Drawing	51

PHOTOGRAPHS

Photograph A.1-1 - Front of IX325 Tablet PC	13
Photograph A.1-2 - Back of IX325 Tablet PC.....	13
Photograph A.1-3 - Edge of IX325 Tablet PC	13
Photograph A.1-4 - Side of IX325 Tablet PC	13
Photograph A.1-5 - Internal Bluetooth Location	14
Photograph A.1-6 - Left Edge Bluetooth Antenna Location	14
Photograph B.6-1 - AC Powerline Conducted Emission Configuration	17
Photograph B.6-2 - AC Powerline Conducted Emission Cable Placement	17
Photograph H.8-1 - 3115 Horn Antenna (2GHz - 10GHz)	43
Photograph H.8-2 - 3115 Horn Antenna (10GHz - 18GHz)	43
Photograph H.8-3 - 3160-09 Horn Antenna (18GHz - 24 GHz)	43
Photograph I.8-1 - Loop Antenna (10kHz - 30MHz)	52
Photograph I.8-2 - Bilog Antenna (30MHz - 1GHz).....	52
Photograph I.8-3 - 3115 Horn Antenna (1GHz - 2GHz).....	52
Photograph I.8-4 - 3115 Horn Antenna (2GHz - 10GHz).....	52
Photograph I.8-5 - 3115 Horn Antenna (10GHz - 18GHz).....	52
Photograph I.8-6 - 3160-09 Horn (18GHz - 24GHz).....	52

Company:	Itronix Corporation	Model:	IX325A860IWLBT	FCC ID:	KBCIX325A860IWLBT	IC ID:	1943A-IX325g
DUT Type:	IX325 Rugged Tablet PC with MSI MS-6837 Bluetooth & internal PIFA Antenna 3			2402 - 2480 MHz			
2006 Celltech Labs Inc.	This document is not to be reproduced in whole or in part without the prior written permission of Celltech Labs Inc.						Page 4 of 62

	Test Report Serial No.:	042406KBC-T743-E15B	Report Revision No.:	Revision 1.0
	Test Date(s):	18May05 - 14Jul05	Report Issue Date:	November 07, 2006
	Test Standard(s):	FCC 47 CFR §15.247	Industry Canada RSS-210 Issue 5	
	Lab Registration(s):	FCC Lab Reg. # 714830	Industry Canada Lab File # IC 3874	

TEST SUMMARY

Referenced Standard: FCC CFR Title 47 Part 15

Appendix	Test Description	Procedure Reference	Limit Reference	Test Start Date	Test End Date	Result
B	Powerline Conducted Emissions	ANSI C63.4	§15.207	6Jun05	6Jun05	Pass
C	Peak Conducted RF Output Power	DA 00-705	§15.247 (b) (1)	14Jul05	14Jul05	Pass
D	Adjacent Channel Separation	DA 00-705	§15.247 (a) (1)	3Jun05	3Jun05	Pass
E	Number of Hopping Channels	DA 00-705	§15.247 (a) (1) (iii)	18May05	18May05	Pass
F	Channel Dwell Time	DA 00-705	§15.247 (a) (1) §15.247 (a) (1) (iii)	3Jun05	3Jun05	Pass
G	20 dB Bandwidth	DA 00-705	§15.247 (a) (1) (iii)	3Jun05	3Jun05	Pass
H	Radiated Spurious Emissions	DA 00-705	§15.247(c)	26May05	9Jun05	Pass
I	Restricted Band Emissions	DA 00-705	§15.205 (a), (b) §15.209 (a)	26May05	9Jun05	Pass



Referenced Standard: IC RSS-210 Issue 5

B	Powerline Conducted Emissions	RSS-212, ANSI C63.4	RSS-210 §6.6	6Jun05	6Jun05	Pass
C	Peak Conducted RF Output Power	RSS-210 § 10	RSS-210 §6.2.2 (o)(a3)	14Jul0505	14Jul05	Pass
D	Adjacent Channel Separation	RSS-210 § 10	RSS-210 A1 §I (ii)	3Jun05	3Jun05	Pass
E	Number of Hopping Channels	RSS-210 § 10	RSS-210 A1 §I (ii)	18May05	18May05	Pass
F	Channel Dwell Time	RSS-210 § 10	RSS-210 A1 §I (ii)	3Jun05	3Jun05	Pass
G	20 dB Bandwidth	RSS-210 § 10	RSS-210 A1 §I (ii)	3Jun05	3Jun05	Pass
H	Radiated Spurious Emissions	RSS-212, ANSI C63.4	RSS-210 §6.2.2 (o)(e1)	26May05	9Jun05	Pass
I	Restricted Band Emissions	RSS-212, ANSI C63.4	RSS-210 §6.3	26May05	9Jun05	Pass

REVISION LOG

Revision No.	Description	Implemented By	Implementation Date
1.0	Initial Release	Jonathan Hughes	07Nov06

SIGNATORIES

Prepared By		January 25, 2006
Name/Title	Duane M. Friesen, C.E.T. / EMC Manager	Date
Approved By		February 17, 2006
Name/Title	Jonathan Hughes / General Manager	Date

Company:	Itronix Corporation	Model:	IX325A860IWLBT	FCC ID:	KBCIX325A860IWLBT	IC ID:	1943A-IX325g	
DUT Type:	IX325 Rugged Tablet PC with MSI MS-6837 Bluetooth & internal PIFA Antenna 3			2402 - 2480 MHz		ITRONIX <small>A GENERAL DYNAMICS COMPANY</small>		
2006 Celltech Labs Inc.		This document is not to be reproduced in whole or in part without the prior written permission of Celltech Labs Inc.					Page 5 of 62	

	Test Report Serial No.:	042406KBC-T743-E15B	Report Revision No.:	Revision 1.0
	Test Date(s):	18May05 - 14Jul05	Report Issue Date:	November 07, 2006
	Test Standard(s):	FCC 47 CFR §15.247	Industry Canada RSS-210 Issue 5	
	Lab Registration(s):	FCC Lab Reg. # 714830	Industry Canada Lab File # IC 3874	

1.0 SCOPE

This report outlines the measurements made and results collected during electromagnetic emissions testing of the Itronix Corporation IX325 Rugged Tablet PC with internal MSI MS-6837 Bluetooth Transmitter and Internal PIFA antenna. The results were applied against the EMC requirements and limits outlined in the technical rules and regulations set forth in the Federal Communication Commission Code of Federal Regulations Title 47 Part 15 Subpart C and Industry Canada RSS-210 Issue 5.

2.0 REFERENCES

2.1 Normative References

ANSI/ISO 17025:1999	General Requirements for competence of testing and calibration laboratories
IEEE/ANSI C63.4-2003	Methods of Measurement of Radio-Noise Emissions from Low-Voltage Electrical and Electronic Equipment in the Range of 9 kHz to 40 GHz
IEEE/ANSI Std C95.1-1999	American National Standard Safety Levels with Respect to Human Exposure to Radio Frequency Electromagnetic Fields
CFR Title 47 Part 2:2004	Code of Federal Regulations Title 47: Telecommunication Part 2: Frequency Allocations and Radio Treaty Matters; General Rules and Regulations
CFR Title 47 Part 15:2004	Code of Federal Regulations Title 47: Telecommunication Part 15: Radio Frequency Devices
IC Spectrum Management & Telecommunications Policy	Radio Standards Specification RSS-212 Issue 1 (Provisional) - Test Facilities & Test Methods for Radio Equipment RSS-210 Issue 5 - Low Power Licence-Exempt Radiocommunication Devices: November 2001 & Amendment November 30, 2002 RSS-102 Issue 1 (Provisional) - Evaluation Procedure for Mobile and Portable Radio Transmitters with respect to Health Canada's Safety Code 6 for Exposure of Humans to Radio Frequency Fields
FCC Public Notice DA 00-705	Filing and Measurement Guidelines for Frequency Hopping Spread Spectrum Systems Released March 30, 2000

Company:	Itronix Corporation	Model:	IX325A860IWLBT	FCC ID:	KBCIX325A860IWLBT	IC ID:	1943A-IX325g
DUT Type:	IX325 Rugged Tablet PC with MSI MS-6837 Bluetooth & internal PIFA Antenna 3			2402 - 2480 MHz			
2006 Celltech Labs Inc.	This document is not to be reproduced in whole or in part without the prior written permission of Celltech Labs Inc.						Page 6 of 62

	Test Report Serial No.:	042406KBC-T743-E15B	Report Revision No.:	Revision 1.0
	Test Date(s):	18May05 - 14Jul05	Report Issue Date:	November 07, 2006
	Test Standard(s):	FCC 47 CFR §15.247	Industry Canada RSS-210 Issue 5	
	Lab Registration(s):	FCC Lab Reg. # 714830	Industry Canada Lab File # IC 3874	

3.0 TERMS AND DEFINITIONS

AV	Average
CFR	Code of Federal Regulations
dB	decibel
dBm	dB referenced to 1 mW
dBuV	dB referenced to 1 uV
DUT	Device under Test
dBc	dB down from carrier
EBW	Emission Bandwidth
EMC	Electromagnetic Compatibility
FCC	Federal Communication Commission
FHSS	Frequency Hopping Spread Spectrum
HP	Hewlett Packard
HPF	High Pass Filter
Hpol	Horizontal Polarization
Hz	Hertz
IC	Industry Canada
kHz	kilohertz
LNA	Low Noise Amplifier
m	meter
MAP	Mean Average Power
MHz	Megahertz
Mbps	megabits per second
na	not applicable
n/a	not available
PIFA	Planar inverted folded antenna
PK	Peak
PPSD	Peak Power Spectral Density
QP	Quasi-peak
RBW	Resolution Bandwidth
R&S	Rohde & Schwarz
RSS	Radio Standard Specification
SA	Spectrum Analyzer
VBW	Video Bandwidth
Vpol	Vertical Polarization

Company:	Itronix Corporation	Model:	IX325A860IWLBT	FCC ID:	KBCIX325A860IWLBT	IC ID:	1943A-IX325g
DUT Type:	IX325 Rugged Tablet PC with MSI MS-6837 Bluetooth & internal PIFA Antenna 3			2402 - 2480 MHz			
2006 Celltech Labs Inc.	This document is not to be reproduced in whole or in part without the prior written permission of Celltech Labs Inc.						Page 7 of 62

	Test Report Serial No.:	042406KBC-T743-E15B	Report Revision No.:	Revision 1.0
	Test Date(s):	18May05 - 14Jul05	Report Issue Date:	November 07, 2006
	Test Standard(s):	FCC 47 CFR §15.247	Industry Canada RSS-210 Issue 5	
	Lab Registration(s):	FCC Lab Reg. # 714830	Industry Canada Lab File # IC 3874	

4.0 FACILITIES AND ACCREDITATIONS

The facilities used in collecting the test results outlined in this report are located at 1955 Moss Court, Kelowna, British Columbia, Canada, V1Y 9L3. The radiated and conducted emissions sites conform to the requirements set forth in ANSI C63.4 and are filed and listed with the FCC under Registration Number 714830 and Industry Canada under File Number IC 3874.

5.0 GENERAL INFORMATION

5.1 Applicant Information

Company Name:	Itronix Corporation
Address:	12825 E. Mirabeau Parkway Spokane Valley, WA 99216 United States

5.2 DUT Description

The DUT consisted of the IX325 Rugged Tablet PC with the internal MSI MS-6837 Bluetooth Transmitter connected to Internal PIFA Antenna 3 installed in the left side center edge of the DUT. Photographs of the DUT placement and construction are shown in Appendix A.

Device:	Rugged Tablet PC		
Model:	IX325A860IWLBT	Serial Number:	ZZGEG5074ZZ9799
Identifier(s):	FCC ID: KBCIX325A860IWLBT	IC:	1943A-IX325g
Power Source(s):	Delta Electronics 75 Watt AC-DC Power Supply Model: ADP-75 FB B Rev 00 (S/N: UCT030200307)		
	Internal Lithium-ion 11.1 V 3600 mAh Battery Model: T8M-E		
	External Second Lithium-ion 11.1 V 3600 mAh Battery Model: T8S-E		

Device:	2.4GHz FHSS Bluetooth Transmitter		
Model:	Micro-Star International Co. Ltd. MS-6837	Serial Number:	none
Rule Part(s):	FCC: §15.247; §2.1091; §1.1310	IC:	RSS-210 Issue 5 - A1. 11/30/02
Classification:	FCC: Spread Spectrum Transmitter (DSS)	IC:	Low Power Licence-Exempt Transmitter
Power Source:	Powered from the internal PC power supply		

Device:	Internal Bluetooth PIFA Antenna 3		
Model:	Well Green Technology Bluetooth Antenna		
Gain:	-0.81 dBi		

Note: In compliance with the requirements of §15.247 (b) (4), the gain of the antenna used in this DUT is less than 6 dBi, therefore no reduction in the conducted power limit is required.

Company:	Itronix Corporation	Model:	IX325A860IWLBT	FCC ID:	KBCIX325A860IWLBT	IC ID:	1943A-IX325g
DUT Type:	IX325 Rugged Tablet PC with MSI MS-6837 Bluetooth & internal PIFA Antenna 3			2402 - 2480 MHz			
2006 Celltech Labs Inc.	This document is not to be reproduced in whole or in part without the prior written permission of Celltech Labs Inc.						Page 8 of 62

	Test Report Serial No.:	042406KBC-T743-E15B	Report Revision No.:	Revision 1.0
	Test Date(s):	18May05 - 14Jul05	Report Issue Date:	November 07, 2006
	Test Standard(s):	FCC 47 CFR §15.247	Industry Canada RSS-210 Issue 5	
	Lab Registration(s):	FCC Lab Reg. # 714830	Industry Canada Lab File # IC 3874	

5.3 Co-Located Equipment

Device:	GPS Receiver Module
Model:	Leadtek Model LR9805
Device:	GPS Antenna (Receive only)
Model:	Sarantel 101401040/2004UK

5.4 Cable Descriptions

ROUTING		Length m	Model	Terminations		Shield Type	Shield Termination		Suppression
From	To			End 1	End 2		End 1	End 2	
PC Ethernet Port	Ethernet Hub	1.0	N/a	RJ-45	RJ-45	None	na	na	None
PC Ethernet Port	Ethernet Hub	1.0	n/a	RJ-45	RJ-45	None	na	na	None

5.5 Support Equipment

The following equipment was used in support of the DUT.

CO-LOCATED SUPPORT EQUIPMENT LIST		
MANUFACTURER	MODEL	DESCRIPTION
D-Link	DE-809TC/	Ethernet hub
YNG YUH	YP-040	Hub power supply
MLi	699	Speakers
Polk Audio	n/a	Speaker-microphone
	K8255	Keyboard
Sanwa Supply	MA-MBUSB	Mouse

Company:	Itronix Corporation	Model:	IX325A860IWLBT	FCC ID:	KBCIX325A860IWLBT	IC ID:	1943A-IX325g
DUT Type:	IX325 Rugged Tablet PC with MSI MS-6837 Bluetooth & internal PIFA Antenna 3			2402 - 2480 MHz			
2006 Celltech Labs Inc.	This document is not to be reproduced in whole or in part without the prior written permission of Celltech Labs Inc.						Page 9 of 62

	Test Report Serial No.:	042406KBC-T743-E15B	Report Revision No.:	Revision 1.0
	Test Date(s):	18May05 - 14Jul05	Report Issue Date:	November 07, 2006
	Test Standard(s):	FCC 47 CFR §15.247	Industry Canada RSS-210 Issue 5	
	Lab Registration(s):	FCC Lab Reg. # 714830	Industry Canada Lab File # IC 3874	

5.6 Clock Frequencies

5.6.1 DUT Clock Frequencies

Device:	Rugged Tablet PC
Clocks:	n/a
Device:	2.4GHz FHSS Bluetooth Transmitter
Clocks:	n/a
Device:	Internal Bluetooth PIFA Antenna 3
Clocks:	None

5.6.2 Co-Located Clock Frequencies

Device:	Peripherals
Clocks:	n/a

5.7 Mode(s) of Operation Tested

Customer supplied software was used to place the Bluetooth transmitter at the appropriate channel with the power level and modulation for the specific measurement.

TX Frequency Range	2402 - 2480 MHz Ch. 0 (2402 MHz), Ch. 39 (2441 MHz) & Ch. 78 (2480 MHz) measured unless otherwise noted
Software Power Gain Settings	Ch. 0 - 255 / 61 Ch. 39 - 255 / 63 Ch. 78 - 255 / 63
RF Peak Conducted Output Power Tested	Ch. 0 - +3.96 dBm (0.00249 Watts) Ch. 39 - +3.57 dBm (0.00228 Watts) Ch. 78 - +3.44 dBm (0.00221 Watts)
Modulation Type	GFSK 0.5 BT Gaussian
Modulation Frequency	0 for carrier power, TXDATA1 default (PRBS9 payload, packet type DM5) for other measurements
Power Source(s) Tested	All tests were performed with the AC Power Adapter powering the DUT.

5.7.1 DUT Exercising Software Description

The DUT was configured and exercised using customer supplied test software that allowed an operator to set the operating parameters of the Bluetooth transmitter. With the exception of the output power and frequency settings, all other settings were left on their default settings. The power and frequency settings used are described in each appendix.

Company:	Itronix Corporation	Model:	IX325A860IWLBT	FCC ID:	KBCIX325A860IWLBT	IC ID:	1943A-IX325g	
DUT Type:	IX325 Rugged Tablet PC with MSI MS-6837 Bluetooth & internal PIFA Antenna 3			2402 - 2480 MHz				
2006 Celltech Labs Inc.		This document is not to be reproduced in whole or in part without the prior written permission of Celltech Labs Inc.					Page 10 of 62	

	Test Report Serial No.:	042406KBC-T743-E15B	Report Revision No.:	Revision 1.0
	Test Date(s):	18May05 - 14Jul05	Report Issue Date:	November 07, 2006
	Test Standard(s):	FCC 47 CFR §15.247	Industry Canada RSS-210 Issue 5	
	Lab Registration(s):	FCC Lab Reg. # 714830	Industry Canada Lab File # IC 3874	

5.8 Configuration Description

The DUT was configured as described by the client as being representative of what would be delivered to a final customer. More specific details may be included in each appendix.

5.8.1 Configuration Justification

The DUT was tested in a configuration described by the client as being worst-case but typical of normal use.

The transmit power setting for each of these frequencies was set to closely match that defined in the radio modular certification or the default factory setting as defined by the manufacturer. Typical representative modulation was applied when applicable. Unless otherwise specified in the applicable appendices, these settings were used for the measurements described in this report.

Prescan measurements were made with the Bluetooth Transmitter set at each of three frequencies describing the frequency band of operation; low (2402 MHz), mid (2441 MHz) and high (2480 MHz) to determine the highest emission present in each band and possible EUT orientation. The orientation with the highest radiated emissions was used for the final measurements described herein. It was determined the highest radiated emissions emanating from the product described herein resulted with it being set on its edge as shown in the setup photographs in the applicable appendices.

6.0 PASS/FAIL CRITERIA

Unless otherwise noted in the Appendices, the pass/fail criteria is the limit set forth in the reference standards. A DUT is considered to have passed the requirements, if the data collected during the described measurement procedure is no greater than the specified limits as defined. The pass/fail statements made in this report only apply to the unit tested.

Company:	Itronix Corporation	Model:	IX325A860IWLBT	FCC ID:	KBCIX325A860IWLBT	IC ID:	1943A-IX325g
DUT Type:	IX325 Rugged Tablet PC with MSI MS-6837 Bluetooth & internal PIFA Antenna 3			2402 - 2480 MHz			
2006 Celltech Labs Inc.	This document is not to be reproduced in whole or in part without the prior written permission of Celltech Labs Inc.						Page 11 of 62

	Test Report Serial No.:	042406KBC-T743-E15B	Report Revision No.:	Revision 1.0
	Test Date(s):	18May05 - 14Jul05	Report Issue Date:	November 07, 2006
	Test Standard(s):	FCC 47 CFR §15.247	Industry Canada RSS-210 Issue 5	
	Lab Registration(s):	FCC Lab Reg. # 714830	Industry Canada Lab File # IC 3874	

APPENDICES

Company:	Itronix Corporation	Model:	IX325A860IWLBT	FCC ID:	KBCIX325A860IWLBT	IC ID:	1943A-IX325g
DUT Type:	IX325 Rugged Tablet PC with MSI MS-6837 Bluetooth & internal PIFA Antenna 3			2402 - 2480 MHz			
2006 Celltech Labs Inc.	This document is not to be reproduced in whole or in part without the prior written permission of Celltech Labs Inc.						Page 12 of 62

	Test Report Serial No.:	042406KBC-T743-E15B	Report Revision No.:	Revision 1.0
	Test Date(s):	18May05 - 14Jul05	Report Issue Date:	November 07, 2006
	Test Standard(s):	FCC 47 CFR §15.247	Industry Canada RSS-210 Issue 5	
	Lab Registration(s):	FCC Lab Reg. # 714830	Industry Canada Lab File # IC 3874	

Appendix A - Photographs

A.1. DEVICE UNDER TEST (DUT) PHOTOGRAPHS

Photograph A.1-1 - Front of IX325 Tablet PC



Photograph A.1-2 - Back of IX325 Tablet PC





Photograph A.1-3 - Edge of IX325 Tablet PC



Photograph A.1-4 - Side of IX325 Tablet PC



Company:	Itronix Corporation	Model:	IX325A860IWLBT	FCC ID:	KBCIX325A860IWLBT	IC ID:	1943A-IX325g
DUT Type:	IX325 Rugged Tablet PC with MSI MS-6837 Bluetooth & internal PIFA Antenna 3			2402 - 2480 MHz		 <small>A GENERAL DYNAMICS COMPANY</small>	
2006 Celltech Labs Inc.	This document is not to be reproduced in whole or in part without the prior written permission of Celltech Labs Inc.						Page 13 of 62

	Test Report Serial No.:	042406KBC-T743-E15B	Report Revision No.:	Revision 1.0
	Test Date(s):	18May05 - 14Jul05	Report Issue Date:	November 07, 2006
	Test Standard(s):	FCC 47 CFR §15.247	Industry Canada RSS-210 Issue 5	
	Lab Registration(s):	FCC Lab Reg. # 714830	Industry Canada Lab File # IC 3874	

Photograph A.1-5 - Internal Bluetooth Location



Photograph A.1-6 - Left Edge Bluetooth Antenna Location



Company:	Itronix Corporation	Model:	IX325A860IWLBT	FCC ID:	KBCIX325A860IWLBT	IC ID:	1943A-IX325g
DUT Type:	IX325 Rugged Tablet PC with MSI MS-6837 Bluetooth & internal PIFA Antenna 3			2402 - 2480 MHz			
2006 Celltech Labs Inc.	This document is not to be reproduced in whole or in part without the prior written permission of Celltech Labs Inc.						Page 14 of 62

	Test Report Serial No.:	042406KBC-T743-E15B	Report Revision No.:	Revision 1.0
	Test Date(s):	18May05 - 14Jul05	Report Issue Date:	November 07, 2006
	Test Standard(s):	FCC 47 CFR §15.247	Industry Canada RSS-210 Issue 5	
	Lab Registration(s):	FCC Lab Reg. # 714830	Industry Canada Lab File # IC 3874	

Appendix B - Conducted Powerline Emissions Measurement

B.1. REFERENCES	
Normative Reference Standard	CFR 47 FCC Part 15 §15.207
Procedure Reference	ANSI C63.4

B.2. LIMITS		
<p>§15.207: Compliance with the provisions of this paragraph shall be based on the measurement of the radio frequency voltage between each powerline and ground at the power terminal.</p>		
Frequency of Emission (MHz)	Conducted Limit (dBuV)	
	Quasi-Peak	Average
0.15 – 0.5	66 to 56*	56 to 46*
0.50 – 5.0	56	46
5.0 – 30.0	60	50

*Decreases with the logarithm of the frequency

B.3. ENVIRONMENTAL CONDITIONS	
Temperature	+25 ± 5 °C
Humidity	31 % ± 10% RH
Barometric Pressure	101.4 kpa

B.4. EQUIPMENT LIST					
ASSET NUMBER	MANUFACTURER	MODEL	DESCRIPTION	LAST CAL	CAL DUE
00063	HP	85662A	Spectrum Analyzer Display	na	na
00051	HP	8566B	Spectrum Analyzer RF Section	12Apr05	12Apr06
00049	HP	85650A	Quasi-Peak Adapter	13Apr05	13Apr06
00047	HP	85685A	Preselector	13Apr05	13Apr06
00083	EMCO	3825/2	Line Impedance Stabilization Network	26Apr05	26Apr06
00084	EMCO	3825/2	Line Impedance Stabilization Network	26Apr05	26Apr06

Company:	Itronix Corporation	Model:	IX325A860IWLBT	FCC ID:	KBCIX325A860IWLBT	IC ID:	1943A-IX325g
DUT Type:	IX325 Rugged Tablet PC with MSI MS-6837 Bluetooth & internal PIFA Antenna 3			2402 - 2480 MHz			
2006 Celltech Labs Inc.	This document is not to be reproduced in whole or in part without the prior written permission of Celltech Labs Inc.						Page 15 of 62

	Test Report Serial No.:	042406KBC-T743-E15B	Report Revision No.:	Revision 1.0
	Test Date(s):	18May05 - 14Jul05	Report Issue Date:	November 07, 2006
	Test Standard(s):	FCC 47 CFR §15.247	Industry Canada RSS-210 Issue 5	
	Lab Registration(s):	FCC Lab Reg. # 714830	Industry Canada Lab File # IC 3874	

B.5. MEASUREMENT EQUIPMENT SETUP	
MEASUREMENT EQUIPMENT CONNECTIONS	The conducted emissions were measured on each of the two AC powerline leads connected to the DUT's power supply brick. A two line LISN was used to make this measurement. A drawing of the equipment setup is shown in B.7
MEASUREMENT EQUIPMENT SETTINGS	<p>Each of the monitor ports from the 2-line LISN was connected in turn to the spectrum analyzer. The port not connected to the analyzer was terminated in a 50-ohm load. A pre-scan of the peak emission levels was made of the 150 kHz - 30 MHz range split into 4 equal frequency bands. The following were the instrumentation settings:</p> <p>Spectrum Analyzer: Start Frequency and Stop Frequency set by software for each of the four bands RBW: 100 kHz VBW: 300 kHz Sweep: 500 mS</p> <p>Quasi-Peak Adapter: Normal - Automatic Bandwidth Setting: 9 kHz</p> <p>The resulting data from each band was corrected and collected by software and presented in the graphical representations shown in B.9 for the two leads.</p> <p>A defined set of frequency points of interest on each lead were used by software to optimize a set of readings for each type of detector (peak, quasi-peak and average). This data was corrected by the software and is presented in the tables shown in section B.9.</p>

Company:	Itronix Corporation	Model:	IX325A860IWLBT	FCC ID:	KBCIX325A860IWLBT	IC ID:	1943A-IX325g
DUT Type:	IX325 Rugged Tablet PC with MSI MS-6837 Bluetooth & internal PIFA Antenna 3			2402 - 2480 MHz			
2006 Celltech Labs Inc.	This document is not to be reproduced in whole or in part without the prior written permission of Celltech Labs Inc.						Page 16 of 62

	Test Report Serial No.:	042406KBC-T743-E15B	Report Revision No.:	Revision 1.0
	Test Date(s):	18May05 - 14Jul05	Report Issue Date:	November 07, 2006
	Test Standard(s):	FCC 47 CFR §15.247	Industry Canada RSS-210 Issue 5	
	Lab Registration(s):	FCC Lab Reg. # 714830	Industry Canada Lab File # IC 3874	

B.6. SETUP PHOTOS

Photograph B.6-1 - AC Powerline Conducted Emission Configuration



Photograph B.6-2 - AC Powerline Conducted Emission Cable Placement

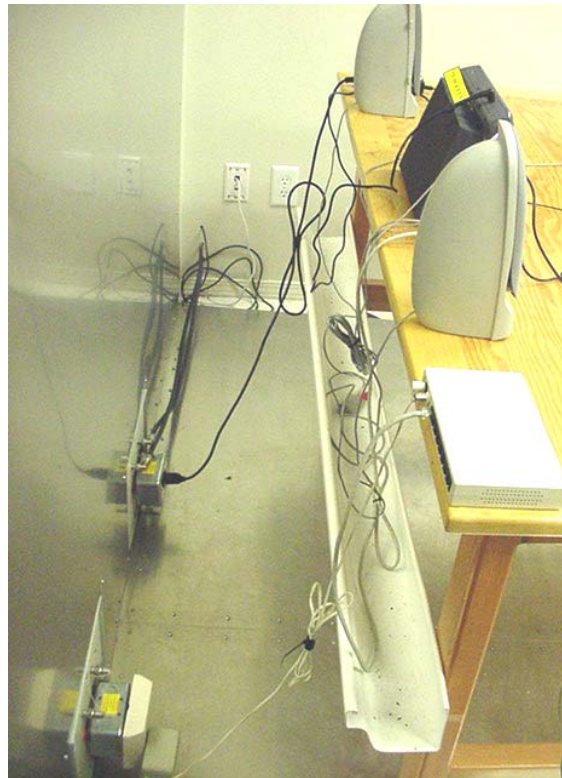

Company:	Itronix Corporation	Model:	IX325A860IWLBT	FCC ID:	KBCIX325A860IWLBT	IC ID:	1943A-IX325g
DUT Type:	IX325 Rugged Tablet PC with MSI MS-6837 Bluetooth & internal PIFA Antenna 3			2402 - 2480 MHz			
2006 Celltech Labs Inc.	This document is not to be reproduced in whole or in part without the prior written permission of Celltech Labs Inc.						Page 17 of 62

 Testing and Engineering Services Lab	Test Report Serial No.:	042406KBC-T743-E15B	Report Revision No.:	Revision 1.0
	Test Date(s):	18May05 - 14Jul05	Report Issue Date:	November 07, 2006
	Test Standard(s):	FCC 47 CFR §15.247	Industry Canada RSS-210 Issue 5	
	Lab Registration(s):	FCC Lab Reg. # 714830	Industry Canada Lab File # IC 3874	

B.7. SETUP DRAWING

Figure B.7-1 - Setup Drawing

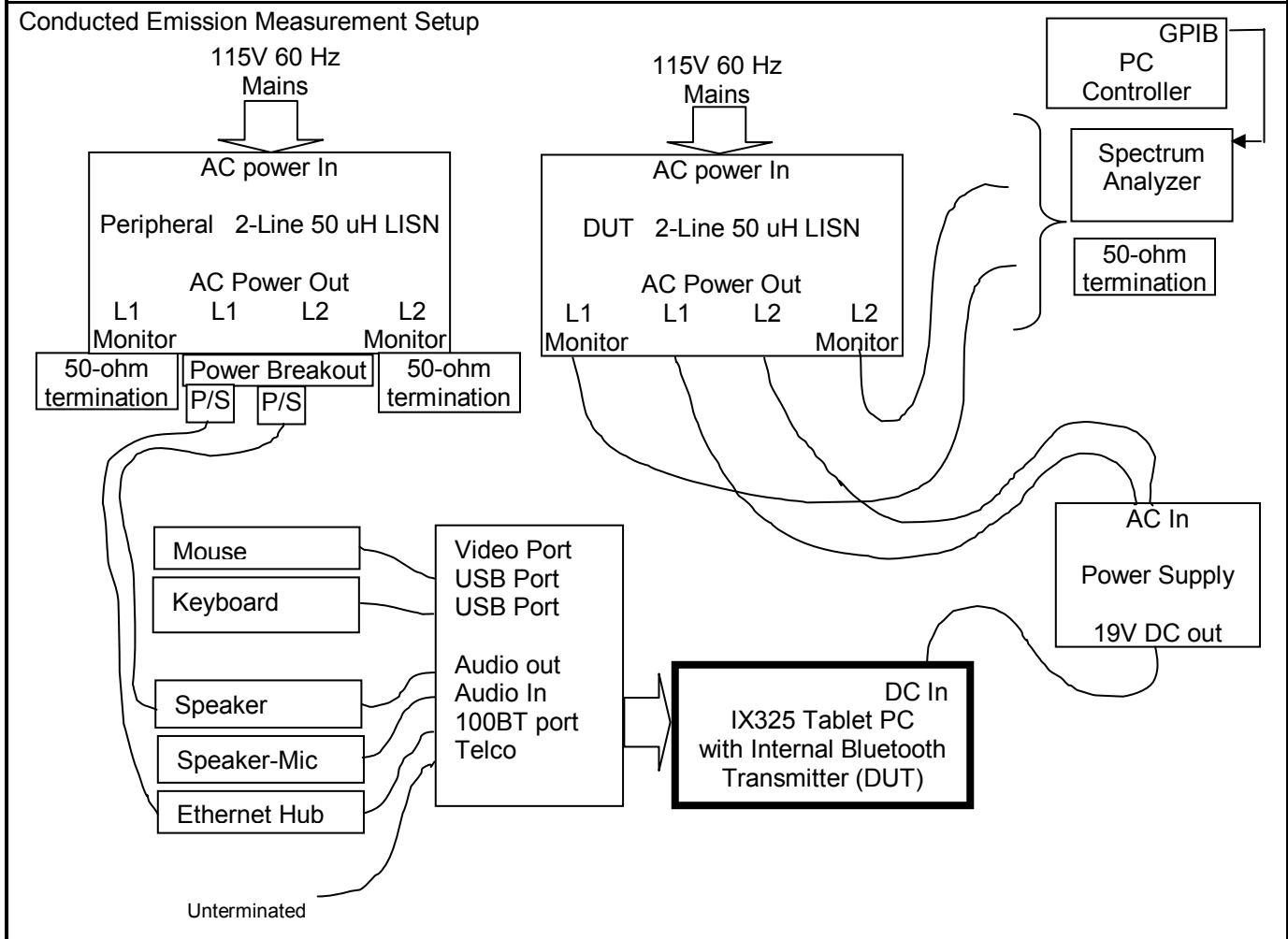

B.8. DUT OPERATING DESCRIPTION

Bluetooth	The Bluetooth transmitter was set to transmit at full power while hopping channels with a TXDATA1 modulation setting.
PC	Other than operating the Bluetooth software and running MS windows, no PC exercising was performed.
Peripherals	All peripherals were active, but no specific traffic was initiated.

Company:	Itronix Corporation	Model:	IX325A860IWLBT	FCC ID:	KBCIX325A860IWLBT	IC ID:	1943A-IX325g	
DUT Type:	IX325 Rugged Tablet PC with MSI MS-6837 Bluetooth & internal PIFA Antenna 3			2402 - 2480 MHz		 <small>A GENERAL DYNAMICS COMPANY</small>		
2006 Celltech Labs Inc.		This document is not to be reproduced in whole or in part without the prior written permission of Celltech Labs Inc.					Page 18 of 62	



Test Report Serial No.:	042406KBC-T743-E15B	Report Revision No.:	Revision 1.0
Test Date(s):	18May05 - 14Jul05	Report Issue Date:	November 07, 2006
Test Standard(s):	FCC 47 CFR §15.247	Industry Canada RSS-210 Issue 5	
Lab Registration(s):	FCC Lab Reg. # 714830	Industry Canada Lab File # IC 3874	

B.9. TEST RESULTS

Following are peak emission plots and tabular data describing the peak, quasi-peak and average measurements made of the DUT.

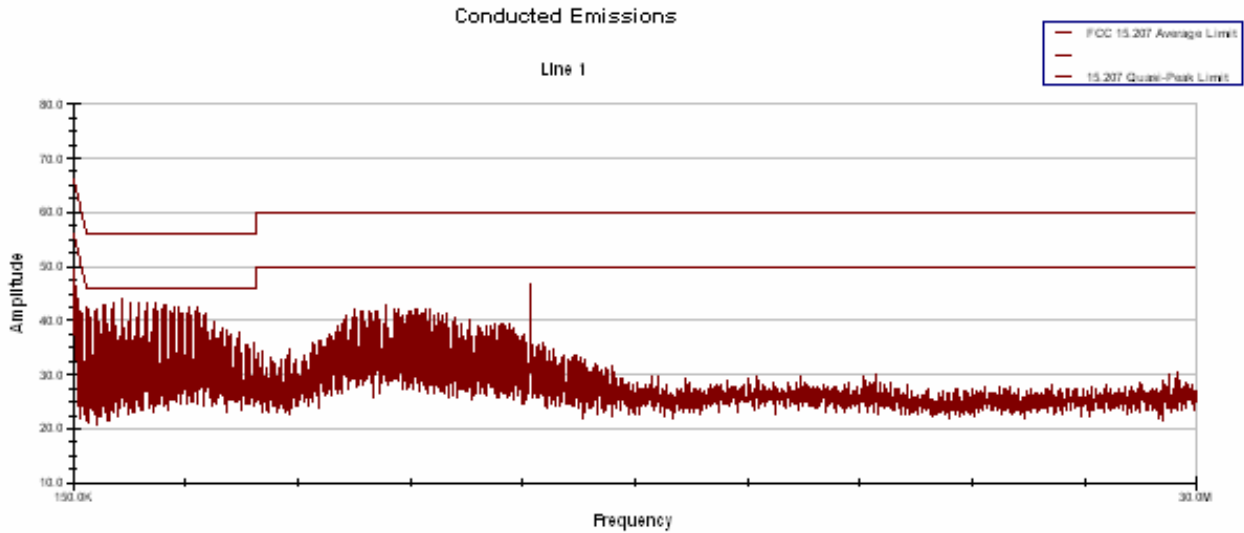

Project Number: KBCIX325-BT
Company: Itronix
Product: IX325 with MSI Bluetooth

Standard: FCC 15.207
Test Start Date: 6-Jun-05
Test End Date: 6-Jun-05

Line 1 Conducted Emissions

Frequency MHz	Uncorrected Reading			Correction Factor dB	Corrected Emission Level			Quasi-Peak Limit dBuV	Quasi-Peak Margin dB	Average Limit dBuV	Average Margin dB	Pass/Fail
	Peak dBuV	Quasi-Peak dBuV	Average dBuV		Peak dBuV	Quasi-Peak dBuV	Average dBuV					
0.173	64.10	54.13	26.16	-1.77	62.33	52.36	12.47	64.83	12.47	54.83	42.36	Pass
0.179	61.80	54.06	25.44	-1.67	60.13	52.39	12.12	64.51	12.12	54.51	42.39	Pass
0.188	61.90	51.82	23.47	-1.56	60.34	50.26	13.88	64.15	13.88	54.15	40.26	Pass
0.195	60.50	49.77	21.06	-1.48	59.02	48.29	15.54	63.82	15.54	53.82	38.29	Pass
0.200	59.70	50.57	30.91	-1.43	58.27	49.14	14.46	63.60	14.46	53.60	39.14	Pass
0.209	59.50	50.79	20.56	-1.34	58.16	49.45	13.78	63.23	13.78	53.23	39.45	Pass
0.261	54.90	45.49	18.20	-0.99	53.91	44.50	16.91	61.41	16.90	51.41	34.50	Pass
0.297	52.50	42.90	15.18	-0.84	51.66	42.06	18.26	60.31	18.25	50.31	32.06	Pass
0.304	52.30	42.80	14.37	-0.82	51.48	41.98	18.15	60.13	18.15	50.13	31.98	Pass
0.412	46.60	36.66	10.18	-0.57	46.03	36.09	21.51	57.60	21.51	47.60	26.09	Pass
1.925	32.80	23.20	11.15	-0.30	32.50	22.90	33.10	56.00	33.10	46.00	12.90	Pass
3.579	36.40	21.63	9.83	-0.31	36.10	21.33	34.68	56.00	34.68	46.00	11.33	Pass
5.028	32.80	18.99	11.00	-0.31	32.50	18.69	41.32	60.00	41.32	50.00	8.69	Pass
6.596	31.60	28.32	24.93	-0.32	31.28	28.00	32.00	60.00	32.00	50.00	18.00	Pass
7.518	31.60	20.33	12.16	-0.33	31.27	20.00	40.00	60.00	40.00	50.00	10.00	Pass
9.182	30.20	18.60	12.45	-0.34	29.86	18.26	41.74	60.00	41.74	50.00	8.26	Pass
10.421	30.50	19.03	12.90	-0.34	30.16	18.69	41.31	60.00	41.31	50.00	8.69	Pass

Corrected Emission Level (dBuV) = Uncorrected Reading (dBuV) + Correction Factor (dB)
 Margin (dB) = Limit (dBuV) - Corrected Emission Level (dBuV)

Company:	Itronix Corporation	Model:	IX325A860IWLBT	FCC ID:	KBCIX325A860IWLBT	IC ID:	1943A-IX325g
DUT Type:	IX325 Rugged Tablet PC with MSI MS-6837 Bluetooth & internal PIFA Antenna 3			2402 - 2480 MHz		ITRONIX <small>A GENERAL DYNAMICS COMPANY</small>	
2006 Celltech Labs Inc.	This document is not to be reproduced in whole or in part without the prior written permission of Celltech Labs Inc.						Page 19 of 62



Test Report Serial No.:	042406KBC-T743-E15B	Report Revision No.:	Revision 1.0
Test Date(s):	18May05 - 14Jul05	Report Issue Date:	November 07, 2006
Test Standard(s):	FCC 47 CFR §15.247	Industry Canada RSS-210 Issue 5	
Lab Registration(s):	FCC Lab Reg. # 714830	Industry Canada Lab File # IC 3874	

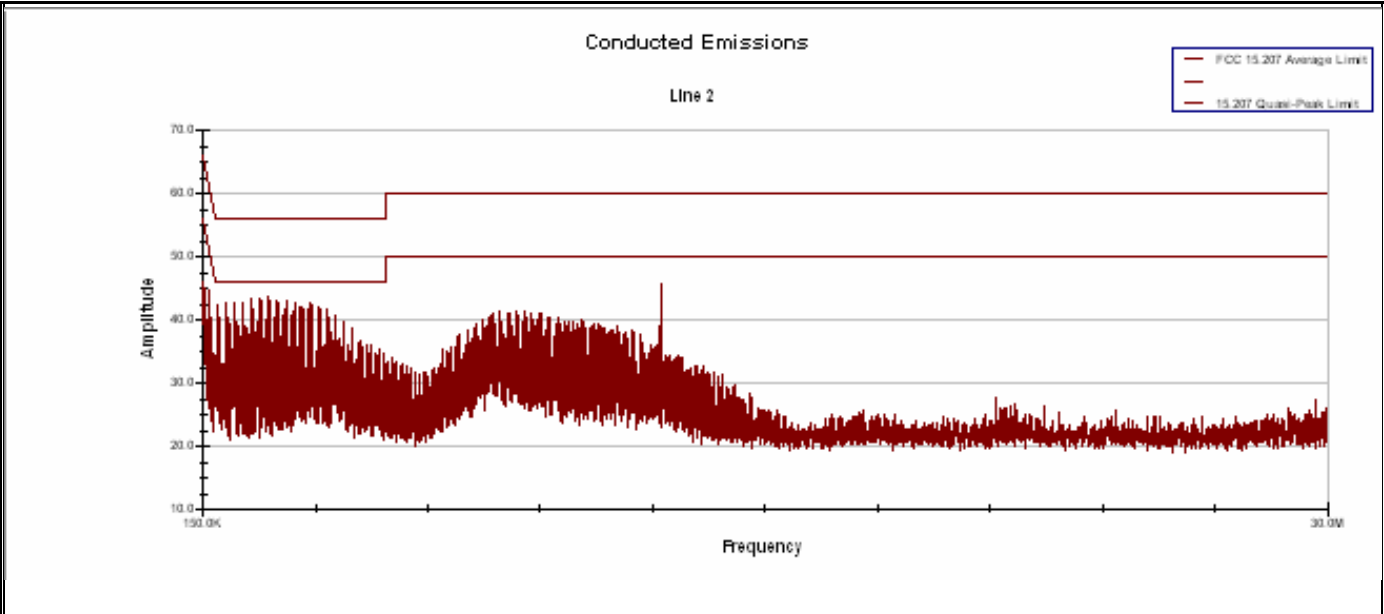

Project Number: KBCIX325-BT
Company: Itronix
Product: IX325 with MSI Bluetooth

Standard: FCC 15.207
Test Start Date: 6-Jun-05
Test End Date: 6-Jun-05

Line 2 Conducted Emissions												
Frequency MHz	Uncorrected Reading			Correction Factor dB	Corrected Emission Level			Quasi-Peak Limit dBuV	Quasi-Peak Margin dB	Average Limit dBuV	Average Margin dB	Pass/Fail
	Peak dBuV	Quasi-Peak dBuV	Average dBuV		Peak dBuV	Quasi-Peak dBuV	Average dBuV					
0.158	65.30	56.03	28.93	-2.01	63.29	54.02	11.55	65.57	11.55	55.57	44.02	Pass
0.165	64.90	55.50	27.59	-1.89	63.01	53.61	11.60	65.21	11.60	55.21	43.61	Pass
0.186	61.40	51.78	23.83	-1.59	59.81	50.19	14.02	64.21	14.02	54.21	40.19	Pass
0.204	61.00	51.31	32.01	-1.40	59.60	49.91	13.55	63.46	13.55	53.46	39.91	Pass
0.209	59.90	50.87	20.77	-1.35	58.55	49.52	13.71	63.23	13.71	53.23	39.52	Pass
0.223	58.60	49.28	18.73	-1.23	57.37	48.05	14.67	62.71	14.67	52.71	38.05	Pass
0.238	57.40	47.64	17.08	-1.13	56.27	46.51	15.65	62.16	15.65	52.16	36.51	Pass
0.275	53.80	44.91	14.01	-0.94	52.86	43.97	16.99	60.96	16.99	50.96	33.97	Pass
0.335	51.60	42.14	37.68	-0.72	50.88	41.42	17.92	59.34	17.92	49.34	31.42	Pass
0.345	49.60	40.07	9.27	-0.69	48.91	39.38	19.72	59.09	19.71	49.09	29.38	Pass
3.099	37.60	33.94	32.58	-0.29	37.31	33.65	22.35	56.00	22.35	46.00	23.65	Pass
3.518	31.10	22.97	11.72	-0.30	30.81	22.68	33.33	56.00	33.33	46.00	12.68	Pass
4.779	32.40	28.01	24.26	-0.30	32.10	27.71	28.29	56.00	28.29	46.00	17.71	Pass
6.329	32.10	28.51	25.78	-0.34	31.76	28.17	31.83	60.00	31.83	50.00	18.17	Pass
10.229	31.10	27.03	24.23	-0.34	30.77	26.70	33.31	60.00	33.31	50.00	16.70	Pass
13.732	28.00	21.33	17.58	-0.37	27.63	20.96	39.04	60.00	39.04	50.00	10.96	Pass

Corrected Emission Level (dBuV) = Uncorrected Reading (dBuV) + Correction Factor (dB)
 Margin (dB) = Limit (dBuV) - Corrected Emission Level (dBuV)

Company:	Itronix Corporation	Model:	IX325A860IWLBT	FCC ID:	KBCIX325A860IWLBT	IC ID:	1943A-IX325g	
DUT Type:	IX325 Rugged Tablet PC with MSI MS-6837 Bluetooth & internal PIFA Antenna 3			2402 - 2480 MHz		ITRONIX <small>A GENERAL DYNAMICS COMPANY</small>		
2006 Celltech Labs Inc.		This document is not to be reproduced in whole or in part without the prior written permission of Celltech Labs Inc.					Page 20 of 62	

	Test Report Serial No.:	042406KBC-T743-E15B	Report Revision No.:	Revision 1.0
	Test Date(s):	18May05 - 14Jul05	Report Issue Date:	November 07, 2006
	Test Standard(s):	FCC 47 CFR §15.247	Industry Canada RSS-210 Issue 5	
	Lab Registration(s):	FCC Lab Reg. # 714830	Industry Canada Lab File # IC 3874	

B.10. PASS/FAIL

In reference to the results outlined in B.9 the DUT passes the requirements as stated in the reference standards as follows:

The RF voltage measured in reference to ground on each of the power line conductors does not exceed the limits as outline in FCC 15.207.

The emission measured on Line 1 with the least margin to the limit was measured with a QP detector at 179 kHz and has a margin of 12.12 dB. The emission measured on Line 2 with the least margin to the limit was measured with a QP detector at 158 kHz and has a margin of 11.55 dB.

B.11. SIGN-OFF

I attest to the accuracy of the data. All measurements reported herein were performed by me and are correct to the best of my knowledge and belief. I assume full responsibility for the completeness of these measurements.



Russell Pipe
Senior Compliance Technologist
Celltech Labs Inc.

6Jun05
Date

Company:	Itronix Corporation	Model:	IX325A860IWLBT	FCC ID:	KBCIX325A860IWLBT	IC ID:	1943A-IX325g
DUT Type:	IX325 Rugged Tablet PC with MSI MS-6837 Bluetooth & internal PIFA Antenna 3			2402 - 2480 MHz			
2006 Celltech Labs Inc.	This document is not to be reproduced in whole or in part without the prior written permission of Celltech Labs Inc.						Page 21 of 62

	Test Report Serial No.:	042406KBC-T743-E15B	Report Revision No.:	Revision 1.0
	Test Date(s):	18May05 - 14Jul05	Report Issue Date:	November 07, 2006
	Test Standard(s):	FCC 47 CFR §15.247	Industry Canada RSS-210 Issue 5	
	Lab Registration(s):	FCC Lab Reg. # 714830	Industry Canada Lab File # IC 3874	

Appendix C - Peak Conducted RF Output Power Measurement

C.1. REFERENCES	
Normative Reference Standard	FCC CFR 47 §15.247(b) (1)
Procedure Reference	FCC 97-114

C.2. LIMITS	
C.2.1. FCC CFR 47	
<p>§15.247(b): The maximum peak output power of the intentional radiator shall not exceed the following: §15.247(b) (1) For frequency hopping systems operating in the 2400 – 2483.5 MHz band employing at least 75 hopping channels, and all frequency hopping systems in the 5725 – 5850 MHz bands: 1 Watt.*</p>	

*Appendix E results confirm the number of hopping channels is at least 75.

C.3. ENVIRONMENTAL CONDITIONS	
Temperature	+25 ± 5 °C
Humidity	31 % ± 10% RH
Barometric Pressure	101.4 kpa

C.4. EQUIPMENT LIST					
ASSET NUMBER	MANUFACTURER	MODEL	DESCRIPTION	LAST CAL	CAL DUE
00015	Agilent	E4408B	Spectrum Analyzer	24Jan05	24Jan06
00075	Alpha Wire-J	9223	1ft. RG223/U RF Cable	na*	na
00076	Pasternack	PE7014-30	30dB 2 Watt Attenuator	na*	na

*Cable and attenuator verified with power meter prior to use

C.5. MEASUREMENT EQUIPMENT SETUP	
Measurement Equipment Connections	The equipment was connected as shown in the setup drawing in B.6.
Measurement Equipment Settings	To evaluate the maximum peak power, with the following spectrum analyzer settings were used: RBW – 1 MHz VBW – 1 MHz Detector – Peak Trace – Max Hold Span -12 MHz
Measurement Procedure	A PC controller was used to record the spectrum analyzer display and pick the maximum level.

Company:	Itronix Corporation	Model:	IX325A860IWLBT	FCC ID:	KBCIX325A860IWLBT	IC ID:	1943A-IX325g
DUT Type:	IX325 Rugged Tablet PC with MSI MS-6837 Bluetooth & internal PIFA Antenna 3			2402 - 2480 MHz			
2006 Celltech Labs Inc.	This document is not to be reproduced in whole or in part without the prior written permission of Celltech Labs Inc.						Page 22 of 62

	Test Report Serial No.:	042406KBC-T743-E15B	Report Revision No.:	Revision 1.0
	Test Date(s):	18May05 - 14Jul05	Report Issue Date:	November 07, 2006
	Test Standard(s):	FCC 47 CFR §15.247	Industry Canada RSS-210 Issue 5	
	Lab Registration(s):	FCC Lab Reg. # 714830	Industry Canada Lab File # IC 3874	

C.6. SETUP DRAWING

Figure C.6-1 - Setup Drawing

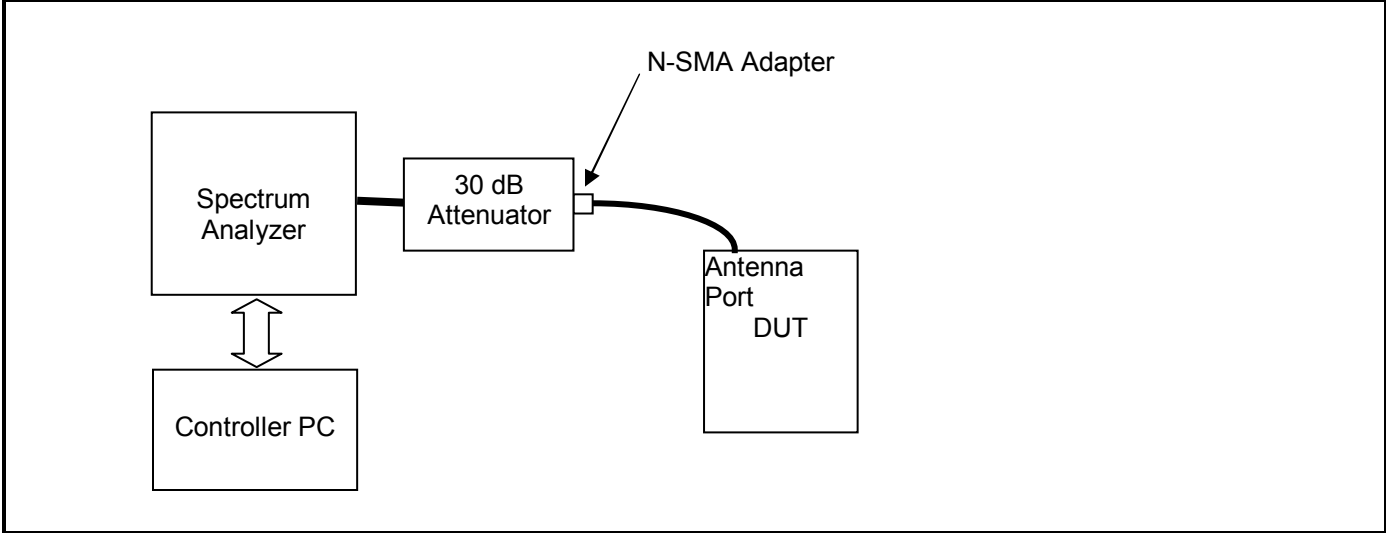

C.7. DUT OPERATING DESCRIPTION

The unmodulated carrier was set for its maximum rated power output or setting at each of the three frequencies representing the frequency band of operation.

Company:	Itronix Corporation	Model:	IX325A860IWLBT	FCC ID:	KBCIX325A860IWLBT	IC ID:	1943A-IX325g
DUT Type:	IX325 Rugged Tablet PC with MSI MS-6837 Bluetooth & internal PIFA Antenna 3			2402 - 2480 MHz			
2006 Celltech Labs Inc.	This document is not to be reproduced in whole or in part without the prior written permission of Celltech Labs Inc.						Page 23 of 62

	Test Report Serial No.:	042406KBC-T743-E15B	Report Revision No.:	Revision 1.0
	Test Date(s):	18May05 - 14Jul05	Report Issue Date:	November 07, 2006
	Test Standard(s):	FCC 47 CFR §15.247	Industry Canada RSS-210 Issue 5	
	Lab Registration(s):	FCC Lab Reg. # 714830	Industry Canada Lab File # IC 3874	

C.8. TEST RESULTS					
Channel	Power Settings	Frequency	Peak Conducted Power		Limit
			Power (ext/int)	MHz	
Low	255/61	2402	+3.96	0.00249	1
Mid	255/63	2441	+3.57	0.00228	1
High	255/63	2480	+3.44	0.00221	1

C.9. PASS/FAIL
<p>In reference to the results outlined in C.8, the DUT passes the requirements as stated in the reference standards as follows:</p> <p><u>§15.247(b): The maximum peak output power of the intentional radiator shall not exceed the following:</u> <u>§15.247(b) (1) For frequency hopping systems operating in the 2400 - 2483.5 MHz band employing at least 75 hopping channels, and all frequency hopping systems in the 5725 - 5850 MHz bands: 1 Watt</u></p> <p>The number of hopping channels is greater than 75 and the maximum power recorded was measured for Channel 0 at 0.00249 Watts (+3.96 dBm) when the DUT was set as defined.</p>

C.10. SIGN-OFF
<p>I attest to the accuracy of the data. All measurements reported herein were performed by me and are correct to the best of my knowledge and belief. I assume full responsibility for the completeness of these measurements.</p> <p></p> <p>_____ Russell Pipe Senior Compliance Technologist Celltech Labs Inc.</p> <p>_____ 14Jul05 Date</p>

Company:	Itronix Corporation	Model:	IX325A860IWLBT	FCC ID:	KBCIX325A860IWLBT	IC ID:	1943A-IX325g
DUT Type:	IX325 Rugged Tablet PC with MSI MS-6837 Bluetooth & internal PIFA Antenna 3			2402 - 2480 MHz			
2006 Celltech Labs Inc.	This document is not to be reproduced in whole or in part without the prior written permission of Celltech Labs Inc.						Page 24 of 62

	Test Report Serial No.:	042406KBC-T743-E15B	Report Revision No.:	Revision 1.0
	Test Date(s):	18May05 - 14Jul05	Report Issue Date:	November 07, 2006
	Test Standard(s):	FCC 47 CFR §15.247	Industry Canada RSS-210 Issue 5	
	Lab Registration(s):	FCC Lab Reg. # 714830	Industry Canada Lab File # IC 3874	

Appendix D - Adjacent Channel Separation

D.1. REFERENCES	
Normative Reference Standard	FCC CFR 47 §15.247 (a) (1)
Test Reference	FCC Public Notice DA 00-705 released March 30, 2000

D.2. LIMITS	
<p>§15.247(a) (1): Frequency hopping systems shall have hopping channel carrier frequencies separated by a minimum of 25 kHz or 20 dB bandwidth of the hopping channel, whichever is greater.</p>	

Note: The 20 dB bandwidth of the hopping channel as outlined in Appendix G is 989.33 kHz. Therefore the channel separation must be at least 989.33 kHz.

D.3. ENVIRONMENTAL CONDITIONS	
Temperature	+25 ± 5 °C
Humidity	31 % ± 10% RH
Barometric Pressure	101.4 kpa

D.4. EQUIPMENT LIST					
ASSET NUMBER	MANUFACTURER	MODEL	DESCRIPTION	LAST CAL	CAL DUE
00015	Agilent	E4408B	Spectrum Analyzer	24Jan05	24Jan06
00075	Alpha Wire-J	9223	1ft. RG223/U RF Cable	na*	na
00076	Pasternack	PE7014-30	30dB 2 Watt Attenuator	na*	na

*Cable and attenuator verified with power meter prior to use

Company:	Itronix Corporation	Model:	IX325A860IWLBT	FCC ID:	KBCIX325A860IWLBT	IC ID:	1943A-IX325g
DUT Type:	IX325 Rugged Tablet PC with MSI MS-6837 Bluetooth & internal PIFA Antenna 3			2402 - 2480 MHz			
2006 Celltech Labs Inc.	This document is not to be reproduced in whole or in part without the prior written permission of Celltech Labs Inc.						Page 25 of 62

	Test Report Serial No.:	042406KBC-T743-E15B	Report Revision No.:	Revision 1.0
	Test Date(s):	18May05 - 14Jul05	Report Issue Date:	November 07, 2006
	Test Standard(s):	FCC 47 CFR §15.247	Industry Canada RSS-210 Issue 5	
	Lab Registration(s):	FCC Lab Reg. # 714830	Industry Canada Lab File # IC 3874	

D.5. MEASUREMENT EQUIPMENT SETUP

Measurement Equipment Connections	The equipment was connected as shown in the setup drawing in D.6.
Measurement Equipment Settings	The channel separation is measured within the band with the following spectrum analyzer settings: Span – 2 MHz RBW – 100 kHz VBW – 300 MHz Sweep – 5 mS Detector – Peak Trace - Max Hold

D.6. SETUP DRAWING

Figure D.6-1 - Setup Drawing

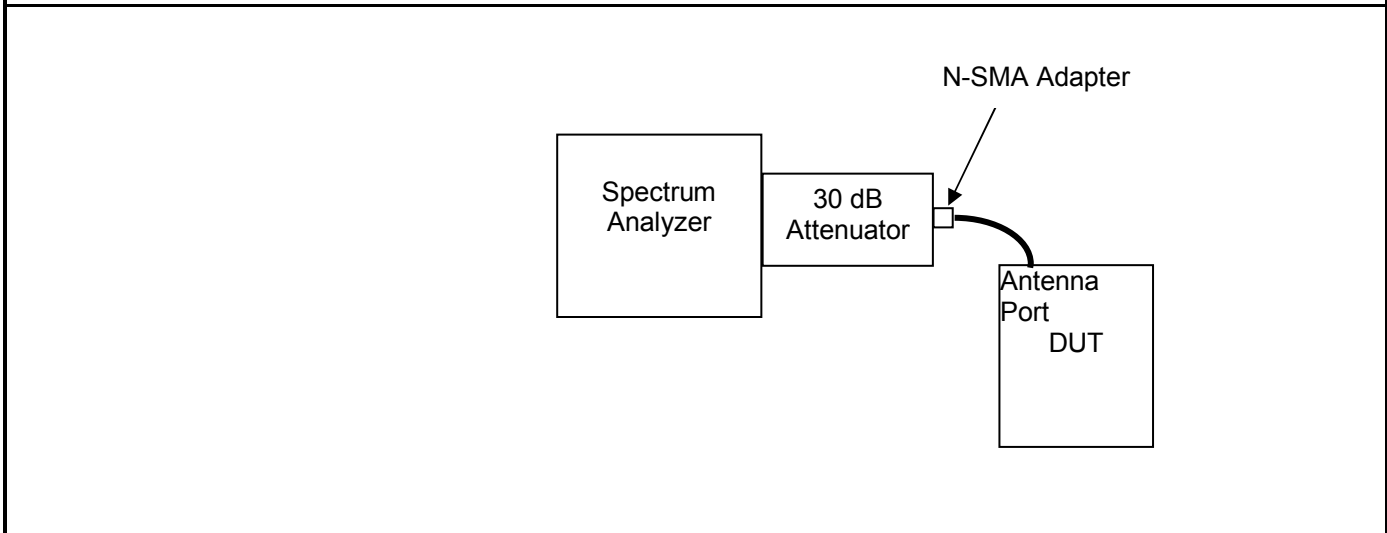

D.7. DUT OPERATING DESCRIPTION

The channel separation measurement was performed with the DUT set at max power and to hop through the channels with the analyzer set for max hold. Two adjacent channels near the mid channel (Channel 38 and 39) are captured on the display. Pseudo-random data was used to modulate the signal.

Company:	Itronix Corporation	Model:	IX325A860IWLBT	FCC ID:	KBCIX325A860IWLBT	IC ID:	1943A-IX325g
DUT Type:	IX325 Rugged Tablet PC with MSI MS-6837 Bluetooth & internal PIFA Antenna 3			2402 - 2480 MHz			
2006 Celltech Labs Inc.	This document is not to be reproduced in whole or in part without the prior written permission of Celltech Labs Inc.						Page 26 of 62



Test Report Serial No.:	042406KBC-T743-E15B	Report Revision No.:	Revision 1.0
Test Date(s):	18May05 - 14Jul05	Report Issue Date:	November 07, 2006
Test Standard(s):	FCC 47 CFR §15.247	Industry Canada RSS-210 Issue 5	
Lab Registration(s):	FCC Lab Reg. # 714830	Industry Canada Lab File # IC 3874	

D.8. TEST RESULTS

IX325 BT - Channel Separation Δ Mkr1 1.000 MHz
 Ref 24.41 dBm Atten 5 dB 0.057 dB

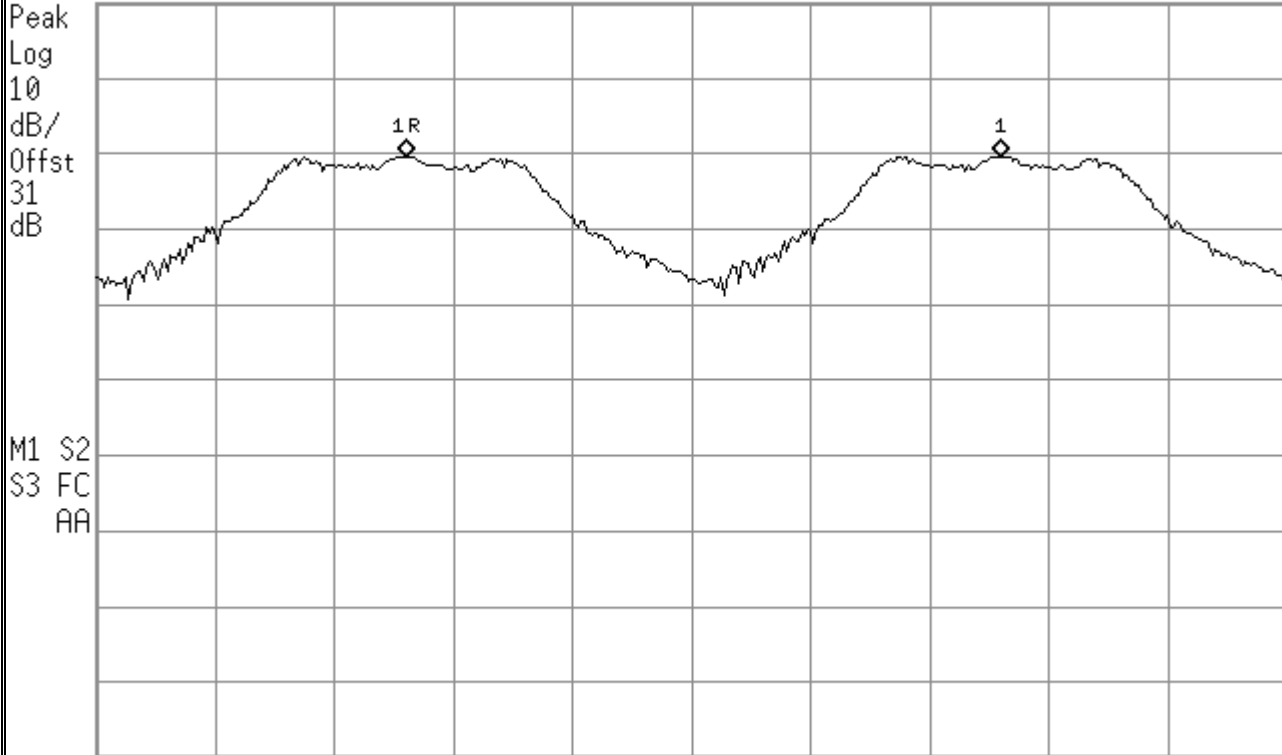

Center 2.441 GHz Span 2 MHz
 #Res BW 100 kHz #VBW 300 kHz Sweep 5 ms (401 pts)

Company:	Itronix Corporation	Model:	IX325A860IWLBT	FCC ID:	KBCIX325A860IWLBT	IC ID:	1943A-IX325g
DUT Type:	IX325 Rugged Tablet PC with MSI MS-6837 Bluetooth & internal PIFA Antenna 3			2402 - 2480 MHz		ITRONIX <small>A GENERAL DYNAMICS COMPANY</small>	
2006 Celltech Labs Inc.	This document is not to be reproduced in whole or in part without the prior written permission of Celltech Labs Inc.						Page 27 of 62

	Test Report Serial No.:	042406KBC-T743-E15B	Report Revision No.:	Revision 1.0
	Test Date(s):	18May05 - 14Jul05	Report Issue Date:	November 07, 2006
	Test Standard(s):	FCC 47 CFR §15.247	Industry Canada RSS-210 Issue 5	
	Lab Registration(s):	FCC Lab Reg. # 714830	Industry Canada Lab File # IC 3874	

D.9. PASS/FAIL

In reference to the results outlined in D.8, the DUT passes the requirements as stated in the reference standards as follows:

§15.247(a) (1): Frequency hopping systems shall have hopping channel carrier frequencies separated by a minimum of 25 kHz or 20 dB bandwidth of the hopping channel, whichever is greater.

The channel separation measured between Channel 38 and 39 was 1 MHz, which is greater than 25 kHz and greater than the 20 dB bandwidth, outlined in Appendix G.

D.10. SIGN-OFF

I attest to the accuracy of the data. All measurements reported herein were performed by me and are correct to the best of my knowledge and belief. I assume full responsibility for the completeness of these measurements.



 Russell Pipe
 Senior Compliance Technologist
 Celltech Labs Inc.

 3Jun05
 Date

Company:	Itronix Corporation	Model:	IX325A860IWLBT	FCC ID:	KBCIX325A860IWLBT	IC ID:	1943A-IX325g
DUT Type:	IX325 Rugged Tablet PC with MSI MS-6837 Bluetooth & internal PIFA Antenna 3			2402 - 2480 MHz			
2006 Celltech Labs Inc.	This document is not to be reproduced in whole or in part without the prior written permission of Celltech Labs Inc.						Page 28 of 62

	Test Report Serial No.:	042406KBC-T743-E15B	Report Revision No.:	Revision 1.0
	Test Date(s):	18May05 - 14Jul05	Report Issue Date:	November 07, 2006
	Test Standard(s):	FCC 47 CFR §15.247	Industry Canada RSS-210 Issue 5	
	Lab Registration(s):	FCC Lab Reg. # 714830	Industry Canada Lab File # IC 3874	

Appendix E - Number of Hopping Channels

E.1. REFERENCES	
Normative Reference Standard	FCC CFR 47 §15.247 (a) (1) (iii)
Test Reference	FCC Public Notice DA 00-705 released March 30, 2000

E.2. LIMITS	
<i>§15.247 (a) (1) (iii): Frequency hopping systems in the 2400 – 2483.5 MHz band shall use at least 15 non-overlapping channels.</i>	

E.3. ENVIRONMENTAL CONDITIONS	
Temperature	+25 ± 5 °C
Humidity	31 % ± 10% RH
Barometric Pressure	101.4 kpa

E.4. EQUIPMENT LIST					
ASSET NUMBER	MANUFACTURER	MODEL	DESCRIPTION	LAST CAL	CAL DUE
00015	Agilent	E4408B	Spectrum Analyzer	24Jan05	24Jan06
00075	Alpha Wire-J	9223	1ft. RG223/U RF Cable	na*	na
00076	Pasternack	PE7014-30	30dB 2 Watt Attenuator	na*	na

*Cable and attenuator verified with power meter prior to use

Company:	Itronix Corporation	Model:	IX325A860IWLBT	FCC ID:	KBCIX325A860IWLBT	IC ID:	1943A-IX325g
DUT Type:	IX325 Rugged Tablet PC with MSI MS-6837 Bluetooth & internal PIFA Antenna 3			2402 - 2480 MHz			
2006 Celltech Labs Inc.	This document is not to be reproduced in whole or in part without the prior written permission of Celltech Labs Inc.						Page 29 of 62

	Test Report Serial No.:	042406KBC-T743-E15B	Report Revision No.:	Revision 1.0
	Test Date(s):	18May05 - 14Jul05	Report Issue Date:	November 07, 2006
	Test Standard(s):	FCC 47 CFR §15.247	Industry Canada RSS-210 Issue 5	
	Lab Registration(s):	FCC Lab Reg. # 714830	Industry Canada Lab File # IC 3874	

E.5. MEASUREMENT EQUIPMENT SETUP

Measurement Equipment Connections	The equipment was connected as shown in the setup drawing in E.6.
Measurement Equipment Settings	<p>The number of hopping channels is measured within the band with the following spectrum analyzer settings:</p> <ul style="list-style-type: none"> Span – 100 MHz RBW – 100 kHz VBW – 1 MHz Sweep – 21.74 mS Detector – Peak Trace - Max Hold

E.6. SETUP DRAWING

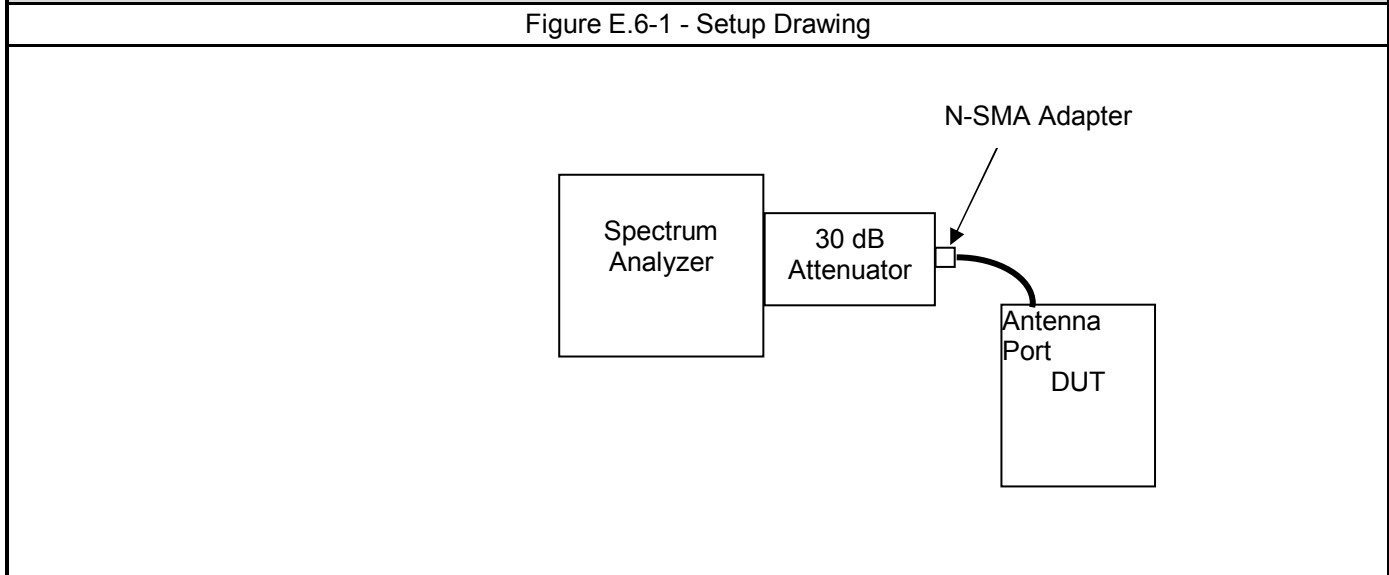

E.7. DUT OPERATING DESCRIPTION

The number of hopping channels is measurement with the DUT set at max power and to hop through the channels for a sufficient period of time for a display capture using the analyzer set for max hold.

Company:	Itronix Corporation	Model:	IX325A860IWLBT	FCC ID:	KBCIX325A860IWLBT	IC ID:	1943A-IX325g
DUT Type:	IX325 Rugged Tablet PC with MSI MS-6837 Bluetooth & internal PIFA Antenna 3			2402 - 2480 MHz			
2006 Celltech Labs Inc.	This document is not to be reproduced in whole or in part without the prior written permission of Celltech Labs Inc.						Page 30 of 62

Test Report Serial No.:	042406KBC-T743-E15B	Report Revision No.:	Revision 1.0
Test Date(s):	18May05 - 14Jul05	Report Issue Date:	November 07, 2006
Test Standard(s):	FCC 47 CFR §15.247	Industry Canada RSS-210 Issue 5	
Lab Registration(s):	FCC Lab Reg. # 714830	Industry Canada Lab File # IC 3874	

E.8. TEST RESULTS

IX325 BT Number of Hopping Channels

Ref 136 dB μ V #Atten 5 dB

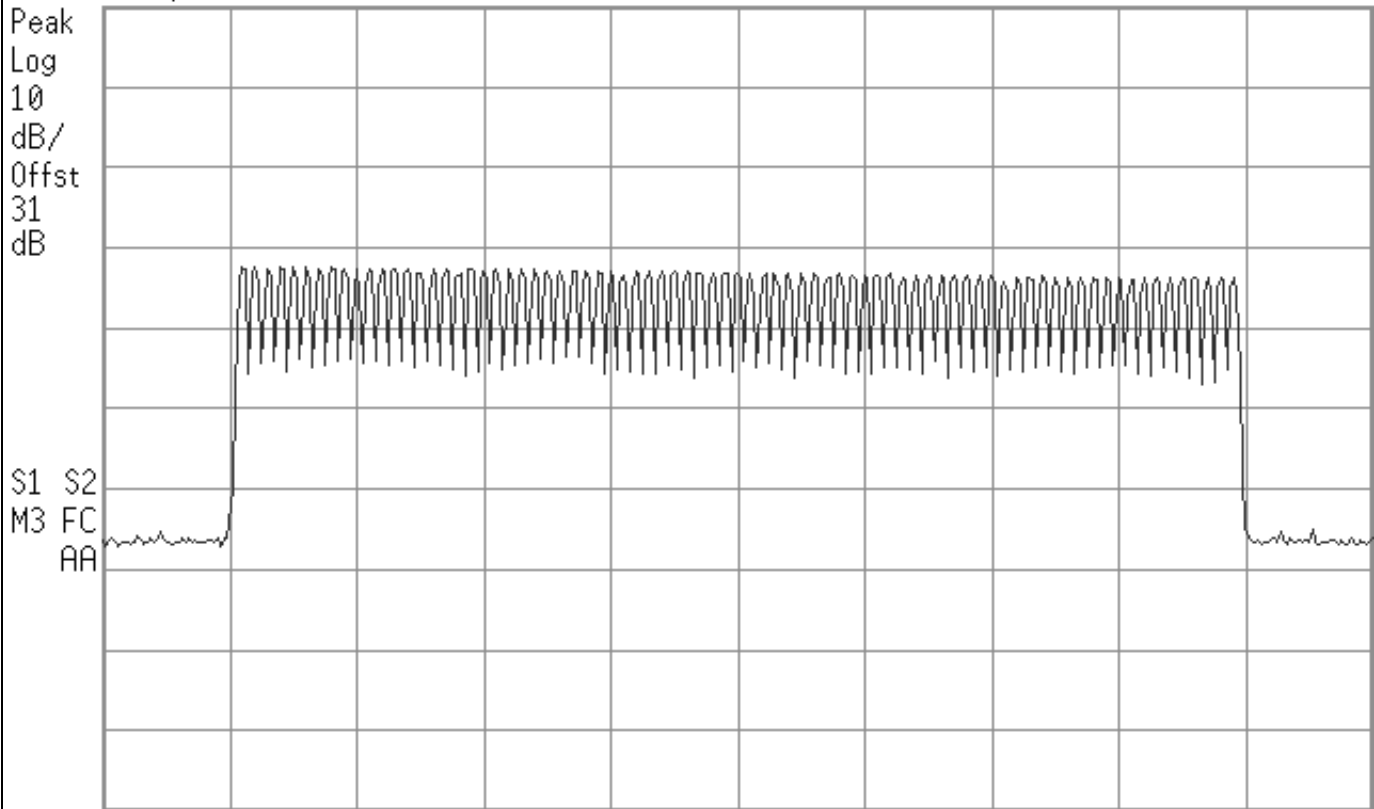

Center 2.441 GHz Span 100 MHz
 #Res BW 100 kHz #VBW 1 MHz Sweep 21.74 ms (401 pts)

Company:	Itronix Corporation	Model:	IX325A860IWLBT	FCC ID:	KBCIX325A860IWLBT	IC ID:	1943A-IX325g
DUT Type:	IX325 Rugged Tablet PC with MSI MS-6837 Bluetooth & internal PIFA Antenna 3			2402 - 2480 MHz		ITRONIX <small>A GENERAL DYNAMICS COMPANY</small>	
2006 Celltech Labs Inc.	This document is not to be reproduced in whole or in part without the prior written permission of Celltech Labs Inc.						Page 31 of 62

	Test Report Serial No.:	042406KBC-T743-E15B	Report Revision No.:	Revision 1.0
	Test Date(s):	18May05 - 14Jul05	Report Issue Date:	November 07, 2006
	Test Standard(s):	FCC 47 CFR §15.247	Industry Canada RSS-210 Issue 5	
	Lab Registration(s):	FCC Lab Reg. # 714830	Industry Canada Lab File # IC 3874	

E.9. PASS/FAIL

In reference to the results outlined in E.8, the DUT passes the requirements as stated in the reference standards as follows:
 §15.247 (a) (1) (iii): Frequency hopping systems in the 2400 - 2483.5 MHz band shall use at least 15 non-overlapping channels
 The 79 channels measured and shown in the plot presented.

E.10. SIGN-OFF

I attest to the accuracy of the data. All measurements reported herein were performed by me and are correct to the best of my knowledge and belief. I assume full responsibility for the completeness of these measurements.



 Russell Pipe
 Senior Compliance Technologist
 Celltech Labs Inc.

 18May05
 Date

Company:	Itronix Corporation	Model:	IX325A860IWLBT	FCC ID:	KBCIX325A860IWLBT	IC ID:	1943A-IX325g
DUT Type:	IX325 Rugged Tablet PC with MSI MS-6837 Bluetooth & internal PIFA Antenna 3			2402 - 2480 MHz		 <small>A GENERAL DYNAMICS COMPANY</small>	
2006 Celltech Labs Inc.	This document is not to be reproduced in whole or in part without the prior written permission of Celltech Labs Inc.						Page 32 of 62

	Test Report Serial No.:	042406KBC-T743-E15B	Report Revision No.:	Revision 1.0
	Test Date(s):	18May05 - 14Jul05	Report Issue Date:	November 07, 2006
	Test Standard(s):	FCC 47 CFR §15.247	Industry Canada RSS-210 Issue 5	
	Lab Registration(s):	FCC Lab Reg. # 714830	Industry Canada Lab File # IC 3874	

Appendix F - Channel Dwell Time

F.1. REFERENCES	
Normative Reference Standard	FCC CFR 47 §15.247 (a) (1), FCC CFR 47 §15.247 (a) (1) (iii)
Test Reference	FCC Public Notice DA 00-705 released March 30, 2000

F.2. LIMITS	
<p>§15.247 (a) (1):The system shall hop to channel frequencies that are selected at the hopping rate from a pseudorandomly ordered list of hopping frequencies. Each frequency must be used equally on the average by each transmitter.</p> <p>§15.247 (a) (1) (iii):The average time of occupancy on any channel shall be greater than 0.4 seconds within a period of 0.4 seconds multiplied by the number of hopping channels employed.</p>	

F.3. ENVIRONMENTAL CONDITIONS	
Temperature	+25 ± 5 °C
Humidity	31 % ± 10% RH
Barometric Pressure	101.4 kpa

F.4. EQUIPMENT LIST					
ASSET NUMBER	MANUFACTURER	MODEL	DESCRIPTION	LAST CAL	CAL DUE
00015	Agilent	E4408B	Spectrum Analyzer	24Jan05	24Jan06
00075	Alpha Wire-J	9223	1ft. RG223/U RF Cable	na*	na
00076	Pasternack	PE7014-30	30dB 2 Watt Attenuator	na*	na

*Cable and attenuator verified with power meter prior to use

Company:	Itronix Corporation	Model:	IX325A860IWLBT	FCC ID:	KBCIX325A860IWLBT	IC ID:	1943A-IX325g
DUT Type:	IX325 Rugged Tablet PC with MSI MS-6837 Bluetooth & internal PIFA Antenna 3			2402 - 2480 MHz			
2006 Celltech Labs Inc.	This document is not to be reproduced in whole or in part without the prior written permission of Celltech Labs Inc.						Page 33 of 62

	Test Report Serial No.:	042406KBC-T743-E15B	Report Revision No.:	Revision 1.0
	Test Date(s):	18May05 - 14Jul05	Report Issue Date:	November 07, 2006
	Test Standard(s):	FCC 47 CFR §15.247	Industry Canada RSS-210 Issue 5	
	Lab Registration(s):	FCC Lab Reg. # 714830	Industry Canada Lab File # IC 3874	

F.5. MEASUREMENT EQUIPMENT SETUP

Measurement Equipment Connections	The equipment was connected as shown in the setup drawing in F.6.
Measurement Equipment Settings	<p>Two measurements are used for this determination. The first was the determination of the list repletion rate, using spectrum analyzer settings of:</p> <p>Frequency – 2441 MHz Span – 0 MHz RBW – 1 MHz VBW – 3 MHz Sweep – 200 mS Detector – Peak Trace - Max Hold</p> <p>The second measurement was the pulse width measurement, with spectrum analyzer settings of:</p> <p>Frequency – 2441 MHz Span – 0 MHz RBW – 1 MHz VBW – 3 MHz Sweep – 4 mS Detector – Peak Trace - Max Hold</p>

F.6. SETUP DRAWING

Figure F.6-1 - Setup Drawing

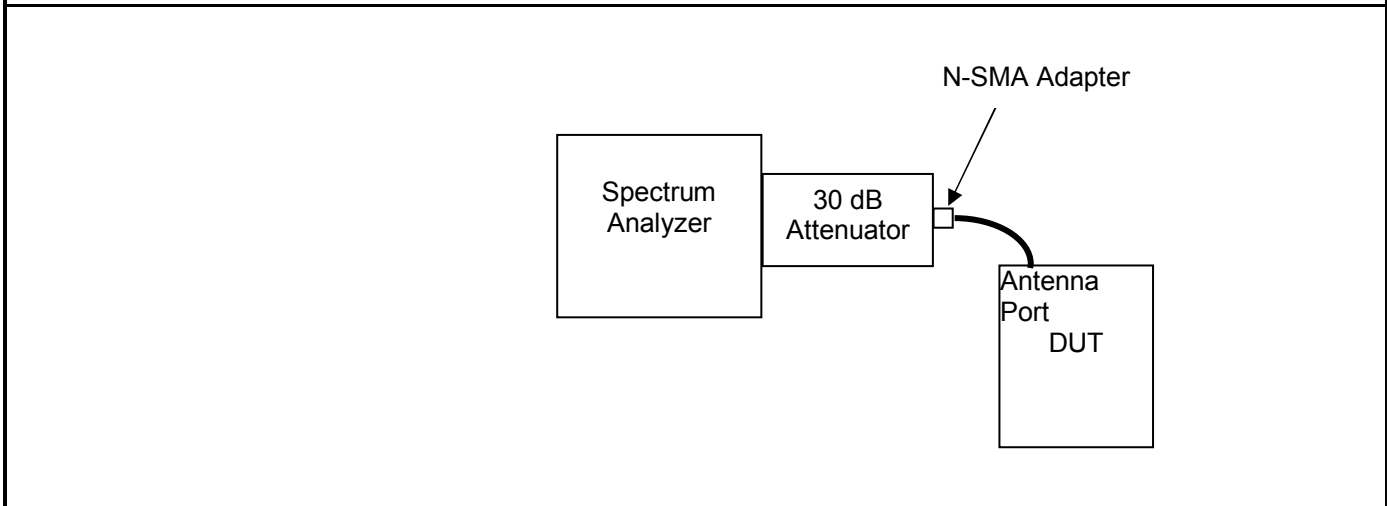

F.7. DUT OPERATING DESCRIPTION

The hopping dwell time is measured with the DUT set at max power and to hop through the channels with the analyzer set for max hold. The analyzer trace is allowed to fill for a long enough period to show the time used for the DUT to go through the pseudo-random frequency list and restart with the channel being monitored.

Company:	Itronix Corporation	Model:	IX325A860IWLBT	FCC ID:	KBCIX325A860IWLBT	IC ID:	1943A-IX325g
DUT Type:	IX325 Rugged Tablet PC with MSI MS-6837 Bluetooth & internal PIFA Antenna 3			2402 - 2480 MHz			
2006 Celltech Labs Inc.	This document is not to be reproduced in whole or in part without the prior written permission of Celltech Labs Inc.						Page 34 of 62

Test Report Serial No.:	042406KBC-T743-E15B	Report Revision No.:	Revision 1.0
Test Date(s):	18May05 - 14Jul05	Report Issue Date:	November 07, 2006
Test Standard(s):	FCC 47 CFR §15.247	Industry Canada RSS-210 Issue 5	
Lab Registration(s):	FCC Lab Reg. # 714830	Industry Canada Lab File # IC 3874	

F.8. TEST RESULTS

Figure F.8-1 - List Repetition Rate

Figure F.8-2 - Pulse Width

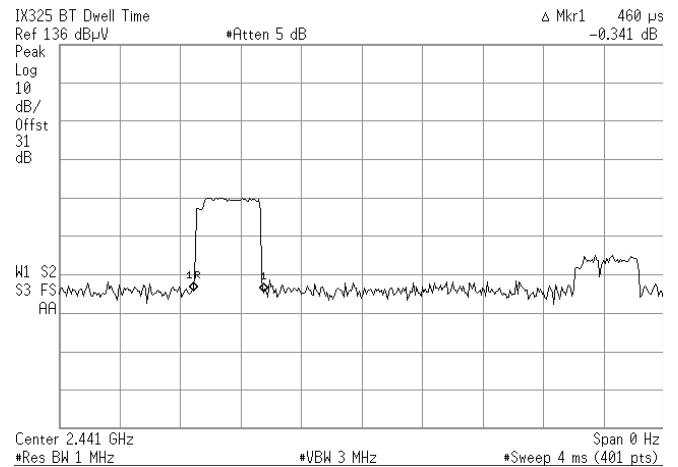
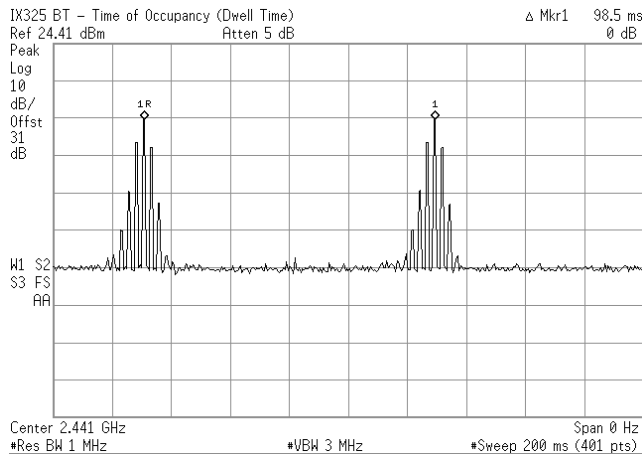

The pseudorandom list repeats each 98.5 mS, therefore each channel will be active once each 98.5 mS. (see Figure F.8.1)
 Each time the channel is active, it is for 460 uS. (Figure F.8.2)
 The number of hopping channels is 79, therefore the total reference time is 79 * 0.4 seconds = 31.6 seconds.
 The number of times the channel is active within the reference time of 31.6 seconds is 31.6 sec / 98.5 mS = 320.81 times
 The average time in which a channel is active (dwell time) in the reference time (31.6 sec) = 320.81 times X 460 uS = 147.57 mS.

Company:	Itronix Corporation	Model:	IX325A860IWLBT	FCC ID:	KBCIX325A860IWLBT	IC ID:	1943A-IX325g
DUT Type:	IX325 Rugged Tablet PC with MSI MS-6837 Bluetooth & internal PIFA Antenna 3			2402 - 2480 MHz		ITRONIX A GENERAL DYNAMICS COMPANY	
2006 Celltech Labs Inc.	This document is not to be reproduced in whole or in part without the prior written permission of Celltech Labs Inc.						Page 35 of 62

	Test Report Serial No.:	042406KBC-T743-E15B	Report Revision No.:	Revision 1.0
	Test Date(s):	18May05 - 14Jul05	Report Issue Date:	November 07, 2006
	Test Standard(s):	FCC 47 CFR §15.247	Industry Canada RSS-210 Issue 5	
	Lab Registration(s):	FCC Lab Reg. # 714830	Industry Canada Lab File # IC 3874	

F.9. PASS/FAIL

In reference to the results outlined in F.8, the DUT passes the requirements as stated in the reference standards as follows:

§15.247 (a) (1):The system shall hop to channel frequencies that are selected at the hopping rate from a pseudorandomly ordered list of hopping frequencies. Each frequency must be used equally on the average by each transmitter.

§15.247 (a) (1) (iii):The average time of occupancy on any channel shall be greater than 0.4 seconds within a period of 0.4 seconds multiplied by the number of hopping channels employed

The DUT channel appears to utilize all available channels over a finite time period. The time the system dwells on each channel within any reference period of 31.6 seconds was determined to be 0.147 seconds as measured on Channel 39 and shown in the included display plot.

F.10. SIGN-OFF

I attest to the accuracy of the data. All measurements reported herein were performed by me and are correct to the best of my knowledge and belief. I assume full responsibility for the completeness of these measurements.



Russell Pipe
Senior Compliance Technologist
Celltech Labs Inc.

3Jun05

Date

Company:	Itronix Corporation	Model:	IX325A860IWLBT	FCC ID:	KBCIX325A860IWLBT	IC ID:	1943A-IX325g
DUT Type:	IX325 Rugged Tablet PC with MSI MS-6837 Bluetooth & internal PIFA Antenna 3			2402 - 2480 MHz			
2006 Celltech Labs Inc.	This document is not to be reproduced in whole or in part without the prior written permission of Celltech Labs Inc.						Page 36 of 62

	Test Report Serial No.:	042406KBC-T743-E15B	Report Revision No.:	Revision 1.0
	Test Date(s):	18May05 - 14Jul05	Report Issue Date:	November 07, 2006
	Test Standard(s):	FCC 47 CFR §15.247	Industry Canada RSS-210 Issue 5	
	Lab Registration(s):	FCC Lab Reg. # 714830	Industry Canada Lab File # IC 3874	

Appendix G - 20 dB Bandwidth Measurement

G.1. REFERENCES	
Normative Reference Standard	FCC CFR 47 §15.247 (a) (1) (iii)
Test Reference	FCC Public Notice DA 00-705 released March 30, 2000

G.2. LIMITS	
§15.247 (a) (1) (iii): <i>Frequency hopping systems in the 2400 – 2483.5 MHz band shall use at least 15 non-overlapping channels.</i>	
Note: The channel width as referenced in the results outlined in Appendix D and E is 1 MHz, therefore to be non-overlapping, the 20 dB bandwidth must be no greater than 1 MHz for the system to comply.	

G.3. ENVIRONMENTAL CONDITIONS	
Temperature	+25 ± 5 °C
Humidity	31 % ± 10% RH
Barometric Pressure	101.4 kpa

G.4. EQUIPMENT LIST					
ASSET NUMBER	MANUFACTURER	MODEL	DESCRIPTION	LAST CAL	CAL DUE
00015	Agilent	E4408B	Spectrum Analyzer	24Jan05	24Jan06
00075	Alpha Wire-J	9223	1ft. RG223/U RF Cable	na*	na
00076	Pasternack	PE7014-30	30dB 2 Watt Attenuator	na*	na

*Cable and attenuator verified with power meter prior to use

Company:	Itronix Corporation	Model:	IX325A860IWLBT	FCC ID:	KBCIX325A860IWLBT	IC ID:	1943A-IX325g
DUT Type:	IX325 Rugged Tablet PC with MSI MS-6837 Bluetooth & internal PIFA Antenna 3			2402 - 2480 MHz			
2006 Celltech Labs Inc.	This document is not to be reproduced in whole or in part without the prior written permission of Celltech Labs Inc.						Page 37 of 62

	Test Report Serial No.:	042406KBC-T743-E15B	Report Revision No.:	Revision 1.0
	Test Date(s):	18May05 - 14Jul05	Report Issue Date:	November 07, 2006
	Test Standard(s):	FCC 47 CFR §15.247	Industry Canada RSS-210 Issue 5	
	Lab Registration(s):	FCC Lab Reg. # 714830	Industry Canada Lab File # IC 3874	

G.5. MEASUREMENT EQUIPMENT SETUP

Measurement Equipment Connections	The equipment was connected as shown in the setup drawing in G.6.
Measurement Equipment Settings	<p>The occupied bandwidth was measured for each channel using the spectrum analyzer with settings of:</p> <p>Frequency – each of three low, mid and high channels (2402, 2441 & 2480 MHz)</p> <p>Span – 3 MHz</p> <p>RBW – 100 kHz</p> <p>VBW – 300 kHz</p> <p>Sweep – 5 mS</p> <p>Detector – Peak</p> <p>Trace - Max Hold</p>

G.6. SETUP DRAWING

Figure G.6-1 - Setup Drawing

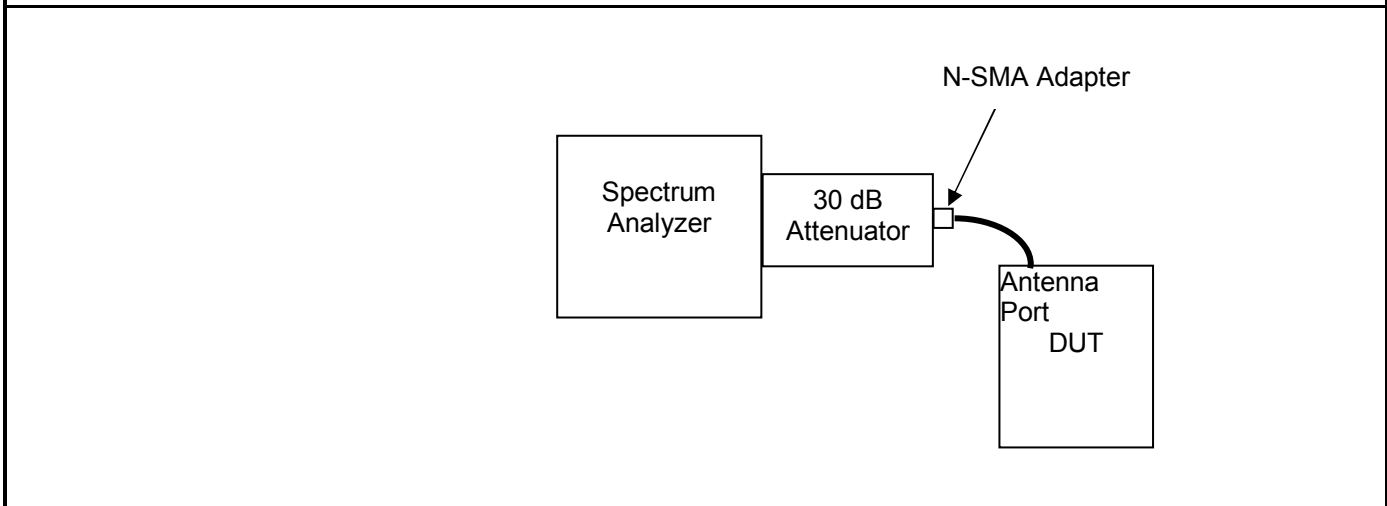

G.7. DUT OPERATING DESCRIPTION

The 20 dB occupied bandwidth is measurement with the DUT set at max power for each of the three low, mid and high channels with pseudo-random modulation applied.

Company:	Itronix Corporation	Model:	IX325A860IWLBT	FCC ID:	KBCIX325A860IWLBT	IC ID:	1943A-IX325g
DUT Type:	IX325 Rugged Tablet PC with MSI MS-6837 Bluetooth & internal PIFA Antenna 3			2402 - 2480 MHz			
2006 Celltech Labs Inc.	This document is not to be reproduced in whole or in part without the prior written permission of Celltech Labs Inc.						Page 38 of 62



Test Report Serial No.:	042406KBC-T743-E15B	Report Revision No.:	Revision 1.0
Test Date(s):	18May05 - 14Jul05	Report Issue Date:	November 07, 2006
Test Standard(s):	FCC 47 CFR §15.247	Industry Canada RSS-210 Issue 5	
Lab Registration(s):	FCC Lab Reg. # 714830	Industry Canada Lab File # IC 3874	

G.8. TEST RESULTS

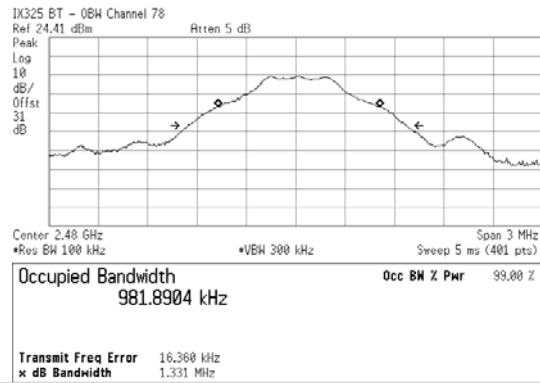
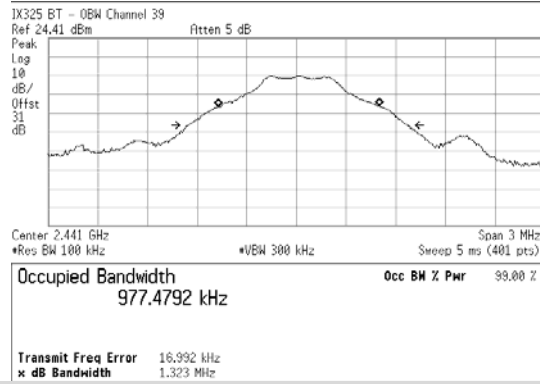
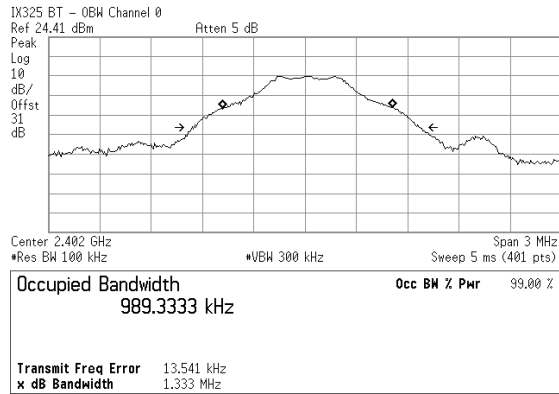

Channel	Power Settings	Frequency	-20 dBc Bandwidth	Limit
	Power (ext/int)	MHz	kHz	kHz
Low	255/61	2402	989.33	1000
Mid	255/63	2441	977.48	1000
High	255/63	2480	981.89	1000

Company:	Itronix Corporation	Model:	IX325A860IWLBT	FCC ID:	KBCIX325A860IWLBT	IC ID:	1943A-IX325g
DUT Type:	IX325 Rugged Tablet PC with MSI MS-6837 Bluetooth & internal PIFA Antenna 3			2402 - 2480 MHz		ITRONIX A GENERAL DYNAMICS COMPANY	
2006 Celltech Labs Inc.	This document is not to be reproduced in whole or in part without the prior written permission of Celltech Labs Inc.						Page 39 of 62

	Test Report Serial No.:	042406KBC-T743-E15B	Report Revision No.:	Revision 1.0
	Test Date(s):	18May05 - 14Jul05	Report Issue Date:	November 07, 2006
	Test Standard(s):	FCC 47 CFR §15.247	Industry Canada RSS-210 Issue 5	
	Lab Registration(s):	FCC Lab Reg. # 714830	Industry Canada Lab File # IC 3874	

G.9. PASS/FAIL

In reference to the results outlined in G.8, the DUT passes the requirements as stated in the reference standards as follows:

§15.247 (a) (1) (iii): Frequency hopping systems in the 2400 - 2483.5 MHz band shall use at least 15 non-overlapping channels.
 Note: The channel width as referenced in the results outlined in Appendix D and E is 1 MHz, therefore to be non-overlapping, the 20 dB bandwidth must be no greater than 1 MHz for the system to comply.

The DUT channel with the widest occupied bandwidth was Channel 0 with a width of 989.33 kHz.

G.10. SIGN-OFF

I attest to the accuracy of the data. All measurements reported herein were performed by me and are correct to the best of my knowledge and belief. I assume full responsibility for the completeness of these measurements.



Russell Pipe
 Senior Compliance Technologist
 Celltech Labs Inc.

3Jun05
 Date

Company:	Itronix Corporation	Model:	IX325A860IWLBT	FCC ID:	KBCIX325A860IWLBT	IC ID:	1943A-IX325g
DUT Type:	IX325 Rugged Tablet PC with MSI MS-6837 Bluetooth & internal PIFA Antenna 3			2402 - 2480 MHz			
2006 Celltech Labs Inc.	This document is not to be reproduced in whole or in part without the prior written permission of Celltech Labs Inc.						Page 40 of 62

	Test Report Serial No.:	042406KBC-T743-E15B	Report Revision No.:	Revision 1.0
	Test Date(s):	18May05 - 14Jul05	Report Issue Date:	November 07, 2006
	Test Standard(s):	FCC 47 CFR §15.247	Industry Canada RSS-210 Issue 5	
	Lab Registration(s):	FCC Lab Reg. # 714830	Industry Canada Lab File # IC 3874	

Appendix H - Radiated Spurious Emissions Measurement

H.1. REFERENCES	
Normative Reference Standard	FCC CFR 47 §15.247(c)
Procedure Reference	ANSI C63.4; FCC 97-114

H.2. LIMITS	
H.2.1. FCC CFR 47	
<p>§15.247 (c): In any 100 kHz bandwidth outside the frequency band in which the spread spectrum or digitally modulated intentional radiator is operating, the radio frequency power that is produced by the intentional radiator shall be at least 20 dB below that in the 100 kHz bandwidth within the band that contains the highest level of desired power, based on either an RF conducted or a radiated measurement. Attenuation below the general limits specified in 15.209 (a) is not required.</p>	
<p>Note: Spurious emissions within the restricted bands are reported in Appendix I. The maximum carrier field strength @ 3m was determined for each receive antenna orientation and detector setting. For the most conservative limit, the minimum carrier field strengths measured in this configuration were determined to be with CH 0 for horizontal and CH39 for vertical. Based on these field strengths, a horizontal peak 20 dBc limit of 76.49 dBuV/m and a vertical peak 20 dBc limit of 72.48 dBuV/m was determined. A horizontal average 20 dBc limit of 76.59 dBuV/m and vertical average limit of 72.53 dBuV/m were determined. The carrier field strengths used in this determination are presented in the table shown in the follow pages.</p>	

H.3. ENVIRONMENTAL CONDITIONS	
Temperature	+25 ± 5 °C
Humidity	31 % ± 10% RH
Barometric Pressure	101.4 kpa

H.4. EQUIPMENT LIST						
RECEIVING EQUIPMENT						
ID	ASSET NUMBER	MANUFACTURER	MODEL	DESCRIPTION	LAST CAL	CAL DUE
1	00072	EMCO	2075	Mini-mast	na	na
2	00073	EMCO	2080	Turn Table	na	na
3	00071	EMCO	2090	Multi-Device Controller	na	na
5	00035	ETS	3115	Double Ridged Guide Horn	24Mar04	24Mar06
6	00035	ETS	3160-09	Standard Gain Horn	na	na
7	00051	HP	8566B	Spectrum Analyzer RF Section	12Apr05	12Apr06
8	00049	HP	85650A	Quasi-Peak Adapter	13Apr05	13Apr06
9	00047	HP	85685A	RF Preselector	13Apr05	13Apr06
10	00015	Agilent	4408B	Spectrum Analyzer	24Jan05	24Jan06
11	00115	Miteq	J54-00102600-35-5A	LNA	28Dec04	28Dec05
12	00093	Microtronics	HPM50111	High Pass Filter	8Jun04	8Dec05
13	00119	INMAT	18AH-10	10dB attenuator	8Jun04	8Dec05
14	00120	Celltech	n/a	Microwave Cable (RX)	25Mar05	25Mar06
15	00121	Andrew	FSJ4-50B	Microwave Cable (RX)	25Mar05	25Mar06
16	00130	Andrew	FSJ1-50A	Microwave Cable (RX)	25Mar05	25Mar06

Company:	Itronix Corporation	Model:	IX325A860IWLBT	FCC ID:	KBCIX325A860IWLBT	IC ID:	1943A-IX325g	
DUT Type:	IX325 Rugged Tablet PC with MSI MS-6837 Bluetooth & internal PIFA Antenna 3			2402 - 2480 MHz				
2006 Celltech Labs Inc.		This document is not to be reproduced in whole or in part without the prior written permission of Celltech Labs Inc.					Page 41 of 62	

	Test Report Serial No.:	042406KBC-T743-E15B	Report Revision No.:	Revision 1.0
	Test Date(s):	18May05 - 14Jul05	Report Issue Date:	November 07, 2006
	Test Standard(s):	FCC 47 CFR §15.247	Industry Canada RSS-210 Issue 5	
	Lab Registration(s):	FCC Lab Reg. # 714830	Industry Canada Lab File # IC 3874	

H.5. MEASUREMENT EQUIPMENT SETUP

MEASUREMENT EQUIPMENT CONNECTIONS	The measurement equipment was connected as shown in the E.6. A number of antennas were used to cover the applicable frequency range test. The ranges in which each antenna was used are as follows:			
	Frequency Range	Spectrum Analyzer Asset #	LNA/Filter/Attenuator Asset #	Antenna Asset #
	1 GHz – 2 GHz	00051/00047	00119/00115	00035
	1 GHz – 18 GHz	00051	00093/00115	00035
	18 GHz – 22 GHz	00051	00093/00115	80001
	22 GHz – 26 GHz	00015	00093/00115	80001
MEASUREMENT EQUIPMENT SETTINGS	The spectrum analyzer was set to the following settings:			
	Frequency Range	RBW	VBW	Detector
	MHz	kHz	kHz	
	30 – 1000	100	300	Peak*
	> 1000	1000*	1000	Peak*
*As a worst-case prescan measurement, the average/QP limit was applied to measurements made with a peak detector using a RBW of 1 MHz (vs the specified 100 kHz), unless otherwise noted.				

H.6. SETUP DRAWING

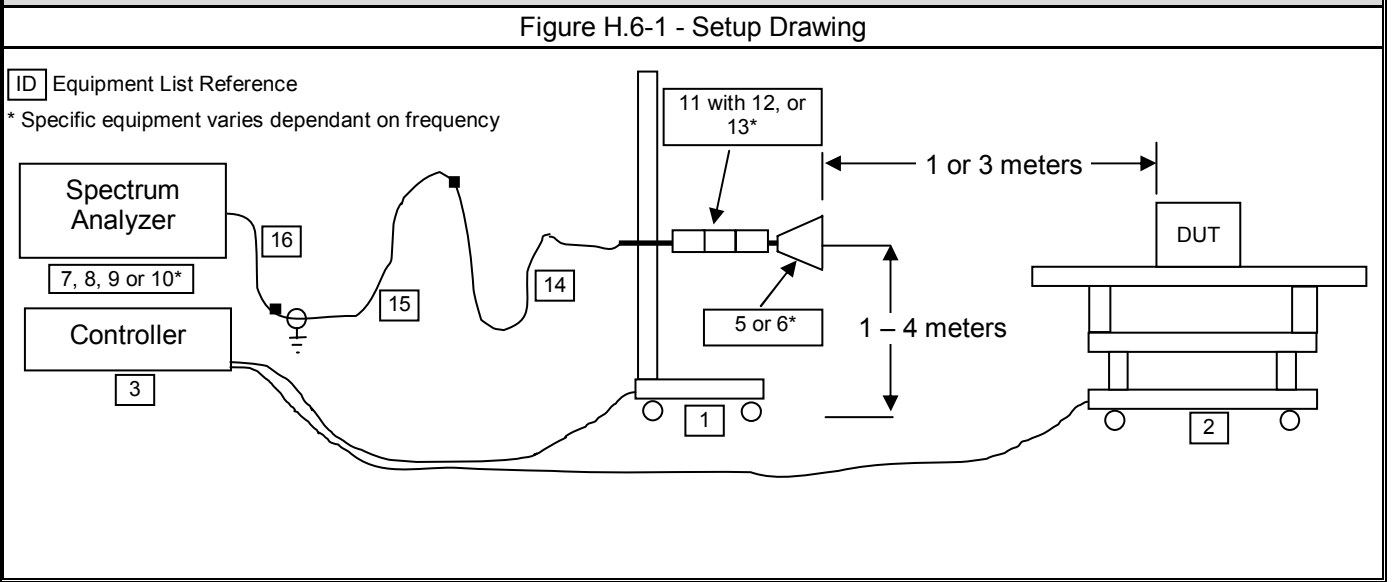

H.7. DUT OPERATING DESCRIPTION

Measurements were made at three channels throughout the band, Low Channel (2402 MHz), Mid Channel (2441 MHz), High Channel (2480 MHz). The configuration used was with a gain setting of 250/40 for the low channel, 250/44 for mid channel and 220/45 for the high channel. The modulation was set to 1000. As a worst-case, the band-edge measurements were made of the low and high channels with data stream modulation.

Company:	Itronix Corporation	Model:	IX325A860IWLBT	FCC ID:	KBCIX325A860IWLBT	IC ID:	1943A-IX325g	
DUT Type:	IX325 Rugged Tablet PC with MSI MS-6837 Bluetooth & internal PIFA Antenna 3			2402 - 2480 MHz				
2006 Celltech Labs Inc.		This document is not to be reproduced in whole or in part without the prior written permission of Celltech Labs Inc.					Page 42 of 62	

Test Report Serial No.:	042406KBC-T743-E15B	Report Revision No.:	Revision 1.0
Test Date(s):	18May05 - 14Jul05	Report Issue Date:	November 07, 2006
Test Standard(s):	FCC 47 CFR §15.247	Industry Canada RSS-210 Issue 5	
Lab Registration(s):	FCC Lab Reg. # 714830	Industry Canada Lab File # IC 3874	

H.8. SETUP PHOTOGRAPHS

Photograph H.8-1 - 3115 Horn Antenna (2GHz - 10GHz)



Photograph H.8-2 - 3115 Horn Antenna (10GHz - 18GHz)



Photograph H.8-3 - 3160-09 Horn Antenna (18GHz - 24 GHz)



Company:	Itronix Corporation	Model:	IX325A860IWLBT	FCC ID:	KBCIX325A860IWLBT	IC ID:	1943A-IX325g
DUT Type:	IX325 Rugged Tablet PC with MSI MS-6837 Bluetooth & internal PIFA Antenna 3			2402 - 2480 MHz		ITRONIX <small>A GENERAL DYNAMICS COMPANY</small>	
2006 Celltech Labs Inc.	This document is not to be reproduced in whole or in part without the prior written permission of Celltech Labs Inc.						Page 43 of 62

 Celltech Testing and Engineering Services Lab	Test Report Serial No.:	042406KBC-T743-E15B	Report Revision No.:	Revision 1.0
	Test Date(s):	18May05 - 14Jul05	Report Issue Date:	November 07, 2006
	Test Standard(s):	FCC 47 CFR §15.247	Industry Canada RSS-210 Issue 5	
	Lab Registration(s):	FCC Lab Reg. # 714830	Industry Canada Lab File # IC 3874	

H.9. TEST RESULTS

H.9.1. Carrier Field Strengths @ Specified Distance



Project Numb 040505KBC-T630-E15B
Company: Itronix
Product: IX325 with MSI BT

Standard: FCC15.247a
Test Start Date: 30-May-05
Test End Date: 9-Jun-05

Channel	Polarity	Measurement Distance	Antenna	Frequency	SA Level	Noise Floor	AF	CL	Other	Total CF	Field Strength	Detector	RBW
							dB/m	dB	dB	dB/m	dBuV/m		kHz
		m		MHz	dBuV								
BT-CH0	H	3	Horn SN6276	2402.20	84.30		30.24	5.08	-23.13	12.19	96.49	PK	100
BT-CH0	H	3	Horn SN6276	2402.00	84.40		30.24	5.08	-23.13	12.19	96.59	AV	100
BT-CH0	V	3	Horn SN6276	2402.02	81.95		30.24	5.08	-23.13	12.19	94.14	PK	100
BT-CH0	V	3	Horn SN6276	2402.00	82.10		30.24	5.08	-23.13	12.19	94.29	AV	100
BT-CH39	H	3	Horn SN6276	2440.96	85.20		30.31	5.14	-23.12	12.33	97.53	PK	100
BT-CH39	H	3	Horn SN6276	2440.96	85.30		30.31	5.14	-23.12	12.33	97.63	AV	100
BT-CH39	V	3	Horn SN6276	2440.99	80.15		30.31	5.14	-23.12	12.33	92.48	PK	100
BT-CH39	V	3	Horn SN6276	2440.99	80.20		30.31	5.14	-23.12	12.33	92.53	AV	100
BT-CH78	H	3	Horn SN6276	2479.95	87.10		30.37	5.17	-23.12	12.41	99.51	PK	100
BT-CH78	H	3	Horn SN6276	2479.95	87.25		30.37	5.17	-23.12	12.41	99.66	AV	100
BT-CH78	V	3	Horn SN6276	2479.95	82.70		30.37	5.17	-23.12	12.41	95.11	PK	100
BT-CH78	V	3	Horn SN6276	2479.95	82.80		30.37	5.17	-23.12	12.41	95.21	AV	100

Formulae:

Total CF = AF + CL + Other

Field Strength = SA Level + Total CF

Note: Carrier is unmodulated

Company:	Itronix Corporation	Model:	IX325A860IWLBT	FCC ID:	KBCIX325A860IWLBT	IC ID:	1943A-IX325g
DUT Type:	IX325 Rugged Tablet PC with MSI MS-6837 Bluetooth & internal PIFA Antenna 3			2402 - 2480 MHz		 <small>A GENERAL DYNAMICS COMPANY</small>	
2006 Celltech Labs Inc.	This document is not to be reproduced in whole or in part without the prior written permission of Celltech Labs Inc.						Page 44 of 62



Test Report Serial No.:	042406KBC-T743-E15B	Report Revision No.:	Revision 1.0
Test Date(s):	18May05 - 14Jul05	Report Issue Date:	November 07, 2006
Test Standard(s):	FCC 47 CFR §15.247	Industry Canada RSS-210 Issue 5	
Lab Registration(s):	FCC Lab Reg. # 714830	Industry Canada Lab File # IC 3874	

H.9.2. Lower Band-edge Emission Field Strengths @ Specified Distance

Note: (Upper Band-edge (Restricted) is in Appendix I)

Channel 0 - Conducted Band-edge Plots

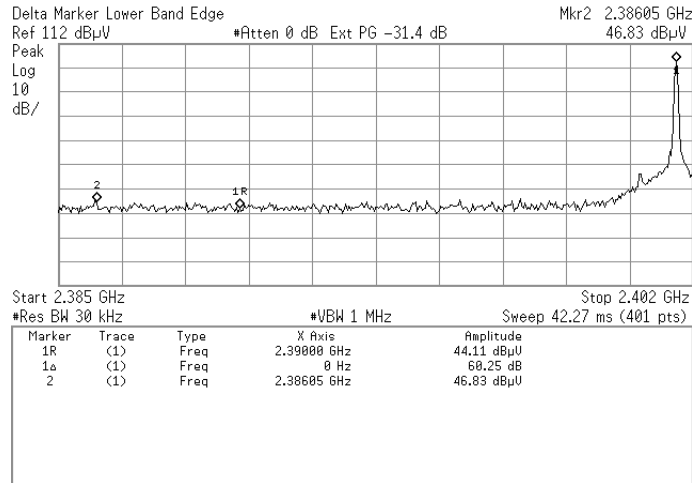

Channel 0 - Radiated Carrier Field Strengths

Channel	Polarity	Measurement Distance	Antenna	Frequency	SA Level	Noise Floor	AF	CL	Other	Total CF	Field Strength	Detector	RBW
							dB/m	dB	dB	dB/m	dBuV/m		kHz
BT-CH0	H	3	Horn SN6276	2402.20	84.30		30.24	5.08	-23.13	12.19	96.49	PK	100
BT-CH0	H	3	Horn SN6276	2402.00	84.40		30.24	5.08	-23.13	12.19	96.59	AV	100
BT-CH0	V	3	Horn SN6276	2402.02	81.95		30.24	5.08	-23.13	12.19	94.14	PK	100
BT-CH0	V	3	Horn SN6276	2402.00	82.10		30.24	5.08	-23.13	12.19	94.29	AV	100

Channel 0 - Calculated Band-edge (Out-of-Band) Field Strengths

Channel	Polarity	Distance	Frequency	Carrier Radiated Field Strength	Delta Marker	Detector	Calculated Bandedge Field Strength	Duty Cycle Correction	Corrected Bandedge Field Strength	Specifeid Limit	Specified Limit Distance	Limit Distance Correction	Calculated Limit	Margin	Pass/Fail
BT-CH0	H	3	2386.05	96.49	57.53	PK	38.96	0.00	38.96	76.49	3.00	0.00	76.49	37.53	PASS
BT-CH0	H	3	2386.05	96.59	57.53	AV	39.06	0.00	39.06	76.59	3.00	0.00	76.59	37.53	PASS
BT-CH0	V	3	2386.05	94.14	57.53	PK	36.61	0.00	36.61	74.14	3.00	0.00	74.14	37.53	PASS
BT-CH0	V	3	2386.05	94.29	57.53	AV	36.76	0.00	36.76	74.29	3.00	0.00	74.29	37.53	PASS

Formulae:

Total CF (dB) = Antenna Factor (dB) + Cable Factor (dB) + Other Factor (Amplifier Gain, Filter Loss, etc) (dB)

Field Strength (dBuV/m) = SA Reading (dBuV) + Total CF (dB/m)

Limit Distance Correction (dB) = 40 * log(d1/d2) for f < 30 MHz, 20*log(d1/d2) for f > 30 MHz; where d1 is the measurement distance and d2 is the published limit

Limit (dBuV/m) = Published Limit (dBuV/m) + Limit Distance Correction (dB)

Margin (dB) = Limit (dBuV/m) - Field Strength (dBuV/m)

Note: Measurements and calculation reference the Marker-Delta Method Described in FCC Public Notice DA 00-705

Company:	Itronix Corporation	Model:	IX325A860IWLBT	FCC ID:	KBCIX325A860IWLBT	IC ID:	1943A-IX325g
DUT Type:	IX325 Rugged Tablet PC with MSI MS-6837 Bluetooth & internal PIFA Antenna 3			2402 - 2480 MHz		ITRONIX A GENERAL DYNAMICS COMPANY	
2006 Celltech Labs Inc.	This document is not to be reproduced in whole or in part without the prior written permission of Celltech Labs Inc.						Page 45 of 62

 Testing and Engineering Services Lab	Test Report Serial No.:	042406KBC-T743-E15B	Report Revision No.:	Revision 1.0
	Test Date(s):	18May05 - 14Jul05	Report Issue Date:	November 07, 2006
	Test Standard(s):	FCC 47 CFR §15.247	Industry Canada RSS-210 Issue 5	
	Lab Registration(s):	FCC Lab Reg. # 714830	Industry Canada Lab File # IC 3874	

H.9.3. Spurious Emission Field Strengths @ Specified Distance

Channel 0

 Testing and Engineering Services Lab	Project Number:	040505KBC-T630-E15B	Standard:	Part 15 100k RBW
	Company:	Itronix	Test Start Date:	30-May-05
	Product:	IX325 with MSI BT	Test End Date:	9-Jun-05

Channel	Polarity	Distance m	Rx Antenna	Frequency MHz	SA Level dBuV	Noise Floor	Rx AF	Rx CL	Other Rx	Total Rx CF	Field Strength	Detector	Limit Distance	Limit Distance Correction	Calculated Limit	Margin	Pass/Fail
							dB/m	dB	dB	dB/m	dBuV/m	(PK/QP/AV)	m	dB	dBuV/m	dB	
BT-CH0	H	3	Horn SN6276	7209.02	28.55	NF	38.18	9.72	-30.84	17.05	45.60	PK*	3.00	0.00	76.59	30.99	PASS
BT-CH0	H	3	Horn SN6276	9617.54	26.40	NF	40.30	12.24	-30.71	21.83	48.23	PK*	3.00	0.00	76.59	28.37	PASS
BT-CH0	H	1	Horn SN6276	14402.68	30.95	NF	42.50	21.33	-30.74	33.09	64.04	PK*	3.00	9.54	86.13	22.09	PASS
BT-CH0	H	1	3160-09	23470.98	37.50		40.40	22.85	-35.56	27.69	65.19	PK*	3.00	9.54	86.13	20.95	PASS
BT-CH0	V	3	Horn SN6276	2620.90	35.20		30.79	5.35	-23.11	13.03	48.23	PK*	3.00	0.00	72.53	24.30	PASS
BT-CH0	V	3	Horn SN6276	7206.00	28.30	NF	38.17	9.75	-30.84	17.08	45.38	PK*	3.00	0.00	72.53	27.15	PASS
BT-CH0	V	3	Horn SN6276	8782.40	27.20	NF	39.85	10.73	-30.75	19.84	47.04	PK*	3.00	0.00	72.53	25.49	PASS
BT-CH0	V	3	Horn SN6276	9608.00	27.65	NF	40.30	12.06	-30.71	21.65	49.30	PK*	3.00	0.00	72.53	23.23	PASS
BT-CH0	V	1	Horn SN6276	14404.58	31.05	NF	42.50	21.30	-30.74	33.06	64.11	PK*	3.00	9.54	82.07	17.96	PASS
BT-CH0	V	1	3160-09	21615.60	36.60	NF	40.30	22.60	-35.58	27.32	63.92	PK*	3.00	9.54	82.07	18.15	PASS
BT-CH0	V	1	3160-09	23230.04	37.85	NF	40.40	22.82	-35.56	27.65	65.50	PK	3.00	9.54	82.02	16.51	PASS
BT-CH0	V	1	3160-09	23236.92	37.55	NF	40.40	22.82	-35.56	27.66	65.21	PK	3.00	9.54	82.02	16.81	PASS
BT-CH0	V	1	3160-09	23239.54	25.40	NF	40.40	22.82	-35.56	27.66	53.06	AV	3.00	9.54	82.07	29.01	PASS
BT-CH0	V	1	3160-09	23241.16	25.35	NF	40.40	22.82	-35.56	27.66	53.01	AV	3.00	9.54	82.07	29.06	PASS

Formulae:
 Total CF = Antenna Factor + Cable Factor + Other Factor (Amplifier Gain, filter loss, etc)
 Field Strength = SA Reading + Total CF
 Limit Distance Correction = 40*log(d1/d2) for F<30 MHz, 20*log(d1/d2) for F> 30 MHz:
 where d1 is the measurement distance, d2 is the published limit distance
 Limit = Specified Limit + Limit Distance Correction
 Margin = Limit - Field Strength

*PK = QP or Average Limits where applied to the peak emission

***The frequency points reported, describe the highest emission measured in each of the ranges tested and are used to describe the measured spectrum as a whole. Emissions that may be present in the restricted bands are evaluated against the appropriate limits in Appendix I. No out-of-band emissions were measured above the levels noted.**

Company:	Itronix Corporation	Model:	IX325A860IWLBT	FCC ID:	KBCIX325A860IWLBT	IC ID:	1943A-IX325g
DUT Type:	IX325 Rugged Tablet PC with MSI MS-6837 Bluetooth & internal PIFA Antenna 3			2402 - 2480 MHz		 <small>A GENERAL DYNAMICS COMPANY</small>	
2006 Celltech Labs Inc.	This document is not to be reproduced in whole or in part without the prior written permission of Celltech Labs Inc.						Page 46 of 62

 Celltech Testing and Engineering Services Lab	Test Report Serial No.:	042406KBC-T743-E15B	Report Revision No.:	Revision 1.0
	Test Date(s):	18May05 - 14Jul05	Report Issue Date:	November 07, 2006
	Test Standard(s):	FCC 47 CFR §15.247	Industry Canada RSS-210 Issue 5	
	Lab Registration(s):	FCC Lab Reg. # 714830	Industry Canada Lab File # IC 3874	

Channel 39

 Celltech Testing and Engineering Services Lab	Project Number:	040505KBC-T630-E15B	Standard:	FCC15.247c
	Company:	Itronix	Test Start Date:	30-May-05
	Product:	IX325 with MSI BT	Test End Date:	9-Jun-05

BT-CH39	H	3	Horn SN6276	9531.31	25.45	NF	40.30	11.93	-30.72	21.51	46.96	PK*	3.00	0.00	76.59	29.63	PASS
BT-CH39	H	1	Horn SN6276	14650.92	30.90	NF	42.57	20.90	-30.87	32.59	63.49	PK*	3.00	9.54	86.13	22.64	PASS
BT-CH39	H	1	Horn SN6276	14640.60	31.50	NF	42.57	19.79	-30.87	31.49	62.99	PK*	3.00	9.54	86.13	23.15	PASS
BT-CH39	H	1	Horn SN6276	17079.92	31.30	NF	43.22	19.51	-32.16	30.57	61.87	PK*	3.00	9.54	86.13	24.27	PASS
BT-CH39	H	1	3160-09	21969.14	36.50	NF	40.30	22.65	-35.58	27.37	63.87	PK*	3.00	9.54	86.13	22.26	PASS
BT-CH39	V	3	Horn SN6276	3514.64	22.00	NF	33.34	6.23	-31.15	8.42	30.42	PK*	3.00	0.00	72.53	42.10	PASS
BT-CH39	V	1	Horn SN6276	14643.76	31.55	NF	42.57	20.13	-30.87	31.83	63.38	PK*	3.00	9.54	82.07	18.69	PASS
BT-CH39	V	1	Horn SN6276	17083.46	32.05	NF	43.23	19.23	-32.16	30.30	62.35	PK*	3.00	9.54	82.07	19.72	PASS
BT-CH39	V	1	3160-09	21972.64	36.60	NF	40.30	22.65	-35.58	27.37	63.97	PK*	3.00	9.54	82.07	18.10	PASS
BT-CH39	V	1	3160-09	23524.66	37.75	NF	40.40	22.85	-35.56	27.70	65.45	PK	3.00	9.54	82.02	16.57	PASS
BT-CH39	V	1	3160-09	23536.12	25.40	NF	40.40	22.86	-35.56	27.70	53.10	AV	3.00	9.54	82.07	28.97	PASS

Formulae:
 Total CF = Antenna Factor + Cable Factor + Other Factor (Amplifier Gain, filter loss, etc)
 Field Strength = SA Reading + Total CF
 Limit Distance Correction = 40*log(d1/d2) for F<30 MHz, 20*log(d1/d2) for F> 30 MHz:
 where d1 is the measurement distance, d2 is the published limit distance
 Limit = Specified Limit + Limit Distance Correction
 Margin = Limit - Field Strength

*PK = QP or Average Limits where applied to the peak emission

***The frequency points reported, describe the highest emission measured in each of the ranges tested and are used to describe the measured spectrum as a whole. Emissions that may be present in the restricted bands are evaluated against the appropriate limits in Appendix I. No out-of-band emissions were measured above the levels noted.**

Channel 78

 Celltech Testing and Engineering Services Lab	Project Number:	040505KBC-T630-E15B	Standard:	FCC15.247c
	Company:	Itronix	Test Start Date:	30-May-05
	Product:	IX325 with MSI BT	Test End Date:	9-Jun-05

BT-CH78	H	3	Horn SN6276	9911.52	26.25	NF	40.30	12.43	-30.70	22.03	48.28	PK*	3.00	0.00	76.59	28.31	PASS
BT-CH78	H	1	Horn SN6276	14873.30	31.70	NF	42.53	21.67	-30.99	33.20	64.90	PK*	3.00	9.54	86.13	21.23	PASS
BT-CH78	H	1	Horn SN6276	17361.68	31.60	NF	44.01	17.39	-32.31	29.09	60.69	PK*	3.00	9.54	86.13	25.44	PASS
BT-CH78	V	3	Horn SN6276	2648.04	27.10	NF	30.87	5.38	-23.11	13.14	40.24	PK*	3.00	0.00	72.53	32.28	PASS
BT-CH78	V	3	Horn SN6276	8978.02	26.90	NF	40.16	11.03	-30.74	20.45	47.35	PK*	3.00	0.00	72.53	25.17	PASS
BT-CH78	V	3	Horn SN6276	9914.38	25.25	NF	40.30	12.49	-30.70	22.09	47.34	PK*	3.00	0.00	72.53	25.19	PASS
BT-CH78	V	1	Horn SN6276	14881.52	31.35	NF	42.52	21.38	-31.00	32.91	64.26	PK*	3.00	9.54	82.07	17.81	PASS
BT-CH78	V	1	Horn SN6276	17354.12	31.60	NF	43.99	17.50	-32.31	29.18	60.78	PK*	3.00	9.54	82.07	21.29	PASS
BT-CH78	V	1	3160-09	23449.22	37.30	NF	40.40	22.84	-35.56	27.69	64.99	PK	3.00	9.54	82.02	17.03	PASS
BT-CH78	V	1	3160-09	23462.26	25.40	NF	40.40	22.85	-35.56	27.69	53.09	AV	3.00	9.54	82.07	28.98	PASS

Formulae:
 Total CF = Antenna Factor + Cable Factor + Other Factor (Amplifier Gain, filter loss, etc)
 Field Strength = SA Reading + Total CF
 Limit Distance Correction = 40*log(d1/d2) for F<30 MHz, 20*log(d1/d2) for F> 30 MHz:
 where d1 is the measurement distance, d2 is the published limit distance
 Limit = Specified Limit + Limit Distance Correction
 Margin = Limit - Field Strength

*PK = QP or Average Limits where applied to the peak emission

***The frequency points reported, describe the highest emission measured in each of the ranges tested and are used to describe the measured spectrum as a whole. Emissions that may be present in the restricted bands are evaluated against the appropriate limits in Appendix I. No out-of-band emissions were measured above the levels noted.**

Company:	Itronix Corporation	Model:	IX325A860IWLBT	FCC ID:	KBCIX325A860IWLBT	IC ID:	1943A-IX325g
DUT Type:	IX325 Rugged Tablet PC with MSI MS-6837 Bluetooth & internal PIFA Antenna 3			2402 - 2480 MHz		 A GENERAL DYNAMICS COMPANY	
2006 Celltech Labs Inc.	This document is not to be reproduced in whole or in part without the prior written permission of Celltech Labs Inc.						Page 47 of 62

	Test Report Serial No.:	042406KBC-T743-E15B	Report Revision No.:	Revision 1.0
	Test Date(s):	18May05 - 14Jul05	Report Issue Date:	November 07, 2006
	Test Standard(s):	FCC 47 CFR §15.247	Industry Canada RSS-210 Issue 5	
	Lab Registration(s):	FCC Lab Reg. # 714830	Industry Canada Lab File # IC 3874	

H.10. PASS/FAIL

In reference to the results outlined in H.9, the DUT passes the requirements as stated in the reference standards as follows:
 FCC 15.247 (c): All emissions within any 100 kHz bandwidth outside the operating frequency band are greater than 20 dB below the maximum 100 kHz bandwidth signal within the operating band.

H.11. SIGN-OFF

I attest to the accuracy of the data. All measurements reported herein were performed by me and are correct to the best of my knowledge and belief. I assume full responsibility for the completeness of these measurements.



 Russell Pipe
 Senior Compliance Technologist
 Celltech Labs Inc.

 9Jun05
 Date

Company:	Itronix Corporation	Model:	IX325A860IWLBT	FCC ID:	KBCIX325A860IWLBT	IC ID:	1943A-IX325g
DUT Type:	IX325 Rugged Tablet PC with MSI MS-6837 Bluetooth & internal PIFA Antenna 3			2402 - 2480 MHz			
2006 Celltech Labs Inc.	This document is not to be reproduced in whole or in part without the prior written permission of Celltech Labs Inc.						Page 48 of 62

 Celltech Testing and Engineering Services Lab	Test Report Serial No.:	042406KBC-T743-E15B	Report Revision No.:	Revision 1.0
	Test Date(s):	18May05 - 14Jul05	Report Issue Date:	November 07, 2006
	Test Standard(s):	FCC 47 CFR §15.247	Industry Canada RSS-210 Issue 5	
	Lab Registration(s):	FCC Lab Reg. # 714830	Industry Canada Lab File # IC 3874	

Appendix I - Restricted Band Emissions Measurement

I.1. REFERENCES	
Normative Reference Standard	FCC CFR 47 §15.205 (a) (b), FCC CFR 47 §15.209 (a)
Procedure Reference	FCC 97-114

I.2. LIMITS																																																																									
FCC CFR 47 §15.205	<p>(a) Except as shown in paragraph (d) of this section, only spurious emissions are permitted in any of the frequency bands listed below:</p> <table border="1" style="width: 100%; border-collapse: collapse;"> <thead> <tr> <th style="width: 25%;">MHz</th> <th style="width: 25%;">MHz</th> <th style="width: 25%;">MHz</th> <th style="width: 25%;">GHz</th> </tr> </thead> <tbody> <tr><td>0.090-0.110</td><td>16.42-16.423</td><td>399.9-410</td><td>4.5-5.15</td></tr> <tr><td>1.0495-0.505</td><td>16.69475-16.69525</td><td>608-614</td><td>5.35-5.46</td></tr> <tr><td>2.1735-2.1905</td><td>16.80425-16.80475</td><td>960-1240</td><td>7.25-7.75</td></tr> <tr><td>4.125-4.128</td><td>25.5-25.67</td><td>1300-1427</td><td>8.025-8.5</td></tr> <tr><td>4.17725-4.17775</td><td>37.5-38.25</td><td>1435-1626.5</td><td>9.0-9.2</td></tr> <tr><td>4.20725-4.20775</td><td>73-74.6</td><td>1645.5-1646.5</td><td>9.3-9.5</td></tr> <tr><td>6.215-6.218</td><td>74.8-75.2</td><td>1660-1710</td><td>10.6-12.7</td></tr> <tr><td>6.26775-6.26825</td><td>108-121.94</td><td>1718.8-1722.2</td><td>13.25-13.4</td></tr> <tr><td>6.31175-6.31225</td><td>123-138</td><td>2200-2300</td><td>14.47-14.5</td></tr> <tr><td>8.291-8.294</td><td>149.9-150.05</td><td>2310-2390</td><td>15.35-16.2</td></tr> <tr><td>8.362-8.366</td><td>156.52475-156.52525</td><td>2483.5-2500</td><td>17.7-21.4</td></tr> <tr><td>8.37625-8.38675</td><td>156.7-156.9</td><td>2655-2900</td><td>22.01-23.12</td></tr> <tr><td>8.41425-8.41475</td><td>162.0125-167.17</td><td>3260-3267</td><td>23.6-24.0</td></tr> <tr><td>12.29-12.293</td><td>167.72-173.2</td><td>3332-3339</td><td>31.2-31.8</td></tr> <tr><td>12.51975-12.52025</td><td>240-285</td><td>3345.8-3358</td><td>36.43-36.5</td></tr> <tr><td>12.57675-12.57725</td><td>322-335.4</td><td>3600-4400</td><td>(²)</td></tr> <tr><td>13.36-13.41</td><td></td><td></td><td></td></tr> </tbody> </table> <p>¹ Until February 1, 1999, this restricted band shall be 0.490-0.510 MHz. ² Above 38.6</p> <p>(b) Except as provided in paragraphs (d) and (e), the field strength of emissions appearing within these frequency bands shall not exceed the limits shown in 15.209. At frequencies equal to or less than 1000 MHz, compliance with the limits in Section 15.209 shall be demonstrated using measurement instrumentation employing a CISPR quasi-peak detector. Above 1000 MHz, compliance with the emission limits in Section 15.209 shall be demonstrated based on the average value of the measured emissions. The provisions of 15.35 apply to these measurements.</p>	MHz	MHz	MHz	GHz	0.090-0.110	16.42-16.423	399.9-410	4.5-5.15	1.0495-0.505	16.69475-16.69525	608-614	5.35-5.46	2.1735-2.1905	16.80425-16.80475	960-1240	7.25-7.75	4.125-4.128	25.5-25.67	1300-1427	8.025-8.5	4.17725-4.17775	37.5-38.25	1435-1626.5	9.0-9.2	4.20725-4.20775	73-74.6	1645.5-1646.5	9.3-9.5	6.215-6.218	74.8-75.2	1660-1710	10.6-12.7	6.26775-6.26825	108-121.94	1718.8-1722.2	13.25-13.4	6.31175-6.31225	123-138	2200-2300	14.47-14.5	8.291-8.294	149.9-150.05	2310-2390	15.35-16.2	8.362-8.366	156.52475-156.52525	2483.5-2500	17.7-21.4	8.37625-8.38675	156.7-156.9	2655-2900	22.01-23.12	8.41425-8.41475	162.0125-167.17	3260-3267	23.6-24.0	12.29-12.293	167.72-173.2	3332-3339	31.2-31.8	12.51975-12.52025	240-285	3345.8-3358	36.43-36.5	12.57675-12.57725	322-335.4	3600-4400	(²)	13.36-13.41			
MHz	MHz	MHz	GHz																																																																						
0.090-0.110	16.42-16.423	399.9-410	4.5-5.15																																																																						
1.0495-0.505	16.69475-16.69525	608-614	5.35-5.46																																																																						
2.1735-2.1905	16.80425-16.80475	960-1240	7.25-7.75																																																																						
4.125-4.128	25.5-25.67	1300-1427	8.025-8.5																																																																						
4.17725-4.17775	37.5-38.25	1435-1626.5	9.0-9.2																																																																						
4.20725-4.20775	73-74.6	1645.5-1646.5	9.3-9.5																																																																						
6.215-6.218	74.8-75.2	1660-1710	10.6-12.7																																																																						
6.26775-6.26825	108-121.94	1718.8-1722.2	13.25-13.4																																																																						
6.31175-6.31225	123-138	2200-2300	14.47-14.5																																																																						
8.291-8.294	149.9-150.05	2310-2390	15.35-16.2																																																																						
8.362-8.366	156.52475-156.52525	2483.5-2500	17.7-21.4																																																																						
8.37625-8.38675	156.7-156.9	2655-2900	22.01-23.12																																																																						
8.41425-8.41475	162.0125-167.17	3260-3267	23.6-24.0																																																																						
12.29-12.293	167.72-173.2	3332-3339	31.2-31.8																																																																						
12.51975-12.52025	240-285	3345.8-3358	36.43-36.5																																																																						
12.57675-12.57725	322-335.4	3600-4400	(²)																																																																						
13.36-13.41																																																																									
FCC CFR 47 §15.209	<p>(a) Except as provided elsewhere in this Subpart, the emissions from an intentional radiator shall not exceed the field strength levels specified in the following table:</p> <table border="1" style="width: 100%; border-collapse: collapse;"> <thead> <tr> <th>Frequency</th> <th>Field Strength</th> <th>Measurement Distance</th> </tr> <tr> <th>MHz</th> <th>uV/m</th> <th>Meters</th> </tr> </thead> <tbody> <tr><td>.009 - 0.490</td><td>2400/F(kHz)</td><td>300</td></tr> <tr><td>0.490 - 1.705</td><td>24000/F(kHz)</td><td>30</td></tr> <tr><td>1.705 - 30.0</td><td>30</td><td>30</td></tr> <tr><td>30 - 88</td><td>100</td><td>3</td></tr> <tr><td>88 - 216</td><td>150</td><td>3</td></tr> <tr><td>216 - 960</td><td>200</td><td>3</td></tr> <tr><td>Above 960</td><td>500</td><td>3</td></tr> </tbody> </table> <p>(b) In the emission table above, the tighter limit applies at the band edges.</p>	Frequency	Field Strength	Measurement Distance	MHz	uV/m	Meters	.009 - 0.490	2400/F(kHz)	300	0.490 - 1.705	24000/F(kHz)	30	1.705 - 30.0	30	30	30 - 88	100	3	88 - 216	150	3	216 - 960	200	3	Above 960	500	3																																													
Frequency	Field Strength	Measurement Distance																																																																							
MHz	uV/m	Meters																																																																							
.009 - 0.490	2400/F(kHz)	300																																																																							
0.490 - 1.705	24000/F(kHz)	30																																																																							
1.705 - 30.0	30	30																																																																							
30 - 88	100	3																																																																							
88 - 216	150	3																																																																							
216 - 960	200	3																																																																							
Above 960	500	3																																																																							

Company:	Itronix Corporation	Model:	IX325A860IWLBT	FCC ID:	KBCIX325A860IWLBT	IC ID:	1943A-IX325g
DUT Type:	IX325 Rugged Tablet PC with MSI MS-6837 Bluetooth & internal PIFA Antenna 3			2402 - 2480 MHz		 <small>A GENERAL DYNAMICS COMPANY</small>	
2006 Celltech Labs Inc.	This document is not to be reproduced in whole or in part without the prior written permission of Celltech Labs Inc.						Page 49 of 62

	Test Report Serial No.:	042406KBC-T743-E15B	Report Revision No.:	Revision 1.0
	Test Date(s):	18May05 - 14Jul05	Report Issue Date:	November 07, 2006
	Test Standard(s):	FCC 47 CFR §15.247	Industry Canada RSS-210 Issue 5	
	Lab Registration(s):	FCC Lab Reg. # 714830	Industry Canada Lab File # IC 3874	

I.3. ENVIRONMENTAL CONDITIONS	
Temperature	+25 ± 5 °C
Humidity	31 % ± 10% RH
Barometric Pressure	101.4 kpa

I.4. EQUIPMENT LIST					
ASSET NUMBER	MANUFACTURER	MODEL	DESCRIPTION	LAST CAL	CAL DUE
00072	EMCO	2075	Mini-mast	n/a	n/a
00073	EMCO	2080	Turn Table	n/a	n/a
00071	EMCO	2090	Multi-Device Controller	n/a	n/a
00085	EMCO	6502	Loop Antenna	10Aug04	10Aug05
00050	Chase	CBL-6111A	Bilog Antenna	08Feb05	08Feb06
00035	ETS	3115	Double Ridged Guide Horn	24Mar04	24Mar06
00202	ETS	3160-09	Standard Gain Horn Antenna	27Jun04	27Jun05
00015	Agilent	E4408B	Spectrum Analyzer	24Jan05	24Jan06
00051	HP	8566B	Spectrum Analyzer RF Section	12Apr05	12Apr06
00049	HP	85650A	Quasi-peak Adapter	13Apr05	13Apr06
00047	HP	85685A	RF Preselector	13Apr05	13Apr06
00048	Gore	65474	Microwave Cable	22Apr05	22Apr06
00115	Miteq	J54-00102600-35-5A	LNA	28Dec04	28Dec05

Company:	Itronix Corporation	Model:	IX325A860IWLBT	FCC ID:	KBCIX325A860IWLBT	IC ID:	1943A-IX325g
DUT Type:	IX325 Rugged Tablet PC with MSI MS-6837 Bluetooth & internal PIFA Antenna 3			2402 - 2480 MHz			
2006 Celltech Labs Inc.	This document is not to be reproduced in whole or in part without the prior written permission of Celltech Labs Inc.						Page 50 of 62

	Test Report Serial No.:	042406KBC-T743-E15B	Report Revision No.:	Revision 1.0
	Test Date(s):	18May05 - 14Jul05	Report Issue Date:	November 07, 2006
	Test Standard(s):	FCC 47 CFR §15.247	Industry Canada RSS-210 Issue 5	
	Lab Registration(s):	FCC Lab Reg. # 714830	Industry Canada Lab File # IC 3874	

I.5. MEASUREMENT EQUIPMENT SETUP

MEASUREMENT EQUIPMENT CONNECTIONS	The measurement equipment was connected as shown in I.6. A number of antennas were used to cover the applicable frequency range test. The ranges in which each antenna was used are as follows:				
	Frequency Range		Antenna		
	10 kHz – 30 MHz		EMCO 6502 Loop		
	30 MHz – 1 GHz		CBL-6111A Bilog		
	1 GHz – 18 GHz		ETS 3115 Horn		
18 GHz– 26GHz		ETS 3160-09 Horn			
MEASUREMENT EQUIPMENT SETTINGS	The spectrum analyzer was set to the following settings:				
	Frequency Range	RBW	VBW	Quasi-Peak BW	Detector
	MHz	kHz	kHz	kHz	
	0.01 - 0.15	3 ¹	30	0.2	Peak ²
	0.15 – 30	100 ¹	300	3	Peak ²
	30 – 1000	1000 ¹	300	120	Peak ²
	> 1000	1000	1000	na	Peak ²
Note 1: The Quasi-peak adapter was placed in normal for all measurements below 1000 MHz, therefore its bandwidths take precedence.					
Note 2: As a worst-case measurement, when suitable margin could be realized, the average limit was applied to measurements made with a peak detector.					

I.6. SETUP DRAWING

Figure I.6-1 - Setup Drawing

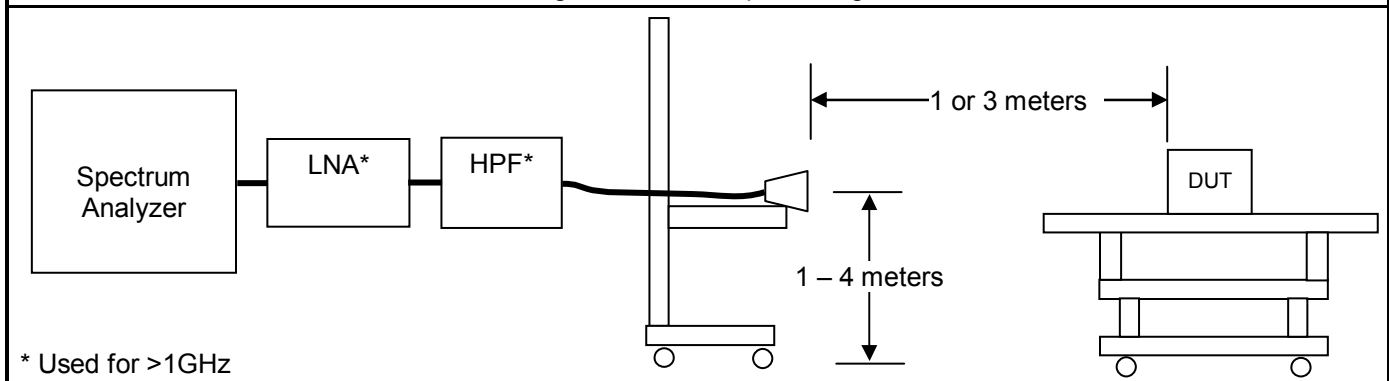

I.7. DUT OPERATING DESCRIPTION

Measurements were made at three channels throughout the band, Low Channel (2402 MHz), Mid Channel (2441 MHz), High Channel (2480 MHz). The configuration used was with a gain setting of 250/40 for the low channel, 250/44 for mid channel and 220/45 for the high channel. The modulation was set to 1000. As a worst-case, the band-edge measurements were made of the low and high channels with data stream modulation.

Company:	Itronix Corporation	Model:	IX325A860IWLBT	FCC ID:	KBCIX325A860IWLBT	IC ID:	1943A-IX325g
DUT Type:	IX325 Rugged Tablet PC with MSI MS-6837 Bluetooth & internal PIFA Antenna 3			2402 - 2480 MHz			
2006 Celltech Labs Inc.	This document is not to be reproduced in whole or in part without the prior written permission of Celltech Labs Inc.						Page 51 of 62

Test Report Serial No.:	042406KBC-T743-E15B	Report Revision No.:	Revision 1.0
Test Date(s):	18May05 - 14Jul05	Report Issue Date:	November 07, 2006
Test Standard(s):	FCC 47 CFR §15.247	Industry Canada RSS-210 Issue 5	
Lab Registration(s):	FCC Lab Reg. # 714830	Industry Canada Lab File # IC 3874	

I.8. SETUP PHOTOGRAPHS

Photograph I.8-1 - Loop Antenna (10kHz - 30MHz)



Photograph I.8-2 - Bilog Antenna (30MHz - 1GHz)



Photograph I.8-3 - 3115 Horn Antenna (1GHz - 2GHz)



Photograph I.8-4 - 3115 Horn Antenna (2GHz - 10GHz)



Photograph I.8-5 - 3115 Horn Antenna (10GHz - 18GHz)



Photograph I.8-6 - 3160-09 Horn (18GHz - 24GHz)



Company:	Itronix Corporation	Model:	IX325A860IWLBT	FCC ID:	KBCIX325A860IWLBT	IC ID:	1943A-IX325g
DUT Type:	IX325 Rugged Tablet PC with MSI MS-6837 Bluetooth & internal PIFA Antenna 3			2402 - 2480 MHz		ITRONIX A GENERAL DYNAMICS COMPANY	
2006 Celltech Labs Inc.	This document is not to be reproduced in whole or in part without the prior written permission of Celltech Labs Inc.						Page 52 of 62



Test Report Serial No.:	042406KBC-T743-E15B	Report Revision No.:	Revision 1.0
Test Date(s):	18May05 - 14Jul05	Report Issue Date:	November 07, 2006
Test Standard(s):	FCC 47 CFR §15.247	Industry Canada RSS-210 Issue 5	
Lab Registration(s):	FCC Lab Reg. # 714830	Industry Canada Lab File # IC 3874	

I.9. TEST RESULTS

I.9.1. Emission Field Strengths near Lower Band-edge @ Specified Distance

Note: (Actual Lower Band-edge (Out-of-Band) is in Appendix H)

Channel 0 - Conducted Band-edge Plots

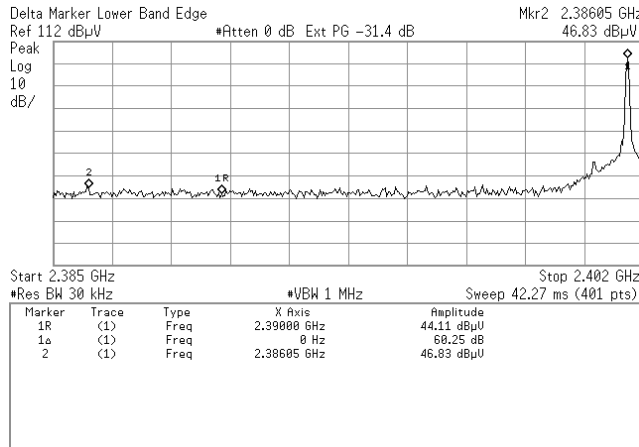

Channel 0 - Radiated Carrier Field Strengths

Channel	Polarity	Measurement Distance	Antenna	Frequency	SA Level	Noise Floor	AF	CL	Other	Total CF	Field Strength	Detector	RBW
							dB/m	dB	dB	dB/m	dBµV/m		kHz
BT-CH0	H	3	Horn SN6276	2401.96	84.20		30.24	5.08	-23.13	12.19	96.39	PK	1000
BT-CH0	H	3	Horn SN6276	2401.94	84.30		30.24	5.08	-23.13	12.19	96.49	AV	1000
BT-CH0	V	3	Horn SN6276	2401.97	81.95		30.24	5.08	-23.13	12.19	94.14	PK	1000
BT-CH0	V	3	Horn SN6276	2401.97	82.00		30.24	5.08	-23.13	12.19	94.19	AV	1000

Channel 0 - Calculated Band-edge (Restricted Band) Field Strengths

Channel	Polarity	Distance	Frequency	Carrier Radiated Field Strength	Delta Marker	Detector	Calculated Bandedge Field Strength	Duty Cycle Correction	Corrected Bandedge Field Strength	Specifield Limit	Specified Limit Distance	Limit Distance Correction	Calculated Limit	Margin	Pass/Fail
BT-CH0	H	3	2390.00	96.39	60.25	PK	36.14	0.00	36.14	73.98	3.00	0.00	73.98	37.84	PASS
BT-CH0	H	3	2390.00	96.49	60.25	AV	36.24	0.00	36.24	53.98	3.00	0.00	53.98	17.74	PASS
BT-CH0	V	3	2390.00	94.14	60.25	PK	33.89	0.00	33.89	73.98	3.00	0.00	73.98	40.09	PASS
BT-CH0	V	3	2390.00	94.19	60.25	AV	33.94	0.00	33.94	53.98	3.00	0.00	53.98	20.04	PASS

Formulae:

Total CF (dB) = Antenna Factor (dB) + Cable Factor (dB) + Other Factor (Amplifier Gain, Filter Loss, etc) (dB)

Field Strength (dBµV/m) = SA Reading (dBµV) + Total CF (dB/m)

Limit Distance Correction (dB) = 40 * log(d1/d2) for f < 30 MHz, 20*log(d1/d2) for f > 30 MHz; where d1 is the measurement distance and d2 is the published limit

Limit (dBµV/m) = Published Limit (dBµV/m) + Limit Distance Correction (dB)

Margin (dB) = Limit (dBµV/m) - Field Strength (dBµV/m)

Note: Measurements and calculation reference the Marker-Delta Method Described in FCC Public Notice DA 00-705

Company:	Itronix Corporation	Model:	IX325A860IWLBT	FCC ID:	KBCIX325A860IWLBT	IC ID:	1943A-IX325g	
DUT Type:	IX325 Rugged Tablet PC with MSI MS-6837 Bluetooth & internal PIFA Antenna 3			2402 - 2480 MHz		ITRONIX A GENERAL DYNAMICS COMPANY		
2006 Celltech Labs Inc.		This document is not to be reproduced in whole or in part without the prior written permission of Celltech Labs Inc.					Page 53 of 62	

	Test Report Serial No.:	042406KBC-T743-E15B	Report Revision No.:	Revision 1.0
	Test Date(s):	18May05 - 14Jul05	Report Issue Date:	November 07, 2006
	Test Standard(s):	FCC 47 CFR §15.247	Industry Canada RSS-210 Issue 5	
	Lab Registration(s):	FCC Lab Reg. # 714830	Industry Canada Lab File # IC 3874	

1.9.2. Upper Band-edge Emission Field Strengths @ Specified Distance

Channel 78 - Conducted Band-edge Plots

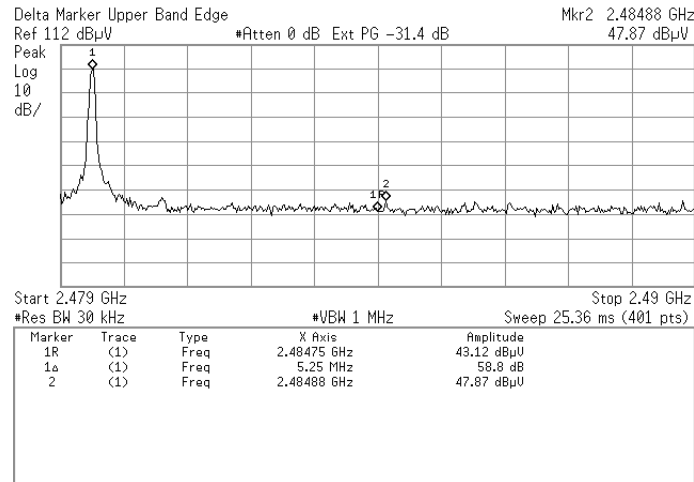

Channel 0 - Radiated Carrier Field Strengths

Channel	Polarity	Measurement Distance	Antenna	Frequency	SA Level	Noise Floor	AF	CL	Other	Total CF	Field Strength	Detector	RBW
							dB/m	dB	dB	dB/m	dBuV/m		kHz
BT-CH78	H	3	Horn SN6276	2479.95	87.25		30.37	5.17	-23.12	12.41	99.66	PK	1000
BT-CH78	H	3	Horn SN6276	2479.95	87.25		30.37	5.17	-23.12	12.41	99.66	AV	1000
BT-CH78	V	3	Horn SN6276	2479.95	82.75		30.37	5.17	-23.12	12.41	95.16	PK	1000
BT-CH78	V	3	Horn SN6276	2479.95	82.75		30.37	5.17	-23.12	12.41	95.16	AV	1000

Channel 0 - Calculated Band-edge (Out-of-Band) Field Strengths

Channel	Polarity	Distance	Frequency	Carrier Radiated Field Strength	Delta Marker	Detector	Calculated Bandedge Field Strength	Duty Cycle Correction	Corrected Bandedge Field Strength	Specifield Limit	Specified Limit Distance	Limit Distance Correction	Calculated Limit	Margin	Pass/Fail
BT-CH78	H	3	2484.80	99.66	54.05	PK	45.61	0.00	45.61	73.98	3.00	0.00	73.98	28.37	PASS
BT-CH78	H	3	2484.80	99.66	54.05	AV	45.61	0.00	45.61	53.98	3.00	0.00	53.98	8.37	PASS
BT-CH78	V	3	2484.80	95.16	54.05	PK	41.11	0.00	41.11	73.98	3.00	0.00	73.98	32.87	PASS
BT-CH78	V	3	2484.80	95.16	54.05	AV	41.11	0.00	41.11	53.98	3.00	0.00	53.98	12.87	PASS

Formulae:

Total CF (dB) = Antenna Factor (dB) + Cable Factor (dB) + Other Factor (Amplifier Gain, Filter Loss, etc) (dB)

Field Strength (dBuV/m) = SA Reading (dBuV) + Total CF (dB/m)

Limit Distance Correction (dB) = 40 * log(d1/d2) for f < 30 MHz, 20*log(d1/d2) for f > 30 MHz; where d1 is the measurement distance and d2 is the published limit

Limit (dBuV/m) = Published Limit (dBuV/m) + Limit Distance Correction (dB)

Margin (dB) = Limit (dBuV/m) - Field Strength (dBuV/m)

Note: Measurements and calculation reference the Marker-Delta Method Described in FCC Public Notice DA 00-705

Company:	Itronix Corporation	Model:	IX325A860IWLBT	FCC ID:	KBCIX325A860IWLBT	IC ID:	1943A-IX325g	
DUT Type:	IX325 Rugged Tablet PC with MSI MS-6837 Bluetooth & internal PIFA Antenna 3			2402 - 2480 MHz				
2006 Celltech Labs Inc.		This document is not to be reproduced in whole or in part without the prior written permission of Celltech Labs Inc.					Page 54 of 62	



Test Report Serial No.:	042406KBC-T743-E15B	Report Revision No.:	Revision 1.0
Test Date(s):	18May05 - 14Jul05	Report Issue Date:	November 07, 2006
Test Standard(s):	FCC 47 CFR §15.247	Industry Canada RSS-210 Issue 5	
Lab Registration(s):	FCC Lab Reg. # 714830	Industry Canada Lab File # IC 3874	

I.9.3. Spurious Emission Field Strengths @ Specified Distance

Channel 0 - Horizontal Polarization

Channel	Polarity	Distance m	Rx Antenna	Frequency MHz	SA Level dBuV	Category	Rx AF	Rx CL	Other Rx	Total Rx CF	Field Strength	Detector PK/QP/AV	Limit Distance	Limit Distance Correction	Calculated Limit	Margin	Pass/Fail
							dB/m	dB	dB	dB/m	dBuV/m		m	dB	dBuV/m	dB	
BT-CH0	H	3	Horn SN6276	1106.90	16.60		26.65	3.42	0.00	30.07	46.67	PK*	3.00	0.00	53.98	7.31	PASS
BT-CH0	H	3	Horn SN6276	1170.10	16.20	NF	26.74	3.52	0.00	30.26	46.46	PK*	3.00	0.00	53.98	7.52	PASS
BT-CH0	H	3	Horn SN6276	1332.62	16.60	NF	26.97	3.75	0.00	30.71	47.31	PK*	3.00	0.00	53.98	6.67	PASS
BT-CH0	H	3	Horn SN6276	1536.52	16.20	NF	27.38	4.02	0.00	31.40	47.60	PK*	3.00	0.00	53.98	6.38	PASS
BT-CH0	H	3	Horn SN6276	1598.84	16.20	NF	27.67	4.15	0.00	31.82	48.02	PK*	3.00	0.00	53.98	5.96	PASS
BT-CH0	H	3	Horn SN6276	1663.78	16.60	NF	27.99	4.24	0.00	32.22	48.82	PK*	3.00	0.00	53.98	5.16	PASS
BT-CH0	H	3	Horn SN6276	2317.00	41.15	NF	30.11	4.99	-23.13	11.96	53.11	PK	3.00	0.00	73.98	20.87	PASS
BT-CH0	H	3	Horn SN6276	2315.84	27.85	NF	30.11	4.98	-23.13	11.96	39.81	AV	3.00	0.00	53.98	14.17	PASS
BT-CH0	H	3	Horn SN6276	2324.42	41.55	NF	30.12	5.00	-23.13	11.99	53.54	PK	3.00	0.00	73.98	20.44	PASS
BT-CH0	H	3	Horn SN6276	2334.76	27.85	NF	30.14	5.02	-23.13	12.02	39.87	AV	3.00	0.00	53.98	14.11	PASS
BT-CH0	H	3	Horn SN6276	2378.66	41.60	NF	30.21	5.05	-23.13	12.13	53.73	PK	3.00	0.00	73.98	20.25	PASS
BT-CH0	H	3	Horn SN6276	2382.82	27.70	NF	30.21	5.05	-23.13	12.14	39.84	AV	3.00	0.00	53.98	14.14	PASS
BT-CH0	H	3	Horn SN6276	2494.12	39.25		30.39	5.23	-23.12	12.50	51.75	PK*	3.00	0.00	53.98	2.23	PASS
BT-CH0	H	3	Horn SN6276	2485.60	42.80		30.38	5.19	-23.12	12.45	55.25	PK	3.00	0.00	73.98	18.73	PASS
BT-CH0	H	3	Horn SN6276	2490.54	28.05		30.38	5.21	-23.12	12.48	40.53	AV	3.00	0.00	53.98	13.45	PASS
BT-CH0	H	3	Horn SN6276	2788.90	40.80	NF	31.32	5.53	-23.10	13.76	54.56	PK	3.00	0.00	73.98	19.42	PASS
BT-CH0	H	3	Horn SN6276	2773.36	27.50	NF	31.27	5.53	-23.10	13.71	41.21	AV	3.00	0.00	53.98	12.77	PASS
BT-CH0	H	3	Horn SN6276	4799.96	33.65	NF	35.30	7.62	-31.04	11.88	45.53	PK*	3.00	0.00	53.98	8.45	PASS
BT-CH0	H	3	Horn SN6276	7597.85	36.80	NF	38.78	10.17	-30.81	18.14	54.94	PK	3.00	0.00	73.98	19.04	PASS
BT-CH0	H	3	Horn SN6276	7580.37	23.90	NF	38.76	10.07	-30.81	18.02	41.92	AV	3.00	0.00	53.98	12.06	PASS
BT-CH0	H	3	Horn SN6276	8302.91	39.25		39.28	10.25	-30.77	18.76	58.01	PK	3.00	0.00	73.98	15.97	PASS
BT-CH0	H	3	Horn SN6276	8302.90	30.75		39.28	10.25	-30.77	18.76	49.51	AV	3.00	0.00	53.98	4.47	PASS
BT-CH0	H	3	Horn SN6276	9417.79	36.05	NF	40.28	11.72	-30.72	21.28	57.33	PK	3.00	0.00	73.98	16.65	PASS
BT-CH0	H	3	Horn SN6276	9421.77	22.65	NF	40.28	11.72	-30.72	21.29	43.94	AV	3.00	0.00	53.98	10.04	PASS
BT-CH0	H	1	Horn SN6276	12008.50	45.50		40.51	17.25	-30.61	27.15	72.65	PK	3.00	9.54	83.52	10.87	PASS
BT-CH0	H	1	Horn SN6276	12008.50	33.55		40.51	17.25	-30.61	27.15	60.70	AV	3.00	9.54	63.52	2.82	PASS
BT-CH0	H	1	3160-09	19207.84	45.25	NF	40.24	22.00	-35.18	27.06	72.31	PK	3.00	9.54	83.52	11.21	PASS
BT-CH0	H	1	3160-09	19216.72	31.95	NF	40.24	22.01	-35.18	27.07	59.02	AV	3.00	9.54	63.52	4.51	PASS
BT-CH0	H	1	3160-09	19579.00	44.90	NF	40.30	22.18	-35.38	27.11	72.01	PK	3.00	9.54	83.52	11.51	PASS
BT-CH0	H	1	3160-09	19593.16	32.05	NF	40.30	22.19	-35.38	27.11	59.16	AV	3.00	9.54	63.52	4.36	PASS
BT-CH0	H	1	3160-09	21377.04	46.70		40.30	22.57	-35.58	27.29	73.99	PK	3.00	9.54	83.52	9.53	PASS
BT-CH0	H	1	3160-09	21367.02	33.45		40.30	22.57	-35.58	27.29	60.74	AV	3.00	9.54	63.52	2.79	PASS
BT-CH0	H	1	3160-09	22108.40	47.70		40.32	22.67	-35.58	27.41	75.11	PK	3.00	9.54	83.52	8.41	PASS
BT-CH0	H	1	3160-09	22103.14	34.25		40.32	22.67	-35.58	27.41	61.66	AV	3.00	9.54	63.52	1.86	PASS
BT-CH0	H	1	3160-09	23805.04	48.15		40.40	22.89	-35.56	27.74	75.89	PK	3.00	9.54	83.52	7.64	PASS
BT-CH0	H	1	3160-09	23801.86	35.15		40.40	22.89	-35.56	27.74	62.89	AV	3.00	9.54	63.52	0.64	PASS

Formulae:

Total CF = Antenna Factor + Cable Factor + Other Factor (Amplifier Gain, filter loss, etc)

Field Strength = SA Reading + Total CF

Limit Distance Correction = 40*log(d1/d2) for F<30 MHz, 20*log(d1/d2) for F> 30 MHz:

where d1 is the measurement distance, d2 is the published limit distance

Limit = Specified Limit + Limit Distance Correction

Margin = Limit - Field Strength

*PK = QP or Average Limits where applied to the peak emission

***The frequency points reported, describe the highest emission measured in each of the ranges tested and are used to describe the measured spectrum as a whole. Though a frequency point detailed may not be in a restricted band, it was the highest emission present in the band measured therefore infers that all emissions that may be present within the restricted bands are in compliance if it is in compliance.**

Company:	Itronix Corporation	Model:	IX325A860IWLBT	FCC ID:	KBCIX325A860IWLBT	IC ID:	1943A-IX325g
DUT Type:	IX325 Rugged Tablet PC with MSI MS-6837 Bluetooth & internal PIFA Antenna 3			2402 - 2480 MHz		ITRONIX <small>A GENERAL DYNAMICS COMPANY</small>	
2006 Celltech Labs Inc.	This document is not to be reproduced in whole or in part without the prior written permission of Celltech Labs Inc.						Page 55 of 62



Test Report Serial No.:	042406KBC-T743-E15B	Report Revision No.:	Revision 1.0
Test Date(s):	18May05 - 14Jul05	Report Issue Date:	November 07, 2006
Test Standard(s):	FCC 47 CFR §15.247	Industry Canada RSS-210 Issue 5	
Lab Registration(s):	FCC Lab Reg. # 714830	Industry Canada Lab File # IC 3874	

Channel 0 - Vertical Polarization

Channel	Polarity	Distance m	Rx Antenna	Frequency MHz	SA Level dBuV	Category	Rx AF	Rx CL	Other Rx	Total Rx CF	Field Strength	Detector	Limit Distance	Limit Distance Correction	Calculated Limit	Margin	Pass/Fail
							dB/m	dB	dB	dB/m	dBuV/m	PK/QP/AV	m	dB	dBuV/m	dB	
BT-CH0	V	3	Horn SN6276	1074.02	38.80	NF	26.60	3.36	0.00	29.96	68.76	PK	3.00	0.00	73.98	5.22	PASS
BT-CH0	V	3	Horn SN6276	1074.53	2.40	NF	26.60	3.36	0.00	29.96	32.36	AV	3.00	0.00	53.98	21.62	PASS
BT-CH0	V	3	Horn SN6276	1093.12	25.70	NF	26.63	3.40	0.00	30.03	55.73	PK	3.00	0.00	73.98	18.25	PASS
BT-CH0	V	3	Horn SN6276	1093.08	2.50	NF	26.63	3.40	0.00	30.03	32.53	AV	3.00	0.00	53.98	21.45	PASS
BT-CH0	V	3	Horn SN6276	1105.07	16.40	NF	26.65	3.42	0.00	30.07	46.47	PK*	3.00	0.00	53.98	7.51	PASS
BT-CH0	V	3	Horn SN6276	1113.02	15.60	NF	26.66	3.43	0.00	30.09	45.69	PK*	3.00	0.00	53.98	8.29	PASS
BT-CH0	V	3	Horn SN6276	1129.98	32.10	NF	26.68	3.47	0.00	30.15	62.25	PK	3.00	0.00	73.98	11.73	PASS
BT-CH0	V	3	Horn SN6276	1130.00	2.50		26.68	3.47	0.00	30.15	32.65	AV	3.00	0.00	53.98	21.33	PASS
BT-CH0	V	3	Horn SN6276	1136.83	14.80		26.69	3.49	0.00	30.18	44.98	PK*	3.00	0.00	53.98	9.00	PASS
BT-CH0	V	3	Horn SN6276	1152.15	16.50		26.71	3.51	0.00	30.22	46.72	PK*	3.00	0.00	53.98	7.26	PASS
BT-CH0	V	3	Horn SN6276	1351.60	16.20	NF	26.99	3.78	0.00	30.78	46.98	PK*	3.00	0.00	53.98	7.00	PASS
BT-CH0	V	3	Horn SN6276	2332.68	40.00	NF	30.13	5.01	-23.13	12.01	52.01	PK	3.00	0.00	73.98	21.97	PASS
BT-CH0	V	3	Horn SN6276	2332.68	27.70	NF	30.13	5.01	-23.13	12.01	39.71	AV	3.00	0.00	53.98	14.27	PASS
BT-CH0	V	3	Horn SN6276	2387.56	41.15	NF	30.22	5.06	-23.13	12.15	53.30	PK	3.00	0.00	73.98	20.68	PASS
BT-CH0	V	3	Horn SN6276	2379.80	27.70	NF	30.21	5.05	-23.13	12.13	39.83	AV	3.00	0.00	53.98	14.15	PASS
BT-CH0	V	3	Horn SN6276	2680.96	47.60		30.98	5.43	-23.10	13.31	60.91	PK	3.00	0.00	73.98	13.07	PASS
BT-CH0	V	3	Horn SN6276	2680.96	32.40		30.98	5.43	-23.10	13.31	45.71	AV	3.00	0.00	53.98	8.27	PASS
BT-CH0	V	3	Horn SN6276	2738.00	42.65		31.16	5.44	-23.10	13.50	56.15	PK	3.00	0.00	73.98	17.83	PASS
BT-CH0	V	3	Horn SN6276	2738.00	29.25		31.16	5.44	-23.10	13.50	42.75	AV	3.00	0.00	53.98	11.23	PASS
BT-CH0	V	3	Horn SN6276	2795.00	40.90	NF	31.34	5.53	-23.10	13.77	54.67	PK	3.00	0.00	73.98	19.30	PASS
BT-CH0	V	3	Horn SN6276	2795.98	27.65	NF	31.35	5.53	-23.09	13.78	41.43	AV	3.00	0.00	53.98	12.55	PASS
BT-CH0	V	3	Horn SN6276	2851.26	41.10	NF	31.52	5.60	-23.09	14.03	55.13	PK	3.00	0.00	73.98	18.85	PASS
BT-CH0	V	3	Horn SN6276	2838.90	27.20	NF	31.48	5.57	-23.09	13.96	41.16	AV	3.00	0.00	53.98	12.82	PASS
BT-CH0	V	3	Horn SN6276	4328.35	33.65	NF	34.70	7.02	-31.08	10.64	44.29	PK*	3.00	0.00	53.98	9.69	PASS
BT-CH0	V	3	Horn SN6276	4790.65	32.50	NF	35.28	7.55	-31.04	11.79	44.29	PK*	3.00	0.00	53.98	9.69	PASS
BT-CH0	V	3	Horn SN6276	4804.00	32.95	NF	35.31	7.58	-31.04	11.84	44.79	PK*	3.00	0.00	53.98	9.19	PASS
BT-CH0	V	3	Horn SN6276	7540.57	41.35	NF	38.73	9.81	-30.82	17.72	59.07	PK	3.00	0.00	73.98	14.91	PASS
BT-CH0	V	3	Horn SN6276	7540.51	34.85	NF	38.73	9.81	-30.82	17.72	52.57	AV	3.00	0.00	53.98	1.41	PASS
BT-CH0	V	3	Horn SN6276	8374.94	36.30		39.32	10.22	-30.76	18.78	55.08	PK	3.00	0.00	73.98	18.90	PASS
BT-CH0	V	3	Horn SN6276	8375.10	25.30		39.33	10.22	-30.76	18.78	44.08	AV	3.00	0.00	53.98	9.90	PASS
BT-CH0	V	1	Horn SN6276	12008.50	44.05		40.51	17.25	-30.61	27.15	71.20	PK	3.00	9.54	83.52	12.32	PASS
BT-CH0	V	1	Horn SN6276	12008.50	33.60		40.51	17.25	-30.61	27.15	60.75	AV	3.00	9.54	63.52	2.77	PASS
BT-CH0	V	1	3160-09	19214.64	45.60	NF	40.24	22.01	-35.18	27.07	72.67	PK	3.00	9.54	83.52	10.86	PASS
BT-CH0	V	1	3160-09	19221.42	32.05	NF	40.24	22.01	-35.19	27.07	59.12	AV	3.00	9.54	63.52	4.40	PASS
BT-CH0	V	1	3160-09	19795.44	45.30	NF	40.30	22.29	-35.49	27.10	72.40	PK	3.00	9.54	83.52	11.12	PASS
BT-CH0	V	1	3160-09	19796.36	32.35	NF	40.30	22.29	-35.49	27.10	59.45	AV	3.00	9.54	63.52	4.07	PASS
BT-CH0	V	1	3160-09	23728.96	49.10	NF	40.40	22.88	-35.56	27.73	76.83	PK	3.00	9.54	83.52	6.70	PASS
BT-CH0	V	1	3160-09	23714.44	35.20	NF	40.40	22.88	-35.56	27.72	62.92	AV	3.00	9.54	63.52	0.60	PASS

Formulae:

Total CF = Antenna Factor + Cable Factor + Other Factor (Amplifier Gain, filter loss, etc)

Field Strength = SA Reading + Total CF

Limit Distance Correction = 40*log(d1/d2) for F<30 MHz, 20*log(d1/d2) for F> 30 MHz:

where d1 is the measurement distance, d2 is the published limit distance

Limit = Specified Limit + Limit Distance Correction

Margin = Limit - Field Strength

*PK = QP or Average Limits where applied to the peak emission

***The frequency points reported, describe the highest emission measured in each of the ranges tested and are used to describe the measured spectrum as a whole. Emissions that may be present in the restricted bands are evaluated against the appropriate limits in Appendix I. No out-of-band emissions were measured above the levels noted.**

Company:	Itronix Corporation	Model:	IX325A860IWLBT	FCC ID:	KBCIX325A860IWLBT	IC ID:	1943A-IX325g
DUT Type:	IX325 Rugged Tablet PC with MSI MS-6837 Bluetooth & internal PIFA Antenna 3			2402 - 2480 MHz		ITRONIX <small>A GENERAL DYNAMICS COMPANY</small>	
2006 Celltech Labs Inc.	This document is not to be reproduced in whole or in part without the prior written permission of Celltech Labs Inc.						Page 56 of 62



Test Report Serial No.:	042406KBC-T743-E15B	Report Revision No.:	Revision 1.0
Test Date(s):	18May05 - 14Jul05	Report Issue Date:	November 07, 2006
Test Standard(s):	FCC 47 CFR §15.247	Industry Canada RSS-210 Issue 5	
Lab Registration(s):	FCC Lab Reg. # 714830	Industry Canada Lab File # IC 3874	

Channel 39 - Horizontal Polarization

Channel	Polarity	Distance m	Rx Antenna	Frequency MHz	SA Level dBuV	Category	Rx AF	Rx CL	Other Rx	Total Rx CF	Field Strength	Detector	Limit Distance	Limit Distance Correction	Calculated Limit	Margin	Pass/Fail
							dB/m	dB	dB	dB/m	dBuV/m	PK/QP/AV	m	dB	dBuV/m	dB	
BT-CH39	H	3	Hom SN6276	1023.68	13.40	NF	26.53	3.44	0.00	29.98	43.38	PK*	3.00	0.00	53.98	10.60	PASS
BT-CH39	H	3	Hom SN6276	1120.90	15.00	NF	26.67	3.44	0.00	30.11	45.11	PK*	3.00	0.00	53.98	8.87	PASS
BT-CH39	H	3	Hom SN6276	1344.02	18.60	NF	26.98	3.76	0.00	30.74	49.34	PK*	3.00	0.00	53.98	4.64	PASS
BT-CH39	H	3	Hom SN6276	1377.45	16.20	NF	27.03	3.81	0.00	30.84	47.04	PK*	3.00	0.00	53.98	6.94	PASS
BT-CH39	H	3	Hom SN6276	1391.67	17.20	NF	27.05	3.86	0.00	30.90	48.10	PK*	3.00	0.00	53.98	5.87	PASS
BT-CH39	H	3	Hom SN6276	1494.27	16.80	NF	27.19	4.02	0.00	31.21	48.01	PK*	3.00	0.00	53.98	5.97	PASS
BT-CH39	H	3	Hom SN6276	1679.31	16.80	NF	28.06	4.24	0.00	32.30	49.10	PK*	3.00	0.00	53.98	4.88	PASS
BT-CH39	H	3	Hom SN6276	2334.82	35.70		30.14	5.02	-23.13	12.02	47.72	PK*	3.00	0.00	53.98	6.26	PASS
BT-CH39	H	3	Hom SN6276	2703.28	35.40	NF	31.05	5.45	-23.10	13.40	48.80	PK*	3.00	0.00	53.98	5.18	PASS
BT-CH39	H	3	Hom SN6276	4605.32	32.70	NF	34.91	7.35	-31.06	11.20	43.90	PK*	3.00	0.00	53.98	10.08	PASS
BT-CH39	H	3	Hom SN6276	4881.25	37.60		35.46	7.66	-31.03	12.09	49.69	PK*	3.00	0.00	53.98	4.29	PASS
BT-CH39	H	3	Hom SN6276	4951.26	31.05	NF	35.60	7.64	-31.03	12.22	43.27	PK*	3.00	0.00	53.98	10.71	PASS
BT-CH39	H	3	Hom SN6276	7323.00	47.90		38.38	9.96	-30.84	17.51	65.41	PK	3.00	0.00	73.98	8.57	PASS
BT-CH39	H	3	Hom SN6276	7323.00	32.60		38.38	9.96	-30.84	17.51	50.11	AV	3.00	0.00	53.98	3.87	PASS
BT-CH39	H	3	Hom SN6276	8303.63	38.00		39.28	10.26	-30.77	18.77	56.77	PK	3.00	0.00	73.98	17.21	PASS
BT-CH39	H	3	Hom SN6276	8303.27	28.80		39.28	10.25	-30.77	18.77	47.57	AV	3.00	0.00	53.98	6.41	PASS
BT-CH39	H	3	Hom SN6276	8375.71	40.80		39.33	10.21	-30.76	18.77	59.57	PK	3.00	0.00	73.98	14.41	PASS
BT-CH39	H	3	Hom SN6276	8375.53	33.70		39.33	10.21	-30.76	18.77	52.47	AV	3.00	0.00	53.98	1.50	PASS
BT-CH39	H	3	Hom SN6276	9436.97	35.50	NF	40.29	11.85	-30.72	21.42	56.92	PK	3.00	0.00	73.98	17.06	PASS
BT-CH39	H	3	Hom SN6276	9454.83	22.45	NF	40.29	11.76	-30.72	21.33	43.78	AV	3.00	0.00	53.98	10.20	PASS
BT-CH39	H	1	Hom SN6276	11837.98	36.00	NF	40.47	17.41	-30.62	27.25	63.25	PK	3.00	9.54	83.52	20.27	PASS
BT-CH39	H	1	Hom SN6276	11887.86	23.45	NF	40.48	17.19	-30.62	27.05	50.50	AV	3.00	9.54	63.52	13.02	PASS
BT-CH39	H	1	Hom SN6276	12203.50	43.70		40.78	16.17	-30.60	26.35	70.05	PK	3.00	9.54	83.52	13.47	PASS
BT-CH39	H	1	Hom SN6276	12203.50	33.10		40.78	16.17	-30.60	26.35	59.45	AV	3.00	9.54	63.52	4.07	PASS
BT-CH39	H	1	Hom SN6276	16049.24	42.35	NF	40.73	20.77	-31.62	29.89	72.24	PK	3.00	9.54	83.52	11.28	PASS
BT-CH39	H	1	Hom SN6276	16042.36	29.40	NF	40.71	21.06	-31.61	30.16	59.56	AV	3.00	9.54	63.52	3.96	PASS
BT-CH39	H	1	Hom SN6276	17969.75	38.07	NF	45.81	11.15	-32.63	24.33	62.40	PK	3.00	9.54	83.52	21.12	PASS
BT-CH39	H	1	Hom SN6276	17969.25	28.72	NF	45.81	11.15	-32.63	24.33	53.05	AV	3.00	9.54	63.52	10.47	PASS
BT-CH39	H	1	Hom SN6276	17831.10	38.68	NF	45.39	11.10	-32.56	23.94	62.62	PK	3.00	9.54	83.52	20.91	PASS
BT-CH39	H	1	Hom SN6276	17835.40	29.50	NF	45.41	11.10	-32.56	23.95	53.45	AV	3.00	9.54	63.52	10.07	PASS
BT-CH39	H	1	Hom SN6276	17921.20	38.53	NF	45.66	11.14	-32.61	24.19	62.72	PK	3.00	9.54	83.52	20.80	PASS
BT-CH39	H	1	Hom SN6276	17923.90	28.65	NF	45.67	11.14	-32.61	24.20	52.85	AV	3.00	9.54	63.52	10.67	PASS
BT-CH39	H	1	3160-09	18944.88	45.70	NF	40.20	21.87	-35.04	27.03	72.73	PK	3.00	9.54	83.52	10.79	PASS
BT-CH39	H	1	3160-09	18942.80	31.80	NF	40.20	21.87	-35.04	27.03	58.83	AV	3.00	9.54	63.52	4.69	PASS
BT-CH39	H	1	3160-09	19695.92	44.90	NF	40.30	22.24	-35.44	27.10	72.00	PK	3.00	9.54	83.52	11.52	PASS
BT-CH39	H	1	3160-09	19687.70	32.10	NF	40.30	22.24	-35.43	27.10	59.20	AV	3.00	9.54	63.52	4.32	PASS
BT-CH39	H	1	3160-09	22108.48	47.60	NF	40.32	22.67	-35.58	27.41	75.01	PK	3.00	9.54	83.52	8.51	PASS
BT-CH39	H	1	3160-09	22099.04	34.15	NF	40.32	22.67	-35.58	27.41	61.56	AV	3.00	9.54	63.52	1.96	PASS
BT-CH39	H	1	3160-09	22667.76	47.90	NF	40.40	22.74	-35.57	27.57	75.47	PK	3.00	9.54	83.52	8.05	PASS
BT-CH39	H	1	3160-09	22667.66	35.00	NF	40.40	22.74	-35.57	27.57	62.57	AV	3.00	9.54	63.52	0.95	PASS
BT-CH39	H	1	3160-09	23788.56	48.00	NF	40.40	22.89	-35.56	27.73	75.73	PK	3.00	9.54	83.52	7.79	PASS
BT-CH39	H	1	3160-09	23793.98	35.05	NF	40.40	22.89	-35.56	27.74	62.79	AV	3.00	9.54	63.52	0.74	PASS
BT-CH39	H	1	3160-09	23948.22	47.45	NF	40.40	22.91	-35.55	27.76	75.21	PK	3.00	9.54	83.52	8.31	PASS
BT-CH39	H	1	3160-09	23942.92	35.00	NF	40.40	22.91	-35.55	27.76	62.76	AV	3.00	9.54	63.52	0.77	PASS

Formulae:

Total CF = Antenna Factor + Cable Factor + Other Factor (Amplifier Gain, filter loss, etc)

Field Strength = SA Reading + Total CF

Limit Distance Correction = 40*log(d1/d2) for F<30 MHz, 20*log(d1/d2) for F > 30 MHz:

where d1 is the measurement distance, d2 is the published limit distance

Limit = Specified Limit + Limit Distance Correction

Margin = Limit - Field Strength

*PK = QP or Average Limits where applied to the peak emission

***The frequency points reported, describe the highest emission measured in each of the ranges tested and are used to describe the measured spectrum as a whole. Emissions that may be present in the restricted bands are evaluated against the appropriate limits in Appendix I. No out-of-band emissions were measured above the levels noted.**

Company:	Itronix Corporation	Model:	IX325A860IWLBT	FCC ID:	KBCIX325A860IWLBT	IC ID:	1943A-IX325g
DUT Type:	IX325 Rugged Tablet PC with MSI MS-6837 Bluetooth & internal PIFA Antenna 3				2402 - 2480 MHz		ITRONIX <small>A GENERAL DYNAMICS COMPANY</small>
2006 Celltech Labs Inc.	This document is not to be reproduced in whole or in part without the prior written permission of Celltech Labs Inc.						Page 57 of 62



Test Report Serial No.:	042406KBC-T743-E15B	Report Revision No.:	Revision 1.0
Test Date(s):	18May05 - 14Jul05	Report Issue Date:	November 07, 2006
Test Standard(s):	FCC 47 CFR §15.247	Industry Canada RSS-210 Issue 5	
Lab Registration(s):	FCC Lab Reg. # 714830	Industry Canada Lab File # IC 3874	

Channel 78 - Horizontal Polarization

Channel	Polarity	Distance m	Rx Antenna	Frequency MHz	SA Level dBuV	Category	Rx AF	Rx CL	Other Rx	Total Rx CF	Field Strength	Detector	Limit Distance	Limit Distance Correction	Calculated Limit	Margin	Pass/Fail
							dB/m	dB	dB	dB/m	dBuV/m		PK/QP/AV	m			
BT-CH78	H	3	Horn SN6276	2258.92	36.55	NF	30.01	4.93	-23.14	11.81	48.36	PK	3.00	0.00	73.98	25.62	PASS
BT-CH78	H	3	Horn SN6276	2265.90	22.00	NF	30.03	4.93	-23.14	11.82	33.82	AV	3.00	0.00	53.98	20.16	PASS
BT-CH78	H	3	Horn SN6276	4959.28	32.25	NF	35.62	7.68	-31.03	12.27	44.52	PK	3.00	0.00	73.98	29.46	PASS
BT-CH78	H	3	Horn SN6276	4956.42	19.30	NF	35.61	7.66	-31.03	12.25	31.55	AV	3.00	0.00	53.98	22.43	PASS
BT-CH78	H	3	Horn SN6276	7443.75	37.15	NF	38.60	9.85	-30.83	17.63	54.78	PK	3.00	0.00	73.98	19.20	PASS
BT-CH78	H	3	Horn SN6276	7439.57	23.25	NF	38.59	9.82	-30.83	17.59	40.84	AV	3.00	0.00	53.98	13.14	PASS
BT-CH78	H	3	Horn SN6276	7465.23	36.50	NF	38.64	9.99	-30.82	17.81	54.31	PK	3.00	0.00	73.98	19.67	PASS
BT-CH78	H	3	Horn SN6276	7463.25	23.45	NF	38.63	9.99	-30.82	17.80	41.25	AV	3.00	0.00	53.98	12.73	PASS
BT-CH78	H	3	Horn SN6276	8303.50	39.35		39.28	10.25	-30.77	18.77	58.12	PK	3.00	0.00	73.98	15.86	PASS
BT-CH78	H	3	Horn SN6276	8303.02	29.65		39.28	10.25	-30.77	18.76	48.41	AV	3.00	0.00	53.98	5.57	PASS
BT-CH78	H	3	Horn SN6276	8376.13	42.10		39.33	10.21	-30.76	18.77	60.87	PK	3.00	0.00	73.98	13.11	PASS
BT-CH78	H	3	Horn SN6276	8375.57	32.50		39.33	10.21	-30.76	18.77	51.27	AV	3.00	0.00	53.98	2.70	PASS
BT-CH78	H	3	Horn SN6276	9334.63	35.75	NF	40.27	11.47	-30.72	21.01	56.76	PK	3.00	0.00	73.98	17.22	PASS
BT-CH78	H	3	Horn SN6276	9329.93	22.65	NF	40.27	11.54	-30.72	21.08	43.73	AV	3.00	0.00	53.98	10.25	PASS
BT-CH78	H	3	Horn SN6276	9326.87	35.60	NF	40.27	11.58	-30.72	21.12	56.72	PK	3.00	0.00	73.98	17.26	PASS
BT-CH78	H	3	Horn SN6276	9326.71	22.65	NF	40.27	11.58	-30.72	21.12	43.77	AV	3.00	0.00	53.98	10.21	PASS
BT-CH78	H	1	Horn SN6276	11221.86	35.20	NF	40.57	20.14	-30.65	30.06	65.26	PK	3.00	9.54	83.52	18.26	PASS
BT-CH78	H	1	Horn SN6276	11220.76	22.50	NF	40.57	20.17	-30.65	30.09	52.59	AV	3.00	9.54	63.52	10.93	PASS
BT-CH78	H	1	Horn SN6276	12397.92	35.55	NF	41.06	15.67	-30.60	26.13	61.68	PK	3.00	9.54	83.52	21.84	PASS
BT-CH78	H	1	Horn SN6276	12389.40	23.00	NF	41.05	15.66	-30.60	26.11	49.11	AV	3.00	9.54	63.52	14.41	PASS
BT-CH78	H	1	Horn SN6276	15918.56	41.95	NF	40.63	23.24	-31.55	32.32	74.27	PK	3.00	9.54	83.52	9.25	PASS
BT-CH78	H	1	Horn SN6276	15922.94	29.25	NF	40.63	23.20	-31.55	32.28	61.53	AV	3.00	9.54	63.52	1.99	PASS
BT-CH78	H	1	Horn SN6276	17845.25	39.63	NF	45.44	11.11	-32.57	23.98	63.61	PK	3.00	9.54	83.52	19.92	PASS
BT-CH78	H	1	Horn SN6276	17847.25	29.51	NF	45.44	11.11	-32.57	23.98	53.49	AV	3.00	9.54	63.52	10.03	PASS
BT-CH78	H	1	Horn SN6276	17838.45	39.29	NF	45.42	11.11	-32.56	23.96	63.25	PK	3.00	9.54	83.52	20.28	PASS
BT-CH78	H	1	Horn SN6276	17835.20	29.50	NF	45.41	11.10	-32.56	23.95	53.45	AV	3.00	9.54	63.52	10.07	PASS
BT-CH78	H	1	Horn SN6276	17914.35	38.91	NF	45.64	11.13	-32.60	24.17	63.08	PK	3.00	9.54	83.52	20.44	PASS
BT-CH78	H	1	Horn SN6276	17918.55	29.58	NF	45.66	11.14	-32.61	24.18	53.76	AV	3.00	9.54	63.52	9.76	PASS
BT-CH78	H	1	3160-09	19714.22	44.95	NF	40.30	22.25	-35.45	27.10	72.05	PK	3.00	9.54	83.52	11.47	PASS
BT-CH78	H	1	3160-09	19719.10	32.05	NF	40.30	22.25	-35.45	27.10	59.15	AV	3.00	9.54	63.52	4.37	PASS
BT-CH78	H	1	3160-09	22209.26	46.85	NF	40.34	22.68	-35.57	27.45	74.30	PK	3.00	9.54	83.52	9.22	PASS
BT-CH78	H	1	3160-09	22204.52	34.35	NF	40.34	22.68	-35.57	27.45	61.80	AV	3.00	9.54	63.52	1.72	PASS
BT-CH78	H	1	3160-09	22230.48	46.80	NF	40.35	22.68	-35.57	27.46	74.26	PK	3.00	9.54	83.52	9.27	PASS
BT-CH78	H	1	3160-09	22240.98	34.40	NF	40.35	22.69	-35.57	27.46	61.86	AV	3.00	9.54	63.52	1.66	PASS
BT-CH78	H	1	3160-09	22326.60	47.25	NF	40.37	22.70	-35.57	27.49	74.74	PK	3.00	9.54	83.52	8.78	PASS
BT-CH78	H	1	3160-09	22310.62	34.35	NF	40.36	22.69	-35.57	27.48	61.83	AV	3.00	9.54	63.52	1.69	PASS
BT-CH78	H	1	3160-09	23796.94	48.05	NF	40.40	22.89	-35.56	27.74	75.79	PK	3.00	9.54	83.52	7.74	PASS
BT-CH78	H	1	3160-09	23795.12	35.10	NF	40.40	22.89	-35.56	27.74	62.84	AV	3.00	9.54	63.52	0.69	PASS
BT-CH78	H	1	3160-09	23833.76	47.95	NF	40.40	22.90	-35.55	27.74	75.69	PK	3.00	9.54	83.52	7.83	PASS
BT-CH78	H	1	3160-09	23819.64	35.05	NF	40.40	22.89	-35.55	27.74	62.79	AV	3.00	9.54	63.52	0.73	PASS

Formulae:

Total CF = Antenna Factor + Cable Factor + Other Factor (Amplifier Gain, filter loss, etc)

Field Strength = SA Reading + Total CF

Limit Distance Correction = 40*log(d1/d2) for F<30 MHz, 20*log(d1/d2) for F> 30 MHz:

where d1 is the measurement distance, d2 is the published limit distance

Limit = Specified Limit + Limit Distance Correction

Margin = Limit - Field Strength

*PK = QP or Average Limits where applied to the peak emission

***The frequency points reported, describe the highest emission measured in each of the ranges tested and are used to describe the measured spectrum as a whole. Emissions that may be present in the restricted bands are evaluated against the appropriate limits in Appendix I. No out-of-band emissions were measured above the levels noted.**

Company:	Itronix Corporation	Model:	IX325A860IWLBT	FCC ID:	KBCIX325A860IWLBT	IC ID:	1943A-IX325g
DUT Type:	IX325 Rugged Tablet PC with MSI MS-6837 Bluetooth & internal PIFA Antenna 3				2402 - 2480 MHz		ITRONIX <small>A GENERAL DYNAMICS COMPANY</small>
2006 Celltech Labs Inc.	This document is not to be reproduced in whole or in part without the prior written permission of Celltech Labs Inc.						Page 59 of 62



Test Report Serial No.:	042406KBC-T743-E15B	Report Revision No.:	Revision 1.0
Test Date(s):	18May05 - 14Jul05	Report Issue Date:	November 07, 2006
Test Standard(s):	FCC 47 CFR §15.247	Industry Canada RSS-210 Issue 5	
Lab Registration(s):	FCC Lab Reg. # 714830	Industry Canada Lab File # IC 3874	

Channel 78 - Vertical Polarization

BT-CH78	V	3	Hom SN6276	2317.40	38.20		30.11	4.99	-23.13	11.96	50.16	PK*	3.00	0.00	53.98	3.82	PASS
BT-CH78	V	3	Hom SN6276	2342.84	35.55		30.15	5.03	-23.13	12.05	47.60	PK*	3.00	0.00	53.98	6.38	PASS
BT-CH78	V	3	Hom SN6276	2344.30	22.55		30.15	5.03	-23.13	12.05	34.60	AV	3.00	0.00	53.98	19.38	PASS
BT-CH78	V	3	Hom SN6276	2683.22	42.70		30.99	5.44	-23.10	13.32	56.02	PK	3.00	0.00	73.98	17.96	PASS
BT-CH78	V	3	Hom SN6276	2684.70	26.45		30.99	5.44	-23.10	13.32	39.77	AV	3.00	0.00	53.98	14.21	PASS
BT-CH78	V	3	Hom SN6276	2697.34	48.45		31.03	5.45	-23.10	13.38	61.83	PK	3.00	0.00	73.98	12.15	PASS
BT-CH78	V	3	Hom SN6276	2699.40	31.95		31.04	5.46	-23.10	13.39	45.34	AV	3.00	0.00	53.98	8.64	PASS
BT-CH78	V	3	Hom SN6276	2713.66	36.99		31.08	5.43	-23.10	13.41	50.40	PK*	3.00	0.00	53.98	3.58	PASS
BT-CH78	V	3	Hom SN6276	2712.54	37.10		31.08	5.43	-23.10	13.41	50.51	PK*	3.00	0.00	53.98	3.47	PASS
BT-CH78	V	3	Hom SN6276	2705.18	21.55		31.06	5.45	-23.10	13.40	34.95	AV	3.00	0.00	53.98	19.03	PASS
BT-CH78	V	3	Hom SN6276	2754.02	39.70		31.21	5.50	-23.10	13.61	53.31	PK	3.00	0.00	73.98	20.67	PASS
BT-CH78	V	3	Hom SN6276	2754.56	29.00		31.21	5.50	-23.10	13.61	42.61	AV	3.00	0.00	53.98	11.37	PASS
BT-CH78	V	3	Hom SN6276	2795.22	36.00		31.34	5.53	-23.10	13.78	49.78	PK*	3.00	0.00	53.98	4.20	PASS
BT-CH78	V	3	Hom SN6276	3755.77	32.25	NF	34.02	6.46	-31.13	9.35	41.60	PK*	3.00	0.00	53.98	12.38	PASS
BT-CH78	V	3	Hom SN6276	4302.45	36.50		34.70	6.95	-31.08	10.57	47.07	PK*	3.00	0.00	53.98	6.91	PASS
BT-CH78	V	3	Hom SN6276	4639.08	31.40	NF	34.98	7.30	-31.05	11.22	42.62	PK*	3.00	0.00	53.98	11.36	PASS
BT-CH78	V	3	Hom SN6276	4967.46	32.30	NF	35.63	7.66	-31.03	12.27	44.57	PK*	3.00	0.00	53.98	9.41	PASS
BT-CH78	V	3	Hom SN6276	7433.43	35.80	NF	38.58	9.82	-30.83	17.57	53.37	PK	3.00	0.00	73.98	20.61	PASS
BT-CH78	V	3	Hom SN6276	7440.93	23.25	NF	38.59	9.83	-30.83	17.60	40.85	AV	3.00	0.00	53.98	13.13	PASS
BT-CH78	V	3	Hom SN6276	7616.59	37.05	NF	38.79	9.94	-30.81	17.92	54.97	PK	3.00	0.00	73.98	19.01	PASS
BT-CH78	V	3	Hom SN6276	7612.59	23.60	NF	38.79	10.00	-30.81	17.98	41.58	AV	3.00	0.00	53.98	12.40	PASS
BT-CH78	V	3	Hom SN6276	8141.37	36.15	NF	39.18	10.32	-30.77	18.73	54.88	PK	3.00	0.00	73.98	19.10	PASS
BT-CH78	V	3	Hom SN6276	8135.31	22.70	NF	39.18	10.34	-30.77	18.75	41.45	AV	3.00	0.00	53.98	12.53	PASS
BT-CH78	V	3	Hom SN6276	8375.84	36.80		39.33	10.21	-30.76	18.77	55.57	PK	3.00	0.00	73.98	18.41	PASS
BT-CH78	V	3	Hom SN6276	8375.52	25.40		39.33	10.21	-30.76	18.77	44.17	AV	3.00	0.00	53.98	9.80	PASS
BT-CH78	V	3	Hom SN6276	9323.80	35.20	NF	40.26	11.62	-30.72	21.16	56.36	PK	3.00	0.00	73.98	17.62	PASS
BT-CH78	V	3	Hom SN6276	9322.48	22.50	NF	40.26	11.64	-30.72	21.18	43.68	AV	3.00	0.00	53.98	10.30	PASS
BT-CH78	V	3	Hom SN6276	9345.26	35.25	NF	40.27	11.46	-30.72	21.01	56.26	PK	3.00	0.00	73.98	17.72	PASS
BT-CH78	V	3	Hom SN6276	9343.68	22.55	NF	40.27	11.44	-30.72	20.99	43.54	AV	3.00	0.00	53.98	10.44	PASS
BT-CH78	V	1	Hom SN6276	11188.98	35.00	NF	40.59	19.77	-30.65	29.71	64.71	PK	3.00	9.54	83.52	18.81	PASS
BT-CH78	V	1	Hom SN6276	11183.50	22.55	NF	40.59	19.78	-30.65	29.72	52.27	AV	3.00	9.54	63.52	11.25	PASS
BT-CH78	V	1	Hom SN6276	12390.04	36.05	NF	41.05	15.67	-30.60	26.11	62.16	PK	3.00	9.54	83.52	21.36	PASS
BT-CH78	V	1	Hom SN6276	12404.56	23.00	NF	41.07	15.77	-30.60	26.24	49.24	AV	3.00	9.54	63.52	14.28	PASS
BT-CH78	V	1	Hom SN6276	16156.54	41.85	NF	41.01	21.08	-31.67	30.41	72.26	PK	3.00	9.54	83.52	11.26	PASS
BT-CH78	V	1	Hom SN6276	16139.68	29.25	NF	40.96	19.92	-31.66	29.22	58.47	AV	3.00	9.54	63.52	5.06	PASS
BT-CH78	V	1	Hom SN6276	17946.60	39.07	NF	45.74	11.15	-32.62	24.26	63.33	PK	3.00	9.54	83.52	20.19	PASS
BT-CH78	V	1	Hom SN6276	17947.65	29.60	NF	45.74	11.15	-32.62	24.27	53.87	AV	3.00	9.54	63.52	9.66	PASS
BT-CH78	V	1	Hom SN6276	17791.00	39.17	NF	45.27	11.09	-32.54	23.82	62.99	PK	3.00	9.54	83.52	20.53	PASS
BT-CH78	V	1	Hom SN6276	17792.30	28.95	NF	45.28	11.09	-32.54	23.83	52.78	AV	3.00	9.54	63.52	10.75	PASS
BT-CH78	V	1	Hom SN6276	17850.30	38.81	NF	45.45	11.11	-32.57	23.99	62.80	PK	3.00	9.54	83.52	20.72	PASS
BT-CH78	V	1	Hom SN6276	17847.70	29.58	NF	45.44	11.11	-32.57	23.98	53.56	AV	3.00	9.54	63.52	9.96	PASS
BT-CH78	V	1	3160-09	19010.16	44.90	NF	40.20	21.91	-35.08	27.03	71.93	PK	3.00	9.54	83.52	11.59	PASS
BT-CH78	V	1	3160-09	19010.34	31.80	NF	40.20	21.91	-35.08	27.03	58.83	AV	3.00	9.54	63.52	4.69	PASS
BT-CH78	V	1	3160-09	21189.52	46.10	NF	40.30	22.55	-35.59	27.26	73.36	PK	3.00	9.54	83.52	10.16	PASS
BT-CH78	V	1	3160-09	21181.18	33.20	NF	40.30	22.55	-35.59	27.26	60.46	AV	3.00	9.54	63.52	3.06	PASS
BT-CH78	V	1	3160-09	22313.64	47.45	NF	40.36	22.70	-35.57	27.49	74.94	PK	3.00	9.54	83.52	8.59	PASS
BT-CH78	V	1	3160-09	22319.76	34.55	NF	40.36	22.70	-35.57	27.49	62.04	AV	3.00	9.54	63.52	1.48	PASS
BT-CH78	V	1	3160-09	22356.22	47.80	NF	40.37	22.70	-35.57	27.50	75.30	PK	3.00	9.54	83.52	8.22	PASS
BT-CH78	V	1	3160-09	22346.10	34.60	NF	40.37	22.70	-35.57	27.50	62.10	AV	3.00	9.54	63.52	1.43	PASS
BT-CH78	V	1	3160-09	23787.36	48.10	NF	40.40	22.89	-35.56	27.73	75.83	PK	3.00	9.54	83.52	7.69	PASS
BT-CH78	V	1	3160-09	23786.88	35.10	NF	40.40	22.89	-35.56	27.73	62.83	AV	3.00	9.54	63.52	0.69	PASS

Formulae:

Total CF = Antenna Factor + Cable Factor + Other Factor (Amplifier Gain, filter loss, etc)

Field Strength = SA Reading + Total CF

Limit Distance Correction = $40 \cdot \log(d1/d2)$ for $F < 30$ MHz, $20 \cdot \log(d1/d2)$ for $F > 30$ MHz:

where d1 is the measurement distance, d2 is the published limit distance

Limit = Specified Limit + Limit Distance Correction

Margin = Limit - Field Strength

*PK = QP or Average Limits where applied to the peak emission

***The frequency points reported, describe the highest emission measured in each of the ranges tested and are used to describe the measured spectrum as a whole. Emissions that may be present in the restricted bands are evaluated against the appropriate limits in Appendix I. No out-of-band emissions were measured above the levels noted.**

Company:	Itronix Corporation	Model:	IX325A860IWLBT	FCC ID:	KBCIX325A860IWLBT	IC ID:	1943A-IX325g
DUT Type:	IX325 Rugged Tablet PC with MSI MS-6837 Bluetooth & internal PIFA Antenna 3			2402 - 2480 MHz		ITRONIX <small>A GENERAL DYNAMICS COMPANY</small>	
2006 Celltech Labs Inc.	This document is not to be reproduced in whole or in part without the prior written permission of Celltech Labs Inc.						Page 60 of 62

	Test Report Serial No.:	042406KBC-T743-E15B	Report Revision No.:	Revision 1.0
	Test Date(s):	18May05 - 14Jul05	Report Issue Date:	November 07, 2006
	Test Standard(s):	FCC 47 CFR §15.247	Industry Canada RSS-210 Issue 5	
	Lab Registration(s):	FCC Lab Reg. # 714830	Industry Canada Lab File # IC 3874	

I.10. PASS/FAIL

In reference to the results outlined in I.9, the DUT passes the requirements as stated in the reference standards as follows: FCC 15.205 (a) (b) and 15.209 (a): No emissions were measured within the restricted bands as outlined in 15.205 that exceeded the limits stated in 15.209.

I.11. SIGN-OFF

I attest to the accuracy of the data. All measurements reported herein were performed by me and are correct to the best of my knowledge and belief. I assume full responsibility for the completeness of these measurements.



Russell Pipe
Senior Compliance Technologist
Celltech Labs Inc.

9Jun05

Date

Company:	Itronix Corporation	Model:	IX325A860IWLBT	FCC ID:	KBCIX325A860IWLBT	IC ID:	1943A-IX325g
DUT Type:	IX325 Rugged Tablet PC with MSI MS-6837 Bluetooth & internal PIFA Antenna 3			2402 - 2480 MHz			
2006 Celltech Labs Inc.	This document is not to be reproduced in whole or in part without the prior written permission of Celltech Labs Inc.						Page 61 of 62

	Test Report Serial No.:	042406KBC-T743-E15B	Report Revision No.:	Revision 1.0
	Test Date(s):	18May05 - 14Jul05	Report Issue Date:	November 07, 2006
	Test Standard(s):	FCC 47 CFR §15.247	Industry Canada RSS-210 Issue 5	
	Lab Registration(s):	FCC Lab Reg. # 714830	Industry Canada Lab File # IC 3874	

END OF DOCUMENT

Company:	Itronix Corporation	Model:	IX325A860IWLBT	FCC ID:	KBCIX325A860IWLBT	IC ID:	1943A-IX325g
DUT Type:	IX325 Rugged Tablet PC with MSI MS-6837 Bluetooth & internal PIFA Antenna 3			2402 - 2480 MHz			
2006 Celltech Labs Inc.	This document is not to be reproduced in whole or in part without the prior written permission of Celltech Labs Inc.						Page 62 of 62