	Test Report Serial No.:	042406KBC-T743-E24GWC	Report Issue Date:	November 03, 2006
	Date(s) of Evaluation:	April 25 - July 31, 2006	Report Revision No.:	Revision 1.0
	Test Standard(s) Applied:	FCC 47 CFR §2, §22H, §24E	Industry Canada RSS-132, RSS-133	
	Test Lab Registration(s):	FCC Lab Registration #714830	Industry Canada Lab File #3874	

ELECTROMAGNETIC COMPATIBILITY

EMC TEST REPORT

FCC 47 CFR PART 22 SUBPART H
FCC 47 CFR PART 24 SUBPART E

INDUSTRY CANADA RSS-132 ISSUE 2
INDUSTRY CANADA RSS-133 ISSUE 3

FOR

ITRONIX CORPORATION

MODEL: IX325A860IWLBT

IX325 SERIES RUGGED TABLET PC

WITH INTERNAL

DUAL-BAND GSM/GPRS/EDGE/UMTS PCMCIA MODEM

FCC ID: KBCIX325A860IWLBT

IC ID: 1943A-IX325g

Test Report Serial No.

042406KBC-T743-E24GWC

Test Report Revision No.

Revision 1.0 (Initial Release)

Test Lab and Location

Celltech Compliance Testing & Engineering Lab
(Celltech Labs Inc.)
1955 Moss Court
Kelowna, BC
Canada
V1Y 9L3

Company:	Itronix Corporation	FCC ID:	KBCIX325A860IWLBT	IC ID:	1943A-IX325g	
Model(s):	IX325A860IWLBT	IX325 Rugged Tablet PC with Dual-Band GSM/GPRS/EDGE/UMTS Modem				
2006 Celltech Labs Inc.	This document is not to be reproduced in whole or in part without the prior written permission of Celltech Labs Inc.					Page 1 of 30

	Test Report Serial No.:	042406KBC-T743-E24GWC	Report Issue Date:	November 03, 2006
	Date(s) of Evaluation:	April 25 - July 31, 2006	Report Revision No.:	Revision 1.0
	Test Standard(s) Applied:	FCC 47 CFR §2, §22H, §24E	Industry Canada RSS-132, RSS-133	
	Test Lab Registration(s):	FCC Lab Registration #714830	Industry Canada Lab File #3874	

DECLARATION OF COMPLIANCE

Test Lab and Location	CELLTECH LABS INCORPORATED Testing and Engineering Services 1955 Moss Court Kelowna, B.C. Canada V1Y 9L3				Company Information	ITRONIX CORPORATION 12825 E. Mirabeau Parkway Spokane Valley, WA 99216 United States		
Phone:	250-448-7047	Fax:	250-448-7048					
E-mail:	info@celltechlabs.com	Web site:	www.celltechlabs.com					
Lab Registration No.(s):	FCC:	714830	IC:	IC 3874				
Rule Part(s):	FCC:	§2; §22H; §24E	IC:	RSS-132 Issue 2, RSS-133 Issue 3				
Device Classification:	FCC:	PCS Licensed Transmitter (PCB)	IC:	800 MHz Cellular Telephones Employing New Technologies 2 GHz Personal Communication Services				
Device Identification:	FCC:	KBCIX325A860IWLBT	IC:	1943A-IX325g				
Device Description:	Rugged Tablet PC			Device Model(s):	IX325A860IWLBT			
Internal Transmitter Type:	Dual-Band GSM/GPRS/EDGE/UMTS PCMCIA Modem			Sierra Wireless Model: AirCard 860				
Transmit Frequency Range(s):	GSM/GPRS/EDGE	Cellular Band	824.2 - 848.8 MHz	PCS Band	1850.2 - 1909.8 MHz			
	UMTS	Cellular Band	826.4 - 846.6 MHz	PCS Band	1852.4 - 1907.5 MHz			
Receive Frequency Range(s):	GSM/GPRS/EDGE	Cellular Band	869.2 - 893.8 MHz	PCS Band	1930.2 - 1989.8 MHz			
	UMTS	Cellular Band	871.4 - 891.6 MHz	PCS Band	1932.4 - 1987.5 MHz			
Maximum RF Conducted Output Power Measured:	GPRS	Cellular Band	32.28 dBm	1.69 Watts	PCS Band	28.63 dBm	0.729 Watts	
	EDGE	Cellular Band	26.89 dBm	0.489 Watts	PCS Band	25.73 dBm	0.374 Watts	
	UMTS	Cellular Band	24.00 dBm	0.251 Watts	PCS Band	23.00 dBm	0.200 Watts	
Max. ERP/EIRP Measured:	GPRS	Cellular Band	29.00 dBm	0.794 Watts	PCS Band	30.24 dBm	1.06 Watts	
	EDGE	Cellular Band	27.21 dBm	0.526 Watts	PCS Band	30.37 dBm	1.09 Watts	
	UMTS	Cellular Band	22.18 dBm	0.165 Watts	PCS Band	23.07 dBm	0.203 Watts	
GSM Transmit Class:	Class B	can be connected to GPRS and GSM services using only one service at a time						
GSM Multislot Class:	Class 10	2 Uplink Slots	Max. Source-Based Time-Averaged Duty Cycle:		25%			
GSM Power Class:	GPRS 850:	1	GPRS 1900:	1	EDGE 850:	E2	EDGE 1900:	E2
WCDMA Power Class:	UMTS 850:	3	UMTS 1900:	3	Maximum Duty Cycle:		100%	
WCDMA Uplink Channels:	1 DPCCCH Channel			1 DPDCH Channel				
Modulation Type(s) Tested:	GPRS: GMSK		EDGE: 8-PSK		UMTS: WCDMA			
Antenna Type(s) Tested:	External Hinged Monopole		Sierra Wireless		attached to AirCard 860			
Internal Battery Type:	Lithium-ion		11.1 V, 3600 mAh		Model: T8M-E			
Power Source(s) Tested:	AC Power Adapter		75 Watt		Model: ADP-75FB B			

This wireless device has demonstrated compliance with the applicable technical standards as indicated in the measurement report and was tested in accordance with the measurement procedures specified in FCC 47 CFR Rule Parts 2, 22H, 24E; Industry Canada RSS-132 Issue 2, RSS 133 Issue 3; and ANSI TIA/EIA-603-C-2004.

I attest to the accuracy of the data. All measurements reported herein were performed by me or were under my supervision and are correct to the best of my knowledge and belief. I assume full responsibility for the completeness of these measurements and vouch for the qualifications of all persons taking them.

This test report shall not be reproduced partially, or in full, without the prior written approval of Celltech Labs Inc. The results and statements contained in this report pertain only to the device(s) evaluated.

Test Report Approved By:
Spencer Watson
EMC Lab Manager
Celltech Labs Inc.



Company:	Itronix Corporation	FCC ID:	KBCIX325A860IWLBT	IC ID:	1943A-IX325g	
Model(s):	IX325A860IWLBT	IX325 Rugged Tablet PC with Dual-Band GSM/GPRS/EDGE/UMTS Modem				
2006 Celltech Labs Inc.	This document is not to be reproduced in whole or in part without the prior written permission of Celltech Labs Inc.					Page 2 of 30

	Test Report Serial No.:	042406KBC-T743-E24GWC	Report Issue Date:	November 03, 2006
	Date(s) of Evaluation:	April 25 - July 31, 2006	Report Revision No.:	Revision 1.0
	Test Standard(s) Applied:	FCC 47 CFR §2, §22H, §24E	Industry Canada RSS-132, RSS-133	
	Test Lab Registration(s):	FCC Lab Registration #714830	Industry Canada Lab File #3874	

TABLE OF CONTENTS

1.0 SCOPE.....	5
2.0 REFERENCES	5
2.1 Normative References	5
3.0 TERMS AND DEFINITIONS	6
4.0 FACILITIES AND ACCREDITATIONS	7
5.0 GENERAL INFORMATION.....	7
5.1 Applicant Information	7
5.2 DUT Description	7
5.3 Mode(s) of Operation Tested	8
5.4 Configuration Description.....	9
6.0 PASS/FAIL CRITERIA	9
APPENDICES	10
Appendix A - Conducted RF Output Power Measurement	11
Appendix B - Effective Radiated Power / Effective Isotropic Radiated Power Measurement.....	15
Appendix C - Radiated Spurious Emissions Measurement.....	23
END OF DOCUMENT	30

FIGURES

Figure A.6-1 - Setup Drawing.....	13
Figure B.6-1 - Setup Drawing.....	16
Figure C.6-1 - Setup Drawing	24

PHOTOGRAPHS

Photograph B.7-1 - Bilog Receive Antenna with DUT Antenna - DUT "Landscape" Configuration.....	17
Photograph B.7-2 - Horn Receive Antenna with DUT Antenna - DUT "Portrait" Configuration.....	17
Photograph B.7-3 - Dipole Substitution Setup	17
Photograph B.7-4 - Horn Substitution Setup.....	17
Photograph B.7-5 - Bilog Receive Antenna with DUT Antenna - DUT "LCD Face-Up" Configuration	18
Photograph B.7-6 - DUT "LCD Face-Up" Configuration Close-up	18
Photograph B.7-7 - DUT "Landscape" Configuration Close-up	18
Photograph B.7-8 - DUT "Portrait" Configuration Close-up.....	18

	Test Report Serial No.:	042406KBC-T743-E24GWC	Report Issue Date:	November 03, 2006
	Date(s) of Evaluation:	April 25 - July 31, 2006	Report Revision No.:	Revision 1.0
	Test Standard(s) Applied:	FCC 47 CFR §2, §22H, §24E	Industry Canada RSS-132, RSS-133	
	Test Lab Registration(s):	FCC Lab Registration #714830	Industry Canada Lab File #3874	

TEST SUMMARY

Referenced Standard(s): FCC CFR Title 47 Parts 2, 22 & 24

Appendix	Test Description	Procedure Reference	Limit Reference	Test Start Date	Test End Date	Result
A	Conducted RF Output Power	FCC 97-114, §2.1046	N/A	25Apr06	25Apr06	N/A
B	Effective Radiated Power Effective Isotropic Radiated Power	ANSI/TIA/EIA-603-C	§22.913 §24.232(b)	27Jun06	27Jun06	Pass
C	Radiated Spurious Emissions	ANSI/TIA/EIA-603-C	§22.917 (a), §24.238 (a)	27Jul06	31Jul06	Pass



Referenced Standard(s): IC RSS-132 Issue 2 & RSS-133 Issue 3

A	Conducted RF Output Power	ANSI/TIA/EIA-603-C	N/A	25Apr06	25Apr06	N/A
B	Effective Radiated Power Effective Isotropic Radiated Power	ANSI/TIA/EIA-603-C	RSS-132 §4.4 RSS-133 §6.4	27Jun06	27Jun06	Pass
C	Radiated Spurious Emissions	ANSI/TIA/EIA-603-C	RSS-132 §4.5 RSS-133 §6.5	27Jul06	31Jul06	Pass

REVISION LOG

Revision	Description	Implemented By	Implementation Date
1.0	Initial Release	Jonathan Hughes	November 03, 2006

SIGNATORIES

Prepared By:		August 11, 2006
Name/Title:	Spencer Watson / EMC Manager	Date
Reviewed By:		November 03, 2006
Name/Title:	Jonathan Hughes / General Manager	Date

Company:	Itronix Corporation	FCC ID:	KBCIX325A860IWLBT	IC ID:	1943A-IX325g	
Model(s):	IX325A860IWLBT	IX325 Rugged Tablet PC with Dual-Band GSM/GPRS/EDGE/UMTS Modem				
2006 Celltech Labs Inc.		This document is not to be reproduced in whole or in part without the prior written permission of Celltech Labs Inc.				Page 4 of 30

	Test Report Serial No.:	042406KBC-T743-E24GWC	Report Issue Date:	November 03, 2006
	Date(s) of Evaluation:	April 25 - July 31, 2006	Report Revision No.:	Revision 1.0
	Test Standard(s) Applied:	FCC 47 CFR §2, §22H, §24E	Industry Canada RSS-132, RSS-133	
	Test Lab Registration(s):	FCC Lab Registration #714830	Industry Canada Lab File #3874	

1.0 SCOPE

This report outlines the measurements made and results collected during electromagnetic emissions testing of the Itronix Corporation Model: IX325A860IWLBT Rugged Tablet PC utilizing the Sierra Wireless AirCard 860 Dual-Band GSM/GPRS/EDGE/UMTS PCMCIA Modem. The Sierra Wireless AirCard 860 external hinged monopole antenna was connected to the PCMCIA Card. The measurement results were applied against the applicable EMC requirements and limits outlined in the technical rules and regulations set forth in the Federal Communication Commission Code of Federal Regulations Title 47 Parts 2, 22 Subpart H, and 24 Subpart E; and Industry Canada Radio Standards Specification RSS-132 Issue 2, and RSS-133 Issue 3.

2.0 REFERENCES

2.1 Normative References

ANSI/ISO 17025:1999	General Requirements for competence of testing and calibration laboratories
IEEE/ANSI C63.4:2003	Methods of Measurement of Radio-Noise Emissions from Low-Voltage Electrical and Electronic Equipment in the Range of 9 kHz to 40 GHz
IEEE/ANSI Std C95.1:1999	American National Standard Safety Levels with Respect to Human Exposure to Radio Frequency Electromagnetic Fields
ANSI/TIA/EIA-603-C:2004	Land Mobile FM or PM Communication Equipment Measurement and Performance Standards
CFR Title 47 Part 2:2005	Code of Federal Regulations Title 47: Telecommunication Part 2: Frequency Allocations and Radio Treaty Matters; General Rules and Regulations
CFR Title 47 Part 22:2005	Code of Federal Regulations Title 47: Telecommunication Part 22: Public Mobile Services
CFR Title 47 Part 24:2005	Code of Federal Regulations Title 47: Telecommunication Part 24: Personal Communication Services
IC Spectrum Management & Telecommunications Policy	Radio Standards Specification RSS-102 Issue 2 - Radio Frequency Exposure Compliance of Radiocommunication Apparatus (All Frequency Bands) RSS-132 Issue 2 - 800 MHz Cellular Telephones Employing New Technologies RSS-133 Issue 3 - 2 GHz Personal Communication Services RSS-212 Issue 1 (Provisional) - Test Facilities & Test Methods for Radio Equipment RSS-Gen Issue 1 - General Requirements and Information for the Certification of Radiocommunication Equipment SRSP-503 Issue 6 - Technical Requirements for Cellular Radiotelephone Systems Operating in the Bands 824 - 849 MHz and 869 - 894 MHz

Company:	Itronix Corporation	FCC ID:	KBCIX325A860IWLBT	IC ID:	1943A-IX325g	
Model(s):	IX325A860IWLBT	IX325 Rugged Tablet PC with Dual-Band GSM/GPRS/EDGE/UMTS Modem				
2006 Celltech Labs Inc.	This document is not to be reproduced in whole or in part without the prior written permission of Celltech Labs Inc.					Page 5 of 30

	Test Report Serial No.:	042406KBC-T743-E24GWC	Report Issue Date:	November 03, 2006
	Date(s) of Evaluation:	April 25 - July 31, 2006	Report Revision No.:	Revision 1.0
	Test Standard(s) Applied:	FCC 47 CFR §2, §22H, §24E	Industry Canada RSS-132, RSS-133	
	Test Lab Registration(s):	FCC Lab Registration #714830	Industry Canada Lab File #3874	

3.0 TERMS AND DEFINITIONS

AV	Average
CDMA	Code Division Multiple Access
CFR	Code of Federal Regulations
dB	decibel
dBm	dB referenced to 1 mW
dBuV	dB referenced to 1 uV
DUT	Device under Test
dBc	dB down from carrier
EBW	Emission Bandwidth
EDGE	Enhanced Data Rates for GSM Evolution
EIRP	Effective Isotropic Radiated Power
EMC	Electromagnetic Compatibility
ERP	Effective Radiated Power
FCC	Federal Communication Commission
FHSS	Frequency Hopping Spread Spectrum
GSM	Global Systems for Mobile Communication
GPRS	General Packet Radio Service
HP	Hewlett Packard
HPF	High Pass Filter
Hpol	Horizontal Polarization
Hz	Hertz
IC	Industry Canada
kHz	kilohertz
LNA	Low Noise Amplifier
m	meter
MHz	Megahertz
Mbps	megabits per second
na	not applicable
n/a	not available
PK	Peak
PPSD	Peak Power Spectral Density
QP	Quasi-peak
RBW	Resolution Bandwidth
R&S	Rohde & Schwarz
RSS	Radio Standard Specification
SA	Spectrum Analyzer
UMTS	Universal Mobile Telecommunications System
VBW	Video Bandwidth
Vpol	Vertical Polarization
WCDMA	Wide CDMA

Company:	Itronix Corporation	FCC ID:	KBCIX325A860IWLBT	IC ID:	1943A-IX325g	
Model(s):	IX325A860IWLBT	IX325 Rugged Tablet PC with Dual-Band GSM/GPRS/EDGE/UMTS Modem				
2006 Celltech Labs Inc.	This document is not to be reproduced in whole or in part without the prior written permission of Celltech Labs Inc.					Page 6 of 30

	Test Report Serial No.:	042406KBC-T743-E24GWC	Report Issue Date:	November 03, 2006
	Date(s) of Evaluation:	April 25 - July 31, 2006	Report Revision No.:	Revision 1.0
	Test Standard(s) Applied:	FCC 47 CFR §2, §22H, §24E	Industry Canada RSS-132, RSS-133	
	Test Lab Registration(s):	FCC Lab Registration #714830	Industry Canada Lab File #3874	

4.0 FACILITIES AND ACCREDITATIONS

The facilities used in collecting the test results outlined in this report are located at 1955 Moss Court, Kelowna, British Columbia, Canada, V1Y 9L3. The radiated and conducted emissions sites conform with the requirements set forth in ANSI C63.4 and are filed and listed with the FCC under Registration Number 714830 and Industry Canada under File Number IC 3874.

5.0 GENERAL INFORMATION

5.1 Applicant Information

Company Name:	Itronix Corporation
Address:	12825 E. Mirabeau Parkway Spokane Valley, WA 99216 United States

5.2 DUT Description

The DUT consisted of the IX325 Rugged Tablet PC utilizing the internal Sierra Wireless AirCard 860 Dual-Band GSM/GPRS/EDGE/UMTS PCMCIA Modem with external hinged monopole antenna on the PCMCIA Card.

Device under Test:	IX325 Rugged Tablet PC		
Model(s):	IX325A860IWLBT	Serial Number:	ZZGEG5073ZZ9784
Identifier(s):	FCC ID: KBCIX325A860IWLBT	IC:	1943A-IX325g
Internal Battery:	11.1V Lithium-ion Battery, 3.6Ah (Model: T8M-E)		
Power Source Tested:	75 Watt AC Power Adapter (Delta Electronics Inc. Model: ADP-75FB B)		

Internal Transmitter:	Dual-Band GSM/GPRS/EDGE/UMTS PCMCIA Modem		
Manufacturer/Model:	Sierra Wireless AirCard 860	Serial Number:	357806000465210
Rule Part(s) Tested:	FCC:	§2.1091; §22.913, §22.917; §24.232(b), §24.238	
	IC:	RSS-132 Issue 2, RSS-133 Issue 3	
Device Classification(s):	FCC:	PCS Licensed Transmitter (PCB)	
	IC:	800 MHz Cellular Telephones employing New Technologies (RSS-132) 2 GHz Personal Communication Services (RSS-133)	

Antenna Type:	External Hinged Monopole Antenna
Model:	Sierra Wireless AirCard 860 Antenna

Company:	Itronix Corporation	FCC ID:	KBCIX325A860IWLBT	IC ID:	1943A-IX325g	
Model(s):	IX325A860IWLBT	IX325 Rugged Tablet PC with Dual-Band GSM/GPRS/EDGE/UMTS Modem				
2006 Celltech Labs Inc.	This document is not to be reproduced in whole or in part without the prior written permission of Celltech Labs Inc.					Page 7 of 30

	Test Report Serial No.:	042406KBC-T743-E24GWC	Report Issue Date:	November 03, 2006
	Date(s) of Evaluation:	April 25 - July 31, 2006	Report Revision No.:	Revision 1.0
	Test Standard(s) Applied:	FCC 47 CFR §2, §22H, §24E	Industry Canada RSS-132, RSS-133	
	Test Lab Registration(s):	FCC Lab Registration #714830	Industry Canada Lab File #3874	

5.3 Mode(s) of Operation Tested

Of the three modes, GPRS, EDGE and UMTS, GPRS and EDGE were considered similar in modulation type, channel frequency and relative power level. G-TEM measurements were made in all three modes of operation and the worst case for GPRS and EDGE was chosen for prescan measurements.

5.3.1 Dual-Band GPRS

Customer supplied software was used to set the GPRS mode to the appropriate channel and power level for the specific measurement. Between PCS band GPRS and EDGE modes, PCS GPRS was found to have higher radiated emissions when tested in a G-TEM and therefore prescan measurements were made with the PCS GPRS band set to the low, mid and high channels. Final measurements were made of all significant emissions. Between Cell band GPRS and EDGE modes, Cell band EDGE was found to have higher radiated emissions when tested in a G-TEM and therefore prescan measurements were made with the Cell band EDGE mode set to the low, mid and high channels. The following settings were used for each channel during G-TEM testing and all other tests performed.

5.3.1.1 Cellular GPRS

Transmit Frequency Range:	824.2 - 848.8 MHz Ch. 128 (824.200 MHz), Ch. 190 (836.600 MHz) & Ch. 251 (848.800 MHz)
Power Gain Settings:	The proprietary Sierra Wireless Procomm Plus test script was utilized to set the RF output power to maximum
Modulation Type:	GMSK

5.3.1.2 PCS GPRS

Transmit Frequency Range:	1850.2 - 1909.8 MHz Ch. 512 (1850.2 MHz), Ch. 661 (1880.0) & Ch. 810 (1909.8 MHz)
Power Gain Settings:	The proprietary Sierra Wireless Procomm Plus test script was utilized to set the RF output power to maximum
Modulation Type:	GMSK

5.3.2 Dual-Band EDGE

Customer supplied software was used to set the EDGE mode to the appropriate channel and power level for the specific measurement. Between PCS band GPRS and EDGE modes, PCS GPRS was found to have higher radiated emissions when tested in a G-TEM and therefore prescan measurements were made with the PCS GPRS band set to the low, mid and high channels. Final measurements were made of all significant emissions. Between Cell band GPRS and EDGE modes, Cell band EDGE was found to have higher radiated emissions when tested in a G-TEM and therefore prescan measurements were made with the Cell band EDGE mode set to the low, mid and high channels. The following settings were used for each channel during G-TEM testing and all other tests performed.

5.3.2.1 Cellular EDGE

Transmit Frequency Range:	824.2 - 848.8 MHz Ch. 128 (824.200 MHz), Ch. 190 (836.600 MHz) & Ch. 251 (848.800 MHz)
Power Gain Settings:	The proprietary Sierra Wireless Procomm Plus test script was utilized to set the RF output power to maximum
Modulation Type:	8-PSK

Company:	Itronix Corporation	FCC ID:	KBCIX325A860IWLBT	IC ID:	1943A-IX325g	
Model(s):	IX325A860IWLBT	IX325 Rugged Tablet PC with Dual-Band GSM/GPRS/EDGE/UMTS Modem				
2006 Celltech Labs Inc.	This document is not to be reproduced in whole or in part without the prior written permission of Celltech Labs Inc.					Page 8 of 30

	Test Report Serial No.:	042406KBC-T743-E24GWC	Report Issue Date:	November 03, 2006
	Date(s) of Evaluation:	April 25 - July 31, 2006	Report Revision No.:	Revision 1.0
	Test Standard(s) Applied:	FCC 47 CFR §2, §22H, §24E	Industry Canada RSS-132, RSS-133	
	Test Lab Registration(s):	FCC Lab Registration #714830	Industry Canada Lab File #3874	

5.3.2.2 PCS EDGE

Transmit Frequency Range:	1850.2 - 1909.8 MHz Ch. 512 (1850.2 MHz), Ch. 661 (1880.0 MHz) & Ch. 810 (1909.8 MHz)
Power Gain Settings:	The proprietary Sierra Wireless Procomm Plus test script was utilized to set the RF output power to maximum
Modulation Type:	8-PSK

5.3.3 Dual-Band UMTS

The Anritsu MT8820A Radio Communications Test Set was used to set the UMTS mode to the appropriate channel and power level for the specific measurement via air-link. Prescan measurements were made with the UMTS mode set to the low, mid and high channels for each band. Final measurements were made of all significant emissions. The following settings were used for each channel.

5.3.3.1 Cellular UMTS

Transmit Frequency Range:	826.4 - 846.6 MHz Ch. 4132 (826.4 MHz), Ch. 4182 (836.4 MHz) & Ch. 4233 (846.6 MHz)
Power Gain Settings:	The maximum output power setting was established using the Anritsu 8820A Radio Communications Test Set in "All Up Bits" power control mode
Modulation Type:	WCDMA

5.3.3.2 PCS UMTS

Transmit Frequency Range:	1852.4 - 1907.5 MHz Ch. 9262 (1852.4 MHz), Ch. 9400 (1880.0 MHz) & Ch. 9538 (1907.5 MHz)
Power Gain Settings:	The maximum output power setting was established using the Anritsu 8820A Radio Communications Test Set in "All Up Bits" power control mode
Modulation Type:	WCDMA

5.4 Configuration Description

The DUT was configured, as described by the client as being representative of what would be delivered to a final customer. Because the Tablet PC orientation can be user configured (0 degrees "landscape" or -90 degrees "portrait"), prescan evaluations were made to determine the configuration that resulted in the highest emissions. This prescan evaluation indicated that tablet carrier field strengths were maximized during cellular operation with the unit placed flat with the LCD facing up and the hinged monopole antenna positioned perpendicular with the ground plane. Maximized carrier field strengths during PCS operation occurred with the antenna edge of the tablet facing up and the hinged monopole antenna positioned parallel with the ground plane. More specific details may be included in each appendix.

5.4.1 Configuration Justification

The DUT was tested in a configuration described by the client as being typical of normal use.

6.0 PASS/FAIL CRITERIA

Unless otherwise noted in the Appendices, the pass/fail criteria is the limit set forth in the reference standards. A DUT is considered to have passed the requirements, if the data collected during the described measurement procedure is no greater than the specified limits as defined. The pass/fail statements made in this report only apply to the unit tested.

Company:	Itronix Corporation	FCC ID:	KBCIX325A860IWLBT	IC ID:	1943A-IX325g	
Model(s):	IX325A860IWLBT	IX325 Rugged Tablet PC with Dual-Band GSM/GPRS/EDGE/UMTS Modem				
2006 Celltech Labs Inc.	This document is not to be reproduced in whole or in part without the prior written permission of Celltech Labs Inc.					Page 9 of 30

	Test Report Serial No.:	042406KBC-T743-E24GWC	Report Issue Date:	November 03, 2006
	Date(s) of Evaluation:	April 25 - July 31, 2006	Report Revision No.:	Revision 1.0
	Test Standard(s) Applied:	FCC 47 CFR §2, §22H, §24E	Industry Canada RSS-132, RSS-133	
	Test Lab Registration(s):	FCC Lab Registration #714830	Industry Canada Lab File #3874	

APPENDICES

Company:	Itronix Corporation	FCC ID:	KBCIX325A860IWLBT	IC ID:	1943A-IX325g	
Model(s):	IX325A860IWLBT	IX325 Rugged Tablet PC with Dual-Band GSM/GPRS/EDGE/UMTS Modem				
2006 Celltech Labs Inc.	This document is not to be reproduced in whole or in part without the prior written permission of Celltech Labs Inc.					Page 10 of 30

	Test Report Serial No.:	042406KBC-T743-E24GWC	Report Issue Date:	November 03, 2006
	Date(s) of Evaluation:	April 25 - July 31, 2006	Report Revision No.:	Revision 1.0
	Test Standard(s) Applied:	FCC 47 CFR §2, §22H, §24E	Industry Canada RSS-132, RSS-133	
	Test Lab Registration(s):	FCC Lab Registration #714830	Industry Canada Lab File #3874	

Appendix A - Conducted RF Output Power Measurement

A.1 REFERENCES

Normative Reference Standard	FCC CFR 47 §2.1046 (a)
Procedure Reference	FCC 97-114

A.2 LIMITS

A.2.1 FCC CFR 47

FCC CFR 47 §2.1046 (a) For transmitters other than single sideband, independent sideband and controlled carrier radiotelephone, power output shall be measured at the RF output terminals when the transmitter is adjusted in accordance with the tune-up procedures to give the values of current and voltage on the circuit elements specified in §2.1033(c) (8).

*ERP and EIRP limits are specified in Appendix B.

A.3 ENVIRONMENTAL CONDITIONS

Temperature	25 +/- 5 °C
Humidity	40 +/- 10 %
Barometric Pressure	101 +/- 3 kPa

A.4 EQUIPMENT LIST

ASSET NUMBER	MANUFACTURER	MODEL	DESCRIPTION	LAST CAL	CAL DUE
00110	Gigatronics	8652A	Power Meter	12Apr06	12Apr07
00011	Gigatronics	80701A	Power Sensor	03Feb06	03Feb07
00012	Gigatronics	80701A	Power Sensor	12Sept05	12Sept06
00102	Pasternack	PE7015-3010	30 dB Attenuator	n/a*	n/a*
00208	Anritsu	MT8820A	Radio Communications Test Set	06Jun06	06Jun07
00078	Pasternack	PE2214-20	Directional Coupler 1-18 GHz	n/a*	n/a*

*Verified with power meter prior to use

Company:	Itronix Corporation	FCC ID:	KBCIX325A860IWLBT	IC ID:	1943A-IX325g	
Model(s):	IX325A860IWLBT	IX325 Rugged Tablet PC with Dual-Band GSM/GPRS/EDGE/UMTS Modem				
2006 Celltech Labs Inc.		This document is not to be reproduced in whole or in part without the prior written permission of Celltech Labs Inc.				Page 11 of 30

	Test Report Serial No.:	042406KBC-T743-E24GWC	Report Issue Date:	November 03, 2006
	Date(s) of Evaluation:	April 25 - July 31, 2006	Report Revision No.:	Revision 1.0
	Test Standard(s) Applied:	FCC 47 CFR §2, §22H, §24E	Industry Canada RSS-132, RSS-133	
	Test Lab Registration(s):	FCC Lab Registration #714830	Industry Canada Lab File #3874	

A.5 MEASUREMENT EQUIPMENT SETUP

Measurement Equipment Connections	The equipment was connected as shown in the setup drawing in A.6.
Measurement Equipment Settings - GPRS and EDGE	Power Meter Settings: Mode - BAP Frequency compensation set for carrier frequency Offset set appropriately for attenuator characteristics
Measurement Procedure - GPRS and EDGE	The RF conducted output power levels for both PCS and cellular bands in both GPRS and EDGE modes were measured at the DUT antenna connector port using a Gigatronics 8652A Universal Power Meter in burst average power mode. An offset was entered into the power meter to correct for the losses of the attenuator and cable installed between the transmitter output port and the power sensor input. The proprietary Sierra Wireless Procomm Plus test script was used to set the DUT to transmit at maximum output power level as described in section 5.3 of this report. All subsequent tests were performed using the same device setup procedures.
Measurement Equipment Settings - UMTS	Power Meter Settings: Mode - MAP Frequency compensation set for carrier frequency Offset set appropriately for attenuator characteristics
Measurement Procedure - UMTS	The RF conducted output power levels for both PCS and cellular bands were measured at the DUT antenna connector port using a Gigatronics 8652A Universal Power Meter in modulated average power mode. An offset was entered into the power meter to correct for the losses of the directional coupler and cable installed between the transmitter output port and the power sensor input. The Anritsu Radio Communications Test Set was utilized to set the DUT to transmit at maximum output power level as described in section 5.3 of this report. All subsequent tests were performed using the device setup procedures.
PROCEDURES USED TO ESTABLISH TEST SIGNAL (UMTS)	<p>The following settings were used to configure the Anritsu MT8820A Communications Test Set:</p> <p>Instrument Information</p> <p>Application: WCDMA Standard: MX88200B 4.41 #003 Scenario: MX882050A Serial Number: 6200241241</p> <p>Call Parameters</p> <p>Preset: 3GPP Test Loop Mode: Mode 1 Channel Coding: Reference Measurement Channel 12.2 kbps DTCH Data Pattern: PN9 Power Control Algorithm: Algorithm 1 TPC Step size: 1dB Power Control Bit Pattern: All-Up Bits UL Channel: 9262 / 9400 / 9538 4132 / 4182 / 4233 DL Channel: 9662 / 9800 / 9938 4357 / 4407 / 4458</p>

Company:	Itronix Corporation	FCC ID:	KBCIX325A860IWLBT	IC ID:	1943A-IX325g	
Model(s):	IX325A860IWLBT	IX325 Rugged Tablet PC with Dual-Band GSM/GPRS/EDGE/UMTS Modem				
2006 Celltech Labs Inc.		This document is not to be reproduced in whole or in part without the prior written permission of Celltech Labs Inc.				Page 12 of 30

Test Report Serial No.:	042406KBC-T743-E24GWC	Report Issue Date:	November 03, 2006
Date(s) of Evaluation:	April 25 - July 31, 2006	Report Revision No.:	Revision 1.0
Test Standard(s) Applied:	FCC 47 CFR §2, §22H, §24E	Industry Canada RSS-132, RSS-133	
Test Lab Registration(s):	FCC Lab Registration #714830	Industry Canada Lab File #3874	

A.6 SETUP DRAWING

Figure A.6-1 - Setup Drawing
GPRS/EDGE Conducted Power Measurements

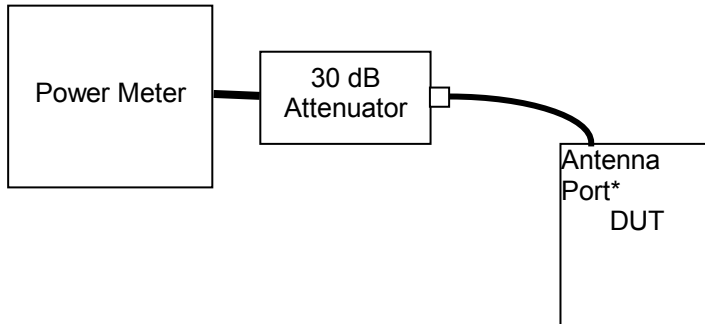

*measurement made/referenced at PCMCIA card antenna connector port

Figure A.6-2 - Setup Drawing
UMTS Conducted Power Measurements

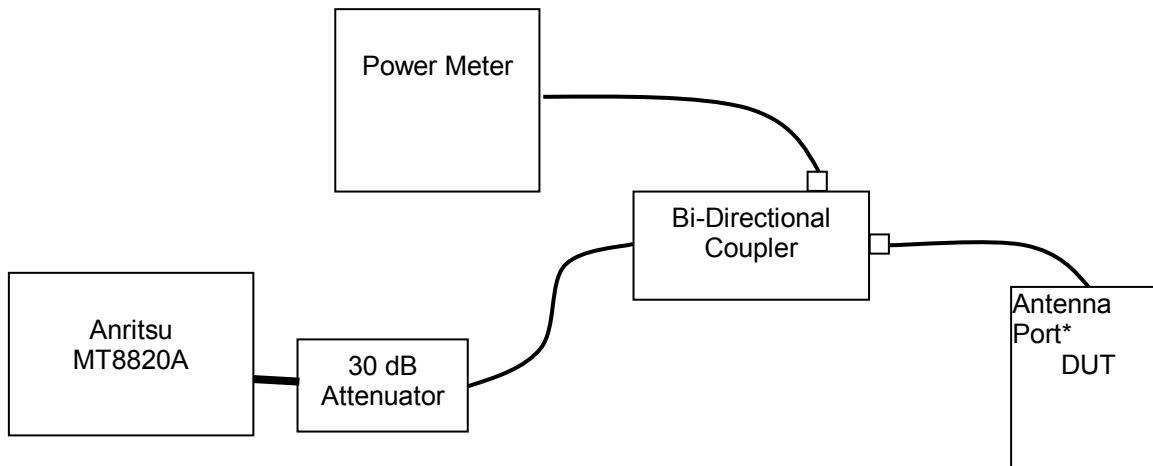

*measurement made/referenced at PCMCIA card antenna connector port

	Test Report Serial No.:	042406KBC-T743-E24GWC	Report Issue Date:	November 03, 2006
	Date(s) of Evaluation:	April 25 - July 31, 2006	Report Revision No.:	Revision 1.0
	Test Standard(s) Applied:	FCC 47 CFR §2, §22H, §24E	Industry Canada RSS-132, RSS-133	
	Test Lab Registration(s):	FCC Lab Registration #714830	Industry Canada Lab File #3874	

A.7 DUT OPERATING DESCRIPTION

Power measurements were made in the cellular and PCS bands, with the DUT set appropriately as described in section 5.3.

A.8 TEST RESULTS

Mode	Channel	Frequency	Conducted Power	
Cellular GPRS	128	824.2 MHz	+31.75 dBm	1.50 Watts
	190	836.6 MHz	+31.84 dBm	1.53 Watts
	251	848.8 MHz	+32.28 dBm	1.69 Watts
Cellular EDGE	128	824.2 MHz	+26.68 dBm	0.466 Watts
	190	836.6 MHz	+26.89 dBm	0.489 Watts
	251	848.8 MHz	+26.72 dBm	0.470 Watts
Cellular UMTS	4132	826.4 MHz	+23.80 dBm	0.240 Watts
	4182	836.4 MHz	+23.90 dBm	0.245 Watts
	4233	846.6 MHz	+24.00 dBm	0.251 Watts
PCS GPRS	512	1850.2 MHz	+28.42 dBm	0.695 Watts
	661	1880.0 MHz	+28.63 dBm	0.729 Watts
	810	1909.8 MHz	+28.54 dBm	0.714 Watts
PCS EDGE	512	1850.2 MHz	+25.53 dBm	0.357 Watts
	661	1880.0 MHz	+25.73 dBm	0.374 Watts
	810	1909.8 MHz	+25.55 dBm	0.359 Watts
PCS UMTS	9262	1852.4 MHz	+22.33 dBm	0.171 Watts
	9400	1880.0 MHz	+23.00 dBm	0.200 Watts
	9538	1907.5 MHz	+22.70 dBm	0.186 Watts

A.9 PASS/FAIL

There is no pass/fail criterion for this measurement.

A.10 SIGN-OFF

I attest to the accuracy of the data. All measurements reported herein were performed by me and are correct to the best of my knowledge and belief. I assume full responsibility for the completeness of these measurements.



Spencer Watson
EMC Lab Manager
Celltech Labs Inc.

April 25, 2006

Date

Company:	Itronix Corporation	FCC ID:	KBCIX325A860IWLBT	IC ID:	1943A-IX325g	
Model(s):	IX325A860IWLBT	IX325 Rugged Tablet PC with Dual-Band GSM/GPRS/EDGE/UMTS Modem				
2006 Celltech Labs Inc.		This document is not to be reproduced in whole or in part without the prior written permission of Celltech Labs Inc.				Page 14 of 30

	Test Report Serial No.:	042406KBC-T743-E24GWC	Report Issue Date:	November 03, 2006
	Date(s) of Evaluation:	April 25 - July 31, 2006	Report Revision No.:	Revision 1.0
	Test Standard(s) Applied:	FCC 47 CFR §2, §22H, §24E	Industry Canada RSS-132, RSS-133	
	Test Lab Registration(s):	FCC Lab Registration #714830	Industry Canada Lab File #3874	

Appendix B - Effective Radiated Power / Effective Isotropic Radiated Power Measurement

B.1 REFERENCES

Normative Reference Standard	FCC CFR 47 §22.913 (a), FCC CFR 47 §24.232 (b)
Procedure Reference	ANSI/TIA/EIA-603-C

B.2 LIMITS

B.2.1 FCC CFR 47

FCC CFR 47 §22.913 (a)	(a) <i>Maximum ERP. The ERP of mobile transmitters and auxiliary transmitters must not exceed 7 Watts.</i>
FCC CFR 47 §24.232 (b)	(b) <i>Mobile/portable stations are limited to 2 watts e.i.r.p. peak power and the equipment must employ means to limit the power to the minimum necessary for successful communications.</i>

B.3 ENVIRONMENTAL CONDITIONS

Temperature	25 +/- 5 °C
Humidity	40 +/- 10 %
Barometric Pressure	101 +/- 3 kPa

B.4 EQUIPMENT LIST

ASSET NUMBER	MANUFACTURER	MODEL	DESCRIPTION	LAST CAL	CAL DUE
00072	EMCO	2075	Mini-mast	n/a	n/a
00073	EMCO	2080	Turn Table	n/a	n/a
00071	EMCO	2090	Multi-Device Controller	n/a	n/a
00050	Chase	CBL-6111A	Bilog Antenna	04Apr06	04Apr07
00055	EMCO	3121C	Dipole Antenna	04Apr06	04Apr07
00034	ETS	3115	Double Ridged Guide Horn	11Aug05	11Aug07
00035	ETS	3115	Double Ridged Guide Horn	03Apr06	03Apr08
00161	Waveline	899	Standard Gain Horn Antenna	n/a	n/a
00051	HP	8566B	Spectrum Analyzer RF Section	04Apr06	04Apr07
00049	HP	85650A	Quasi-peak Adapter	04Apr06	04Apr07
00047	HP	85685A	RF Preselector	05Apr06	05Apr07
00048	Gore	65474	Microwave Cable	16Aug05	16Aug06
00006	R & S	SMR 20	Signal Generator (10MHz-40GHz)	06Apr06	06Apr07
00114	Amplifier Research	DC7154	Directional Coupler (0.8-4.2 GHz)	n/a	n/a
00078	Pasternack	PE2214-20	Directional Coupler (1-18 GHz)	n/a	n/a
00106	Amplifier Research	5S1G4	Power Amplifier (5W, 800MHz-4.2GHz)	n/a	n/a
00041	Amplifier Research	10W1000C	Power Amplifier (0.5 – 1 GHz)	n/a	n/a
00110	Gigatronics	8652A	Power Meter	12Apr06	12Apr07
00011	Gigatronics	80701A	Power Sensor	03Feb06	03Feb07
00208	Anritsu	MT8820A	Radio Communication Test Set	06Jun06	06Jun07

Company:	Itronix Corporation	FCC ID:	KBCIX325A860IWLBT	IC ID:	1943A-IX325g	
Model(s):	IX325A860IWLBT	IX325 Rugged Tablet PC with Dual-Band GSM/GPRS/EDGE/UMTS Modem				
2006 Celltech Labs Inc.		This document is not to be reproduced in whole or in part without the prior written permission of Celltech Labs Inc.				Page 15 of 30

	Test Report Serial No.:	042406KBC-T743-E24GWC	Report Issue Date:	November 03, 2006
	Date(s) of Evaluation:	April 25 - July 31, 2006	Report Revision No.:	Revision 1.0
	Test Standard(s) Applied:	FCC 47 CFR §2, §22H, §24E	Industry Canada RSS-132, RSS-133	
	Test Lab Registration(s):	FCC Lab Registration #714830	Industry Canada Lab File #3874	

B.5 MEASUREMENT EQUIPMENT SETUP

MEASUREMENT EQUIPMENT CONNECTIONS	For the field strength measurements, the measurement equipment was connected as shown in B.6. A number of antennas were used to cover the applicable frequency range tested. The ranges in which each antenna was used are as follows. For the final substitutions, the DUT was replaced with the appropriate antenna and fed from a CW signal source sufficient to replicate the received field strength of the emission being investigated.			
	Frequency Range	RX Antenna	TX Antenna	
	30 MHz - 1GHz	Bilog	Dipole	
	1 GHz - 18 GHz	ETS 3115 Horn	ETS 3115 Horn	
MEASUREMENT EQUIPMENT SETTINGS	For the spurious out-of-band emissions, the spectrum analyzer was set to the following settings:			
	Mode	RBW	VBW	Detector
		kHz	kHz	
	Cellular	100	300	Peak
PCS	1000	1000	Peak	

B.6 SETUP DRAWING

Figure B.6-1 - Setup Drawing

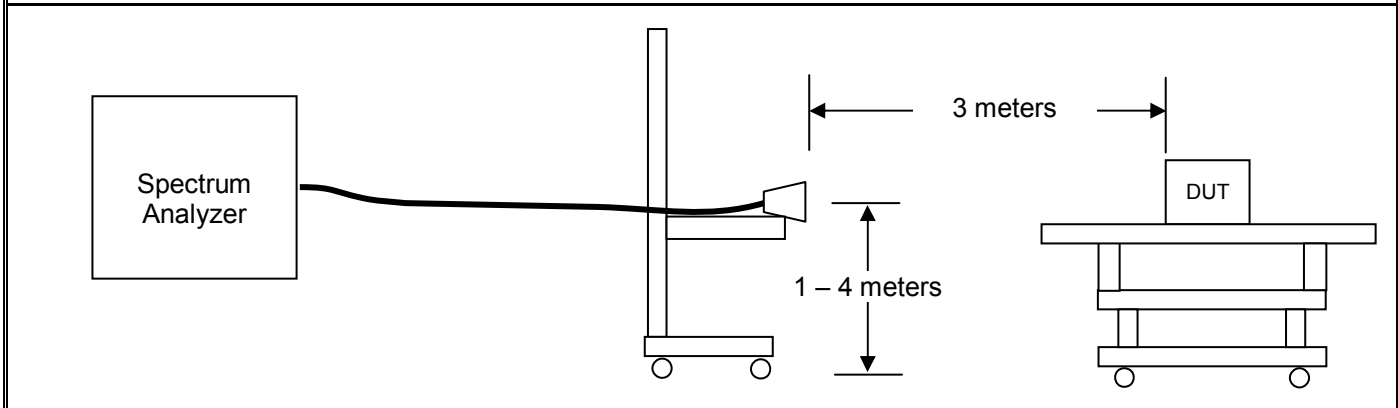

Test Report Serial No.:	042406KBC-T743-E24GWC	Report Issue Date:	November 03, 2006
Date(s) of Evaluation:	April 25 - July 31, 2006	Report Revision No.:	Revision 1.0
Test Standard(s) Applied:	FCC 47 CFR §2, §22H, §24E	Industry Canada RSS-132, RSS-133	
Test Lab Registration(s):	FCC Lab Registration #714830	Industry Canada Lab File #3874	

B.7 SETUP PHOTOGRAPHS

Photograph B.7-1 - Bilog Receive Antenna with DUT Antenna - DUT "Landscape" Configuration



Photograph B.7-2 - Horn Receive Antenna with DUT Antenna - DUT "Portrait" Configuration



Photograph B.7-3 - Dipole Substitution Setup

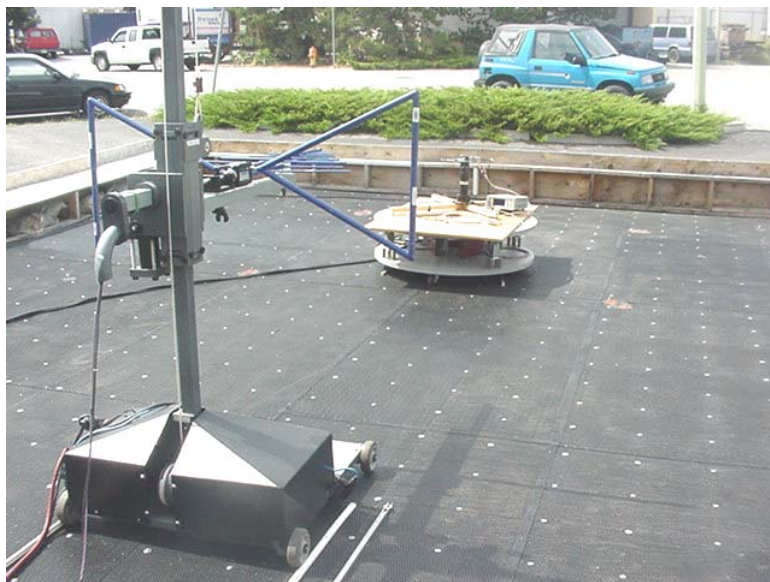

Photograph B.7-4 - Horn Substitution Setup



Test Report Serial No.:	042406KBC-T743-E24GWC	Report Issue Date:	November 03, 2006
Date(s) of Evaluation:	April 25 - July 31, 2006	Report Revision No.:	Revision 1.0
Test Standard(s) Applied:	FCC 47 CFR §2, §22H, §24E	Industry Canada RSS-132, RSS-133	
Test Lab Registration(s):	FCC Lab Registration #714830	Industry Canada Lab File #3874	

SETUP PHOTOGRAPHS (CONTINUED)

Photograph B.7-5 - Bilog Receive Antenna with DUT Antenna - DUT "LCD Face-Up" Configuration



Photograph B.7-6 - DUT "LCD Face-Up" Configuration Close-up



Photograph B.7-7 - DUT "Landscape" Configuration Close-up



Photograph B.7-8 - DUT "Portrait" Configuration Close-up



B.8 DUT OPERATING DESCRIPTION

Measurements were made for the low, mid and high channels transmitting in each of the modulation types for both the cellular and PCS bands at maximum power level as described in Appendix A.



Test Report Serial No.:	042406KBC-T743-E24GWC	Report Issue Date:	November 03, 2006
Date(s) of Evaluation:	April 25 - July 31, 2006	Report Revision No.:	Revision 1.0
Test Standard(s) Applied:	FCC 47 CFR §2, §22H, §24E	Industry Canada RSS-132, RSS-133	
Test Lab Registration(s):	FCC Lab Registration #714830	Industry Canada Lab File #3874	

B.9 TEST RESULTS

B.9.1 Carrier Levels (Attached Hinged Monopole Antenna)

B.9.1.1 Cellular GPRS Carrier Levels



Project Number: 740
Company: Itronix
Product: IX325 with AC860
Standard: FCC22.913
Test Start Date: 27-Jun-06
Test End Date: 27-Jun-06

Configuration		Polarity	Distance m	Carrier Channel	Frequency MHz	Corrected Field Strength dBuV/m	Substituted SA Signal Level (uncorrected) dBuV	Power Applied to Antenna dBm	Antenna Gain dBd	ERP Limit		Margin dB	Pass/ Fail	Measured ERP Carrier Level	
Orientation	Accessory									dBm	Watts			dBm	milliWatts
Portable GPRS Cellular Band Radiated Carrier Power Levels															
Long Edge Up	None	H	3	128	824.2000	126.52	100.00	27.33	-1.45	38.45	7.00	12.57	PASS	25.88	387.58
Long Edge Up	None	V	3	128	824.2000	123.92	97.40	23.94	-1.45	38.45	7.00	15.96	PASS	22.49	177.57
Long Edge Up	None	H	3	190	836.6000	127.16	100.30	28.86	-1.35	38.45	7.00	10.94	PASS	27.51	564.00
Long Edge Up	None	V	3	190	836.6000	124.86	98.00	25.47	-1.35	38.45	7.00	14.33	PASS	24.12	258.39
Long Edge Up	None	H	3	251	848.8000	128.32	101.20	30.25	-1.25	38.45	7.00	9.45	PASS	29.00	794.40
Long Edge Up	None	V	3	251	848.8000	126.12	99.00	27.10	-1.25	38.45	7.00	12.60	PASS	25.85	384.63

Note:

Measured ERP Carrier Level (dBm) = Power Applied to Antenna (dBm) + Antenna Gain (dBd)

The DUT was measured in 3 orientations with respect to the receive antenna, only the orientation with the highest Radiated Power results is shown here.

Note: "Long Edge Up" ("Landscape") Device Orientation

B.9.1.2 PCS GPRS Carrier Levels



Project Number: 740
Company: Itronix
Product: IX325 with AC860
Standard: FCC24.232b
Test Start Date: 27-Jun-06
Test End Date: 27-Jun-06

Configuration		Polarity	Distance m	Carrier Channel	Frequency MHz	Corrected Field Strength dBuV/m	Substituted SA Signal Level (uncorrected) dBuV	Power Applied to Antenna dBm	Antenna Gain dBi	EIRP Limit		Margin dB	Pass/ Fail	Measured EIRP Carrier Level	
Orientation	Accessory									dBm	Watts			dBm	milliWatts
Portable GPRS PCS Band Radiated Carrier Power Levels															
Long Edge Up	None	H	3	512	1850.2000	126.01	93.20	20.61	8.72	33.01	2.00	3.68	PASS	29.33	857.09
Long Edge Up	None	V	3	512	1850.2000	117.31	84.50	10.58	8.72	33.01	2.00	13.71	PASS	19.30	85.12
Long Edge Up	None	H	3	661	1880.0000	125.87	92.90	21.48	8.76	33.01	2.00	2.77	PASS	30.24	1055.84
Long Edge Up	None	V	3	661	1880.0000	118.27	85.30	12.10	8.76	33.01	2.00	12.15	PASS	20.86	121.79
Long Edge Up	None	H	3	810	1909.8000	124.34	91.20	20.24	8.79	33.01	2.00	3.98	PASS	29.03	800.16
Long Edge Up	None	V	3	810	1909.8000	119.94	86.80	14.50	8.79	33.01	2.00	9.72	PASS	23.29	213.39

Note:

Measured ERP Carrier Level (dBm) = Power Applied to Antenna (dBm) + Antenna Gain (dBd)

The DUT was measured in 3 orientations with respect to the receive antenna, only the orientation with the highest Radiated Power results is shown here.

Note: "Long Edge Up" ("Landscape") Device Orientation

Company:	Itronix Corporation	FCC ID:	KBCIX325A860IWLBT	IC ID:	1943A-IX325g	
Model(s):	IX325A860IWLBT	IX325 Rugged Tablet PC with Dual-Band GSM/GPRS/EDGE/UMTS Modem				
2006 Celltech Labs Inc.	This document is not to be reproduced in whole or in part without the prior written permission of Celltech Labs Inc.					Page 19 of 30



Test Report Serial No.:	042406KBC-T743-E24GWC	Report Issue Date:	November 03, 2006
Date(s) of Evaluation:	April 25 - July 31, 2006	Report Revision No.:	Revision 1.0
Test Standard(s) Applied:	FCC 47 CFR §2, §22H, §24E	Industry Canada RSS-132, RSS-133	
Test Lab Registration(s):	FCC Lab Registration #714830	Industry Canada Lab File #3874	

B.9.2 Carrier Levels (Attached Hinged Monopole Antenna)

B.9.2.1 Cellular EDGE Carrier Levels



Project Number: 740
Company: Itronix
Product: IX325 with AC860
Standard: FCC22.913
Test Start Date: 27-Jun-06
Test End Date: 27-Jun-06

Configuration		Polarity	Distance m	Carrier Channel	Frequency MHz	Corrected Field Strength dBuV/m	Substituted SA Signal Level (uncorrected) dBuV	Power Applied to Antenna dBm	Antenna Gain dBd	ERP Limit		Margin dB	Pass/ Fail	Measured ERP Carrier Level	
Orientation	Accessory									dBm	Watts			dBm	milliWatts
Portable EDGE Cellular Band Radiated Carrier Power Levels															
Face Up	None	H	3	128	824.2000	125.22	98.70	26.03	-1.45	38.45	7.00	13.87	PASS	24.58	287.32
Face Up	None	V	3	128	824.2000	121.42	94.90	21.44	-1.45	38.45	7.00	18.46	PASS	19.99	99.85
Face Up	None	H	3	190	836.6000	125.46	98.60	27.16	-1.35	38.45	7.00	12.64	PASS	25.81	381.31
Face Up	None	V	3	190	836.6000	122.66	95.80	23.27	-1.35	38.45	7.00	16.53	PASS	21.92	155.70
Face Up	None	H	3	251	848.8000	126.52	99.40	28.46	-1.25	38.45	7.00	11.24	PASS	27.21	526.07
Face Up	None	V	3	251	848.8000	123.12	96.00	24.10	-1.25	38.45	7.00	15.60	PASS	22.85	192.77

Note:

Measured ERP Carrier Level (dBm) = Power Applied to Antenna (dBm) + Antenna Gain (dBd)

The DUT was measured in 3 orientations with respect to the receive antenna, only the orientation with the highest Radiated Power results is shown here.

Note: "Face Up" ("LCD Display-Up") Device Orientation

B.9.2.2 PCS EDGE Carrier Levels



Project Number: 740
Company: Itronix
Product: IX325 with AC860
Standard: FCC24.232b
Test Start Date: 27-Jun-06
Test End Date: 27-Jun-06

Configuration		Polarity	Distance m	Carrier Channel	Frequency MHz	Corrected Field Strength dBuV/m	Substituted SA Signal Level (uncorrected) dBuV	Power Applied to Antenna dBm	Antenna Gain dBi	EIRP Limit		Margin dB	Pass/ Fail	Measured EIRP Carrier Level	
Orientation	Accessory									dBm	Watts			dBm	milliWatts
Portable EDGE PCS Band Radiated Carrier Power Levels															
Short Edge Up	None	H	3	512	1850.2000	126.21	93.40	20.81	8.72	33.01	2.00	3.48	PASS	29.53	897.48
Short Edge Up	None	V	3	512	1850.2000	114.11	81.30	7.38	8.72	33.01	2.00	16.91	PASS	16.10	40.74
Short Edge Up	None	H	3	661	1880.0000	125.97	93.00	21.58	8.76	33.01	2.00	2.67	PASS	30.34	1080.44
Short Edge Up	None	V	3	661	1880.0000	116.27	83.30	9.88	8.76	33.01	2.00	14.37	PASS	18.64	73.05
Short Edge Up	None	H	3	810	1909.8000	125.64	92.50	21.58	8.79	33.01	2.00	2.64	PASS	30.37	1089.37
Short Edge Up	None	V	3	810	1909.8000	116.14	83.00	10.57	8.79	33.01	2.00	13.65	PASS	19.36	86.33

Note:

Measured ERP Carrier Level (dBm) = Power Applied to Antenna (dBm) + Antenna Gain (dBd)

The DUT was measured in 3 orientations with respect to the receive antenna, only the orientation with the highest Radiated Power results is shown here.

Note: "Short Edge Up" ("Portrait") Device Orientation

Company:	Itronix Corporation	FCC ID:	KBCIX325A860IWLBT	IC ID:	1943A-IX325g	ITRONIX A GENERAL DYNAMICS COMPANY
Model(s):	IX325A860IWLBT	IX325 Rugged Tablet PC with Dual-Band GSM/GPRS/EDGE/UMTS Modem				
2006 Celltech Labs Inc.	This document is not to be reproduced in whole or in part without the prior written permission of Celltech Labs Inc.					Page 20 of 30

	Test Report Serial No.:	042406KBC-T743-E24GWC	Report Issue Date:	November 03, 2006
	Date(s) of Evaluation:	April 25 - July 31, 2006	Report Revision No.:	Revision 1.0
	Test Standard(s) Applied:	FCC 47 CFR §2, §22H, §24E	Industry Canada RSS-132, RSS-133	
	Test Lab Registration(s):	FCC Lab Registration #714830	Industry Canada Lab File #3874	

B.9.3 Carrier Levels (Attached Hinged Monopole Antenna)

B.9.3.1 Cellular UMTS Carrier Levels

		Project Number:	740	Standard:	FCC22.913
		Company:	Itronix	Test Start Date:	27-Jun-06
		Product:	IX325 with AC860	Test End Date:	27-Jun-06

Configuration		Polarity	Distance m	Carrier Channel	Frequency MHz	Corrected Field Strength dBuV/m	Substituted SA Signal Level (uncorrected) dBuV	Power Applied to Antenna dBm	Antenna Gain dBd	ERP Limit		Margin dB	Pass/ Fail	Measured ERP Carrier Level	
Orientation	Accessory									dBm	Watts			dBm	milliWatts
Portable WCDMA Cellular Band Radiated Carrier Power Levels															
Face Up	None	H	3	4132	826.4000	118.36	91.80	19.16	-1.43	38.45	7.00	20.72	PASS	17.73	59.31
Face Up	None	V	3	4132	826.4000	117.66	91.10	17.59	-1.43	38.45	7.00	22.29	PASS	16.16	41.32
Face Up	None	H	3	4182	836.4000	121.26	94.40	22.96	-1.35	38.45	7.00	16.84	PASS	21.61	144.92
Face Up	None	V	3	4182	836.4000	120.76	93.90	21.37	-1.35	38.45	7.00	18.43	PASS	20.02	100.49
Face Up	None	H	3	4233	846.6000	121.49	94.40	23.45	-1.27	38.45	7.00	16.27	PASS	22.18	165.30
Face Up	None	V	3	4233	846.6000	121.09	94.00	22.10	-1.27	38.45	7.00	17.62	PASS	20.83	121.14

Note:
Measured ERP Carrier Level (dBm) = Power Applied to Antenna (dBm) + Antenna Gain (dBd)
The DUT was measured in 3 orientations with respect to the receive antenna, only the orientation with the highest Radiated Power results is shown here.

Note: "Face Up" ("LCD Display-Up") Device Orientation

B.9.3.2 PCS UMTS Carrier Levels

		Project Number:	740	Standard:	FCC24.232b
		Company:	Itronix	Test Start Date:	27-Jun-06
		Product:	IX325 with AC860	Test End Date:	27-Jun-06

Configuration		Polarity	Distance m	Carrier Channel	Frequency MHz	Corrected Field Strength dBuV/m	Substituted SA Signal Level (uncorrected) dBuV	Power Applied to Antenna dBm	Antenna Gain dBi	EIRP Limit		Margin dB	Pass/ Fail	Measured EIRP Carrier Level	
Orientation	Accessory									dBm	Watts			dBm	milliWatts
Portable WCDMA PCS Band Radiated Carrier Power Levels															
Long Edge Up	None	H	3	9262	1852.4000	117.92	85.10	12.37	8.72	33.01	2.00	10.32	PASS	21.09	128.61
Long Edge Up	None	V	3	9262	1852.4000	120.82	88.00	14.35	8.72	33.01	2.00	7.42	PASS	23.07	202.90
Long Edge Up	None	H	3	9400	1880.0000	115.87	82.90	11.45	8.76	33.01	2.00	12.37	PASS	20.21	104.86
Long Edge Up	None	V	3	9400	1880.0000	119.57	86.60	13.66	8.76	33.01	2.00	8.67	PASS	22.42	174.42
Long Edge Up	None	H	3	9538	1907.5000	116.02	82.90	11.97	8.79	33.01	2.00	12.22	PASS	20.76	119.10
Long Edge Up	None	V	3	9538	1907.5000	119.52	86.40	14.10	8.79	33.01	2.00	8.72	PASS	22.89	194.49

Note:
Measured ERP Carrier Level (dBm) = Power Applied to Antenna (dBm) + Antenna Gain (dBd)
The DUT was measured in 3 orientations with respect to the receive antenna, only the orientation with the highest Radiated Power results is shown here.

Note: "Long Edge Up" ("Landscape") Device Orientation

Company:	Itronix Corporation	FCC ID:	KBCIX325A860IWLBT	IC ID:	1943A-IX325g	
Model(s):	IX325A860IWLBT	IX325 Rugged Tablet PC with Dual-Band GSM/GPRS/EDGE/UMTS Modem				
2006 Celltech Labs Inc.		This document is not to be reproduced in whole or in part without the prior written permission of Celltech Labs Inc.				Page 21 of 30

	Test Report Serial No.:	042406KBC-T743-E24GWC	Report Issue Date:	November 03, 2006
	Date(s) of Evaluation:	April 25 - July 31, 2006	Report Revision No.:	Revision 1.0
	Test Standard(s) Applied:	FCC 47 CFR §2, §22H, §24E	Industry Canada RSS-132, RSS-133	
	Test Lab Registration(s):	FCC Lab Registration #714830	Industry Canada Lab File #3874	

B.10 PASS/FAIL

In reference to the results outlined in B.9, the DUT passes the requirements as stated in the reference standards.

B.11 SIGN-OFF

I attest to the accuracy of the data. All measurements reported herein were performed by me and are correct to the best of my knowledge and belief. I assume full responsibility for the completeness of these measurements.



Spencer Watson
EMC Lab Manager
Celltech Labs Inc.

June 27, 2006
Date

Company:	Itronix Corporation	FCC ID:	KBCIX325A860IWLBT	IC ID:	1943A-IX325g	
Model(s):	IX325A860IWLBT	IX325 Rugged Tablet PC with Dual-Band GSM/GPRS/EDGE/UMTS Modem				
2006 Celltech Labs Inc.		This document is not to be reproduced in whole or in part without the prior written permission of Celltech Labs Inc.				Page 22 of 30

	Test Report Serial No.:	042406KBC-T743-E24GWC	Report Issue Date:	November 03, 2006
	Date(s) of Evaluation:	April 25 - July 31, 2006	Report Revision No.:	Revision 1.0
	Test Standard(s) Applied:	FCC 47 CFR §2, §22H, §24E	Industry Canada RSS-132, RSS-133	
	Test Lab Registration(s):	FCC Lab Registration #714830	Industry Canada Lab File #3874	

Appendix C - Radiated Spurious Emissions Measurement

C.1 REFERENCES

Normative Reference Standard	FCC CFR 47 §22.917(a), FCC CFR 47 §24.238(a)
Procedure Reference	ANSI/TIA/EIA-603-C

C.2 LIMITS

C.2.1 FCC CFR 47

FCC CFR 47 §22.917 & §24.238	(a) <i>Out of band emissions. The power of any emission outside of the authorized operating frequency ranges must be attenuated below the transmitting power (P) by a factor of at least 43 + 10 log(P) dB.</i>
------------------------------	---

C.3 ENVIRONMENTAL CONDITIONS

Temperature	25 +/- 5 °C
Humidity	40 +/- 10 %
Barometric Pressure	101 +/- 3 kPa

C.4 EQUIPMENT LIST

ASSET NUMBER	MANUFACTURER	MODEL	DESCRIPTION	LAST CAL	CAL DUE
00072	EMCO	2075	Mini-mast	n/a	n/a
00073	EMCO	2080	Turn Table	n/a	n/a
00071	EMCO	2090	Multi-Device Controller	n/a	n/a
00050	Chase	CBL-6111A	Bilog Antenna	04Apr06	04Apr07
00055	EMCO	3121C	Dipole Antenna	04Apr06	04Apr07
00034	ETS	3115	Double Ridged Guide Horn	11Aug05	11Aug07
00035	ETS	3115	Double Ridged Guide Horn	03Apr06	03Apr08
00161	Waveline	899	Standard Gain Horn Antenna	n/a	n/a
00051	HP	8566B	Spectrum Analyzer RF Section	04Apr06	04Apr07
00049	HP	85650A	Quasi-peak Adapter	04Apr06	04Apr07
00047	HP	85685A	RF Preselector	05Apr06	05Apr07
00048	Gore	65474	Microwave Cable	16Aug05	16Aug06
00115	Miteq	J54-00102600-35-5A	LNA	18Apr06	18Apr07
00006	R & S	SMR 20	Signal Generator (10MHz-40GHz)	06Apr06	06Apr07
00114	Amplifier Research	DC7154	Directional Coupler (0.8-4.2 GHz)	n/a	n/a
00078	Pasternack	PE2214-20	Directional Coupler (1-18 GHz)	n/a	n/a
00106	Amplifier Research	5S1G4	Power Amplifier (5W, 800MHz-4.2GHz)	n/a	n/a
00041	Amplifier Research	10W1000C	Power Amplifier (0.5 – 1 GHz)	n/a	n/a
00110	Gigatronics	8652A	Power Meter	12Apr06	12Apr07
00011	Gigatronics	80701A	Power Sensor	03Feb06	03Feb07
00208	Anritsu	MT8820A	Radio Communication Analyzer	06Jun06	06Jun07

Company:	Itronix Corporation	FCC ID:	KBCIX325A860IWLBT	IC ID:	1943A-IX325g	
Model(s):	IX325A860IWLBT	IX325 Rugged Tablet PC with Dual-Band GSM/GPRS/EDGE/UMTS Modem				
2006 Celltech Labs Inc.		This document is not to be reproduced in whole or in part without the prior written permission of Celltech Labs Inc.				Page 23 of 30

	Test Report Serial No.:	042406KBC-T743-E24GWC	Report Issue Date:	November 03, 2006
	Date(s) of Evaluation:	April 25 - July 31, 2006	Report Revision No.:	Revision 1.0
	Test Standard(s) Applied:	FCC 47 CFR §2, §22H, §24E	Industry Canada RSS-132, RSS-133	
	Test Lab Registration(s):	FCC Lab Registration #714830	Industry Canada Lab File #3874	

C.5 MEASUREMENT EQUIPMENT SETUP

MEASUREMENT EQUIPMENT CONNECTIONS	For the field strength measurements, the measurement equipment was connected as shown in C.6. A number of antennas were used to cover the applicable frequency range tested. The ranges in which each antenna was used are shown below. For the final substitutions, the DUT was replaced with the appropriate antenna and fed from a CW signal source sufficient to replicate the received field strength of the emission being investigated.			
	Frequency Range	RX Antenna	TX Antenna	
	30 MHz - 1GHz	Bilog	Dipole	
	1 GHz - 18 GHz	ETS 3115 Horn	ETS 3115 Horn	
	18 GHz - 20 GHz	Waveline 899 Horn	Waveline 899 Horn	
MEASUREMENT EQUIPMENT SETTINGS	For the spurious out-of-band emissions, the spectrum analyzer was set to the following settings:			
	Mode	RBW	VBW	Detector
		kHz	kHz	
	Cellular < 1 GHz	100	300	Peak*
	Cellular > 1 GHz	1000	1000	Peak*
	PCS	1000	1000	Peak*
*Where the peak emission exceeded the average limit, an average measurement was made using video averaging				

C.6 SETUP DRAWING

Figure C.6-1 - Setup Drawing

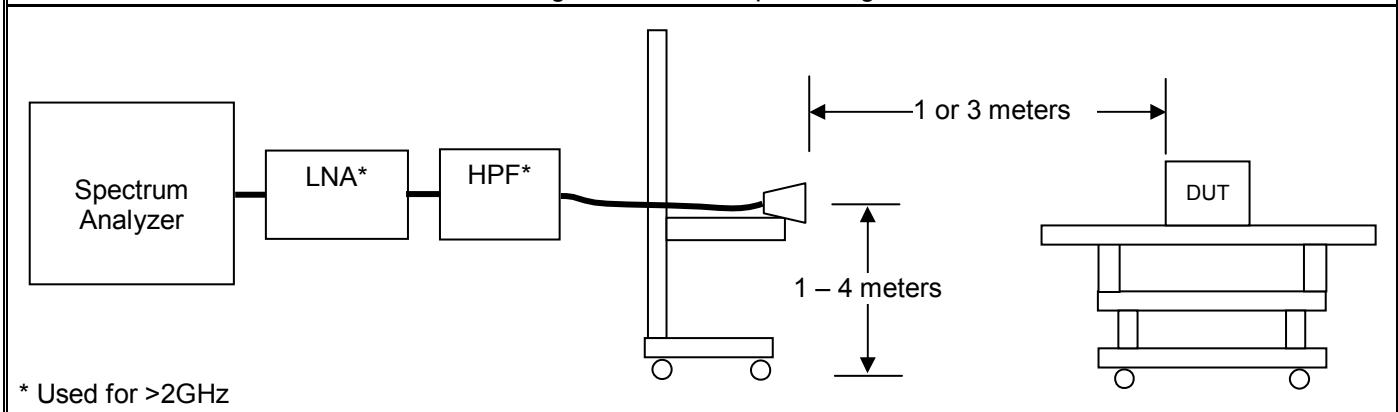

C.7 DUT OPERATING DESCRIPTION

Measurements were made for the low, mid and high channels transmitting in each of the modulation types for both the cellular and PCS bands at maximum power level as described in Appendix A.

Company:	Itronix Corporation	FCC ID:	KBCIX325A860IWLBT	IC ID:	1943A-IX325g	
Model(s):	IX325A860IWLBT	IX325 Rugged Tablet PC with Dual-Band GSM/GPRS/EDGE/UMTS Modem				
2006 Celltech Labs Inc.	This document is not to be reproduced in whole or in part without the prior written permission of Celltech Labs Inc.					Page 24 of 30



Test Report Serial No.:	042406KBC-T743-E24GWC	Report Issue Date:	November 03, 2006
Date(s) of Evaluation:	April 25 - July 31, 2006	Report Revision No.:	Revision 1.0
Test Standard(s) Applied:	FCC 47 CFR §2, §22H, §24E	Industry Canada RSS-132, RSS-133	
Test Lab Registration(s):	FCC Lab Registration #714830	Industry Canada Lab File #3874	

C.8 TEST RESULTS

The spurious measurements detailed in this section are referenced to the carrier levels set forth in Appendix B of this report:

C.8.1 Spurious Emissions (Attached Hinged Monopole Antenna)

C.8.1.1 Cellular EDGE Spurious Emissions



Project Number: 740
Company: Itronix
Product: IX325 with AC860

Standard: FCC22.917
Test Start Date: 27-Jul-06
Test End Date: 31-Jul-06

Polarity	Distance m	Substitution Antenna Type	Carrier Channel	Frequency	Corrected Field Strength	Maximized SA Signal Level (uncorrected)	Power Applied to Antenna	Antenna Gain	ERP Emission Level	Limit	Margin	Pass/Fail
				MHz	dBuV/m	dBuV	dBm	dBi	dBm	dBm or dBuV/m*	dB	
H	3	none	128	1648.26	56.01	24.40	n/a	n/a	n/a	84.4*	28.4*	PASS*
H	3	none	128	2466.47	49.06	37.00	n/a	n/a	n/a	84.4*	35.3*	PASS*
H	3	none	128	3292.24	37.86	31.00	n/a	n/a	n/a	84.4*	46.5*	PASS*
H	3	none	190	1673.87	59.25	27.50	n/a	n/a	n/a	84.4*	25.1*	PASS*
H	3	none	190	2509.80	44.70	32.50	n/a	n/a	n/a	84.4*	39.7*	PASS*
H	3	none	190	3346.40	38.26	31.20	n/a	n/a	n/a	84.4*	46.1*	PASS*
H	3	none	251	1697.43	65.12	33.20	n/a	n/a	n/a	84.4*	19.2*	PASS*
H	3	none	251	1697.43	41.41	9.49	n/a	n/a	n/a	84.4*	43.0*	PASS*
H	3	none	251	2546.40	45.71	33.30	n/a	n/a	n/a	84.4*	38.7*	PASS*
H	3	none	251	3395.20	38.52	31.30	n/a	n/a	n/a	84.4*	45.8*	PASS*
V	3	none	128	1648.51	55.51	23.90	n/a	n/a	n/a	84.4*	28.9*	PASS*
V	3	none	128	2470.13	61.87	49.80	n/a	n/a	n/a	84.4*	22.5*	PASS*
V	3	none	128	2470.13	32.37	20.30	n/a	n/a	n/a	84.4*	52.0*	PASS*
V	3	none	128	3296.80	44.60	37.70	n/a	n/a	n/a	84.4*	39.8*	PASS*
V	3	none	190	1673.93	58.85	27.10	n/a	n/a	n/a	84.4*	25.5*	PASS*
V	3	none	190	2509.80	44.70	32.50	n/a	n/a	n/a	84.4*	39.7*	PASS*
V	3	none	190	3346.40	46.66	39.60	n/a	n/a	n/a	84.4*	37.7*	PASS*
V	3	none	251	1697.60	62.92	31.00	n/a	n/a	n/a	84.4*	21.4*	PASS*
V	3	none	251	1697.60	40.82	8.90	n/a	n/a	n/a	84.4*	43.5*	PASS*
V	3	none	251	2546.23	46.71	34.30	n/a	n/a	n/a	84.4*	37.7*	PASS*
V	3	none	251	3395.20	38.62	31.40	n/a	n/a	n/a	84.4*	45.7*	PASS*

*The emissions reported above represent the highest emissions or noise floor measured within the frequency band of 30MHz and the 10th harmonic of the carrier with field strengths within 20 dB of the theoretical limit. All other emissions attributed to the EUT had field strengths greater than 20 dB below the theoretical limit and substitutions were not made.

Company:	Itronix Corporation	FCC ID:	KBCIX325A860IWLBT	IC ID:	1943A-IX325g		
Model(s):	IX325A860IWLBT	IX325 Rugged Tablet PC with Dual-Band GSM/GPRS/EDGE/UMTS Modem					
2006 Celltech Labs Inc.		This document is not to be reproduced in whole or in part without the prior written permission of Celltech Labs Inc.					Page 25 of 30



Test Report Serial No.:	042406KBC-T743-E24GWC	Report Issue Date:	November 03, 2006
Date(s) of Evaluation:	April 25 - July 31, 2006	Report Revision No.:	Revision 1.0
Test Standard(s) Applied:	FCC 47 CFR §2, §22H, §24E	Industry Canada RSS-132, RSS-133	
Test Lab Registration(s):	FCC Lab Registration #714830	Industry Canada Lab File #3874	

C.8.1.2 PCS GPRS Spurious Emissions



Project Number: 740
Company: Itronix
Product: IX325 with AC860

Standard: FCC24.238
Test Start Date: 27-Jul-06
Test End Date: 31-Jul-06

Polarity	Distance m	Substitution Antenna Type	Carrier Channel	Frequency	Corrected Field Strength	Maximized SA Signal Level (uncorrected)	Power Applied to Antenna	Antenna Gain	EIRP Emission Level	Limit	Margin	Pass/Fail
				MHz	dBuV/m	dBuV	dBm	dB	dBm	dBm or dBuV/m*	dB	
H	3	none	512	3700.33	42.51	34.00	n/a	n/a	n/a	82.2*	39.7*	PASS*
H	3	none	512	5550.60	45.09	31.00	n/a	n/a	n/a	82.2*	37.1*	PASS*
H	1	none	512	7400.80	49.80	39.28	n/a	n/a	n/a	91.8*	42.0*	PASS*
H	3	none	661	3760.33	39.69	31.10	n/a	n/a	n/a	82.2*	42.5*	PASS*
H	3	none	661	5640.00	42.75	28.60	n/a	n/a	n/a	82.2*	39.5*	PASS*
H	1	none	661	7520.00	50.10	39.20	n/a	n/a	n/a	91.8*	41.7*	PASS*
H	3	none	810	3819.66	40.63	31.70	n/a	n/a	n/a	82.2*	41.6*	PASS*
H	3	none	810	5729.46	47.01	33.00	n/a	n/a	n/a	82.2*	35.2*	PASS*
H	1	none	810	7639.20	50.90	39.89	n/a	n/a	n/a	91.8*	40.9*	PASS*
V	3	none	512	3700.40	48.31	39.80	n/a	n/a	n/a	82.2*	33.9*	PASS*
V	3	none	512	5550.60	44.89	30.80	n/a	n/a	n/a	82.2*	37.3*	PASS*
V	1	none	512	7400.40	51.65	41.13	n/a	n/a	n/a	91.8*	40.1*	PASS*
V	3	none	661	3760.00	40.19	31.60	n/a	n/a	n/a	82.2*	42.0*	PASS*
V	3	none	661	5640.00	43.25	29.10	n/a	n/a	n/a	82.2*	39.0*	PASS*
V	1	none	661	7520.50	52.65	41.75	n/a	n/a	n/a	91.8*	39.1*	PASS*
V	3	none	810	3819.22	39.52	30.60	n/a	n/a	n/a	82.2*	42.7*	PASS*
V	3	none	810	5729.40	49.51	35.50	n/a	n/a	n/a	82.2*	32.7*	PASS*
V	1	none	810	7639.20	49.84	38.83	n/a	n/a	n/a	91.8*	41.9*	PASS*

*The emissions reported above represent the highest emissions or noise floor measured within the frequency band of 30MHz and the 10th harmonic of the carrier with field strengths within 20 dB of the theoretical limit. All other emissions attributed to the EUT had field strengths greater than 20 dB below the theoretical limit and substitutions were not made.

Company:	Itronix Corporation	FCC ID:	KBCIX325A860IWLBT	IC ID:	1943A-IX325g	
Model(s):	IX325A860IWLBT	IX325 Rugged Tablet PC with Dual-Band GSM/GPRS/EDGE/UMTS Modem				
2006 Celltech Labs Inc.		This document is not to be reproduced in whole or in part without the prior written permission of Celltech Labs Inc.				Page 26 of 30



Test Report Serial No.:	042406KBC-T743-E24GWC	Report Issue Date:	November 03, 2006
Date(s) of Evaluation:	April 25 - July 31, 2006	Report Revision No.:	Revision 1.0
Test Standard(s) Applied:	FCC 47 CFR §2, §22H, §24E	Industry Canada RSS-132, RSS-133	
Test Lab Registration(s):	FCC Lab Registration #714830	Industry Canada Lab File #3874	

C.8.1.3 Cellular UMTS Spurious Emissions



Project Number: 740
Company: Itronix
Product: IX325 with AC860

Standard: FCC22.917
Test Start Date: 27-Jul-06
Test End Date: 31-Jul-06

Polarity	Distance m	Substitution Antenna Type	Carrier Channel	Frequency	Corrected Field Strength	Maximized SA Signal Level (uncorrected)	Power Applied to Antenna	Antenna Gain	ERP Emission Level	Limit	Margin	Pass/Fail
				MHz	dBuV/m	dBuV	dBm	dBi	dBm	dBm or dBuV/m*	dB	
H	3	none	4132	1652.80	48.13	16.50	n/a	n/a	n/a	84.4*	36.2*	PASS*
H	3	none	4132	2479.20	43.09	31.00	n/a	n/a	n/a	84.4*	41.3*	PASS*
H	3	none	4132	3305.60	38.71	31.80	n/a	n/a	n/a	84.4*	45.7*	PASS*
H	3	none	4182	1675.21	53.76	22.00	n/a	n/a	n/a	84.4*	30.6*	PASS*
H	3	none	4182	2509.20	44.70	32.50	n/a	n/a	n/a	84.4*	39.7*	PASS*
H	3	none	4182	3345.60	38.06	31.00	n/a	n/a	n/a	84.4*	46.3*	PASS*
H	3	none	4233	1690.88	52.57	20.70	n/a	n/a	n/a	84.4*	31.8*	PASS*
H	3	none	4233	2539.80	44.98	32.60	n/a	n/a	n/a	84.4*	39.4*	PASS*
H	3	none	4233	3386.40	38.62	31.40	n/a	n/a	n/a	84.4*	45.8*	PASS*
V	3	none	4132	1652.80	48.03	16.40	n/a	n/a	n/a	84.4*	36.3*	PASS*
V	3	none	4132	2479.20	44.49	32.40	n/a	n/a	n/a	84.4*	39.9*	PASS*
V	3	none	4132	3305.60	38.61	31.70	n/a	n/a	n/a	84.4*	45.8*	PASS*
V	3	none	4182	1675.28	52.26	20.50	n/a	n/a	n/a	84.4*	32.1*	PASS*
V	3	none	4182	2509.20	44.00	31.80	n/a	n/a	n/a	84.4*	40.4*	PASS*
V	3	none	4182	3345.60	38.26	31.20	n/a	n/a	n/a	84.4*	46.1*	PASS*
V	3	none	4233	1691.00	50.97	19.10	n/a	n/a	n/a	84.4*	33.4*	PASS*
V	3	none	4233	2539.80	45.18	32.80	n/a	n/a	n/a	84.4*	39.2*	PASS*
V	3	none	4233	3386.40	39.12	31.90	n/a	n/a	n/a	84.4*	45.3*	PASS*

*The emissions reported above represent the highest emissions or noise floor measured within the frequency band of 30MHz and the 10th harmonic of the carrier with field strengths within 20 dB of the theoretical limit. All other emissions attributed to the EUT had field strengths greater than 20 dB below the theoretical limit and substitutions were not made.

Company:	Itronix Corporation	FCC ID:	KBCIX325A860IWLBT	IC ID:	1943A-IX325g	
Model(s):	IX325A860IWLBT	IX325 Rugged Tablet PC with Dual-Band GSM/GPRS/EDGE/UMTS Modem				
2006 Celltech Labs Inc.		This document is not to be reproduced in whole or in part without the prior written permission of Celltech Labs Inc.				Page 27 of 30



Test Report Serial No.:	042406KBC-T743-E24GWC	Report Issue Date:	November 03, 2006
Date(s) of Evaluation:	April 25 - July 31, 2006	Report Revision No.:	Revision 1.0
Test Standard(s) Applied:	FCC 47 CFR §2, §22H, §24E	Industry Canada RSS-132, RSS-133	
Test Lab Registration(s):	FCC Lab Registration #714830	Industry Canada Lab File #3874	

C.8.1.4 PCS UMTS Spurious Emissions



Project Number: 740
Company: Itronix
Product: IX325 with AC860

Standard: FCC24.238
Test Start Date: 27-Jul-06
Test End Date: 31-Jul-06

Polarity	Distance	Substitution Antenna Type	Carrier Channel	Frequency	Corrected Field Strength	Maximized SA Signal Level (uncorrected)	Power Applied to Antenna	Antenna Gain	EIRP Emission Level	Limit	Margin	Pass/Fail
				MHz	dBuV/m	dBuV	dBm	dBi	dBm	dBm or dBuV/m*	dB	
H	3	none	9262	3704.80	39.19	30.70	n/a	n/a	n/a	82.2*	43.0*	PASS*
H	3	none	9262	5557.20	44.94	30.70	n/a	n/a	n/a	82.2*	37.3*	PASS*
H	1	none	9262	7409.60	50.66	40.11	n/a	n/a	n/a	91.8*	41.1*	PASS*
H	3	none	9400	3760.00	39.99	31.40	n/a	n/a	n/a	82.2*	42.2*	PASS*
H	3	none	9400	5640.00	45.35	31.20	n/a	n/a	n/a	82.2*	36.9*	PASS*
H	1	none	9400	7520.00	51.42	40.52	n/a	n/a	n/a	91.8*	40.4*	PASS*
H	3	none	9538	3816.85	41.70	32.80	n/a	n/a	n/a	82.2*	40.5*	PASS*
H	3	none	9538	5727.25	49.20	35.20	n/a	n/a	n/a	82.2*	33.0*	PASS*
H	1	none	9538	7630.00	51.16	40.16	n/a	n/a	n/a	91.8*	40.6*	PASS*
V	3	none	9262	3704.80	37.69	29.20	n/a	n/a	n/a	82.2*	44.5*	PASS*
V	3	none	9262	5557.20	44.74	30.50	n/a	n/a	n/a	82.2*	37.5*	PASS*
V	1	none	9262	7409.60	50.44	39.89	n/a	n/a	n/a	91.8*	41.3*	PASS*
V	3	none	9400	3760.00	39.69	31.10	n/a	n/a	n/a	82.2*	42.5*	PASS*
V	3	none	9400	5640.00	45.85	31.70	n/a	n/a	n/a	82.2*	36.4*	PASS*
V	1	none	9400	7520.00	51.09	40.19	n/a	n/a	n/a	91.8*	40.7*	PASS*
V	3	none	9538	3815.00	41.49	32.60	n/a	n/a	n/a	82.2*	40.7*	PASS*
V	3	none	9538	5727.31	45.90	31.90	n/a	n/a	n/a	82.2*	36.3*	PASS*
V	1	none	9538	7630.00	51.13	40.13	n/a	n/a	n/a	91.8*	40.6*	PASS*

*The emissions reported above represent the highest emissions or noise floor measured within the frequency band of 30MHz and the 10th harmonic of the carrier with field strengths within 20 dB of the theoretical limit. All other emissions attributed to the EUT had field strengths greater than 20 dB below the theoretical limit and substitutions were not made.

Company:	Itronix Corporation	FCC ID:	KBCIX325A860IWLBT	IC ID:	1943A-IX325g		
Model(s):	IX325A860IWLBT	IX325 Rugged Tablet PC with Dual-Band GSM/GPRS/EDGE/UMTS Modem					
2006 Celltech Labs Inc.		This document is not to be reproduced in whole or in part without the prior written permission of Celltech Labs Inc.					Page 28 of 30

	Test Report Serial No.:	042406KBC-T743-E24GWC	Report Issue Date:	November 03, 2006
	Date(s) of Evaluation:	April 25 - July 31, 2006	Report Revision No.:	Revision 1.0
	Test Standard(s) Applied:	FCC 47 CFR §2, §22H, §24E	Industry Canada RSS-132, RSS-133	
	Test Lab Registration(s):	FCC Lab Registration #714830	Industry Canada Lab File #3874	

C.9 PASS/FAIL

In reference to the results outlined in C.8, the DUT passes the requirements as stated in the reference standards as follows:

FCC 22.917 (a) Out of band emissions. The power of any emission outside of the authorized operating frequency ranges must be attenuated below the transmitting power (P) by a factor of at least $43 + 10 \log(P)$ dB.

FCC 24.238 (a): Out of band emissions. The power of any emission outside of the authorized operating frequency ranges must be attenuated below the transmitting power (P) by a factor of at least $43 + 10 \log(P)$ dB.

C.10 SIGN-OFF

I attest to the accuracy of the data. All measurements reported herein were performed by me and are correct to the best of my knowledge and belief. I assume full responsibility for the completeness of these measurements.



Spencer Watson
EMC Lab Manager
Celltech Labs Inc.

July 31, 2006

Date

Company:	Itronix Corporation	FCC ID:	KBCIX325A860IWLBT	IC ID:	1943A-IX325g	
Model(s):	IX325A860IWLBT	IX325 Rugged Tablet PC with Dual-Band GSM/GPRS/EDGE/UMTS Modem				
2006 Celltech Labs Inc.	This document is not to be reproduced in whole or in part without the prior written permission of Celltech Labs Inc.					Page 29 of 30

	Test Report Serial No.:	042406KBC-T743-E24GWC	Report Issue Date:	November 03, 2006
	Date(s) of Evaluation:	April 25 - July 31, 2006	Report Revision No.:	Revision 1.0
	Test Standard(s) Applied:	FCC 47 CFR §2, §22H, §24E	Industry Canada RSS-132, RSS-133	
	Test Lab Registration(s):	FCC Lab Registration #714830	Industry Canada Lab File #3874	

END OF DOCUMENT

Company:	Itronix Corporation	FCC ID:	KBCIX325A860IWLBT	IC ID:	1943A-IX325g	
Model(s):	IX325A860IWLBT	IX325 Rugged Tablet PC with Dual-Band GSM/GPRS/EDGE/UMTS Modem				
2006 Celltech Labs Inc.	This document is not to be reproduced in whole or in part without the prior written permission of Celltech Labs Inc.					Page 30 of 30