

Test Report Serial No.:	060605KBC-T643-S15W	Issue Date:	Aug. 4, 2005
Dates of Evaluation:	June 9, 23, July 15, 2005	Report Issue:	Issue 1 Rev0
Type of Evaluation:	RF Exposure	SAR	FCC 2.1093 IC RSS-102

## DECLARATION OF COMPLIANCE SAR RF EXPOSURE EVALUATION

### Test Lab

**CELLTECH LABS INC.**  
Testing and Engineering Services  
1955 Moss Court  
Kelowna, B.C.  
Canada V1Y 9L3  
Phone: 250-448-7047  
Fax: 250-448-7046  
e-mail: info@celltechlabs.com  
web site: www.celltechlabs.com

### Applicant Information

**ITRONIX CORPORATION**  
801 South Stevens Street  
Spokane, WA 99204  
United States

**FCC IDENTIFIER:** KBCIX325-IWL  
**IC IDENTIFIER:** 1943A-IX325a  
**Model(s):** IX325-IWL

**Rule Part(s):** FCC 47 CFR §2.1093; IC RSS-102 Issue 1 (Provisional)  
**Test Procedure(s):** FCC OET Bulletin 65, Supplement C (Edition 01-01)  
**FCC Device Classification:** Digital Transmission System (DTS)  
**IC Device Classification:** Low Power License-Exempt Radiocommunication Device (RSS-210 Issue 5)

**Device Description:** Rugged Tablet PC  
**Internal Transmitter(s):** Intel Pro 2200BG 802.11b/g WLAN Mini-PCI Card  
**Mode(s) of Operation:** DSSS (Direct Sequence Spread Spectrum) - 802.11b/g  
**Modulation Type(s):** OFDM with BPSK, QPSK, 16QAM, 64QAM, DBPSK, DQPSK, CCK  
**Data Rate(s):**  
802.11b: 1 / 2 / 5.5 / 11 Mbps  
802.11g: 6 / 9 / 12 / 18 / 24 / 36 / 48 / 54 Mbps  
**Tx Frequency Range(s):** 2412 - 2462 MHz (802.11b/g)  
**Max. RF Output Power Tested:** 20.5 dBm (112 mW) Peak Conducted (802.11b, 11 Mbps)  
**Power Source(s) Tested:** Internal Lithium-ion Battery 11.1 V, 3600 mAh (Model: T8M-E)  
75 W AC Power Adapter (Delta Electronics Model: ADP-75FB B)  
**Antenna Type(s) Tested:** Internal PIFA (Top Right Side of LCD Display)

**Max. SAR Level(s) Evaluated:** 0.210 W/kg (1g average) - Antenna Edge of Tablet PC

Celltech Labs Inc. declares under its sole responsibility that this wireless device was compliant with the Specific Absorption Rate (SAR) RF exposure requirements specified in FCC 47 CFR §2.1093 and Health Canada's Safety Code 6. The device was tested in accordance with the measurement standards and procedures specified in FCC OET Bulletin 65, Supplement C (Edition 01-01) and Industry Canada RSS-102 Issue 1 (Provisional) for the General Population / Uncontrolled Exposure environment. All measurements were performed in accordance with the SAR system manufacturer recommendations.

I attest to the accuracy of data. All measurements were performed by me or were made under my supervision and are correct to the best of my knowledge and belief. I assume full responsibility for the completeness of these measurements and vouch for the qualifications of all persons taking them.

This test report shall not be reproduced partially, or in full, without the prior written approval of Celltech Labs Inc. The results and statements contained in this report pertain only to the device(s) evaluated.

Tests Performed By:



**Sean Johnston**  
Compliance Technologist  
Celltech Labs Inc.

Report Reviewed By:



**Spencer Watson**  
Senior Compliance Technologist  
Celltech Labs Inc.



<b>Applicant:</b>	Itronix Corporation	<b>FCC ID:</b>	KBCIX325-IWL	<b>IC ID:</b>	1943A-IX325a	
<b>Model:</b>	IX325-IWL	<b>Type:</b>	Rugged Tablet PC with Intel Pro 2200BG 802.11b/g WLAN Mini-PCI Card			
2005 Celltech Labs Inc.		This document is not to be reproduced in whole or in part without the written permission of Celltech Labs Inc.				1 of 42

<b>TABLE OF CONTENTS</b>	
<b>1.0 INTRODUCTION</b>	<b>3</b>
<b>2.0 DESCRIPTION of DEVICE UNDER TEST (DUT)</b>	<b>3</b>
<b>3.0 SAR MEASUREMENT SYSTEM</b>	<b>4</b>
<b>4.0 MEASUREMENT SUMMARY</b>	<b>5</b>
<b>5.0 DETAILS OF SAR EVALUATION</b>	<b>6</b>
<b>6.0 EVALUATION PROCEDURES</b>	<b>6</b>
<b>7.0 SYSTEM PERFORMANCE CHECK</b>	<b>7</b>
<b>8.0 SIMULATED EQUIVALENT TISSUES</b>	<b>8</b>
<b>9.0 SAR SAFETY LIMITS</b>	<b>8</b>
<b>10.0 ROBOT SYSTEM SPECIFICATIONS</b>	<b>9</b>
<b>11.0 PROBE SPECIFICATION (ET3DV6)</b>	<b>10</b>
<b>12.0 SAM PHANTOM V4.0C</b>	<b>10</b>
<b>13.0 PLANAR PHANTOM</b>	<b>10</b>
<b>14.0 DEVICE HOLDER</b>	<b>10</b>
<b>15.0 TEST EQUIPMENT LIST</b>	<b>11</b>
<b>16.0 MEASUREMENT UNCERTAINTIES</b>	<b>12</b>
<b>MEASUREMENT UNCERTAINTIES (Cont.)</b>	<b>13</b>
<b>17.0 REFERENCES</b>	<b>14</b>
<b>APPENDIX A - SAR MEASUREMENT DATA</b>	<b>15</b>
<b>APPENDIX B - SYSTEM PERFORMANCE CHECK DATA</b>	<b>22</b>
<b>APPENDIX C - MEASURED FLUID DIELECTRIC PARAMETERS</b>	<b>29</b>
<b>APPENDIX D - SAR TEST SETUP PHOTOGRAPHS</b>	<b>34</b>
<b>APPENDIX E - SYSTEM VALIDATION</b>	<b>39</b>
<b>APPENDIX F - PROBE CALIBRATION</b>	<b>40</b>
<b>APPENDIX G - SAM PHANTOM CERTIFICATE OF CONFORMITY</b>	<b>41</b>
<b>APPENDIX H - PLANAR PHANTOM CERTIFICATE OF CONFORMITY</b>	<b>42</b>

Test Report Serial No.:	060605KBC-T643-S15W	Issue Date:	Aug. 4, 2005
Dates of Evaluation:	June 9, 23, July 15, 2005	Report Issue:	Issue 1 Rev0
Type of Evaluation:	RF Exposure	SAR	FCC 2.1093
			IC RSS-102

## 1.0 INTRODUCTION

This measurement report demonstrates that ITRONIX CORPORATION Model: IX325-IWL Rugged Tablet PC FCC ID: KBCIX325-IWL incorporating the Intel Pro 2200BG 802.11b/g WLAN Mini-PCI Card complies with the SAR (Specific Absorption Rate) RF exposure requirements specified in FCC 47 CFR §2.1093 (see reference [1]), and Health Canada's Safety Code 6 (see reference [2]) for the General Population / Uncontrolled Exposure environment. The test procedures described in FCC OET Bulletin 65, Supplement C, Edition 01-01 (see reference [3]), and IC RSS-102 Issue 1 (Provisional) (see reference [4]), were employed. A description of the product and operating configuration, detailed summary of the test results, methodology and procedures used in the evaluation, equipment used, and the various provisions of the rules are included within this test report.

## 2.0 DESCRIPTION of DEVICE UNDER TEST (DUT)

<b>FCC Rule Part(s)</b>	47 CFR §2.1093					
<b>IC Rule Part(s)</b>	RSS-102 Issue 1 (Provisional)					
<b>Test Procedure(s)</b>	FCC OET Bulletin 65, Supplement C (01-01)					
<b>FCC Device Classification</b>	Digital Transmission System (DTS)				15C	
<b>IC Device Classification</b>	Low Power License-Exempt Radiocommunication Device				RSS-210 Issue 5	
<b>Device Description</b>	Rugged Tablet PC					
<b>Internal Transmitter(s)</b>	Intel Pro 2200BG 802.11b/g WLAN Mini-PCI Card					
<b>FCC IDENTIFIER</b>	KBCIX325-IWL			<b>IC IDENTIFIER</b>	1943A-IX325a	
<b>Model(s)</b>	IX325-IWL					
<b>Serial No.(s)</b>	ZZGEG5074ZZ9799		Rugged Tablet PC		Identical Prototype	
	06036C074ADC54906006		Intel 802.11b/g		Production Unit	
<b>Mode(s) of Operation</b>	DSSS (Direct Sequence Spread Spectrum)					
<b>Modulation Type(s)</b>	OFDM with BPSK, QPSK, 16QAM, 64QAM, DBPSK, DQPSK, CCK					
<b>Data Rate(s)</b>	802.11b		1 / 2 / 5.5 / 11 Mbps			
	802.11g		6 / 9 / 12 / 18 / 24 / 36 / 48 / 54 Mbps			
<b>Tx Frequency Range(s)</b>	2412 - 2462 MHz			802.11b/g		
<b>Max. Conducted RF Output Power Level(s) Measured</b>	<b>Freq. (MHz)</b>	<b>Chan.</b>	<b>Test Mode</b>	<b>Data Rate</b>	<b>Peak Conducted</b>	
	2442	6	802.11b	1Mbps	18.6 dBm	0.072 Watts
				11Mbps	20.5 dBm	0.112 Watts
2442	6	802.11g	6 Mbps	16.7 dBm	0.047 Watts	
<b>Antenna Type(s) Tested</b>	Internal PIFA		Top Right Side of LCD Display		802.11b/g WLAN	
<b>Power Source(s) Tested</b>	Internal Lithium-ion Battery		11.1 V, 3600 mAh		Model: T8M-E	
	Delta Electronics AC Power Adapter		75 Watts AC		Model: ADP-75FB B	
<b>Additional Power Source(s) (Not Tested)</b>	External Second Lithium-ion Battery		11.1 V, 3600 mAh		Model: T8S-E	
	Note: The external second lithium-ion battery was not evaluated for SAR due to the fact that it has exactly the same power specifications as the internal battery and provides additional spacing.					
<b>DUT Configurations Evaluated</b>	Bottom Side		0.0 cm spacing		Note: SAR evaluations for the bottom side of the DUT resulted in measured area scan peak SAR levels that were below the measurable range of the DASY4 system (<0.005 W/kg). All zoom scans were subsequently evaluated and the levels were below the measurement noise floor. See Appendix A for area scan test plots.	
	Antenna Edge		0.0 cm spacing			

<b>Applicant:</b>	Itronix Corporation	<b>FCC ID:</b>	KBCIX325-IWL	<b>IC ID:</b>	1943A-IX325a	
<b>Model:</b>	IX325-IWL	<b>Type:</b>	Rugged Tablet PC with Intel Pro 2200BG 802.11b/g WLAN Mini-PCI Card			
2005 Celltech Labs Inc.		This document is not to be reproduced in whole or in part without the written permission of Celltech Labs Inc.				3 of 42

Test Report Serial No.:	060605KBC-T643-S15W	Issue Date:	Aug. 4, 2005
Dates of Evaluation:	June 9, 23, July 15, 2005	Report Issue:	Issue 1 Rev0
Type of Evaluation:	RF Exposure	SAR	FCC 2.1093
			IC RSS-102

### 3.0 SAR MEASUREMENT SYSTEM

Celltech Labs Inc. SAR measurement facility utilizes the Dosimetric Assessment System (DASY™) manufactured by Schmid & Partner Engineering AG (SPEAG™) of Zurich, Switzerland. The DASY4 measurement system is comprised of the measurement server, robot controller, computer, near-field probe, probe alignment sensor, specific anthropomorphic mannequin (SAM) phantom, and various planar phantoms for brain and/or body SAR evaluations. The robot is a six-axis industrial robot performing precise movements to position the probe to the location (points) of maximum electromagnetic field (EMF). A cell controller system contains the power supply, robot controller, teach pendant (Joystick), and remote control, is used to drive the robot motors. The Staubli robot is connected to the cell controller to allow software manipulation of the robot. A data acquisition electronic (DAE) circuit performs the signal amplification, signal multiplexing, AD-conversion, offset measurements, mechanical surface detection, collision detection, etc. is connected to the Electro-optical coupler (EOC). The EOC performs the conversion from the optical into digital electric signal of the DAE and transfers data to the DASY4 measurement server. The DAE3 utilizes a highly sensitive electrometer-grade preamplifier with auto-zeroing, a channel and gain-switching multiplexer, a fast 16-bit AD-converter and a command decoder and control logic unit. Transmission to the DASY4 measurement server is accomplished through an optical downlink for data and status information and an optical uplink for commands and clock lines. The mechanical probe-mounting device includes two different sensor systems for frontal and sidewise probe contacts. The sensor systems are also used for mechanical surface detection and probe collision detection. The robot uses its own controller with a built in VME-bus computer.



**DASY4 SAR Measurement System with planar phantom**



**DASY4 SAR Measurement System with SAM phantom**

<b>Applicant:</b>	<b>Itronix Corporation</b>	<b>FCC ID:</b>	<b>KBCIX325-IWL</b>	<b>IC ID:</b>	<b>1943A-IX325a</b>	
<b>Model:</b>	<b>IX325-IWL</b>	<b>Type:</b>	<b>Rugged Tablet PC with Intel Pro 2200BG 802.11b/g WLAN Mini-PCI Card</b>			
2005 Celltech Labs Inc.		This document is not to be reproduced in whole or in part without the written permission of Celltech Labs Inc.				4 of 42

Test Report Serial No.:	060605KBC-T643-S15W	Issue Date:	Aug. 4, 2005
Dates of Evaluation:	June 9, 23, July 15, 2005	Report Issue:	Issue 1 Rev0
Type of Evaluation:	RF Exposure	SAR	FCC 2.1093 IC RSS-102

## 4.0 MEASUREMENT SUMMARY

### BODY SAR MEASUREMENT RESULTS

#### DUT Test Position: Antenna Edge (General Purpose Hatch Cover Side)

Test Date	Freq.	Chan.	Test Mode	Data Rate (Mbps)	Power Source	Antenna Type	DUT Position to Planar Phantom	Separation Distance to Planar Phantom (cm)	Cond. Power Before Test (dBm)	Measured SAR 1g (W/kg)	SAR Drift During Test (dB)	Scaled SAR 1g (W/kg) with droop
Jun 23	2442	Mid	802.11b	1	Internal Li-ion Battery	Internal	Antenna Edge	0.0	18.6	0.200	-0.222	0.210
Jun 23	2442	Mid	802.11b	1	AC Power	Internal	Antenna Edge	0.0	18.6	0.163	-0.184	0.170
Jul 15	2442	Mid	802.11b	11	Internal Li-ion Battery	Internal	Antenna Edge	0.0	20.5	0.116	-0.0180	0.116

**ANSI / IEEE C95.1 1999 - SAFETY LIMIT**  
**BODY: 1.6 W/kg (averaged over 1 gram)**  
**Spatial Peak - Uncontrolled Exposure / General Population**

Test Date(s)	June 23, 2005	July 15, 2005	Test Date(s)	June 23	July 15	Unit		
Measured Fluid Type	2450 MHz Body			Relative Humidity	35	32	%	
Dielectric Constant $\epsilon_r$	IEEE Target	Date	Meas.	Dev.	Atmospheric Pressure	102.4	106.4	kPa
	52.7	±5%	Jun 23	50.2	-4.7%	Ambient Temperature	23.0	24.6
Conductivity $\sigma$ (mho/m)	2450 MHz Body			Fluid Temperature	23.7	23.9	°C	
	IEEE Target	Date	Meas.	Dev.	Fluid Depth	≥ 15	≥ 15	cm
	1.95	±5%	Jun 23	1.95	0.0%	$\rho$ (Kg/m <sup>3</sup> )	1000	
			Jul 15	1.92	-1.5%			

Note(s):

- The measurement results were obtained with the DUT tested in the conditions described in this report. Detailed measurement data and plots showing the maximum SAR location of the DUT are reported in Appendix A.
- If the scaled SAR levels evaluated at the mid channel were  $\geq 3$  dB below the SAR limit, SAR evaluation for the low and high channels was optional (per FCC OET Bulletin 65, Supplement C, Edition 01-01 - see reference [3]).
- 802.11g mode was not evaluated based on average output power levels at the higher data rates were below the average power levels for the lower data rates in 802.11b mode (per May 2005 TCB Council Workshop - see reference [7]).
- SAR evaluations for the bottom side of the DUT resulted in measured area scan peak SAR levels that were below the measurable range of the DASY4 system ( $<0.005$  W/kg). All zoom scans were subsequently evaluated and the levels were below the measurement noise floor. See Appendix A for area scan test plots.
- The power droops measured by the DASY4 system for the duration of the SAR evaluations were added to the measured SAR levels to report scaled SAR results as shown in the above test data table.
- The DUT battery was fully charged prior to each SAR evaluation utilizing battery power.
- The ambient and fluid temperatures were measured prior to, and during, the fluid dielectric parameter check and the SAR evaluation. The temperatures reported were consistent for all measurement periods.
- The dielectric parameters of the simulated tissue mixture were measured prior to the SAR evaluation using an ALS-PR-DIEL Dielectric Probe Kit and an HP 8753ET Network Analyzer (see Appendix C).
- The SAR evaluations were performed within 24 hours of the system performance check.

Applicant:	Itronix Corporation	FCC ID:	KBCIX325-IWL	IC ID:	1943A-IX325a	
Model:	IX325-IWL	Type:	Rugged Tablet PC with Intel Pro 2200BG 802.11b/g WLAN Mini-PCI Card			
2005 Celltech Labs Inc.		This document is not to be reproduced in whole or in part without the written permission of Celltech Labs Inc.				5 of 42

Test Report Serial No.:	060605KBC-T643-S15W	Issue Date:	Aug. 4, 2005
Dates of Evaluation:	June 9, 23, July 15, 2005	Report Issue:	Issue 1 Rev0
Type of Evaluation:	RF Exposure	SAR	FCC 2.1093 IC RSS-102

## 5.0 DETAILS OF SAR EVALUATION

The ITRONIX CORPORATION Model: IX325-IWL Rugged Tablet PC FCC ID: KBCIX325-IWL with the Intel Pro 2200BG 802.11b/g WLAN Card was compliant for localized Specific Absorption Rate (Uncontrolled Exposure) based on the test provisions and conditions described below. The detailed test setup photographs are shown in Appendix D.

### SAR Test Configuration

- The DUT was evaluated for body SAR with the antenna edge (general purpose hatch cover side) of the tablet PC placed parallel to, and touching, the outer surface of the planar phantom. The DUT was evaluated with internal lithium-ion battery and AC power supply.
- The DUT was evaluated for body SAR with the bottom side of the tablet PC placed parallel to, and touching, the outer surface of the planar phantom. The DUT was evaluated with internal lithium-ion battery and AC power supply.
- SAR evaluations for the bottom side of the DUT resulted in measured area scan peak SAR levels that were below the measurable range of the DASY4 system (<0.005 W/kg). All zoom scans were subsequently evaluated and the levels were below the measurement noise floor. See Appendix A for area scan test plots.
- The ambient and fluid temperatures were measured prior to, and during, the fluid dielectric parameter check and the SAR evaluation. The temperatures reported were consistent for all measurement periods.
- The dielectric parameters of the simulated tissue mixture were measured prior to the SAR evaluation using an ALS-PR-DIEL Dielectric Probe Kit and an HP 8753ET Network Analyzer (see Appendix C for printout of measured fluid dielectric parameters).
- The SAR evaluations were performed within 24 hours of the daily system performance check.

### Test Modes & Power Settings

- The peak conducted power levels were measured prior to the SAR evaluations using a Gigatronics 8652A Universal Power Meter according to the procedures described in FCC 47 CFR §2.1046.
- The power droops measured by the DASY4 system for the duration of the SAR evaluations were added to the measured SAR levels to report scaled SAR results as shown in the test data table (page 5).
- The DUT was controlled in test mode via internal software. SAR measurements were performed with the DUT transmitting continuously at maximum power with a modulated DSSS signal.
- The DUT battery was fully charged prior to each SAR evaluation utilizing battery power.

## 6.0 EVALUATION PROCEDURES

- (i) The evaluation was performed in the applicable area of the phantom depending on the type of device being tested. For devices held to the ear during normal operation, both the left and right ear positions were evaluated using the SAM phantom.  
(ii) For body-worn and face-held devices a planar phantom was used.
- The SAR was determined by a pre-defined procedure within the DASY4 software. Upon completion of a reference and optical surface check, the exposed region of the phantom was scanned near the inner surface with a grid spacing of 15mm x 15mm.

An area scan was determined as follows:

- Based on the defined area scan grid, a more detailed grid is created to increase the points by a factor of 10. The interpolation function then evaluates all field values between corresponding measurement points.
- A linear search is applied to find all the candidate maxima. Subsequently, all maxima are removed that are >2 dB from the global maximum. The remaining maxima are then used to position the cube scans.

A 1g and 10g spatial peak SAR was determined as follows:

- Extrapolation is used to find the points between the dipole center of the probe and the surface of the phantom. This data cannot be measured, since the center of the dipoles is 2.7 mm away from the tip of the probe and the distance between the surface and the lowest measuring point is 1.4 mm (see probe calibration document in Appendix F). The extrapolation was based on trivariate quadratics computed from the previously calculated 3D interpolated points nearest the phantom surface.
- Interpolated data is used to calculate the average SAR over 1g and 10g cubes by spatially discretizing the entire measured cube. The volume used to determine the averaged SAR is a 1mm grid (42875 interpolated points).
- A zoom scan volume of 32 mm x 32 mm x 30 mm (5 x 5 x 7 points) centered at the peak SAR location determined from the area scan is used for all zoom scans for devices with a transmit frequency < 800 MHz. Zoom scans for frequencies ≥ 800 MHz are determined with a scan volume of 30 mm x 30 mm x 30 mm (7 x 7 x 7) to ensure complete capture of the peak spatial-average SAR.

<b>Applicant:</b>	<b>Itronix Corporation</b>	<b>FCC ID:</b>	<b>KBCIX325-IWL</b>	<b>IC ID:</b>	<b>1943A-IX325a</b>	
<b>Model:</b>	<b>IX325-IWL</b>	<b>Type:</b>	<b>Rugged Tablet PC with Intel Pro 2200BG 802.11b/g WLAN Mini-PCI Card</b>			
2005 Celltech Labs Inc.		This document is not to be reproduced in whole or in part without the written permission of Celltech Labs Inc.				6 of 42

## 7.0 SYSTEM PERFORMANCE CHECK

Prior to the SAR evaluations a system check was performed with a 2450MHz dipole (see Appendix E for system validation procedures). System checks evaluated in brain simulant were performed at the planar section of the SAM phantom. System checks evaluated in body simulant were performed in the Barski planar phantom. The dielectric parameters of the simulated tissue mixture were measured prior to the system performance check using an ALS-PR-DIEL Dielectric Probe Kit and an HP 8753ET Network Analyzer (see Appendix C for printout of measured fluid dielectric parameters). A forward power of 250 mW was applied to the dipole and the system was verified to a tolerance of  $\pm 10\%$  (see Appendix B for system performance check test plots). See Table 1 below for the SAR system manufacturer's reference body SAR values from the DASY4 Operation Manual, April 2005 (see reference [6]).

### SYSTEM PERFORMANCE CHECK EVALUATION

Test Date	2450MHz Equiv. Tissue	SAR 1g (W/kg)			Dielectric Constant $\epsilon_r$			Conductivity $\sigma$ (mho/m)			$\rho$ (Kg/m <sup>3</sup> )	Amb. Temp. (°C)	Fluid Temp. (°C)	Fluid Depth (cm)	Humid. (%)	Barom. Press. (kPa)
		IEEE Target	Meas.	Dev.	IEEE Target	Meas.	Dev.	IEEE Target	Meas.	Dev.						
6/9/05	Brain	13.1 $\pm 10\%$	13.9	+6.1%	39.2 $\pm 5\%$	37.4	-4.6%	1.80 $\pm 5\%$	1.87	+3.9%	1000	22.0	24.8	$\geq 15$	38	101.7
6/23/05	Body	12.8 $\pm 10\%$	12.8	0.0%	52.7 $\pm 5\%$	50.2	-4.7%	1.95 $\pm 5\%$	1.95	0.0%	1000	23.0	23.7	$\geq 15$	35	102.4
7/15/05	Body	12.8 $\pm 10\%$	12.9	+0.8%	52.7 $\pm 5\%$	50.7	-3.8%	1.95 $\pm 5\%$	1.92	-1.5%	1000	24.6	23.9	$\geq 15$	32	106.4

Note(s):

1. The ambient and fluid temperatures were measured prior to, and during, the fluid dielectric parameter check and the system performance check. The temperatures listed in the table above were consistent for all measurement periods.

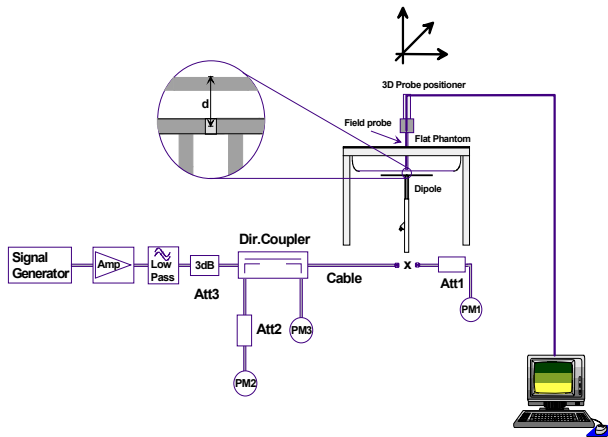

Figure 1. System Performance Check Setup Diagram

Dipole Type	Distance [mm]	Frequency [MHz]	SAR (1g) [W/kg]	SAR (10g) [W/kg]	SAR (peak) [W/kg]
D300V2	15	300	3.02	2.06	4.36
D450V2	15	450	5.01	3.36	7.22
D835V2	15	835	9.71	6.38	14.1
D900V2	15	900	11.1	7.17	16.3
D1450V2	10	1450	29.6	16.6	49.8
D1500V2	10	1500	30.8	17.1	52.1
D1640V2	10	1640	34.4	18.7	59.4
D1800V2	10	1800	38.5	20.3	67.5
D1900V2	10	1900	39.8	20.8	69.6
D2000V2	10	2000	40.9	21.2	71.5
D2450V2	10	2450	51.2	23.7	97.6
D3000V2	10	3000	61.9	24.8	136.7

Table 32.1: Numerical reference SAR values for SPEAG dipoles and flat phantom filled with body-tissue simulating liquid. Note: All SAR values normalized to 1 W forward power.

Table 1. SAR system manufacturer's reference body SAR values



2450MHz Dipole Setup (SAM Phantom)



2450MHz Dipole Setup (Planar Phantom)

## 8.0 SIMULATED EQUIVALENT TISSUES

The 2450MHz simulated tissue mixtures consist of Glycol-monobutyl, water, and salt (body mixture only). The fluids were prepared according to standardized procedures and measured for dielectric parameters (permittivity and conductivity).

SIMULATED TISSUE MIXTURES		
INGREDIENT	2450 MHz Brain	2450 MHz Body
	System Performance Check	System Performance Check
		DUT Evaluation
Water	52.00 %	69.98 %
Glycol Monobutyl	48.00 %	30.00 %
Salt	-	0.02 %

## 9.0 SAR SAFETY LIMITS

EXPOSURE LIMITS	SAR (W/kg)	
	(General Population / Uncontrolled Exposure Environment)	(Occupational / Controlled Exposure Environment)
Spatial Average (averaged over the whole body)	0.08	0.4
Spatial Peak (averaged over any 1 g of tissue)	1.60	8.0
Spatial Peak (hands/wrists/feet/ankles averaged over 10 g)	4.0	20.0

Notes:

1. Uncontrolled environments are defined as locations where there is potential exposure of individuals who have no knowledge or control of their potential exposure.
2. Controlled environments are defined as locations where there is potential exposure of individuals who have knowledge of their potential exposure and can exercise control over their exposure.



Test Report Serial No.:	060605KBC-T643-S15W	Issue Date:	Aug. 4, 2005
Dates of Evaluation:	June 9, 23, July 15, 2005	Report Issue:	Issue 1 Rev0
Type of Evaluation:	RF Exposure	SAR	FCC 2.1093
			IC RSS-102

## 10.0 ROBOT SYSTEM SPECIFICATIONS

### Specifications

**POSITIONER:** Stäubli Unimation Corp. Robot Model: RX60L  
**Repeatability:** 0.02 mm  
**No. of axis:** 6

### Data Acquisition Electronic (DAE) System

#### Cell Controller

**Processor:** AMD Athlon XP 2400+  
**Clock Speed:** 2.0 GHz  
**Operating System:** Windows XP Professional

#### Data Converter

**Features:** Signal Amplifier, multiplexer, A/D converter, and control logic  
**Software:** DASY4 software  
**Connecting Lines:** Optical downlink for data and status info.  
 Optical uplink for commands and clock

### DASY4 Measurement Server

**Function:** Real-time data evaluation for field measurements and surface detection  
**Hardware:** PC/104 166MHz Pentium CPU; 32 MB chipdisk; 64 MB RAM  
**Connections:** COM1, COM2, DAE, Robot, Ethernet, Service Interface

### E-Field Probe

**Model:** ET3DV6  
**Serial No.(s):** 1590, 1387  
**Construction:** Triangular core fiber optic detection system  
**Frequency:** 10 MHz to 6 GHz  
**Linearity:** ±0.2 dB (30 MHz to 3 GHz)

### Phantom(s)

**Type:** Planar Phantom  
**Shell Material:** Fiberglass  
**Thickness:** 2.0 ±0.1 mm  
**Volume:** Approx. 72 liters

**Type:** SAM V4.0C  
**Shell Material:** Fiberglass  
**Thickness:** 2.0 ±0.1 mm  
**Volume:** Approx. 25 liters

Test Report Serial No.:	060605KBC-T643-S15W	Issue Date:	Aug. 4, 2005
Dates of Evaluation:	June 9, 23, July 15, 2005	Report Issue:	Issue 1 Rev0
Type of Evaluation:	RF Exposure	SAR	FCC 2.1093 IC RSS-102

## 11.0 PROBE SPECIFICATION (ET3DV6)

Construction:	Symmetrical design with triangular core Built-in shielding against static charges PEEK enclosure material (resistant to organic solvents, e.g. glycol)
Calibration:	In air from 10 MHz to 2.5 GHz In brain simulating tissue at frequencies of 900 MHz and 1.8 GHz (accuracy $\pm 8\%$ )
Frequency:	10 MHz to >6 GHz; Linearity: $\pm 0.2$ dB (30 MHz to 3 GHz)
Directivity:	$\pm 0.2$ dB in brain tissue (rotation around probe axis) $\pm 0.4$ dB in brain tissue (rotation normal to probe axis)
Dynamic Range:	5 $\mu$ W/g to >100 mW/g; Linearity: $\pm 0.2$ dB
Surface Detection:	$\pm 0.2$ mm repeatability in air and clear liquids over diffuse reflecting surfaces
Dimensions:	Overall length: 330 mm Tip length: 16 mm Body diameter: 12 mm Tip diameter: 6.8 mm Distance from probe tip to dipole centers: 2.7 mm
Application:	General dosimetry up to 3 GHz Compliance tests of portable devices



ET3DV6 E-Field Probe

## 12.0 SAM PHANTOM V4.0C

The SAM phantom V4.0C is a fiberglass shell phantom with a 2.0 mm (+/-0.2 mm) shell thickness for left and right head and flat planar area integrated in a wooden table. The shape of the fiberglass shell corresponds to the phantom defined by SCC34-SC2. The device holder positions are adjusted to the standard measurement positions in the three sections (see Appendix F for specifications of the SAM phantom V4.0C).

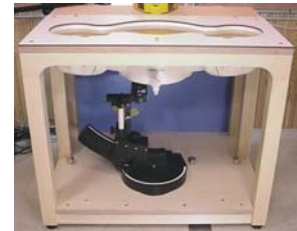

SAM Phantom

## 13.0 PLANAR PHANTOM

The planar phantom is a fiberglass shell phantom with a 2.0 mm (+/-0.2mm) thick device measurement area at the center of the phantom for SAR evaluations of devices with a larger surface area than the planar section of the SAM phantom. The planar phantom is integrated in a wooden table (see Appendix G for dimensions and specifications of the planar phantom).



Planar Phantom

## 14.0 DEVICE HOLDER

The DASY4 device holder has two scales for device rotation (with respect to the body axis) and the device inclination (with respect to the line between the ear openings). The plane between the ear openings and the mouth tip has a rotation angle of 65°. The bottom plate contains three pair of bolts for locking the device holder. The device holder positions are adjusted to the standard measurement positions in the three sections. For evaluations of larger devices such as Laptop and Tablet PCs, a Plexiglas platform is attached to the device holder.



Device Holder

Applicant:	Itronix Corporation	FCC ID:	KBCIX325-IWL	IC ID:	1943A-IX325a	
Model:	IX325-IWL	Type:	Rugged Tablet PC with Intel Pro 2200BG 802.11b/g WLAN Mini-PCI Card			
2005 Celltech Labs Inc.		This document is not to be reproduced in whole or in part without the written permission of Celltech Labs Inc.				10 of 42

Test Report Serial No.:	060605KBC-T643-S15W	Issue Date:	Aug. 4, 2005
Dates of Evaluation:	June 9, 23, July 15, 2005	Report Issue:	Issue 1 Rev0
Type of Evaluation:	RF Exposure	SAR	FCC 2.1093
			IC RSS-102

## 15.0 TEST EQUIPMENT LIST

USED	TEST EQUIPMENT	ASSET NO.	SERIAL NO.	DATE CALIBRATED		CALIBRATION DUE DATE	
	DESCRIPTION						
x	Schmid & Partner DASY4 System	-	-	-	-	-	
x	-DASY4 Measurement Server	00158	1078	N/A	N/A	N/A	
x	-Robot	00046	599396-01	N/A	N/A	N/A	
	-DAE3	00019	353	06Jul04	06Jul05		
	-DAE4			15Jun05	15Jun06		
x	-DAE3	00018	370	25Jan05	25Jan06		
x	-ET3DV6 E-Field Probe	00016	1387	18Mar05	18Mar06		
x	-ET3DV6 E-Field Probe	00017	1590	20May05	20May06		
	-EX3DV4 E-Field Probe	00125	3547	21Jan05	21Jan06		
	-300MHz Validation Dipole	00023	135	26Oct04	26Oct05		
	-450MHz Validation Dipole	00024	136	04Nov04	04Nov05		
	-835MHz Validation Dipole	00022	411	Brain	30Mar05	30Mar06	
				Body	12Apr05	12Apr06	
	-900MHz Validation Dipole	00020	054	Brain	10Jun04	10Jun05	
				Brain	10Jun05	10Jun06	
				Body	10Jun05	10Jun06	
				Body	10Jun05	10Jun06	
	-1800MHz Validation Dipole	00021	247	Brain	08Jun04	08Jun05	
				Brain	14Jun05	14Jun06	
				Body	14Jun05	14Jun06	
				Body	14Jun05	14Jun06	
	-1900MHz Validation Dipole	00032	151	Brain	18Jun04	18Jun05	
				Brain	17Jun05	17Jun06	
				Body	22Apr05	22Apr06	
				Body	22Apr05	22Apr06	
x	-2450MHz Validation Dipole	00025	150	Brain	30Sep04	30Sep05	
x				Body	22Apr05	22Apr06	
	-5000MHz Validation Dipole	00126	1031	Brain	11Jan05	11Jan06	
				Body	11Jan05	11Jan06	
x	-SAM Phantom V4.0C	00154	1033	N/A	N/A	N/A	
x	-Barski Planar Phantom	00155	03-01	N/A	N/A	N/A	
	-Plexiglas Planar Phantom	00156	161	N/A	N/A	N/A	
	-Validation Planar Phantom	00157	137	N/A	N/A	N/A	
	HP 85070C Dielectric Probe Kit	00033	N/A	N/A	N/A	N/A	
x	ALS-PR-DIEL Dielectric Probe Kit	00160	260-00953	N/A	N/A	N/A	
x	Gigatronics 8652A Power Meter	00110	1835801	16Apr05	16Apr06		
	Gigatronics 8652A Power Meter	00008	1835267	29Apr05	29Apr06		
	Gigatronics 8652A Power Meter	00007	1835272	18Oct04	18Oct05		
x	Gigatronics 80701A Power Sensor	00013	1833713	11Oct04	11Oct05		
x	Gigatronics 80701A Power Sensor	00011	1833542	08Oct04	08Oct05		
x	Gigatronics 80701A Power Sensor	00109	1834366	16Apr05	16Apr06		
x	HP 8753ET Network Analyzer	00134	US39170292	04May05	04May06		
x	HP 8648D Signal Generator	00005	3847A00611	29Apr05	29Apr06		
	Rohde & Schwarz SMR40 Signal Generator	00006	100104	12Apr05	12Apr06		
x	Amplifier Research 5S1G4 Power Amplifier	00106	26235	N/A	N/A	N/A	

Applicant:	Itronix Corporation	FCC ID:	KBCIX325-IWL	IC ID:	1943A-IX325a	
Model:	IX325-IWL	Type:	Rugged Tablet PC with Intel Pro 2200BG 802.11b/g WLAN Mini-PCI Card			
2005 Celltech Labs Inc.		This document is not to be reproduced in whole or in part without the written permission of Celltech Labs Inc.				11 of 42

## 16.0 MEASUREMENT UNCERTAINTIES

UNCERTAINTY BUDGET FOR DEVICE EVALUATION						
Error Description	Uncertainty Value ±%	Probability Distribution	Divisor	ci 1g	Uncertainty Value ±% (1g)	V <sub>i</sub> or V <sub>eff</sub>
<b>Measurement System</b>						
Probe calibration	5.9	Normal	1	1	5.9	∞
Axial isotropy of the probe	4.7	Rectangular	1.732050808	0.7	1.9	∞
Spherical isotropy of the probe	9.6	Rectangular	1.732050808	0.7	3.9	∞
Spatial resolution	0	Rectangular	1.732050808	1	0.0	∞
Boundary effects	1	Rectangular	1.732050808	1	0.6	∞
Probe linearity	4.7	Rectangular	1.732050808	1	2.7	∞
Detection limit	1	Rectangular	1.732050808	1	0.6	∞
Readout electronics	0.3	Normal	1	1	0.3	∞
Response time	0.8	Rectangular	1.732050808	1	0.5	∞
Integration time	2.6	Rectangular	1.732050808	1	1.5	∞
RF ambient conditions	3	Rectangular	1.732050808	1	1.7	∞
Mech. constraints of robot	0.4	Rectangular	1.732050808	1	0.2	∞
Probe positioning	2.9	Rectangular	1.732050808	1	1.7	∞
Extrapolation & integration	1	Rectangular	1.732050808	1	0.6	∞
<b>Test Sample Related</b>						
Device positioning	2.9	Normal	1	1	2.9	12
Device holder uncertainty	3.6	Normal	1	1	3.6	8
Power drift	5	Rectangular	1.732050808	1	2.9	∞
<b>Phantom and Setup</b>						
Phantom uncertainty	4	Rectangular	1.732050808	1	2.3	∞
Liquid conductivity (target)	5	Rectangular	1.732050808	0.64	1.8	∞
Liquid conductivity (measured)	2.5	Normal	1	0.64	1.6	∞
Liquid permittivity (target)	5	Rectangular	1.732050808	0.6	1.7	∞
Liquid permittivity (measured)	2.5	Normal	1	0.6	1.5	∞
<b>Combined Standard Uncertainty</b>					<b>10.79</b>	
<b>Expanded Uncertainty (k=2)</b>					<b>21.59</b>	

Measurement Uncertainty Table in accordance with IEEE Standard 1528-2003 (see reference [5])

## MEASUREMENT UNCERTAINTIES (Cont.)

UNCERTAINTY BUDGET FOR SYSTEM VALIDATION						
Error Description	Uncertainty Value ±%	Probability Distribution	Divisor	ci 1g	Uncertainty Value ±% (1g)	V <sub>i</sub> or V <sub>eff</sub>
<b>Measurement System</b>						
Probe calibration	5.9	Normal	1	1	5.9	∞
Axial isotropy of the probe	4.7	Rectangular	1.732050808	1	2.7	∞
Spherical isotropy of the probe	0	Rectangular	1.732050808	1	0.0	∞
Spatial resolution	0	Rectangular	1.732050808	1	0.0	∞
Boundary effects	1	Rectangular	1.732050808	1	0.6	∞
Probe linearity	4.7	Rectangular	1.732050808	1	2.7	∞
Detection limit	1	Rectangular	1.732050808	1	0.6	∞
Readout electronics	0.3	Normal	1	1	0.3	∞
Response time	0	Rectangular	1.732050808	1	0.0	∞
Integration time	0	Rectangular	1.732050808	1	0.0	∞
RF ambient conditions	3	Rectangular	1.732050808	1	1.7	∞
Mech. constraints of robot	0.4	Rectangular	1.732050808	1	0.2	∞
Probe positioning	2.9	Rectangular	1.732050808	1	1.7	∞
Extrapolation & integration	1	Rectangular	1.732050808	1	0.6	∞
<b>Test Sample Related</b>						
Dipole Positioning	2	Normal	1.732050808	1	1.2	∞
Power & Power Drift	4.7	Normal	1.732050808	1	2.7	∞
<b>Phantom and Setup</b>						
Phantom uncertainty	4	Rectangular	1.732050808	1	2.3	∞
Liquid conductivity (target)	5	Rectangular	1.732050808	0.64	1.8	∞
Liquid conductivity (measured)	2.5	Normal	1	0.64	1.6	∞
Liquid permittivity (target)	5	Rectangular	1.732050808	0.6	1.7	∞
Liquid permittivity (measured)	2.5	Normal	1	0.6	1.5	∞
<b>Combined Standard Uncertainty</b>					<b>9.04</b>	
<b>Expanded Uncertainty (k=2)</b>					<b>18.08</b>	

Measurement Uncertainty Table in accordance with IEEE Standard 1528-2003 (see reference [5])

Test Report Serial No.:	060605KBC-T643-S15W	Issue Date:	Aug. 4, 2005
Dates of Evaluation:	June 9, 23, July 15, 2005	Report Issue:	Issue 1 Rev0
Type of Evaluation:	RF Exposure	SAR	FCC 2.1093 IC RSS-102

## 17.0 REFERENCES

- [1] Federal Communications Commission, "Radiofrequency radiation exposure evaluation: portable devices", Rule Part 47 CFR §2.1093: 1999.
- [2] Health Canada, "Limits of Human Exposure to Radiofrequency Electromagnetic Fields in the Frequency Range from 3 kHz to 300 GHz", Safety Code 6.
- [3] Federal Communications Commission, "Evaluating Compliance with FCC Guidelines for Human Exposure to Radio frequency Electromagnetic Fields", OET Bulletin 65, Supplement C (Edition 01-01), FCC, Washington, D.C.: June 2001.
- [4] Industry Canada, "Evaluation Procedure for Mobile and Portable Radio Transmitters with respect to Health Canada's Safety Code 6 for Exposure of Humans to Radio Frequency Fields", Radio Standards Specification RSS-102 Issue 1 (Provisional): September 1999.
- [5] IEEE Standard 1528-2003, "Recommended Practice for Determining the Peak Spatial-Average Specific Absorption Rate (SAR) in the Human Head from Wireless Communications Devices: Measurement Techniques": December 2003.
- [6] Schmid & Partner Engineering AG, "DASY4 Manual", V4.5 April 2005.
- [7] May 2005 TCB Council Workshop, "SAR Test Configurations for 802.11 Wireless LAN Transmitters, 802.11 a/b/g Configurations Rev2, 802.11b/g Output Power".

<b>Applicant:</b>	<b>Itronix Corporation</b>	<b>FCC ID:</b>	<b>KBCIX325-IWL</b>	<b>IC ID:</b>	<b>1943A-IX325a</b>	
<b>Model:</b>	<b>IX325-IWL</b>	<b>Type:</b>	<b>Rugged Tablet PC with Intel Pro 2200BG 802.11b/g WLAN Mini-PCI Card</b>			
2005 Celltech Labs Inc.		This document is not to be reproduced in whole or in part without the written permission of Celltech Labs Inc.				14 of 42

Test Report Serial No.:	060605KBC-T643-S15W	Issue Date:	Aug. 4, 2005
Dates of Evaluation:	June 9, 23, July 15, 2005	Report Issue:	Issue 1 Rev0
Type of Evaluation:	RF Exposure	SAR	FCC 2.1093 IC RSS-102

## APPENDIX A - SAR MEASUREMENT DATA

<b>Applicant:</b>	<b>Itronix Corporation</b>	<b>FCC ID:</b>	<b>KBCIX325-IWL</b>	<b>IC ID:</b>	<b>1943A-IX325a</b>	
<b>Model:</b>	<b>IX325-IWL</b>	<b>Type:</b>	<b>Rugged Tablet PC with Intel Pro 2200BG 802.11b/g WLAN Mini-PCI Card</b>			
2005 Celltech Labs Inc.		This document is not to be reproduced in whole or in part without the written permission of Celltech Labs Inc.				15 of 42

Test Report Serial No.:	060605KBC-T643-S15W	Issue Date:	Aug. 4, 2005
Dates of Evaluation:	June 9, 23, July 15, 2005	Report Issue:	Issue 1 Rev0
Type of Evaluation:	RF Exposure	SAR	FCC 2.1093 IC RSS-102

Date Tested: 06/09/2005

### Body SAR - 802.11b - 1Mbps - Bottom Side of DUT - 0.0 cm Spacing - Internal Battery Power

DUT: Itronix Model: IX325-IWL; Type: Rugged Tablet PC with Intel Pro 2200BG 802.11b/g WLAN; Serial: ZZGEG5074ZZ9799

Ambient Temp: 24.7 °C; Fluid Temp: 23.4 °C; Barometric Pressure: 101.4 kPa; Humidity: 34%

11.1V, 3600mAh Internal Li-ion Battery Pack (Model: T8M-E)  
 Communication System: DSSS WLAN  
 Frequency: 2442 MHz; Duty Cycle: 1:1  
 RF Output Power: 18.6 dBm (Peak Conducted)  
 Medium: M2450 ( $\sigma = 1.99$  mho/m;  $\epsilon_r = 51.2$ ;  $\rho = 1000$  kg/m<sup>3</sup>)

- Probe: ET3DV6 - SN1590; ConvF(4.22, 4.22, 4.22); Calibrated: 20/05/2005
- Sensor-Surface: 4mm (Mechanical Surface Detection)
- Electronics: DAE3 Sn370; Calibrated: 25/01/2005
- Phantom: Barski Industries; Type: Fiberglas Planar; Serial: 03-01
- Measurement SW: DASY4, V4.5 Build 19; Postprocessing SW: SEMCAD, V1.8 Build 146

**Body SAR - 802.11b - 0.0 cm Separation Distance from Bottom Side of DUT to Planar Phantom - Mid Channel Area Scan (16x23x1):** Measurement grid: dx=15mm, dy=15mm  
**Maximum value of SAR (measured) = 0.00201 mW/g**

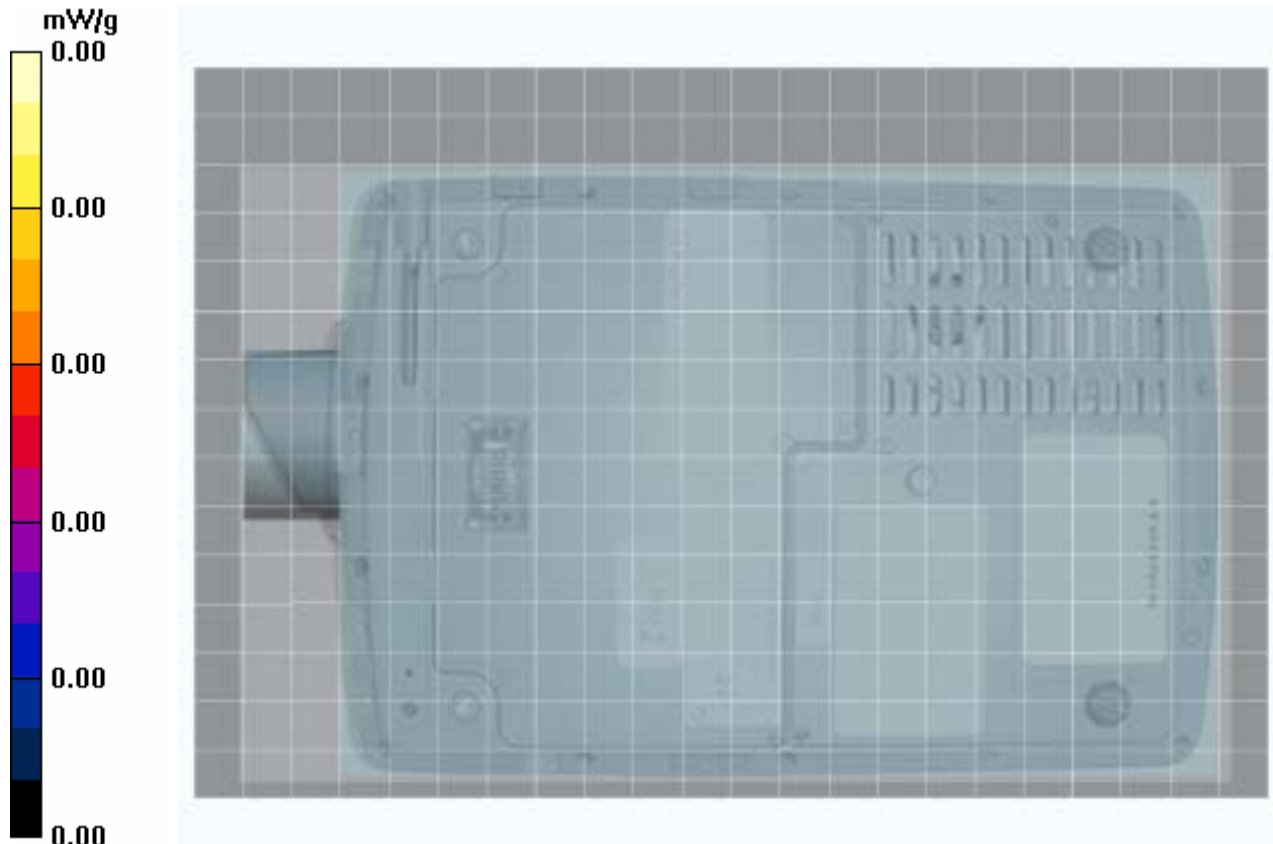



Test Report Serial No.:	060605KBC-T643-S15W	Issue Date:	Aug. 4, 2005
Dates of Evaluation:	June 9, 23, July 15, 2005	Report Issue:	Issue 1 Rev0
Type of Evaluation:	RF Exposure	SAR	FCC 2.1093 IC RSS-102

Date Tested: 06/09/2005

**Body SAR - 802.11b - 1Mbps - Bottom Side of DUT - 0.0 cm Spacing - AC Power Supply**

**DUT: Itronix Model: IX325-IWL; Type: Rugged Tablet PC with Intel Pro 2200BG 802.11b/g WLAN; Serial: ZZGEG5074ZZ9799**

Ambient Temp: 24.7 °C; Fluid Temp: 23.4 °C; Barometric Pressure: 101.4 kPa; Humidity: 34%

75 W AC Power Adapter (Delta Electronics Model: ADP-75FB B)  
 Communication System: DSSS WLAN  
 Frequency: 2442 MHz; Duty Cycle: 1:1  
 RF Output Power: 18.6 dBm (Peak Conducted)  
 Medium: M2450 ( $\sigma = 1.99 \text{ mho/m}$ ;  $\epsilon_r = 51.2$ ;  $\rho = 1000 \text{ kg/m}^3$ )

- Probe: ET3DV6 - SN1590; ConvF(4.22, 4.22, 4.22); Calibrated: 20/05/2005
- Sensor-Surface: 4mm (Mechanical Surface Detection (Locations From Previous Scan Used))
- Electronics: DAE3 Sn370; Calibrated: 25/01/2005
- Phantom: Barski Industries; Type: Fiberglas Planar; Serial: 03-01
- Measurement SW: DASY4, V4.5 Build 19; Postprocessing SW: SEMCAD, V1.8 Build 146

**Body SAR - 802.11b - 0.0 cm Separation Distance from Bottom Side of DUT to Planar Phantom - Mid Channel Area Scan (16x23x1): Measurement grid: dx=15mm, dy=15mm**  
**Maximum value of SAR (measured) = 0.00148 mW/g**

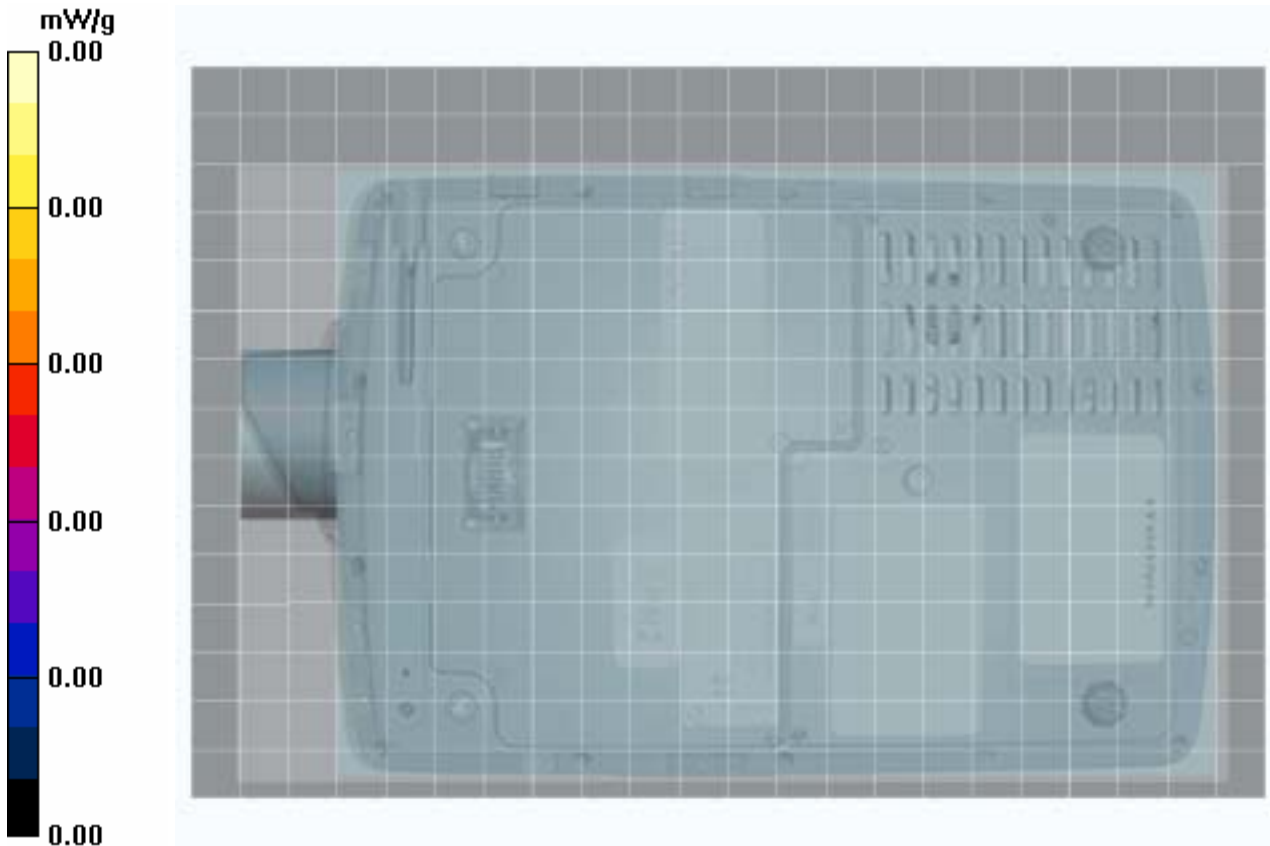

Test Report Serial No.:	060605KBC-T643-S15W	Issue Date:	Aug. 4, 2005
Dates of Evaluation:	June 9, 23, July 15, 2005	Report Issue:	Issue 1 Rev0
Type of Evaluation:	RF Exposure	SAR	FCC 2.1093 IC RSS-102

Date Tested: 06/23/2005

**Body SAR - 802.11b - 1 Mbps - Antenna Edge of DUT - 0.0 cm Spacing - Internal Battery Power**

**DUT: Itronix Model: IX325-IWL; Type: Rugged Tablet PC with Intel Pro 2200BG 802.11b/g WLAN; Serial: ZZGEG5074ZZ9799**

Ambient Temp: 23.0 °C; Fluid Temp: 23.7 °C; Barometric Pressure: 102.4 kPa; Humidity: 35%

11.1V, 3600mAh Internal Li-ion Battery Pack (Model: T8M-E)  
 Communication System: DSSS WLAN  
 Frequency: 2442 MHz; Duty Cycle: 1:1  
 RF Output Power: 18.6 dBm (Peak Conducted)  
 Medium: M2450 ( $\sigma = 1.95 \text{ mho/m}$ ;  $\epsilon_r = 50.2$ ;  $\rho = 1000 \text{ kg/m}^3$ )

- Probe: ET3DV6 - SN1590; ConvF(4.22, 4.22, 4.22); Calibrated: 20/05/2005
- Sensor-Surface: 4mm (Mechanical Surface Detection)
- Electronics: DAE3 Sn370; Calibrated: 25/01/2005
- Phantom: Barski Industries; Type: Fiberglass Planar; Serial: 03-01
- Measurement SW: DASY4, V4.5 Build 19; Postprocessing SW: SEMCAD, V1.8 Build 146

**Body SAR - 802.11b - 0.0 cm Separation Distance from Antenna Edge of DUT to Planar Phantom - Mid Channel Area Scan (8x23x1):** Measurement grid: dx=15mm, dy=15mm

**Body SAR - 802.11b - 0.0 cm Separation Distance from Antenna Edge of DUT to Planar Phantom - Mid Channel Zoom Scan (7x7x7)/Cube 0:** Measurement grid: dx=5mm, dy=5mm, dz=5mm  
 Reference Value = 10.7 V/m; Power Drift = -0.222 dB  
 Peak SAR (extrapolated) = 0.520 W/kg  
**SAR(1 g) = 0.200 mW/g; SAR(10 g) = 0.079 mW/g**

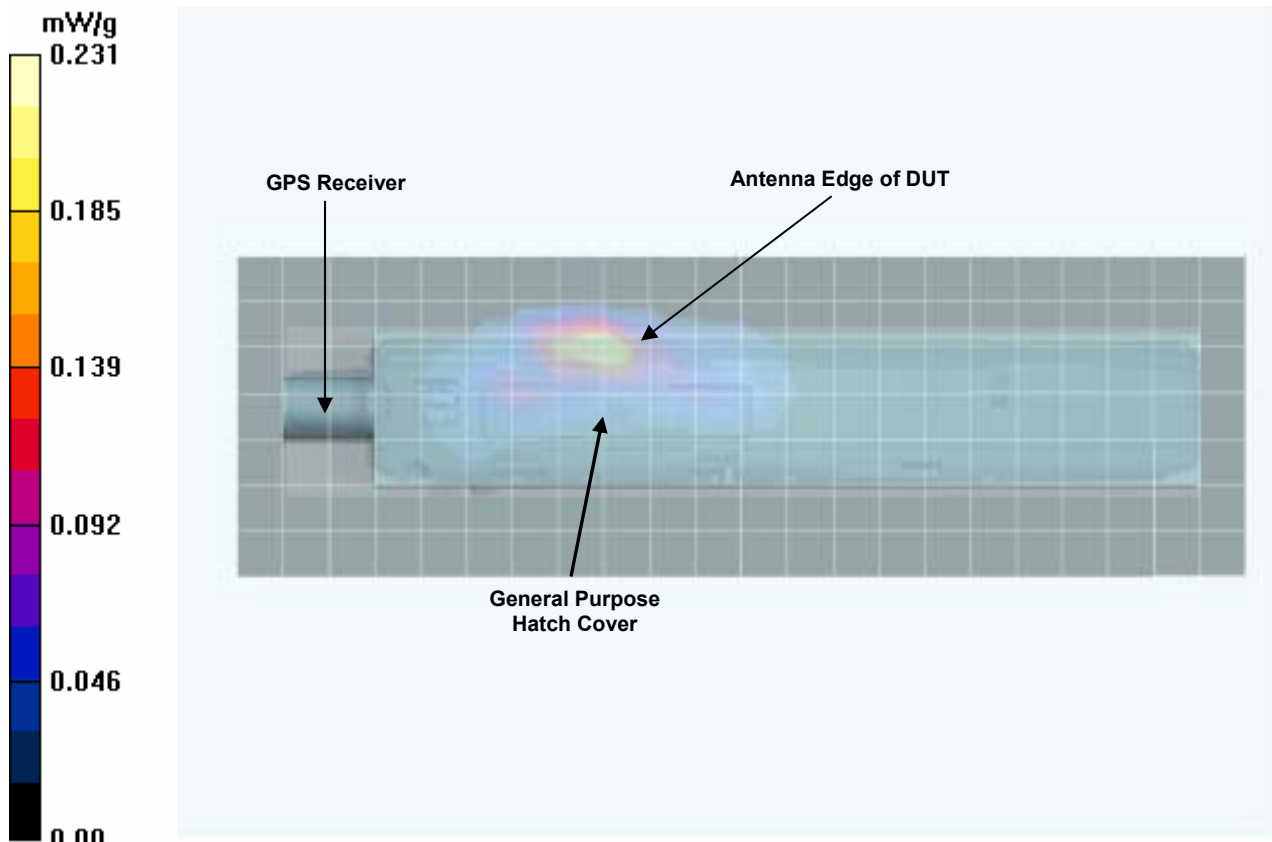

Applicant:	Itronix Corporation	FCC ID:	KBCIX325-IWL	IC ID:	1943A-IX325a	
Model:	IX325-IWL	Type:	Rugged Tablet PC with Intel Pro 2200BG 802.11b/g WLAN Mini-PCI Card			
2005 Celltech Labs Inc.		This document is not to be reproduced in whole or in part without the written permission of Celltech Labs Inc.				18 of 42

Test Report Serial No.:	060605KBC-T643-S15W	Issue Date:	Aug. 4, 2005
Dates of Evaluation:	June 9, 23, July 15, 2005	Report Issue:	Issue 1 Rev0
Type of Evaluation:	RF Exposure	SAR	FCC 2.1093 IC RSS-102

Date Tested: 06/23/2005

### Body SAR - 802.11b - 1 Mbps - Antenna Edge of DUT - 0.0 cm Spacing - AC Power Supply

DUT: Itronix Model: IX325-IWL; Type: Rugged Tablet PC with Intel Pro 2200BG 802.11b/g WLAN; Serial: ZZGEG5074ZZ9799

Ambient Temp: 23.0 °C; Fluid Temp: 23.7 °C; Barometric Pressure: 102.4 kPa; Humidity: 35%

75 W AC Power Adapter (Delta Electronics Model: ADP-75FB B)  
 Communication System: DSSS WLAN  
 Frequency: 2442 MHz; Duty Cycle: 1:1  
 RF Output Power: 18.6 dBm (Peak Conducted)  
 Medium: M2450 ( $\sigma = 1.95 \text{ mho/m}$ ;  $\epsilon_r = 50.2$ ;  $\rho = 1000 \text{ kg/m}^3$ )

- Probe: ET3DV6 - SN1590; ConvF(4.22, 4.22, 4.22); Calibrated: 20/05/2005
- Sensor-Surface: 4mm (Mechanical Surface Detection)
- Electronics: DAE3 Sn370; Calibrated: 25/01/2005
- Phantom: Barski Industries; Type: Fiberglass Planar; Serial: 03-01
- Measurement SW: DASY4, V4.5 Build 19; Postprocessing SW: SEMCAD, V1.8 Build 146

### Body SAR - 802.11b - 0.0 cm Separation Distance from Antenna Edge of DUT to Planar Phantom - Mid Channel Area Scan (8x23x1): Measurement grid: dx=15mm, dy=15mm

Body SAR - 802.11b - 0.0 cm Separation Distance from Antenna Edge of DUT to Planar Phantom - Mid Channel Zoom Scan (7x7x7)/Cube 0: Measurement grid: dx=5mm, dy=5mm, dz=5mm  
 Reference Value = 8.98 V/m; Power Drift = -0.184 dB  
 Peak SAR (extrapolated) = 0.421 W/kg  
**SAR(1 g) = 0.163 mW/g; SAR(10 g) = 0.065 mW/g**

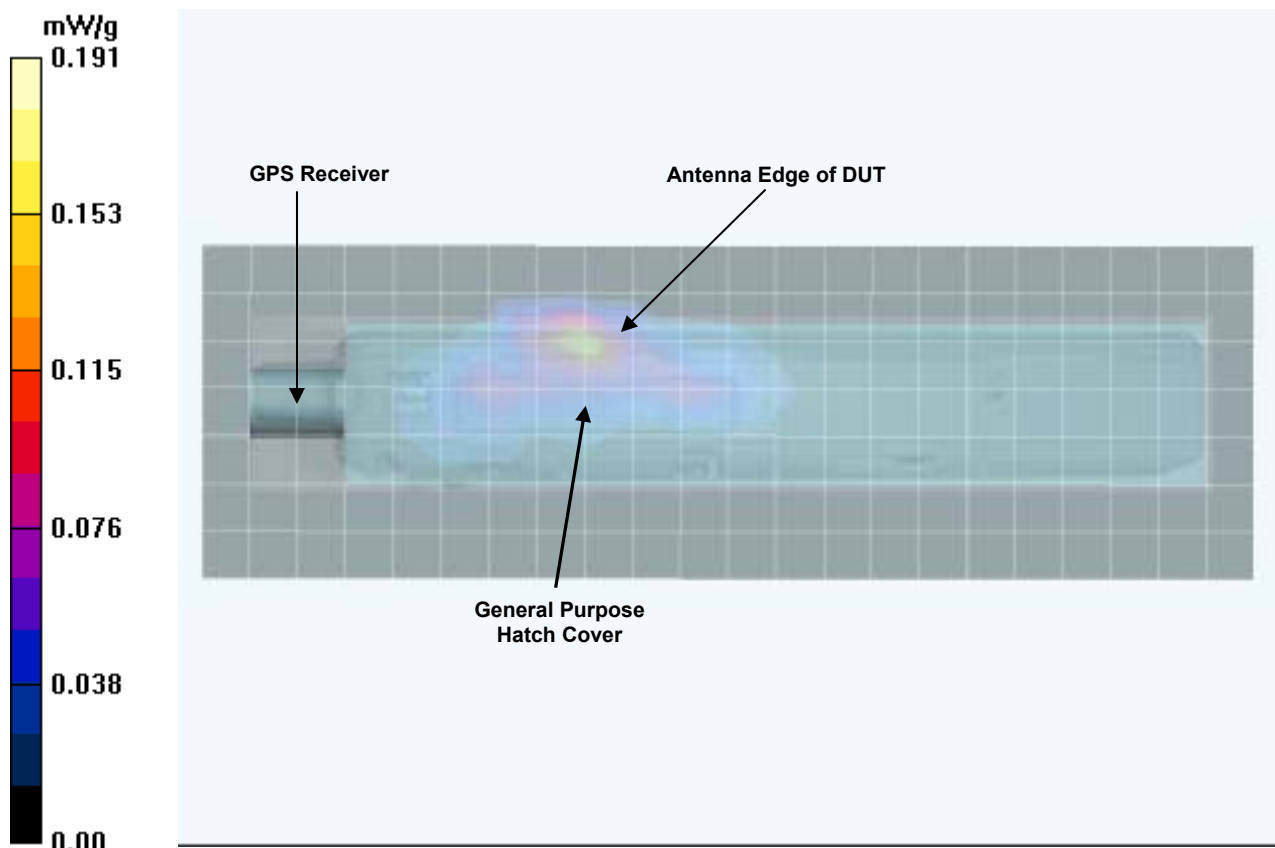

Applicant:	Itronix Corporation	FCC ID:	KBCIX325-IWL	IC ID:	1943A-IX325a	
Model:	IX325-IWL	Type:	Rugged Tablet PC with Intel Pro 2200BG 802.11b/g WLAN Mini-PCI Card			
2005 Celltech Labs Inc.		This document is not to be reproduced in whole or in part without the written permission of Celltech Labs Inc.				19 of 42

Test Report Serial No.:	060605KBC-T643-S15W	Issue Date:	Aug. 4, 2005
Dates of Evaluation:	June 9, 23, July 15, 2005	Report Issue:	Issue 1 Rev0
Type of Evaluation:	RF Exposure	SAR	FCC 2.1093 IC RSS-102

Date Tested: 07/15/2005

### Body SAR - 802.11b - 11 Mbps - Antenna Edge of DUT - 0.0 cm Spacing - Internal Battery Power

DUT: Itronix Model: IX325-IWL; Type: Rugged Tablet PC with Intel Pro 2200BG 802.11b/g WLAN; Serial: ZZGEG5074ZZ9799

Ambient Temp: 24.6 °C; Fluid Temp: 23.9 °C; Barometric Pressure: 106.4 kPa; Humidity: 32%

11.1V, 3600mAh Internal Li-ion Battery Pack (Model: T8M-E)  
 Communication System: DSSS WLAN  
 Frequency: 2442 MHz; Duty Cycle: 1:1  
 RF Output Power: 20.5 dBm (Peak Conducted)  
 Medium: M2450 ( $\sigma = 1.92 \text{ mho/m}$ ;  $\epsilon_r = 50.7$ ;  $\rho = 1000 \text{ kg/m}^3$ )

- Probe: ET3DV6 - SN1387; ConvF(4.3, 4.3, 4.3); Calibrated: 18/03/2005
- Sensor-Surface: 4mm (Mechanical Surface Detection)
- Electronics: DAE3 Sn370; Calibrated: 25/01/2005
- Phantom: Barski Industries; Type: Fiberglass Planar; Serial: 03-01
- Measurement SW: DASY4, V4.5 Build 19; Postprocessing SW: SEMCAD, V1.8 Build 146

**Body SAR - 802.11b - 0.0 cm Separation Distance from Antenna Edge of DUT to Planar Phantom - Mid Channel Area Scan (8x23x1):** Measurement grid: dx=15mm, dy=15mm

**Body SAR - 802.11b - 0.0 cm Separation Distance from Antenna Edge of DUT to Planar Phantom - Mid Channel Zoom Scan (7x7x7)/Cube 0:** Measurement grid: dx=5mm, dy=5mm, dz=5mm

Reference Value = 6.82 V/m; Power Drift = -0.0180 dB  
 Peak SAR (extrapolated) = 0.309 W/kg  
**SAR(1 g) = 0.116 mW/g; SAR(10 g) = 0.045 mW/g**

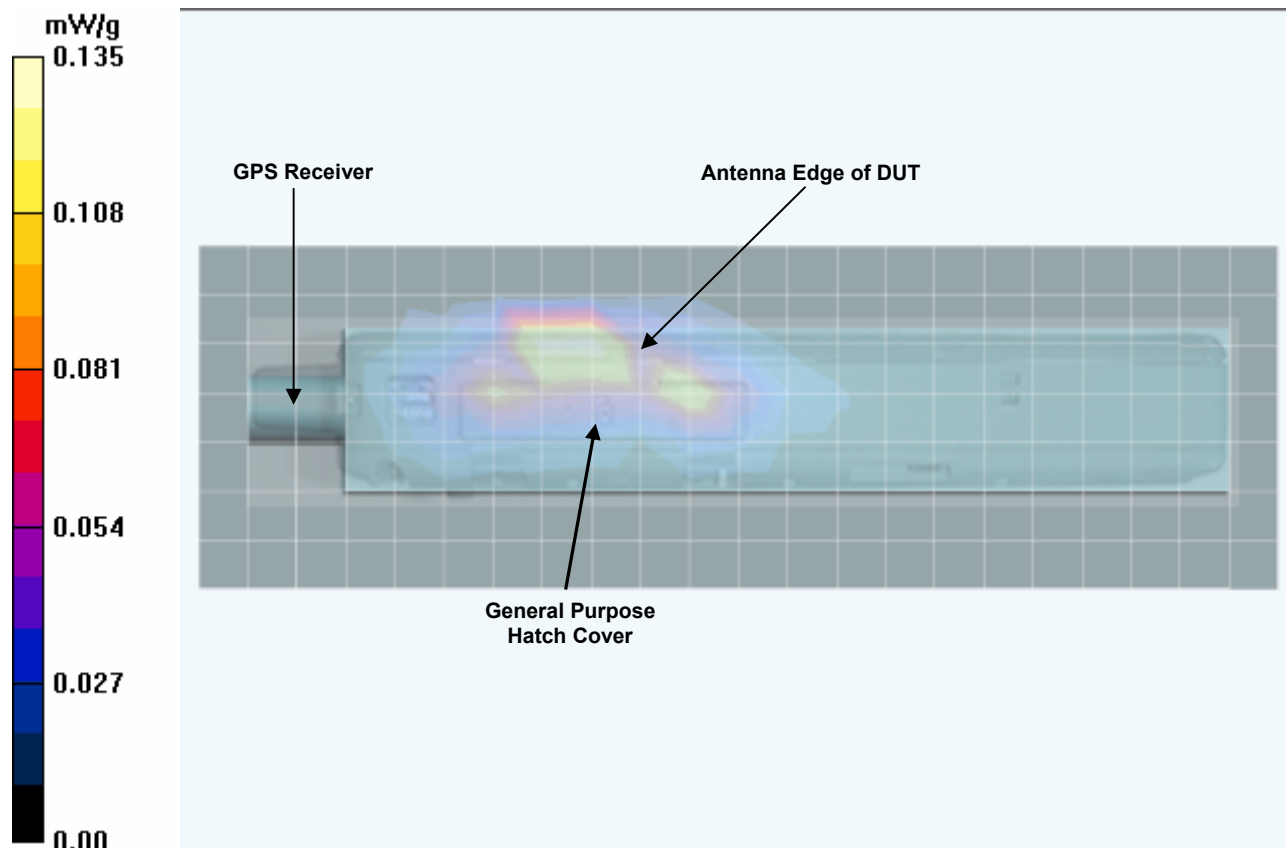

Applicant:	Itronix Corporation	FCC ID:	KBCIX325-IWL	IC ID:	1943A-IX325a	
Model:	IX325-IWL	Type:	Rugged Tablet PC with Intel Pro 2200BG 802.11b/g WLAN Mini-PCI Card			
2005 Celltech Labs Inc.		This document is not to be reproduced in whole or in part without the written permission of Celltech Labs Inc.				20 of 42

Test Report Serial No.:	060605KBC-T643-S15W	Issue Date:	Aug. 4, 2005
Dates of Evaluation:	June 9, 23, July 15, 2005	Report Issue:	Issue 1 Rev0
Type of Evaluation:	RF Exposure	SAR	FCC 2.1093
			IC RSS-102

### Fluid Depth ( $\geq 15\text{cm}$ )



Applicant:	Itronix Corporation	FCC ID:	KBCIX325-IWL	IC ID:	1943A-IX325a	
Model:	IX325-IWL	Type:	Rugged Tablet PC with Intel Pro 2200BG 802.11b/g WLAN Mini-PCI Card			
2005 Celltech Labs Inc.		This document is not to be reproduced in whole or in part without the written permission of Celltech Labs Inc.				21 of 42

Test Report Serial No.:	060605KBC-T643-S15W	Issue Date:	Aug. 4, 2005
Dates of Evaluation:	June 9, 23, July 15, 2005	Report Issue:	Issue 1 Rev0
Type of Evaluation:	RF Exposure	SAR	FCC 2.1093 IC RSS-102

**APPENDIX B - SYSTEM PERFORMANCE CHECK DATA**

<b>Applicant:</b>	<b>Itronix Corporation</b>	<b>FCC ID:</b>	<b>KBCIX325-IWL</b>	<b>IC ID:</b>	<b>1943A-IX325a</b>	
<b>Model:</b>	<b>IX325-IWL</b>	<b>Type:</b>	<b>Rugged Tablet PC with Intel Pro 2200BG 802.11b/g WLAN Mini-PCI Card</b>			
2005 Celltech Labs Inc.		This document is not to be reproduced in whole or in part without the written permission of Celltech Labs Inc.				22 of 42

Test Report Serial No.:	060605KBC-T643-S15W	Issue Date:	Aug. 4, 2005
Dates of Evaluation:	June 9, 23, July 15, 2005	Report Issue:	Issue 1 Rev0
Type of Evaluation:	RF Exposure	SAR	FCC 2.1093 IC RSS-102

Date Tested: 06/09/2005

### System Performance Check (Brain) - 2450 MHz Dipole

**DUT: Dipole 2450 MHz; Model: D2450V2; Type: System Performance Check; Serial: 150; Calibrated: 09/30/2004**

Ambient Temp: 22.0 °C; Fluid Temp: 24.8 °C; Barometric Pressure: 101.7 kPa; Humidity: 38%

Communication System: CW  
 Forward Conducted Power: 250 mW  
 Frequency: 2450 MHz; Duty Cycle: 1:1  
 Medium: HSL2450 ( $\sigma = 1.87 \text{ mho/m}$ ;  $\epsilon_r = 37.4$ ;  $\rho = 1000 \text{ kg/m}^3$ )

- Probe: ET3DV6 - SN1590; ConvF(4.56, 4.56, 4.56); Calibrated: 20/05/2005
- Sensor-Surface: 4mm (Mechanical And Optical Surface Detection)
- Electronics: DAE3 Sn370; Calibrated: 25/01/2005
- Phantom: SAM 4.0; Type: Fiberglass; Serial: 1033
- Measurement SW: DASY4, V4.5 Build 19; Postprocessing SW: SEMCAD, V1.8 Build 146

#### 2450 MHz Dipole - System Performance Check/Area Scan (6x10x1):

Measurement grid: dx=10mm, dy=10mm

#### 2450 MHz Dipole - System Performance Check/Zoom Scan (7x7x7)/Cube 0:

Measurement grid: dx=5mm, dy=5mm, dz=5mm  
 Reference Value = 96.5 V/m; Power Drift = -0.025 dB  
 Peak SAR (extrapolated) = 30.2 W/kg  
**SAR(1 g) = 13.9 mW/g; SAR(10 g) = 6.41 mW/g**

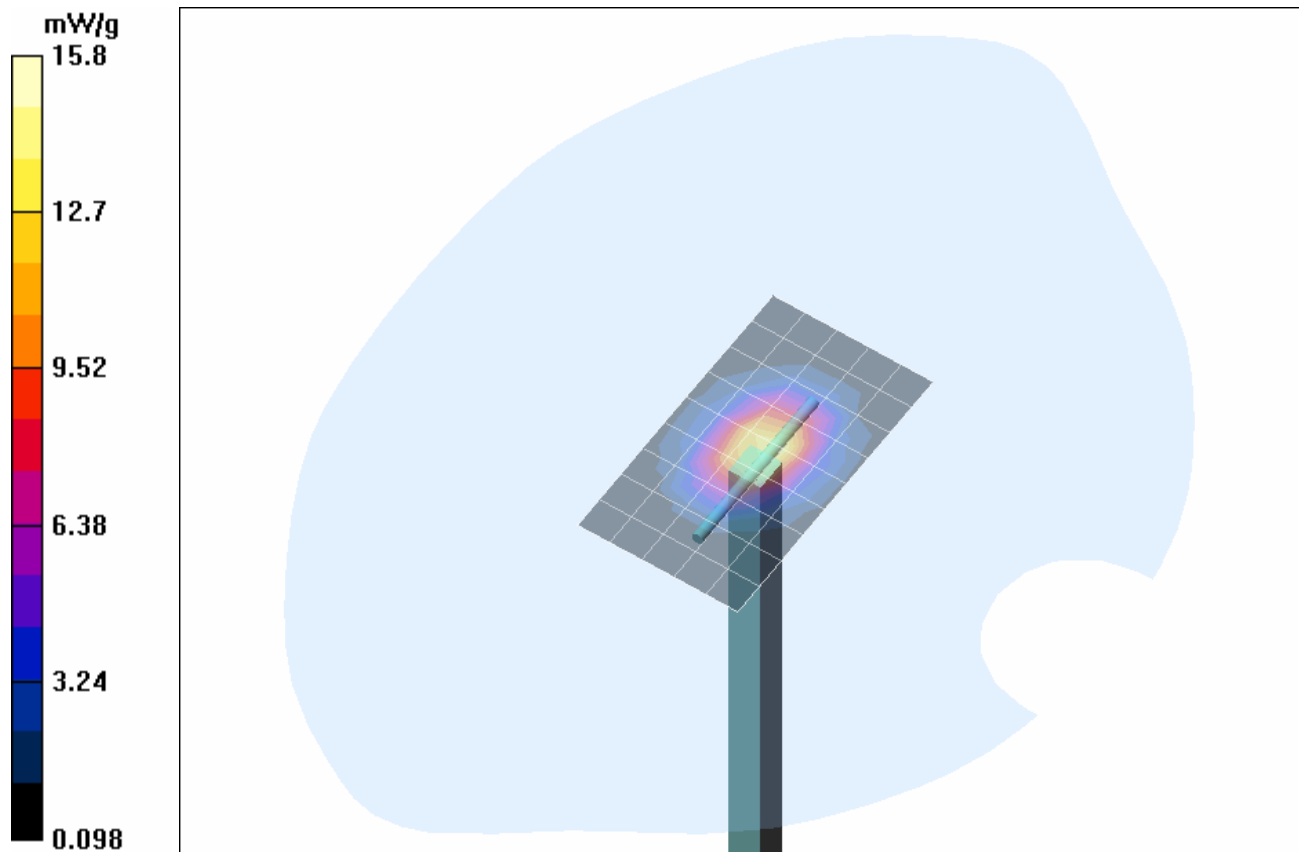

Test Report Serial No.:	060605KBC-T643-S15W	Issue Date:	Aug. 4, 2005
Dates of Evaluation:	June 9, 23, July 15, 2005	Report Issue:	Issue 1 Rev0
Type of Evaluation:	RF Exposure	SAR	FCC 2.1093 IC RSS-102

### Z-Axis Scan

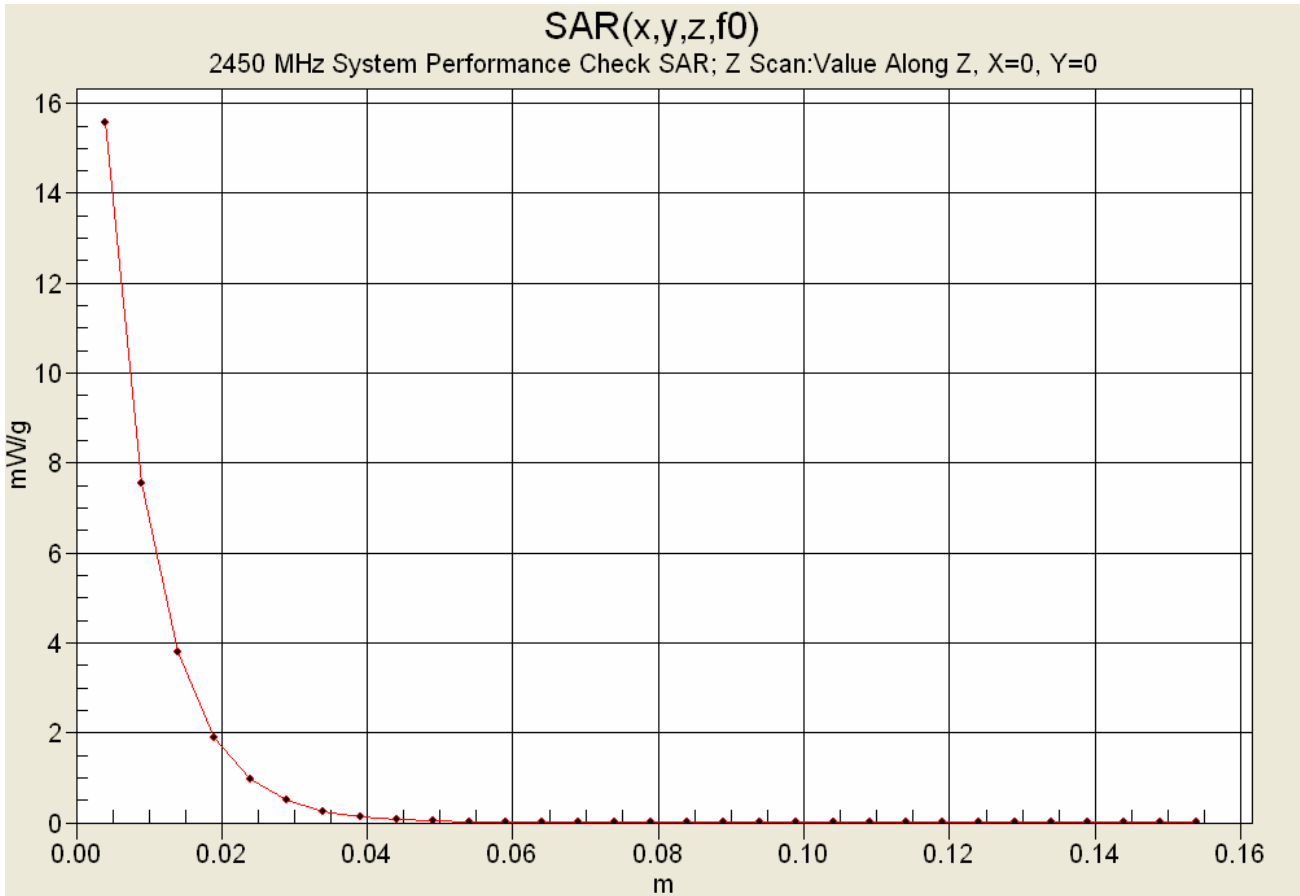

<b>Applicant:</b>	Itronix Corporation	<b>FCC ID:</b>	KBCIX325-IWL	<b>IC ID:</b>	1943A-IX325a	
<b>Model:</b>	IX325-IWL	<b>Type:</b>	Rugged Tablet PC with Intel Pro 2200BG 802.11b/g WLAN Mini-PCI Card			
2005 Celltech Labs Inc.		This document is not to be reproduced in whole or in part without the written permission of Celltech Labs Inc.				24 of 42



Test Report Serial No.:	060605KBC-T643-S15W	Issue Date:	Aug. 4, 2005
Dates of Evaluation:	June 9, 23, July 15, 2005	Report Issue:	Issue 1 Rev0
Type of Evaluation:	RF Exposure	SAR	FCC 2.1093 IC RSS-102

Date Tested: 06/23/2005

### System Performance Check (Body) - 2450 MHz Dipole

**DUT: Dipole 2450 MHz; Model: D2450V2; Type: System Performance Check; Serial: 150; Calibrated: 04/22/2005**

Ambient Temp: 23.0 °C; Fluid Temp: 23.7 °C; Barometric Pressure: 102.4 kPa; Humidity: 35%

Communication System: CW  
 Forward Conducted Power: 250 mW  
 Frequency: 2450 MHz; Duty Cycle: 1:1  
 Medium: M2450 ( $\sigma = 1.95 \text{ mho/m}$ ;  $\epsilon_r = 50.2$ ;  $\rho = 1000 \text{ kg/m}^3$ )

- Probe: ET3DV6 - SN1590; ConvF(4.22, 4.22, 4.22); Calibrated: 20/05/2005
- Sensor-Surface: 4mm (Mechanical Surface Detection)
- Electronics: DAE3 Sn370; Calibrated: 25/01/2005
- Phantom: Barski Industries; Type: Fiberglass Planar; Serial: 03-01
- Measurement SW: DASY4, V4.5 Build 19; Postprocessing SW: SEMCAD, V1.8 Build 146

#### 2450 MHz Dipole - System Performance Check/Area Scan (6x10x1):

Measurement grid: dx=10mm, dy=10mm

#### 2450 MHz Dipole - System Performance Check/Zoom Scan (7x7x7)/Cube 0:

Measurement grid: dx=5mm, dy=5mm, dz=5mm  
 Reference Value = 90.1 V/m; Power Drift = -0.031 dB  
 Peak SAR (extrapolated) = 28.6 W/kg  
**SAR(1 g) = 12.8 mW/g; SAR(10 g) = 5.9 mW/g**

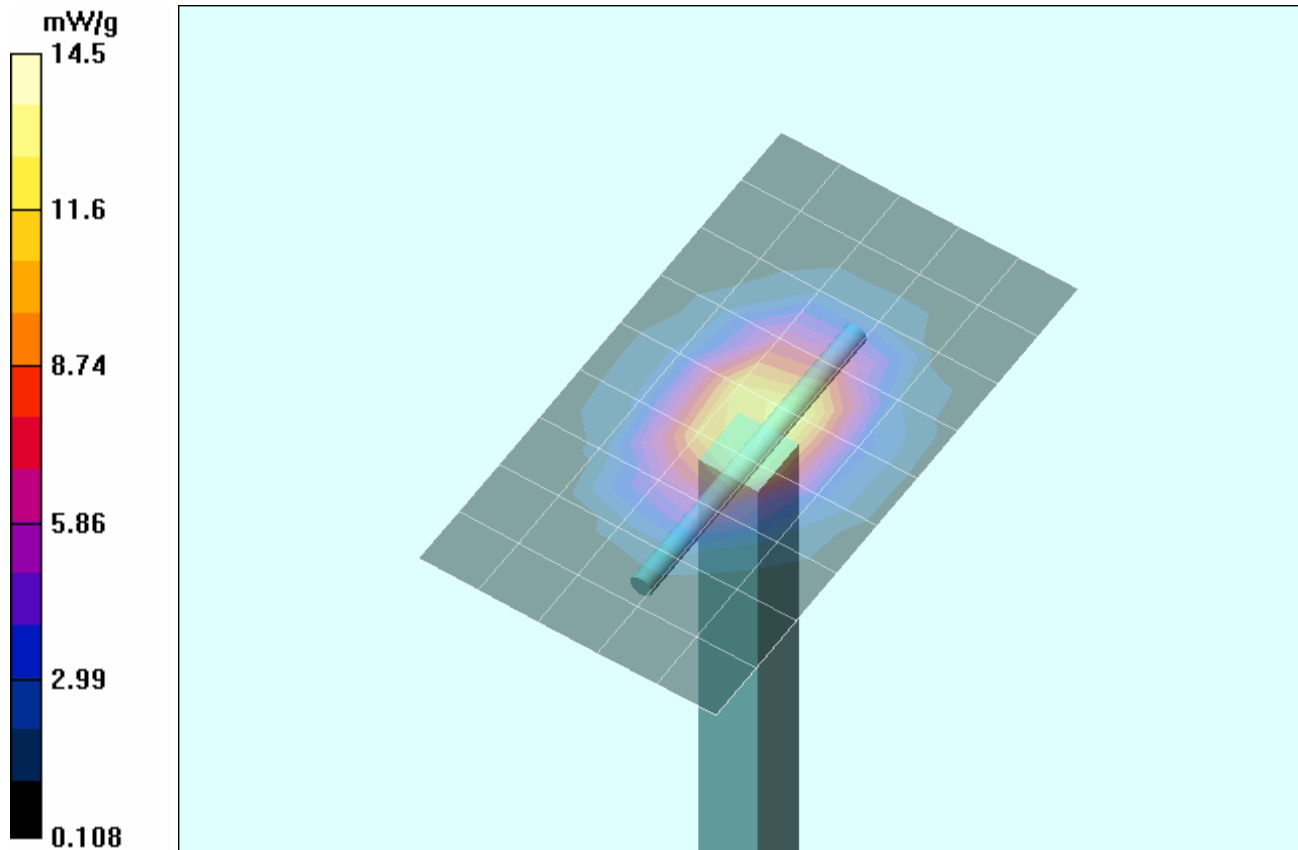

Test Report Serial No.:	060605KBC-T643-S15W	Issue Date:	Aug. 4, 2005
Dates of Evaluation:	June 9, 23, July 15, 2005	Report Issue:	Issue 1 Rev0
Type of Evaluation:	RF Exposure	SAR	FCC 2.1093 IC RSS-102

### Z-Axis Scan

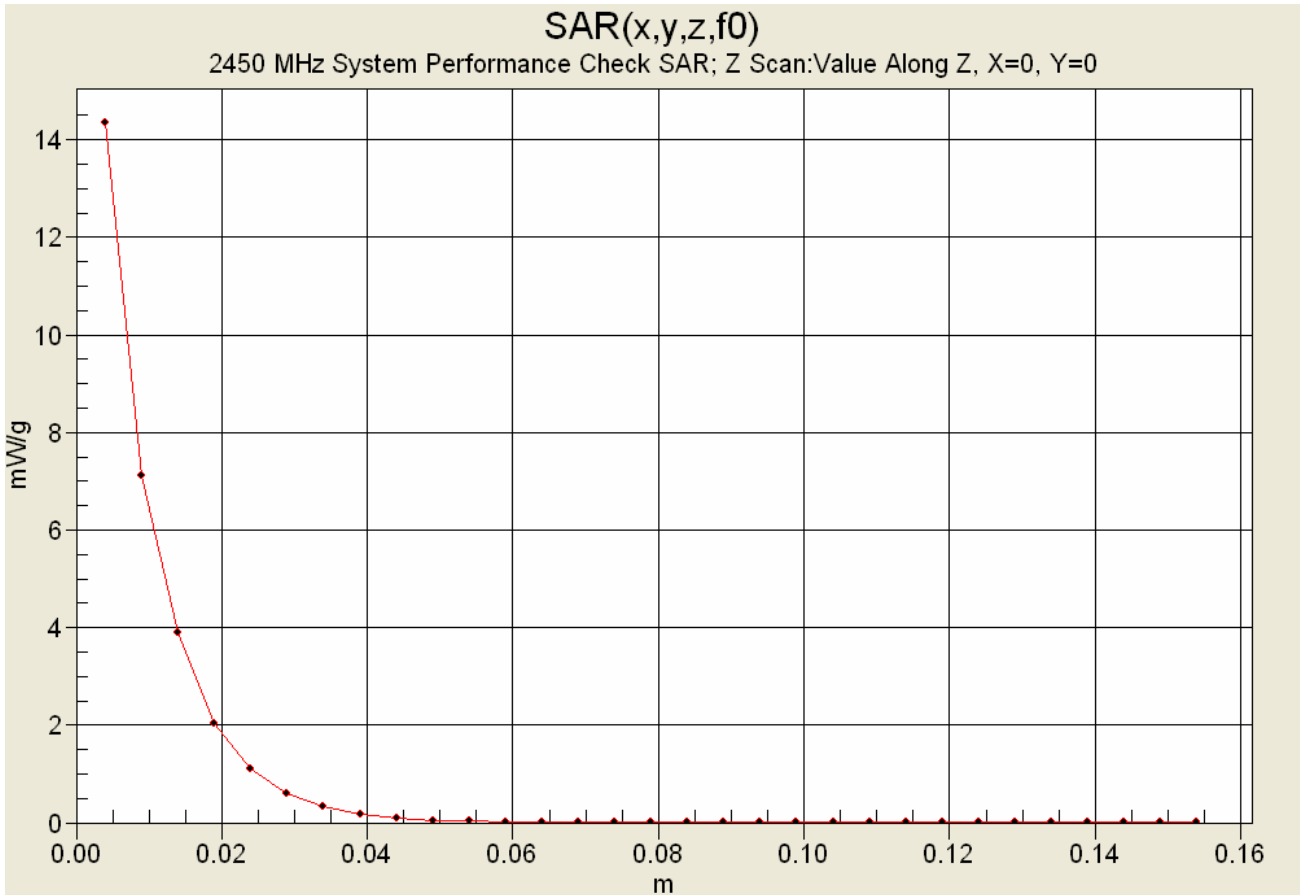

Test Report Serial No.:	060605KBC-T643-S15W	Issue Date:	Aug. 4, 2005
Dates of Evaluation:	June 9, 23, July 15, 2005	Report Issue:	Issue 1 Rev0
Type of Evaluation:	RF Exposure	SAR	FCC 2.1093 IC RSS-102

Date Tested: 07/15/2005

### System Performance Check (Body) - 2450 MHz Dipole

DUT: Dipole 2450 MHz; Model: D2450V2; Type: System Performance Check; Serial: 150; Calibrated: 04/22/2005

Ambient Temp: 24.6 °C; Fluid Temp: 23.9 °C; Barometric Pressure: 106.4 kPa; Humidity: 32%

Communication System: CW  
 Forward Conducted Power: 250 mW  
 Frequency: 2450 MHz; Duty Cycle: 1:1  
 Medium: M2450 ( $\sigma = 1.92 \text{ mho/m}$ ;  $\epsilon_r = 50.7$ ;  $\rho = 1000 \text{ kg/m}^3$ )

- Probe: ET3DV6 - SN1387; ConvF(4.3, 4.3, 4.3); Calibrated: 18/03/2005
- Sensor-Surface: 4mm (Mechanical Surface Detection)
- Electronics: DAE3 Sn370; Calibrated: 25/01/2005
- Phantom: Barski Industries; Type: Fiberglass Planar; Serial: 03-01
- Measurement SW: DASY4, V4.5 Build 19; Postprocessing SW: SEMCAD, V1.8 Build 146

#### 2450 MHz Dipole - System Performance Check/Area Scan (6x10x1):

Measurement grid: dx=10mm, dy=10mm

#### 2450 MHz Dipole - System Performance Check/Zoom Scan (7x7x7)/Cube 0:

Measurement grid: dx=5mm, dy=5mm, dz=5mm  
 Reference Value = 87.7 V/m; Power Drift = -0.064 dB  
 Peak SAR (extrapolated) = 29.3 W/kg  
**SAR(1 g) = 12.9 mW/g; SAR(10 g) = 5.98 mW/g**

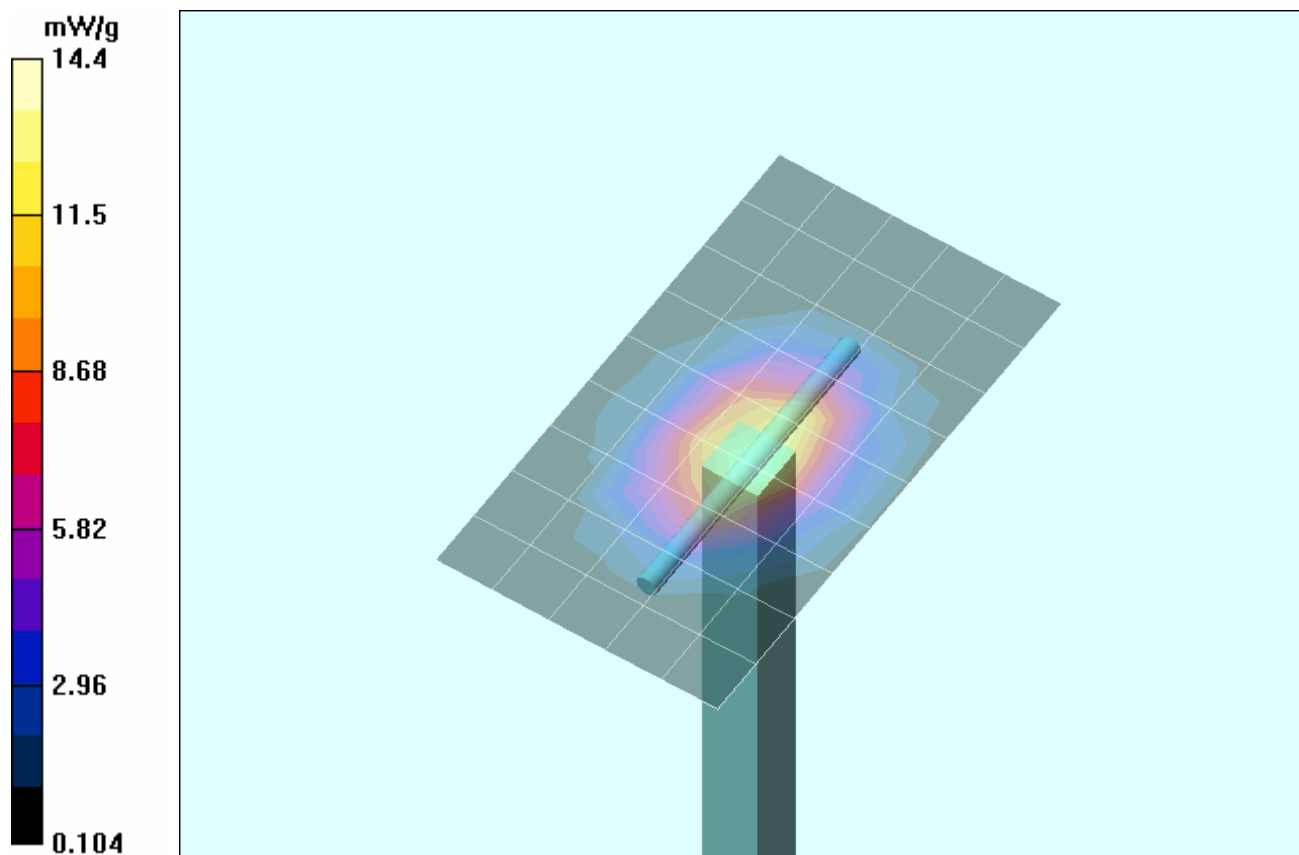

Applicant:	Itronix Corporation	FCC ID:	KBCIX325-IWL	IC ID:	1943A-IX325a	
Model:	IX325-IWL	Type:	Rugged Tablet PC with Intel Pro 2200BG 802.11b/g WLAN Mini-PCI Card			
2005 Celltech Labs Inc.		This document is not to be reproduced in whole or in part without the written permission of Celltech Labs Inc.				27 of 42

Test Report Serial No.:	060605KBC-T643-S15W	Issue Date:	Aug. 4, 2005
Dates of Evaluation:	June 9, 23, July 15, 2005	Report Issue:	Issue 1 Rev0
Type of Evaluation:	RF Exposure	SAR	FCC 2.1093 IC RSS-102

### Z-Axis Scan

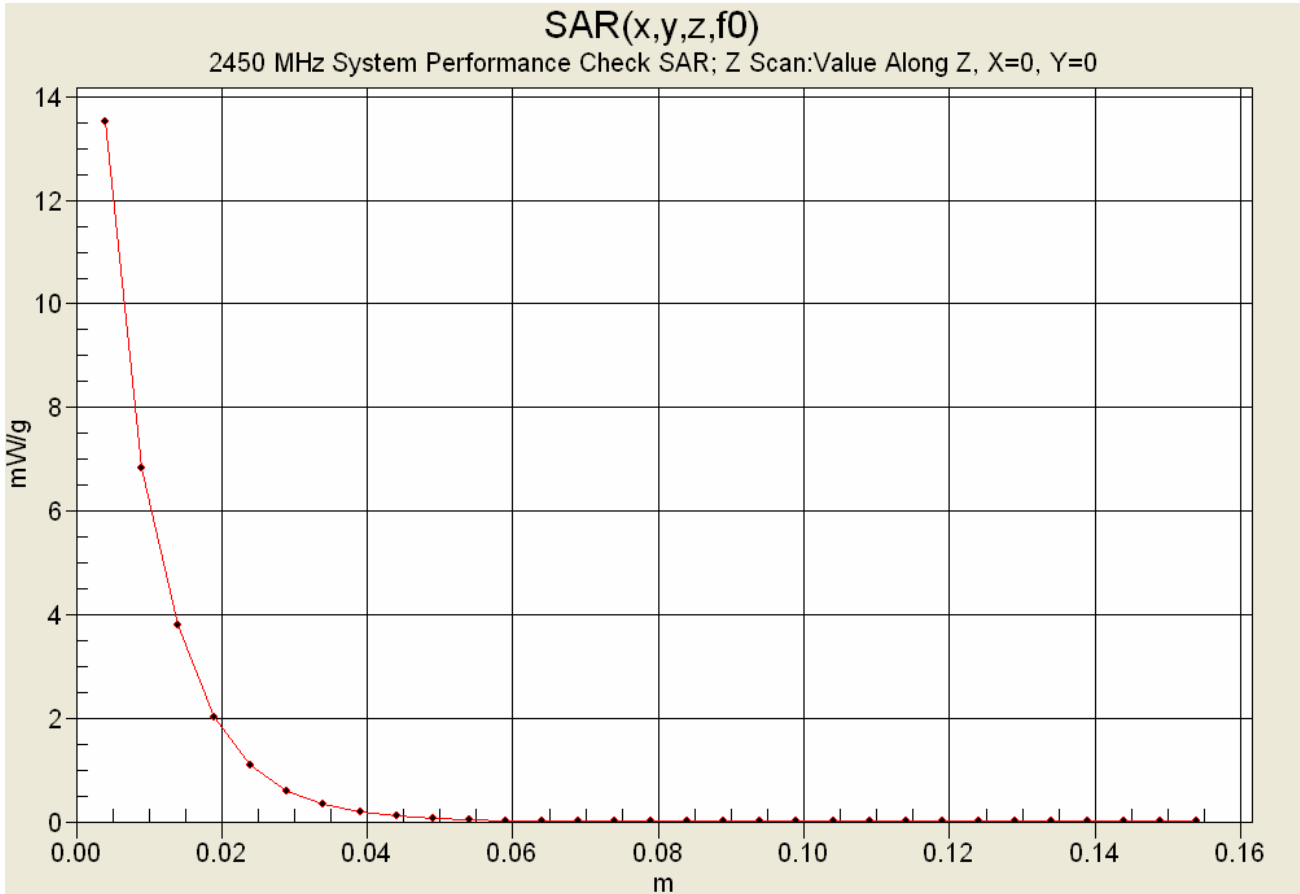

Test Report Serial No.:	060605KBC-T643-S15W	Issue Date:	Aug. 4, 2005
Dates of Evaluation:	June 9, 23, July 15, 2005	Report Issue:	Issue 1 Rev0
Type of Evaluation:	RF Exposure	SAR	FCC 2.1093 IC RSS-102

## APPENDIX C - MEASURED FLUID DIELECTRIC PARAMETERS

<b>Applicant:</b>	<b>Itronix Corporation</b>	<b>FCC ID:</b>	<b>KBCIX325-IWL</b>	<b>IC ID:</b>	<b>1943A-IX325a</b>	
<b>Model:</b>	<b>IX325-IWL</b>	<b>Type:</b>	<b>Rugged Tablet PC with Intel Pro 2200BG 802.11b/g WLAN Mini-PCI Card</b>			
2005 Celltech Labs Inc.		This document is not to be reproduced in whole or in part without the written permission of Celltech Labs Inc.				29 of 42

Test Report Serial No.:	060605KBC-T643-S15W	Issue Date:	Aug. 4, 2005
Dates of Evaluation:	June 9, 23, July 15, 2005	Report Issue:	Issue 1 Rev0
Type of Evaluation:	RF Exposure	SAR	FCC 2.1093 IC RSS-102

## 2450 MHz DUT Evaluation (Body)

\*\*\*\*\*

Celltech Labs Inc.

Test Result for UIM Dielectric Parameter

Thu 09/Jun/2005

Freq Frequency(GHz)

FCC\_eH FCC Bulletin 65 Supplement C ( June 2001) Limits for Head Epsilon

FCC\_sH FCC Bulletin 65 Supplement C (June 2001) Limits for Head Sigma

FCC\_eB FCC Limits for Body Epsilon

FCC\_sB FCC Limits for Body Sigma

Test\_e Epsilon of UIM

Test\_s Sigma of UIM

\*\*\*\*\*

Freq	FCC_eB	FCC_sB	Test_e	Test_s
2.3500	52.83	1.85	51.45	1.82
2.3600	52.82	1.86	51.45	1.84
2.3700	52.81	1.87	51.37	1.87
2.3800	52.79	1.88	51.40	1.88
2.3900	52.78	1.89	51.26	1.90
2.4000	52.77	1.90	51.29	1.89
2.4100	52.75	1.91	51.19	1.93
2.4200	52.74	1.92	51.25	1.93
2.4300	52.73	1.93	51.33	1.96
2.4400	52.71	1.94	51.17	1.96
2.4500	52.70	1.95	51.23	1.99
2.4600	52.69	1.96	51.05	1.98
2.4700	52.67	1.98	50.99	2.00
2.4800	52.66	1.99	51.08	2.01
2.4900	52.65	2.01	50.82	2.04
2.5000	52.64	2.02	50.76	2.04
2.5100	52.62	2.04	50.83	2.06
2.5200	52.61	2.05	50.83	2.07
2.5300	52.60	2.06	50.72	2.08
2.5400	52.59	2.08	50.79	2.09
2.5500	52.57	2.09	50.79	2.11

Test Report Serial No.:	060605KBC-T643-S15W	Issue Date:	Aug. 4, 2005
Dates of Evaluation:	June 9, 23, July 15, 2005	Report Issue:	Issue 1 Rev0
Type of Evaluation:	RF Exposure	SAR	FCC 2.1093 IC RSS-102

### 2450 MHz System Performance Check (Brain)

\*\*\*\*\*

Celltech Labs Inc.

Test Result for UIM Dielectric Parameter

Thu 09/Jun/2005

Freq Frequency(GHz)

FCC\_eH FCC OET 65 Supplement C (June 2001) Limits for Head Epsilon

FCC\_sH FCC OET 65 Supplement C (June 2001) Limits for Head Sigma

Test\_e Epsilon of UIM

Test\_s Sigma of UIM

\*\*\*\*\*

Freq	FCC_eH	FCC_sH	Test_e	Test_s
2.3500	39.38	1.71	38.04	1.75
2.3600	39.36	1.72	37.94	1.78
2.3700	39.34	1.73	37.91	1.78
2.3800	39.32	1.74	37.86	1.80
2.3900	39.31	1.75	37.74	1.82
2.4000	39.29	1.76	37.71	1.82
2.4100	39.27	1.76	37.74	1.84
2.4200	39.25	1.77	37.66	1.85
2.4300	39.24	1.78	37.56	1.84
2.4400	39.22	1.79	37.57	1.87
2.4500	39.20	1.80	37.44	1.87
2.4600	39.19	1.81	37.48	1.89
2.4700	39.17	1.82	37.30	1.90
2.4800	39.16	1.83	37.26	1.90
2.4900	39.15	1.84	37.15	1.92
2.5000	39.14	1.85	37.13	1.93
2.5100	39.12	1.87	37.08	1.94
2.5200	39.11	1.88	36.97	1.96
2.5300	39.10	1.89	37.02	1.96
2.5400	39.09	1.90	37.00	1.97
2.5500	39.07	1.91	36.89	1.99

Test Report Serial No.:	060605KBC-T643-S15W	Issue Date:	Aug. 4, 2005
Dates of Evaluation:	June 9, 23, July 15, 2005	Report Issue:	Issue 1 Rev0
Type of Evaluation:	RF Exposure	SAR	FCC 2.1093 IC RSS-102

## 2450 MHz System Performance Check & DUT Evaluation (Body)

\*\*\*\*\*

Celltech Labs Inc.

Test Result for UIM Dielectric Parameter

Thu 23/Jun/2005

Freq Frequency(GHz)

FCC\_eH FCC Bulletin 65 Supplement C ( June 2001) Limits for Head Epsilon

FCC\_sH FCC Bulletin 65 Supplement C (June 2001) Limits for Head Sigma

FCC\_eB FCC Limits for Body Epsilon

FCC\_sB FCC Limits for Body Sigma

Test\_e Epsilon of UIM

Test\_s Sigma of UIM

\*\*\*\*\*

Freq	FCC_eB	FCC_sB	Test_e	Test_s
2.3500	52.83	1.85	50.96	1.79
2.3600	52.82	1.86	50.74	1.84
2.3700	52.81	1.87	50.79	1.87
2.3800	52.79	1.88	50.90	1.87
2.3900	52.78	1.89	50.94	1.88
2.4000	52.77	1.90	50.68	1.87
2.4100	52.75	1.91	50.61	1.94
2.4200	52.74	1.92	50.91	1.96
2.4300	52.73	1.93	50.40	1.93
2.4400	52.71	1.94	50.47	1.96
2.4500	52.70	1.95	50.21	1.95
2.4600	52.69	1.96	50.77	1.99
2.4700	52.67	1.98	50.37	1.98
2.4800	52.66	1.99	50.51	2.00
2.4900	52.65	2.01	50.30	1.99
2.5000	52.64	2.02	50.43	2.00
2.5100	52.62	2.04	50.08	2.06
2.5200	52.61	2.05	50.31	2.01
2.5300	52.60	2.06	50.40	2.11
2.5400	52.59	2.08	50.24	2.06
2.5500	52.57	2.09	50.46	2.07



Test Report Serial No.:	060605KBC-T643-S15W	Issue Date:	Aug. 4, 2005
Dates of Evaluation:	June 9, 23, July 15, 2005	Report Issue:	Issue 1 Rev0
Type of Evaluation:	RF Exposure	SAR	FCC 2.1093 IC RSS-102

## 2450 MHz System Performance Check & DUT Evaluation (Body)

\*\*\*\*\*

Celltech Labs Inc.

Test Result for UIM Dielectric Parameter

Fri 15/Jul/2005

Freq Frequency(GHz)

FCC\_eH FCC Bulletin 65 Supplement C ( June 2001) Limits for Head Epsilon

FCC\_sH FCC Bulletin 65 Supplement C (June 2001) Limits for Head Sigma

FCC\_eB FCC Limits for Body Epsilon

FCC\_sB FCC Limits for Body Sigma

Test\_e Epsilon of UIM

Test\_s Sigma of UIM

\*\*\*\*\*

Freq	FCC_eB	FCC_sB	Test_e	Test_s
2.3500	52.83	1.85	50.78	1.81
2.3600	52.82	1.86	50.76	1.79
2.3700	52.81	1.87	50.82	1.80
2.3800	52.79	1.88	50.28	1.83
2.3900	52.78	1.89	50.51	1.84
2.4000	52.77	1.90	50.86	1.88
2.4100	52.75	1.91	50.69	1.90
2.4200	52.74	1.92	50.44	1.86
2.4300	52.73	1.93	50.61	1.90
2.4400	52.71	1.94	50.84	1.90
2.4500	52.70	1.95	50.65	1.92
2.4600	52.69	1.96	50.33	1.96
2.4700	52.67	1.98	50.82	1.93
2.4800	52.66	1.99	50.09	1.98
2.4900	52.65	2.01	50.68	1.98
2.5000	52.64	2.02	50.15	2.01
2.5100	52.62	2.04	50.32	2.04
2.5200	52.61	2.05	50.10	2.03
2.5300	52.60	2.06	50.42	2.04
2.5400	52.59	2.08	50.11	2.05
2.5500	52.57	2.09	50.00	2.08

Test Report Serial No.:	060605KBC-T643-S15W	Issue Date:	Aug. 4, 2005
Dates of Evaluation:	June 9, 23, July 15, 2005	Report Issue:	Issue 1 Rev0
Type of Evaluation:	RF Exposure	SAR	FCC 2.1093 IC RSS-102

## APPENDIX D - SAR TEST SETUP PHOTOGRAPHS

<b>Applicant:</b>	Itronix Corporation	<b>FCC ID:</b>	KBCIX325-IWL	<b>IC ID:</b>	1943A-IX325a	
<b>Model:</b>	IX325-IWL	<b>Type:</b>	Rugged Tablet PC with Intel Pro 2200BG 802.11b/g WLAN Mini-PCI Card			
2005 Celltech Labs Inc.		This document is not to be reproduced in whole or in part without the written permission of Celltech Labs Inc.				34 of 42

Test Report Serial No.:	060605KBC-T643-S15W	Issue Date:	Aug. 4, 2005
Dates of Evaluation:	June 9, 23, July 15, 2005	Report Issue:	Issue 1 Rev0
Type of Evaluation:	RF Exposure	SAR	FCC 2.1093 IC RSS-102

**BODY SAR TEST SETUP PHOTOGRAPHS**  
**0.0 cm Separation Distance from Bottom of DUT to Planar Phantom**  
**Internal Lithium-ion Battery Pack (Model: T8M-E)**

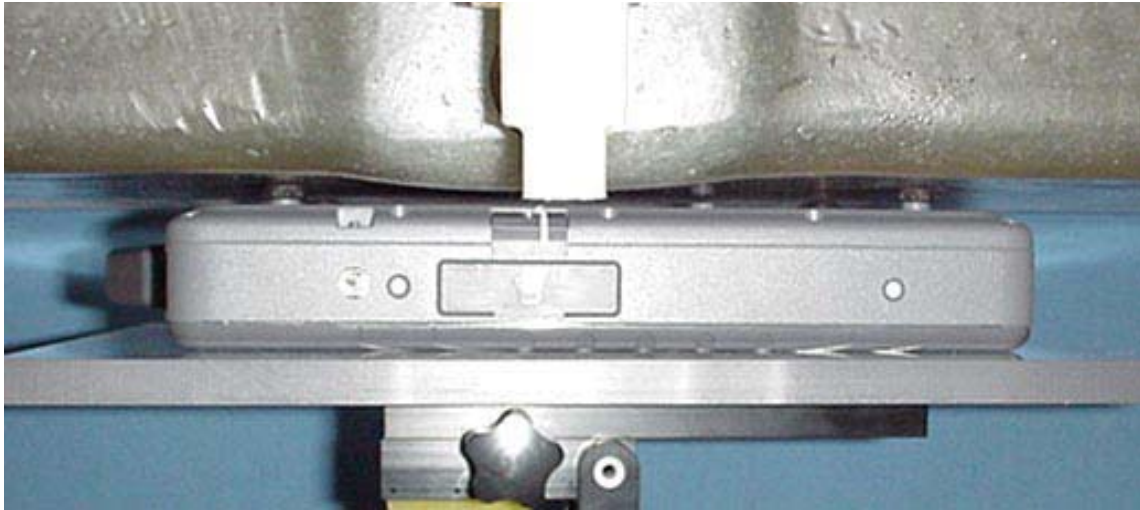

<b>Applicant:</b>	<b>Itronix Corporation</b>	<b>FCC ID:</b>	<b>KBCIX325-IWL</b>	<b>IC ID:</b>	<b>1943A-IX325a</b>	
<b>Model:</b>	<b>IX325-IWL</b>	<b>Type:</b>	<b>Rugged Tablet PC with Intel Pro 2200BG 802.11b/g WLAN Mini-PCI Card</b>			
2005 Celltech Labs Inc.		This document is not to be reproduced in whole or in part without the written permission of Celltech Labs Inc.				35 of 42

Test Report Serial No.:	060605KBC-T643-S15W	Issue Date:	Aug. 4, 2005
Dates of Evaluation:	June 9, 23, July 15, 2005	Report Issue:	Issue 1 Rev0
Type of Evaluation:	RF Exposure	SAR	FCC 2.1093 IC RSS-102

**BODY SAR TEST SETUP PHOTOGRAPHS**  
**0.0 cm Separation Distance from Bottom of DUT to Planar Phantom**  
**75 W AC Power Adapter (Delta Electronics Model: ADP-75FB B)**

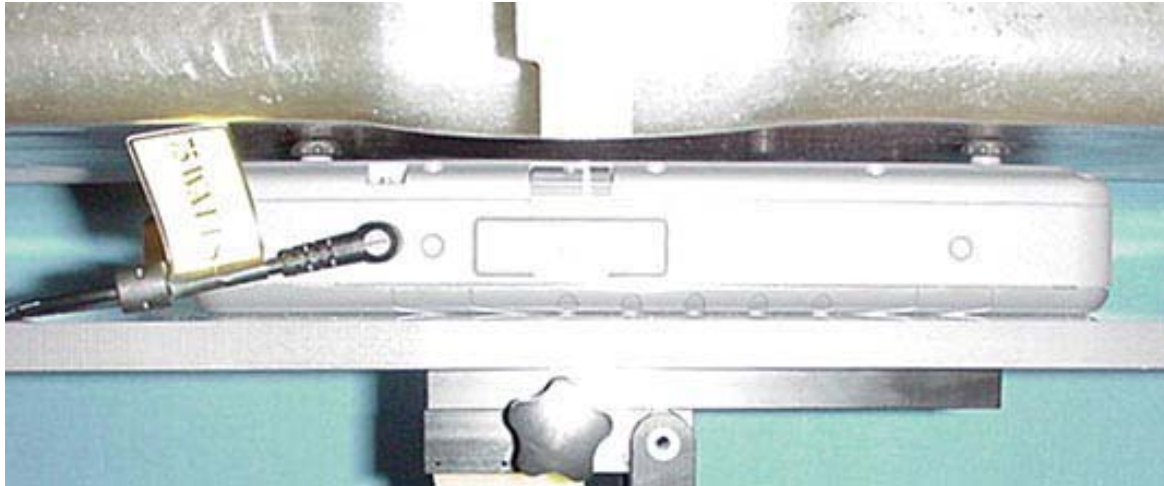

<b>Applicant:</b>	<b>Itronix Corporation</b>	<b>FCC ID:</b>	<b>KBCIX325-IWL</b>	<b>IC ID:</b>	<b>1943A-IX325a</b>	
<b>Model:</b>	<b>IX325-IWL</b>	<b>Type:</b>	<b>Rugged Tablet PC with Intel Pro 2200BG 802.11b/g WLAN Mini-PCI Card</b>			
2005 Celltech Labs Inc.		This document is not to be reproduced in whole or in part without the written permission of Celltech Labs Inc.				36 of 42

Test Report Serial No.:	060605KBC-T643-S15W	Issue Date:	Aug. 4, 2005
Dates of Evaluation:	June 9, 23, July 15, 2005	Report Issue:	Issue 1 Rev0
Type of Evaluation:	RF Exposure	SAR	FCC 2.1093 IC RSS-102

**BODY SAR TEST SETUP PHOTOGRAPHS**  
**0.0 cm Separation Distance from Antenna Edge of DUT to Planar Phantom**  
**Internal Lithium-ion Battery Pack (Model: T8M-E)**

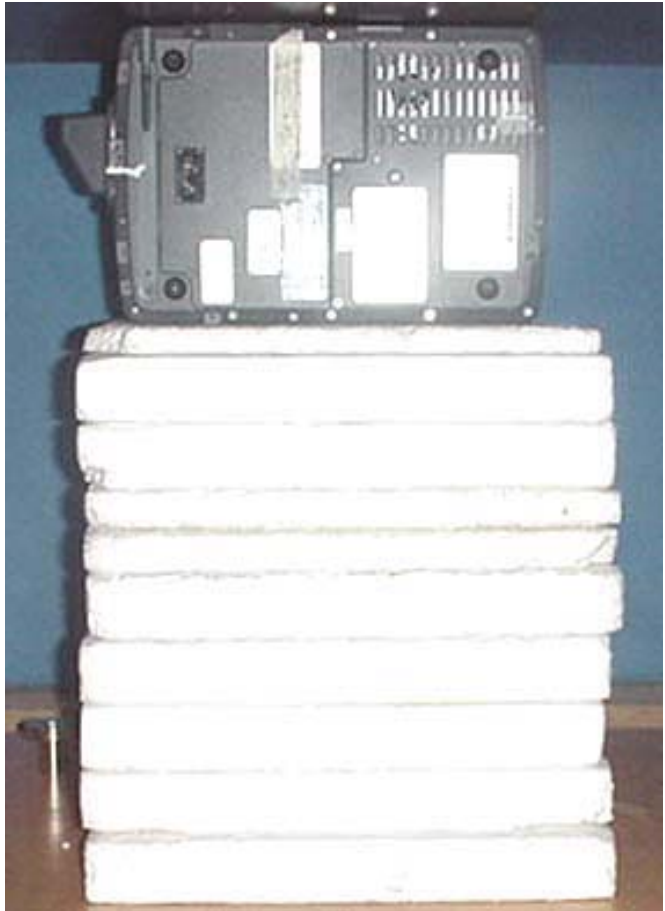

<b>Applicant:</b>	<b>Itronix Corporation</b>	<b>FCC ID:</b>	<b>KBCIX325-IWL</b>	<b>IC ID:</b>	<b>1943A-IX325a</b>	
<b>Model:</b>	<b>IX325-IWL</b>	<b>Type:</b>	<b>Rugged Tablet PC with Intel Pro 2200BG 802.11b/g WLAN Mini-PCI Card</b>			
2005 Celltech Labs Inc.		This document is not to be reproduced in whole or in part without the written permission of Celltech Labs Inc.				37 of 42

Test Report Serial No.:	060605KBC-T643-S15W	Issue Date:	Aug. 4, 2005
Dates of Evaluation:	June 9, 23, July 15, 2005	Report Issue:	Issue 1 Rev0
Type of Evaluation:	RF Exposure	SAR	FCC 2.1093 IC RSS-102

**BODY SAR TEST SETUP PHOTOGRAPHS**  
**0.0 cm Separation Distance from Antenna Edge of DUT to Planar Phantom**  
**75 W AC Power Adapter (Delta Electronics Model: ADP-75FB B)**

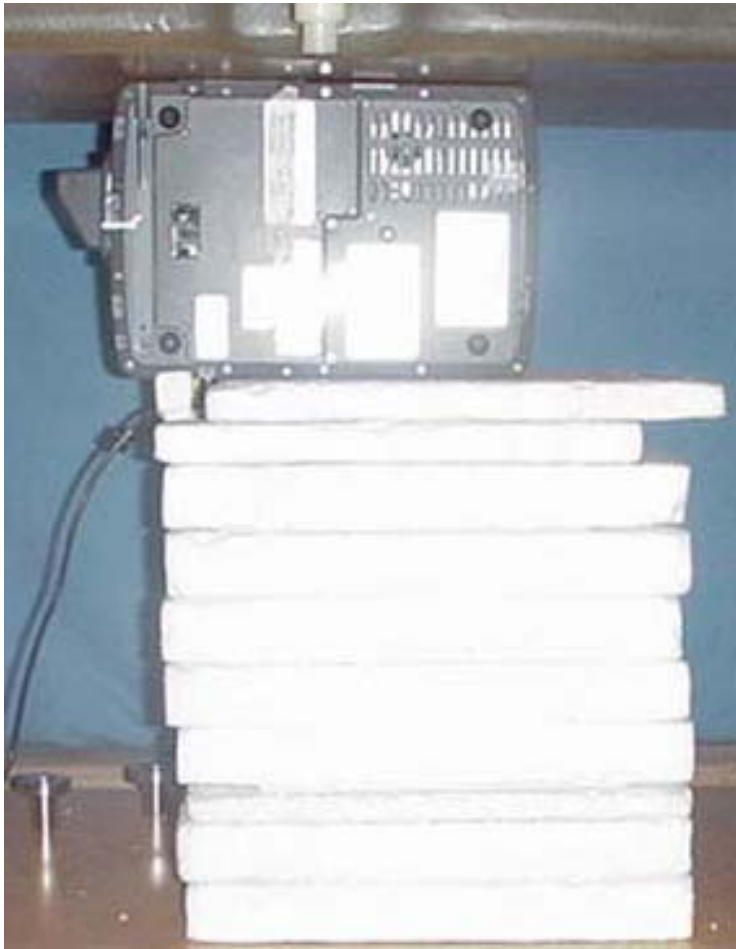

<b>Applicant:</b>	<b>Itronix Corporation</b>	<b>FCC ID:</b>	<b>KBCIX325-IWL</b>	<b>IC ID:</b>	<b>1943A-IX325a</b>	
<b>Model:</b>	<b>IX325-IWL</b>	<b>Type:</b>	<b>Rugged Tablet PC with Intel Pro 2200BG 802.11b/g WLAN Mini-PCI Card</b>			
2005 Celltech Labs Inc.		This document is not to be reproduced in whole or in part without the written permission of Celltech Labs Inc.				38 of 42

Test Report Serial No.:	060605KBC-T643-S15W	Issue Date:	Aug. 4, 2005
Dates of Evaluation:	June 9, 23, July 15, 2005	Report Issue:	Issue 1 Rev0
Type of Evaluation:	RF Exposure	SAR	FCC 2.1093 IC RSS-102

## APPENDIX E - SYSTEM VALIDATION

<b>Applicant:</b>	<b>Itronix Corporation</b>	<b>FCC ID:</b>	<b>KBCIX325-IWL</b>	<b>IC ID:</b>	<b>1943A-IX325a</b>	
<b>Model:</b>	<b>IX325-IWL</b>	<b>Type:</b>	<b>Rugged Tablet PC with Intel Pro 2200BG 802.11b/g WLAN Mini-PCI Card</b>			
2005 Celltech Labs Inc.		This document is not to be reproduced in whole or in part without the written permission of Celltech Labs Inc.				39 of 42

## 2450 MHz SYSTEM VALIDATION DIPOLE

Type:

2450 MHz Validation Dipole

Serial Number:

150

Place of Calibration:

Celltech Labs Inc.

Date of Calibration:

September 30, 2004

Celltech Labs Inc. hereby certifies that this device has been calibrated on the date indicated above.

Calibrated by:

*Spencer Watson*

Approved by:

*Russell W. Pipe*



## 1. Dipole Construction & Electrical Characteristics

The validation dipole was constructed in accordance with the IEEE Std “Recommended Practice for Determining the Spatial-Peak Specific Absorption Rate (SAR) in the Human Body Due to Wireless Communications Devices: Experimental Techniques”. The electrical properties were measured using an HP 8753E Network Analyzer. The network analyzer was calibrated to the validation dipole N-type connector feed point using an HP85032E Type N calibration kit. The dipole was placed parallel to a planar phantom at a separation distance of 10.0mm from the simulating fluid using a loss-less dielectric spacer. The measured input impedance is:

Feed point impedance at 2450 MHz	$\text{Re}\{Z\} = 48.246\Omega$
	$\text{Im}\{Z\} = 1.0996\Omega$
Return Loss at 2450 MHz	-33.519 dB

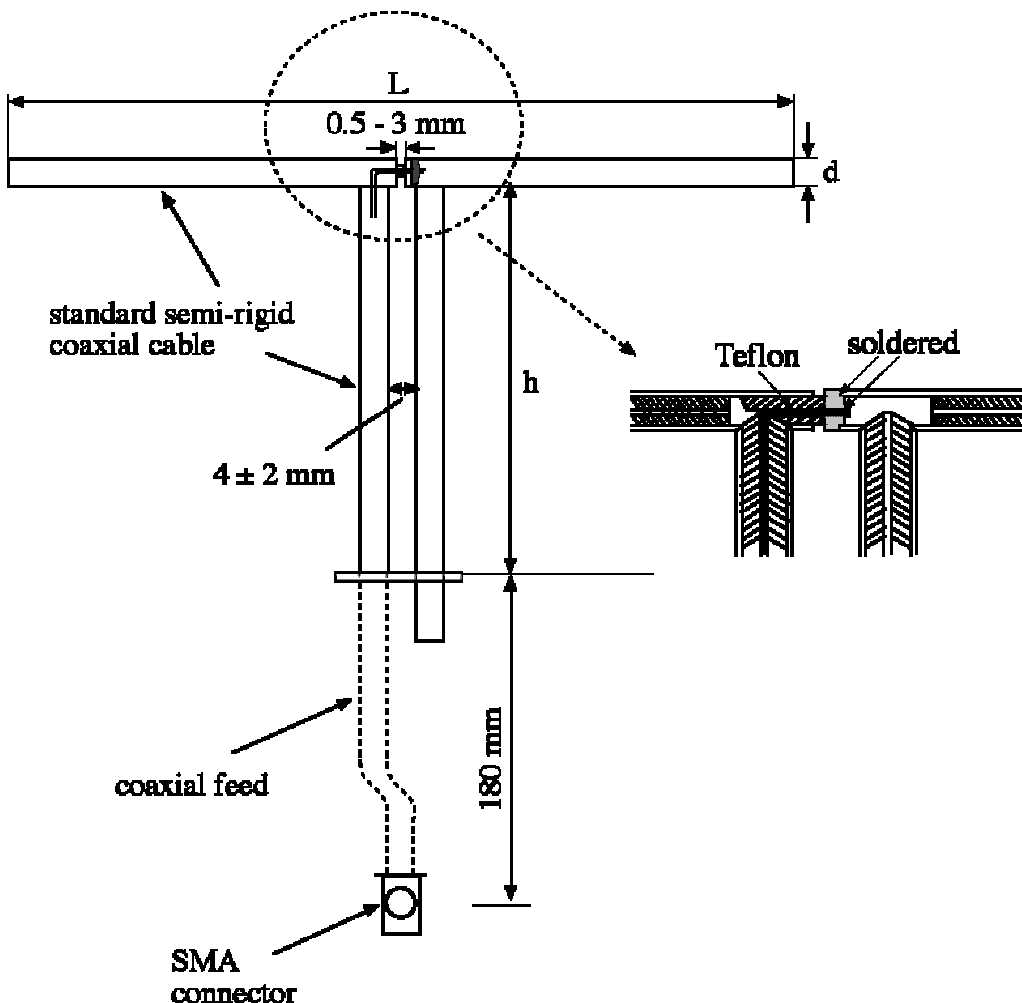

30 Sep 2004 16:29:23

MEM 1 U FS 1: 48.246  $\Omega$  1.0996  $\Omega$  71.432 pH 2 450.000 000 MHz

PRm

Cor

↑

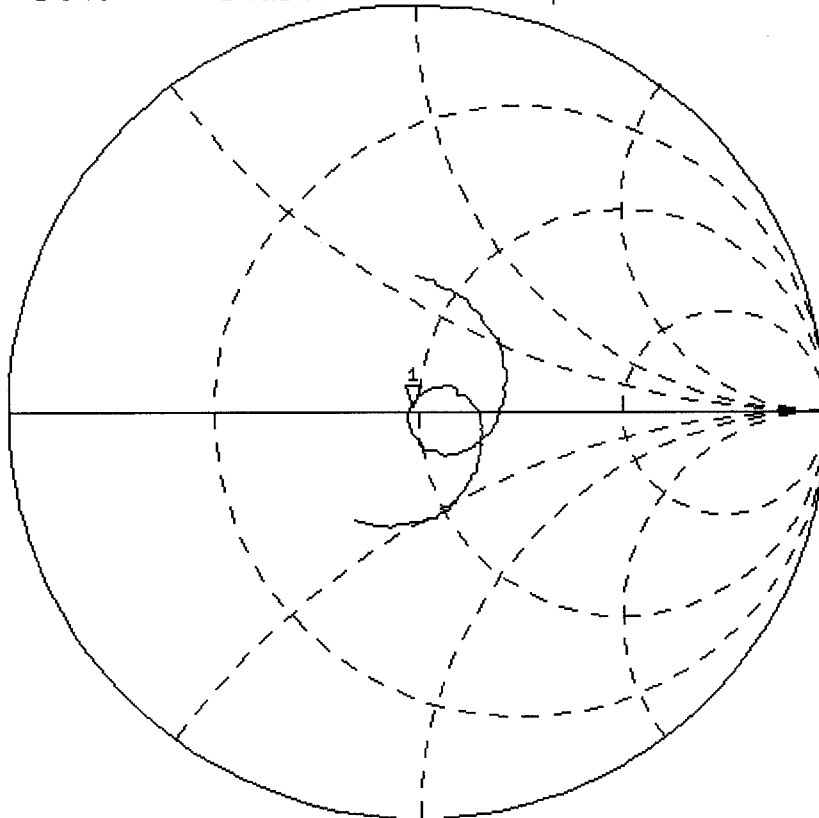

CENTER 2 450.000 000 MHz

SPAN 400.000 000 MHz

30 Sep 2004 16:28:38

CH1 MEM LOG 10 dB/REF 0 dB 1:-33.519 dB 2 450.000 000 MHz

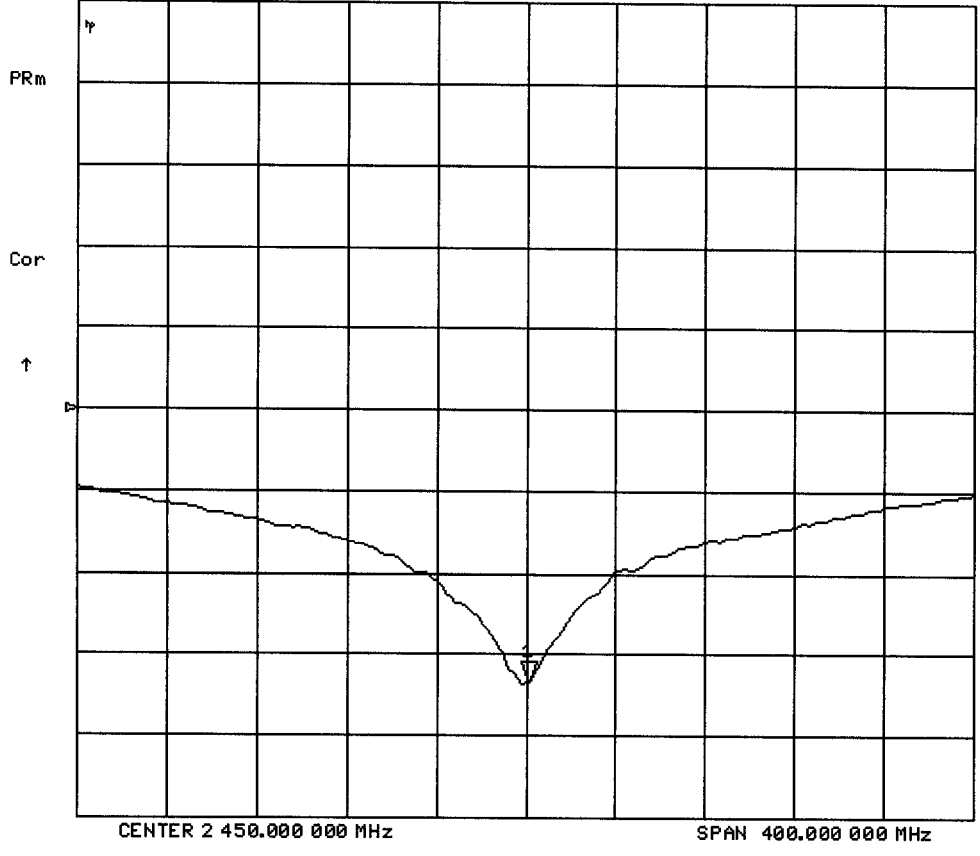

## 2. Validation Dipole Dimensions

Frequency (MHz)	L (mm)	h (mm)	d (mm)
300	420.0	250.0	6.2
450	288.0	167.0	6.2
835	161.0	89.8	3.6
900	149.0	83.3	3.6
1450	89.1	51.7	3.6
1800	72.0	41.7	3.6
1900	68.0	39.5	3.6
2000	64.5	37.5	3.6
2450	51.8	30.6	3.6
3000	41.5	25.0	3.6

## 3. Validation Phantom

The validation phantom is the SAM (Specific Anthropomorphic Mannequin) phantom manufactured by Schmid & Partner Engineering AG. The SAM phantom is a Fiberglass shell integrated in a wooden table. The shape of the shell corresponds to the phantom defined by SCC34-SC2. It enables the dosimetric evaluation of left and right hand phone usage as well as body mounted usage at the flat phantom region. A cover prevents evaporation of the liquid. Reference markings on the phantom allow the complete setup of all predefined phantom positions and measurement grids by manually teaching three points in the robot.

**Shell Thickness:** 2.0 ± 0.1 mm  
**Filling Volume:** Approx. 25 liters  
**Dimensions:** 50 cm (W) x 100 cm (L)

**4. 2450 MHz System Validation Setup**



**5. 2450 MHz Dipole Setup**



## 6. Measurement Conditions

The phantom was filled with brain simulating tissue having the following electrical parameters at 2450 MHz:

Relative Permittivity: 38.5  
 Conductivity: 1.86 mho/m  
 Fluid Temperature: 23.7 °C  
 Fluid Depth: ≥ 15.0 cm

Environmental Conditions:

Ambient Temperature: 25.3 °C  
 Humidity: 32 %  
 Barometric Pressure: 102.7 kPa

The 2450 MHz simulated brain tissue mixture consists of the following ingredients:

Ingredient	Percentage by weight
Water	52.00%
Glycol Monobutyl	48.00%
Target Dielectric Parameters at 22°C	$\epsilon_r = 39.2$ (+/-5%) $\sigma = 1.80$ S/m (+/-5%)

## 7. SAR Measurement

The SAR measurement was performed with the E-field probe in mechanical detection mode only. The setup and determination of the forward power into the dipole was performed using the following procedures.

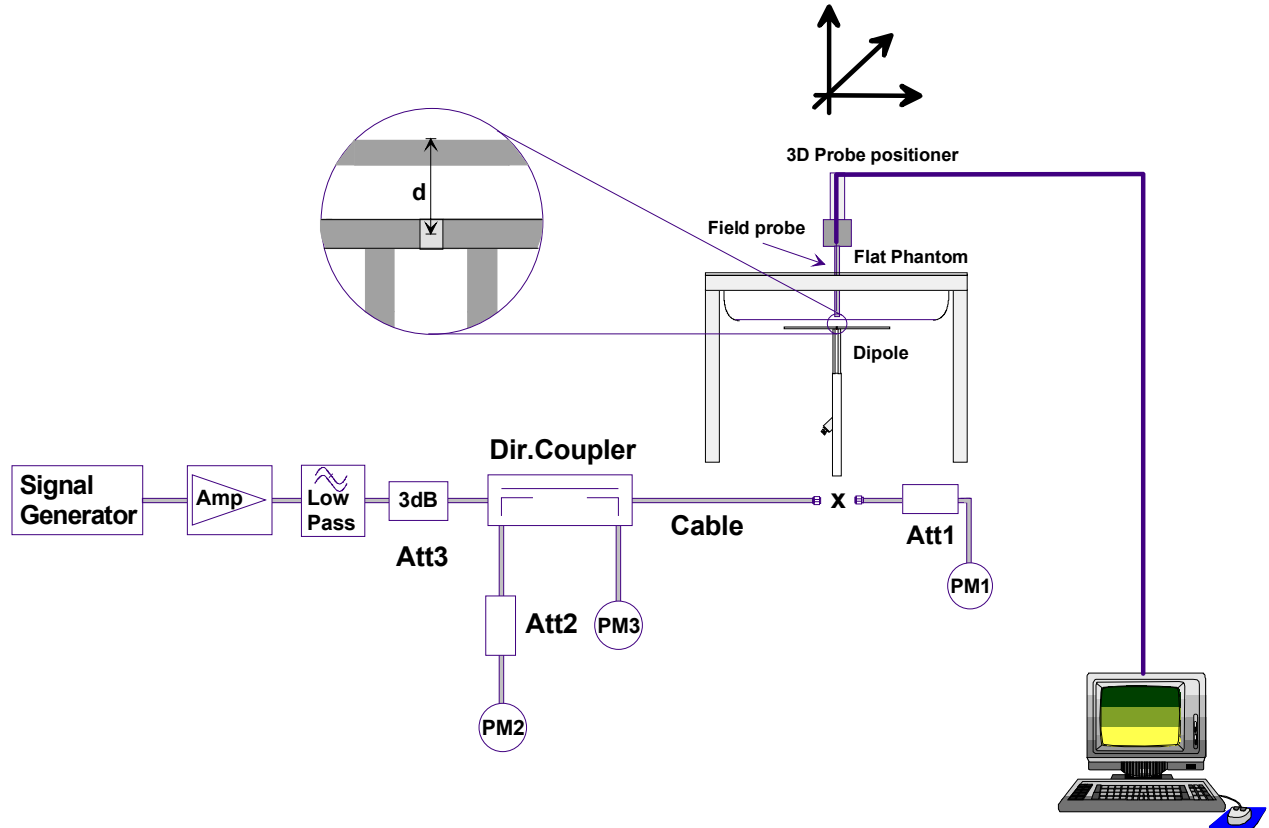

First, the power meter PM1 (including attenuator Att1) is connected to the cable to measure the forward power at the location of the dipole connector (X). The signal generator is adjusted for the desired forward power at the dipole connector (taking into account the attenuation of Att1) as read by power meter PM2. After connecting the cable to the dipole, the signal generator is readjusted for the same reading at power meter PM2. If the signal generator does not allow adjustment in 0.01dB steps, the remaining difference at PM2 must be taken into consideration. PM3 records the reflected power from the dipole to ensure that the value is not changed from the previous value. The reflected power should be 20dB below the forward power.



## 8. Validation Dipole SAR Test Results

Ten SAR measurements were performed in order to achieve repeatability and to establish an average target value.

Validation Measurement	SAR @ 0.25W Input averaged over 1g	SAR @ 1W Input averaged over 1g	SAR @ 0.25W Input averaged over 10g	SAR @ 1W Input averaged over 10g	Peak SAR @ 0.25W Input
Test 1	14.2	56.8	6.58	26.32	30.4
Test 2	14.1	56.4	6.54	26.16	30.2
Test 3	14.1	56.4	6.54	26.16	30.4
Test 4	14.1	56.4	6.51	26.04	30.6
Test 5	14.0	56.0	6.51	26.04	29.8
Test 6	14.0	56.0	6.49	25.96	29.6
Test 7	14.1	56.4	6.54	26.16	30.0
Test 8	14.1	56.4	6.53	26.12	30.1
Test 9	14.0	56.0	6.50	26.00	29.8
Test10	14.0	56.0	6.47	25.88	30.0
Average Value	14.07	56.28	6.52	26.08	30.09

The results have been normalized to 1W (forward power) into the dipole.

IEEE Target over 1cm<sup>3</sup> (1g) of tissue: 52.4 mW/g (+/- 10%)

Averaged over 1cm (1g) of tissue: 56.28 mW/g (+ 7.4% deviation)

IEEE Target over 10cm<sup>3</sup> (10g) of tissue: 24.0 mW/g (+/- 10%)

Averaged over 10cm (10g) of tissue: 26.08 mW/g (+ 8.7% deviation)

## 2540 MHz System Validation - September 30, 2004

**DUT: Dipole 2450 MHz; Model: D2450V2; Serial: 150; Calibrated: 09/30/2004**

Ambient Temp: 25.3 °C; Fluid Temp: 23.7 °C; Barometric Pressure: 102.7 kPa; Humidity: 32%

Communication System: CW

Frequency: 2450 MHz; Duty Cycle: 1:1

Medium: HSL2450 ( $\sigma = 1.86$  mho/m;  $\epsilon_r = 38.5$ ;  $\rho = 1000$  kg/m<sup>3</sup>)

- Probe: ET3DV6 - SN1590; ConvF(4.44, 4.44, 4.44); Calibrated: 24/05/2004

- Sensor-Surface: 4mm (Mechanical And Optical Surface Detection)

- Electronics: DAE3 Sn370; Calibrated: 14/05/2004

- Phantom: SAM 4.0; Type: Fiberglass; Serial: 1033

- Measurement SW: DASY4, V4.3 Build 22; Postprocessing SW: SEMCAD, V1.8 Build 127

**2450 MHz System Validation/Area Scan (6x10x1):** Measurement grid: dx=10mm, dy=10mm

**2450 MHz System Validation/Zoom Scan (7x7x7)/Cube 0:** Measurement grid: dx=5mm, dy=5mm, dz=5mm

Reference Value = 96.9 V/m; Power Drift = 0.0 dB

Peak SAR (extrapolated) = 30.4 W/kg

**SAR(1 g) = 14.2 mW/g; SAR(10 g) = 6.58 mW/g**

**2450 MHz System Validation/Zoom Scan 2 (7x7x7)/Cube 0:** Measurement grid: dx=5mm, dy=5mm, dz=5mm

Reference Value = 96.9 V/m; Power Drift = -0.002 dB

Peak SAR (extrapolated) = 30.2 W/kg

**SAR(1 g) = 14.1 mW/g; SAR(10 g) = 6.54 mW/g**

**2450 MHz System Validation/Zoom Scan 3 (7x7x7)/Cube 0:** Measurement grid: dx=5mm, dy=5mm, dz=5mm

Reference Value = 96.5 V/m; Power Drift = -0.001 dB

Peak SAR (extrapolated) = 30.4 W/kg

**SAR(1 g) = 14.1 mW/g; SAR(10 g) = 6.54 mW/g**

**2450 MHz System Validation/Zoom Scan 4 (7x7x7)/Cube 0:** Measurement grid: dx=5mm, dy=5mm, dz=5mm

Reference Value = 94.1 V/m; Power Drift = 0.008 dB

Peak SAR (extrapolated) = 30.6 W/kg

**SAR(1 g) = 14.1 mW/g; SAR(10 g) = 6.51 mW/g**

**2450 MHz System Validation/Zoom Scan 5 (7x7x7)/Cube 0:** Measurement grid: dx=5mm, dy=5mm, dz=5mm

Reference Value = 96.9 V/m; Power Drift = -0.009 dB

Peak SAR (extrapolated) = 29.8 W/kg

**SAR(1 g) = 14.0 mW/g; SAR(10 g) = 6.51 mW/g**

**2450 MHz System Validation/Zoom Scan 6 (7x7x7)/Cube 0:** Measurement grid: dx=5mm, dy=5mm, dz=5mm

Reference Value = 96.4 V/m; Power Drift = -0.0 dB

Peak SAR (extrapolated) = 29.6 W/kg

**SAR(1 g) = 14.0 mW/g; SAR(10 g) = 6.49 mW/g**

**2450 MHz System Validation/Zoom Scan 7 (7x7x7)/Cube 0:** Measurement grid: dx=5mm, dy=5mm, dz=5mm

Reference Value = 96.4 V/m; Power Drift = -0.008 dB

Peak SAR (extrapolated) = 30 W/kg

**SAR(1 g) = 14.1 mW/g; SAR(10 g) = 6.54 mW/g**

**2450 MHz System Validation/Zoom Scan 8 (7x7x7)/Cube 0:** Measurement grid: dx=5mm, dy=5mm, dz=5mm

Reference Value = 96.4 V/m; Power Drift = -0.004 dB

Peak SAR (extrapolated) = 30.1 W/kg

**SAR(1 g) = 14.1 mW/g; SAR(10 g) = 6.53 mW/g**

**2450 MHz System Validation/Zoom Scan 9 (7x7x7)/Cube 0:** Measurement grid: dx=5mm, dy=5mm, dz=5mm

Reference Value = 96.3 V/m; Power Drift = -0.0 dB

Peak SAR (extrapolated) = 29.8 W/kg

**SAR(1 g) = 14.0 mW/g; SAR(10 g) = 6.5 mW/g**

**2450 MHz System Validation/Zoom Scan 10 (7x7x7)/Cube 0:** Measurement grid: dx=5mm, dy=5mm, dz=5mm

Reference Value = 96.4 V/m; Power Drift = -0.1 dB

Peak SAR (extrapolated) = 30 W/kg

**SAR(1 g) = 14.0 mW/g; SAR(10 g) = 6.47 mW/g**

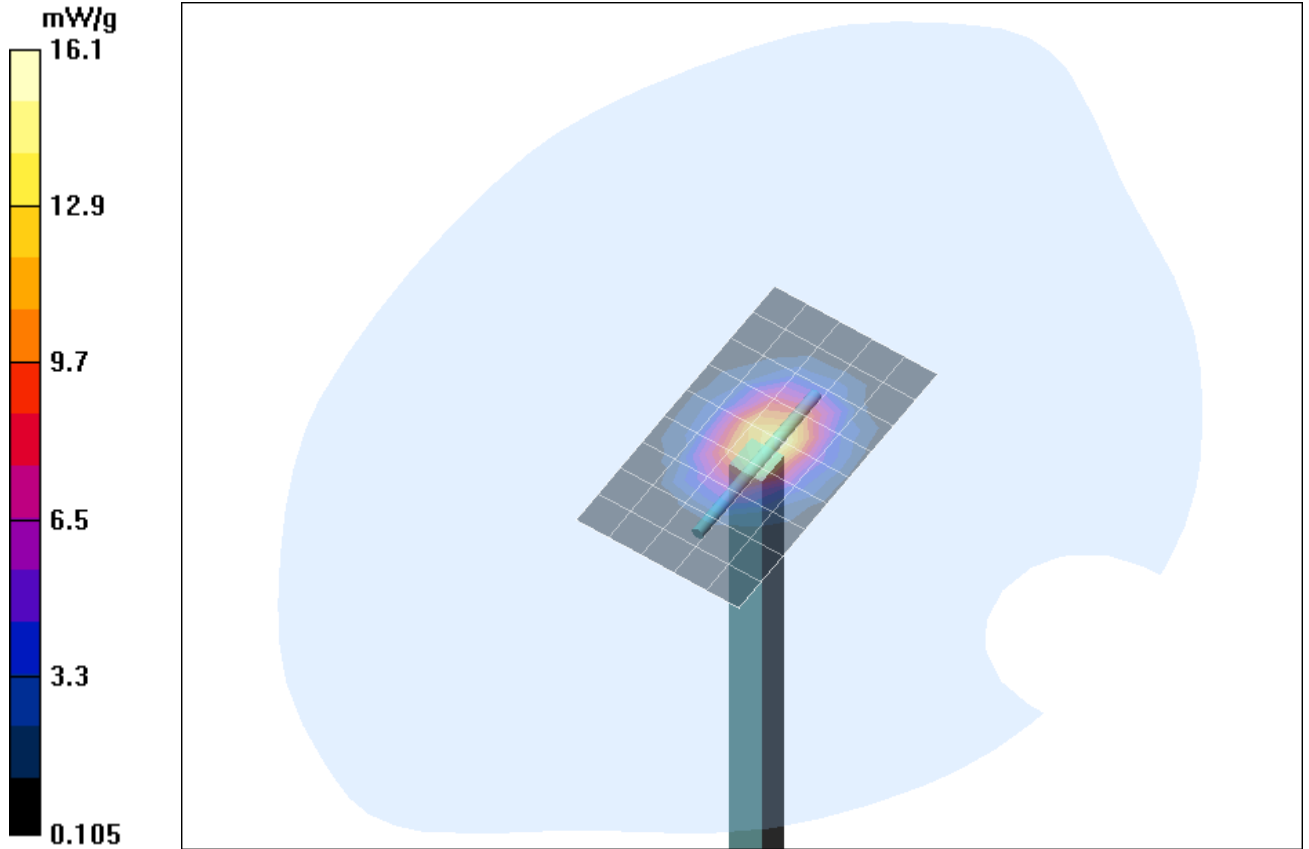

**1 g average of 10 measurements: 14.07 mW/g**  
**10 g average of 10 measurements: 6.521 mW/g**

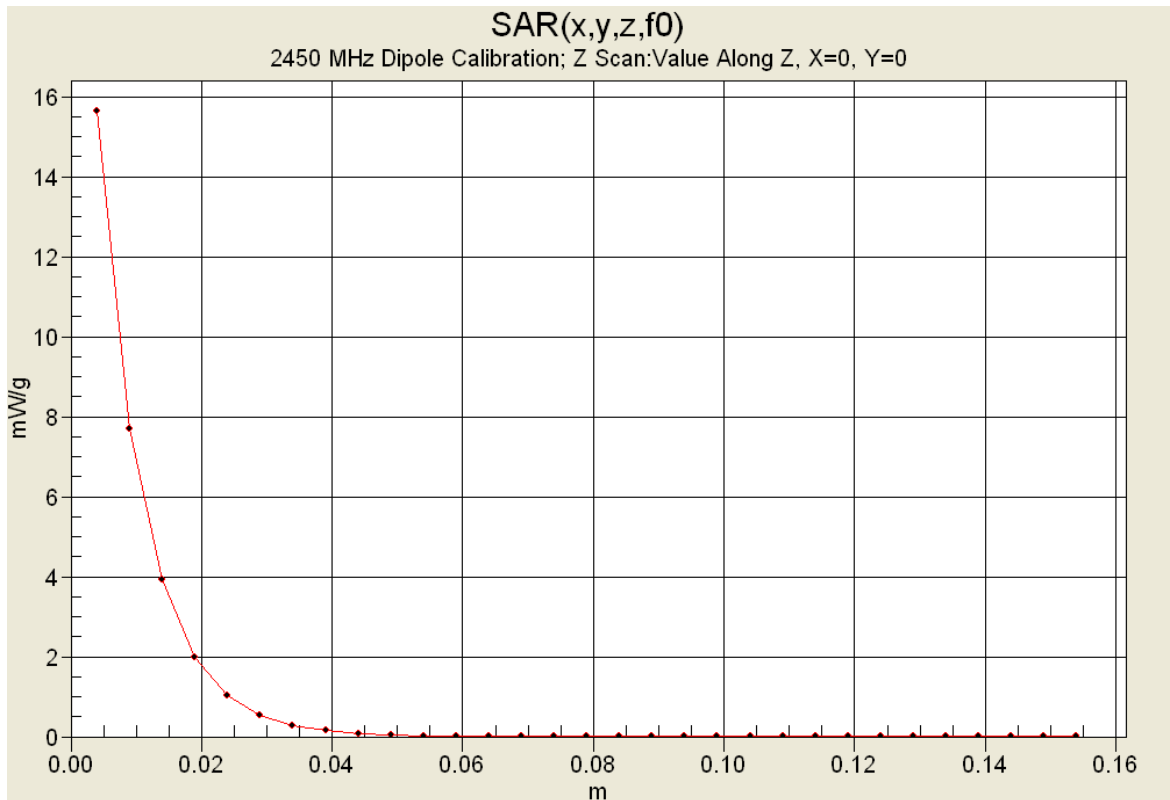

# 2450 MHz System Validation

## Measured Fluid Dielectric Parameters (Brain)

September 30, 2004

Frequency	$\epsilon'$	$\epsilon''$
2.350000000 GHz	38.9044	13.2920
2.360000000 GHz	38.8598	13.3262
2.370000000 GHz	38.8346	13.3589
2.380000000 GHz	38.7702	13.3903
2.390000000 GHz	38.7465	13.4360
2.400000000 GHz	38.6987	13.4546
2.410000000 GHz	38.6553	13.4975
2.420000000 GHz	38.6023	13.5376
2.430000000 GHz	38.5771	13.5800
2.440000000 GHz	38.5403	13.6072
2.450000000 GHz	38.5010	13.6535
2.460000000 GHz	38.4824	13.6770
2.470000000 GHz	38.4488	13.7080
2.480000000 GHz	38.4153	13.7445
2.490000000 GHz	38.3700	13.7692
2.500000000 GHz	38.3378	13.7887
2.510000000 GHz	38.2798	13.8028
2.520000000 GHz	38.2288	13.8500
2.530000000 GHz	38.1683	13.8945
2.540000000 GHz	38.1113	13.9420
2.550000000 GHz	38.0791	13.9851

## 2450 MHz SYSTEM VALIDATION DIPOLE

Type:

**2450 MHz Validation Dipole**

Serial Number:

**150**

Place of Calibration:

**Celltech Labs Inc.**

Date of Calibration:

**April 22, 2005**

**Celltech Labs Inc. hereby certifies that this device has been calibrated on the date indicated above.**

Calibrated by:



Approved by:



### 1. Dipole Construction & Electrical Characteristics

The validation dipole was constructed in accordance with the IEEE Std “Recommended Practice for Determining the Spatial-Peak Specific Absorption Rate (SAR) in the Human Body Due to Wireless Communications Devices: Experimental Techniques”. The electrical properties were measured using an HP 8753E Network Analyzer. The network analyzer was calibrated to the validation dipole N-type connector feed point using an HP85032E Type N calibration kit. The dipole was placed parallel to a planar phantom at a separation distance of 10.0mm from the simulating fluid using a loss-less dielectric spacer. The measured input impedance is:

Feed point impedance at 2450 MHz	$Re\{Z\} = 45.605\Omega$
	$Im\{Z\} = 1.1133\Omega$
Return Loss at 2450 MHz	-26.482 dB

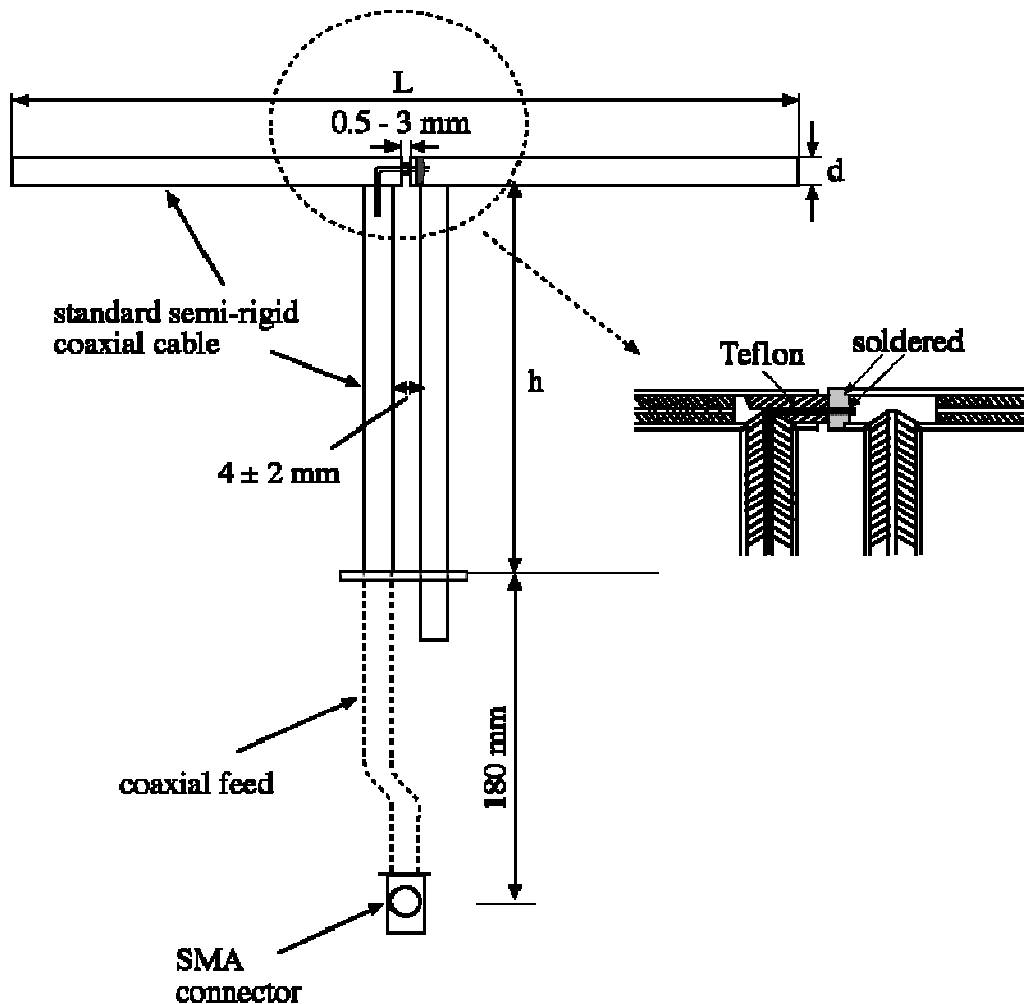

**2. Validation Dipole VSWR Data**

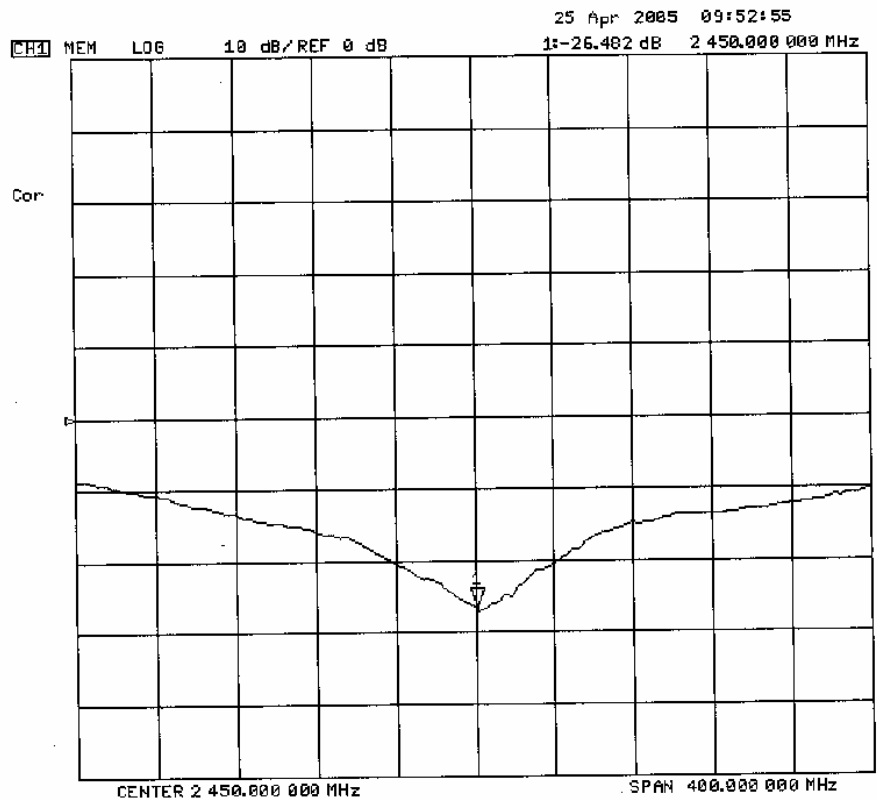
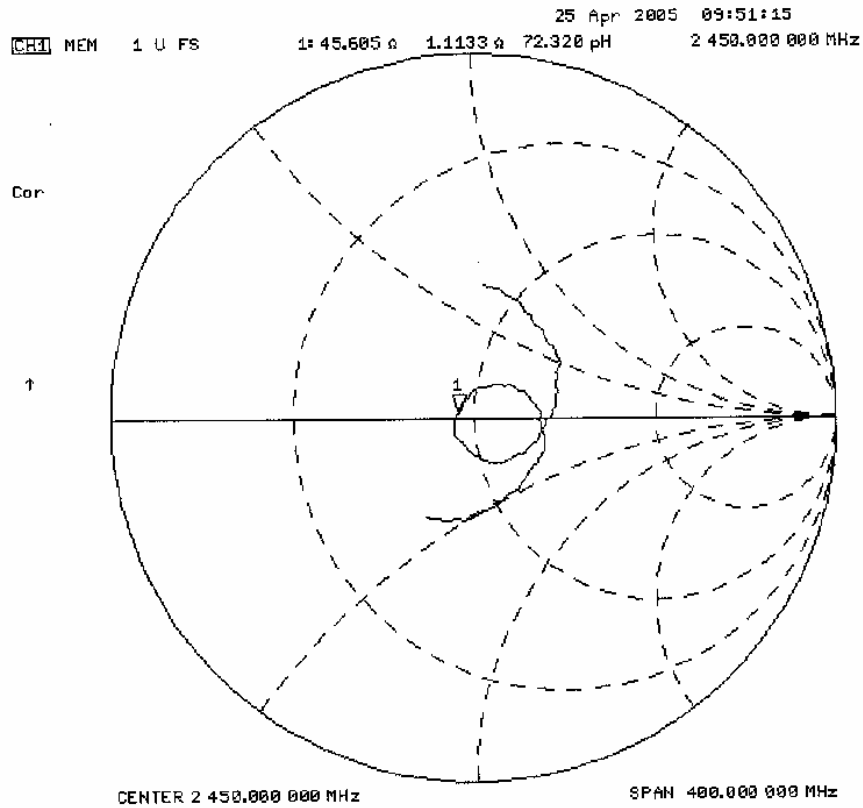

### 3. Validation Dipole Dimensions

Frequency (MHz)	L (mm)	H (mm)	D (mm)
300	420.0	250.0	6.2
450	288.0	167.0	6.2
835	161.0	89.8	3.6
900	149.0	83.3	3.6
1450	89.1	51.7	3.6
1800	72.0	41.7	3.6
1900	68.0	39.5	3.6
2000	64.5	37.5	3.6
2450	51.8	30.6	3.6
3000	41.5	25.0	3.6

### 4. Validation Phantom

The validation phantom is a Fiberglass shell planar phantom manufactured by Barski Industries Ltd. The phantom is in conformance with the requirements defined by IEEE SCC34-SC2 for the dosimetric evaluations of body-worn and lap-held operating configurations. Reference markings on the phantom allow the complete setup of all predefined phantom positions and measurement grids.

**Shell Thickness:** 2.0 ± 0.2 mm  
**Filling Volume:** Approx. 55 liters  
**Dimensions:** 44 cm (W) x 94 cm (L)



**5. 2450 MHz System Validation Setup**



**6. 2450 MHz Dipole Setup**



## 7. Measurement Conditions

The phantom was filled with 2450 MHz Body simulating tissue:

Relative Permittivity:	50.2
Conductivity:	1.97 mho/m
Fluid Temperature:	23.9 °C
Fluid Depth:	≥ 15.0 cm

Environmental Conditions:

Ambient Temperature:	25.7 °C
Humidity:	30 %
Barometric Pressure:	102.6 kPa

The 2450 MHz simulated Body tissue mixture consists of the following ingredients:

<b>Ingredient</b>	<b>Percentage by weight</b>
Water	69.98%
Glycol Monobutyl	30.00%
Salt	0.02%
Target Dielectric Parameters at 22°C	$\epsilon_r = 52.7 (+/-5\%)$ $\sigma = 1.95 \text{ S/m } (+/-5\%)$

## 8. SAR Measurement

The SAR measurement was performed with the E-field probe in mechanical detection mode only. The setup and determination of the forward power into the dipole was performed using the following procedures.

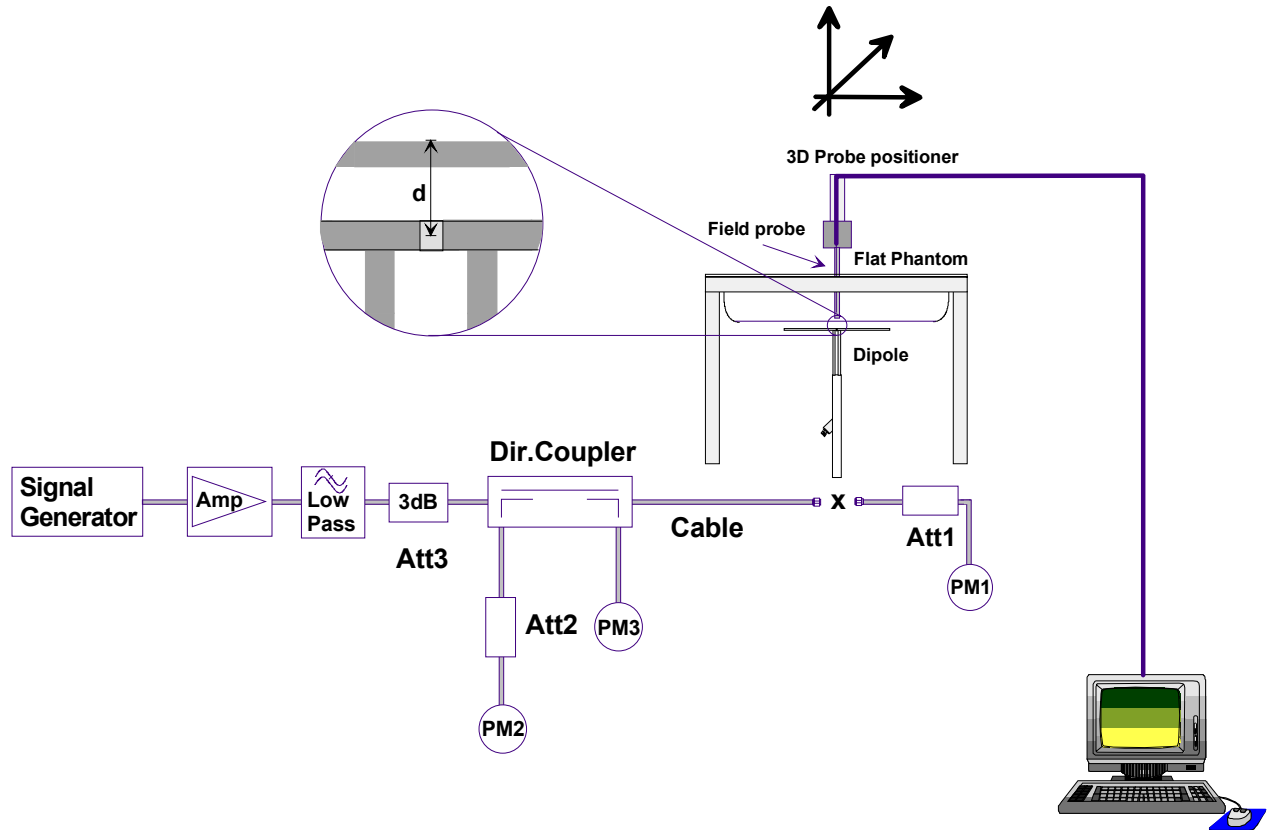

First the power meter PM1 (including attenuator Att1) is connected to the cable to measure the forward power at the location of the dipole connector (X). The signal generator is adjusted for the desired forward power at the dipole connector (taking into account the attenuation of Att1) as read by power meter PM2. After connecting the cable to the dipole, the signal generator is readjusted for the same reading at power meter PM2. If the signal generator does not allow adjustment in 0.01dB steps, the remaining difference at PM2 must be taken into consideration. PM3 records the reflected power from the dipole to ensure that the value is not changed from the previous value. The reflected power should be 20dB below the forward power.

## 9. Validation Dipole SAR Test Results

Ten SAR measurements were performed in order to achieve repeatability and to establish an average target value.

Validation Measurement	SAR @ 0.25W Input averaged over 1g	SAR @ 1W Input averaged over 1g	SAR @ 0.25W Input averaged over 10g	SAR @ 1W Input averaged over 10g	Peak SAR @ 0.25W Input
Test 1	12.6	50.4	5.86	23.44	27.7
Test 2	12.6	50.4	5.86	23.44	27.4
Test 3	12.6	50.4	5.87	23.48	27.4
Test 4	12.6	50.4	5.86	23.44	27.3
Test 5	12.6	50.4	5.86	23.44	27.4
Test 6	12.6	50.4	5.87	23.48	27.8
Test 7	12.7	50.8	5.88	23.52	27.7
Test 8	12.7	50.8	5.88	23.52	27.8
Test 9	12.6	50.4	5.87	23.48	27.6
Test10	12.7	50.8	5.88	23.52	27.7
Average Value	12.63	50.52	5.869	23.48	27.58

The results have been normalized to 1W (forward power) into the dipole.

Target SAR @ 1 Watt Input averaged over 1 gram (W/kg)		Measured SAR @ 1 Watt Input averaged over 1 gram (W/kg)	Deviation from Target (%)	Target SAR @ 1 Watt Input averaged over 10 grams (W/kg)		Measured SAR @ 1 Watt Input averaged over 10 grams (W/kg)	Deviation from Target (%)
51.2	+/- 10%	50.52	- 1.3	23.7	+/- 10%	23.48	- 0.93

Dipole Type	Distance [mm]	Frequency [MHz]	SAR (1g) [W/kg]	SAR (10g) [W/kg]	SAR (peak) [W/kg]
D300V2	15	300	3.02	2.06	4.36
D450V2	15	450	5.01	3.36	7.22
D835V2	15	835	9.71	6.38	14.1
D900V2	15	900	11.1	7.17	16.3
D1450V2	10	1450	29.6	16.6	49.8
D1500V2	10	1500	30.8	17.1	52.1
D1640V2	10	1640	34.4	18.7	59.4
D1800V2	10	1800	38.5	20.3	67.5
D1900V2	10	1900	39.8	20.8	69.6
D2000V2	10	2000	40.9	21.2	71.5
D2450V2	10	2450	51.2	23.7	97.6
D3000V2	10	3000	61.9	24.8	136.7

Table 32.1: Numerical reference SAR values for SPEAG dipoles and flat phantom filled with body-tissue simulating liquid. Note: All SAR values normalized to 1 W forward power.

## 2450 MHz System Validation - April 22, 2005

DUT: Dipole 2450 MHz; Type: D2450V2; Serial: 150; Calibrated: 04/22/2005  
Ambient Temp: 25.7 °C; Fluid Temp: 23.9 °C; Barometric Pressure: 102.6 kPa; Humidity: 30%  
Communication System: CW  
Frequency: 2450 MHz; Duty Cycle: 1:1  
Medium: M2450 Medium parameters used:  $f = 2450$  MHz;  $\sigma = 1.97$  mho/m;  $\epsilon_r = 50.2$ ;  $\rho = 1000$  kg/m<sup>3</sup>  
- Probe: ET3DV6 - SN1590; ConvF(4.22, 4.22, 4.22); Calibrated: 24/05/2004  
- Sensor-Surface: 4mm (Mechanical Surface Detection)  
- Electronics: DAE3 Sn353; Calibrated: 06/07/2004  
- Phantom: Barski Industries; Type: Fiberglass Planar; Serial: 03-01  
- Measurement SW: DASY4, V4.5 Build 19; Postprocessing SW: SEMCAD, V1.8 Build 146

**2450 MHz System Validation/Area Scan (6x10x1):** Measurement grid: dx=10mm, dy=10mm

**2450 MHz System Validation/Zoom Scan (7x7x7)/Cube 0:** Measurement grid: dx=5mm, dy=5mm, dz=5mm  
Reference Value = 88.7 V/m; Power Drift = -0.010 dB  
Peak SAR (extrapolated) = 27.7 W/kg  
**SAR(1 g) = 12.6 mW/g; SAR(10 g) = 5.86 mW/g**

**2450 MHz System Validation/Zoom Scan 2 (7x7x7)/Cube 0:** Measurement grid: dx=5mm, dy=5mm, dz=5mm  
Reference Value = 89.1 V/m; Power Drift = 0.00 dB  
Peak SAR (extrapolated) = 27.4 W/kg  
**SAR(1 g) = 12.6 mW/g; SAR(10 g) = 5.86 mW/g**

**2450 MHz System Validation/Zoom Scan 3 (7x7x7)/Cube 0:** Measurement grid: dx=5mm, dy=5mm, dz=5mm  
Reference Value = 89.0 V/m; Power Drift = 0.015 dB  
Peak SAR (extrapolated) = 27.4 W/kg  
**SAR(1 g) = 12.6 mW/g; SAR(10 g) = 5.87 mW/g**

**2450 MHz System Validation/Zoom Scan 4 (7x7x7)/Cube 0:** Measurement grid: dx=5mm, dy=5mm, dz=5mm  
Reference Value = 89.9 V/m; Power Drift = 0.00 dB  
Peak SAR (extrapolated) = 27.3 W/kg  
**SAR(1 g) = 12.6 mW/g; SAR(10 g) = 5.86 mW/g**

**2450 MHz System Validation/Zoom Scan 5 (7x7x7)/Cube 0:** Measurement grid: dx=5mm, dy=5mm, dz=5mm  
Reference Value = 89.5 V/m; Power Drift = 0.010 dB  
Peak SAR (extrapolated) = 27.4 W/kg  
**SAR(1 g) = 12.6 mW/g; SAR(10 g) = 5.86 mW/g**

**2450 MHz System Validation/Zoom Scan 6 (7x7x7)/Cube 0:** Measurement grid: dx=5mm, dy=5mm, dz=5mm  
Reference Value = 89.0 V/m; Power Drift = -0.042 dB  
Peak SAR (extrapolated) = 27.8 W/kg  
**SAR(1 g) = 12.6 mW/g; SAR(10 g) = 5.87 mW/g**

**2450 MHz System Validation/Zoom Scan 7 (7x7x7)/Cube 0:** Measurement grid: dx=5mm, dy=5mm, dz=5mm  
Reference Value = 89.7 V/m; Power Drift = 0.01 dB  
Peak SAR (extrapolated) = 27.7 W/kg  
**SAR(1 g) = 12.7 mW/g; SAR(10 g) = 5.88 mW/g**

**2450 MHz System Validation/Zoom Scan 8 (7x7x7)/Cube 0:** Measurement grid: dx=5mm, dy=5mm, dz=5mm  
Reference Value = 89.4 V/m; Power Drift = -0.01 dB  
Peak SAR (extrapolated) = 27.8 W/kg  
**SAR(1 g) = 12.7 mW/g; SAR(10 g) = 5.88 mW/g**

**2450 MHz System Validation/Zoom Scan 9 (7x7x7)/Cube 0:** Measurement grid: dx=5mm, dy=5mm, dz=5mm  
Reference Value = 89.3 V/m; Power Drift = -0.00 dB  
Peak SAR (extrapolated) = 27.6 W/kg  
**SAR(1 g) = 12.6 mW/g; SAR(10 g) = 5.87 mW/g**

**2450 MHz System Validation/Zoom Scan 10 (7x7x7)/Cube 0:** Measurement grid: dx=5mm, dy=5mm, dz=5mm  
Reference Value = 89.6 V/m; Power Drift = -0.025 dB  
Peak SAR (extrapolated) = 27.7 W/kg  
**SAR(1 g) = 12.7 mW/g; SAR(10 g) = 5.88 mW/g**

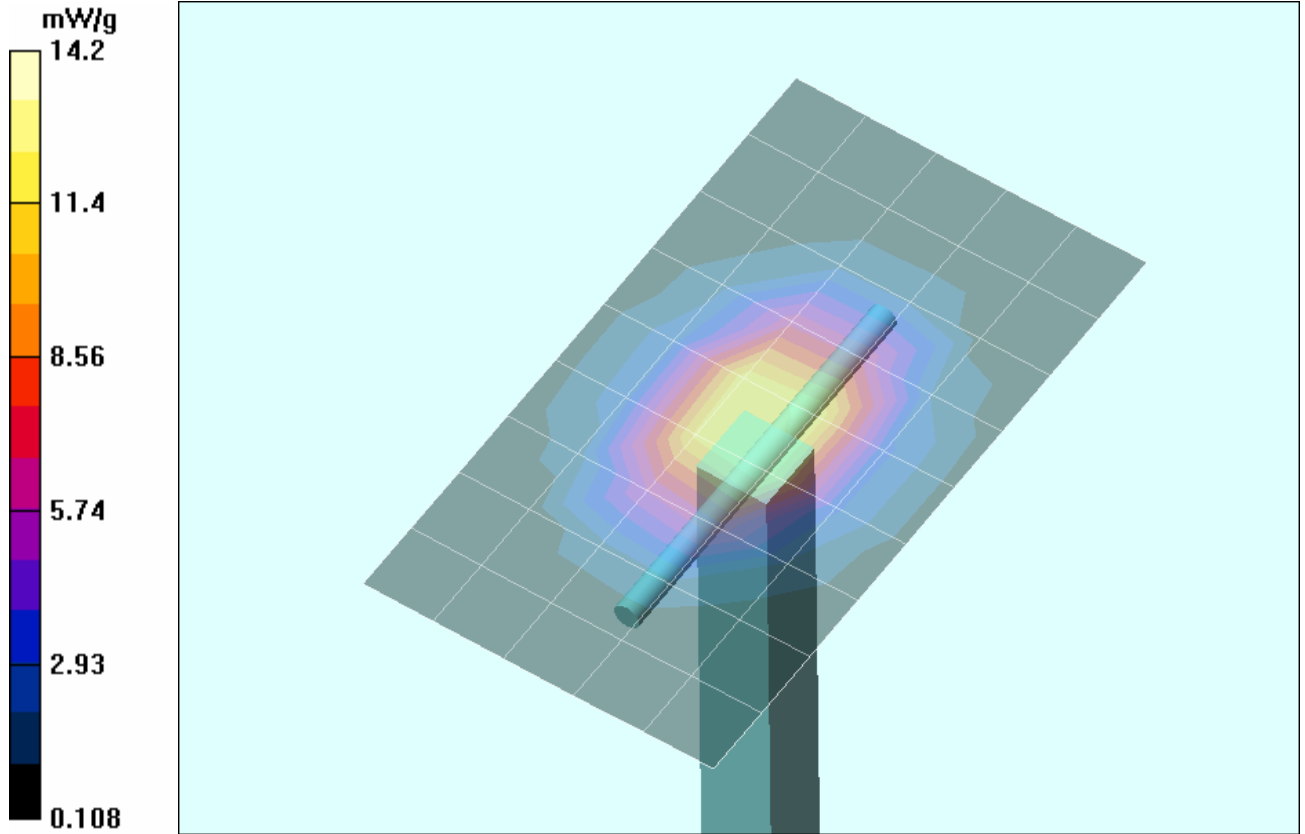

**1 g average of 10 measurements: 12.63 mW/g**  
**10 g average of 10 measurements: 5.869 mW/g**

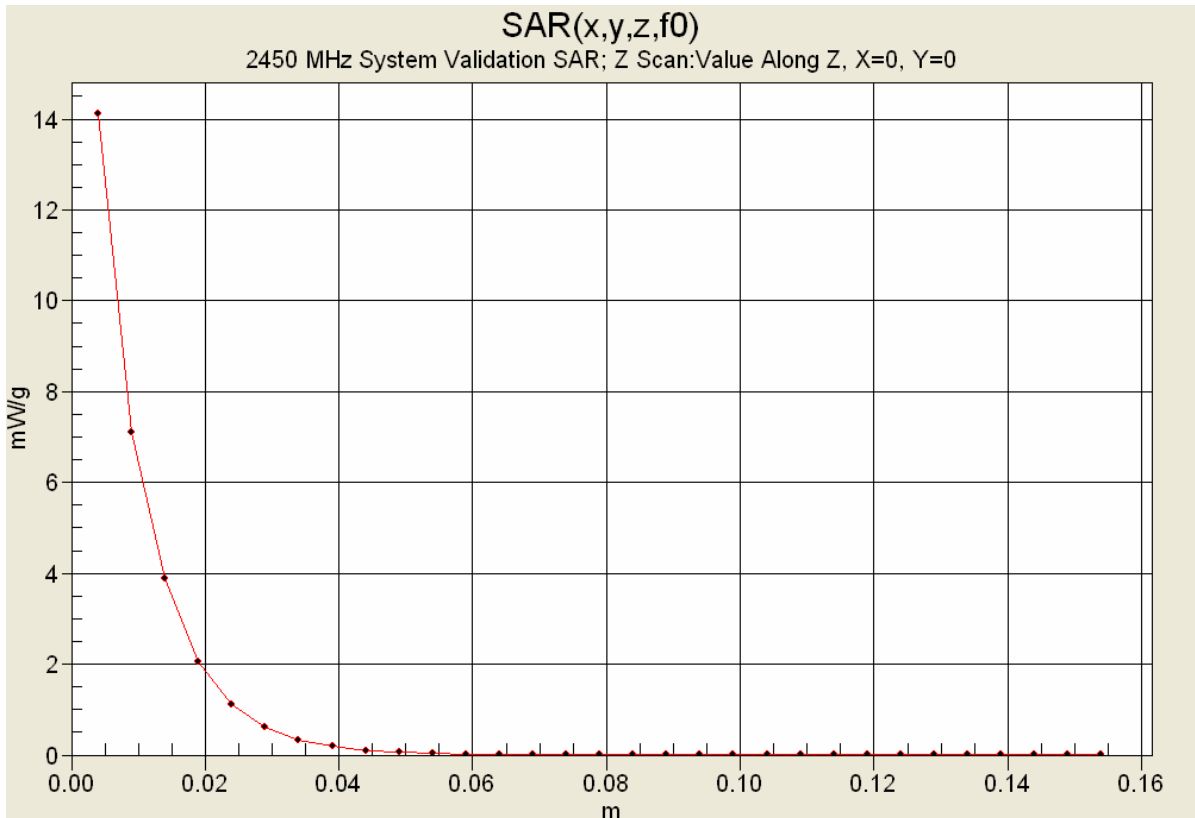

## 10. Measured Fluid Dielectric Parameters

### System Validation - 2450 MHz Dipole

#### Measured Fluid Dielectric Parameters (Muscle)

April 22, 2005

Frequency	$e'$	$e''$
2.350000000 GHz	50.4884	14.1016
2.360000000 GHz	50.4542	14.1475
2.370000000 GHz	50.4295	14.1756
2.380000000 GHz	50.4094	14.2063
2.390000000 GHz	50.3750	14.2541
2.400000000 GHz	50.3395	14.2965
2.410000000 GHz	50.2961	14.3310
2.420000000 GHz	50.2408	14.3481
2.430000000 GHz	50.2047	14.3861
2.440000000 GHz	50.1822	14.4193
<b>2.450000000 GHz</b>	<b>50.1500</b>	<b>14.4611</b>
2.460000000 GHz	50.1035	14.5137
2.470000000 GHz	50.0825	14.5504
2.480000000 GHz	50.0515	14.6073
2.490000000 GHz	50.0191	14.6410
2.500000000 GHz	49.9867	14.6647
2.510000000 GHz	49.9442	14.7231
2.520000000 GHz	49.9042	14.7502
2.530000000 GHz	49.8769	14.7804
2.540000000 GHz	49.8259	14.8081
2.550000000 GHz	49.7900	14.8467



Test Report Serial No.:	060605KBC-T643-S15W	Issue Date:	Aug. 4, 2005
Dates of Evaluation:	June 9, 23, July 15, 2005	Report Issue:	Issue 1 Rev0
Type of Evaluation:	RF Exposure	SAR	FCC 2.1093 IC RSS-102

**APPENDIX G - SAM PHANTOM CERTIFICATE OF CONFORMITY**

<b>Applicant:</b>	<b>Itronix Corporation</b>	<b>FCC ID:</b>	<b>KBCIX325-IWL</b>	<b>IC ID:</b>	<b>1943A-IX325a</b>	
<b>Model:</b>	<b>IX325-IWL</b>	<b>Type:</b>	<b>Rugged Tablet PC with Intel Pro 2200BG 802.11b/g WLAN Mini-PCI Card</b>			
2005 Celltech Labs Inc.		This document is not to be reproduced in whole or in part without the written permission of Celltech Labs Inc.				41 of 42

# Schmid & Partner Engineering AG

Zeughausstrasse 43, 8004 Zurich, Switzerland, Phone +41 1 245 97 00, Fax +41 1 245 97 79

## Certificate of conformity / First Article Inspection

Item	SAM Twin Phantom V4.0
Type No	QD 000 P40 BA
Series No	TP-1002 and higher
Manufacturer / Origin	Untersee Composites Hauptstr. 69 CH-8559 Fruthwilen Switzerland

### Tests

The series production process used allows the limitation to test of first articles. Complete tests were made on the pre-series Type No. QD 000 P40 AA, Serial No. TP-1001 and on the series first article Type No. QD 000 P40 BA, Serial No. TP-1006. Certain parameters have been retested using further series units (called samples).

Test	Requirement	Details	Units tested
Shape	Compliance with the geometry according to the CAD model.	IT'IS CAD File (*)	First article, Samples
Material thickness	Compliant with the requirements according to the standards	2mm +/- 0.2mm in specific areas	First article, Samples
Material parameters	Dielectric parameters for required frequencies	200 MHz – 3 GHz Relative permittivity < 5 Loss tangent < 0.05.	Material sample TP 104-5
Material resistivity	The material has been tested to be compatible with the liquids defined in the standards	Liquid type HSL 1800 and others according to the standard.	Pre-series, First article

### Standards

- [1] CENELEC EN 50361
- [2] IEEE P1528-200x draft 6.5
- [3] IEC PT 62209 draft 0.9

(\*) The IT'IS CAD file is derived from [2] and is also within the tolerance requirements of the shapes of [1] and [3].

### Conformity

Based on the sample tests above, we certify that this item is in compliance with the uncertainty requirements of SAR measurements specified in standard [1] and draft standards [2] and [3].

Date 18.11.2001

Signature / Stamp



**Schmid & Partner  
Engineering AG**



Zeughausstrasse 43, CH-8004 Zurich  
Tel. +41 1 245 97 00, Fax +41 1 245 97 79

Test Report Serial No.:	060605KBC-T643-S15W	Issue Date:	Aug. 4, 2005
Dates of Evaluation:	June 9, 23, July 15, 2005	Report Issue:	Issue 1 Rev0
Type of Evaluation:	RF Exposure	SAR	FCC 2.1093 IC RSS-102

**APPENDIX H - PLANAR PHANTOM CERTIFICATE OF CONFORMITY**

<b>Applicant:</b>	<b>Itronix Corporation</b>	<b>FCC ID:</b>	<b>KBCIX325-IWL</b>	<b>IC ID:</b>	<b>1943A-IX325a</b>	
<b>Model:</b>	<b>IX325-IWL</b>	<b>Type:</b>	<b>Rugged Tablet PC with Intel Pro 2200BG 802.11b/g WLAN Mini-PCI Card</b>			
2005 Celltech Labs Inc.		This document is not to be reproduced in whole or in part without the written permission of Celltech Labs Inc.				42 of 42

2378 Westlake Road  
Kelowna, B.C. Canada  
V1Z-2V2



Ph. # 250-769-6848  
Fax # 250-769-6334  
E-mail: [barskiind@shaw.ca](mailto:barskiind@shaw.ca)  
Web: [www.bcfiberglass.com](http://www.bcfiberglass.com)

## FIBERGLASS FABRICATORS

### Certificate of Conformity

Item : Flat Planar Phantom Unit # 03-01  
Date: June 16, 2003  
Manufacturer: Barski Industries (1985 Ltd)

Test	Requirement	Details
Shape	Compliance to geometry according to drawing	Supplied CAD drawing
Material Thickness	Compliant with the requirements	2mm +/- 0.2mm in measurement area
Material Parameters	Dielectric parameters for required frequencies Based on Dow Chemical technical data	100 MHz-5 GHz Relative permittivity < 5 Loss Tangent < 0.05

#### Conformity

Based on the above information, we certify this product to be compliant to the requirements specified.

Signature: 

Daniel Chailier



**Fiberglass Planar Phantom - Top View**



**Fiberglass Planar Phantom - Front View**



**Fiberglass Planar Phantom - Back View**



**Fiberglass Planar Phantom - Bottom View**

## Dimensions of Fiberglass Planar Phantom

(Manufactured by Barski Industries Ltd. - Unit# 03-01)

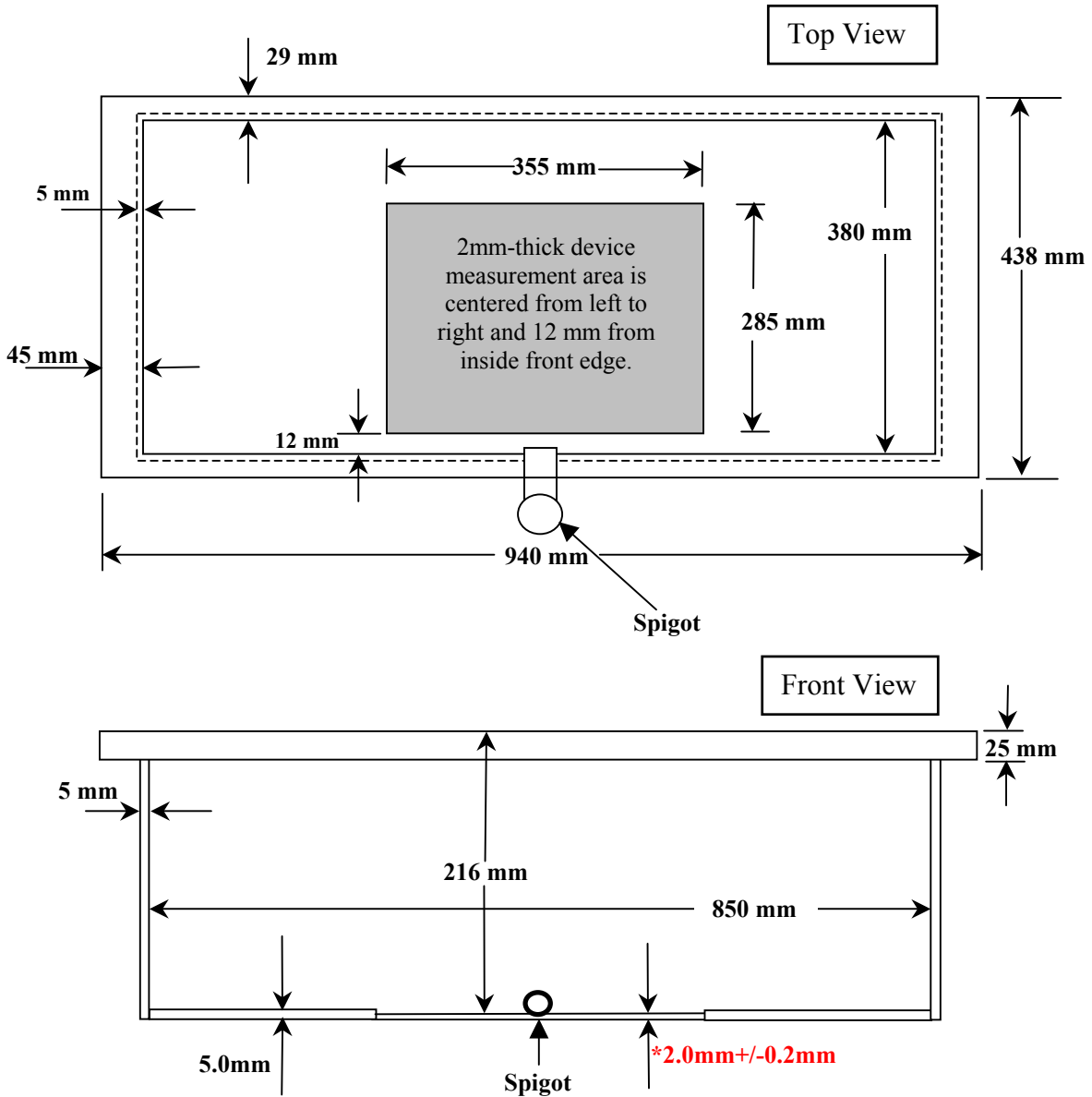

**Note: Measurements that aren't repeated for the opposite sides are the same as the side measured.  
This drawing is not to scale.**