	Test Report Serial No.:	040505KBC-F632-E15CW	Report Issue No.:	E632CW-032906-R0
	Test Date(s):	13Sep05 - 27Nov05	Report Issue Date:	March 29, 2006
	Test Rule Part(s):	FCC 47 CFR §15.247	Industry Canada RSS-210 Issue 6	
	Lab Registration(s):	FCC Lab Reg. # 714830	Industry Canada Lab File # IC 3874	

ELECTROMAGNETIC COMPATIBILITY

EMC TEST REPORT

FCC 47 CFR PART 15 SUBPART C
&
INDUSTRY CANADA RSS-210 ISSUE 6

FOR

ITRONIX CORPORATION

MODEL: IX325-CWL

IX325 SERIES RUGGED TABLET PC

WITH

CISCO AIR-CB21AG-A-K9 802.11ABG WLAN (PCMCIA)

FCC ID: KBCIX325-CWL

IC: 1943A-IX325ab

Test Report Serial Number

040505KBC-F632-E15CW

Test Report Issue No.

E632CW-032906-R0

Test Lab

Celltech Compliance Testing & Engineering Lab
(Celltech Labs Inc.)
1955 Moss Court
Kelowna, BC
Canada V1Y 9L3

	Test Report Serial No.:	040505KBC-F632-E15CW	Report Issue No.:	E632CW-032906-R0
	Test Date(s):	13Sep05 - 27Nov05	Report Issue Date:	March 29, 2006
	Test Rule Part(s):	FCC 47 CFR §15.247	Industry Canada RSS-210 Issue 6	
	Lab Registration(s):	FCC Lab Reg. # 714830	Industry Canada Lab File # IC 3874	

DECLARATION OF COMPLIANCE

Test Lab CELLTECH LABS INC. Testing and Engineering Services 1955 Moss Court Kelowna, B.C. Canada V1Y 9L3 Phone: 250-448-7047 Fax: 250-448-7048 e-mail: info@celltechlabs.com web site: www.celltechlabs.com		Applicant ITRONIX CORPORATION 12825 E. Mirabeau Parkway Spokane Valley, WA 99216 United States	
Lab Registration No.(s):	FCC:	714830	IC: 3874
Rule Part(s):	FCC:	§15.247; §2.1091; §1.1310	IC: RSS-210 Issue 6 Annex 8
Device Classification:	FCC:	Digital Transmission System (DTS)	IC: Low Power License-Exempt Transmitter
Device Identification:	FCC ID:	KBCIX325-CWL	IC: 1943A-IX325ab
DUT Description:			
Model:	IX325-CWL		
Device Description:	Rugged Tablet PC		
Transmitter(s):	CISCO AIR-CB21AG-A-K9 802.11abg WLAN (PCMCIA)		
Transmit Frequency Range:	5180 - 5250 MHz 802.11a (UNII-1 Band) 5250 - 5320 MHz 802.11a (UNII-2 Band) 5745 - 5825 MHz 802.11a (UNII-3 Band) 2412 - 2462 MHz 802.11b/g (ISM Band)		
Max. RF Output Power Measured:	0.0379 Watts - 15.79 dBm - Peak Conducted - 802.11a - 6 Mbps 0.1019 Watts - 20.08 dBm - Peak Conducted - 802.11b - 11 Mbps 0.0622 Watts - 17.94 dBm - Peak Conducted - 802.11g - 6 Mbps		
Max. Radiated RF Power Measured:	111.06 dBuV/m @ 3 meters - 802.11a (1 MHz RBW) 107.19 dBuV/m @ 3 meters - 802.11b (1 MHz RBW) 107.34 dBuV/m @ 3 meters - 802.11g (1 MHz RBW)		
Worst-case Radiated Transmitter Spurious Emissions*:	42.03 dBuV/m peak @ 3 meters for 266.07 MHz - 802.11a (1 MHz RBW, 3.99 dB margin, peak to restricted average limit) 52.75 dBuV/m average @ 3 meters for 2389.05 MHz - 802.11b (1 MHz RBW, calculated band edge, 1.23 dB margin, average to restricted average limit) 61.4 dBuV/m peak @ 1 meter for 12300.10 MHz - 802.11g (1 MHz RBW, 2.12 dB margin, peak to restricted average limit)		
Worst-case Conducted Receiver Spurious Emissions*:	-71.36 dBm @ 13726.25 MHz - 802.11a (100 kHz RBW, 18.36 dB margin) -67.43 dBm @ 7058.65 MHz - 802.11b (100 kHz RBW, 14.43 dB margin) -66.77 dBm @ 7058.65 MHz - 802.11g (100 kHz RBW, 13.77 dB margin)		
Operating Mode(s):	OFDM (Orthogonal Frequency Division Multiplexing) - 802.11a/g DSSS (Direct Sequence Spread Spectrum) - 802.11b		
Modulation Type(s):	BPSK, QPSK, 16-QAM, 64-QAM, DBPSK, DQPSK, CCK		
Antenna Type(s):	Dual-band Diversity Monopole Antenna (embedded on PC Card PCB)		
Power Source(s):	Stationary: 75 Watt AC Power Adapter 11.1 V Internal Lithium-ion Battery, 3600 mAh (Model: T8M-E) 11.1 V External Second Lithium-ion Battery, 3600 mAh (Model: T8S-E)		

*Defined as minimum margin to applicable limit

Applicant:	Itronix Corporation	FCC ID:	KBCIX325-CWL	IC ID:	1943A-IX325ab	
Model(s):	IX325-CWL	IX325 Series Rugged Tablet PC with Cisco AIR-CB21AG-A-K9 802.11 abg WLAN				
2006 Celltech Labs Inc.		This document is not to be reproduced in whole or in part without the prior written permission of Celltech Labs Inc.				Page 2 of 83

	Test Report Serial No.:	040505KBC-F632-E15CW	Report Issue No.:	E632CW-032906-R0
	Test Date(s):	13Sep05 - 27Nov05	Report Issue Date:	March 29, 2006
	Test Rule Part(s):	FCC 47 CFR §15.247	Industry Canada RSS-210 Issue 6	
	Lab Registration(s):	FCC Lab Reg. # 714830	Industry Canada Lab File # IC 3874	

ATTESTATIONS

This wireless device has demonstrated compliance with the applicable technical standards as indicated in the measurement report and was tested in accordance with the measurement procedures specified in FCC 47 CFR Part 15C and Industry Canada RSS-210 Issue 6.

I attest to the accuracy of the data. All measurements reported herein were performed by me or were under my supervision and are correct to the best of my knowledge and belief. I assume full responsibility for the completeness of these measurements and vouch for the qualifications of all persons taking them.

This test report shall not be reproduced partially, or in full, without the prior written approval of Celltech Labs Inc.

The results and statements contained in this report pertain only to the device(s) evaluated.

	<p>Duane M. Friesen, C.E.T. EMC Manager Celltech Labs Inc.</p>
-----------------------------------------------------------------------------------	-----------------------------------------------------------------------------------------------



Applicant:	Itronix Corporation	FCC ID:	KBCIX325-CWL	IC ID:	1943A-IX325ab	
Model(s):	IX325-CWL	IX325 Series Rugged Tablet PC with Cisco AIR-CB21AG-A-K9 802.11 abg WLAN				
2006 Celltech Labs Inc.		This document is not to be reproduced in whole or in part without the prior written permission of Celltech Labs Inc.				Page 3 of 83



	Test Report Serial No.:	040505KBC-F632-E15CW	Report Issue No.:	E632CW-032906-R0
	Test Date(s):	13Sep05 - 27Nov05	Report Issue Date:	March 29, 2006
	Test Rule Part(s):	FCC 47 CFR §15.247	Industry Canada RSS-210 Issue 6	
	Lab Registration(s):	FCC Lab Reg. # 714830	Industry Canada Lab File # IC 3874	

TABLE OF CONTENTS

1.0 SCOPE	7
2.0 REFERENCES	7
2.1 Normative References	7
3.0 TERMS AND DEFINITIONS	8
4.0 FACILITIES AND ACCREDITATIONS	9
5.0 GENERAL INFORMATION	9
5.1 Applicant Information	9
5.2 DUT Description	9
5.3 Co-Located Equipment	10
5.4 Cable Descriptions	10
5.5 Support Equipment	10
5.6 Clock Frequencies	10
5.7 Mode(s) of Operation Tested	11
5.8 Configuration Description	12
6.0 PASS/FAIL CRITERIA	12
APPENDICES	13
Appendix A - DUT Photographs	14
Appendix B - 6 dB Bandwidth Measurement	15
Appendix C - Peak Conducted Power Measurement	21
Appendix D - Conducted Receiver Spurious Emissions Measurement	27
Appendix E - Conducted Transmitter Spurious Emissions Measurement	33
Appendix F - Radiated Spurious Emissions Measurement	42
Appendix G - Restricted Band Emissions Measurement	55
Appendix H - Peak Power Spectral Density Measurement	73
Appendix I - Conducted Powerline Emissions Measurement	77
END OF DOCUMENT	83

FIGURES

Figure B.6-1 - Setup Drawing	16
Figure C.6-1 - Setup Drawing	22
Figure D.6-1 - Setup Drawing	28
Figure E.6-1 - Setup Drawing	34
Figure F.6-1 - Setup Drawing (<26.5 GHz)	43
Figure F.6-2 - Setup Drawing (>26.5 GHz)	43
Figure G.6-1 - Setup Drawing (<26.5 GHz)	58
Figure G.6-2 - Setup Drawing (>26.5 GHz)	58
Figure H.6-1 - Setup Drawing	74
Figure I.6-1 - Setup Drawing	78

Applicant:	Itronix Corporation	FCC ID:	KBCIX325-CWL	IC ID:	1943A-IX325ab	
Model(s):	IX325-CWL	IX325 Series Rugged Tablet PC with Cisco AIR-CB21AG-A-K9 802.11 abg WLAN				
2006 Celltech Labs Inc.		This document is not to be reproduced in whole or in part without the prior written permission of Celltech Labs Inc.				Page 4 of 83

	Test Report Serial No.:	040505KBC-F632-E15CW	Report Issue No.:	E632CW-032906-R0
	Test Date(s):	13Sep05 - 27Nov05	Report Issue Date:	March 29, 2006
	Test Rule Part(s):	FCC 47 CFR §15.247	Industry Canada RSS-210 Issue 6	
	Lab Registration(s):	FCC Lab Reg. # 714830	Industry Canada Lab File # IC 3874	

PHOTOGRAPHS

Photograph A-1 - Front of IX325 Tablet PC	14
Photograph A-2 - Back of IX325 Tablet PC	14
Photograph A-3 - WLAN Card Installed (cover removed).....	14
Photograph A-4 - WLAN PCMCIA Card.....	14
Photograph G-1 - Loop Antenna (10kHz - 30 MHz) @ 3m	59
Photograph G-2 - Bilog Antenna (30 MHz - 1 GHz) @ 3m.....	59
Photograph G-3 - 3115 Horn @ 3 m.....	59
Photograph G-4 - 3115 Horn with LNA/Filter @ 3m	59
Photograph G-5 - Waveline Horn with LNA @ 1m	59
Photograph G-6 - DUT Configuration	59
Photograph I-1 - AC Powerline Conducted Emission Cable Placement.....	79
Photograph I-2 - AC Powerline Conducted Emission Configuration	79

Applicant:	Itronix Corporation	FCC ID:	KBCIX325-CWL	IC ID:	1943A-IX325ab	
Model(s):	IX325-CWL	IX325 Series Rugged Tablet PC with Cisco AIR-CB21AG-A-K9 802.11 abg WLAN				
2006 Celltech Labs Inc.		This document is not to be reproduced in whole or in part without the prior written permission of Celltech Labs Inc.				Page 5 of 83

	Test Report Serial No.:	040505KBC-F632-E15CW	Report Issue No.:	E632CW-032906-R0
	Test Date(s):	13Sep05 - 27Nov05	Report Issue Date:	March 29, 2006
	Test Rule Part(s):	FCC 47 CFR §15.247	Industry Canada RSS-210 Issue 6	
	Lab Registration(s):	FCC Lab Reg. # 714830	Industry Canada Lab File # IC 3874	



TEST SUMMARY

Appendix	Test Description	Procedure Reference	Limit Reference	Test Start Date	Test End Date	Result
Referenced Standard: FCC CFR Title 47 Part 15						
B	6 dB Bandwidth	FCC 97-114	§15.247 (a) (2)	23Nov05	23Nov05	Pass
C	Peak Conducted Output Power	FCC 97-114	§15.247 (b) (3)	23Nov05	23Nov05	Pass
E	Conducted Transmitter Spurious Emissions	FCC 97-114	§15.247(d)	24Nov05	24Nov05	Pass
F	Radiated Spurious Emissions	FCC 97-114	§15.247(d)	13Sep05	14Oct05	Pass
G	Restricted Band Emissions	FCC 97-114	§15.205 (a), (b) §15.209 (a)	13Sep05	14Oct05	Pass
H	Peak Power Spectral Density	FCC 97-114	§15.247(e)	24Nov05	24Nov05	Pass
I	Powerline Conducted Emissions	ANSI C63.4	§15.207	27Nov05	27Nov05	Pass
Referenced Standard: IC RSS-210 Issue 6						
B	6 dB Bandwidth	RSS-210 § 10	RSS-210 A1 §(l)(iv)	23Nov05	23Nov05	Pass
C	Peak Conducted Output Power	RSS-210 § 10	RSS-210 A1 §(l)(iv) RSS-210 §6.2.2 (o)(b)	23Nov05	23Nov05	Pass
D	Conducted Receiver Spurious Emissions	RSS-GEN§6 (b)	RSS-GEN§4.8 (b)	24Nov05	24Nov05	Pass
E	Conducted Transmitter Spurious Emissions	RSS-GEN§6 (b)	RSS-210 §6.3	24Nov05	24Nov05	Pass
F	Radiated Spurious Emissions	RSS-212, ANSI C63.4	RSS-210 Annex 9.3 §(1)&(2)	13Sep05	14Oct05	Pass
G	Restricted Band Emissions	RSS-212, ANSI C63.4	RSS-210 §6.3	13Sep05	14Oct05	Pass
H	Peak Power Spectral Density	RSS-210 § 10	RSS-210 §6.2.2 (o)(b)	24Nov05	24Nov05	Pass
I	Powerline Conducted Emissions	RSS-212, ANSI C63.4	RSS-210 §6.6	27Nov05	27Nov05	Pass

REVISION LOG

Issue No.	Description	Implemented By	Implementation Date
E632CW-032906-R0	Initial Release	Jonathan Hughes	29Mar06

SIGNATORIES

Prepared By		December 01, 2005
Name/Title	Duane M. Friesen, C.E.T. / EMC Manager	Date
Reviewed By		March 29, 2006
Name/Title	Jonathan Hughes / General Manager	Date

Applicant:	Itronix Corporation	FCC ID:	KBCIX325-CWL	IC ID:	1943A-IX325ab	
Model(s):	IX325-CWL	IX325 Series Rugged Tablet PC with Cisco AIR-CB21AG-A-K9 802.11 abg WLAN				
2006 Celltech Labs Inc.		This document is not to be reproduced in whole or in part without the prior written permission of Celltech Labs Inc.				Page 6 of 83

	Test Report Serial No.:	040505KBC-F632-E15CW	Report Issue No.:	E632CW-032906-R0
	Test Date(s):	13Sep05 - 27Nov05	Report Issue Date:	March 29, 2006
	Test Rule Part(s):	FCC 47 CFR §15.247	Industry Canada RSS-210 Issue 6	
	Lab Registration(s):	FCC Lab Reg. # 714830	Industry Canada Lab File # IC 3874	

1.0 SCOPE

This report outlines the measurements made and results collected during the electromagnetic emissions testing of the Itronix Corporation Model: IX325-CWL Rugged Tablet PC with Cisco AIR-CB21AG-A-K9 802.11abg WLAN PCMCIA Card with embedded dual-band diversity PCB antenna. As defined by the manufacturer, the WLAN is designed to operate in North America with the 2412-2462 MHz and 5745-5825 MHz bands addressed in this report. The 5180-5320 MHz operating band is addressed in a separate report for Subpart E of the requirements. The measurement results were applied against the EMC requirements and limits outlined in the technical rules and regulations set forth in the Federal Communication Commission Code of Federal Regulations Title 47 Part 15 Subpart C and Industry Canada RSS-210 Issue 6.

2.0 REFERENCES

2.1 Normative References

ANSI/ISO 17025:1999	General Requirements for competence of testing and calibration laboratories
IEEE/ANSI C63.4-2003	Methods of Measurement of Radio-Noise Emissions from Low-Voltage Electrical and Electronic Equipment in the Range of 9 kHz to 40 GHz
IEEE/ANSI Std C95.1-1999	American National Standard Safety Levels with Respect to Human Exposure to Radio Frequency Electromagnetic Fields
CFR Title 47 Part 2:2005	Code of Federal Regulations Title 47: Telecommunication Part 2: Frequency Allocations and Radio Treaty Matters; General Rules and Regulations
CFR Title 47 Part 15:2005	Code of Federal Regulations Title 47: Telecommunication Part 15: Radio Frequency Devices
FCC Public Notice DA 00-705	Filing and Measurement Guidelines for Frequency Hopping Spread Spectrum Systems March 30, 2000
FCC Knowledge Database Pub. 558074 (May 10, 2005)	
IC Spectrum Management & Telecommunications Policy	Radio Standards Specification RSS-GEN 4.4.1 General Requirements and Information for Certification of Radiocommunication Equipment - Issue 1, September 2005 RSS-212 Issue 1 (Provisional) - Test Facilities & Test Methods for Radio Equipment RSS-210 Issue 6 - Low Power Licence-Exempt Radiocommunication Devices - September 2005 RSS-102 Issue 2 - Radio Frequency Exposure Compliance of Radiocommunication Apparatus (All Frequency Bands) - November 2005

Applicant:	Itronix Corporation	FCC ID:	KBCIX325-CWL	IC ID:	1943A-IX325ab	
Model(s):	IX325-CWL	IX325 Series Rugged Tablet PC with Cisco AIR-CB21AG-A-K9 802.11 abg WLAN				
2006 Celltech Labs Inc.	This document is not to be reproduced in whole or in part without the prior written permission of Celltech Labs Inc.					Page 7 of 83

	Test Report Serial No.:	040505KBC-F632-E15CW	Report Issue No.:	E632CW-032906-R0
	Test Date(s):	13Sep05 - 27Nov05	Report Issue Date:	March 29, 2006
	Test Rule Part(s):	FCC 47 CFR §15.247	Industry Canada RSS-210 Issue 6	
	Lab Registration(s):	FCC Lab Reg. # 714830	Industry Canada Lab File # IC 3874	

3.0 TERMS AND DEFINITIONS

AVG	Average
CFR	Code of Federal Regulations
dB	decibel
dBm	dB referenced to 1 mW
dBuV	dB referenced to 1 uV
DUT	Device under Test
DSSS	Direct Sequence Spread Spectrum
dBc	dB down from carrier
EBW	Emission Bandwidth
EMC	Electromagnetic Compatibility
FCC	Federal Communication Commission
HP	Hewlett Packard
HPF	High Pass Filter
Hpol	Horizontal Polarization
IC	Industry Canada
kHz	kilohertz
LNA	Low Noise Amplifier
m	meter
MHz	Megahertz
Mbps	megabits per second
na	not applicable
n/a	not available
OFDM	Orthogonal Frequency Division Multiplexing
PK	Peak
PPSD	Peak Power Spectral Density
QP	Quasi-Peak
RBW	Resolution Bandwidth
R&S	Rohde & Schwarz
RSS	Radio Standard Specification
SA	Spectrum Analyzer
VBW	Video Bandwidth
Vpol	Vertical Polarization
WLAN	Wireless Local Area Network

Applicant:	Itronix Corporation	FCC ID:	KBCIX325-CWL	IC ID:	1943A-IX325ab	
Model(s):	IX325-CWL	IX325 Series Rugged Tablet PC with Cisco AIR-CB21AG-A-K9 802.11 abg WLAN				
2006 Celltech Labs Inc.		This document is not to be reproduced in whole or in part without the prior written permission of Celltech Labs Inc.				Page 8 of 83

	Test Report Serial No.:	040505KBC-F632-E15CW	Report Issue No.:	E632CW-032906-R0
	Test Date(s):	13Sep05 - 27Nov05	Report Issue Date:	March 29, 2006
	Test Rule Part(s):	FCC 47 CFR §15.247	Industry Canada RSS-210 Issue 6	
	Lab Registration(s):	FCC Lab Reg. # 714830	Industry Canada Lab File # IC 3874	

4.0 FACILITIES AND ACCREDITATIONS

The facilities used in collecting the test results outlined in this report are located at 1955 Moss Court, Kelowna, British Columbia, Canada, V1Y 9L3. The radiated and conducted emissions sites conform to the requirements set forth in ANSI C63.4 and are filed and listed with the FCC under Registration Number 714830 and Industry Canada under File Number IC 3874.

5.0 GENERAL INFORMATION

5.1 Applicant Information

Company Name:	Itronix Corporation
Address:	12825 E. Mirabeau Parkway Spokane Valley, WA 99216 United States

5.2 DUT Description

The DUT consisted of the Itronix Rugged Tablet PC Model: IX325-CWL with Cisco AIR-CB21AG-A-K9 802.11abg WLAN PCMCIA Card installed in the PCMCIA slot. The embedded dual-band monopole diversity PCB antenna is located at the protruding end of the PCMCIA card. Photographs of the DUT placement and construction are shown in Appendix A.

Device:	Rugged Tablet PC		
Model:	IX325-CWL		
Serial Number:	ZZGEG5073ZZ9781		
Identifier(s):	FCC ID:	KBCIX325-CWL	IC: 1943A-IX325ab
Power Source(s):	Delta Electronics 75 Watt AC-DC Power Supply Model: ADP-75 FB B Rev 00 (S/N: UCT030200307)		
	Internal Lithium-ion 11.1 V 3600 mAh Battery Model: T8M-E		
	External Second Lithium-ion 11.1 V 3600 mAh Battery Model: T8S-E		

Device:	WLAN PCMCIA Card (802.11abg)		
Model:	CISCO AIR-CB21AG-A-K9		
Serial No(s):	FOC0853N07U, FOC0852NKWM		
Rule Part(s):	FCC:	§15.247; §2.1091; §1.1310	IC: RSS-210 Issue 6
Classification:	FCC:	Digital Transmission System (DTS)	IC: Low Power License-Exempt Transmitter
Power Source:	Powered from the internal PC power supply		

Device:	Embedded Dual-Band Monopole Diversity PCB antenna (Transmit/Receive & Receive)		
Model:	n/a (Integral to AIR-CB21AG-A-K9 WLAN PCB)		
Gain:	2.0 dBi (horizontal)		

Applicant:	Itronix Corporation	FCC ID:	KBCIX325-CWL	IC ID:	1943A-IX325ab	
Model(s):	IX325-CWL	IX325 Series Rugged Tablet PC with Cisco AIR-CB21AG-A-K9 802.11 abg WLAN				
2006 Celltech Labs Inc.		This document is not to be reproduced in whole or in part without the prior written permission of Celltech Labs Inc.				Page 9 of 83

	Test Report Serial No.:	040505KBC-F632-E15CW	Report Issue No.:	E632CW-032906-R0
	Test Date(s):	13Sep05 - 27Nov05	Report Issue Date:	March 29, 2006
	Test Rule Part(s):	FCC 47 CFR §15.247	Industry Canada RSS-210 Issue 6	
	Lab Registration(s):	FCC Lab Reg. # 714830	Industry Canada Lab File # IC 3874	

5.3 Co-Located Equipment

Device:	GPS Receiver Module
Model:	Leadtek Model LR9805

Device:	GPS Antenna (Receive only)
Model:	Sarantel 101401040/2004UK

5.4 Cable Descriptions

ROUTING		Length m	Model	Terminations		Shield Type	Shield Termination		Suppression
From	To			End 1	End 2		End 1	End 2	
PC modem port	Unterminated	1.0	n/a	RJ-11	RJ-11	None	na	na	None

5.5 Support Equipment

The following equipment was used in support of the DUT.

CO-LOCATED SUPPORT EQUIPMENT LIST		
MANUFACTURER	MODEL	DESCRIPTION
D-Link	DE-809TC/	Ethernet hub
YNG YUH	YP-040	Hub power supply
MLi	699	Speakers
Polk Audio	n/a	Speaker-microphone
-	K8255	Keyboard
Sanwa Supply	MA-MBUSB	Mouse

5.6 Clock Frequencies

5.6.1 DUT Clock Frequencies

Device:	Rugged Tablet PC
Clocks:	n/a
Name:	WLAN PCMCIA Card
Clocks:	n/a
Name:	PCB Antenna (WLAN)
Clocks:	None

5.6.2 Co-Located Clock Frequencies

Device:	Peripherals
Clocks:	n/a

Applicant:	Itronix Corporation	FCC ID:	KBCIX325-CWL	IC ID:	1943A-IX325ab	
Model(s):	IX325-CWL	IX325 Series Rugged Tablet PC with Cisco AIR-CB21AG-A-K9 802.11 abg WLAN				
2006 Celltech Labs Inc.		This document is not to be reproduced in whole or in part without the prior written permission of Celltech Labs Inc.				Page 10 of 83

	Test Report Serial No.:	040505KBC-F632-E15CW	Report Issue No.:	E632CW-032906-R0
	Test Date(s):	13Sep05 - 27Nov05	Report Issue Date:	March 29, 2006
	Test Rule Part(s):	FCC 47 CFR §15.247	Industry Canada RSS-210 Issue 6	
	Lab Registration(s):	FCC Lab Reg. # 714830	Industry Canada Lab File # IC 3874	

5.7 Mode(s) of Operation Tested

The customer supplied the software that was used to set the WLAN card in the appropriate mode, channel, and power level for the specific measurement. The following are the minimum settings used:

Tx Frequency Range:	Modes b & g: 2412 - 2462 MHz Ch. 1 (2412 MHz), Ch. 6 (2437 MHz) & Ch. 11 (2462 MHz) measured unless otherwise noted Mode a: 5745 - 5825 MHz Ch. 149 (5745 MHz), Ch. 157 (5785 MHz) & Ch. 165 (5825 MHz) measured unless otherwise noted					
Software Power Gain Settings:	802.11a set to power setting of 17.0 / 0 for 6 mbps, 14.0 for 54 mbps 802.11b set to power setting of 20.0 / 0 802.11g set to power setting of 18.5 / 0					
RF Peak Conducted Output Power Tested:¹	802.11a	6 Mbps	54 Mbps	802.11b	1 Mbps	11 Mbps
	5745 MHz	15.68 dBm	13.08 dBm	2412 MHz	19.84 dBm	19.69 dBm
	5785 MHz	15.79 dBm	12.77 dBm	2437 MHz	19.95 dBm	20.04 dBm
	5825 MHz	15.57 dBm	12.73 dBm	2462 MHz	20.02 dBm	20.08 dBm
	802.11g	6 Mbps	54 Mbps	-	-	-
	2412 MHz	17.94 dBm	17.83 dBm	-	-	-
	2437 MHz	17.71 dBm	17.59 dBm	-	-	-
	2462 MHz	17.60 dBm	17.49 dBm	-	-	-
Modes / Data Rates Tested:²	802.11a (6, 54 Mbps checked in prescan) (6 Mbps determined to be worst-case spurious and used unless otherwise noted)					
	802.11b (1, 11 Mbps checked in prescan) (1 Mbps short determined to be worst-case spurious and used unless otherwise noted)					
	802.11g (6, 54 Mbps checked in prescan) (6 Mbps determined to be worst-case spurious and used unless otherwise noted)					
Modes of Operation:	802.11a - OFDM, 802.11b - DSSS, 802.11g - OFDM					
Modulation Type(s):	BPSK, QPSK, 16QAM, 64QAM, DBPSK, DQPSK, CCK					
Power Source(s) Tested:	All tests were performed with the AC Power Adapter powering the DUT.					

Note 1: Peak power measured and integrated per FCC Document KDB Pub. No. 558074 Power Output Option 2 Method 1

Note 2: Turbo mode available at module level but not enabled when installed in IX325 Tablet PC per Itronix Corp.

Applicant:	Itronix Corporation	FCC ID:	KBCIX325-CWL	IC ID:	1943A-IX325ab	
Model(s):	IX325-CWL	IX325 Series Rugged Tablet PC with Cisco AIR-CB21AG-A-K9 802.11 abg WLAN				
2006 Celltech Labs Inc.		This document is not to be reproduced in whole or in part without the prior written permission of Celltech Labs Inc.				Page 11 of 83

	Test Report Serial No.:	040505KBC-F632-E15CW	Report Issue No.:	E632CW-032906-R0
	Test Date(s):	13Sep05 - 27Nov05	Report Issue Date:	March 29, 2006
	Test Rule Part(s):	FCC 47 CFR §15.247	Industry Canada RSS-210 Issue 6	
	Lab Registration(s):	FCC Lab Reg. # 714830	Industry Canada Lab File # IC 3874	

5.7.1 DUT Exercising Software Description

The DUT was configured and exercised using customer supplied test software that allows an operator to set the parameters of the WLAN operation. The settings used are described in each appendix. Unless otherwise noted the power gain settings were set as described in section 5.6 with the worst-case data rate as described in the same section. Software power settings were set as defined by the manufacturer for typical operation.

5.8 Configuration Description

The DUT was configured, as described by the client as being representative of what would be delivered to a final customer. This configuration included the WLAN and internal antenna as described in section 5.2 installed in a typical manner. More specific details may be included in each appendix.

5.8.1 Configuration Justification

The DUT was tested in a configuration described by the client as being worst-case but typical of normal use.

Prescan measurements were made with the WLAN in each of the three available modes (a, b & g). The lowest and highest bit rates were tested in each. The lowest, highest and mid-band channels in the mode b, g and upper band of mode a were investigated. In addition, the three orthogonal DUT orientations were used to determine worse case orientation. From this preliminary data, it was determined that the lowest rate in each mode, along with a face up orientation produced the highest spurious emissions (or highest carrier if no significant difference in spurious emissions were found). Software power settings were made based on information received from the customer. These settings were described as those needed to set the DUT to its highest marketed power. Unless otherwise specified in the applicable appendices, these settings (or higher) were used for the measurements described in this report.

6.0 PASS/FAIL CRITERIA

Unless otherwise noted in the Appendices, the pass/fail criteria is the limit set forth in the reference standards. A DUT is considered to have passed the requirements, if the data collected during the described measurement procedure is less than or equal to the specified limits as defined. The pass/fail statements made in this report only apply to the unit tested.

Applicant:	Itronix Corporation	FCC ID:	KBCIX325-CWL	IC ID:	1943A-IX325ab	
Model(s):	IX325-CWL	IX325 Series Rugged Tablet PC with Cisco AIR-CB21AG-A-K9 802.11 abg WLAN				
2006 Celltech Labs Inc.	This document is not to be reproduced in whole or in part without the prior written permission of Celltech Labs Inc.					Page 12 of 83

	Test Report Serial No.:	040505KBC-F632-E15CW	Report Issue No.:	E632CW-032906-R0
	Test Date(s):	13Sep05 - 27Nov05	Report Issue Date:	March 29, 2006
	Test Rule Part(s):	FCC 47 CFR §15.247	Industry Canada RSS-210 Issue 6	
	Lab Registration(s):	FCC Lab Reg. # 714830	Industry Canada Lab File # IC 3874	

APPENDICES

Applicant:	Itronix Corporation	FCC ID:	KBCIX325-CWL	IC ID:	1943A-IX325ab	
Model(s):	IX325-CWL	IX325 Series Rugged Tablet PC with Cisco AIR-CB21AG-A-K9 802.11 abg WLAN				
2006 Celltech Labs Inc.		This document is not to be reproduced in whole or in part without the prior written permission of Celltech Labs Inc.				Page 13 of 83

	Test Report Serial No.:	040505KBC-F632-E15CW	Report Issue No.:	E632CW-032906-R0
	Test Date(s):	13Sep05 - 27Nov05	Report Issue Date:	March 29, 2006
	Test Rule Part(s):	FCC 47 CFR §15.247	Industry Canada RSS-210 Issue 6	
	Lab Registration(s):	FCC Lab Reg. # 714830	Industry Canada Lab File # IC 3874	

Appendix A - DUT Photographs

Photograph A-1 - Front of IX325 Tablet PC



Photograph A-2 - Back of IX325 Tablet PC





Photograph A-3 - WLAN Card Installed (cover removed)



Photograph A-4 - WLAN PCMCIA Card



Applicant:	Itronix Corporation	FCC ID:	KBCIX325-CWL	IC ID:	1943A-IX325ab	
Model(s):	IX325-CWL	IX325 Series Rugged Tablet PC with Cisco AIR-CB21AG-A-K9 802.11 abg WLAN				
2006 Celltech Labs Inc.		This document is not to be reproduced in whole or in part without the prior written permission of Celltech Labs Inc.				Page 14 of 83

	Test Report Serial No.:	040505KBC-F632-E15CW	Report Issue No.:	E632CW-032906-R0
	Test Date(s):	13Sep05 - 27Nov05	Report Issue Date:	March 29, 2006
	Test Rule Part(s):	FCC 47 CFR §15.247	Industry Canada RSS-210 Issue 6	
	Lab Registration(s):	FCC Lab Reg. # 714830	Industry Canada Lab File # IC 3874	

Appendix B - 6 dB Bandwidth Measurement

B.1. REFERENCES	
Normative Reference Standard	FCC CFR 47 §15.247 (2)
Procedure Reference	FCC Document KDB Publication Number 558074

B.2. LIMITS	
B.2.1. FCC CFR 47	
FCC CFR 47 §15.247	<i>(a) (2) Systems using digital modulation techniques may operate in the 902-928 MHz, 2400-2483.5 MHz, and 5725-5850 MHz bands. The minimum 6 dB bandwidth shall be at least 500 kHz</i>

B.3. ENVIRONMENTAL CONDITIONS	
Temperature	25 ± 5 °C
Humidity	35 ± 5 %RH
Barometric Pressure	uncontrolled

B.4. EQUIPMENT LIST					
ASSET NUMBER	MANUFACTURER	MODEL	DESCRIPTION	LAST CAL	CAL DUE
00015	Agilent	E4408B	Spectrum Analyzer	24Jan05	24Jan06
Customer supplied	n/a	n/a	1ft. RG223/U RF Cable	n/a	n/a
00076	Pasternack	PE7014-30	30dB 2 Watt Attenuator	na*	na

*Cable and attenuator verified with power meter prior to use

Applicant:	Itronix Corporation	FCC ID:	KBCIX325-CWL	IC ID:	1943A-IX325ab	
Model(s):	IX325-CWL	IX325 Series Rugged Tablet PC with Cisco AIR-CB21AG-A-K9 802.11 abg WLAN				
2006 Celltech Labs Inc.		This document is not to be reproduced in whole or in part without the prior written permission of Celltech Labs Inc.				Page 15 of 83

	Test Report Serial No.:	040505KBC-F632-E15CW	Report Issue No.:	E632CW-032906-R0
	Test Date(s):	13Sep05 - 27Nov05	Report Issue Date:	March 29, 2006
	Test Rule Part(s):	FCC 47 CFR §15.247	Industry Canada RSS-210 Issue 6	
	Lab Registration(s):	FCC Lab Reg. # 714830	Industry Canada Lab File # IC 3874	

B.5. MEASUREMENT EQUIPMENT SETUP

Measurement Equipment Connections	The equipment was connected as shown in the setup drawing in B.6.
Measurement Equipment Settings	To evaluate the occupied bandwidth, software and a PC controller were used to set the spectrum analyzer using the following setting: RBW – 100 kHz VBW – 100kHz Span – 50 MHz Detector – Sample Average – Power Average Count – 100 Offset – appropriate for external attenuation (-31.4 dB)

B.6. SETUP DRAWING

Figure B.6-1 - Setup Drawing

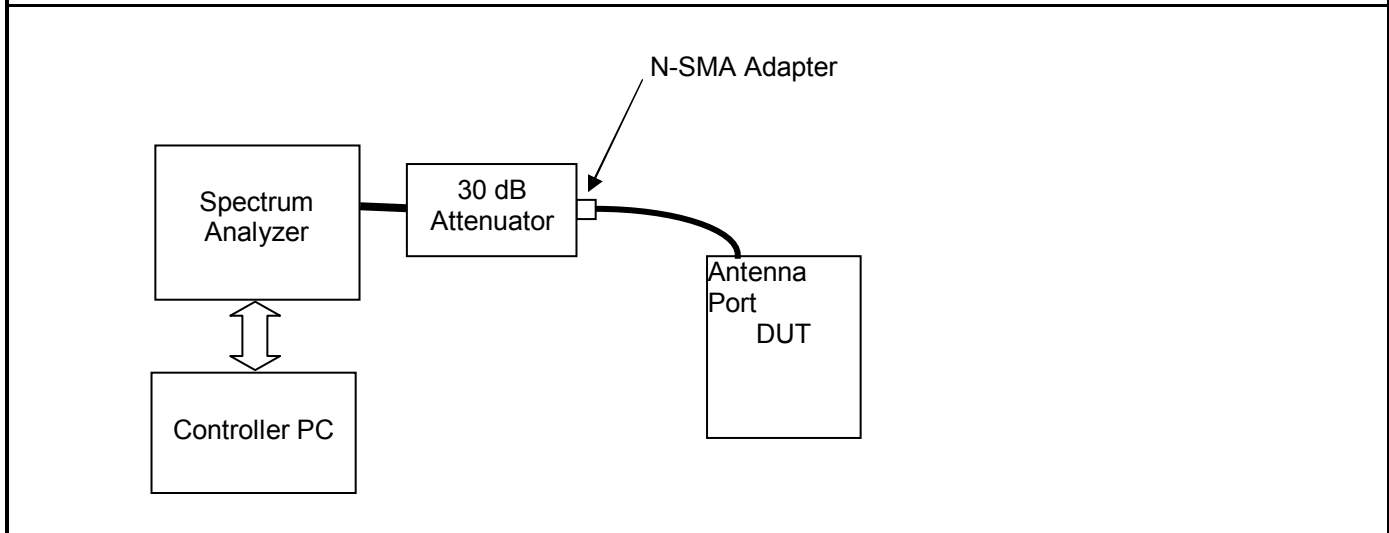

B.7. DUT OPERATING DESCRIPTION

Measurements were made at three channels throughout the band, Low Channel, Mid Channel, High Channel for Modes b and g and the upper band of Mode a, with the lowest and highest data rates.

Applicant:	Itronix Corporation	FCC ID:	KBCIX325-CWL	IC ID:	1943A-IX325ab	
Model(s):	IX325-CWL	IX325 Series Rugged Tablet PC with Cisco AIR-CB21AG-A-K9 802.11 abg WLAN				
2006 Celltech Labs Inc.		This document is not to be reproduced in whole or in part without the prior written permission of Celltech Labs Inc.				Page 16 of 83



Test Report Serial No.:	040505KBC-F632-E15CW	Report Issue No.:	E632CW-032906-R0
Test Date(s):	13Sep05 - 27Nov05	Report Issue Date:	March 29, 2006
Test Rule Part(s):	FCC 47 CFR §15.247	Industry Canada RSS-210 Issue 6	
Lab Registration(s):	FCC Lab Reg. # 714830	Industry Canada Lab File # IC 3874	

B.8. TEST RESULTS

B.8.1. Mode a (upper band) Occupied Bandwidth

IX325 with Cisco abg WLAN Settings: 17.0 & 0.6 mbps, Frequency = 5745 MHz, Mode a, -6 dB Emission Bandwidth = 16.50 MHz with an RBW of 100 kHz

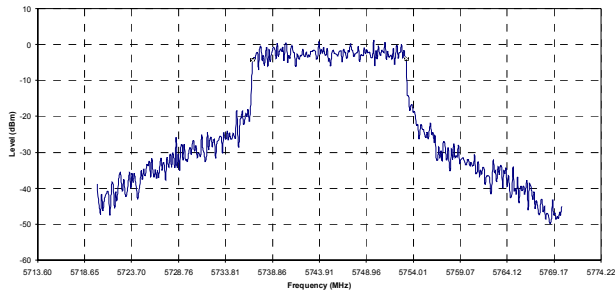

IX325 with Cisco abg WLAN Settings: 14.0 & 0.54 mbps, Frequency = 5745 MHz, Mode a, -6 dB Emission Bandwidth = 16.25 MHz with an RBW of 100 kHz

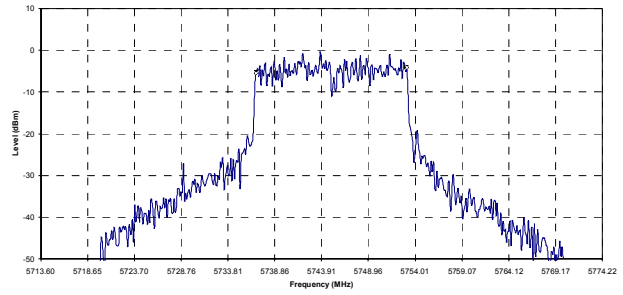

IX325 with Cisco abg WLAN Settings: 17.0 & 0.6 mbps, Frequency = 5785 MHz, Mode a, -6 dB Emission Bandwidth = 16.50 MHz with an RBW of 100 kHz

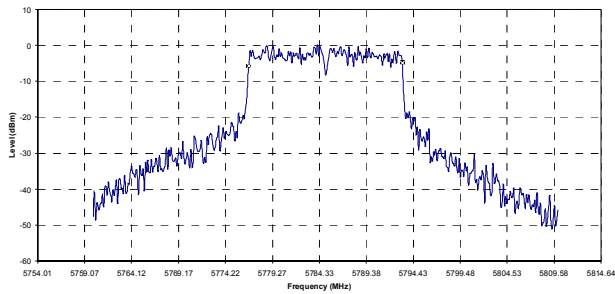

IX325 with Cisco abg WLAN Settings: 14.0 & 0.54 mbps, Frequency = 5785 MHz, Mode a, -6 dB Emission Bandwidth = 16.25 MHz with an RBW of 100 kHz

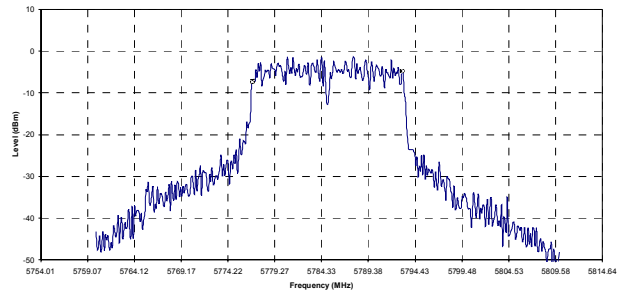

IX325 with Cisco abg WLAN Settings: 17.0 & 0.6 mbps, Frequency = 5825 MHz, Mode a, -6 dB Emission Bandwidth = 16.50 MHz with an RBW of 100 kHz

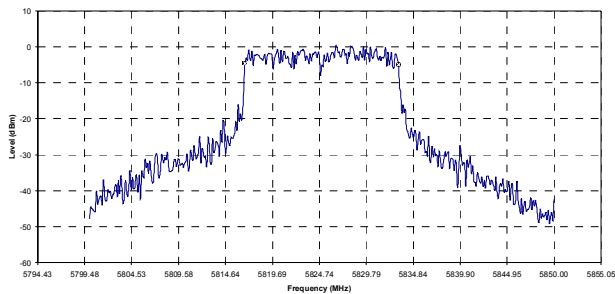

IX325 with Cisco abg WLAN Settings: 14.0 & 0.54 mbps, Frequency = 5825 MHz, Mode a, -6 dB Emission Bandwidth = 16.13 MHz with an RBW of 100 kHz

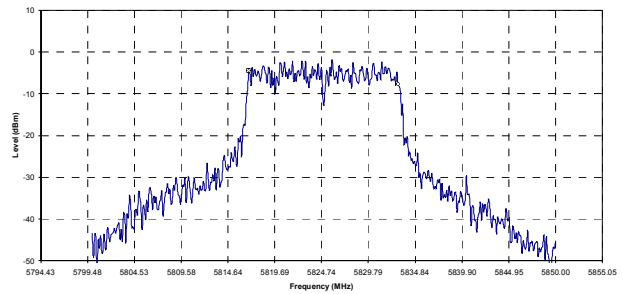

Channel	Channel Frequency MHz	6 dB Bandwidth		Minimum Limit MHz	Pass/Fail
		6 mbps MHz	54 mbps MHz		
149	5745	16.50	16.25	0.5	PASS
157	5785	16.50	16.25	0.5	PASS
165	5825	16.50	16.13	0.5	PASS

Applicant:	Itronix Corporation	FCC ID:	KBCIX325-CWL	IC ID:	1943A-IX325ab	
Model(s):	IX325-CWL	IX325 Series Rugged Tablet PC with Cisco AIR-CB21AG-A-K9 802.11 abg WLAN				
2006 Celltech Labs Inc.		This document is not to be reproduced in whole or in part without the prior written permission of Celltech Labs Inc.				Page 17 of 83



Test Report Serial No.:	040505KBC-F632-E15CW	Report Issue No.:	E632CW-032906-R0
Test Date(s):	13Sep05 - 27Nov05	Report Issue Date:	March 29, 2006
Test Rule Part(s):	FCC 47 CFR §15.247	Industry Canada RSS-210 Issue 6	
Lab Registration(s):	FCC Lab Reg. # 714830	Industry Canada Lab File # IC 3874	

B.8.2. Mode b Occupied Bandwidth

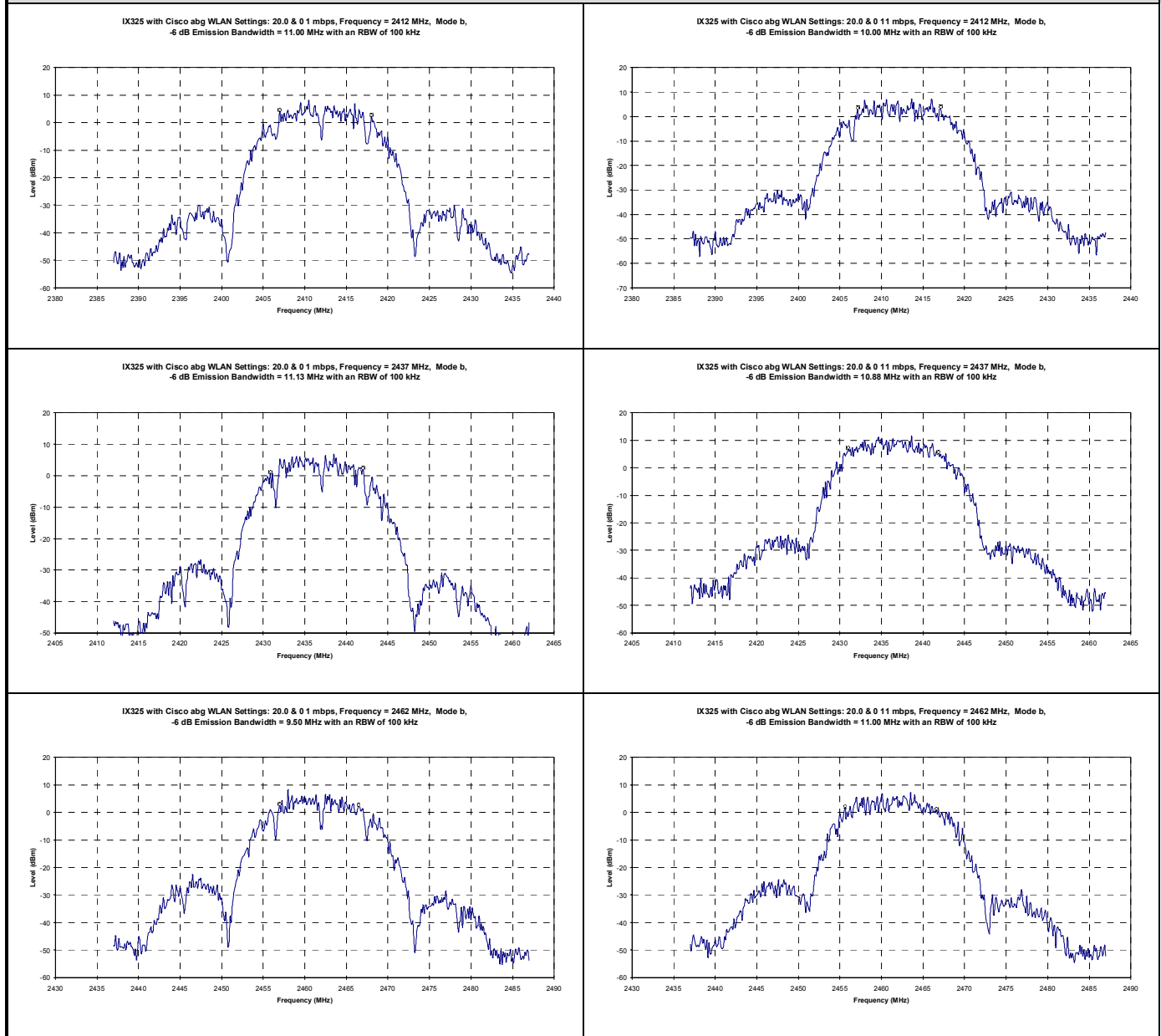

Channel	Channel Frequency MHz	6 dB Bandwidth		Minimum Limit MHz	Pass/Fail
		1 mbps MHz	11 mbps MHz		
1	2412	11.00	10.00	0.5	PASS
6	2437	11.13	10.88	0.5	PASS
11	2462	9.50	11.00	0.5	PASS

Applicant:	Itronix Corporation	FCC ID:	KBCIX325-CWL	IC ID:	1943A-IX325ab	
Model(s):	IX325-CWL	IX325 Series Rugged Tablet PC with Cisco AIR-CB21AG-A-K9 802.11 abg WLAN				
2006 Celltech Labs Inc.		This document is not to be reproduced in whole or in part without the prior written permission of Celltech Labs Inc.				Page 18 of 83



Test Report Serial No.:	040505KBC-F632-E15CW	Report Issue No.:	E632CW-032906-R0
Test Date(s):	13Sep05 - 27Nov05	Report Issue Date:	March 29, 2006
Test Rule Part(s):	FCC 47 CFR §15.247	Industry Canada RSS-210 Issue 6	
Lab Registration(s):	FCC Lab Reg. # 714830	Industry Canada Lab File # IC 3874	

B.8.3. Mode g Occupied Bandwidth

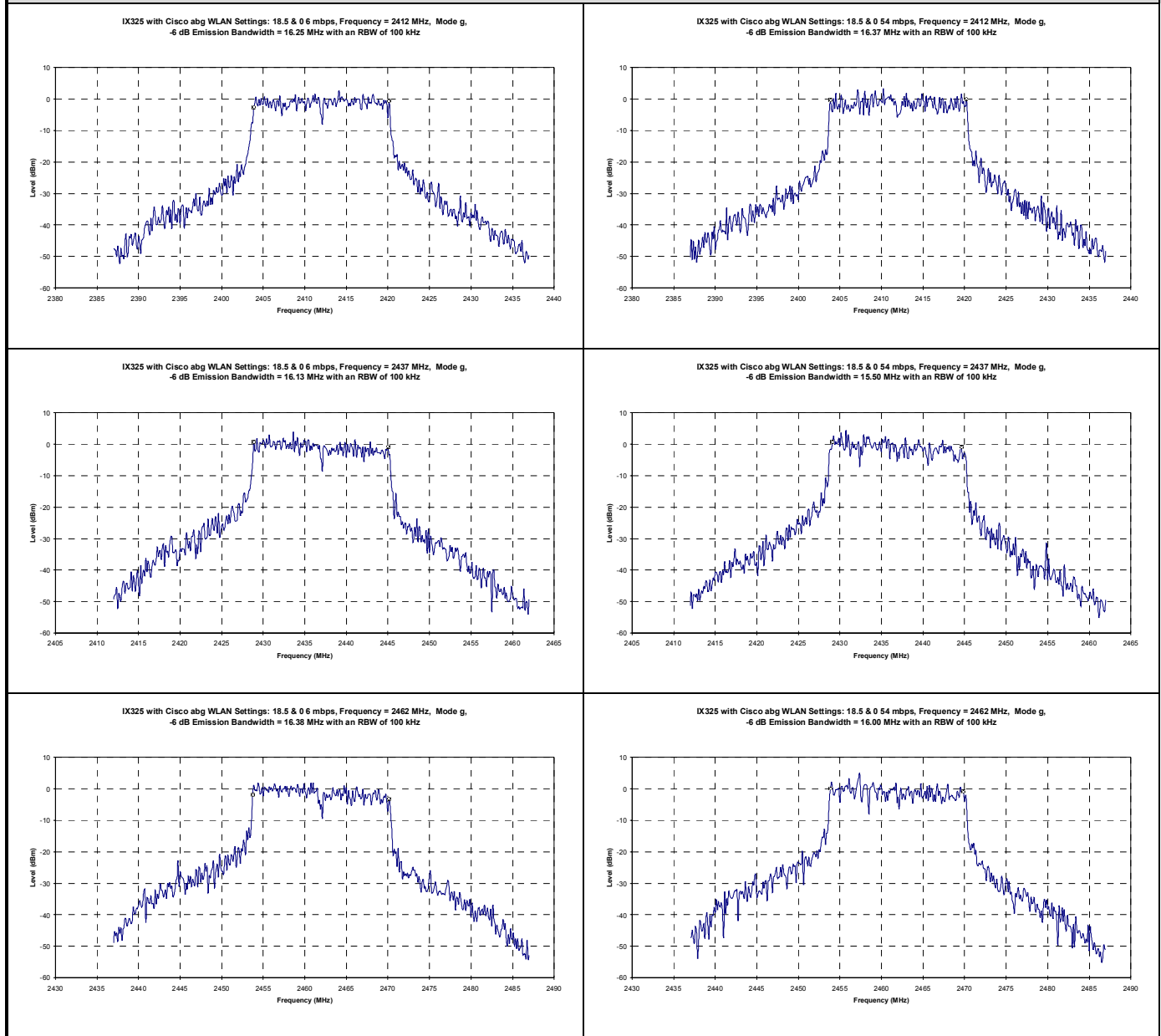

Channel	Channel Frequency MHz	6 dB Bandwidth		Minimum Limit MHz	Pass/Fail
		6 mbps MHz	54 mbps MHz		
1	2412	16.25	16.37	0.5	PASS
6	2437	16.13	15.50	0.5	PASS
11	2462	16.38	16.00	0.5	PASS

Applicant:	Itronix Corporation	FCC ID:	KBCIX325-CWL	IC ID:	1943A-IX325ab	
Model(s):	IX325-CWL	IX325 Series Rugged Tablet PC with Cisco AIR-CB21AG-A-K9 802.11 abg WLAN				
2006 Celltech Labs Inc.		This document is not to be reproduced in whole or in part without the prior written permission of Celltech Labs Inc.				Page 19 of 83

	Test Report Serial No.:	040505KBC-F632-E15CW	Report Issue No.:	E632CW-032906-R0
	Test Date(s):	13Sep05 - 27Nov05	Report Issue Date:	March 29, 2006
	Test Rule Part(s):	FCC 47 CFR §15.247	Industry Canada RSS-210 Issue 6	
	Lab Registration(s):	FCC Lab Reg. # 714830	Industry Canada Lab File # IC 3874	

B.9. PASS/FAIL

In reference to the results outlined in B.8, the DUT passes the requirements as stated in the reference standards as follows:

FCC 15.247 (a) (2): The 6 dB bandwidth as measured meets the minimum 500 kHz bandwidth requirement.

The minimum 6 dB bandwidth was measured for Mode b (1 mbps) and had a value of 9.50 MHz.

B.10. SIGN-OFF

I attest to the accuracy of the data. All measurements reported herein were performed by me and are correct to the best of my knowledge and belief. I assume full responsibility for the completeness of these measurements.



Duane M. Friesen, C.E.T.
EMC Manager
Celltech Labs Inc

23Nov05

Date

Applicant:	Itronix Corporation	FCC ID:	KBCIX325-CWL	IC ID:	1943A-IX325ab	
Model(s):	IX325-CWL	IX325 Series Rugged Tablet PC with Cisco AIR-CB21AG-A-K9 802.11 abg WLAN				
2006 Celltech Labs Inc.		This document is not to be reproduced in whole or in part without the prior written permission of Celltech Labs Inc.				Page 20 of 83

	Test Report Serial No.:	040505KBC-F632-E15CW	Report Issue No.:	E632CW-032906-R0
	Test Date(s):	13Sep05 - 27Nov05	Report Issue Date:	March 29, 2006
	Test Rule Part(s):	FCC 47 CFR §15.247	Industry Canada RSS-210 Issue 6	
	Lab Registration(s):	FCC Lab Reg. # 714830	Industry Canada Lab File # IC 3874	

Appendix C - Peak Conducted Power Measurement

C.1. REFERENCES	
Normative Reference Standard	FCC CFR 47 §15.247(b) (3)
Procedure Reference	FCC Document KDB Publication Number 558074

C.2. LIMITS	
C.2.1. FCC CFR	
<p>§15.247(b): The maximum peak output power of the intentional radiator shall not exceed the following: §15.247(b) (3) For system using digital modulation in the 902 – 928 MHz, 2400 – 2483.5 MHz, and 5725 – 5850 MHz bands: 1 Watt.</p>	

C.3. ENVIRONMENTAL CONDITIONS	
Temperature	25 ± 5 °C
Humidity	35 ± 5 %RH
Barometric Pressure	uncontrolled

C.4. EQUIPMENT LIST					
ASSET NUMBER	MANUFACTURER	MODEL	DESCRIPTION	LAST CAL	CAL DUE
00015	Agilent	E4408B	Spectrum Analyzer	24Jan05	24Jan06
Customer supplied	n/a	n/a	1ft. RG223/U RF Cable	n/a	n/a
00076	Pasternack	PE7014-30	30dB 2 Watt Attenuator	na*	na

*Cable and attenuator verified with power meter prior to use

Applicant:	Itronix Corporation	FCC ID:	KBCIX325-CWL	IC ID:	1943A-IX325ab	
Model(s):	IX325-CWL	IX325 Series Rugged Tablet PC with Cisco AIR-CB21AG-A-K9 802.11 abg WLAN				
2006 Celltech Labs Inc.		This document is not to be reproduced in whole or in part without the prior written permission of Celltech Labs Inc.				Page 21 of 83

	Test Report Serial No.:	040505KBC-F632-E15CW	Report Issue No.:	E632CW-032906-R0
	Test Date(s):	13Sep05 - 27Nov05	Report Issue Date:	March 29, 2006
	Test Rule Part(s):	FCC 47 CFR §15.247	Industry Canada RSS-210 Issue 6	
	Lab Registration(s):	FCC Lab Reg. # 714830	Industry Canada Lab File # IC 3874	

C.5. MEASUREMENT EQUIPMENT SETUP																			
Measurement Equipment Connections	The equipment was connected as shown in the setup drawing in C.6.																		
Measurement Equipment Settings	<p>To evaluate the maximum peak power, with the following spectrum analyzer settings were used:</p> <table border="0"> <tr> <td>[X] Option 2 Method 1</td> <td>[] Option 2 Method 3</td> </tr> <tr> <td>RBW – 1 MHz</td> <td>RBW – 1 MHz</td> </tr> <tr> <td>VBW – 3 MHz</td> <td>VBW – 3 MHz</td> </tr> <tr> <td>Detector – Sample*</td> <td>Detector – Sample*</td> </tr> <tr> <td>Display - Linear</td> <td>Display - Linear</td> </tr> <tr> <td>Averaging – On, Power, 100 traces</td> <td>Averaging – off</td> </tr> <tr> <td>Trace - Write</td> <td>Trace – Max Hold</td> </tr> <tr> <td>Span -25 MHz</td> <td>Span -25 MHz</td> </tr> <tr> <td>Offset – appropriate for external attenuation (-31.4 dB)</td> <td>Offset – appropriate for external attenuation (-31.4 dB)</td> </tr> </table>	[X] Option 2 Method 1	[] Option 2 Method 3	RBW – 1 MHz	RBW – 1 MHz	VBW – 3 MHz	VBW – 3 MHz	Detector – Sample*	Detector – Sample*	Display - Linear	Display - Linear	Averaging – On, Power, 100 traces	Averaging – off	Trace - Write	Trace – Max Hold	Span -25 MHz	Span -25 MHz	Offset – appropriate for external attenuation (-31.4 dB)	Offset – appropriate for external attenuation (-31.4 dB)
[X] Option 2 Method 1	[] Option 2 Method 3																		
RBW – 1 MHz	RBW – 1 MHz																		
VBW – 3 MHz	VBW – 3 MHz																		
Detector – Sample*	Detector – Sample*																		
Display - Linear	Display - Linear																		
Averaging – On, Power, 100 traces	Averaging – off																		
Trace - Write	Trace – Max Hold																		
Span -25 MHz	Span -25 MHz																		
Offset – appropriate for external attenuation (-31.4 dB)	Offset – appropriate for external attenuation (-31.4 dB)																		
Measurement Procedure	A PC controller was used to record the spectrum analyzer display with the above settings. Software was used to integrate the values recorded within the EBW. The resulting channel power was recorded and reported herein.																		

Sample detector used pursuant to the reference document requirements of bin width (25 MHz / 401points = 62 kHz) < 0.5 RBW (0.5 1 MHz = 500 kHz)

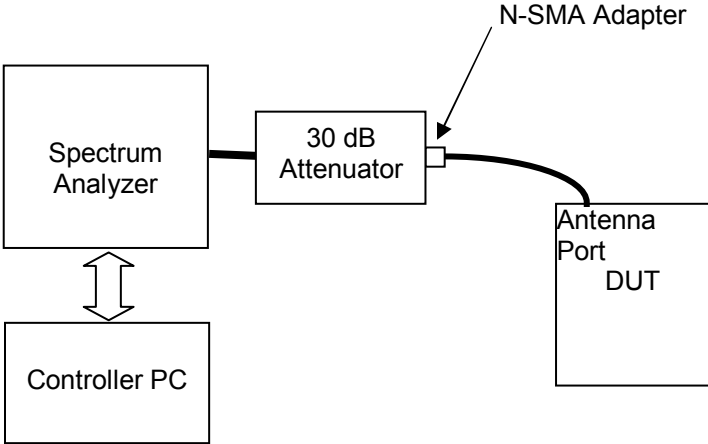
C.6. SETUP DRAWING	
Figure C.6-1 - Setup Drawing	
	

C.7. DUT OPERATING DESCRIPTION	
Measurements were made at three channels throughout the band, Low Channel, Mid Channel, High Channel for Modes b and g and the upper band of Mode a. The measurements were made for both the lowest and highest data rate available for the mode.	

Applicant:	Itronix Corporation	FCC ID:	KBCIX325-CWL	IC ID:	1943A-IX325ab	
Model(s):	IX325-CWL	IX325 Series Rugged Tablet PC with Cisco AIR-CB21AG-A-K9 802.11 abg WLAN				
2006 Celltech Labs Inc.		This document is not to be reproduced in whole or in part without the prior written permission of Celltech Labs Inc.				Page 22 of 83



Test Report Serial No.:	040505KBC-F632-E15CW	Report Issue No.:	E632CW-032906-R0
Test Date(s):	13Sep05 - 27Nov05	Report Issue Date:	March 29, 2006
Test Rule Part(s):	FCC 47 CFR §15.247	Industry Canada RSS-210 Issue 6	
Lab Registration(s):	FCC Lab Reg. # 714830	Industry Canada Lab File # IC 3874	

C.8. TEST RESULTS

C.8.1. Mode a (upper band) Conducted Power

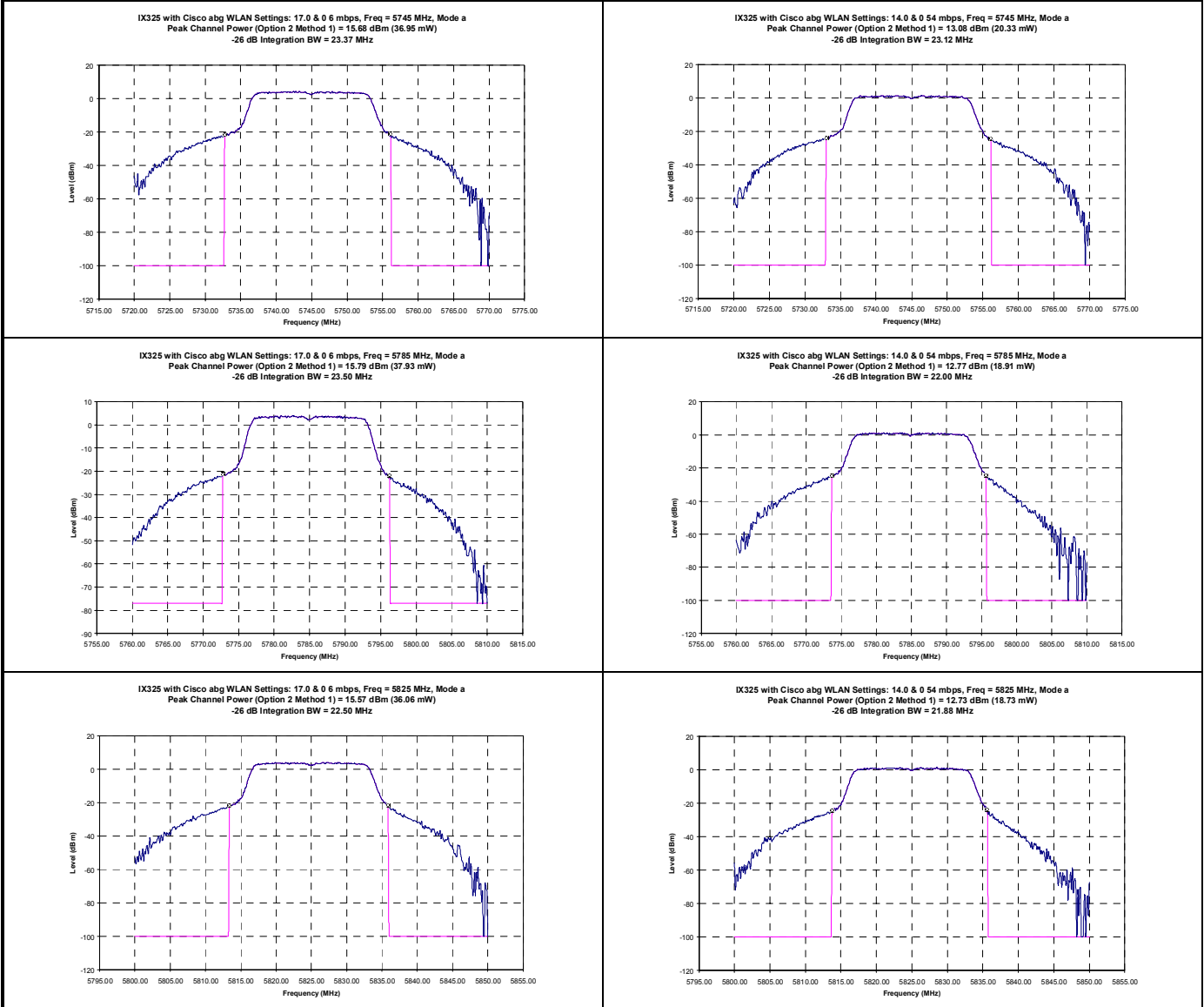

Channel	Channel Frequency MHz	Peak Conducted Power						Limit Watts	Pass/Fail
		6 mbps			54 mbps				
		dBm	Watts	-26 dB EBW (MHz)	dBm	Watts	-26 dB EBW (MHz)		
149	5745	15.68	0.0370	23.37	13.08	0.0203	23.12	1	PASS
157	5785	15.79	0.0379	23.50	12.77	0.0189	22.00	1	PASS
165	5825	15.57	0.0361	22.50	12.73	0.0187	21.88	1	PASS

Applicant:	Itronix Corporation	FCC ID:	KBCIX325-CWL	IC ID:	1943A-IX325ab	ITRONIX A GENERAL DYNAMICS COMPANY	
Model(s):	IX325-CWL	IX325 Series Rugged Tablet PC with Cisco AIR-CB21AG-A-K9 802.11 abg WLAN					
2006 Celltech Labs Inc.		This document is not to be reproduced in whole or in part without the prior written permission of Celltech Labs Inc.					Page 23 of 83



Test Report Serial No.:	040505KBC-F632-E15CW	Report Issue No.:	E632CW-032906-R0
Test Date(s):	13Sep05 - 27Nov05	Report Issue Date:	March 29, 2006
Test Rule Part(s):	FCC 47 CFR §15.247	Industry Canada RSS-210 Issue 6	
Lab Registration(s):	FCC Lab Reg. # 714830	Industry Canada Lab File # IC 3874	

C.8.2. Mode b Conducted Power

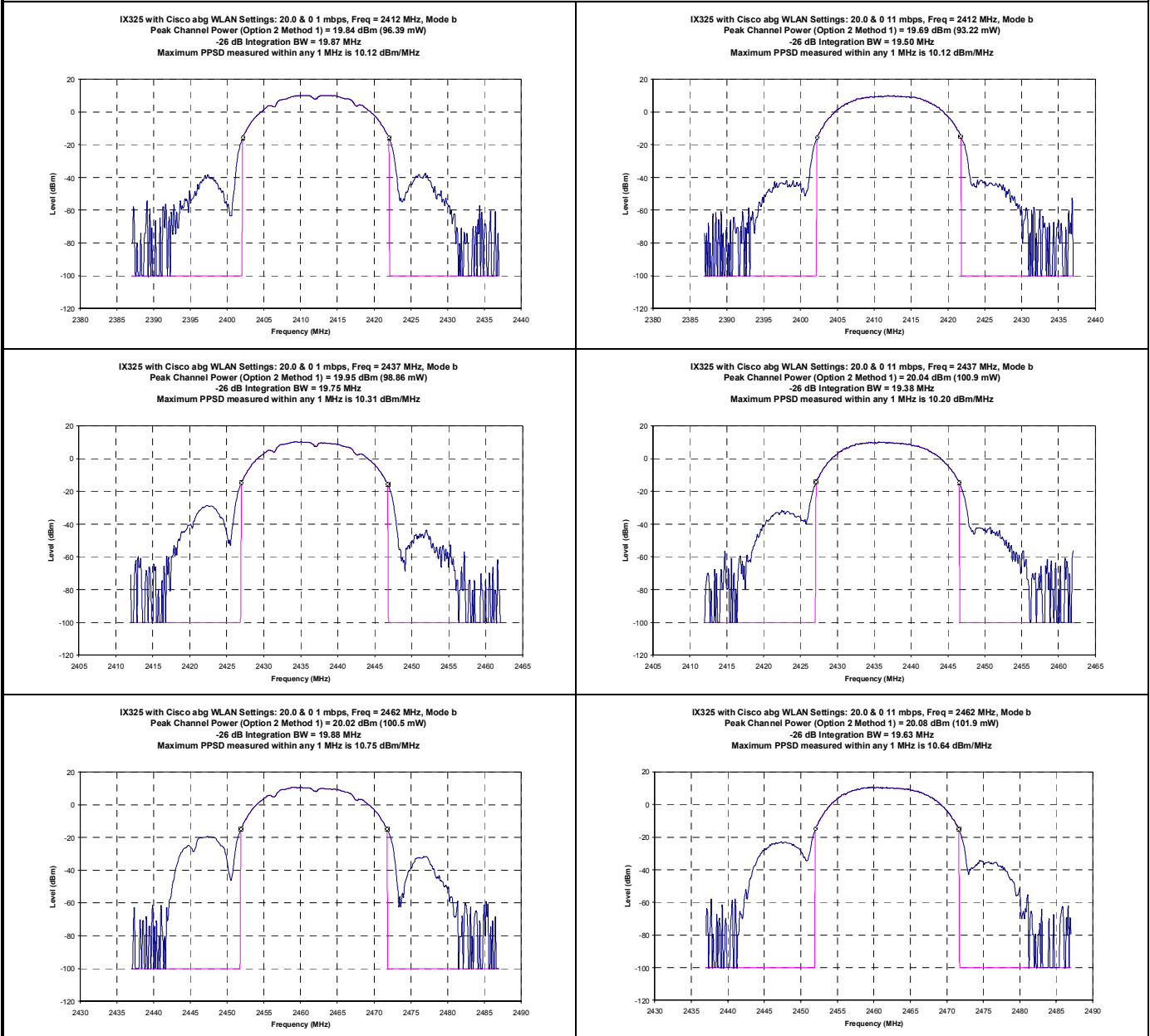

Channel	Channel Frequency MHz	Peak Conducted Power						Limit Watts	Pass/Fail
		1 mbps			11 mbps				
		dBm	Watts	-26 dB EBW (MHz)	dBm	Watts	-26 dB EBW (MHz)		
1	2412	19.84	0.0964	19.87	19.69	0.0932	19.50	1	PASS
6	2437	19.95	0.0989	19.75	20.04	0.1009	19.38	1	PASS
11	2462	20.02	0.1005	19.88	20.08	0.1019	19.63	1	PASS

Applicant:	Itronix Corporation	FCC ID:	KBCIX325-CWL	IC ID:	1943A-IX325ab	ITRONIX A GENERAL DYNAMICS COMPANY	
Model(s):	IX325-CWL	IX325 Series Rugged Tablet PC with Cisco AIR-CB21AG-A-K9 802.11 abg WLAN					
2006 Celltech Labs Inc.		This document is not to be reproduced in whole or in part without the prior written permission of Celltech Labs Inc.					Page 24 of 83



Test Report Serial No.:	040505KBC-F632-E15CW	Report Issue No.:	E632CW-032906-R0
Test Date(s):	13Sep05 - 27Nov05	Report Issue Date:	March 29, 2006
Test Rule Part(s):	FCC 47 CFR §15.247	Industry Canada RSS-210 Issue 6	
Lab Registration(s):	FCC Lab Reg. # 714830	Industry Canada Lab File # IC 3874	

C.8.3. Mode g Conducted Power

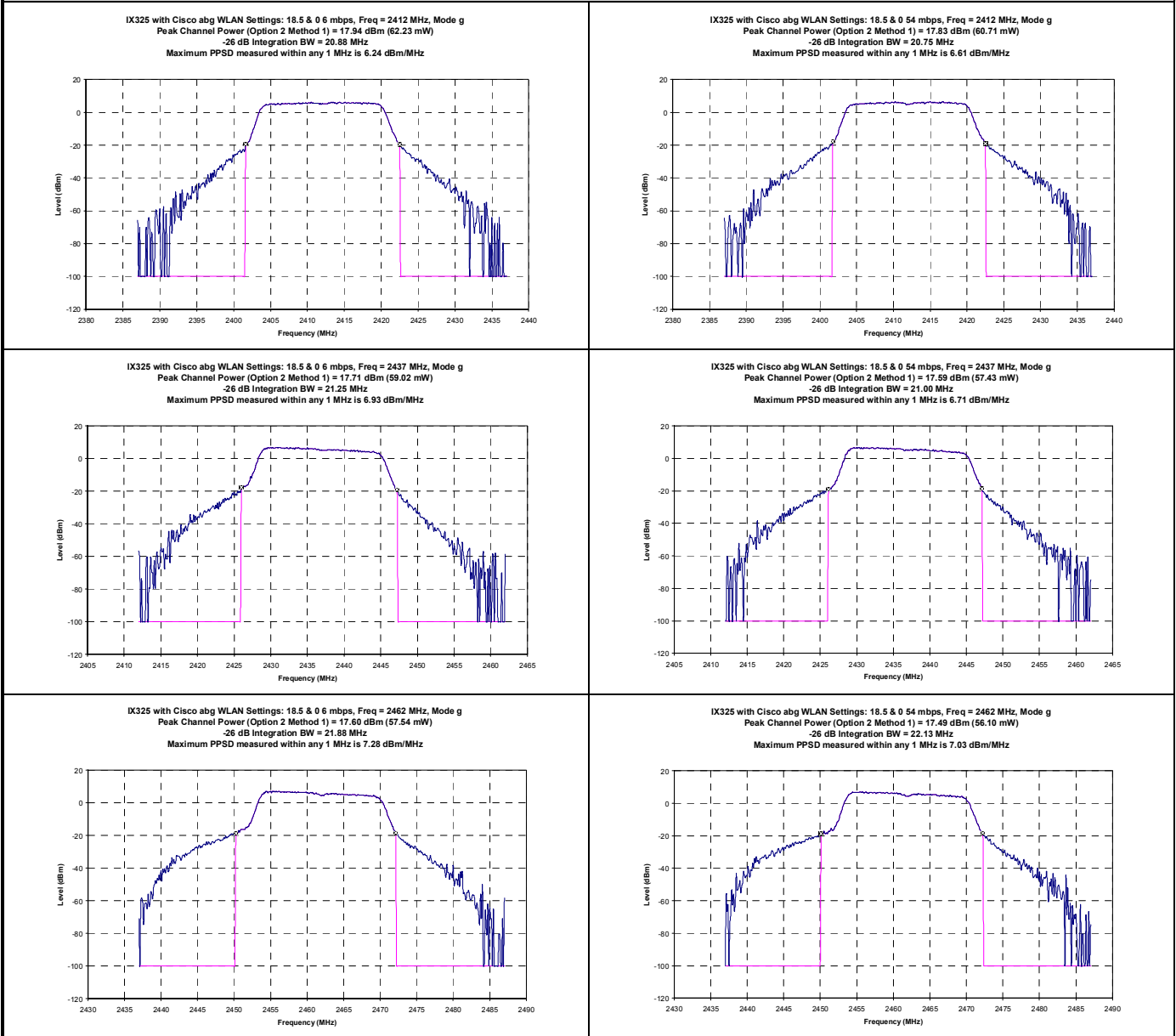

Channel	Channel Frequency MHz	Peak Conducted Power						Limit Watts	Pass/Fail
		6 mbps			54 mbps				
		dBm	Watts	-26 dB EBW (MHz)	dBm	Watts	-26 dB EBW (MHz)		
1	2412	17.94	0.0622	20.88	17.83	0.0607	20.75	1	PASS
6	2437	17.71	0.0590	21.25	17.59	0.0574	21.00	1	PASS
11	2462	17.60	0.0575	21.88	17.49	0.0561	22.13	1	PASS

	Test Report Serial No.:	040505KBC-F632-E15CW	Report Issue No.:	E632CW-032906-R0
	Test Date(s):	13Sep05 - 27Nov05	Report Issue Date:	March 29, 2006
	Test Rule Part(s):	FCC 47 CFR §15.247	Industry Canada RSS-210 Issue 6	
	Lab Registration(s):	FCC Lab Reg. # 714830	Industry Canada Lab File # IC 3874	

C.9. PASS/FAIL

In reference to the results outlined in C.8 the DUT passes the requirements as stated in the reference standards as follows:

FCC 15.247 (b) (3): The peak power did not exceed 1 Watt.

The maximum power was measured for Mode b Channel 11 (11 mbps) and had a value of 0.1019 watts (20.08 dBm).

C.10. SIGN-OFF

I attest to the accuracy of the data. All measurements reported herein were performed by me and are correct to the best of my knowledge and belief. I assume full responsibility for the completeness of these measurements.



Duane M. Friesen, C.E.T.
EMC Manager
Celltech Labs Inc

23Nov05

Date

Applicant:	Itronix Corporation	FCC ID:	KBCIX325-CWL	IC ID:	1943A-IX325ab	
Model(s):	IX325-CWL	IX325 Series Rugged Tablet PC with Cisco AIR-CB21AG-A-K9 802.11 abg WLAN				
2006 Celltech Labs Inc.		This document is not to be reproduced in whole or in part without the prior written permission of Celltech Labs Inc.				Page 26 of 83

	Test Report Serial No.:	040505KBC-F632-E15CW	Report Issue No.:	E632CW-032906-R0
	Test Date(s):	13Sep05 - 27Nov05	Report Issue Date:	March 29, 2006
	Test Rule Part(s):	FCC 47 CFR §15.247	Industry Canada RSS-210 Issue 6	
	Lab Registration(s):	FCC Lab Reg. # 714830	Industry Canada Lab File # IC 3874	

Appendix D - Conducted Receiver Spurious Emissions Measurement

D.1. REFERENCES	
Normative Reference Standard	IC RSS-GEN§6 (b)
Procedure Reference	IC RSS-GEN§4.8 (b)

D.2. LIMITS	
IC RSS-GEN§6	<i>(b) If a conducted measurement is made, no spurious output signals appearing at the antenna terminals shall exceed 2 nanowatts per 4 kHz spurious frequency in the band 30-1000 MHz, or 5 nanowatts above 1 GHz.</i>

D.3. ENVIRONMENTAL CONDITIONS	
Temperature	25 ± 5 °C
Humidity	35 ± 5 %RH
Barometric Pressure	uncontrolled

D.4. EQUIPMENT LIST					
ASSET NUMBER	MANUFACTURER	MODEL	DESCRIPTION	LAST CAL	CAL DUE
00015	Agilent	E4408B	Spectrum Analyzer	24Jan05	24Jan06
Customer supplied	n/a	n/a	1ft. RG223/U RF Cable	n/a	n/a
00076	Narda	4779-2	2x2dB 2 Watt Attenuator	na*	na

*Verification made prior to measurement

Applicant:	Itronix Corporation	FCC ID:	KBCIX325-CWL	IC ID:	1943A-IX325ab	
Model(s):	IX325-CWL	IX325 Series Rugged Tablet PC with Cisco AIR-CB21AG-A-K9 802.11 abg WLAN				
2006 Celltech Labs Inc.		This document is not to be reproduced in whole or in part without the prior written permission of Celltech Labs Inc.				Page 27 of 83

	Test Report Serial No.:	040505KBC-F632-E15CW	Report Issue No.:	E632CW-032906-R0
	Test Date(s):	13Sep05 - 27Nov05	Report Issue Date:	March 29, 2006
	Test Rule Part(s):	FCC 47 CFR §15.247	Industry Canada RSS-210 Issue 6	
	Lab Registration(s):	FCC Lab Reg. # 714830	Industry Canada Lab File # IC 3874	

D.5. MEASUREMENT EQUIPMENT SETUP	
MEASUREMENT EQUIPMENT CONNECTIONS	The equipment was connected as shown in the setup drawing in D.6.
MEASUREMENT EQUIPMENT SETTINGS	RBW – 100 kHz* VBW – 1 MHz Span – Carrier region – 1.0 MHz / 5bands (modes b & g), 0.6 MHz / 5 bands (mode a) Outside carrier region – 22.5 GHz / 12 bands (modes b &g), 22 GHz / 12 bands (mode a) Detector – Peak Averaging – off Max Hold – on Sweeps - 20
Measurement Procedure	A PC controller was used to record the spectrum analyzer display with the above settings. It was used to set the spans and collect the data. Software was used to present a graphical presentation of the combined data collected for each channel.

*Worst case 100 kHz RBW vs. 4 kHz specified in the reference document used to reduce test time

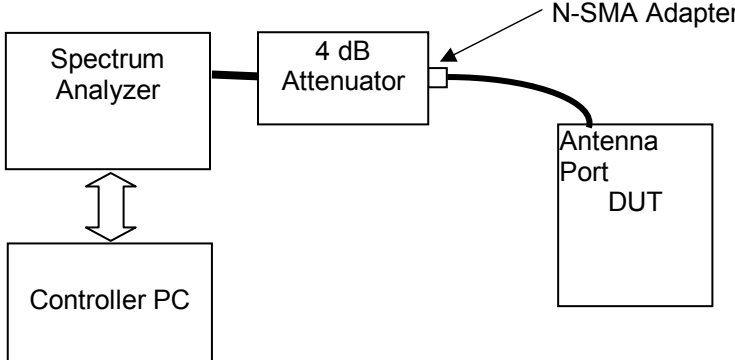
D.6. SETUP DRAWINGS	
Figure D.6-1 - Setup Drawing	
	

D.7. DUT OPERATING DESCRIPTION	
Measurements were made at three channels throughout the band, Low Channel, Mid Channel, High Channel for Modes b and g and the upper band of Mode a. (low and high for reference only) for each of the main and auxiliary ports.	

Applicant:	Itronix Corporation	FCC ID:	KBCIX325-CWL	IC ID:	1943A-IX325ab	
Model(s):	IX325-CWL	IX325 Series Rugged Tablet PC with Cisco AIR-CB21AG-A-K9 802.11 abg WLAN				
2006 Celltech Labs Inc.		This document is not to be reproduced in whole or in part without the prior written permission of Celltech Labs Inc.				Page 28 of 83



Test Report Serial No.:	040505KBC-F632-E15CW	Report Issue No.:	E632CW-032906-R0
Test Date(s):	13Sep05 - 27Nov05	Report Issue Date:	March 29, 2006
Test Rule Part(s):	FCC 47 CFR §15.247	Industry Canada RSS-210 Issue 6	
Lab Registration(s):	FCC Lab Reg. # 714830	Industry Canada Lab File # IC 3874	

D.8. TEST RESULTS

D.8.1. Mode a (upper band) Conducted Receiver Spurious Emissions

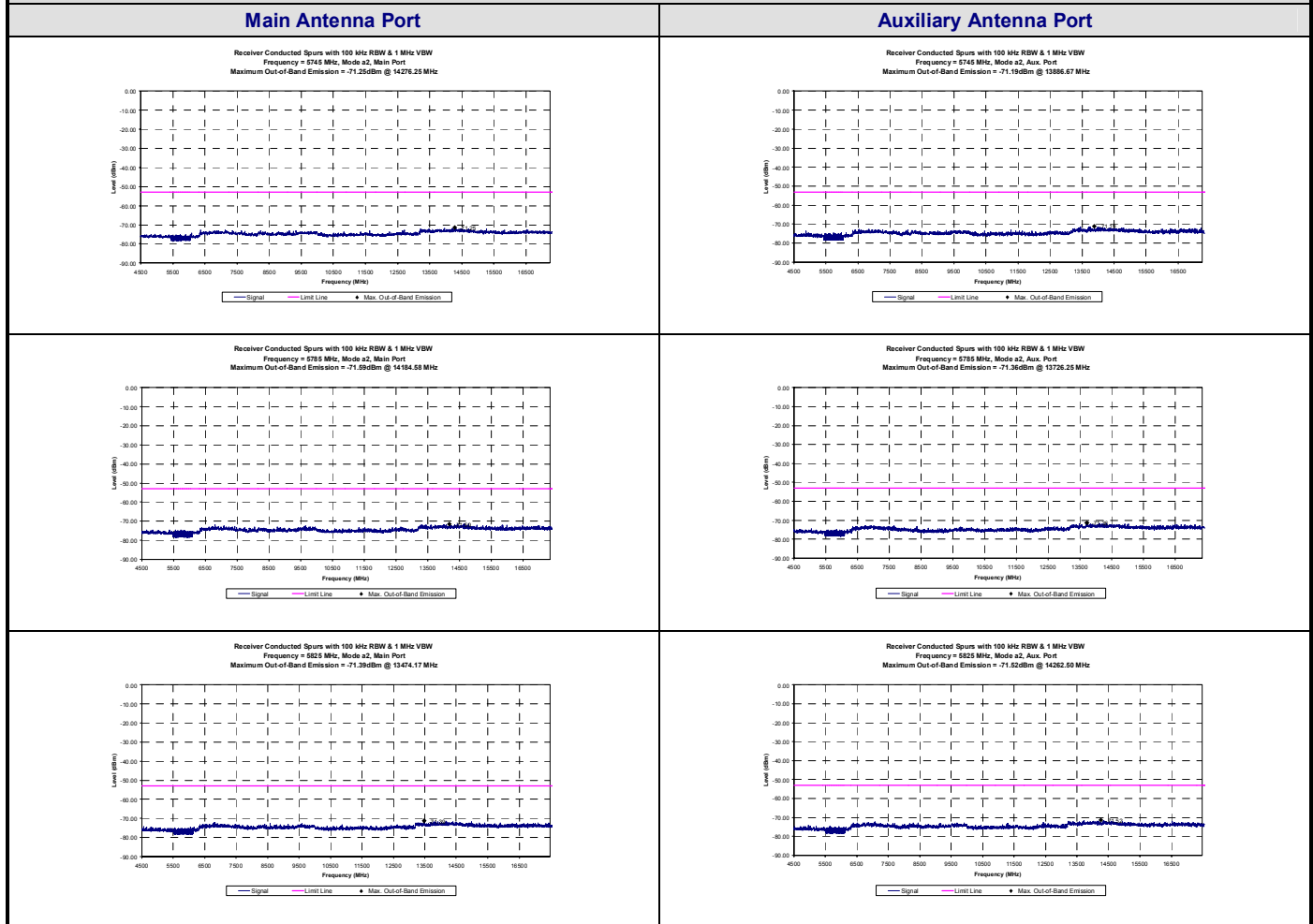

Main Antenna Port								
Channel	Channel Frequency (MHz)	Highest Conducted Out-of-band Spurious Emission		Limit		Margin (dB)	Pass/Fail	
		Frequency (MHz)	Level (dBm)	(nanowatts)	(dBm)			
149	5745	14276.25	-71.25	5	-53	18.25	Pass*	
157	5785	14184.58	-71.59	5	-53	18.59	Pass	
165	5825	13474.17	-71.39	5	-53	18.39	Pass*	
Auxiliary Antenna Port								
149	5745	13886.67	-71.19	5	-53	18.19	Pass*	
157	5785	13726.25	-71.36	5	-53	18.36	Pass	
165	5825	14262.50	-71.52	5	-53	18.52	Pass*	

*Reference only

Applicant:	Itronix Corporation	FCC ID:	KBCIX325-CWL	IC ID:	1943A-IX325ab	
Model(s):	IX325-CWL	IX325 Series Rugged Tablet PC with Cisco AIR-CB21AG-A-K9 802.11 abg WLAN				
2006 Celltech Labs Inc.		This document is not to be reproduced in whole or in part without the prior written permission of Celltech Labs Inc.				Page 29 of 83



Test Report Serial No.:	040505KBC-F632-E15CW	Report Issue No.:	E632CW-032906-R0
Test Date(s):	13Sep05 - 27Nov05	Report Issue Date:	March 29, 2006
Test Rule Part(s):	FCC 47 CFR §15.247	Industry Canada RSS-210 Issue 6	
Lab Registration(s):	FCC Lab Reg. # 714830	Industry Canada Lab File # IC 3874	

D.8.2. Mode b Conducted Receiver Spurious Emissions

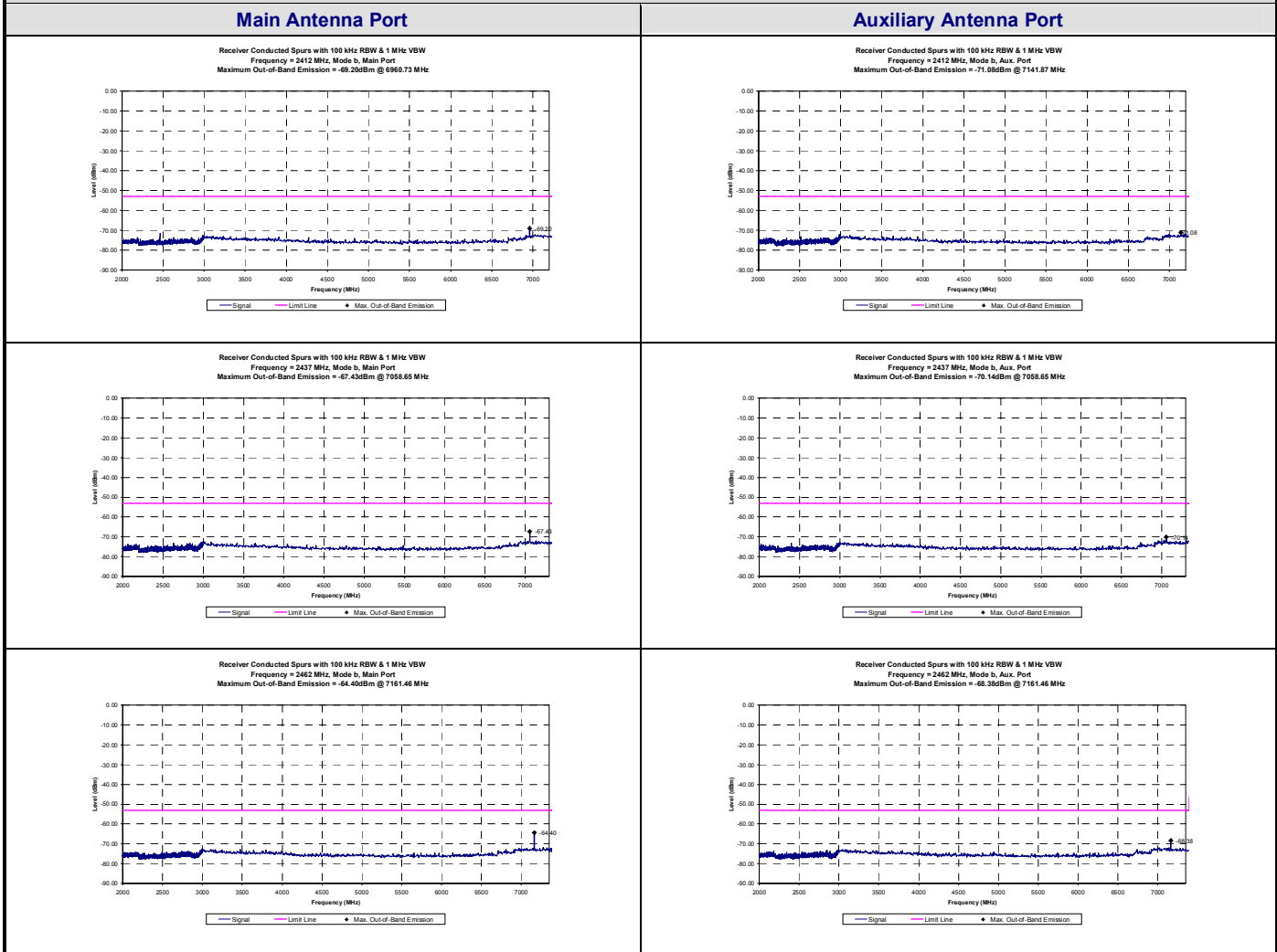

Main Antenna Port							
Channel	Channel Frequency (MHz)	Highest Conducted Out-of-band Spurious Emission		Limit		Margin (dB)	Pass/Fail
		Frequency (MHz)	Level (dBm)	(nanowatts)	(dBm)		
1	2412	6960.73	-69.20	5	-53	16.20	Pass*
6	2437	7058.65	-67.43	5	-53	14.43	Pass
11	2462	7161.46	-64.40	5	-53	11.40	Pass*
Auxiliary Antenna Port							
1	2412	7141.87	-71.08	5	-53	18.08	Pass*
6	2437	7058.65	-70.14	5	-53	17.14	Pass
11	2462	7161.46	-68.38	5	-53	15.38	Pass*

*Reference only

Applicant:	Itronix Corporation	FCC ID:	KBCIX325-CWL	IC ID:	1943A-IX325ab	
Model(s):	IX325-CWL	IX325 Series Rugged Tablet PC with Cisco AIR-CB21AG-A-K9 802.11 abg WLAN				
2006 Celltech Labs Inc.		This document is not to be reproduced in whole or in part without the prior written permission of Celltech Labs Inc.				Page 30 of 83



Test Report Serial No.:	040505KBC-F632-E15CW	Report Issue No.:	E632CW-032906-R0
Test Date(s):	13Sep05 - 27Nov05	Report Issue Date:	March 29, 2006
Test Rule Part(s):	FCC 47 CFR §15.247	Industry Canada RSS-210 Issue 6	
Lab Registration(s):	FCC Lab Reg. # 714830	Industry Canada Lab File # IC 3874	

D.8.3. Mode g Conducted Receiver Spurious Emissions

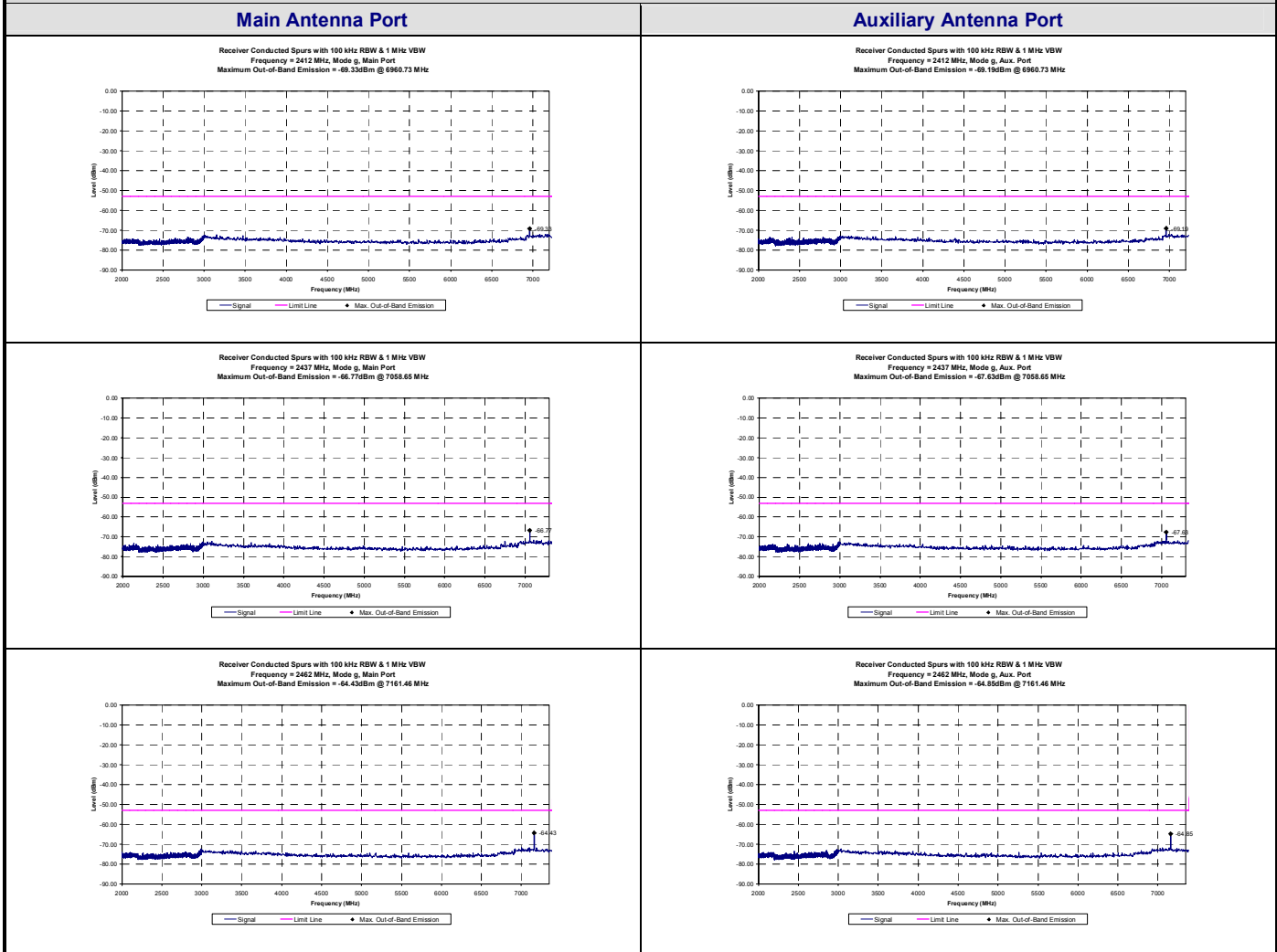

Main Antenna Port							
Channel	Channel Frequency (MHz)	Highest Conducted Out-of-band Spurious Emission		Limit		Margin (dB)	Pass/Fail
		Frequency (MHz)	Level (dBm)	(nanowatts)	(dBm)		
1	2412	6960.73	-69.33	5	-53	16.33	Pass*
6	2437	7058.65	-66.77	5	-53	13.77	Pass
11	2462	7161.46	-64.43	5	-53	11.43	Pass*
Auxiliary Antenna Port							
1	2412	6960.73	-69.19	5	-53	16.19	Pass*
6	2437	7058.65	-67.63	5	-53	14.63	Pass
11	2462	7161.46	-64.85	5	-53	11.85	Pass*

*Reference only

Applicant:	Itronix Corporation	FCC ID:	KBCIX325-CWL	IC ID:	1943A-IX325ab	
Model(s):	IX325-CWL	IX325 Series Rugged Tablet PC with Cisco AIR-CB21AG-A-K9 802.11 abg WLAN				
2006 Celltech Labs Inc.		This document is not to be reproduced in whole or in part without the prior written permission of Celltech Labs Inc.				Page 31 of 83

	Test Report Serial No.:	040505KBC-F632-E15CW	Report Issue No.:	E632CW-032906-R0
	Test Date(s):	13Sep05 - 27Nov05	Report Issue Date:	March 29, 2006
	Test Rule Part(s):	FCC 47 CFR §15.247	Industry Canada RSS-210 Issue 6	
	Lab Registration(s):	FCC Lab Reg. # 714830	Industry Canada Lab File # IC 3874	

D.9. PASS/FAIL

In reference to the results outlined in D.8, the DUT passes the requirements as stated in the reference standards as follows:

IC RSS-GEN (6) (b): If a conducted measurement is made, no spurious output signals appearing at the antenna terminals shall exceed 2 nanowatts per 4 kHz spurious frequency in the band 30-1000 MHz, or 5 nanowatts above 1 GHz.

No emissions were measured below 1 GHz. The emission above 1 GHz, with the lowest margin was measured at 7058.65 MHz, with a level of -66.77 dBm vs. the limit of -53 dBm (5 nW), resulting in a 13.77 dB margin with the DUT receiving on the auxiliary antenna port in Mode g.

D.10. SIGN-OFF

I attest to the accuracy of the data. All measurements reported herein were performed by me and are correct to the best of my knowledge and belief. I assume full responsibility for the completeness of these measurements.



 Duane M. Friesen, C.E.T.
 EMC Manager
 Celltech Labs Inc.

 24Nov05
 Date

Applicant:	Itronix Corporation	FCC ID:	KBCIX325-CWL	IC ID:	1943A-IX325ab	
Model(s):	IX325-CWL	IX325 Series Rugged Tablet PC with Cisco AIR-CB21AG-A-K9 802.11 abg WLAN				
2006 Celltech Labs Inc.		This document is not to be reproduced in whole or in part without the prior written permission of Celltech Labs Inc.				Page 32 of 83

	Test Report Serial No.:	040505KBC-F632-E15CW	Report Issue No.:	E632CW-032906-R0
	Test Date(s):	13Sep05 - 27Nov05	Report Issue Date:	March 29, 2006
	Test Rule Part(s):	FCC 47 CFR §15.247	Industry Canada RSS-210 Issue 6	
	Lab Registration(s):	FCC Lab Reg. # 714830	Industry Canada Lab File # IC 3874	

Appendix E - Conducted Transmitter Spurious Emissions Measurement

E.1. REFERENCES	
Normative Reference Standard	FCC CFR 47 §15.247(d)
Procedure Reference	ANSI C63.4; FCC 97-114

E.2. LIMITS	
FCC CFR 47 §15.247(d)	<i>In any 100 kHz bandwidth outside the frequency band in which the spread spectrum or digitally modulated intentional radiator is operating, the radio frequency power that is produced by the intentional radiator shall be at least 20 dB below that in the 100 kHz bandwidth within the band that contains the highest level of desired power, based on either an RF conducted or a radiated measurement. Attenuation below the general limits specified in 15.209 (a) is not required.*</i>

*Radiated spurious measurements are outlined in Appendix F & G.

E.3. ENVIRONMENTAL CONDITIONS	
Temperature	25 ± 5 °C
Humidity	35 ± 5 %RH
Barometric Pressure	uncontrolled

E.4. EQUIPMENT LIST					
ASSET NUMBER	MANUFACTURER	MODEL	DESCRIPTION	LAST CAL	CAL DUE
00015	Agilent	E4408B	Spectrum Analyzer	24Jan05	24Jan06
Customer supplied	n/a	n/a	1ft. RG223/U RF Cable	n/a	n/a
00076	Pasternack	PE7014-30	30 dB Attenuator	na*	na

*Verification made prior to measurement

Applicant:	Itronix Corporation	FCC ID:	KBCIX325-CWL	IC ID:	1943A-IX325ab	
Model(s):	IX325-CWL	IX325 Series Rugged Tablet PC with Cisco AIR-CB21AG-A-K9 802.11 abg WLAN				
2006 Celltech Labs Inc.		This document is not to be reproduced in whole or in part without the prior written permission of Celltech Labs Inc.				Page 33 of 83

	Test Report Serial No.:	040505KBC-F632-E15CW	Report Issue No.:	E632CW-032906-R0
	Test Date(s):	13Sep05 - 27Nov05	Report Issue Date:	March 29, 2006
	Test Rule Part(s):	FCC 47 CFR §15.247	Industry Canada RSS-210 Issue 6	
	Lab Registration(s):	FCC Lab Reg. # 714830	Industry Canada Lab File # IC 3874	

E.5. MEASUREMENT EQUIPMENT SETUP	
MEASUREMENT EQUIPMENT CONNECTIONS	The equipment was connected as shown in the setup drawing in E.6.
MEASUREMENT EQUIPMENT SETTINGS	RBW – 100 kHz VBW – 1 MHz Span – Carrier region – 1.0 MHz / 5bands (modes b & g), 0.6 MHz / 5 bands (mode a) Outside carrier region – 22.5 GHz / 12 bands (modes b &g), 22 GHz / 12 bands (mode a) Detector – Peak Averaging – off Max Hold – on Sweeps - 20
Measurement Procedure	A PC controller was used to record the spectrum analyzer display with the above settings. It was used to set the spans and collect the data. Software was used to present a graphical presentation of the combined data collected for each channel.

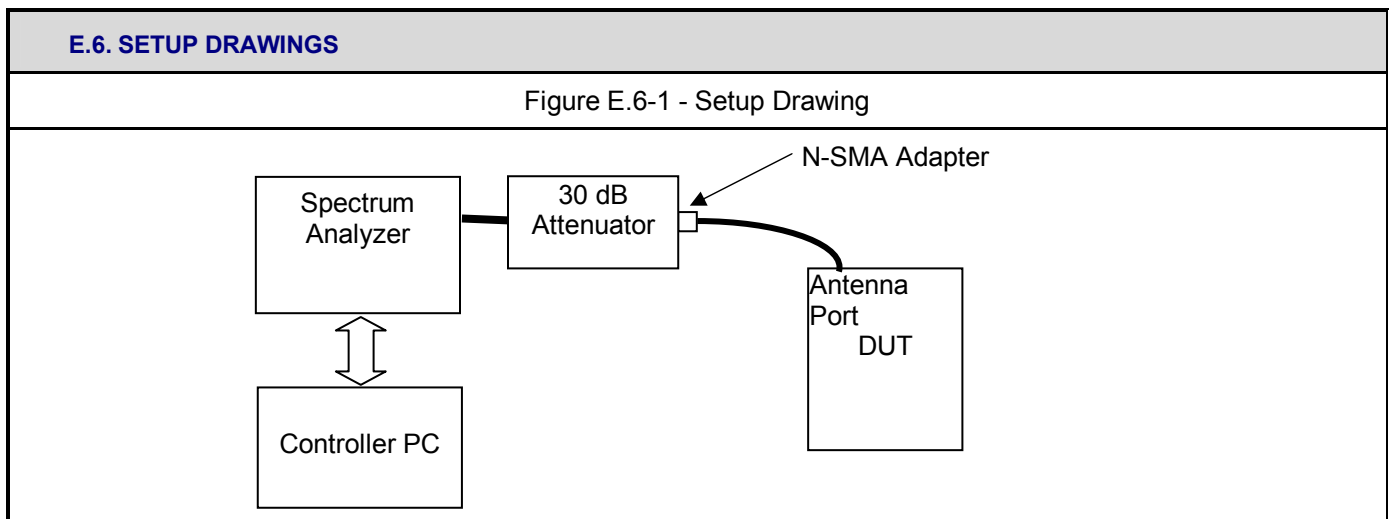

E.7. DUT OPERATING DESCRIPTION	
Measurements were made at three channels throughout the band, Low Channel, Mid Channel, High Channel for Modes b and g and the upper band of Mode a, for each of the lowest and highest data rates	

Applicant:	Itronix Corporation	FCC ID:	KBCIX325-CWL	IC ID:	1943A-IX325ab	
Model(s):	IX325-CWL	IX325 Series Rugged Tablet PC with Cisco AIR-CB21AG-A-K9 802.11 abg WLAN				
2006 Celltech Labs Inc.		This document is not to be reproduced in whole or in part without the prior written permission of Celltech Labs Inc.				Page 34 of 83



Test Report Serial No.:	040505KBC-F632-E15CW	Report Issue No.:	E632CW-032906-R0
Test Date(s):	13Sep05 - 27Nov05	Report Issue Date:	March 29, 2006
Test Rule Part(s):	FCC 47 CFR §15.247	Industry Canada RSS-210 Issue 6	
Lab Registration(s):	FCC Lab Reg. # 714830	Industry Canada Lab File # IC 3874	

E.8. TEST RESULTS

E.8.1. Mode a (upper band) 6 mbps - Conducted Transmitter Spurious Emissions

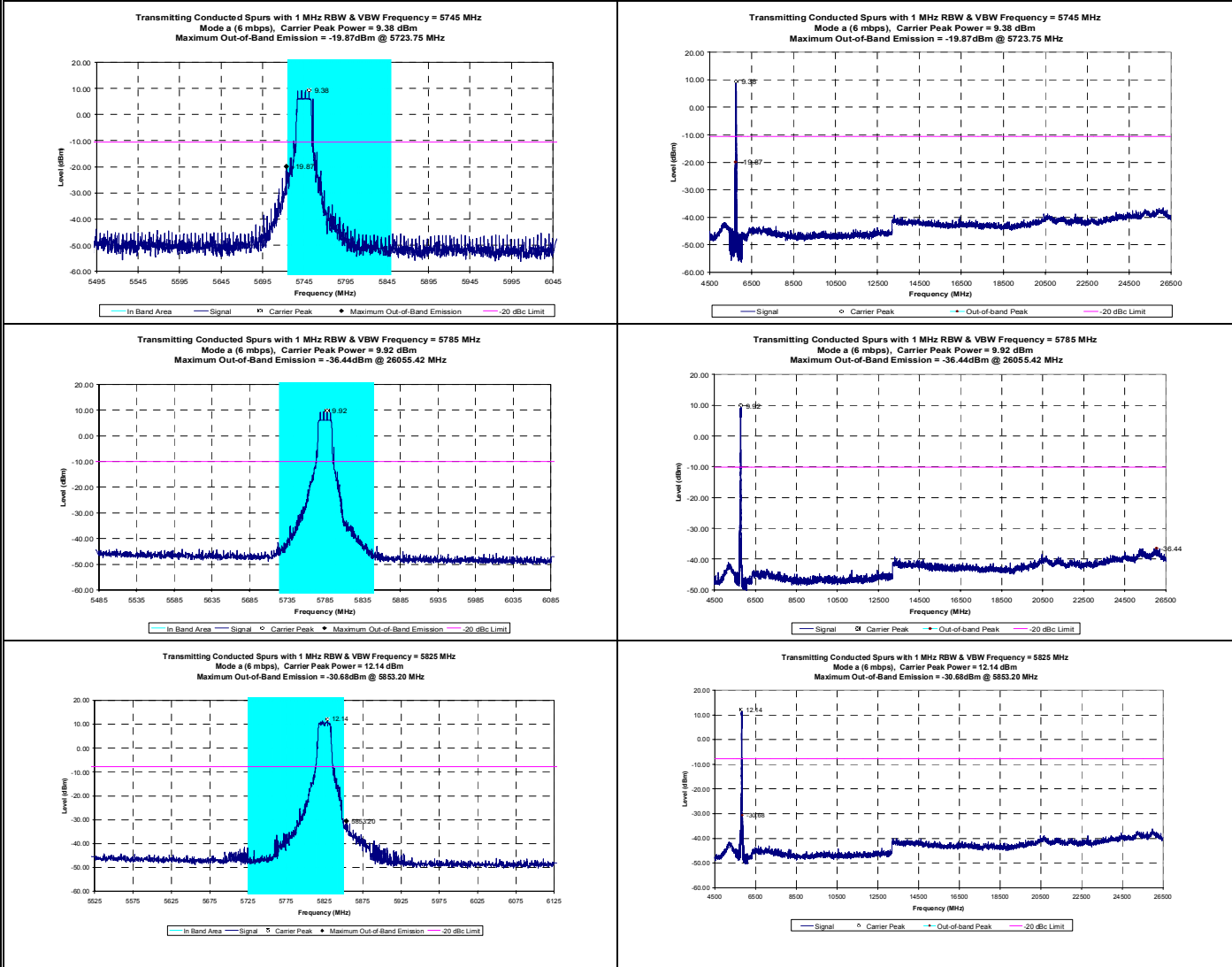

Channel	Channel Frequency (MHz)	Highest Conducted Out-of-band Spurious Emission		Limit (dBm)	Margin (dB)	Pass/Fail
		Frequency (MHz)	Level (dBm)			
149	5745	5723.75	-19.87	-10.62	9.24	Pass
157	5785	26055.42	-36.44	-10.08	26.36	Pass
165	5825	5853.20	-30.68	-7.86	22.82	Pass



Test Report Serial No.:	040505KBC-F632-E15CW	Report Issue No.:	E632CW-032906-R0
Test Date(s):	13Sep05 - 27Nov05	Report Issue Date:	March 29, 2006
Test Rule Part(s):	FCC 47 CFR §15.247	Industry Canada RSS-210 Issue 6	
Lab Registration(s):	FCC Lab Reg. # 714830	Industry Canada Lab File # IC 3874	

E.8.2. Mode a (upper band) 54 mbps - Conducted Transmitter Spurious Emissions

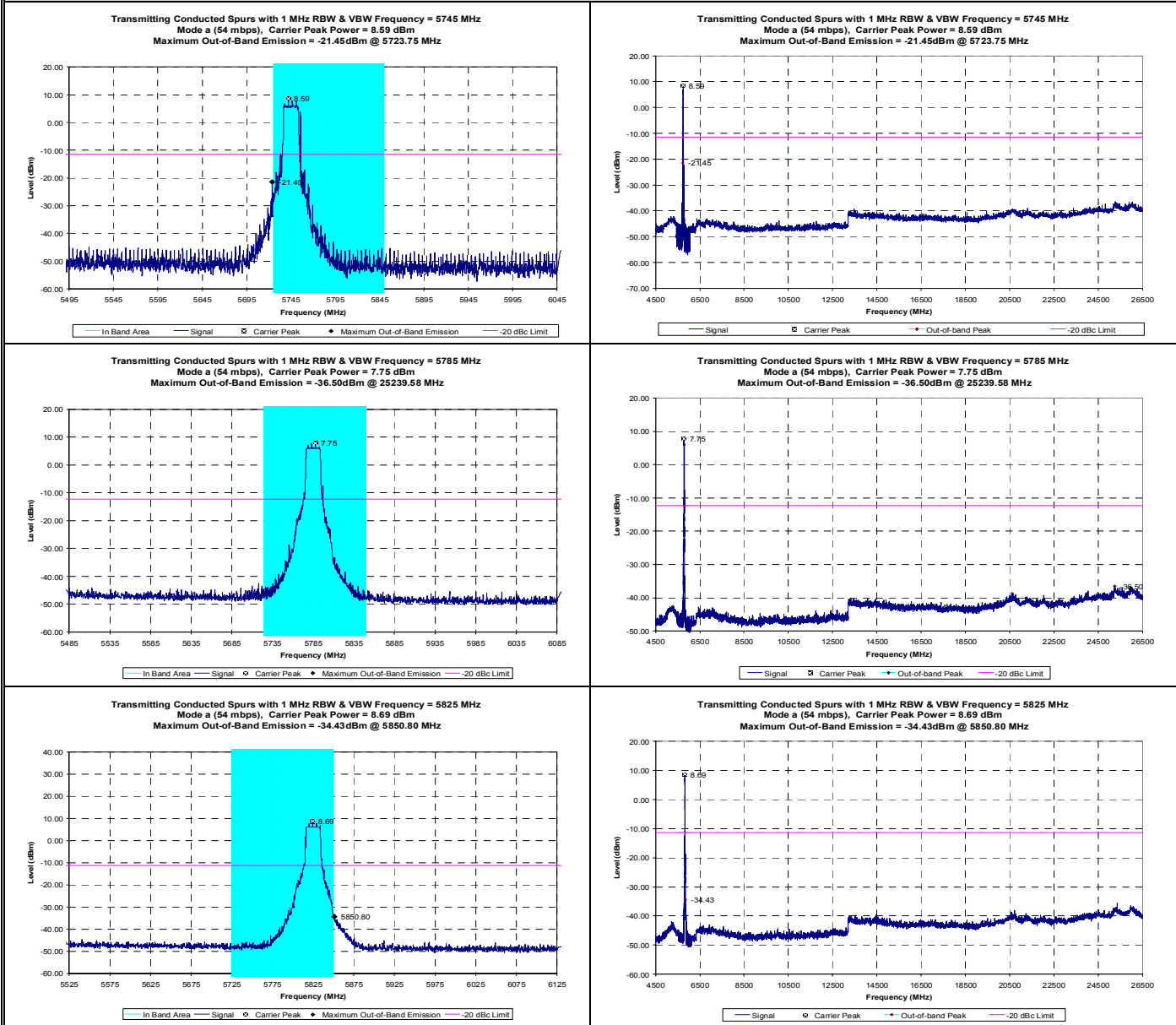

Channel	Channel Frequency (MHz)	Highest Conducted Out-of-band Spurious Emission		Limit (dBm)	Margin (dB)	Pass/Fail
		Frequency (MHz)	Level (dBm)			
149	5745	5723.75	-21.45	-11.42	10.03	Pass
157	5785	25239.58	-36.50	-12.25	24.25	Pass
165	5825	5850.80	-34.43	-11.31	23.12	Pass



Test Report Serial No.:	040505KBC-F632-E15CW	Report Issue No.:	E632CW-032906-R0
Test Date(s):	13Sep05 - 27Nov05	Report Issue Date:	March 29, 2006
Test Rule Part(s):	FCC 47 CFR §15.247	Industry Canada RSS-210 Issue 6	
Lab Registration(s):	FCC Lab Reg. # 714830	Industry Canada Lab File # IC 3874	

E.8.3. Mode b (1 mbps) Conducted Transmitter Spurious Emissions

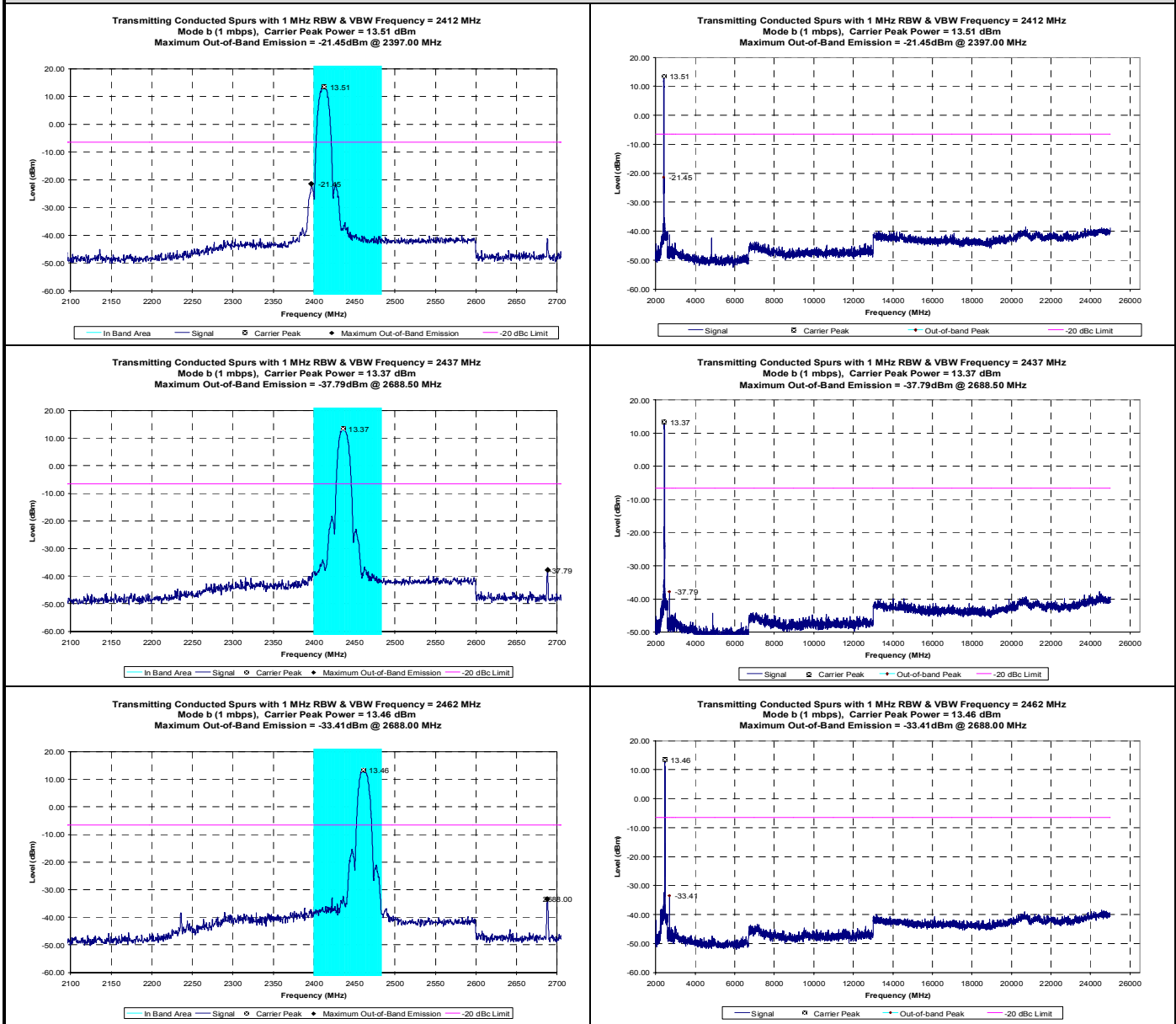

Channel	Channel Frequency (MHz)	Highest Conducted Out-of-band Spurious Emission		Limit (dBm)	Margin (dB)	Pass/Fail
		Frequency (MHz)	Level (dBm)			
1	2412	2397.00	-21.45	-6.49	14.96	Pass
6	2437	2688.50	-37.79	-6.63	31.16	Pass
11	2462	2688.00	-33.41	-6.54	26.87	Pass

Applicant:	Itronix Corporation	FCC ID:	KBCIX325-CWL	IC ID:	1943A-IX325ab	ITRONIX A GENERAL DYNAMICS COMPANY
Model(s):	IX325-CWL	IX325 Series Rugged Tablet PC with Cisco AIR-CB21AG-A-K9 802.11 abg WLAN				
2006 Celltech Labs Inc.		This document is not to be reproduced in whole or in part without the prior written permission of Celltech Labs Inc.				Page 37 of 83



Test Report Serial No.:	040505KBC-F632-E15CW	Report Issue No.:	E632CW-032906-R0
Test Date(s):	13Sep05 - 27Nov05	Report Issue Date:	March 29, 2006
Test Rule Part(s):	FCC 47 CFR §15.247	Industry Canada RSS-210 Issue 6	
Lab Registration(s):	FCC Lab Reg. # 714830	Industry Canada Lab File # IC 3874	

E.8.4. Mode b (11 mbps) Conducted Transmitter Spurious Emissions

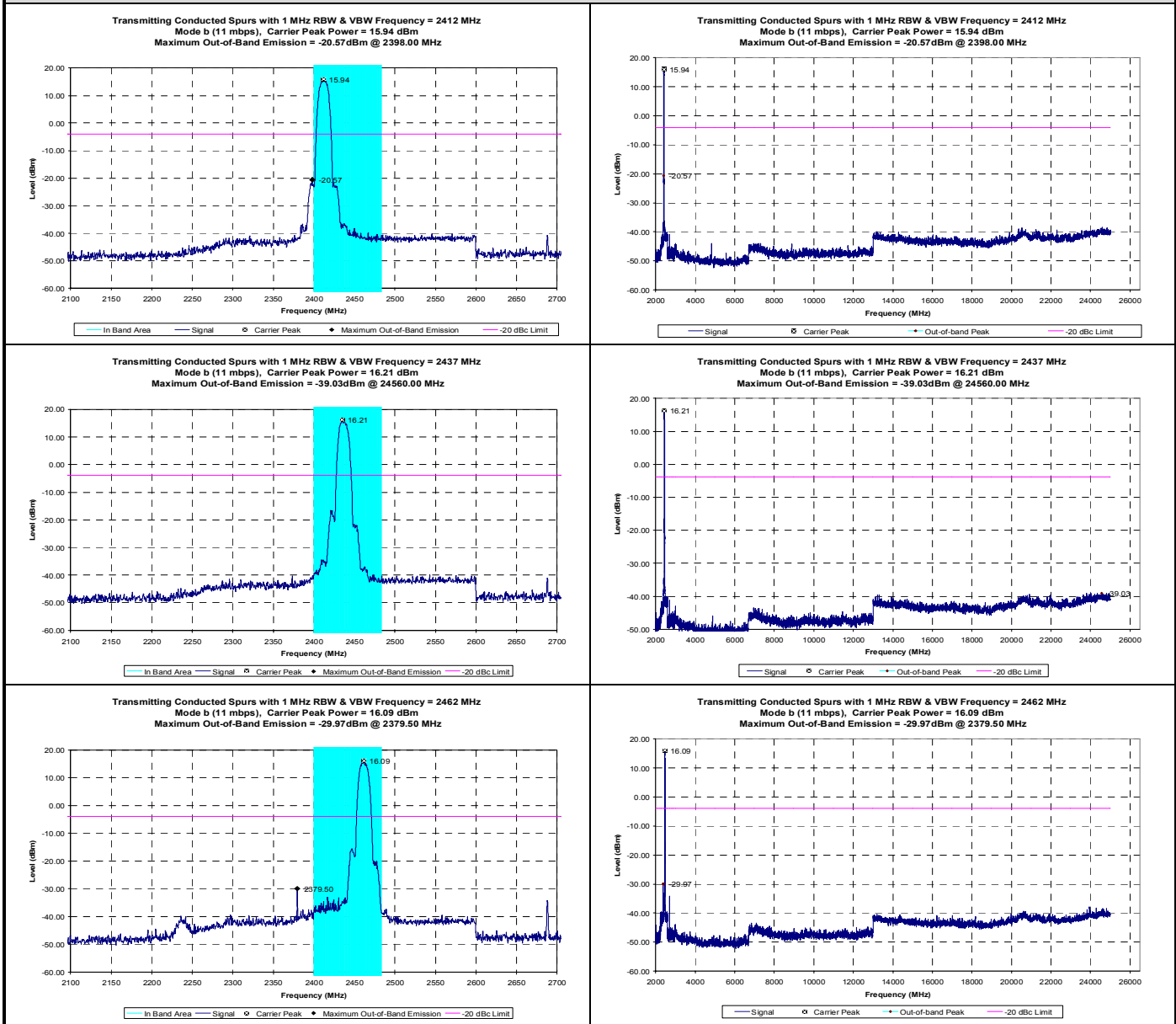

Channel	Channel Frequency (MHz)	Highest Conducted Out-of-band Spurious Emission		Limit (dBm)	Margin (dB)	Pass/Fail
		Frequency (MHz)	Level (dBm)			
1	2412	2398.00	-20.57	-4.07	16.51	Pass
6	2437	24560.00	-39.03	-3.79	35.24	Pass
11	2462	2379.50	-29.97	-3.91	26.06	Pass

E.8.5. Mode g (6 mbps) Conducted Transmitter Spurious Emissions

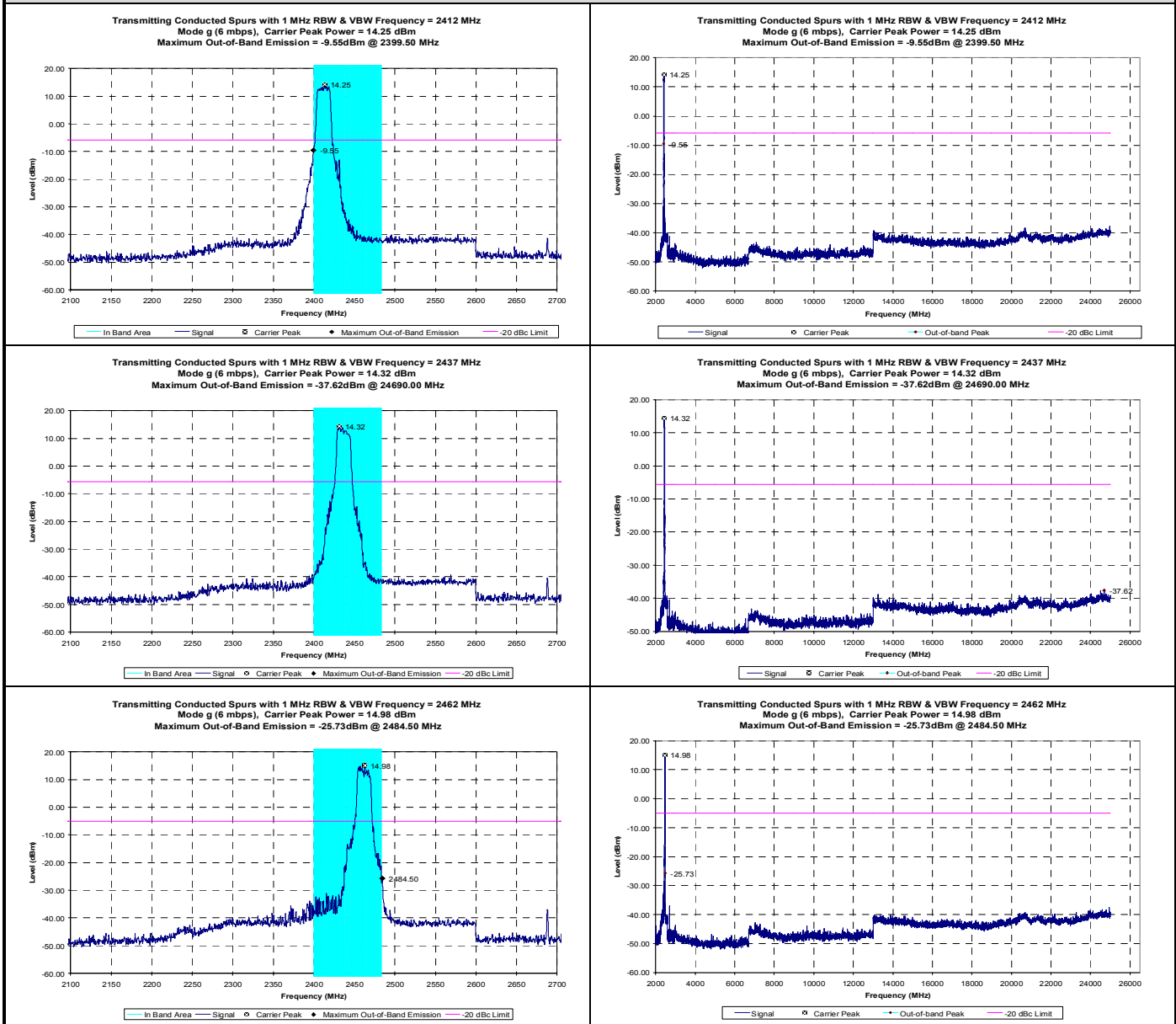

Channel	Channel Frequency (MHz)	Highest Conducted Out-of-band Spurious Emission		Limit (dBm)	Margin (dB)	Pass/Fail
		Frequency (MHz)	Level (dBm)			
1	2412	2399.50	-9.55	-5.75	3.80	Pass
6	2437	24690.00	-37.62	-5.69	31.93	Pass
11	2462	2485.00	-25.73	-5.02	20.71	Pass



Test Report Serial No.:	040505KBC-F632-E15CW	Report Issue No.:	E632CW-032906-R0
Test Date(s):	13Sep05 - 27Nov05	Report Issue Date:	March 29, 2006
Test Rule Part(s):	FCC 47 CFR §15.247	Industry Canada RSS-210 Issue 6	
Lab Registration(s):	FCC Lab Reg. # 714830	Industry Canada Lab File # IC 3874	

E.8.6. Mode g (54 mbps) Conducted Transmitter Spurious Emissions

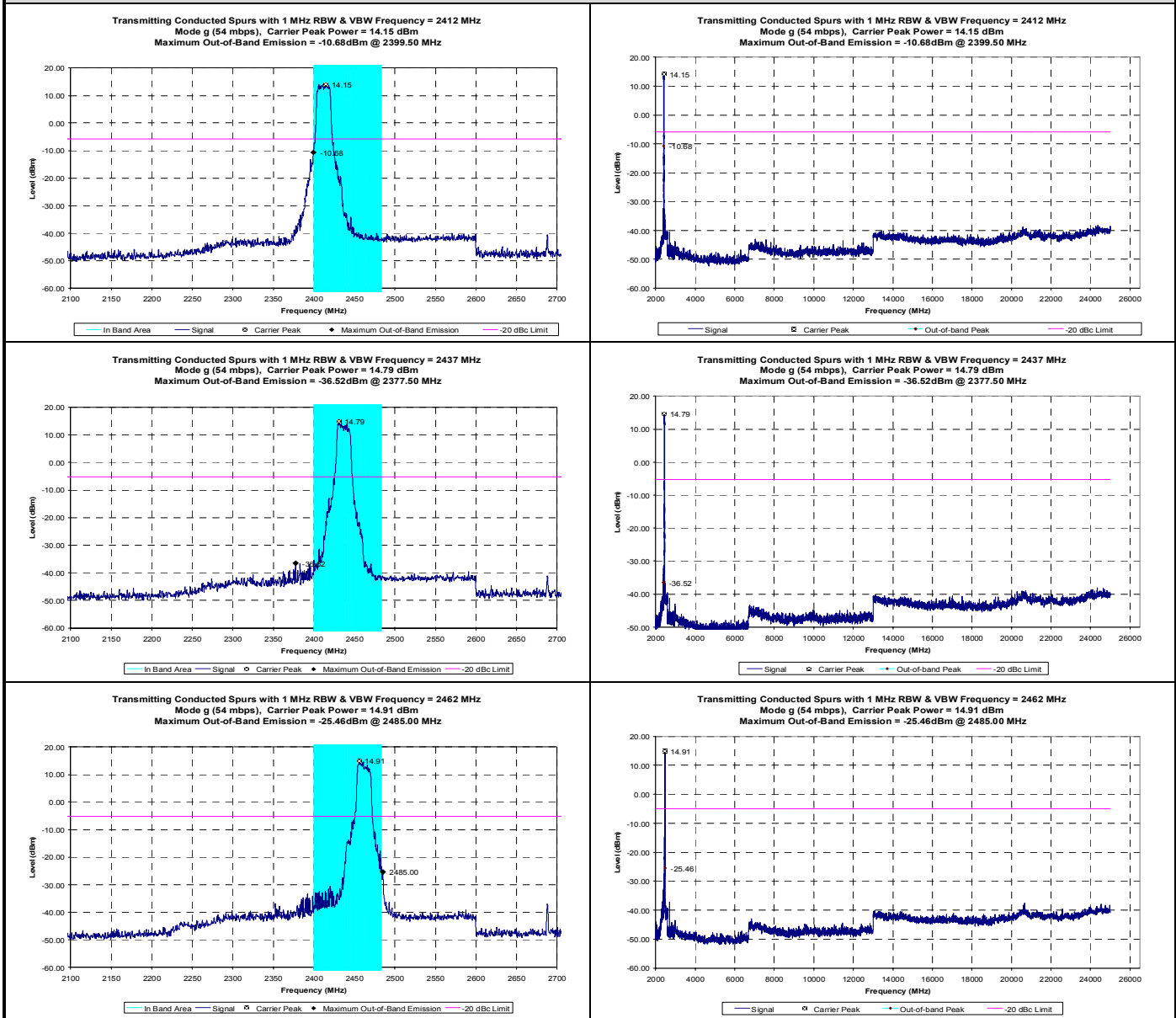

Channel	Channel Frequency (MHz)	Highest Conducted Out-of-band Spurious Emission		Limit (dBm)	Margin (dB)	Pass/Fail
		Frequency (MHz)	Level (dBm)			
1	2412	2399.50	-10.68	-5.85	4.83	Pass
6	2437	2377.50	-36.52	-5.21	31.32	Pass
11	2462	2485.00	-25.46	-5.09	20.37	Pass

Applicant:	Itronix Corporation	FCC ID:	KBCIX325-CWL	IC ID:	1943A-IX325ab	ITRONIX A GENERAL DYNAMICS COMPANY
Model(s):	IX325-CWL	IX325 Series Rugged Tablet PC with Cisco AIR-CB21AG-A-K9 802.11 abg WLAN				
2006 Celltech Labs Inc.		This document is not to be reproduced in whole or in part without the prior written permission of Celltech Labs Inc.				Page 40 of 83

	Test Report Serial No.:	040505KBC-F632-E15CW	Report Issue No.:	E632CW-032906-R0
	Test Date(s):	13Sep05 - 27Nov05	Report Issue Date:	March 29, 2006
	Test Rule Part(s):	FCC 47 CFR §15.247	Industry Canada RSS-210 Issue 6	
	Lab Registration(s):	FCC Lab Reg. # 714830	Industry Canada Lab File # IC 3874	

E.9. PASS/FAIL

In reference to the results outlined in E.8, the DUT passes the requirements as stated in the reference standards as follows:

§15.247 (d): In any 100 kHz bandwidth outside the frequency band in which the spread spectrum or digitally modulated intentional radiator is operating, the radio frequency power that is produced by the intentional radiator shall be at least 20 dB below that in the 100 kHz bandwidth within the band that contains the highest level of desired power, based on either an RF conducted or a radiated measurement. Attenuation below the general limits specified in 15.209 (a) is not required..

The emission with the lowest margin was measured at 2399.5 MHz, with a level of -9.55 dBm vs. the limit of -5.75 dBm, resulting in a 3.80 dB margin with the DUT transmitting Channel 1 in Mode g (6 mbps).

E.10. SIGN-OFF

I attest to the accuracy of the data. All measurements reported herein were performed by me and are correct to the best of my knowledge and belief. I assume full responsibility for the completeness of these measurements.



Duane M. Friesen, C.E.T.
EMC Manager
Celltech Labs Inc.

24Nov05
Date

Applicant:	Itronix Corporation	FCC ID:	KBCIX325-CWL	IC ID:	1943A-IX325ab	
Model(s):	IX325-CWL	IX325 Series Rugged Tablet PC with Cisco AIR-CB21AG-A-K9 802.11 abg WLAN				
2006 Celltech Labs Inc.		This document is not to be reproduced in whole or in part without the prior written permission of Celltech Labs Inc.				Page 41 of 83

	Test Report Serial No.:	040505KBC-F632-E15CW	Report Issue No.:	E632CW-032906-R0
	Test Date(s):	13Sep05 - 27Nov05	Report Issue Date:	March 29, 2006
	Test Rule Part(s):	FCC 47 CFR §15.247	Industry Canada RSS-210 Issue 6	
	Lab Registration(s):	FCC Lab Reg. # 714830	Industry Canada Lab File # IC 3874	

Appendix F - Radiated Spurious Emissions Measurement

F.1. REFERENCES	
Normative Reference Standard	FCC CFR 47 §15.247(d)
Procedure Reference	ANSI C63.4; FCC 97-114

F.2. LIMITS	
F.2.1. FCC CFR 47	
<p>§15.247 (d): In any 100 kHz bandwidth outside the frequency band in which the spread spectrum or digitally modulated intentional radiator is operating, the radio frequency power that is produced by the intentional radiator shall be at least 20 dB below that in the 100 kHz bandwidth within the band that contains the highest level of desired power, based on either an RF conducted or a radiated measurement. Attenuation below the general limits specified in 15.209 (a) is not required.</p>	
<p>Note: Spurious emissions within the restricted bands are reported in Appendix G.</p>	

F.3. ENVIRONMENTAL CONDITIONS	
Temperature	uncontrolled
Humidity	uncontrolled
Barometric Pressure	uncontrolled

F.4. EQUIPMENT LIST						
RECEIVING EQUIPMENT						
ID	ASSET NUMBER	MANUFACTURER	MODEL	DESCRIPTION	LAST CAL	CAL DUE
1	00072	EMCO	2075	Mini-mast	na	na
2	00073	EMCO	2080	Turn Table	na	na
3	00071	EMCO	2090	Multi-Device Controller	na	na
4	00094	HP	11975A	Preamplifier	na	Na
5	00034	ETS	3115	Double Ridged Guide Horn	11Aug05	11Aug06
6	00161/00166	Waveline	899/801-KF	Standard Gain Horn	na	na
7	00163	Waveline	899	Standard Gain Horn	na	Na
8	00051	HP	8566B	Spectrum Analyzer RF Section	12Apr05	12Apr06
9	00049	HP	85650A	Quasi-Peak Adapter	13Apr05	13Apr06
10	00047	HP	85685A	RF Preselector	13Apr05	13Apr06
11	00015	Agilent	4408B	Spectrum Analyzer	24Jan05	24Jan06
12	00115	Miteq	J54-00102600-35-5A	LNA	08Jun04	08Jun06
13	00093	Microtronics	HPM50111	High Pass Filter	8Jun04	8Dec05
14	00119	INMAT	18AH-10	10dB attenuator	8Jun04	8Dec05
15	00192	Agilent	8493C	6dB attenuator	01Jul05	01Jul06
16	00048	GORE	n/a	Microwave Cable (RX)	28Mar05	28Mar06
17	00121	Andrew	FSJ4-50B	Microwave Cable (RX)	12Aug05	12Aug06
18	00130	Andrew	FSJ1-50A	Microwave Cable (RX)	12Aug05	12Aug06
19	00088	HP	11970A	Harmonic mixer	na	na

Applicant:	Itronix Corporation	FCC ID:	KBCIX325-CWL	IC ID:	1943A-IX325ab	
Model(s):	IX325-CWL	IX325 Series Rugged Tablet PC with Cisco AIR-CB21AG-A-K9 802.11 abg WLAN				
2006 Celltech Labs Inc.		This document is not to be reproduced in whole or in part without the prior written permission of Celltech Labs Inc.				Page 42 of 83

F.5. MEASUREMENT EQUIPMENT SETUP

MEASUREMENT EQUIPMENT CONNECTIONS	The measurement equipment was connected as shown in the F.6. A number of antennas were used to cover the applicable frequency range test. The ranges in which each antenna was used are as follows:			
	Frequency Range	Spectrum Analyzer Asset #	LNA/Filter/Attenuator Asset #	Antenna Asset #
	2 GHz – 3 GHz	00051	00119/00115	00034
	3 GHz – 7 GHz	00051	00093/00115	00034
	3 GHz – 7 GHz*	00051	00119/00192/00115	00034
	7 GHz – 18 GHz	00015	00093/00115	00034
	18 GHz – 26.5 GHz	00015	00115	00161/00166
	26.5 GHz – 40 GHz	00051	none	00088/00163
* Replacement equipment used for 5G Channels only				
MEASUREMENT EQUIPMENT SETTINGS	The spectrum analyzer was set to the following settings:			
	Frequency Range	RBW	VBW	Detector
	MHz	kHz	kHz	
	> 1000	1000*	1000	Peak*
	*As a worst-case measurement, the average/QP limit was applied to measurements made with a peak detector using a RBW of 1 MHz (vs the specified 100 kHz), unless otherwise noted. Average measurements were performed with video averaging using a VBW of 30 Hz.			

F.6. SETUP DRAWING

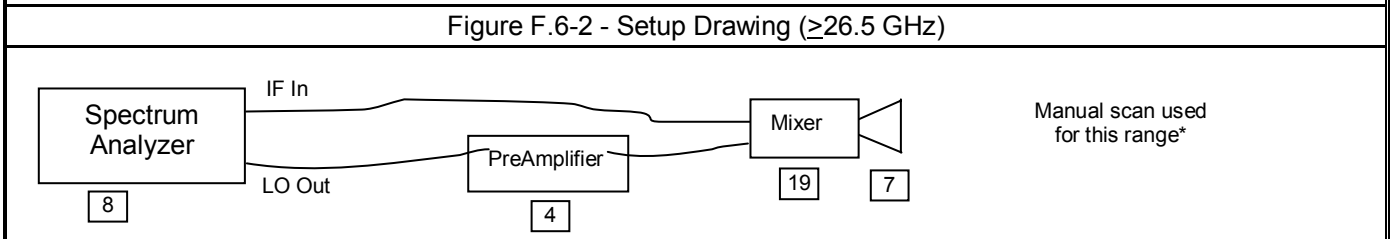
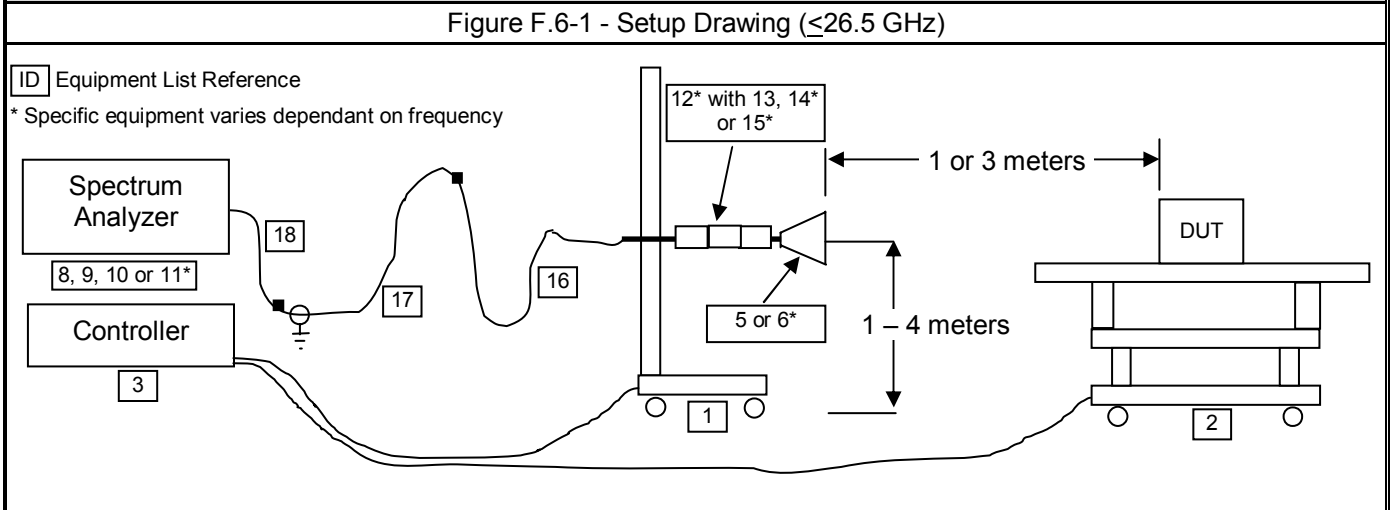

	Test Report Serial No.:	040505KBC-F632-E15CW	Report Issue No.:	E632CW-032906-R0
	Test Date(s):	13Sep05 - 27Nov05	Report Issue Date:	March 29, 2006
	Test Rule Part(s):	FCC 47 CFR §15.247	Industry Canada RSS-210 Issue 6	
	Lab Registration(s):	FCC Lab Reg. # 714830	Industry Canada Lab File # IC 3874	

F.7. SETUP PHOTOGRAPHS

Photograph F.7-1 - 3115 Horn @ 3 m



Photograph F.7-2 - Waveline Horn with LNA @ 1m



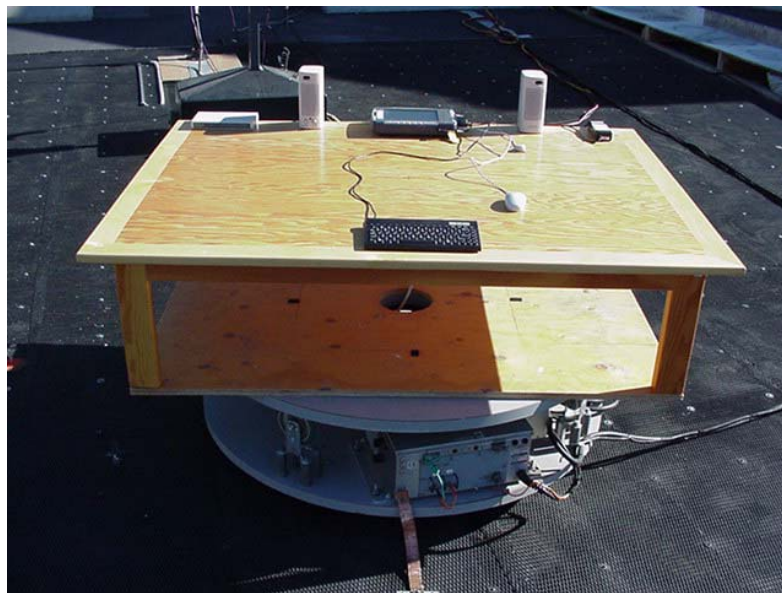

Photograph F.7-3 - DUT Configuration



F.8. DUT OPERATING DESCRIPTION

The worst-case data rate was determined from prescan investigations. Measurements were made at three channels throughout the band, Low Channel, Mid Channel, High Channel for Modes b and g and the upper band of Mode a. The measurements were made for both the worst case data rate determined in the prescan measurements for the mode.

Applicant:	Itronix Corporation	FCC ID:	KBCIX325-CWL	IC ID:	1943A-IX325ab	
Model(s):	IX325-CWL	IX325 Series Rugged Tablet PC with Cisco AIR-CB21AG-A-K9 802.11 abg WLAN				
2006 Celltech Labs Inc.		This document is not to be reproduced in whole or in part without the prior written permission of Celltech Labs Inc.				Page 44 of 83

	Test Report Serial No.:	040505KBC-F632-E15CW	Report Issue No.:	E632CW-032906-R0
	Test Date(s):	13Sep05 - 27Nov05	Report Issue Date:	March 29, 2006
	Test Rule Part(s):	FCC 47 CFR §15.247	Industry Canada RSS-210 Issue 6	
	Lab Registration(s):	FCC Lab Reg. # 714830	Industry Canada Lab File # IC 3874	

F.9. TEST RESULTS

F.9.1. Mode a (upper band) - Fundamental Field Strengths @ Specified Distance (100 kHz RBW)

	Project Number:	632	Standard:	FCC15.247a
	Company:	Itronix	Test Start Date:	13-Oct-05
	Product:	IX325 with CISCO WLAN a/b/g	Test End Date:	13-Oct-05

CISCO WLAN Mode a2 Carrier Field Strengths

Channel	Polarity	Measurement Distance	Antenna	Frequency	SA Level	Noise Floor	AF	CL	Other	Total CF	Field Strength	Detector	RBW
							dB/m	dB	dB	dB/m	dBuV/m		kHz
UNII-CH149	H	3	Horn SN6267	5745.00	54.60		34.24	12.03	0.00	46.27	100.87	PK	100
UNII-CH149	H	3	Horn SN6267	5745.00	46.50		34.24	12.03	0.00	46.27	92.77	AV	100
UNII-CH149	V	3	Horn SN6267	5745.00	49.30		34.24	12.03	0.00	46.27	95.57	PK	100
UNII-CH149	V	3	Horn SN6267	5745.00	41.60		34.24	12.03	0.00	46.27	87.87	AV	100
UNII-CH157	H	3	Horn SN6267	5785.00	55.00		34.25	11.96	0.00	46.21	101.21	PK	100
UNII-CH157	H	3	Horn SN6267	5785.00	47.20		34.25	11.96	0.00	46.21	93.41	AV	100
UNII-CH157	V	3	Horn SN6267	5785.00	49.90		34.25	11.96	0.00	46.21	96.11	PK	100
UNII-CH157	V	3	Horn SN6267	5785.00	41.50		34.25	11.96	0.00	46.21	87.71	AV	100
UNII-CH165	H	3	Horn SN6267	5825.00	55.10		34.26	12.00	0.00	46.26	101.36	PK	100
UNII-CH165	H	3	Horn SN6267	5825.00	48.30		34.26	12.00	0.00	46.26	94.56	AV	100
UNII-CH165	V	3	Horn SN6267	5825.00	53.70		34.26	12.00	0.00	46.26	99.96	PK	100
UNII-CH165	V	3	Horn SN6267	5825.00	44.05		34.26	12.00	0.00	46.26	90.31	AV	100

Formulae:

Total CF = AF + CL + Other

Field Strength = SA Level + Total CF

Applicant:	Itronix Corporation	FCC ID:	KBCIX325-CWL	IC ID:	1943A-IX325ab	
Model(s):	IX325-CWL	IX325 Series Rugged Tablet PC with Cisco AIR-CB21AG-A-K9 802.11 abg WLAN				
2006 Celltech Labs Inc.		This document is not to be reproduced in whole or in part without the prior written permission of Celltech Labs Inc.				Page 45 of 83



Test Report Serial No.:	040505KBC-F632-E15CW	Report Issue No.:	E632CW-032906-R0
Test Date(s):	13Sep05 - 27Nov05	Report Issue Date:	March 29, 2006
Test Rule Part(s):	FCC 47 CFR §15.247	Industry Canada RSS-210 Issue 6	
Lab Registration(s):	FCC Lab Reg. # 714830	Industry Canada Lab File # IC 3874	

F.9.2. Mode a (upper band) - Lower Band-edge Emission Field Strengths @ Specified Distance

Channel 149 Mode a - Conducted Peak Band-edge Plots

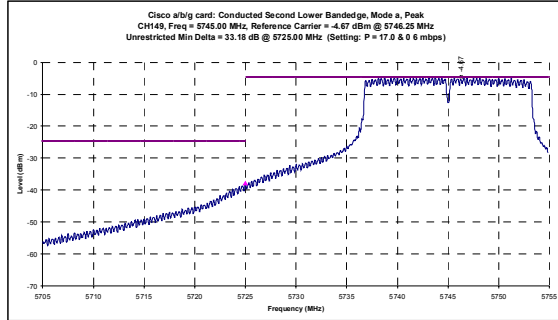

Channel 149 Mode a - Conducted Average Band-edge Plots

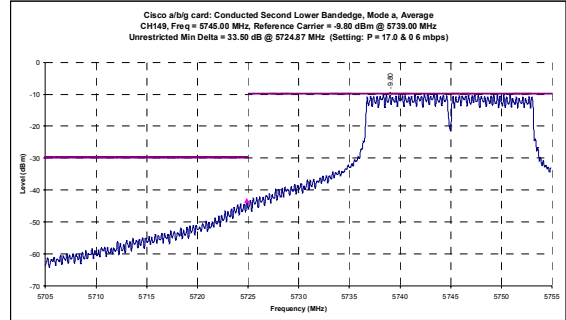

Channel 165 Mode a - Conducted Peak Band-edge Plots

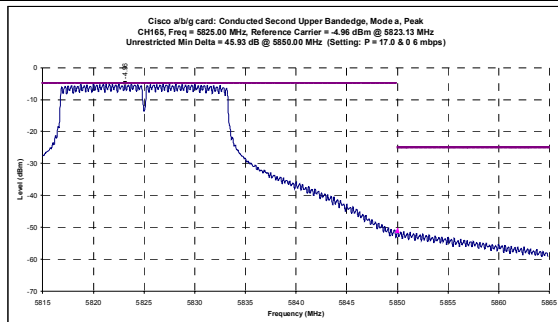

Channel 165 Mode a - Conducted Average Band-edge Plots

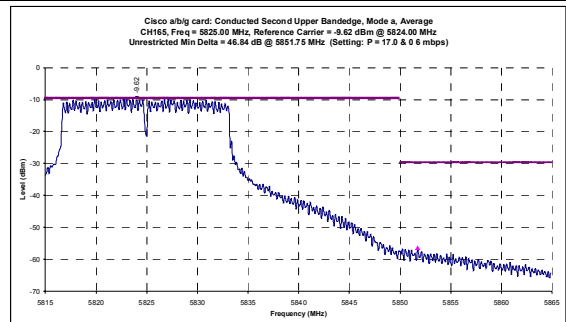

Mode a - Calculated Band-edge Field Strengths

CISCO WLAN Mode a2

Channel	Polarity	Distance	Frequency	Carrier Radiated Field Strength	Delta Marker	Detector	Calculated Band-edge Field Strength	Duty Cycle Correction	Corrected Band-edge Field Strength	Specified Limit	Specified Limit Distance	Limit Distance Correction	Calculated Limit	Margin	Pass/Fail
UNII-CH149	H	3	5725.00	100.87	33.18	PK	67.69	0.00	67.69	81.36	3.00	0.00	81.36	13.67	PASS
UNII-CH149	H	3	5724.87	92.77	33.50	AV	59.27	0.00	59.27	74.56	3.00	0.00	74.56	15.29	PASS
UNII-CH149	V	3	5725.00	95.57	33.18	PK	62.39	0.00	62.39	79.96	3.00	0.00	79.96	17.57	PASS
UNII-CH149	V	3	5724.87	87.87	33.50	AV	54.37	0.00	54.37	70.31	3.00	0.00	70.31	15.94	PASS
UNII-CH165	H	3	5825.00	101.36	45.93	PK	55.43	0.00	55.43	81.36	3.00	0.00	81.36	25.93	PASS
UNII-CH165	H	3	5825.00	94.56	46.84	AV	47.72	0.00	47.72	74.56	3.00	0.00	74.56	26.84	PASS
UNII-CH165	V	3	5825.00	99.96	45.93	PK	54.03	0.00	54.03	79.96	3.00	0.00	79.96	25.93	PASS
UNII-CH165	V	3	5825.00	90.31	46.84	AV	43.47	0.00	43.47	70.31	3.00	0.00	70.31	26.84	PASS

Formulae:

- Calculated Band-edge Field Strength (dBuV/m) = Carrier Radiated Field Strength (dBuV/m) + Delta Marker (dB)
- Duty Cycle Correction (dB) = 20 * log (time on / total time)
- Corrected Band-edge Field Strength (dBuV/m) = Calculated Band-edge Field Strength (dBuV/m) + Duty Cycle Correction (dB)
- Limit Distance Correction = 20 * log (measurement distance / limit distance)
- Calculated Limit (dBuV/m) = Specified Limit (dBuV/m) + Limit Distance Correction (dB)
- Margin (dB) = Corrected Limit (dBuV/m) - Corrected Band-edge Field Strength (dBuV/m)

**Note: Measurements and calculation reference the Marker-Delta Method described in FCC Public Notice DA 00-705
Limit based on highest radiated carrier**

Applicant:	Itronix Corporation	FCC ID:	KBCIX325-CWL	IC ID:	1943A-IX325ab	
Model(s):	IX325-CWL	IX325 Series Rugged Tablet PC with Cisco AIR-CB21AG-A-K9 802.11 abg WLAN				
2006 Celltech Labs Inc.		This document is not to be reproduced in whole or in part without the prior written permission of Celltech Labs Inc.				Page 46 of 83

	Test Report Serial No.:	040505KBC-F632-E15CW	Report Issue No.:	E632CW-032906-R0
	Test Date(s):	13Sep05 - 27Nov05	Report Issue Date:	March 29, 2006
	Test Rule Part(s):	FCC 47 CFR §15.247	Industry Canada RSS-210 Issue 6	
	Lab Registration(s):	FCC Lab Reg. # 714830	Industry Canada Lab File # IC 3874	

F.9.3. Mode a (upper band) - Out-of-Band Spurious Emission Field Strengths @ Specified Distance (not within restricted bands)

		Project Number:	632	Standard:	FCC15.247c
		Company:	Itronix	Test Start Date:	16-Sep-05
		Product:	IX325 with CISCO WLAN a/b/g	Test End Date:	13-Oct-05

Channel	Polarity	Distance	Rx Antenna	Frequency	SA Level	Noise Floor	Rx AF	Rx CL	Other Rx	Total Rx CF	Field Strength	Detector	Limit Distance	Limit Distance Correction	Calculated Limit	Margin	Pass/Fail
							dB/m	dB	dB	dB/m	dBuV/m	(PK/QP/AV)	m	dB	dBuV/m	dB	
UNII-CH149	H	3	Bilog SN1607	839.75	25.50	*	22.89	3.97	0.00	26.86	52.36	PK*	3.00	0.00	74.56	22.20	PASS
UNII-CH149	H	3	Bilog SN1607	913.58	25.70	*	23.87	4.14	0.00	28.01	53.71	PK*	3.00	0.00	74.56	20.86	PASS
UNII-CH149	H	1	Horn SN6267	17230.00	49.55		42.06	10.88	-32.94	20.00	69.55	PK*	3.00	9.54	84.11	14.56	PASS
UNII-CH149	V	3	Bilog SN1607	834.37	25.80	*	22.56	3.97	0.00	26.53	52.33	PK*	3.00	0.00	70.31	17.98	PASS
UNII-CH149	V	3	Horn SN6267	2901.31	33.60	*	29.72	7.66	-23.10	14.28	47.88	PK*	3.00	0.00	70.31	22.43	PASS
UNII-CH149	V	1	Horn SN6267	17230.00	37.22		42.06	10.88	-32.94	20.00	57.22	PK*	3.00	9.54	79.86	22.64	PASS
UNII-CH157	H	3	Bilog SN1607	815.24	25.90	*	22.69	3.94	0.00	26.62	52.52	PK*	3.00	0.00	74.56	22.04	PASS
UNII-CH157	H	3	Bilog SN1607	820.67	26.00	*	22.39	3.97	0.00	26.36	52.36	PK*	3.00	0.00	74.56	22.20	PASS
UNII-CH157	H	3	Bilog SN1607	838.98	25.60	*	22.84	3.98	0.00	26.82	52.42	PK*	3.00	0.00	74.56	22.14	PASS
UNII-CH157	H	3	Bilog SN1607	914.99	26.00	*	23.90	4.14	0.00	28.04	54.04	PK*	3.00	0.00	74.56	20.52	PASS
UNII-CH157	H	3	Horn SN6267	1716.64	28.00	*	26.38	5.64	0.00	32.02	60.02	PK*	3.00	0.00	74.56	14.54	PASS
UNII-CH157	H	1	Horn SN6267	17353.80	47.21		42.59	10.93	-33.07	20.45	67.66	PK*	3.00	9.54	84.11	16.45	PASS
UNII-CH157	H	1	Waveline 899	23137.20	39.60		40.40	13.05	-35.56	17.89	57.49	PK*	3.00	9.54	84.11	26.62	PASS
UNII-CH157	V	3	Bilog SN1607	815.58	25.50	*	22.67	3.94	0.00	26.61	52.11	PK*	3.00	0.00	70.31	18.20	PASS
UNII-CH157	V	3	Bilog SN1607	908.80	25.50	*	23.75	4.12	0.00	27.87	53.37	PK*	3.00	0.00	70.31	16.94	PASS
UNII-CH157	V	3	Bilog SN1607	926.77	27.70		24.37	4.11	0.00	28.48	56.18	PK*	3.00	0.00	70.31	14.13	PASS
UNII-CH157	V	1	Horn SN6267	17353.80	39.04		42.59	10.93	-33.07	20.45	59.49	PK*	3.00	9.54	79.86	20.37	PASS
UNII-CH157	V	1	Waveline 899	23137.20	37.82		40.40	13.05	-35.56	17.89	55.71	PK*	3.00	9.54	79.86	24.15	PASS
UNII-CH165	H	3	Bilog SN1607	813.75	25.30	*	22.68	3.92	0.00	26.60	51.90	PK*	3.00	0.00	74.56	22.67	PASS
UNII-CH165	H	3	Bilog SN1607	833.66	26.10	*	22.52	3.97	0.00	26.49	52.59	PK*	3.00	0.00	74.56	21.97	PASS
UNII-CH165	H	3	Bilog SN1607	905.60	26.30	*	23.62	4.09	0.00	27.72	54.02	PK*	3.00	0.00	74.56	20.55	PASS
UNII-CH165	H	3	Bilog SN1607	911.98	25.90	*	23.84	4.14	0.00	27.98	53.88	PK*	3.00	0.00	74.56	20.68	PASS
UNII-CH165	H	1	Horn SN6267	13402.20	39.20	*	40.39	9.24	-31.42	18.20	57.40	PK*	3.00	9.54	84.11	26.70	PASS
UNII-CH165	H	1	Horn SN6267	17470.60	37.19		43.09	10.97	-33.12	20.95	58.14	PK*	3.00	9.54	84.11	25.97	PASS
UNII-CH165	H	1	Waveline 899	23296.60	38.10		40.40	13.11	-35.56	17.95	56.05	PK*	3.00	9.54	84.11	28.06	PASS
UNII-CH165	V	3	Bilog SN1607	349.21	26.10	*	15.17	2.69	0.00	17.86	43.96	PK*	3.00	0.00	70.31	26.35	PASS
UNII-CH165	V	3	Bilog SN1607	817.02	25.30	*	22.58	3.95	0.00	26.53	51.83	PK*	3.00	0.00	70.31	18.48	PASS
UNII-CH165	V	3	Bilog SN1607	847.69	25.60	*	23.21	4.03	0.00	27.24	52.84	PK*	3.00	0.00	70.31	17.48	PASS
UNII-CH165	V	1	Horn SN6267	17470.60	42.32		43.09	10.97	-33.12	20.95	63.27	PK*	3.00	9.54	79.86	16.59	PASS
UNII-CH165	V	1	Waveline 899	23296.60	37.89		40.40	13.11	-35.56	17.95	55.84	PK*	3.00	9.54	79.86	24.02	PASS

For frequency bands above 26.5 GHz, manual scans at a 1-2 cm distance were made with no emissions observed.

Notes:
*PK denotes QP or Average limits applied to emissions measured with a peak detector
BOLD signifies the highest signal measured near a carrier harmonic frequency
No DUT emissions levels were measured above those reported
Formulae:
Total CF = Antenna Factor + Cable Factor + Other Factor (Amplifier Gain, filter loss, etc)
Field Strength = SA Reading + Total CF
Limit Distance Correction = 40*log(d1/d2) for F<30 MHz, 20*log(d1/d2) for F> 30 MHz:
where d1 is the measurement distance, d2 is the published limit distance
Limit = Specified Limit + Limit Distance Correction
Margin = Limit - Field Strength
Limit based on highest radiated carrier

Applicant:	Itronix Corporation	FCC ID:	KBCIX325-CWL	IC ID:	1943A-IX325ab	
Model(s):	IX325-CWL	IX325 Series Rugged Tablet PC with Cisco AIR-CB21AG-A-K9 802.11 abg WLAN				
2006 Celltech Labs Inc.		This document is not to be reproduced in whole or in part without the prior written permission of Celltech Labs Inc.				Page 47 of 83

	Test Report Serial No.:	040505KBC-F632-E15CW	Report Issue No.:	E632CW-032906-R0
	Test Date(s):	13Sep05 - 27Nov05	Report Issue Date:	March 29, 2006
	Test Rule Part(s):	FCC 47 CFR §15.247	Industry Canada RSS-210 Issue 6	
	Lab Registration(s):	FCC Lab Reg. # 714830	Industry Canada Lab File # IC 3874	

F.9.4. Mode b - Fundamental Field Strengths @ Specified Distance (100 kHz RBW)

	Project Number:	632	Standard:	FCC15.247a
	Company:	Itronix	Test Start Date:	19-Sep-05
	Product:	IX325 w CISCO abg	Test End Date:	14-Oct-05

IX325 with Cisco abg - mode b Carrier Field Strengths

Channel	Polarity	Measurement Distance	Antenna	Frequency	SA Level	Noise Floor	AF	CL	Other	Total CF	Field Strength	Detector	RBW
							dB/m	dB	dB	dB/m	dBuV/m		kHz
WLAN-CH1	H	3	Horn SN6267	2412.00	68.35		28.21	6.83	0.00	35.04	103.39	PK	100
WLAN-CH1	H	3	Horn SN6267	2412.00	61.80		28.21	6.83	0.00	35.04	96.84	AV	100
WLAN-CH1	V	3	Horn SN6267	2412.00	66.15		28.21	6.83	0.00	35.04	101.19	PK	100
WLAN-CH1	V	3	Horn SN6267	2412.00	58.40		28.21	6.83	0.00	35.04	93.44	AV	100
WLAN-CH6	H	3	Horn SN6267	2437.00	67.55		28.25	6.84	0.00	35.09	102.64	PK	100
WLAN-CH6	H	3	Horn SN6267	2437.00	61.50		28.25	6.84	0.00	35.09	96.59	AV	100
WLAN-CH6	V	3	Horn SN6267	2437.00	65.50		28.25	6.84	0.00	35.09	100.59	PK	100
WLAN-CH6	V	3	Horn SN6267	2437.00	57.70		28.25	6.84	0.00	35.09	92.79	AV	100
WLAN-CH11	H	3	Horn SN6267	2462.00	68.30		28.29	6.91	0.00	35.19	103.49	PK	100
WLAN-CH11	H	3	Horn SN6267	2462.00	62.80		28.29	6.91	0.00	35.19	97.99	AV	100
WLAN-CH11	V	3	Horn SN6267	2462.00	65.20		28.29	6.91	0.00	35.19	100.39	PK	100
WLAN-CH11	V	3	Horn SN6267	2462.00	57.15		28.29	6.91	0.00	35.19	92.34	AV	100

Formulae:
Total CF = AF + CL + Other
Field Strength = SA Level + Total CF

Applicant:	Itronix Corporation	FCC ID:	KBCIX325-CWL	IC ID:	1943A-IX325ab	
Model(s):	IX325-CWL	IX325 Series Rugged Tablet PC with Cisco AIR-CB21AG-A-K9 802.11 abg WLAN				
2006 Celltech Labs Inc.		This document is not to be reproduced in whole or in part without the prior written permission of Celltech Labs Inc.				Page 48 of 83



Test Report Serial No.:	040505KBC-F632-E15CW	Report Issue No.:	E632CW-032906-R0
Test Date(s):	13Sep05 - 27Nov05	Report Issue Date:	March 29, 2006
Test Rule Part(s):	FCC 47 CFR §15.247	Industry Canada RSS-210 Issue 6	
Lab Registration(s):	FCC Lab Reg. # 714830	Industry Canada Lab File # IC 3874	

F.9.5. Mode b - Lower Band-edge Emission Field Strengths @ Specified Distance

Channel 1 Mode b - Conducted Peak Band-edge Plots

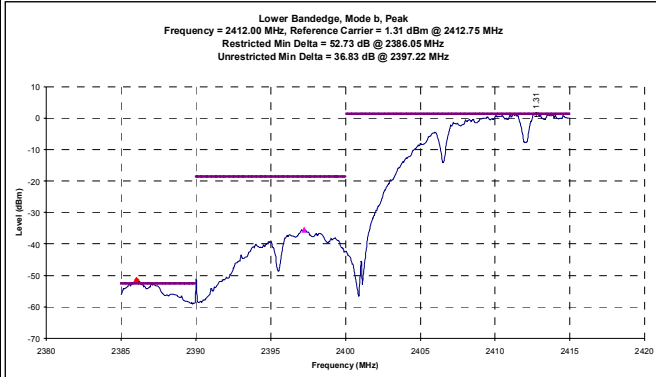

Channel 1 Mode b - Conducted Average Band-edge Plots

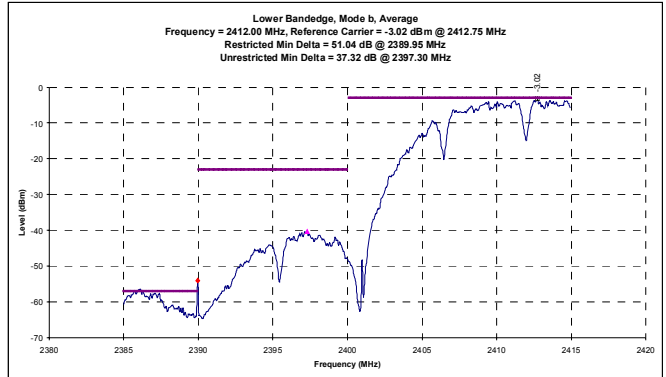

Channel 1 b - Calculated Band-edge (Unrestricted) Field Strengths

Itronix IX325 with Cisco abg - Mode b															
Channel	Polarity	Distance	Frequency	Carrier Radiated Field Strength	Delta Marker	Detector	Calculated Bandedge Field Strength	Duty Cycle Correction	Corrected Bandedge Field Strength	Specified Limit	Specified Limit Distance	Limit Distance Correction	Calculated Limit	Margin	Pass/Fail
WLAN-CH1	H	3	2397.22	103.39	36.83	PK	66.56	0.00	66.56	83.49	3.00	0.00	83.49	16.94	PASS
WLAN-CH1	H	3	2397.30	96.84	37.32	AV	59.52	0.00	59.52	77.99	3.00	0.00	77.99	18.48	PASS
WLAN-CH1	V	3	2397.22	101.19	36.83	PK	64.36	0.00	64.36	81.19	3.00	0.00	81.19	16.83	PASS
WLAN-CH1	V	3	2397.30	93.44	37.32	AV	56.12	0.00	56.12	73.44	3.00	0.00	73.44	17.32	PASS

Formulae:

- Calculated Bandedge Field Strength (dBuV/m) = Carrier Radiated Field Strength (dBuV/m) + Delta Marker (dB)
- Duty Cycle Correction (dB) = 20 * log (time on / total time)
- Corrected Bandedge Field Strength (dBuV/m) = Calculated Bandedge Field Strength (dBuV/m) + Duty Cycle Correction (dB)
- Limit Distance Correction = 20 * log (measurement distance / limit distance)
- Calculated Limit (dBuV/m) = Specified Limit (dBuV/m) + Limit Distance Correction (dB)
- Margin (dB) = Corrected Limit (dBuV/m) - Corrected Bandedge Field Strength (dBuV/m)

**Note: Measurements and calculation reference the Marker-Delta Method described in FCC Public Notice DA 00-705
 Limit based on highest radiated carrier**

Applicant:	Itronix Corporation	FCC ID:	KBCIX325-CWL	IC ID:	1943A-IX325ab	
Model(s):	IX325-CWL	IX325 Series Rugged Tablet PC with Cisco AIR-CB21AG-A-K9 802.11 abg WLAN				
2006 Celltech Labs Inc.		This document is not to be reproduced in whole or in part without the prior written permission of Celltech Labs Inc.				Page 49 of 83

	Test Report Serial No.:	040505KBC-F632-E15CW	Report Issue No.:	E632CW-032906-R0
	Test Date(s):	13Sep05 - 27Nov05	Report Issue Date:	March 29, 2006
	Test Rule Part(s):	FCC 47 CFR §15.247	Industry Canada RSS-210 Issue 6	
	Lab Registration(s):	FCC Lab Reg. # 714830	Industry Canada Lab File # IC 3874	

F.9.6. Mode b - Out-of-Band Spurious Emission Field Strengths @ Specified Distance (not within restricted bands)

		Project Number: 632 Company: Itronix Product: IX325 w CISCO abg	Standard: FCC15.209 Test Start Date: 19-Sep-05 Test End Date: 14-Oct-05														
Channel	Polarity	Distance	Rx Antenna	Frequency	SA Level	Noise Floor	Rx AF	Rx CL	Other Rx	Total Rx CF	Field Strength	Detector	Limit Distance	Limit Distance Correction	Calculated Limit	Margin	Pass/Fail
							dBuV/m	dB	dB	dB/m	dBuV/m	(PK/QP/AV)	m	dB	dBuV/m	dB	
WLAN-CH1	H	3	Horn SN6276	7238.15	42.75		35.72	6.41	-32.16	9.97	52.72	PK*	3.00	0.00	77.99	25.27	PASS
WLAN-CH1	H	3	Horn SN6276	9647.80	45.53		37.62	7.51	-31.96	13.17	58.70	PK*	3.00	0.00	77.99	19.30	PASS
WLAN-CH1	H	1	Horn SN6276	16879.90	39.28		40.17	10.75	-32.95	17.97	57.25	PK*	3.00	9.54	87.54	30.28	PASS
WLAN-CH1	H	1	Waveline 899	21708.00	38.60		40.30	12.52	-35.58	17.25	55.85	PK*	3.00	9.54	87.54	31.69	PASS
WLAN-CH1	V	3	Horn SN6276	7236.05	49.96		35.72	6.41	-32.16	9.96	59.92	PK*	3.00	0.00	73.44	13.52	PASS
WLAN-CH1	V	3	Horn SN6276	9647.85	43.77		37.62	7.51	-31.96	13.17	56.94	PK*	3.00	0.00	73.44	16.50	PASS
WLAN-CH1	V	1	Horn SN6276	16882.18	38.80		40.18	10.76	-32.95	17.98	56.78	PK*	3.00	9.54	82.98	26.20	PASS
WLAN-CH1	V	1	Waveline 899	21708.00	37.88		40.30	12.52	-35.58	17.25	55.13	PK*	3.00	9.54	82.98	27.86	PASS
WLAN-CH6	H	3	Horn SN6276	9748.05	44.31		37.70	7.56	-31.99	13.27	57.58	PK*	3.00	0.00	77.99	20.42	PASS
WLAN-CH6	H	3	Horn SN6276	3052.45	61.00		30.13	7.85	-31.94	6.03	67.03	PK	3.00	0.00	83.49	16.46	PASS
WLAN-CH6	H	3	Horn SN6276	3052.45	46.10		30.13	7.85	-31.94	6.03	52.13	AV	3.00	0.00	77.99	25.86	PASS
WLAN-CH6	H	1	Horn SN6276	14621.85	40.13		41.21	9.80	-31.68	19.34	59.47	PK*	3.00	9.54	87.54	28.07	PASS
WLAN-CH6	H	1	Horn SN6276	17059.40	39.15		41.06	10.82	-32.96	18.92	58.07	PK*	3.00	9.54	87.54	29.47	PASS
WLAN-CH6	H	1	Waveline 899	21933.00	38.03		40.30	12.61	-35.58	17.33	55.36	PK*	3.00	9.54	87.54	32.18	PASS
WLAN-CH6	V	3	Horn SN6276	9747.90	44.48		37.70	7.56	-31.99	13.27	57.75	PK*	3.00	0.00	73.44	15.69	PASS
WLAN-CH6	V	1	Horn SN6276	14621.80	40.66		41.21	9.80	-31.68	19.34	60.00	PK*	3.00	9.54	82.98	22.98	PASS
WLAN-CH6	V	1	Horn SN6276	17055.80	39.08		41.03	10.82	-32.96	18.90	57.98	PK*	3.00	9.54	82.98	25.00	PASS
WLAN-CH6	V	1	Waveline 899	21933.00	37.86		40.30	12.61	-35.58	17.33	55.19	PK*	3.00	9.54	82.98	27.79	PASS
WLAN-CH11	H	3	Horn SN6276	9847.93	42.24		37.78	7.60	-31.98	13.41	55.65	PK*	3.00	0.00	77.99	22.35	PASS
WLAN-CH11	H	1	Horn SN6276	14775.88	39.30		40.60	9.87	-31.82	18.64	57.94	PK*	3.00	9.54	87.54	29.59	PASS
WLAN-CH11	H	1	Horn SN6276	17235.30	38.71		42.11	10.88	-32.95	20.05	58.76	PK*	3.00	9.54	87.54	28.78	PASS
WLAN-CH11	V	3	Horn SN6276	1891.00	33.30		26.79	5.93	0.00	32.71	66.01	PK	3.00	0.00	81.19	15.18	PASS
WLAN-CH11	V	3	Horn SN6276	9847.93	43.54		37.78	7.60	-31.98	13.41	56.95	PK*	3.00	0.00	73.44	16.49	PASS
WLAN-CH11	V	1	Horn SN6276	14771.86	39.93		40.61	9.87	-31.81	18.67	58.60	PK*	3.00	9.54	82.98	24.38	PASS
WLAN-CH11	V	1	Horn SN6276	17237.93	38.46		42.13	10.89	-32.96	20.06	58.52	PK*	3.00	9.54	82.98	24.46	PASS

For frequency bands above 26.5 GHz, manual scans at a 1-2 cm distance were made with no emissions observed.

Notes:
 *PK denotes QP or Average limits applied to emissions measured with a peak detector
BOLD signifies the highest signal measured near a carrier harmonic frequency
 No DUT emissions levels were measured above those reported
Formulae:
 Total CF = Antenna Factor + Cable Factor + Other Factor (Amplifier Gain, filter loss, etc)
 Field Strength = SA Reading + Total CF
 Limit Distance Correction = 40*log(d1/d2) for F<30 MHz, 20*log(d1/d2) for F> 30 MHz:
 where d1 is the measurement distance, d2 is the published limit distance
 Limit = Specified Limit + Limit Distance Correction
 Margin = Limit - Field Strength

Limit based on highest radiated carrier

Applicant:	Itronix Corporation	FCC ID:	KBCIX325-CWL	IC ID:	1943A-IX325ab	
Model(s):	IX325-CWL	IX325 Series Rugged Tablet PC with Cisco AIR-CB21AG-A-K9 802.11 abg WLAN				
2006 Celltech Labs Inc.		This document is not to be reproduced in whole or in part without the prior written permission of Celltech Labs Inc.				Page 50 of 83

	Test Report Serial No.:	040505KBC-F632-E15CW	Report Issue No.:	E632CW-032906-R0
	Test Date(s):	13Sep05 - 27Nov05	Report Issue Date:	March 29, 2006
	Test Rule Part(s):	FCC 47 CFR §15.247	Industry Canada RSS-210 Issue 6	
	Lab Registration(s):	FCC Lab Reg. # 714830	Industry Canada Lab File # IC 3874	

F.9.7. Mode g - Fundamental Field Strengths @ Specified Distance (100 kHz RBW)

	Project Number:	632	Standard:	FCC15.247a
	Company:	Itronix	Test Start Date:	19-Sep-05
	Product:	IX325 with Cisco abg	Test End Date:	13-Oct-05

Itronix IX325 with Cisco ABG - mode g Carrier Field Strengths

Channel	Polarity	Measurement Distance	Antenna	Frequency	SA Level	Noise Floor	AF	CL	Other	Total CF	Field Strength	Detector	RBW
							dB/m	dB	dB	dB/m	dBuV/m		kHz
WLAN-CH1	H	3	Horn SN6267	2412.00	62.85		28.21	6.83	0.00	35.04	97.89	PK	100
WLAN-CH1	H	3	Horn SN6267	2412.00	55.35		28.21	6.83	0.00	35.04	90.39	AV	100
WLAN-CH1	V	3	Horn SN6267	2412.00	60.40		28.21	6.83	0.00	35.04	95.44	PK	100
WLAN-CH1	V	3	Horn SN6267	2412.00	53.15		28.21	6.83	0.00	35.04	88.19	AV	100
WLAN-CH6	H	3	Horn SN6267	2437.00	64.00		28.25	6.84	0.00	35.09	99.09	PK	100
WLAN-CH6	H	3	Horn SN6267	2437.00	55.40		28.25	6.84	0.00	35.09	90.49	AV	100
WLAN-CH6	V	3	Horn SN6267	2437.00	60.55		28.25	6.84	0.00	35.09	95.64	PK	100
WLAN-CH6	V	3	Horn SN6267	2437.00	53.60		28.25	6.84	0.00	35.09	88.69	AV	100
WLAN-CH11	H	3	Horn SN6267	2462.00	63.50		28.29	6.91	0.00	35.19	98.69	PK	100
WLAN-CH11	H	3	Horn SN6267	2462.00	57.35		28.29	6.91	0.00	35.19	92.54	AV	100
WLAN-CH11	V	3	Horn SN6267	2462.00	61.95		28.29	6.91	0.00	35.19	97.14	PK	100
WLAN-CH11	V	3	Horn SN6267	2462.00	54.45		28.29	6.91	0.00	35.19	89.64	AV	100

Formulae:
Total CF = AF + CL + Other
Field Strength = SA Level + Total CF

Applicant:	Itronix Corporation	FCC ID:	KBCIX325-CWL	IC ID:	1943A-IX325ab	
Model(s):	IX325-CWL	IX325 Series Rugged Tablet PC with Cisco AIR-CB21AG-A-K9 802.11 abg WLAN				
2006 Celltech Labs Inc.		This document is not to be reproduced in whole or in part without the prior written permission of Celltech Labs Inc.				Page 51 of 83

	Test Report Serial No.:	040505KBC-F632-E15CW	Report Issue No.:	E632CW-032906-R0
	Test Date(s):	13Sep05 - 27Nov05	Report Issue Date:	March 29, 2006
	Test Rule Part(s):	FCC 47 CFR §15.247	Industry Canada RSS-210 Issue 6	
	Lab Registration(s):	FCC Lab Reg. # 714830	Industry Canada Lab File # IC 3874	

F.9.8. Mode g - Lower Band-edge Emission Field Strengths @ Specified Distance

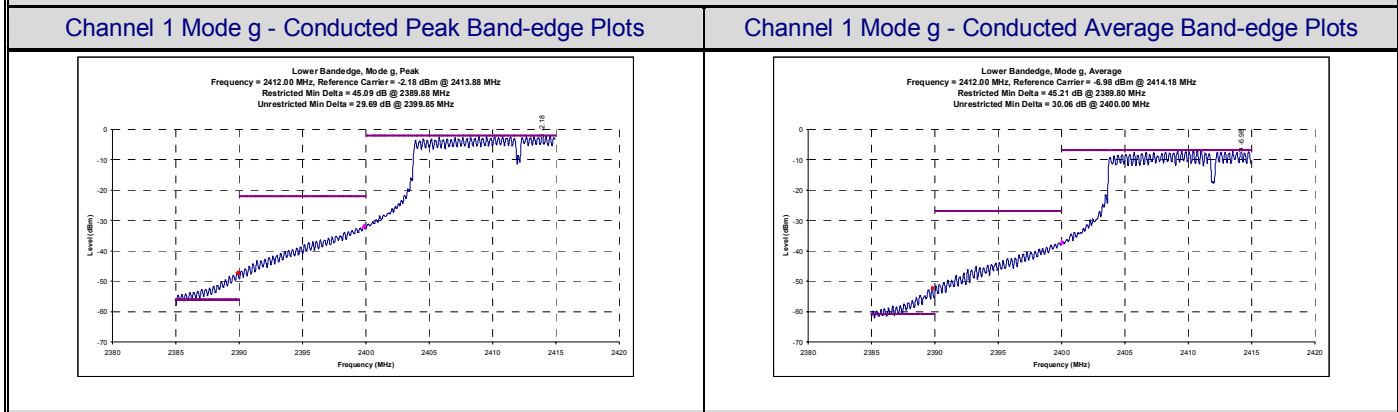

Channel 1 g – Calculated Band-edge (Unrestricted) Field Strengths

Itronix IX325 with Cisco ABG - mode g															
Channel	Polarity	Distance	Frequency	Carrier Radiated Field Strength	Delta Marker	Detector	Calculated Bandedge Field Strength	Duty Cycle Correction	Corrected Bandedge Field Strength	Specified Limit	Specified Limit Distance	Limit Distance Correction	Calculated Limit	Margin	Pass/Fail
WLAN-CH1	H	3	2399.85	97.89	29.69	PK	68.20	0.00	68.20	79.09	3.00	0.00	79.09	10.89	PASS
WLAN-CH1	H	3	2400.00	90.39	30.06	AV	60.33	0.00	60.33	72.54	3.00	0.00	72.54	12.22	PASS
WLAN-CH1	V	3	2399.85	95.44	29.69	PK	65.75	0.00	65.75	77.14	3.00	0.00	77.14	11.40	PASS
WLAN-CH1	V	3	2400.00	88.19	30.06	AV	58.13	0.00	58.13	69.64	3.00	0.00	69.64	11.52	PASS

Formulae:

- Calculated Bandedge Field Strength (dBuV/m) = Carrier Radiated Field Strength (dBuV/m) + Delta Marker (dB)
- Duty Cycle Correction (dB) = 20 * log (time on / total time)
- Corrected Bandedge Field Strength (dBuV/m) = Calculated Bandedge Field Strength (dBuV/m) + Duty Cycle Correction (dB)
- Limit Distance Correction = 20 * log (measurement distance / limit distance)
- Calculated Limit (dBuV/m) = Specified Limit (dBuV/m) + Limit Distance Correction (dB)
- Margin (dB) = Corrected Limit (dBuV/m) – Corrected Bandedge Field Strength (dBuV/m)

Note: Measurements and calculation reference the Marker-Delta Method described in FCC Public Notice DA 00-705
Limit based on highest radiated carrier

Applicant:	Itronix Corporation	FCC ID:	KBCIX325-CWL	IC ID:	1943A-IX325ab	
Model(s):	IX325-CWL	IX325 Series Rugged Tablet PC with Cisco AIR-CB21AG-A-K9 802.11 abg WLAN				
2006 Celltech Labs Inc.		This document is not to be reproduced in whole or in part without the prior written permission of Celltech Labs Inc.				Page 52 of 83

	Test Report Serial No.:	040505KBC-F632-E15CW	Report Issue No.:	E632CW-032906-R0
	Test Date(s):	13Sep05 - 27Nov05	Report Issue Date:	March 29, 2006
	Test Rule Part(s):	FCC 47 CFR §15.247	Industry Canada RSS-210 Issue 6	
	Lab Registration(s):	FCC Lab Reg. # 714830	Industry Canada Lab File # IC 3874	

F.9.9. Mode g - Out-of-Band Spurious Emission Field Strengths @ Specified Distance (not within restricted bands)

		Project Number: 632 Company: Itronix Product: IX325 with Cisco abg	Standard: FCC15.209 Test Start Date: 19-Sep-05 Test End Date: 13-Oct-05														
Channel	Polarity	Distance	Rx Antenna	Frequency	SA Level	Noise Floor	Rx AF	Rx CL	Other Rx	Total Rx CF	Field Strength	Detector	Limit Distance	Limit Distance Correction	Calculated Limit	Margin	Pass/Fail
		m		MHz	dBuV		dB/m	dB	dB	dB/m	dBuV/m	(PK/QP/AV)	m	dB	dBuV/m	dB	
WLAN-CH1	H	3	Bilog SN1607	815.70	30.50	*	22.66	3.94	0.00	26.60	57.10	PK*	3.00	0.00	72.54	15.44	PASS
WLAN-CH1	H	3	Horn SN6267	3017.50	58.40		30.10	7.82	-31.19	6.73	65.13	PK	3.00	0.00	79.09	13.96	PASS
WLAN-CH1	H	3	Horn SN6267	3017.50	26.60		30.10	7.82	-31.19	6.73	33.33	AV	3.00	0.00	72.54	39.21	PASS
WLAN-CH1	H	1	Horn SN6267	7240.25	64.05		35.81	6.41	-30.84	11.38	75.43	PK*	3.00	9.54	82.09	6.66	PASS
WLAN-CH1	H	1	Horn SN6267	9649.15	39.89		37.98	7.51	-30.71	14.78	54.67	PK*	3.00	9.54	82.09	27.42	PASS
WLAN-CH1	H	1	Horn SN6267	16880.15	40.00	*	40.43	10.75	-32.06	19.13	59.13	PK*	3.00	9.54	82.09	22.96	PASS
WLAN-CH1	H	1	Waveline 899	21708.00	38.96	*	40.30	12.52	-35.58	17.25	56.21	PK*	3.00	9.54	82.09	25.88	PASS
WLAN-CH1	V	1	Horn SN6267	7237.40	53.59		35.80	6.41	-30.84	11.37	64.96	PK*	3.00	9.54	79.19	14.23	PASS
WLAN-CH1	V	1	Horn SN6267	9650.10	40.77		37.98	7.51	-30.71	14.78	55.55	PK*	3.00	9.54	79.19	23.64	PASS
WLAN-CH1	V	1	Horn SN6267	16582.03	39.21		38.86	10.64	-31.90	17.61	56.82	PK*	3.00	9.54	79.19	22.37	PASS
WLAN-CH1	V	1	Waveline 899	21708.00	38.19		40.30	12.52	-35.58	17.25	55.44	PK*	3.00	9.54	79.19	23.75	PASS
WLAN-CH6	H	3	Horn SN6267	3042.58	57.50		30.15	7.81	-31.18	6.78	64.28	PK	3.00	0.00	79.09	14.81	PASS
WLAN-CH6	H	3	Horn SN6267	3042.58	31.10		30.15	7.81	-31.18	6.78	37.88	AV	3.00	0.00	72.54	34.66	PASS
WLAN-CH6	H	1	Horn SN6267	9748.00	40.05		38.04	7.56	-30.71	14.89	54.94	PK*	3.00	9.54	82.09	27.15	PASS
WLAN-CH6	H	1	Horn SN6267	14517.65	39.09		41.68	9.75	-30.80	20.63	59.72	PK*	3.00	9.54	82.09	22.37	PASS
WLAN-CH6	H	1	Horn SN6267	17060.35	39.17		41.32	10.82	-32.15	19.99	59.16	PK*	3.00	9.54	82.09	22.93	PASS
WLAN-CH6	H	1	Waveline 899	21933.00	38.54		40.30	12.61	-35.58	17.33	55.87	PK*	3.00	9.54	82.09	26.22	PASS
WLAN-CH6	V	1	Horn SN6267	9746.40	39.79		38.04	7.56	-30.71	14.89	54.68	PK*	3.00	9.54	79.19	24.51	PASS
WLAN-CH6	V	1	Horn SN6267	14625.35	40.36		41.27	9.80	-30.86	20.21	60.57	PK*	3.00	9.54	79.19	18.62	PASS
WLAN-CH6	V	1	Horn SN6267	17062.18	39.10		41.33	10.82	-32.15	20.00	59.10	PK*	3.00	9.54	79.19	20.09	PASS
WLAN-CH6	V	1	Waveline 899	21933.00	38.30		40.30	12.61	-35.58	17.33	55.63	PK*	3.00	9.54	79.19	23.56	PASS
WLAN-CH11	H	1	Horn SN6267	9848.00	39.65		38.10	7.60	-30.70	15.00	54.65	PK*	3.00	9.54	82.09	27.43	PASS
WLAN-CH11	H	1	Horn SN6267	14775.40	40.08		40.69	9.87	-30.94	19.62	59.70	PK*	3.00	9.54	82.09	22.39	PASS
WLAN-CH11	H	1	Horn SN6267	17229.60	39.92		42.05	10.88	-32.24	20.69	60.61	PK*	3.00	9.54	82.09	21.47	PASS
WLAN-CH11	V	3	Horn SN6267	1285.00	33.10		25.03	4.86	0.00	29.89	62.99	PK	3.00	0.00	77.14	14.15	PASS
WLAN-CH11	V	3	Horn SN6267	1285.00	22.80		25.03	4.86	0.00	29.89	52.69	AV	3.00	0.00	69.64	16.95	PASS
WLAN-CH11	V	1	Horn SN6267	9847.95	39.14		38.10	7.60	-30.70	15.00	54.14	PK*	3.00	9.54	79.19	25.04	PASS
WLAN-CH11	V	1	Horn SN6267	14769.10	39.87		40.71	9.87	-30.94	19.64	59.51	PK*	3.00	9.54	79.19	19.67	PASS
WLAN-CH11	V	1	Horn SN6267	17236.20	39.73		42.08	10.88	-32.25	20.72	60.45	PK*	3.00	9.54	79.19	18.73	PASS

For frequency bands above 26.5 GHz, manual scans at a 1-2 cm distance were made with no emissions observed.

Notes:
 *PK denotes QP or Average limits applied to emissions measured with a peak detector
BOLD signifies the highest signal measured near a carrier harmonic frequency
 No DUT emissions levels were measured above those reported
Formulae:
 Total CF = Antenna Factor + Cable Factor + Other Factor (Amplifier Gain, filter loss, etc)
 Field Strength = SA Reading + Total CF
 Limit Distance Correction = 40*log(d1/d2) for F<30 MHz, 20*log(d1/d2) for F> 30 MHz:
 where d1 is the measurement distance, d2 is the published limit distance
 Limit = Specified Limit + Limit Distance Correction
 Margin = Limit - Field Strength
Limit based on highest radiated carrier

Applicant:	Itronix Corporation	FCC ID:	KBCIX325-CWL	IC ID:	1943A-IX325ab	
Model(s):	IX325-CWL	IX325 Series Rugged Tablet PC with Cisco AIR-CB21AG-A-K9 802.11 abg WLAN				
2006 Celltech Labs Inc.		This document is not to be reproduced in whole or in part without the prior written permission of Celltech Labs Inc.				Page 53 of 83

	Test Report Serial No.:	040505KBC-F632-E15CW	Report Issue No.:	E632CW-032906-R0
	Test Date(s):	13Sep05 - 27Nov05	Report Issue Date:	March 29, 2006
	Test Rule Part(s):	FCC 47 CFR §15.247	Industry Canada RSS-210 Issue 6	
	Lab Registration(s):	FCC Lab Reg. # 714830	Industry Canada Lab File # IC 3874	

F.10. PASS/FAIL

In reference to the results outlined in F.9, the DUT passes the requirements as stated in the reference standards as follows:

FCC 15.247 (d): All emissions within any 100 kHz bandwidth outside the operating frequency band are greater than 20 dB below the maximum 100 kHz bandwidth signal within the operating band.

The emission not within a restricted band, with the lowest margin to the limit was measured at 1 meter, in the horizontal polarization with Channel 1 in Mode g at 7240.26 MHz. The peak level measured was 75.43 dBuV/m resulting in a margin of 6.66 dB to the average limit.

F.11. SIGN-OFF

I attest to the accuracy of the data. All measurements reported herein were performed by me and are correct to the best of my knowledge and belief. I assume full responsibility for the completeness of these measurements.



Russell Pipe
Senior Compliance Technologist
Celltech Labs Inc.

19Oct05
Date

Applicant:	Itronix Corporation	FCC ID:	KBCIX325-CWL	IC ID:	1943A-IX325ab	
Model(s):	IX325-CWL	IX325 Series Rugged Tablet PC with Cisco AIR-CB21AG-A-K9 802.11 abg WLAN				
2006 Celltech Labs Inc.		This document is not to be reproduced in whole or in part without the prior written permission of Celltech Labs Inc.				Page 54 of 83

	Test Report Serial No.:	040505KBC-F632-E15CW	Report Issue No.:	E632CW-032906-R0
	Test Date(s):	13Sep05 - 27Nov05	Report Issue Date:	March 29, 2006
	Test Rule Part(s):	FCC 47 CFR §15.247	Industry Canada RSS-210 Issue 6	
	Lab Registration(s):	FCC Lab Reg. # 714830	Industry Canada Lab File # IC 3874	

Appendix G - Restricted Band Emissions Measurement

G.1. REFERENCES	
Normative Reference Standard	FCC CFR 47 §15.205 (a) (b), FCC CFR 47 §15.209 (a)
Procedure Reference	FCC 97-114

G.2. LIMITS

FCC CFR 47 §15.205	(a) Except as shown in paragraph (d) of this section, only spurious emissions are permitted in any of the frequency bands listed below:			
	MHz	MHz	MHz	GHz
	0.090–0.110	16.42–16.423	399.9–410	4.5–5.15
	10.495–0.505	16.69475–16.69525	608–614	5.35–5.46
	2.1735–2.1905	16.80425–16.80475	960–1240	7.25–7.75
	4.125–4.128	25.5–25.67	1300–1427	8.025–8.5
	4.17725–4.17775	37.5–38.25	1435–1626.5	9.0–9.2
	4.20725–4.20775	73–74.6	1645.5–1646.5	9.3–9.5
	6.215–6.218	74.8–75.2	1660–1710	10.6–12.7
	6.26775–6.26825	108–121.94	1718.8–1722.2	13.25–13.4
	6.31175–6.31225	123–138	2200–2300	14.47–14.5
	8.291–8.294	149.9–150.05	2310–2390	15.35–16.2
	8.362–8.366	156.52475–156.52525	2483.5–2500	17.7–21.4
	8.37625–8.38675	156.7–156.9	2655–2900	22.01–23.12
	8.41425–8.41475	162.0125–167.17	3260–3267	23.6–24.0
	12.29–12.293	167.72–173.2	3332–3339	31.2–31.8
	12.51975–12.52025	240–285	3345.8–3358	36.43–36.5
	12.57675–12.57725	322–335.4	3600–4400	(²)
	13.36–13.41			
	¹ Until February 1, 1999, this restricted band shall be 0.490–0.510 MHz. ² Above 38.6			
	(b) Except as provided in paragraphs (d) and (e), the field strength of emissions appearing within these frequency bands shall not exceed the limits shown in 15.209. At frequencies equal to or less than 1000 MHz, compliance with the limits in Section 15.209 shall be demonstrated using measurement instrumentation employing a CISPR quasi-peak detector. Above 1000 MHz, compliance with the emission limits in Section 15.209 shall be demonstrated based on the average value of the measured emissions. The provisions of 15.35 apply to these measurements.			

FCC CFR 47 §15.209	(a) Except as provided elsewhere in this Subpart, the emissions from an intentional radiator shall not exceed the field strength levels specified in the following table:			
	Frequency	Field Strength		Measurement Distance
	MHz	uV/m	dBuV/m	Meters
	.009 – 0.490	2400/F(kHz)	48.52 – 13.80	300
	0.490 – 1.705	24000/F(kHz)	33.80 – 22.97	30
	1.705 – 30.0	30	29.54	30
	30 – 88	100	40.00	3
	88 – 216	150	43.52	3
	216 - 960	200	46.02	3
	Above 960	500	53.98	3
	(b) In the emission table above, the tighter limit applies at the band edges.			

	Test Report Serial No.:	040505KBC-F632-E15CW	Report Issue No.:	E632CW-032906-R0
	Test Date(s):	13Sep05 - 27Nov05	Report Issue Date:	March 29, 2006
	Test Rule Part(s):	FCC 47 CFR §15.247	Industry Canada RSS-210 Issue 6	
	Lab Registration(s):	FCC Lab Reg. # 714830	Industry Canada Lab File # IC 3874	

G.3. ENVIRONMENTAL CONDITIONS	
Temperature	uncontrolled
Humidity	uncontrolled
Barometric Pressure	uncontrolled

G.4. EQUIPMENT LIST						
RECEIVING EQUIPMENT						
ID	ASSET NUMBER	MANUFACTURER	MODEL	DESCRIPTION	LAST CAL	CAL DUE
1	00072	EMCO	2075	Mini-mast	na	na
2	00073	EMCO	2080	Turn Table	na	na
3	00071	EMCO	2090	Multi-Device Controller	na	na
4	00085	EMCO	6502	Loop Antenna	12Aug05	12Aug06
5	00050	Chase	CBL-6111A	Bilog Antenna	08Feb05	08Feb06
6	00034	ETS	3115	Double Ridged Guide Horn	11Aug05	11Aug06
7	00161/00166	Waveline	899/801-KF	Standard Gain Horn	na	na
8	00163	Waveline	899	Standard Gain Horn	na	Na
9	00051	HP	8566B	Spectrum Analyzer RF Section	12Apr05	12Apr06
10	00049	HP	85650A	Quasi-Peak Adapter	13Apr05	13Apr06
11	00047	HP	85685A	RF Preselector	13Apr05	13Apr06
12	00015	Agilent	4408B	Spectrum Analyzer	24Jan05	24Jan06
13	00115	Miteq	J54-00102600-35-5A	LNA	08Jun04	08Jun06
14	00093	Microtronics	HPM50111	High Pass Filter	08Jun04	08Dec05
15	00119	INMAT	18AH-10	10dB attenuator	08Jun04	08Dec05
16	00192	Agilent	8493C	6dB attenuator	01Jul05	01Jul06
17	00048	GORE	n/a	Microwave Cable (RX)	28Mar05	28Mar06
18	00121	Andrew	FSJ4-50B	Microwave Cable (RX)	12Aug05	12Aug06
19	00130	Andrew	FSJ1-50A	Microwave Cable (RX)	12Aug05	12Aug06
20	00088	HP	11970A	Harmonic mixer	na	na
21	00094	HP	11975A	Preamplifier	na	na

Applicant:	Itronix Corporation	FCC ID:	KBCIX325-CWL	IC ID:	1943A-IX325ab	
Model(s):	IX325-CWL	IX325 Series Rugged Tablet PC with Cisco AIR-CB21AG-A-K9 802.11 abg WLAN				
2006 Celltech Labs Inc.		This document is not to be reproduced in whole or in part without the prior written permission of Celltech Labs Inc.				Page 56 of 83

	Test Report Serial No.:	040505KBC-F632-E15CW	Report Issue No.:	E632CW-032906-R0
	Test Date(s):	13Sep05 - 27Nov05	Report Issue Date:	March 29, 2006
	Test Rule Part(s):	FCC 47 CFR §15.247	Industry Canada RSS-210 Issue 6	
	Lab Registration(s):	FCC Lab Reg. # 714830	Industry Canada Lab File # IC 3874	

G.5. MEASUREMENT EQUIPMENT SETUP				
MEASUREMENT EQUIPMENT CONNECTIONS	The measurement equipment was connected as shown in the G.6. A number of antennas were used to cover the applicable frequency range test. The ranges in which each antenna was used are as follows:			
	Frequency Range	Spectrum Analyzer Asset #	LNA/Filter/Attenuator Asset #	Antenna Asset #
	10kHz - 30 MHz	00051/00049/00047	none	00085
	30 MHz – 1 GHz	00051/00049/00047	none	00050
	1 GHz – 2 GHz	00051/00047	00119/00115	00034
	2 GHz – 3 GHz	00051	00119/00115	00034
	3 GHz – 7 GHz	00051	00093/00115	00034
	3 GHz – 7 GHz*	00051	00119/00192/00115	00034
	7 GHz – 18 GHz	00015	00093/00115	00161/00166
	18 GHz – 26.5 GHz	00015	00115	00161/00166
	26.5 GHz – 40 GHz	00051	none	00088/00163
* non-standard equipment configuration used for 5G Channels only				
MEASUREMENT EQUIPMENT SETTINGS	The spectrum analyzer was set to the following settings:			
	Frequency Range	RBW	VBW	Detector
	MHz	kHz	kHz	
	0.009 – 0.150	0.200	10	Peak*
	0.150 – 30	9	30	Peak*
	30 – 1000	100	300	Peak*
	> 1000	1000*	1000	Peak*
*As a worst-case measurement, the average/QP limit was applied to measurements made with a peak detector, unless otherwise noted. Average measurements were performed with video averaging using a VBW of 30 Hz.				

Applicant:	Itronix Corporation	FCC ID:	KBCIX325-CWL	IC ID:	1943A-IX325ab	
Model(s):	IX325-CWL	IX325 Series Rugged Tablet PC with Cisco AIR-CB21AG-A-K9 802.11 abg WLAN				
2006 Celltech Labs Inc.		This document is not to be reproduced in whole or in part without the prior written permission of Celltech Labs Inc.				Page 57 of 83

	Test Report Serial No.:	040505KBC-F632-E15CW	Report Issue No.:	E632CW-032906-R0
	Test Date(s):	13Sep05 - 27Nov05	Report Issue Date:	March 29, 2006
	Test Rule Part(s):	FCC 47 CFR §15.247	Industry Canada RSS-210 Issue 6	
	Lab Registration(s):	FCC Lab Reg. # 714830	Industry Canada Lab File # IC 3874	

G.6. SETUP DRAWING

Figure G.6-1 - Setup Drawing (≤ 26.5 GHz)

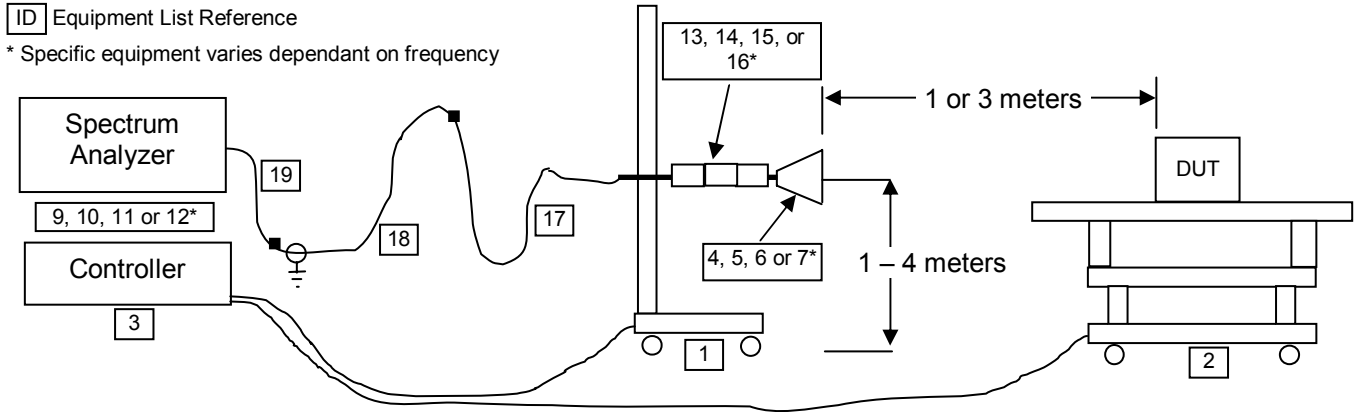
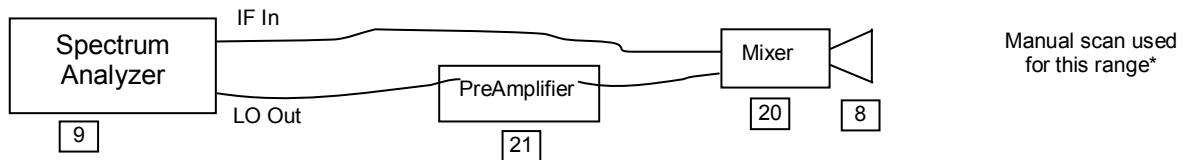



Figure G.6-2 - Setup Drawing (≥ 26.5 GHz)



Applicant:	Itronix Corporation	FCC ID:	KBCIX325-CWL	IC ID:	1943A-IX325ab	
Model(s):	IX325-CWL	IX325 Series Rugged Tablet PC with Cisco AIR-CB21AG-A-K9 802.11 abg WLAN				
2006 Celltech Labs Inc.		This document is not to be reproduced in whole or in part without the prior written permission of Celltech Labs Inc.				Page 58 of 83

G.7. SETUP PHOTOGRAPHS

Photograph G-1 - Loop Antenna (10kHz - 30 MHz) @ 3m



Photograph G-2 - Bilog Antenna (30 MHz - 1 GHz) @ 3m



Photograph G-3 - 3115 Horn @ 3m



Photograph G-4 - 3115 Horn with LNA/Filter @ 3m



Photograph G-5 - Waveline Horn with LNA @ 1m



Photograph G-6 - DUT Configuration

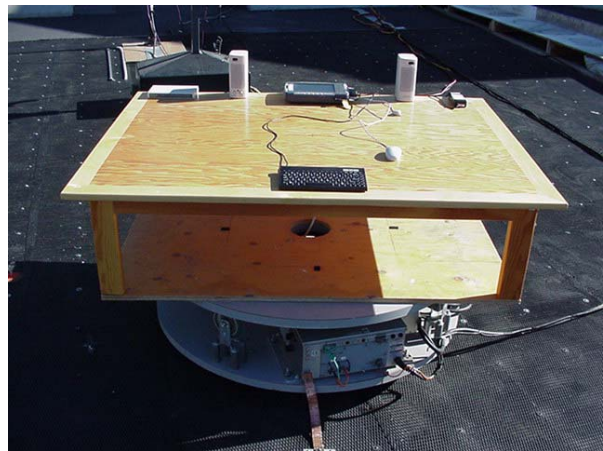

	Test Report Serial No.:	040505KBC-F632-E15CW	Report Issue No.:	E632CW-032906-R0
	Test Date(s):	13Sep05 - 27Nov05	Report Issue Date:	March 29, 2006
	Test Rule Part(s):	FCC 47 CFR §15.247	Industry Canada RSS-210 Issue 6	
	Lab Registration(s):	FCC Lab Reg. # 714830	Industry Canada Lab File # IC 3874	

G.8. DUT OPERATING DESCRIPTION

The worst-case data rate was determined from prescan investigations. Measurements were made at three channels throughout the band, Low Channel, Mid Channel, High Channels and Modes b and g and the upper band of Mode a.

G.9. TEST RESULTS

G.9.1. Mode a (upper band) - Fundamental Field Strengths @ Specified Distance (1 MHz RBW)

	Project Number:	632	Standard:	FCC15.247a
	Company:	Itronix	Test Start Date:	13-Oct-05
	Product:	IX325 with CISCO WLAN a/b/g	Test End Date:	13-Oct-05

CISCO WLAN Mode a2 Carrier Field Strengths

Channel	Polarity	Measurement Distance m	Antenna	Frequency MHz	SA Level dBuV	Noise Floor	AF	CL	Other	Total CF	Field Strength	Detector	RBW
							dB/m	dB	dB	dB/m	dBuV/m		kHz
UNII-CH149	H	3	Horn SN6267	5745.00	63.60		34.24	12.03	0.00	46.27	109.87	PK	1000
UNII-CH149	H	3	Horn SN6267	5745.00	54.10		34.24	12.03	0.00	46.27	100.37	AV	1000
UNII-CH149	V	3	Horn SN6267	5745.00	58.10		34.24	12.03	0.00	46.27	104.37	PK	1000
UNII-CH149	V	3	Horn SN6267	5745.00	49.00		34.24	12.03	0.00	46.27	95.27	AV	1000
UNII-CH157	H	3	Horn SN6267	5785.00	64.80		34.25	11.96	0.00	46.21	111.01	PK	1000
UNII-CH157	H	3	Horn SN6267	5785.00	54.60		34.25	11.96	0.00	46.21	100.81	AV	1000
UNII-CH157	V	3	Horn SN6267	5785.00	58.70		34.25	11.96	0.00	46.21	104.91	PK	1000
UNII-CH157	V	3	Horn SN6267	5785.00	48.30		34.25	11.96	0.00	46.21	94.51	AV	1000
UNII-CH165	H	3	Horn SN6267	5825.00	64.80		34.26	12.00	0.00	46.26	111.06	PK	1000
UNII-CH165	H	3	Horn SN6267	5825.00	54.45		34.26	12.00	0.00	46.26	100.71	AV	1000
UNII-CH165	V	3	Horn SN6267	5825.00	62.75		34.26	12.00	0.00	46.26	109.01	PK	1000
UNII-CH165	V	3	Horn SN6267	5825.00	51.50		34.26	12.00	0.00	46.26	97.76	AV	1000

Formulae:

Total CF = AF + CL + Other

Field Strength = SA Level + Total CF

Notes for following tables:

*PK denotes QP or Average limits applied to emissions measured with a peak detector

BOLD signifies the highest signal measured near a carrier harmonic frequency

No DUT emissions levels were measured above those reported

Formulae:

Total CF = Antenna Factor + Cable Factor + Other Factor (Amplifier Gain, filter loss, etc)

Field Strength = SA Reading + Total CF

Limit Distance Correction = $40 \cdot \log(d1/d2)$ for $F < 30$ MHz, $20 \cdot \log(d1/d2)$ for $F > 30$ MHz:

where d1 is the measurement distance, d2 is the published limit distance

Limit = Specified Limit + Limit Distance

The frequency points reported describe the highest emission measured in each of the ranges tested and are used to describe the measured spectrum as a whole. It is shown that the highest emissions measured within the spectrum pass the appropriate restricted limits; therefore all emissions within the restricted bands would also meet the requirements. No out-of-band emissions were measured above the levels noted.

Applicant:	Itronix Corporation	FCC ID:	KBCIX325-CWL	IC ID:	1943A-IX325ab	
Model(s):	IX325-CWL	IX325 Series Rugged Tablet PC with Cisco AIR-CB21AG-A-K9 802.11 abg WLAN				
2006 Celltech Labs Inc.		This document is not to be reproduced in whole or in part without the prior written permission of Celltech Labs Inc.				Page 60 of 83



Test Report Serial No.:	040505KBC-F632-E15CW	Report Issue No.:	E632CW-032906-R0
Test Date(s):	13Sep05 - 27Nov05	Report Issue Date:	March 29, 2006
Test Rule Part(s):	FCC 47 CFR §15.247	Industry Canada RSS-210 Issue 6	
Lab Registration(s):	FCC Lab Reg. # 714830	Industry Canada Lab File # IC 3874	

G.9.2. Mode a (upper band) - Channel 149 Out-of-Band Spurious Emission Field Strengths @ Specified Distance (within restricted bands)

Channel		Polarity	Distance	Rx Antenna	Frequency	SA Level	Noise Floor	Rx AF	Rx CL	Other Rx	Total Rx CF	Field Strength	Detector	Limit Distance	Limit Distance Correction	Calculated Limit	Margin	Pass/Fail
UNII-CH149	H	3	Bilog SN1607	992.27	25.60	*	24.65	4.27	0.00	28.92	54.52	PK	3.00	0.00	73.98	19.46	PASS	
UNII-CH149	H	3	Bilog SN1607	992.27	13.90	*	24.65	4.27	0.00	28.92	42.82	QP	3.00	0.00	53.98	11.16	PASS	
UNII-CH149	H	3	Horn SN6267	1018.18	27.50	*	24.48	4.36	0.00	28.84	56.34	PK	3.00	0.00	73.98	17.64	PASS	
UNII-CH149	H	3	Horn SN6267	1018.18	13.60	*	24.48	4.36	0.00	28.84	42.44	AV	3.00	0.00	53.98	11.54	PASS	
UNII-CH149	H	3	Horn SN6267	1138.11	27.50	*	24.73	4.54	0.00	29.27	56.77	PK	3.00	0.00	73.98	17.21	PASS	
UNII-CH149	H	3	Horn SN6267	1131.11	13.90	*	24.71	4.55	0.00	29.26	43.16	AV	3.00	0.00	53.98	10.82	PASS	
UNII-CH149	H	3	Horn SN6267	1330.64	27.80	*	25.13	4.94	0.00	30.07	57.87	PK	3.00	0.00	73.98	16.11	PASS	
UNII-CH149	H	3	Horn SN6267	1330.64	14.10	*	25.13	4.94	0.00	30.07	44.17	AV	3.00	0.00	53.98	9.81	PASS	
UNII-CH149	H	3	Horn SN6267	1470.82	27.70	*	25.42	5.18	0.00	30.61	58.31	PK	3.00	0.00	73.98	15.67	PASS	
UNII-CH149	H	3	Horn SN6267	1470.82	14.60	*	25.42	5.18	0.00	30.61	45.21	AV	3.00	0.00	53.98	8.77	PASS	
UNII-CH149	H	3	Horn SN6267	1701.45	28.20	*	26.32	5.63	0.00	31.95	60.15	PK	3.00	0.00	73.98	13.83	PASS	
UNII-CH149	H	3	Horn SN6267	1701.45	15.10	*	26.32	5.63	0.00	31.95	47.05	AV	3.00	0.00	53.98	6.93	PASS	
UNII-CH149	H	3	Horn SN6267	1702.95	26.80	*	26.32	5.63	0.00	31.96	58.76	PK	3.00	0.00	73.98	15.22	PASS	
UNII-CH149	H	3	Horn SN6267	1702.95	14.90	*	26.32	5.63	0.00	31.96	46.86	AV	3.00	0.00	53.98	7.12	PASS	
UNII-CH149	H	3	Horn SN6267	2237.42	34.95	*	27.93	6.53	-23.17	11.29	46.24	PK*	3.00	0.00	53.98	7.74	PASS	
UNII-CH149	H	3	Horn SN6267	2328.61	34.70	*	28.08	6.66	-23.17	11.57	46.27	PK*	3.00	0.00	53.98	7.71	PASS	
UNII-CH149	H	3	Horn SN6267	2740.57	33.45	*	29.17	7.36	-23.12	13.41	46.86	PK*	3.00	0.00	53.98	7.12	PASS	
UNII-CH149	H	3	Horn SN6267	2744.32	33.60	*	29.18	7.36	-23.12	13.42	47.02	PK*	3.00	0.00	53.98	6.96	PASS	
UNII-CH149	H	3	Horn SN6267	3829.78	37.75	*	32.03	9.17	-32.28	8.93	46.68	PK*	3.00	0.00	53.98	7.30	PASS	
UNII-CH149	H	3	Horn SN6267	4564.32	32.15	*	32.44	10.21	-32.35	10.30	42.45	PK*	3.00	0.00	53.98	11.53	PASS	
UNII-CH149	H	3	Horn SN6267	5083.84	32.40	*	33.56	10.97	-32.21	12.32	44.72	PK*	3.00	0.00	53.98	9.26	PASS	
UNII-CH149	H	3	Horn SN6267	5143.18	32.45	*	33.65	11.17	-32.18	12.64	45.09	PK*	3.00	0.00	53.98	8.89	PASS	
UNII-CH149	H	3	Horn SN6267	5388.78	31.25	*	34.02	11.87	-32.17	13.72	44.97	PK*	3.00	0.00	53.98	9.01	PASS	
UNII-CH149	H	1	Horn SN6267	11490.00	38.48	*	38.64	8.36	-31.88	15.12	53.60	PK*	3.00	9.54	63.52	9.93	PASS	
UNII-CH149	H	1	Horn SN6267	11488.55	54.54	*	38.64	8.36	-31.89	15.11	69.65	PK	3.00	9.54	83.52	13.87	PASS	
UNII-CH149	H	1	Horn SN6267	11490.75	41.18	*	38.64	8.36	-31.88	15.12	56.30	AV	3.00	9.54	63.52	7.22	PASS	
UNII-CH149	H	1	Horn SN6267	15462.80	39.35	*	37.94	10.19	-32.36	15.77	55.12	PK*	3.00	9.54	63.52	8.40	PASS	
UNII-CH149	H	1	Horn SN6267	17961.75	39.07	*	47.36	11.15	-33.45	25.06	64.13	PK	3.00	9.54	83.52	19.39	PASS	
UNII-CH149	H	1	Horn SN6267	17967.55	28.31	*	47.41	11.15	-33.44	25.12	53.43	AV	3.00	9.54	63.52	10.09	PASS	
UNII-CH149	H	1	Waveline_899	22977.00	37.78	*	40.40	12.99	-35.56	17.83	55.61	PK*	3.00	9.54	63.52	7.92	PASS	
UNII-CH149	H	1	Waveline_899	21222.00	39.93	*	40.30	12.35	-35.59	17.06	56.99	PK*	3.00	9.54	63.52	6.53	PASS	
UNII-CH149	H	1	Waveline_899	23854.25	40.22	*	40.40	13.31	-35.55	18.16	58.38	PK*	3.00	9.54	63.52	5.14	PASS	
UNII-CH149	V	3	Horn SN6267	1020.13	27.50	*	24.48	4.37	0.00	28.85	56.35	PK	3.00	0.00	73.98	17.63	PASS	
UNII-CH149	V	3	Horn SN6267	1020.13	13.60	*	24.48	4.37	0.00	28.85	42.45	AV	3.00	0.00	53.98	11.53	PASS	
UNII-CH149	V	3	Horn SN6267	1051.52	27.30	*	24.55	4.40	0.00	28.95	56.25	PK	3.00	0.00	73.98	17.73	PASS	
UNII-CH149	V	3	Horn SN6267	1051.52	14.10	*	24.55	4.40	0.00	28.95	43.05	AV	3.00	0.00	53.98	10.93	PASS	
UNII-CH149	V	3	Horn SN6267	1101.02	27.00	*	24.65	4.49	0.00	29.14	56.14	PK	3.00	0.00	73.98	17.84	PASS	
UNII-CH149	V	3	Horn SN6267	1101.02	14.20	*	24.65	4.49	0.00	29.14	43.34	AV	3.00	0.00	53.98	10.64	PASS	
UNII-CH149	V	3	Horn SN6267	1511.88	27.40	*	25.53	5.26	0.00	30.79	58.19	PK	3.00	0.00	73.98	15.79	PASS	
UNII-CH149	V	3	Horn SN6267	1511.88	14.60	*	25.53	5.26	0.00	30.79	45.39	AV	3.00	0.00	53.98	8.59	PASS	
UNII-CH149	V	3	Horn SN6267	1602.95	28.20	*	25.91	5.41	0.00	31.32	59.52	PK	3.00	0.00	73.98	14.46	PASS	
UNII-CH149	V	3	Horn SN6267	1602.95	14.70	*	25.91	5.41	0.00	31.32	46.02	AV	3.00	0.00	53.98	7.96	PASS	
UNII-CH149	V	3	Horn SN6267	1693.73	28.70	*	26.29	5.61	0.00	31.89	60.59	PK	3.00	0.00	73.98	13.39	PASS	
UNII-CH149	V	3	Horn SN6267	1693.73	15.00	*	26.29	5.61	0.00	31.89	46.89	AV	3.00	0.00	53.98	7.09	PASS	
UNII-CH149	V	3	Horn SN6267	2291.50	34.20	*	28.02	6.60	-23.16	11.46	45.66	PK*	3.00	0.00	53.98	8.32	PASS	
UNII-CH149	V	3	Horn SN6267	2372.69	35.90	*	28.15	6.73	-23.16	11.72	47.62	PK*	3.00	0.00	53.98	6.36	PASS	
UNII-CH149	V	3	Horn SN6267	2837.22	33.40	*	29.50	7.52	-23.12	13.91	47.31	PK*	3.00	0.00	53.98	6.67	PASS	
UNII-CH149	V	1	Horn SN6267	11490.00	38.48	*	38.64	8.36	-31.88	15.12	53.60	PK*	3.00	9.54	63.52	9.93	PASS	
UNII-CH149	V	1	Horn SN6267	7568.40	39.06	*	36.51	6.56	-32.13	10.93	49.99	PK*	3.00	9.54	63.52	13.53	PASS	
UNII-CH149	V	1	Horn SN6267	9346.55	39.14	*	37.91	7.37	-32.03	13.25	52.39	PK*	3.00	9.54	63.52	11.13	PASS	
UNII-CH149	V	1	Horn SN6267	11488.55	52.08	*	38.64	8.36	-31.89	15.11	67.19	PK	3.00	9.54	83.52	16.33	PASS	
UNII-CH149	V	1	Horn SN6267	11489.65	39.57	*	38.64	8.36	-31.88	15.11	54.68	AV	3.00	9.54	63.52	8.84	PASS	
UNII-CH149	V	1	Horn SN6267	13380.65	39.60	*	40.33	9.23	-31.44	18.12	57.72	PK*	3.00	9.54	63.52	5.80	PASS	
UNII-CH149	V	1	Horn SN6267	14487.80	39.31	*	41.74	9.74	-31.57	19.91	59.22	PK*	3.00	9.54	63.52	4.30	PASS	
UNII-CH149	V	1	Horn SN6267	15455.40	39.22	*	37.97	10.18	-32.35	15.80	55.02	PK*	3.00	9.54	63.52	8.50	PASS	
UNII-CH149	V	1	Horn SN6267	17987.40	39.01	*	47.59	11.16	-33.44	25.31	64.32	PK	3.00	9.54	83.52	19.20	PASS	
UNII-CH149	V	1	Horn SN6267	17989.35	28.33	*	47.61	11.16	-33.44	25.33	53.66	AV	3.00	9.54	63.52	9.86	PASS	
UNII-CH149	V	1	Waveline_899	22977.80	37.63	*	40.40	12.99	-35.56	17.83	55.46	PK*	3.00	9.54	63.52	8.07	PASS	
UNII-CH149	V	1	Waveline_899	19839.25	39.29	*	40.30	11.84	-35.51	16.62	55.91	PK*	3.00	9.54	63.52	7.61	PASS	
UNII-CH149	V	1	Waveline_899	22990.85	39.35	*	40.40	13.00	-35.56	17.83	57.18	PK*	3.00	9.54	63.52	6.34	PASS	
UNII-CH149	V	1	Waveline_899	23926.15	39.80	*	40.40	13.34	-35.55	18.18	57.98	PK*	3.00	9.54	63.52	5.54	PASS	

For frequency bands above 26.5 GHz, manual scans at a 1-2 cm distance were made with no emissions observed.

*See notes following F.9.1

Applicant:	Itronix Corporation	FCC ID:	KBCIX325-CWL	IC ID:	1943A-IX325ab	ITRONIX A GENERAL DYNAMICS COMPANY
Model(s):	IX325-CWL	IX325 Series Rugged Tablet PC with Cisco AIR-CB21AG-A-K9 802.11 abg WLAN				
2006 Celltech Labs Inc.		This document is not to be reproduced in whole or in part without the prior written permission of Celltech Labs Inc.				Page 61 of 83

 Celltech Testing and Engineering Services Lab	Test Report Serial No.:	040505KBC-F632-E15CW	Report Issue No.:	E632CW-032906-R0
	Test Date(s):	13Sep05 - 27Nov05	Report Issue Date:	March 29, 2006
	Test Rule Part(s):	FCC 47 CFR §15.247	Industry Canada RSS-210 Issue 6	
	Lab Registration(s):	FCC Lab Reg. # 714830	Industry Canada Lab File # IC 3874	

G.9.3. Mode a (upper band) - Channel 157 Out-of-Band Spurious Emission Field Strengths @ Specified Distance (within restricted bands)

Channel	Polarity	Distance m	Rx Antenna	Frequency MHz	SA Level dBuV	Noise Floor	Rx AF	Rx CL	Other Rx	Total Rx CF	Field Strength	Detector	Limit Distance	Limit Distance Correction	Calculated Limit	Margin	Pass/Fail
							dB/m	dB	dB	dB/m	dBuV/m	(PK/QP/AV)	m	dB	dBuV/m	dB	
UNII-CH157	H	3	Horn SN6267	1074.22	28.00	*	24.59	4.46	0.00	29.06	57.06	PK	3.00	0.00	73.98	16.92	PASS
UNII-CH157	H	3	Horn SN6267	1074.22	14.00	*	24.59	4.46	0.00	29.06	43.06	AV	3.00	0.00	53.98	10.92	PASS
UNII-CH157	H	3	Horn SN6267	1220.32	27.50	*	24.90	4.72	0.00	29.62	57.12	PK	3.00	0.00	73.98	16.86	PASS
UNII-CH157	H	3	Horn SN6267	1220.32	14.10	*	24.90	4.72	0.00	29.62	43.72	AV	3.00	0.00	53.98	10.26	PASS
UNII-CH157	H	3	Horn SN6267	1491.91	29.10	*	25.47	5.23	0.00	30.70	59.80	PK	3.00	0.00	73.98	14.18	PASS
UNII-CH157	H	3	Horn SN6267	1491.91	14.80	*	25.47	5.23	0.00	30.70	45.50	AV	3.00	0.00	53.98	8.48	PASS
UNII-CH157	H	3	Horn SN6267	1663.05	28.40	*	26.16	5.53	0.00	31.69	60.09	PK	3.00	0.00	73.98	13.89	PASS
UNII-CH157	H	3	Horn SN6267	1663.05	14.90	*	26.16	5.53	0.00	31.69	46.59	AV	3.00	0.00	53.98	7.39	PASS
UNII-CH157	H	3	Horn SN6267	2269.14	35.00	*	27.98	6.58	-23.17	11.39	46.39	PK*	3.00	0.00	53.98	7.59	PASS
UNII-CH157	H	3	Horn SN6267	2288.97	34.75	*	28.01	6.60	-23.16	11.46	46.21	PK*	3.00	0.00	53.98	7.77	PASS
UNII-CH157	H	3	Horn SN6267	2325.31	34.95	*	28.07	6.65	-23.17	11.56	46.51	PK*	3.00	0.00	53.98	7.47	PASS
UNII-CH157	H	3	Horn SN6267	2713.96	34.35	*	29.08	7.30	-23.13	13.25	47.60	PK*	3.00	0.00	53.98	6.38	PASS
UNII-CH157	H	3	Horn SN6267	2798.12	34.05	*	29.37	7.49	-23.12	13.74	47.79	PK*	3.00	0.00	53.98	6.19	PASS
UNII-CH157	H	3	Horn SN6267	3769.22	37.40	*	31.87	9.06	-32.25	8.69	46.09	PK*	3.00	0.00	53.98	7.89	PASS
UNII-CH157	H	3	Horn SN6267	3856.54	38.05	*	32.10	9.34	-32.28	9.17	47.22	PK*	3.00	0.00	53.98	6.76	PASS
UNII-CH157	H	3	Horn SN6267	5118.08	32.55	*	33.61	11.13	-32.21	12.53	45.08	PK*	3.00	0.00	53.98	8.90	PASS
UNII-CH157	H	1	Horn SN6267	11570.00	54.02	*	38.68	8.39	-31.83	15.24	69.26	PK	3.00	9.54	83.52	14.26	PASS
UNII-CH157	H	1	Horn SN6267	11570.00	41.28	*	38.68	8.39	-31.83	15.24	56.52	AV	3.00	9.54	63.52	7.00	PASS
UNII-CH157	H	1	Horn SN6267	8302.60	41.19	*	37.29	6.89	-32.07	12.12	53.31	PK*	3.00	9.54	63.52	10.22	PASS
UNII-CH157	H	1	Horn SN6267	11580.25	53.11	*	38.68	8.40	-31.84	15.24	68.35	PK	3.00	9.54	83.52	15.17	PASS
UNII-CH157	H	1	Horn SN6267	11580.00	38.55	*	38.68	8.40	-31.84	15.24	53.79	AV	3.00	9.54	63.52	9.73	PASS
UNII-CH157	H	1	Horn SN6267	13361.30	39.62	*	40.28	9.22	-31.51	17.99	57.61	PK*	3.00	9.54	63.52	5.91	PASS
UNII-CH157	H	1	Horn SN6267	14478.25	39.40	*	41.74	9.73	-31.55	19.92	59.32	PK*	3.00	9.54	63.52	4.20	PASS
UNII-CH157	H	1	Horn SN6267	15425.55	39.29	*	38.09	10.17	-32.36	15.90	55.19	PK*	3.00	9.54	63.52	8.33	PASS
UNII-CH157	H	1	Horn SN6267	17771.10	38.97	*	45.65	11.08	-33.37	23.36	62.33	PK	3.00	9.54	83.52	21.19	PASS
UNII-CH157	H	1	Horn SN6267	17760.80	28.12	*	45.56	11.08	-33.37	23.27	51.39	AV	3.00	9.54	63.52	12.14	PASS
UNII-CH157	H	1	Waveline_899	22732.30	39.64	*	40.40	12.90	-35.57	17.73	57.37	PK*	3.00	9.54	63.52	6.15	PASS
UNII-CH157	H	1	Waveline_899	23840.25	40.28	*	40.40	13.31	-35.55	18.15	58.43	PK*	3.00	9.54	63.52	5.09	PASS
UNII-CH157	V	3	Bilog SN1607	113.99	25.10	*	11.54	2.09	0.00	13.63	38.73	PK*	3.00	0.00	43.52	4.79	PASS
UNII-CH157	V	3	Horn SN6267	1039.96	27.30	*	24.52	4.39	0.00	28.91	56.21	PK	3.00	0.00	73.98	17.77	PASS
UNII-CH157	V	3	Horn SN6267	1039.96	14.00	*	24.52	4.39	0.00	28.91	42.91	AV	3.00	0.00	53.98	11.07	PASS
UNII-CH157	V	3	Horn SN6267	1152.38	28.20	*	24.76	4.60	0.00	29.36	57.56	PK	3.00	0.00	73.98	16.42	PASS
UNII-CH157	V	3	Horn SN6267	1152.38	14.20	*	24.76	4.60	0.00	29.36	43.56	AV	3.00	0.00	53.98	10.42	PASS
UNII-CH157	V	3	Horn SN6267	1353.95	27.80	*	25.18	4.98	0.00	30.16	57.96	PK	3.00	0.00	73.98	16.02	PASS
UNII-CH157	V	3	Horn SN6267	1353.95	14.50	*	25.18	4.98	0.00	30.16	44.66	AV	3.00	0.00	53.98	9.32	PASS
UNII-CH157	V	3	Horn SN6267	1675.05	28.30	*	26.21	5.55	0.00	31.76	60.06	PK	3.00	0.00	73.98	13.92	PASS
UNII-CH157	V	3	Horn SN6267	1675.05	15.10	*	26.21	5.55	0.00	31.76	46.86	AV	3.00	0.00	53.98	7.12	PASS
UNII-CH157	V	3	Horn SN6267	2271.64	34.05	*	27.99	6.58	-23.17	11.40	45.45	PK*	3.00	0.00	53.98	8.53	PASS
UNII-CH157	V	3	Horn SN6267	2833.75	33.45	*	29.49	7.52	-23.12	13.89	47.34	PK*	3.00	0.00	53.98	6.64	PASS
UNII-CH157	V	3	Horn SN6267	2870.85	34.50	*	29.62	7.60	-23.11	14.10	48.60	PK*	3.00	0.00	53.98	5.38	PASS
UNII-CH157	V	3	Horn SN6267	5085.00	30.80	*	33.56	10.98	-32.21	12.33	43.13	PK*	3.00	0.00	53.98	10.85	PASS
UNII-CH157	V	3	Horn SN6267	5392.46	32.30	*	34.02	11.92	-32.17	13.78	46.08	PK*	3.00	0.00	53.98	7.90	PASS
UNII-CH157	V	1	Horn SN6267	11570.00	51.34	*	38.68	8.39	-31.83	15.24	66.58	PK	3.00	9.54	83.52	16.94	PASS
UNII-CH157	V	1	Horn SN6267	11570.00	38.65	*	38.68	8.39	-31.83	15.24	53.89	AV	3.00	9.54	63.52	9.63	PASS
UNII-CH157	V	1	Horn SN6267	7713.50	42.37	*	36.63	6.62	-32.11	11.14	53.51	PK*	3.00	9.54	63.52	10.01	PASS
UNII-CH157	V	1	Horn SN6267	10844.55	38.49	*	38.15	8.06	-31.95	14.26	52.75	PK*	3.00	9.54	63.52	10.78	PASS
UNII-CH157	V	1	Horn SN6267	11565.30	38.09	*	38.67	8.39	-31.82	15.24	53.33	PK*	3.00	9.54	63.52	10.19	PASS
UNII-CH157	V	1	Horn SN6267	12617.25	37.98	*	38.59	8.88	-31.66	15.81	53.79	PK*	3.00	9.54	63.52	9.74	PASS
UNII-CH157	V	1	Horn SN6267	13335.10	40.00	*	40.21	9.21	-31.54	17.88	57.88	PK*	3.00	9.54	63.52	5.64	PASS
UNII-CH157	V	1	Horn SN6267	15474.65	39.39	*	37.89	10.19	-32.38	15.70	55.09	PK*	3.00	9.54	63.52	8.43	PASS
UNII-CH157	V	1	Horn SN6267	17894.20	40.02	*	46.75	11.13	-33.41	24.47	64.49	PK	3.00	9.54	83.52	19.03	PASS
UNII-CH157	V	1	Horn SN6267	17906.50	28.23	*	46.86	11.13	-33.43	24.57	52.80	AV	3.00	9.54	63.52	10.73	PASS
UNII-CH157	V	1	Waveline_899	19460.75	39.15	*	40.29	11.70	-35.31	16.68	55.83	PK*	3.00	9.54	63.52	7.69	PASS
UNII-CH157	V	1	Waveline_899	20661.95	41.05	*	40.30	12.14	-35.59	16.85	57.90	PK*	3.00	9.54	63.52	5.62	PASS
UNII-CH157	V	1	Waveline_899	23881.75	39.84	*	40.40	13.32	-35.55	18.17	58.01	PK*	3.00	9.54	63.52	5.51	PASS

For frequency bands above 26.5 GHz, manual scans at a 1-2 cm distance were made with no emissions observed.

*See notes following F.9.1

Applicant:	Itronix Corporation	FCC ID:	KBCIX325-CWL	IC ID:	1943A-IX325ab	 ITRONIX A GENERAL DYNAMICS COMPANY
Model(s):	IX325-CWL	IX325 Series Rugged Tablet PC with Cisco AIR-CB21AG-A-K9 802.11 abg WLAN				
2006 Celltech Labs Inc.		This document is not to be reproduced in whole or in part without the prior written permission of Celltech Labs Inc.				Page 62 of 83

	Test Report Serial No.:	040505KBC-F632-E15CW	Report Issue No.:	E632CW-032906-R0
	Test Date(s):	13Sep05 - 27Nov05	Report Issue Date:	March 29, 2006
	Test Rule Part(s):	FCC 47 CFR §15.247	Industry Canada RSS-210 Issue 6	
	Lab Registration(s):	FCC Lab Reg. # 714830	Industry Canada Lab File # IC 3874	

G.9.4. Mode a (upper band) - Channel 165 Out-of-Band Spurious Emission Field Strengths @ Specified Distance (within restricted bands)

Celltech		Project Number:	632 <th>Standard:</th> <td>FCC15.209c </td>	Standard:	FCC15.209c												
Celltech		Company:	Itronix <th>Test Start Date:</th> <td>16-Sep-05</td>	Test Start Date:	16-Sep-05												
Celltech		Product:	IX325 with CISCO WLAN ab/g	Test End Date:	13-Oct-05												
Channel	Polarity	Distance	Rx Antenna	Frequency	SA Level	Noise Floor	Rx AF	Rx CL	Other Rx	Total Rx CF	Field Strength	Detector	Limit Distance	Limit Distance Correction	Calculated Limit	Margin	Pass/Fail
		m		Mhz	dBuV		dB/m	dB	dB	dB/m	dBuV/m	(PK/QP/AV)	m	dB	dBuV/m	dB	
UNII-CH165	H	3	Horn SN6267	1089.49	27.40	*	24.63	4.49	0.00	29.11	56.51	PK	3.00	0.00	73.98	17.47	PASS
UNII-CH165	H	3	Horn SN6267	1089.49	14.10	*	24.63	4.49	0.00	29.11	43.21	AV	3.00	0.00	53.98	10.77	PASS
UNII-CH165	H	3	Horn SN6267	1507.76	28.20	*	25.52	5.26	0.00	30.77	58.97	PK	3.00	0.00	73.98	15.01	PASS
UNII-CH165	H	3	Horn SN6267	1507.76	14.70	*	25.52	5.26	0.00	30.77	45.47	AV	3.00	0.00	53.98	8.51	PASS
UNII-CH165	H	3	Horn SN6267	1670.53	28.20	*	26.19	5.54	0.00	31.73	59.93	PK	3.00	0.00	73.98	14.05	PASS
UNII-CH165	H	3	Horn SN6267	1670.53	14.90	*	26.19	5.54	0.00	31.73	46.63	AV	3.00	0.00	53.98	7.35	PASS
UNII-CH165	H	3	Horn SN6267	2298.00	35.65	*	28.03	6.61	-23.16	11.47	47.12	PK*	3.00	0.00	53.98	6.85	PASS
UNII-CH165	H	3	Horn SN6267	2664.70	34.80	*	28.91	7.23	-23.14	13.00	47.80	PK*	3.00	0.00	53.98	6.18	PASS
UNII-CH165	H	3	Horn SN6267	2825.57	34.90	*	29.46	7.52	-23.13	13.85	48.75	PK*	3.00	0.00	53.98	5.22	PASS
UNII-CH165	H	3	Horn SN6267	2881.49	34.40	*	29.65	7.65	-23.11	14.19	48.59	PK*	3.00	0.00	53.98	5.39	PASS
UNII-CH165	H	3	Horn SN6267	3883.16	36.35	*	32.17	9.20	-32.34	9.04	45.39	PK*	3.00	0.00	53.98	8.59	PASS
UNII-CH165	H	3	Horn SN6267	4299.66	32.85	*	32.37	9.98	-32.41	9.95	42.80	PK*	3.00	0.00	53.98	11.18	PASS
UNII-CH165	H	3	Horn SN6267	5143.70	33.00	*	33.65	11.17	-32.18	12.64	45.64	PK*	3.00	0.00	53.98	8.34	PASS
UNII-CH165	H	1	Horn SN6267	11650.00	52.92	*	38.70	8.43	-31.84	15.30	68.22	PK	3.00	9.54	83.52	15.30	PASS
UNII-CH165	H	1	Horn SN6267	11650.00	40.74	*	38.70	8.43	-31.84	15.30	56.04	AV	3.00	9.54	63.52	7.48	PASS
UNII-CH165	H	1	Horn SN6267	8337.90	38.84	*	37.34	6.91	-32.06	12.19	51.03	PK*	3.00	9.54	63.52	12.49	PASS
UNII-CH165	H	1	Horn SN6267	11645.55	54.98	*	38.70	8.43	-31.82	15.31	70.29	PK	3.00	9.54	83.52	13.23	PASS
UNII-CH165	H	1	Horn SN6267	11649.85	41.00	*	38.70	8.43	-31.83	15.30	56.30	AV	3.00	9.54	63.52	7.22	PASS
UNII-CH165	H	1	Horn SN6267	15375.50	39.27	*	38.29	10.15	-32.34	16.10	55.37	PK*	3.00	9.54	63.52	8.15	PASS
UNII-CH165	H	1	Horn SN6267	17894.10	38.85	*	46.75	11.13	-33.41	24.47	63.32	PK	3.00	9.54	83.52	20.20	PASS
UNII-CH165	H	1	Horn SN6267	17897.25	28.33	*	46.78	11.13	-33.41	24.50	52.83	AV	3.00	9.54	63.52	10.69	PASS
UNII-CH165	H	1	Waveline_899	22779.25	39.72	*	40.40	12.92	-35.57	17.75	57.47	PK*	3.00	9.54	63.52	6.05	PASS
UNII-CH165	H	1	Waveline_899	23858.80	39.57	*	40.40	13.31	-35.55	18.16	57.73	PK*	3.00	9.54	63.52	5.79	PASS
UNII-CH165	V	3	Bilog SN1607	243.73	25.30	*	12.05	2.45	0.00	14.50	39.80	PK*	3.00	0.00	46.02	6.23	PASS
UNII-CH165	V	3	Bilog SN1607	266.07	25.50	*	14.01	2.51	0.00	16.53	42.03	PK*	3.00	0.00	46.02	3.99	PASS
UNII-CH165	V	3	Bilog SN1607	324.09	24.50	*	14.36	2.65	0.00	17.02	41.52	PK*	3.00	0.00	46.02	4.50	PASS
UNII-CH165	V	3	Bilog SN1607	962.14	25.00	*	25.50	4.21	0.00	29.71	54.71	PK	3.00	0.00	73.98	19.27	PASS
UNII-CH165	V	3	Bilog SN1607	962.14	13.50	*	25.50	4.21	0.00	29.71	43.21	QP	3.00	0.00	53.98	10.77	PASS
UNII-CH165	V	3	Horn SN6267	1061.81	28.00	*	24.57	4.42	0.00	28.99	56.99	PK	3.00	0.00	73.98	16.99	PASS
UNII-CH165	V	3	Horn SN6267	1061.81	14.10	*	24.57	4.42	0.00	28.99	43.09	AV	3.00	0.00	53.98	10.89	PASS
UNII-CH165	V	3	Horn SN6267	1224.85	28.20	*	24.91	4.73	0.00	29.64	57.84	PK	3.00	0.00	73.98	16.14	PASS
UNII-CH165	V	3	Horn SN6267	1224.85	14.20	*	24.91	4.73	0.00	29.64	43.84	AV	3.00	0.00	53.98	10.14	PASS
UNII-CH165	V	3	Horn SN6267	1438.64	27.80	*	25.35	5.12	0.00	30.47	58.27	PK	3.00	0.00	73.98	15.71	PASS
UNII-CH165	V	3	Horn SN6267	1438.64	14.60	*	25.35	5.12	0.00	30.47	45.07	AV	3.00	0.00	53.98	8.91	PASS
UNII-CH165	V	3	Horn SN6267	1517.63	28.30	*	25.56	5.26	0.00	30.82	59.12	PK	3.00	0.00	73.98	14.86	PASS
UNII-CH165	V	3	Horn SN6267	1517.63	14.70	*	25.56	5.26	0.00	30.82	45.52	AV	3.00	0.00	53.98	8.46	PASS
UNII-CH165	V	3	Horn SN6267	1687.75	28.90	*	26.26	5.59	0.00	31.85	60.75	PK	3.00	0.00	73.98	13.23	PASS
UNII-CH165	V	3	Horn SN6267	1687.75	15.00	*	26.26	5.59	0.00	31.85	46.85	AV	3.00	0.00	53.98	7.13	PASS
UNII-CH165	V	3	Horn SN6267	2335.35	34.45	*	28.09	6.67	-23.17	11.59	46.04	PK*	3.00	0.00	53.98	7.94	PASS
UNII-CH165	V	3	Horn SN6267	2367.80	34.50	*	28.14	6.72	-23.16	11.70	46.20	PK*	3.00	0.00	53.98	7.78	PASS
UNII-CH165	V	3	Horn SN6267	2776.81	33.95	*	29.29	7.41	-23.13	13.58	47.53	PK*	3.00	0.00	53.98	6.45	PASS
UNII-CH165	V	3	Horn SN6267	2840.84	34.50	*	29.51	7.52	-23.12	13.92	48.42	PK*	3.00	0.00	53.98	5.56	PASS
UNII-CH165	V	3	Horn SN6267	4299.98	39.35	*	32.37	9.98	-32.41	9.95	49.30	PK*	3.00	0.00	53.98	4.68	PASS
UNII-CH165	V	3	Horn SN6267	5060.70	31.85	*	33.52	10.94	-32.20	12.26	44.11	PK*	3.00	0.00	53.98	9.87	PASS
UNII-CH165	V	3	Horn SN6267	5412.88	33.40	*	34.05	11.71	-32.17	13.60	47.00	PK*	3.00	0.00	53.98	6.98	PASS
UNII-CH165	V	1	Horn SN6267	11650.00	51.64	*	38.70	8.43	-31.84	15.30	66.94	PK	3.00	9.54	83.52	16.58	PASS
UNII-CH165	V	1	Horn SN6267	11650.00	38.95	*	38.70	8.43	-31.84	15.30	54.25	AV	3.00	9.54	63.52	9.27	PASS
UNII-CH165	V	1	Horn SN6267	12312.10	37.95	*	38.54	8.74	-31.75	15.52	53.47	PK*	3.00	9.54	63.52	10.05	PASS
UNII-CH165	V	1	Horn SN6267	13393.30	39.18	*	40.36	9.23	-31.43	18.17	57.35	PK*	3.00	9.54	63.52	6.17	PASS
UNII-CH165	V	1	Horn SN6267	15800.75	39.05	*	37.46	10.34	-32.54	15.26	54.31	PK*	3.00	9.54	63.52	9.21	PASS
UNII-CH165	V	1	Horn SN6267	17948.90	39.12	*	47.24	11.15	-33.44	24.95	64.07	PK	3.00	9.54	83.52	19.45	PASS
UNII-CH165	V	1	Horn SN6267	17951.55	28.45	*	47.27	11.15	-33.44	24.97	53.42	AV	3.00	9.54	63.52	10.10	PASS
UNII-CH165	V	1	Waveline_899	20648.25	40.61	*	40.30	12.14	-35.59	16.84	57.45	PK*	3.00	9.54	63.52	6.07	PASS
UNII-CH165	V	1	Waveline_899	22703.80	40.04	*	40.40	12.89	-35.57	17.72	57.76	PK*	3.00	9.54	63.52	5.76	PASS
UNII-CH165	V	1	Waveline_899	23915.80	39.32	*	40.40	13.33	-35.55	18.18	57.50	PK*	3.00	9.54	63.52	6.02	PASS

For frequency bands above 26.5 GHz, manual scans at a 1-2 cm distance were made with no emissions observed.

*See notes following F.9.1

Applicant:	Itronix Corporation	FCC ID:	KBCIX325-CWL	IC ID:	1943A-IX325ab	
Model(s):	IX325-CWL	IX325 Series Rugged Tablet PC with Cisco AIR-CB21AG-A-K9 802.11 abg WLAN				
2006 Celltech Labs Inc.		This document is not to be reproduced in whole or in part without the prior written permission of Celltech Labs Inc.				Page 63 of 83

	Test Report Serial No.:	040505KBC-F632-E15CW	Report Issue No.:	E632CW-032906-R0
	Test Date(s):	13Sep05 - 27Nov05	Report Issue Date:	March 29, 2006
	Test Rule Part(s):	FCC 47 CFR §15.247	Industry Canada RSS-210 Issue 6	
	Lab Registration(s):	FCC Lab Reg. # 714830	Industry Canada Lab File # IC 3874	

G.9.5. Mode b - Fundamental Field Strengths @ Specified Distance (1 MHz RBW)

IX325 with Cisco abg - mode b Carrier Field Strengths													
Channel	Polarity	Measurement Distance	Antenna	Frequency	SA Level	Noise Floor	AF	CL	Other	Total CF	Field Strength	Detector	RBW
							dB/m	dB	dB	dB/m	dBuV/m		kHz
WLAN-CH1	H	3	Horn SN6267	2412.00	72.15		28.21	6.83	0.00	35.04	107.19	PK	1000
WLAN-CH1	H	3	Horn SN6267	2412.00	68.75		28.21	6.83	0.00	35.04	103.79	AV	1000
WLAN-CH1	V	3	Horn SN6267	2412.00	70.10		28.21	6.83	0.00	35.04	105.14	PK	1000
WLAN-CH1	V	3	Horn SN6267	2412.00	66.65		28.21	6.83	0.00	35.04	101.69	AV	1000
WLAN-CH6	H	3	Horn SN6267	2437.00	71.10		28.25	6.84	0.00	35.09	106.19	PK	1000
WLAN-CH6	H	3	Horn SN6267	2437.00	68.15		28.25	6.84	0.00	35.09	103.24	AV	1000
WLAN-CH6	V	3	Horn SN6267	2437.00	68.95		28.25	6.84	0.00	35.09	104.04	PK	1000
WLAN-CH6	V	3	Horn SN6267	2437.00	66.25		28.25	6.84	0.00	35.09	101.34	AV	1000
WLAN-CH11	H	3	Horn SN6267	2462.00	71.70		28.29	6.91	0.00	35.19	106.89	PK	1000
WLAN-CH11	H	3	Horn SN6267	2462.00	68.70		28.29	6.91	0.00	35.19	103.89	AV	1000
WLAN-CH11	V	3	Horn SN6267	2462.00	68.45		28.29	6.91	0.00	35.19	103.64	PK	1000
WLAN-CH11	V	3	Horn SN6267	2462.00	65.75		28.29	6.91	0.00	35.19	100.94	AV	1000

Formulae:
Total CF = AF + CL + Other
Field Strength = SA Level + Total CF

Applicant:	Itronix Corporation	FCC ID:	KBCIX325-CWL	IC ID:	1943A-IX325ab	
Model(s):	IX325-CWL	IX325 Series Rugged Tablet PC with Cisco AIR-CB21AG-A-K9 802.11 abg WLAN				
2006 Celltech Labs Inc.		This document is not to be reproduced in whole or in part without the prior written permission of Celltech Labs Inc.				Page 64 of 83



Test Report Serial No.:	040505KBC-F632-E15CW	Report Issue No.:	E632CW-032906-R0
Test Date(s):	13Sep05 - 27Nov05	Report Issue Date:	March 29, 2006
Test Rule Part(s):	FCC 47 CFR §15.247	Industry Canada RSS-210 Issue 6	
Lab Registration(s):	FCC Lab Reg. # 714830	Industry Canada Lab File # IC 3874	

G.9.6. Mode b - Band-edge Emission Field Strengths @ Specified Distance (Restricted band)

Channel 1 Mode b - Conducted Peak Band-edge Plots

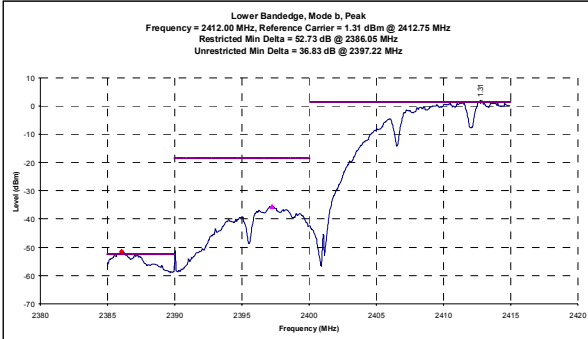

Channel 1 Mode b - Conducted Average Band-edge Plots

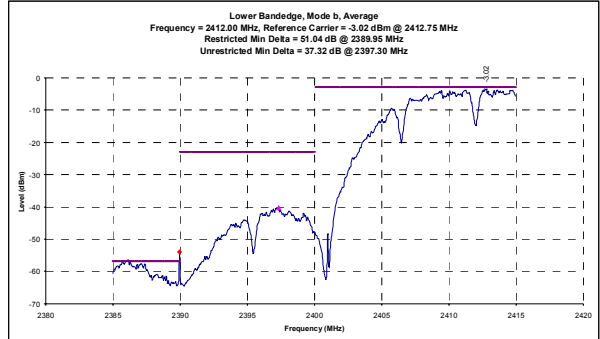

Channel 11 Mode b - Conducted Peak Band-edge Plots

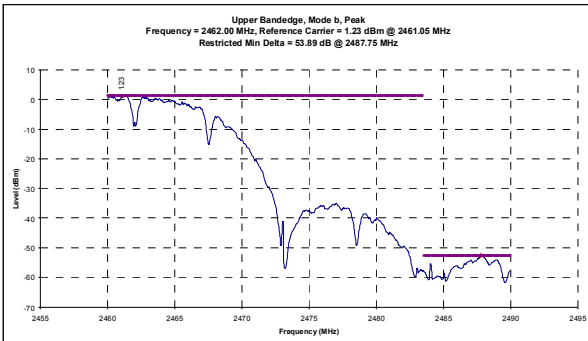

Channel 11 Mode b - Conducted Average Band-edge Plots

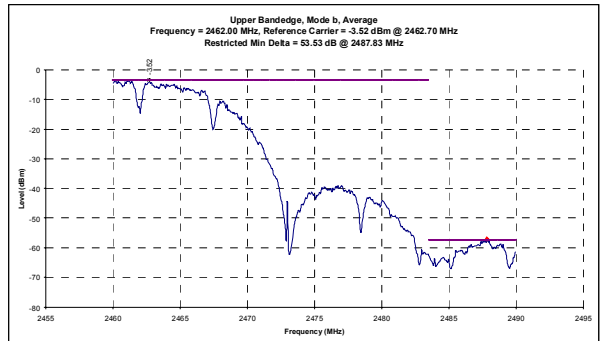

Mode b - Calculated Band-edge (Restricted) Field Strengths

Itronix IX325 with Cisco abg - Mode b															
Channel	Polarity	Distance	Frequency	Carrier Radiated Field Strength	Delta Marker	Detector	Calculated Bandedge Field Strength	Duty Cycle Correction	Corrected Bandedge Field Strength	Specified Limit	Specified Limit Distance	Limit Distance Correction	Calculated Limit	Margin	Pass/Fail
WLAN-CH1	H	3	2386.05	107.19	52.73	PK	54.46	0.00	54.46	73.98	3.00	0.00	73.98	19.52	PASS
WLAN-CH1	H	3	2389.95	103.79	51.04	AV	52.75	0.00	52.75	53.98	3.00	0.00	53.98	1.23	PASS
WLAN-CH1	V	3	2386.05	105.14	52.73	PK	52.41	0.00	52.41	73.98	3.00	0.00	73.98	21.57	PASS
WLAN-CH1	V	3	2389.95	101.69	51.04	AV	50.65	0.00	50.65	53.98	3.00	0.00	53.98	3.33	PASS
WLAN-CH11	H	3	2487.75	106.89	53.89	PK	53.00	0.00	53.00	73.98	3.00	0.00	73.98	20.98	PASS
WLAN-CH11	H	3	2487.83	103.89	53.53	AV	50.36	0.00	50.36	53.98	3.00	0.00	53.98	3.62	PASS
WLAN-CH11	V	3	2487.75	103.64	53.89	PK	49.75	0.00	49.75	73.98	3.00	0.00	73.98	24.23	PASS
WLAN-CH11	V	3	2487.83	100.94	53.53	AV	47.41	0.00	47.41	53.98	3.00	0.00	53.98	6.57	PASS

Formulae:

Calculated Bandedge Field Strength (dBuV/m) = Carrier Radiated Field Strength (dBuV/m) + Delta Marker (dB)

Duty Cycle Correction (dB) = 20 * log (time on / total time)

Corrected Bandedge Field Strength (dBuV/m) = Calculated Bandedge Field Strength (dBuV/m) + Duty Cycle Correction (dB)

Limit Distance Correction = 20 * log (measurement distance / limit distance)

Calculated Limit (dBuV/m) = Specified Limit (dBuV/m) + Limit Distance Correction (dB)

Margin (dB) = Corrected Limit (dBuV/m) - Corrected Bandedge Field Strength (dBuV/m)

Note: Measurements and calculation reference the Marker-Delta Method described in FCC Public Notice DA 00-705

Applicant:	Itronix Corporation	FCC ID:	KBCIX325-CWL	IC ID:	1943A-IX325ab	ITRONIX A GENERAL DYNAMICS COMPANY
Model(s):	IX325-CWL	IX325 Series Rugged Tablet PC with Cisco AIR-CB21AG-A-K9 802.11 abg WLAN				
2006 Celltech Labs Inc.		This document is not to be reproduced in whole or in part without the prior written permission of Celltech Labs Inc.				Page 65 of 83

	Test Report Serial No.:	040505KBC-F632-E15CW	Report Issue No.:	E632CW-032906-R0
	Test Date(s):	13Sep05 - 27Nov05	Report Issue Date:	March 29, 2006
	Test Rule Part(s):	FCC 47 CFR §15.247	Industry Canada RSS-210 Issue 6	
	Lab Registration(s):	FCC Lab Reg. # 714830	Industry Canada Lab File # IC 3874	

G.9.7. Mode b - Out-of-Band Spurious Emission Field Strengths @ Specified Distance (within restricted bands)

		Project Number: 632	Standard: FCC15.209
		Company: Itronix	Test Start Date: 19-Sep-05
		Product: IX325 w CISCO abg	Test End Date: 14-Oct-05

Channel	Polarity	Distance	Rx Antenna	Frequency	SA Level	Noise Floor	Rx AF	Rx CL	Other Rx	Total Rx CF	Field Strength	Detector	Limit Distance	Limit Distance Correction	Calculated Limit	Margin	Pass/Fail
							dB/m	dB	dB	dB/m	dBuV/m	(PK/QP/AV)	m	dB	dBuV/m	dB	
				MHz	dBuV												
WLAN-CH1	H	3	Horn SN6276	2845.54	49.80		29.47	7.53	-23.09	13.91	63.71	PK	3.00	0.00	73.98	10.27	PASS
WLAN-CH1	H	3	Horn SN6276	2845.54	32.60		29.47	7.53	-23.09	13.91	46.51	AV	3.00	0.00	53.98	7.47	PASS
WLAN-CH1	H	3	Horn SN6276	2854.62	55.70		29.51	7.53	-23.09	13.95	69.65	PK	3.00	0.00	73.98	4.33	PASS
WLAN-CH1	H	3	Horn SN6276	2854.62	30.10		29.51	7.53	-23.09	13.95	44.05	AV	3.00	0.00	53.98	9.93	PASS
WLAN-CH1	H	3	Horn SN6276	4823.89	40.40		32.91	5.31	-32.34	5.88	46.28	PK*	3.00	0.00	53.98	7.70	PASS
WLAN-CH1	H	1	Horn SN6276	12060.50	39.66		38.84	8.62	-31.76	15.70	55.36	PK*	3.00	9.54	63.52	8.16	PASS
WLAN-CH1	H	1	Horn SN6276	14474.60	39.90		41.68	9.73	-31.54	19.87	59.77	PK*	3.00	9.54	63.52	3.75	PASS
WLAN-CH1	H	1	Waveline 899	19296.00	37.21		40.26	11.64	-35.23	16.67	53.88	PK*	3.00	9.54	63.52	9.64	PASS
WLAN-CH1	V	3	Horn SN6276	2848.45	40.30		29.48	7.53	-23.09	13.92	54.22	PK	3.00	0.00	73.98	19.76	PASS
WLAN-CH1	V	3	Horn SN6276	2848.45	35.20		29.48	7.53	-23.09	13.92	49.12	AV	3.00	0.00	53.98	4.86	PASS
WLAN-CH1	V	3	Horn SN6276	2865.00	31.30		29.54	7.56	-23.09	14.01	45.31	PK*	3.00	0.00	53.98	8.66	PASS
WLAN-CH1	V	3	Horn SN6276	4823.88	43.50		32.91	5.31	-32.34	5.88	49.38	PK*	3.00	0.00	53.98	4.60	PASS
WLAN-CH1	V	1	Horn SN6276	12055.50	39.08		38.84	8.62	-31.76	15.70	54.78	PK*	3.00	9.54	63.52	8.74	PASS
WLAN-CH1	V	1	Horn SN6276	14475.38	39.45		41.68	9.73	-31.54	19.87	59.32	PK*	3.00	9.54	63.52	4.20	PASS
WLAN-CH6	H	3	Horn SN6276	2866.00	30.70		29.54	7.57	-23.09	14.02	44.72	PK*	3.00	0.00	53.98	9.26	PASS
WLAN-CH6	H	3	Horn SN6276	2898.54	29.80		29.66	7.66	-23.09	14.23	44.03	PK*	3.00	0.00	53.98	9.95	PASS
WLAN-CH6	H	3	Horn SN6276	4873.83	40.20		33.02	5.33	-32.34	6.02	46.22	PK*	3.00	0.00	53.98	7.76	PASS
WLAN-CH6	H	1	Horn SN6276	7308.43	42.29		35.88	6.44	-32.14	10.18	52.47	PK*	3.00	9.54	63.52	11.05	PASS
WLAN-CH6	H	1	Horn SN6276	12181.63	39.25		38.72	8.68	-31.71	15.68	54.93	PK*	3.00	9.54	63.52	8.59	PASS
WLAN-CH6	H	1	Waveline 899	19496.00	37.41		40.30	11.71	-35.33	16.68	54.09	PK*	3.00	9.54	63.52	9.43	PASS
WLAN-CH6	V	3	Bilog SN1607	254.07	22.60		13.21	2.47	0.00	15.67	38.27	PK*	3.00	0.00	46.02	7.75	PASS
WLAN-CH6	V	3	Horn SN6276	4873.94	41.10		33.02	5.33	-32.34	6.02	47.12	PK*	3.00	0.00	53.98	6.86	PASS
WLAN-CH6	V	1	Horn SN6276	7308.45	48.78		35.88	6.44	-32.14	10.18	58.96	PK*	3.00	9.54	63.52	4.56	PASS
WLAN-CH6	V	1	Horn SN6276	12183.25	36.23		38.72	8.68	-31.71	15.68	51.91	PK*	3.00	9.54	63.52	11.61	PASS
WLAN-CH6	V	1	Waveline 899	19496.00	37.54		40.30	11.71	-35.33	16.68	54.22	PK*	3.00	9.54	63.52	9.30	PASS
WLAN-CH11	H	3	Horn SN6276	4244.25	30.30		32.30	9.83	-32.42	9.72	40.02	PK*	3.00	0.00	53.98	13.96	PASS
WLAN-CH11	H	3	Horn SN6276	4358.00	32.10		32.26	9.99	-32.41	9.84	41.94	PK*	3.00	0.00	53.98	12.04	PASS
WLAN-CH11	H	3	Horn SN6276	4923.79	39.20		33.13	5.36	-32.29	6.20	45.40	PK*	3.00	0.00	53.98	8.58	PASS
WLAN-CH11	H	1	Horn SN6276	7386.13	43.65		36.05	6.47	-32.17	10.35	54.00	PK*	3.00	9.54	63.52	9.52	PASS
WLAN-CH11	H	1	Horn SN6276	12308.35	36.81		38.59	8.73	-31.76	15.57	52.38	PK*	3.00	9.54	63.52	11.14	PASS
WLAN-CH11	H	1	Waveline 899	19696.00	37.56		40.30	11.79	-35.44	16.65	54.21	PK*	3.00	9.54	63.52	9.31	PASS
WLAN-CH11	H	1	Waveline 899	22158.00	38.19		40.33	12.69	-35.57	17.45	55.64	PK*	3.00	9.54	63.52	7.88	PASS
WLAN-CH11	V	3	Horn SN6276	2866.00	30.90		29.54	7.57	-23.09	14.02	44.92	PK*	3.00	0.00	53.98	9.06	PASS
WLAN-CH11	V	3	Horn SN6276	4923.79	40.70		33.13	5.36	-32.29	6.20	46.90	PK*	3.00	0.00	53.98	7.08	PASS
WLAN-CH11	V	1	Horn SN6276	7386.05	46.55		36.05	6.47	-32.17	10.35	56.90	PK*	3.00	9.54	63.52	6.62	PASS
WLAN-CH11	V	1	Horn SN6276	12305.50	38.20		38.59	8.73	-31.76	15.57	53.77	PK*	3.00	9.54	63.52	9.75	PASS
WLAN-CH11	V	1	Waveline 899	19696.00	38.55		40.30	11.79	-35.44	16.65	55.20	PK*	3.00	9.54	63.52	8.32	PASS
WLAN-CH11	V	1	Waveline 899	22158.00	39.27		40.33	12.69	-35.57	17.45	56.72	PK*	3.00	9.54	63.52	6.80	PASS

For frequency bands above 26.5 GHz, manual scans at a 1-2 cm distance were made with no emissions observed.

Notes:
 *PK denotes QP or Average limits applied to emissions measured with a peak detector
BOLD signifies the highest signal measured near a carrier harmonic frequency
 No DUT emissions levels were measured above those reported
Formulae:
 Total CF = Antenna Factor + Cable Factor + Other Factor (Amplifier Gain, filter loss, etc)
 Field Strength = SA Reading + Total CF
 Limit Distance Correction = 40*log(d1/d2) for F<30 MHz, 20*log(d1/d2) for F> 30 MHz:
 where d1 is the measurement distance, d2 is the published limit distance
 Limit = Specified Limit + Limit Distance

The frequency points reported describe the highest emission measured in each of the ranges tested and are used to describe the measured spectrum as a whole. It is shown that the highest emissions measured within the spectrum pass the appropriate restricted limits; therefore all emissions within the restricted bands would also meet the requirements. No out-of-band emissions were measured above the levels noted.

Applicant:	Itronix Corporation	FCC ID:	KBCIX325-CWL	IC ID:	1943A-IX325ab	
Model(s):	IX325-CWL	IX325 Series Rugged Tablet PC with Cisco AIR-CB21AG-A-K9 802.11 abg WLAN				
2006 Celltech Labs Inc.		This document is not to be reproduced in whole or in part without the prior written permission of Celltech Labs Inc.				Page 66 of 83

	Test Report Serial No.:	040505KBC-F632-E15CW	Report Issue No.:	E632CW-032906-R0
	Test Date(s):	13Sep05 - 27Nov05	Report Issue Date:	March 29, 2006
	Test Rule Part(s):	FCC 47 CFR §15.247	Industry Canada RSS-210 Issue 6	
	Lab Registration(s):	FCC Lab Reg. # 714830	Industry Canada Lab File # IC 3874	

G.9.8. Mode g - Lower Band-edge Emission Field Strengths @ Specified Distance

	Project Number:	632	Standard:	FCC15.247a
	Company:	Itronix	Test Start Date:	19-Sep-05
	Product:	IX325 with Cisco abg	Test End Date:	13-Oct-05

Itronix IX325 with Cisco ABG - mode g Carrier Field Strengths

Channel	Polarity	Measurement Distance	Antenna	Frequency	SA Level	Noise Floor	AF	CL	Other	Total CF	Field Strength	Detector	RBW
							dB/m	dB	dB	dB/m	dBuV/m		kHz
		m		MHz	dBuV								
WLAN-CH1	H	3	Horn SN6267	2412.00	72.30		28.21	6.83	0.00	35.04	107.34	PK	1000
WLAN-CH1	H	3	Horn SN6267	2412.00	61.55		28.21	6.83	0.00	35.04	96.59	AV	1000
WLAN-CH1	V	3	Horn SN6267	2412.00	68.65		28.21	6.83	0.00	35.04	103.69	PK	1000
WLAN-CH1	V	3	Horn SN6267	2412.00	59.45		28.21	6.83	0.00	35.04	94.49	AV	1000
WLAN-CH6	H	3	Horn SN6267	2437.00	71.50		28.25	6.84	0.00	35.09	106.59	PK	1000
WLAN-CH6	H	3	Horn SN6267	2437.00	62.45		28.25	6.84	0.00	35.09	97.54	AV	1000
WLAN-CH6	V	3	Horn SN6267	2437.00	68.50		28.25	6.84	0.00	35.09	103.59	PK	1000
WLAN-CH6	V	3	Horn SN6267	2437.00	59.40		28.25	6.84	0.00	35.09	94.49	AV	1000
WLAN-CH11	H	3	Horn SN6267	2462.00	71.10		28.29	6.91	0.00	35.19	106.29	PK	1000
WLAN-CH11	H	3	Horn SN6267	2462.00	62.20		28.29	6.91	0.00	35.19	97.39	AV	1000
WLAN-CH11	V	3	Horn SN6267	2462.00	69.40		28.29	6.91	0.00	35.19	104.59	PK	1000
WLAN-CH11	V	3	Horn SN6267	2462.00	60.70		28.29	6.91	0.00	35.19	95.89	AV	1000

Formulae:
Total CF = AF + CL + Other
Field Strength = SA Level + Total CF

Applicant:	Itronix Corporation	FCC ID:	KBCIX325-CWL	IC ID:	1943A-IX325ab	
Model(s):	IX325-CWL	IX325 Series Rugged Tablet PC with Cisco AIR-CB21AG-A-K9 802.11 abg WLAN				
2006 Celltech Labs Inc.		This document is not to be reproduced in whole or in part without the prior written permission of Celltech Labs Inc.				Page 67 of 83



Test Report Serial No.:	040505KBC-F632-E15CW	Report Issue No.:	E632CW-032906-R0
Test Date(s):	13Sep05 - 27Nov05	Report Issue Date:	March 29, 2006
Test Rule Part(s):	FCC 47 CFR §15.247	Industry Canada RSS-210 Issue 6	
Lab Registration(s):	FCC Lab Reg. # 714830	Industry Canada Lab File # IC 3874	

G.9.9. Mode g - Band-edge Emission Field Strengths @ Specified Distance (Restricted)

Channel 1 Mode g - Conducted Peak Band-edge Plots

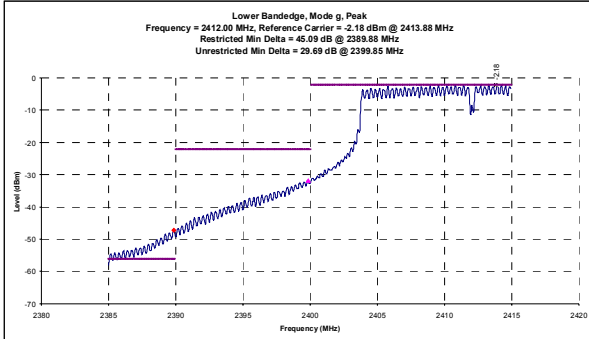

Channel 1 Mode g - Conducted Average Band-edge Plots

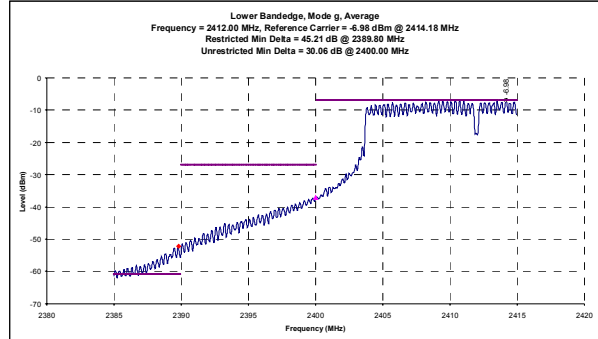

Channel 11 Mode g - Conducted Peak Band-edge Plots

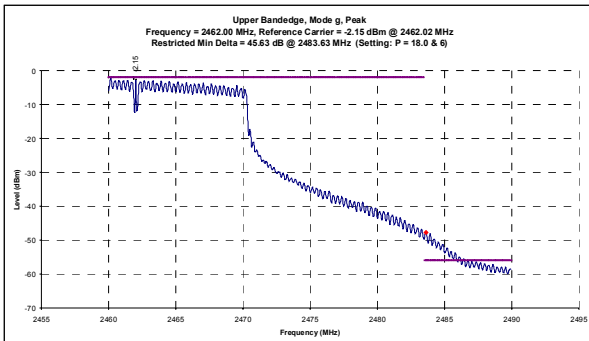

Channel 11 Mode g - Conducted Average Band-edge Plots

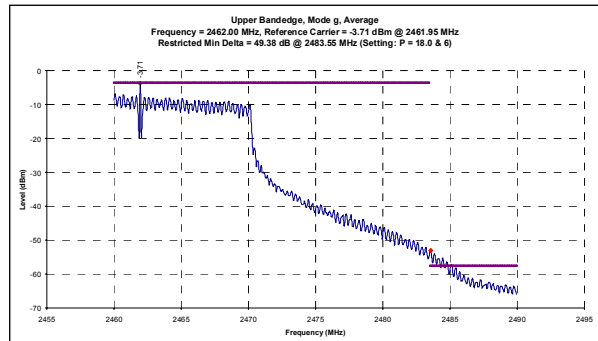

Mode g - Calculated Band-edge (Restricted) Field Strengths

Itronix IX325 with Cisco ABG - mode g															
Channel	Polarity	Distance	Frequency	Carrier Radiated Field Strength	Delta Marker	Detector	Calculated Bandedge Field Strength	Duty Cycle Correction	Corrected Bandedge Field Strength	Specified Limit	Specified Limit Distance	Limit Distance Correction	Calculated Limit	Margin	Pass/Fail
		m	MHz	dBuV/m	dB		dBuV/m	dB	dBuV/m	dBuV/m	m	dB	dBuV/m	dB	
WLAN-CH1	H	3	2389.88	107.34	45.09	PK	62.25	0.00	62.25	73.98	3.00	0.00	73.98	11.73	PASS
WLAN-CH1	H	3	2389.80	96.59	45.21	AV	51.38	0.00	51.38	53.98	3.00	0.00	53.98	2.60	PASS
WLAN-CH1	V	3	2389.88	103.69	45.09	PK	58.60	0.00	58.60	73.98	3.00	0.00	73.98	15.38	PASS
WLAN-CH1	V	3	2389.80	94.49	45.21	AV	49.28	0.00	49.28	53.98	3.00	0.00	53.98	4.70	PASS
WLAN-CH11	H	3	2483.63	106.29	45.63	PK	60.66	0.00	60.66	73.98	3.00	0.00	73.98	13.32	PASS
WLAN-CH11	H	3	2483.55	97.39	49.38	AV	48.01	0.00	48.01	53.98	3.00	0.00	53.98	5.97	PASS
WLAN-CH11	V	3	2483.63	104.59	45.63	PK	58.96	0.00	58.96	73.98	3.00	0.00	73.98	15.02	PASS
WLAN-CH11	V	3	2483.55	95.89	49.38	AV	46.51	0.00	46.51	53.98	3.00	0.00	53.98	7.47	PASS

Formulae:

- Calculated Bandedge Field Strength (dBuV/m) = Carrier Radiated Field Strength (dBuV/m) + Delta Marker (dB)
- Duty Cycle Correction (dB) = 20 * log (time on / total time)
- Corrected Bandedge Field Strength (dBuV/m) = Calculated Bandedge Field Strength (dBuV/m) + Duty Cycle Correction (dB)
- Limit Distance Correction = 20 * log (measurement distance / limit distance)
- Calculated Limit (dBuV/m) = Specified Limit (dBuV/m) + Limit Distance Correction (dB)
- Margin (dB) = Corrected Limit (dBuV/m) - Corrected Bandedge Field Strength (dBuV/m)

Note: Measurements and calculation reference the Marker-Delta Method described in FCC Public Notice DA 00-705

Applicant:	Itronix Corporation	FCC ID:	KBCIX325-CWL	IC ID:	1943A-IX325ab	ITRONIX A GENERAL DYNAMICS COMPANY
Model(s):	IX325-CWL	IX325 Series Rugged Tablet PC with Cisco AIR-CB21AG-A-K9 802.11 abg WLAN				
2006 Celltech Labs Inc.		This document is not to be reproduced in whole or in part without the prior written permission of Celltech Labs Inc.				Page 68 of 83

	Test Report Serial No.:	040505KBC-F632-E15CW	Report Issue No.:	E632CW-032906-R0
	Test Date(s):	13Sep05 - 27Nov05	Report Issue Date:	March 29, 2006
	Test Rule Part(s):	FCC 47 CFR §15.247	Industry Canada RSS-210 Issue 6	
	Lab Registration(s):	FCC Lab Reg. # 714830	Industry Canada Lab File # IC 3874	

G.9.10. Mode g - Channel 1 Out-of-Band Spurious Emission Field Strengths @ Specified Distance (within restricted bands)

	Project Number:	632	Standard:	FCC15.209
	Company:	Itronix	Test Start Date:	19-Sep-05
	Product:	IX325 with Cisco abg	Test End Date:	13-Oct-05

Channel	Polarity	Distance m	Rx Antenna	Frequency MHz	SA Level dBuV	Noise Floor	Rx AF	Rx CL	Other Rx	Total Rx CF	Field Strength	Detector (PK/QP/AV)	Limit Distance	Limit Distance Correction	Calculated Limit dBuV/m	Margin dB	Pass/Fail
							dB/m	dB	dB	dB/m	dBuV/m		m	dB			
WLAN-CH1	H	3	Bilog SN1607	131.85	22.20		12.24	2.14	0.00	14.38	36.58	PK*	3.00	0.00	43.52	6.94	PASS
WLAN-CH1	H	3	Horn SN6267	1031.00	33.30	*	24.50	4.38	0.00	28.88	62.18	PK	3.00	0.00	73.98	11.80	PASS
WLAN-CH1	H	3	Horn SN6267	1031.00	21.90	*	24.50	4.38	0.00	28.88	50.78	AV	3.00	0.00	53.98	3.20	PASS
WLAN-CH1	H	3	Horn SN6267	2499.00	32.40	*	28.35	6.96	-23.12	12.18	44.58	PK*	3.00	0.00	53.98	9.39	PASS
WLAN-CH1	H	3	Horn SN6267	4323.00	31.40	*	32.36	9.98	-31.08	11.25	42.65	PK*	3.00	0.00	53.98	11.33	PASS
WLAN-CH1	H	3	Horn SN6267	4825.90	37.40		33.03	5.31	-31.04	7.31	44.71	PK*	3.00	0.00	53.98	9.27	PASS
WLAN-CH1	H	3	Horn SN6267	4923.25	29.90		33.25	10.73	-31.03	12.96	42.86	PK*	3.00	0.00	53.98	11.12	PASS
WLAN-CH1	H	1	Horn SN6267	12064.68	49.06	*	38.77	8.62	-30.61	16.78	65.84	PK	3.00	9.54	83.52	17.68	PASS
WLAN-CH1	H	1	Horn SN6267	12053.45	32.83		38.78	8.62	-30.61	16.79	49.62	AV	3.00	9.54	63.52	13.90	PASS
WLAN-CH1	H	1	Horn SN6267	14475.40	39.74	*	41.73	9.73	-30.78	20.68	60.42	PK*	3.00	9.54	63.52	3.10	PASS
WLAN-CH1	H	1	Waveline 899	19296.00	37.78	*	40.26	11.64	-35.23	16.67	54.45	PK*	3.00	9.54	63.52	9.07	PASS
WLAN-CH1	V	3	Horn SN6267	1088.00	33.20	*	24.62	4.49	0.00	29.11	62.31	PK	3.00	0.00	73.98	11.67	PASS
WLAN-CH1	V	3	Horn SN6267	1088.00	22.30	*	24.62	4.49	0.00	29.11	51.41	AV	3.00	0.00	53.98	2.57	PASS
WLAN-CH1	V	3	Horn SN6267	4319.50	29.90	*	32.36	9.96	-31.08	11.24	41.14	PK*	3.00	0.00	53.98	12.84	PASS
WLAN-CH1	V	3	Horn SN6267	4824.70	39.30		33.03	5.31	-31.04	7.30	46.60	PK*	3.00	0.00	53.98	7.38	PASS
WLAN-CH1	V	3	Horn SN6267	4923.25	29.60		33.25	10.73	-31.03	12.96	42.56	PK*	3.00	0.00	53.98	11.42	PASS
WLAN-CH1	V	1	Horn SN6267	12065.05	43.54	*	38.77	8.62	-30.61	16.78	60.32	PK*	3.00	9.54	63.52	3.20	PASS
WLAN-CH1	V	1	Horn SN6267	14472.90	38.74	*	41.73	9.73	-30.78	20.68	59.42	PK*	3.00	9.54	63.52	4.10	PASS
WLAN-CH1	V	1	Waveline 899	19296.00	40.13	*	40.26	11.64	-35.23	16.67	56.80	PK*	3.00	9.54	63.52	6.72	PASS

For frequency bands above 26.5 GHz, manual scans at a 1-2 cm distance were made with no emissions observed.

Notes:

*PK denotes QP or Average limits applied to emissions measured with a peak detector
BOLD signifies the highest signal measured near a carrier harmonic frequency
 No DUT emissions levels were measured above those reported

Formulae:

Total CF = Antenna Factor + Cable Factor + Other Factor (Amplifier Gain, filter loss, etc)
 Field Strength = SA Reading + Total CF
 Limit Distance Correction = 40*log(d1/d2) for F<30 MHz, 20*log(d1/d2) for F> 30 MHz:
 where d1 is the measurement distance, d2 is the published limit distance
 Limit = Specified Limit + Limit Distance

The frequency points reported describe the highest emission measured in each of the ranges tested and are used to describe the measured spectrum as a whole. It is shown that the highest emissions measured within the spectrum pass the appropriate restricted limits; therefore all emissions within the restricted bands would also meet the requirements. No out-of-band emissions were measured above the levels noted.

Applicant:	Itronix Corporation	FCC ID:	KBCIX325-CWL	IC ID:	1943A-IX325ab	
Model(s):	IX325-CWL	IX325 Series Rugged Tablet PC with Cisco AIR-CB21AG-A-K9 802.11 abg WLAN				
2006 Celltech Labs Inc.		This document is not to be reproduced in whole or in part without the prior written permission of Celltech Labs Inc.				Page 69 of 83

	Test Report Serial No.:	040505KBC-F632-E15CW	Report Issue No.:	E632CW-032906-R0
	Test Date(s):	13Sep05 - 27Nov05	Report Issue Date:	March 29, 2006
	Test Rule Part(s):	FCC 47 CFR §15.247	Industry Canada RSS-210 Issue 6	
	Lab Registration(s):	FCC Lab Reg. # 714830	Industry Canada Lab File # IC 3874	

G.9.11. Mode g - Channel 6 Out-of-Band Spurious Emission Field Strengths @ Specified Distance (within restricted bands)

		Project Number: 632 Company: Itronix Product: IX325 with Cisco abg	Standard: FCC15.209 Test Start Date: 19-Sep-05 Test End Date: 13-Oct-05														
Channel	Polarity	Distance m	Rx Antenna	Frequency MHz	SA Level dBuV	Noise Floor	Rx AF	Rx CL	Other Rx	Total Rx CF	Field Strength	Detector	Limit Distance	Limit Distance Correction	Calculated Limit	Margin	Pass/Fail
							dB/m	dB	dB	dB/m	dBuV/m	(PK/QP/AV)	m	dB	dBuV/m	dB	
WLAN-CH6	H	3	Bilog SN1607	245.34	22.80	*	12.24	2.47	0.00	14.71	37.51	PK*	3.00	0.00	46.02	8.51	PASS
WLAN-CH6	H	3	Horn SN6267	1129.00	33.10	*	24.71	4.55	0.00	29.26	62.36	PK	3.00	0.00	73.98	11.62	PASS
WLAN-CH6	H	3	Horn SN6267	1129.00	22.30	*	24.71	4.55	0.00	29.26	51.56	AV	3.00	0.00	53.98	2.42	PASS
WLAN-CH6	H	3	Horn SN6267	3654.75	47.80	*	31.56	8.91	-31.13	9.34	57.14	PK	3.00	0.00	73.98	16.84	PASS
WLAN-CH6	H	3	Horn SN6267	3654.75	21.90	*	31.56	8.91	-31.13	9.34	31.24	AV	3.00	0.00	53.98	22.74	PASS
WLAN-CH6	H	3	Horn SN6267	4874.70	35.70	*	33.14	5.33	-31.04	7.44	43.14	PK*	3.00	0.00	53.98	10.84	PASS
WLAN-CH6	H	1	Horn SN6267	7306.83	56.09	*	35.98	6.44	-30.84	11.58	67.67	PK	3.00	9.54	83.52	15.85	PASS
WLAN-CH6	H	1	Horn SN6267	7305.45	34.67	*	35.97	6.44	-30.84	11.57	46.24	AV	3.00	9.54	63.52	17.28	PASS
WLAN-CH6	H	1	Horn SN6267	12183.30	46.45	*	38.66	8.68	-30.61	16.73	63.18	PK	3.00	9.54	83.52	20.34	PASS
WLAN-CH6	H	1	Horn SN6267	12180.80	32.95	*	38.66	8.68	-30.61	16.73	49.68	AV	3.00	9.54	63.52	13.84	PASS
WLAN-CH6	H	1	Waveline 899	19496.00	37.90	*	40.30	11.71	-35.33	16.68	54.58	PK*	3.00	9.54	63.52	8.94	PASS
WLAN-CH6	V	3	Bilog SN1607	254.07	22.50	*	13.21	2.47	0.00	15.67	38.17	PK*	3.00	0.00	46.02	7.85	PASS
WLAN-CH6	V	3	Bilog SN1607	243.40	21.90	*	12.01	2.45	0.00	14.46	36.36	PK*	3.00	0.00	46.02	9.66	PASS
WLAN-CH6	V	3	Horn SN6267	1130.00	33.20	*	24.71	4.55	0.00	29.26	62.46	PK	3.00	0.00	73.98	11.52	PASS
WLAN-CH6	V	3	Horn SN6267	1130.00	22.20	*	24.71	4.55	0.00	29.26	51.46	AV	3.00	0.00	53.98	2.52	PASS
WLAN-CH6	V	3	Horn SN6267	4195.25	28.90	*	32.41	9.75	-31.09	11.07	39.97	PK*	3.00	0.00	53.98	14.01	PASS
WLAN-CH6	V	3	Horn SN6267	4873.70	35.40	*	33.14	5.33	-31.04	7.44	42.84	PK*	3.00	0.00	53.98	11.14	PASS
WLAN-CH6	V	1	Horn SN6267	7306.20	52.43	*	35.97	6.44	-30.84	11.58	64.01	PK	3.00	9.54	83.52	19.52	PASS
WLAN-CH6	V	1	Horn SN6267	7301.63	23.50	*	35.96	6.44	-30.84	11.56	35.06	AV	3.00	9.54	63.52	28.46	PASS
WLAN-CH6	V	1	Horn SN6267	12177.75	39.19	*	38.67	8.67	-30.61	16.73	55.92	PK*	3.00	9.54	63.52	7.60	PASS
WLAN-CH6	V	1	Waveline 899	19496.00	38.68	*	40.30	11.71	-35.33	16.68	55.36	PK*	3.00	9.54	63.52	8.16	PASS

For frequency bands above 26.5 GHz, manual scans at a 1-2 cm distance were made with no emissions observed.

Notes:

*PK denotes QP or Average limits applied to emissions measured with a peak detector
BOLD signifies the highest signal measured near a carrier harmonic frequency
 No DUT emissions levels were measured above those reported

Formulae:

Total CF = Antenna Factor + Cable Factor + Other Factor (Amplifier Gain, filter loss, etc)

Field Strength = SA Reading + Total CF

Limit Distance Correction = 40*log(d1/d2) for F<30 MHz, 20*log(d1/d2) for F> 30 MHz:

where d1 is the measurement distance, d2 is the published limit distance

Limit = Specified Limit + Limit Distance

The frequency points reported describe the highest emission measured in each of the ranges tested and are used to describe the measured spectrum as a whole. It is shown that the highest emissions measured within the spectrum pass the appropriate restricted limits; therefore all emissions within the restricted bands would also meet the requirements. No out-of-band emissions were measured above the levels noted.

Applicant:	Itronix Corporation	FCC ID:	KBCIX325-CWL	IC ID:	1943A-IX325ab	
Model(s):	IX325-CWL	IX325 Series Rugged Tablet PC with Cisco AIR-CB21AG-A-K9 802.11 abg WLAN				
2006 Celltech Labs Inc.		This document is not to be reproduced in whole or in part without the prior written permission of Celltech Labs Inc.				Page 70 of 83

	Test Report Serial No.:	040505KBC-F632-E15CW	Report Issue No.:	E632CW-032906-R0
	Test Date(s):	13Sep05 - 27Nov05	Report Issue Date:	March 29, 2006
	Test Rule Part(s):	FCC 47 CFR §15.247	Industry Canada RSS-210 Issue 6	
	Lab Registration(s):	FCC Lab Reg. # 714830	Industry Canada Lab File # IC 3874	

G.9.12. Mode g - Channel 11 Out-of-Band Spurious Emission Field Strengths @ Specified Distance (within restricted bands)

		Project Number: 632 Company: Itronix Product: IX325 with Cisco abg	Standard: FCC15.209 Test Start Date: 19-Sep-05 Test End Date: 13-Oct-05														
Channel	Polarity	Distance	Rx Antenna	Frequency	SA Level	Noise Floor	Rx AF	Rx CL	Other Rx	Total Rx CF	Field Strength	Detector	Limit Distance	Limit Distance Correction	Calculated Limit	Margin	Pass/Fail
		m		MHz	dBuV		dB/m	dB	dB	dB/m	dBuV/m	(PK/QP/AV)	m	dB	dBuV/m	dB	
WLAN-CH11	H	3	Bilog SN1607	249.22	21.80	*	12.71	2.48	0.00	15.19	36.99	PK*	3.00	0.00	46.02	9.03	PASS
WLAN-CH11	H	3	Bilog SN1607	326.82	22.10	*	14.47	2.64	0.00	17.12	39.22	PK*	3.00	0.00	46.02	6.81	PASS
WLAN-CH11	H	3	Horn SN6267	1089.00	33.70	*	24.62	4.49	0.00	29.11	62.81	PK	3.00	0.00	73.98	11.17	PASS
WLAN-CH11	H	3	Horn SN6267	1089.00	22.20	*	24.62	4.49	0.00	29.11	51.31	AV	3.00	0.00	53.98	2.67	PASS
WLAN-CH11	H	3	Horn SN6267	1342.00	31.90	*	25.15	4.96	0.00	30.11	62.01	PK	3.00	0.00	73.98	11.97	PASS
WLAN-CH11	H	3	Horn SN6267	1342.00	19.40	*	25.15	4.96	0.00	30.11	49.51	AV	3.00	0.00	53.98	4.47	PASS
WLAN-CH11	H	3	Horn SN6267	2867.00	30.30	*	29.60	7.57	-23.09	14.09	44.39	PK*	3.00	0.00	53.98	9.59	PASS
WLAN-CH11	H	3	Horn SN6267	4321.25	29.70	*	32.36	9.97	-31.08	11.25	40.95	PK*	3.00	0.00	53.98	13.03	PASS
WLAN-CH11	H	3	Horn SN6267	4925.10	39.20	*	33.26	5.36	-31.03	7.58	46.78	PK*	3.00	0.00	53.98	7.20	PASS
WLAN-CH11	H	1	Horn SN6267	7379.60	53.52	*	36.16	6.47	-30.83	11.80	65.32	PK	3.00	9.54	83.52	18.21	PASS
WLAN-CH11	H	3	Horn SN6267	7380.65	34.81	*	36.16	6.47	-30.83	11.80	46.61	AV	3.00	0.00	53.98	7.37	PASS
WLAN-CH11	H	3	Horn SN6267	9399.75	33.40	*	37.90	15.03	-30.72	22.21	55.61	PK	3.00	0.00	73.98	18.37	PASS
WLAN-CH11	H	3	Horn SN6267	9399.75	22.20	*	37.90	15.03	-30.72	22.21	44.41	AV	3.00	0.00	53.98	9.57	PASS
WLAN-CH11	H	1	Horn SN6267	12300.10	44.72	*	38.55	8.73	-30.60	16.68	61.40	PK*	3.00	9.54	63.52	2.12	PASS
WLAN-CH11	H	1	Waveline_899	19696.00	37.61	*	40.30	11.79	-35.44	16.65	54.26	PK*	3.00	9.54	63.52	9.26	PASS
WLAN-CH11	H	1	Waveline_899	22158.00	38.12	*	40.33	12.69	-35.57	17.45	55.57	PK*	3.00	9.54	63.52	7.95	PASS
WLAN-CH11	V	3	Bilog SN1607	241.46	23.40	*	11.78	2.45	0.00	14.23	37.63	PK*	3.00	0.00	46.02	8.39	PASS
WLAN-CH11	V	3	Bilog SN1607	266.52	26.40	*	13.98	2.53	0.00	16.51	42.91	PK*	3.00	0.00	46.02	3.11	PASS
WLAN-CH11	V	3	Bilog SN1607	334.58	23.80	*	14.78	2.67	0.00	17.45	41.25	PK*	3.00	0.00	46.02	4.77	PASS
WLAN-CH11	V	3	Horn SN6267	2867.00	31.30	*	29.60	7.57	-23.09	14.09	45.39	PK*	3.00	0.00	53.98	8.59	PASS
WLAN-CH11	V	3	Horn SN6267	4513.75	30.20	*	32.32	10.19	-31.06	11.44	41.64	PK*	3.00	0.00	53.98	12.34	PASS
WLAN-CH11	V	3	Horn SN6267	4923.40	35.90	*	33.25	5.36	-31.03	7.58	43.48	PK*	3.00	0.00	53.98	10.50	PASS
WLAN-CH11	V	1	Horn SN6267	7377.25	51.79	*	36.15	6.47	-30.83	11.79	63.58	PK	3.00	9.54	83.52	19.94	PASS
WLAN-CH11	V	1	Horn SN6267	7385.50	35.06	*	36.17	6.47	-30.83	11.81	46.87	AV	3.00	9.54	63.52	16.65	PASS
WLAN-CH11	V	3	Horn SN6267	9163.50	32.70	*	37.94	15.02	-30.73	22.23	54.93	PK	3.00	0.00	73.98	19.05	PASS
WLAN-CH11	V	3	Horn SN6267	9163.50	22.60	*	37.94	15.02	-30.73	22.23	44.83	AV	3.00	0.00	53.98	9.15	PASS
WLAN-CH11	V	1	Horn SN6267	12302.75	39.20	*	38.55	8.73	-30.60	16.68	55.88	PK*	3.00	9.54	63.52	7.64	PASS
WLAN-CH11	V	1	Waveline_899	19696.00	38.19	*	40.30	11.79	-35.44	16.65	54.84	PK*	3.00	9.54	63.52	8.68	PASS
WLAN-CH11	V	1	Waveline_899	22158.00	38.25	*	40.33	12.69	-35.57	17.45	55.70	PK*	3.00	9.54	63.52	7.82	PASS

For frequency bands above 26.5 GHz, manual scans at a 1-2 cm distance were made with no emissions observed.

Notes:

*PK denotes QP or Average limits applied to emissions measured with a peak detector

BOLD signifies the highest signal measured near a carrier harmonic frequency

No DUT emissions levels were measured above those reported

Formulae:

Total CF = Antenna Factor + Cable Factor + Other Factor (Amplifier Gain, filter loss, etc)

Field Strength = SA Reading + Total CF

Limit Distance Correction = $40 \cdot \log(d1/d2)$ for $F < 30$ MHz, $20 \cdot \log(d1/d2)$ for $F > 30$ MHz:

where d1 is the measurement distance, d2 is the published limit distance

Limit = Specified Limit + Limit Distance

The frequency points reported describe the highest emission measured in each of the ranges tested and are used to describe the measured spectrum as a whole. It is shown that the highest emissions measured within the spectrum pass the appropriate restricted limits; therefore all emissions within the restricted bands would also meet the requirements. No out-of-band emissions were measured above the levels noted.

Applicant:	Itronix Corporation	FCC ID:	KBCIX325-CWL	IC ID:	1943A-IX325ab	
Model(s):	IX325-CWL	IX325 Series Rugged Tablet PC with Cisco AIR-CB21AG-A-K9 802.11 abg WLAN				
2006 Celltech Labs Inc.		This document is not to be reproduced in whole or in part without the prior written permission of Celltech Labs Inc.				Page 71 of 83

	Test Report Serial No.:	040505KBC-F632-E15CW	Report Issue No.:	E632CW-032906-R0
	Test Date(s):	13Sep05 - 27Nov05	Report Issue Date:	March 29, 2006
	Test Rule Part(s):	FCC 47 CFR §15.247	Industry Canada RSS-210 Issue 6	
	Lab Registration(s):	FCC Lab Reg. # 714830	Industry Canada Lab File # IC 3874	

G.10. PASS/FAIL

In reference to the results outlined in G.9, the DUT passes the requirements as stated in the reference standards as follows:

FCC 15.205 (a) (b) and 15.209 (a): No emissions were measured within the restricted bands as outlined in 15.205 that exceeded the limits stated in 15.209.

The emission within a restricted band, with the lowest margin to the limit was calculated for the lower band edge for Mode b (Channel 1) at 3 meters, in the horizontal polarization. The calculated average level was 52.78 dBuV/m resulting in a margin of 1.23 dB.

G.11. SIGN-OFF

I attest to the accuracy of the data. All measurements reported herein were performed by me and are correct to the best of my knowledge and belief. I assume full responsibility for the completeness of these measurements.



 Russell Pipe
 Senior Compliance Technologist
 Celltech Labs Inc.

 19Oct05
 Date

Applicant:	Itronix Corporation	FCC ID:	KBCIX325-CWL	IC ID:	1943A-IX325ab	
Model(s):	IX325-CWL	IX325 Series Rugged Tablet PC with Cisco AIR-CB21AG-A-K9 802.11 abg WLAN				
2006 Celltech Labs Inc.		This document is not to be reproduced in whole or in part without the prior written permission of Celltech Labs Inc.				Page 72 of 83

	Test Report Serial No.:	040505KBC-F632-E15CW	Report Issue No.:	E632CW-032906-R0
	Test Date(s):	13Sep05 - 27Nov05	Report Issue Date:	March 29, 2006
	Test Rule Part(s):	FCC 47 CFR §15.247	Industry Canada RSS-210 Issue 6	
	Lab Registration(s):	FCC Lab Reg. # 714830	Industry Canada Lab File # IC 3874	

Appendix H - Peak Power Spectral Density Measurement

H.1. REFERENCES	
Normative Reference Standard	FCC CFR 47 §15.247(e)
Procedure Reference	FCC Bulletin KDB Publication No 558074

H.2. LIMITS	
H.2.1. FCC CFR	
<p>§15.247(d): For digitally modulated systems, the peak power spectral density conducted from the intentional radiator to the antenna shall not be greater than +8 dBm in any 3 kHz band during any time interval of continuous transmission.</p>	

H.3. ENVIRONMENTAL CONDITIONS	
Temperature	25 ± 5 °C
Humidity	35 ± 5 %RH
Barometric Pressure	uncontrolled

H.4. EQUIPMENT LIST					
ASSET NUMBER	MANUFACTURER	MODEL	DESCRIPTION	LAST CAL	CAL DUE
00015	Agilent	E4408B	Spectrum Analyzer	24Jan05	24Jan06
Customer supplied	n/a	n/a	1ft. RG223/U RF Cable	n/a	n/a
00076	Pasternack	PE7014-30	30dB 2 Watt Attenuator	na*	na

*Cable and attenuator verified with power meter prior to use

Applicant:	Itronix Corporation	FCC ID:	KBCIX325-CWL	IC ID:	1943A-IX325ab	
Model(s):	IX325-CWL	IX325 Series Rugged Tablet PC with Cisco AIR-CB21AG-A-K9 802.11 abg WLAN				
2006 Celltech Labs Inc.		This document is not to be reproduced in whole or in part without the prior written permission of Celltech Labs Inc.				Page 73 of 83

	Test Report Serial No.:	040505KBC-F632-E15CW	Report Issue No.:	E632CW-032906-R0
	Test Date(s):	13Sep05 - 27Nov05	Report Issue Date:	March 29, 2006
	Test Rule Part(s):	FCC 47 CFR §15.247	Industry Canada RSS-210 Issue 6	
	Lab Registration(s):	FCC Lab Reg. # 714830	Industry Canada Lab File # IC 3874	

H.5. MEASUREMENT EQUIPMENT SETUP	
Measurement Equipment Connections	The equipment was connected as shown in the setup drawing in H.6.
Measurement Procedure	<p>The power spectral density measurement was performed using the PSD Option 2 method described in the FCC document KDB Publication No. 558074. Using software to control the spectrum analyzer, it was set to successively determine the signal peak, center it and reduce the RBW and span until the 3 kHz RBW was reached.</p> <p>The common settings are as follows:</p> <p>Detector – Sample* Average – Power Trace Average – 100 VBW – 1 MHz</p> <p>Offset – appropriate for external attenuation (-31.4 dB)</p> <p>The successive settings are as follows (Sweep time always 100 seconds):</p> <ol style="list-style-type: none"> 1) Span – 30 MHz, RBW – 300 kHz 2) Span – 10 MHz, RBW – 100 kHz, 3) Span – 3 MHz, RBW – 30 kHz 4) Span – 300 kHz, RBW – 3kHz <p>The analyzer display was recorded and the trace maximum of value reported.</p>

* Sample detector was used in compliance with the procedure requirements ie: Bin width < 0.5 RBW and transmitter at max power for 100 sweeps. Bin width = 300kHz /401 points = 0.748 kHz < 1.5 kHz (0.5 * 3 kHz)

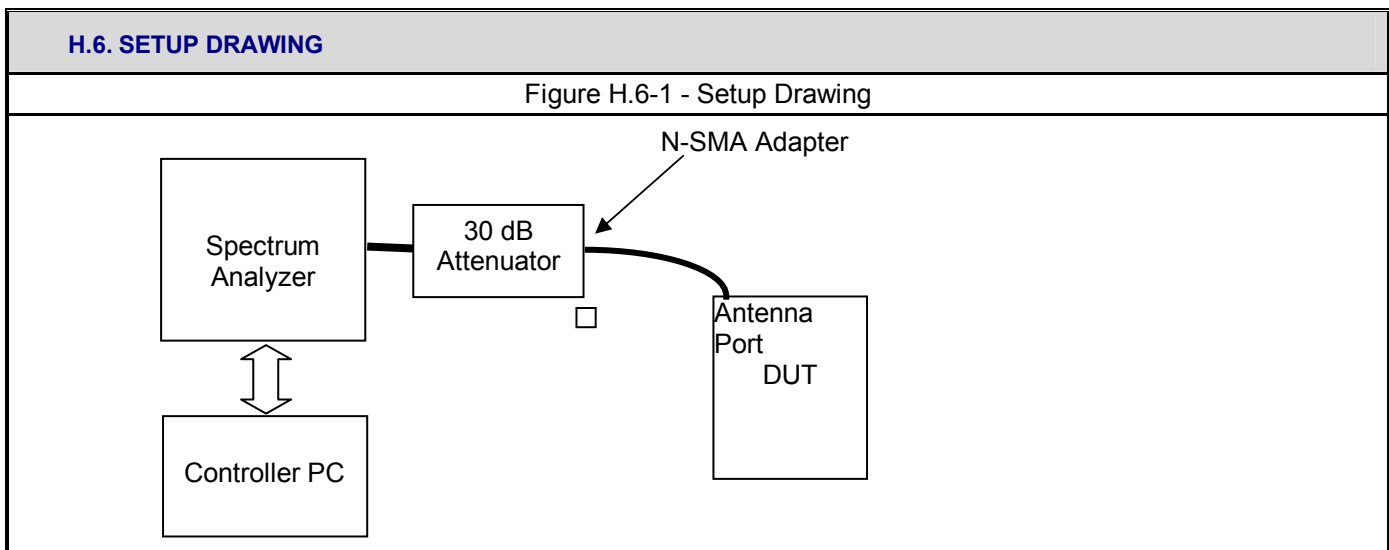

Applicant:	Itronix Corporation	FCC ID:	KBCIX325-CWL	IC ID:	1943A-IX325ab	
Model(s):	IX325-CWL	IX325 Series Rugged Tablet PC with Cisco AIR-CB21AG-A-K9 802.11 abg WLAN				
2006 Celltech Labs Inc.		This document is not to be reproduced in whole or in part without the prior written permission of Celltech Labs Inc.				Page 74 of 83

	Test Report Serial No.:	040505KBC-F632-E15CW	Report Issue No.:	E632CW-032906-R0
	Test Date(s):	13Sep05 - 27Nov05	Report Issue Date:	March 29, 2006
	Test Rule Part(s):	FCC 47 CFR §15.247	Industry Canada RSS-210 Issue 6	
	Lab Registration(s):	FCC Lab Reg. # 714830	Industry Canada Lab File # IC 3874	

H.7. TEST RESULTS

H.7.1. Mode a (upper) Peak Power Spectral Density

Channel	Channel Frequency MHz	PPSD		Maximum Limit dBm/3kHz	Pass/Fail
		6 mbps dBm/3kHz	54 mbps dBm/3kHz		
		149	5745		
157	5785	-18.931	-20.749	+8	PASS
165	5825	-19.153	-21.292	+8	PASS

H.7.2. Mode b Peak Power Spectral Density

Channel	Channel Frequency MHz	PPSD		Maximum Limit dBm/3kHz	Pass/Fail
		1 mbps dBm/3kHz	11 mbps dBm/3kHz		
		1	2412		
6	2437	-13.009	-12.135	+8	PASS
11	2462	-13.165	-12.712	+8	PASS

H.7.3. Mode g Peak Power Spectral Density

Channel	Channel Frequency MHz	PPSD		Maximum Limit dBm/3kHz	Pass/Fail
		6 mbps dBm/3kHz	54 mbps dBm/3kHz		
		1	2412		
6	2437	-15.376	-14.049	+8	PASS
11	2462	-15.145	-14.61	+8	PASS

Applicant:	Itronix Corporation	FCC ID:	KBCIX325-CWL	IC ID:	1943A-IX325ab	
Model(s):	IX325-CWL	IX325 Series Rugged Tablet PC with Cisco AIR-CB21AG-A-K9 802.11 abg WLAN				
2006 Celltech Labs Inc.		This document is not to be reproduced in whole or in part without the prior written permission of Celltech Labs Inc.				Page 75 of 83

	Test Report Serial No.:	040505KBC-F632-E15CW	Report Issue No.:	E632CW-032906-R0
	Test Date(s):	13Sep05 - 27Nov05	Report Issue Date:	March 29, 2006
	Test Rule Part(s):	FCC 47 CFR §15.247	Industry Canada RSS-210 Issue 6	
	Lab Registration(s):	FCC Lab Reg. # 714830	Industry Canada Lab File # IC 3874	

H.8. PASS/FAIL

In reference to the results outlined in H.5, the DUT passes the requirements as stated in the reference standards as follows:

FCC 15.247 (e): The peak power spectral density did not exceed +8 dBm in any 3 kHz band.

The highest peak power spectral density was measured for Mode b Channel 1 (11 mbps) with a value of -10.558 dBm/3kHz.

H.9. SIGN-OFF

I attest to the accuracy of the data. All measurements reported herein were performed by me and are correct to the best of my knowledge and belief. I assume full responsibility for the completeness of these measurements.



Duane M. Friesen, C.E.T.
EMC Manager
Celltech Labs Inc.

24Nov05

Date

Applicant:	Itronix Corporation	FCC ID:	KBCIX325-CWL	IC ID:	1943A-IX325ab	
Model(s):	IX325-CWL	IX325 Series Rugged Tablet PC with Cisco AIR-CB21AG-A-K9 802.11 abg WLAN				
2006 Celltech Labs Inc.		This document is not to be reproduced in whole or in part without the prior written permission of Celltech Labs Inc.				Page 76 of 83

	Test Report Serial No.:	040505KBC-F632-E15CW	Report Issue No.:	E632CW-032906-R0
	Test Date(s):	13Sep05 - 27Nov05	Report Issue Date:	March 29, 2006
	Test Rule Part(s):	FCC 47 CFR §15.247	Industry Canada RSS-210 Issue 6	
	Lab Registration(s):	FCC Lab Reg. # 714830	Industry Canada Lab File # IC 3874	

Appendix I - Conducted Powerline Emissions Measurement

I.1. REFERENCES	
Normative Reference Standard	CFR 47 FCC Part 15 §15.207 (a)
Procedure Reference	ANSI C63.4

I.2. LIMITS		
<p>§15.207(a): Compliance with the provisions of this paragraph shall be based on the measurement of the radio frequency voltage between each powerline and ground at the power terminal.</p>		
Frequency of Emission (MHz)	Conducted Limit (dBuV)	
	Quasi-Peak	Average
0.15 – 0.5	66 to 56*	56 to 46*
0.50 – 5.0	56	46
5.0 – 30.0	60	50

*Decreases logarithmically with frequency.

I.3. ENVIRONMENTAL CONDITIONS	
Temperature	25 ± 5 °C
Humidity	35 ± 5 %RH
Barometric Pressure	uncontrolled

I.4. EQUIPMENT LIST					
ASSET NUMBER	MANUFACTURER	MODEL	DESCRIPTION	LAST CAL	CAL DUE
00049	HP	85650A	Quasi-Peak Adapter	13Apr05	13Apr06
00047	HP	85685A	RF Preselector	13Apr05	13Apr06
00051	HP	8566B	Spectrum Analyzer RF Section	12Apr05	12Apr06
00083	EMCO	3825/2	Line Impedance Stabilization Network	26Apr05	26Apr06
00084	EMCO	3825/2	Line Impedance Stabilization Network	26Apr05	26Apr06

I.5. MEASUREMENT EQUIPMENT SETUP	
MEASUREMENT EQUIPMENT CONNECTIONS	The conducted emissions were measured on each of the two AC powerline leads connected to the DUT's power supply brick. A two line LISN was used to make this measurement. A drawing of the equipment setup is shown in I.7
MEASUREMENT EQUIPMENT SETTINGS	<p>Each of the monitor ports from the 2-line LISN was connected in turn to the spectrum analyzer. The port not connected to the analyzer was terminated in a 50-ohm load. A prescan of the peak emission levels was made of the 150 kHz – 30 MHz range split into 4 equal frequency bands. The following were the spectrum analyzer settings:</p> <p style="margin-left: 20px;">Start Frequency and Stop Frequency set by software for each of the four bands RBW: 100 kHz VBW: 300 kHz Sweep: 500 mS</p> <p>The resulting data from each band was corrected and collected by software and presented in the graphical representations shown in I.9 for the two leads. The frequency points with peak levels within 20 dB of the average limit were selected and optimized using software control each type of detector (peak, quasi-peak and average). This data was corrected by the software is presented in the tables shown in section I.9.</p>

Applicant:	Itronix Corporation	FCC ID:	KBCIX325-CWL	IC ID:	1943A-IX325ab	
Model(s):	IX325-CWL	IX325 Series Rugged Tablet PC with Cisco AIR-CB21AG-A-K9 802.11 abg WLAN				
2006 Celltech Labs Inc.		This document is not to be reproduced in whole or in part without the prior written permission of Celltech Labs Inc.				Page 77 of 83

I.6. SETUP DRAWING

Figure I.6-1 - Setup Drawing

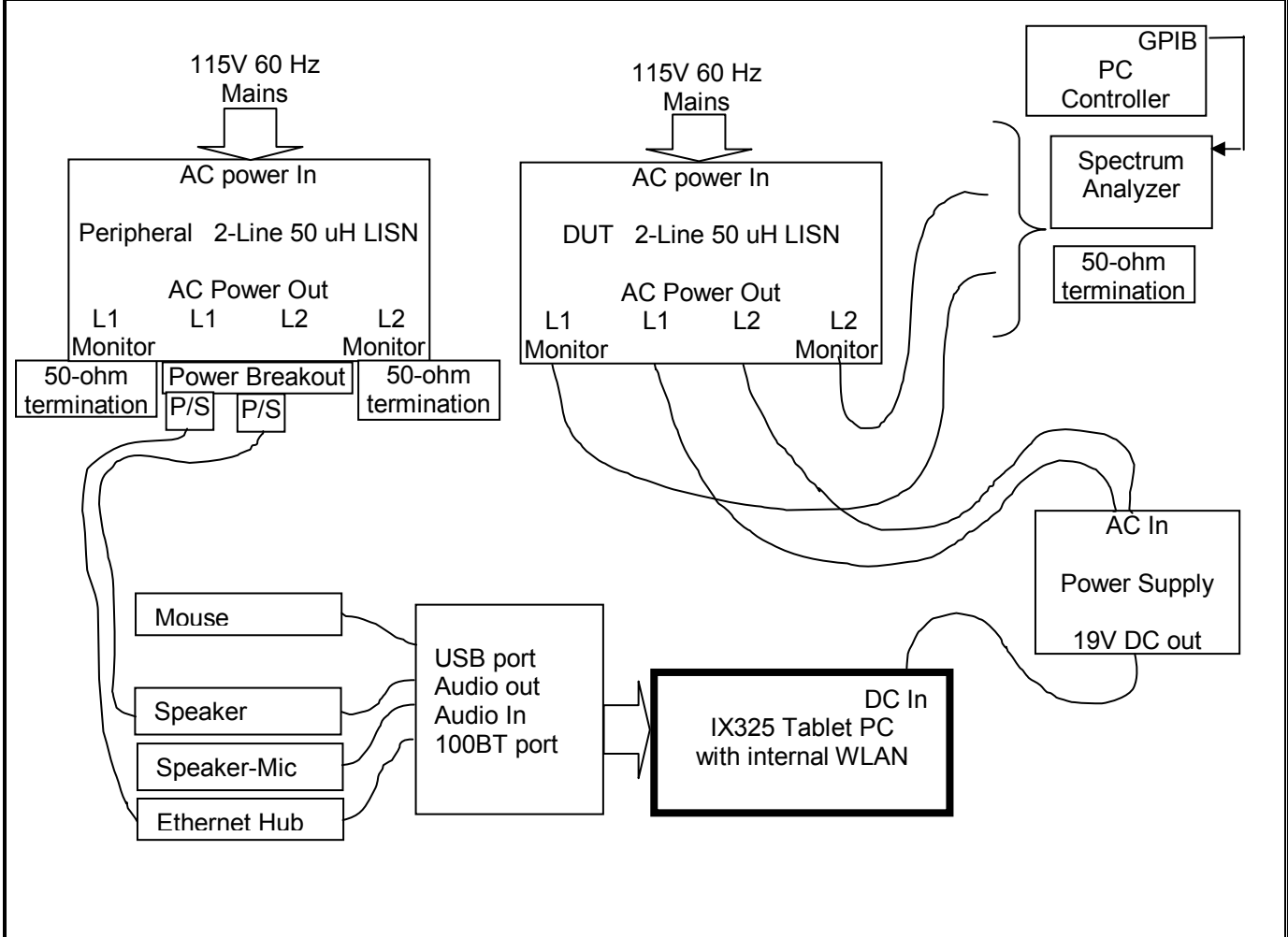

I.7. DUT OPERATING DESCRIPTION

WLAN:	Using the highest conducted power as a guide, the WLAN was set to transmit at full power on Channel 11, Mode b 11 Mb/s
PC:	Other than operating the WLAN software and running MS windows, no PC exercising was performed.
Peripherals:	All peripherals were active, but no specific traffic was initiated.

	Test Report Serial No.:	040505KBC-F632-E15CW	Report Issue No.:	E632CW-032906-R0
	Test Date(s):	13Sep05 - 27Nov05	Report Issue Date:	March 29, 2006
	Test Rule Part(s):	FCC 47 CFR §15.247	Industry Canada RSS-210 Issue 6	
	Lab Registration(s):	FCC Lab Reg. # 714830	Industry Canada Lab File # IC 3874	

I.8. SETUP PHOTOS

Photograph I-1 - AC Powerline Conducted Emission Cable Placement

Photograph I-2 - AC Powerline Conducted Emission Configuration

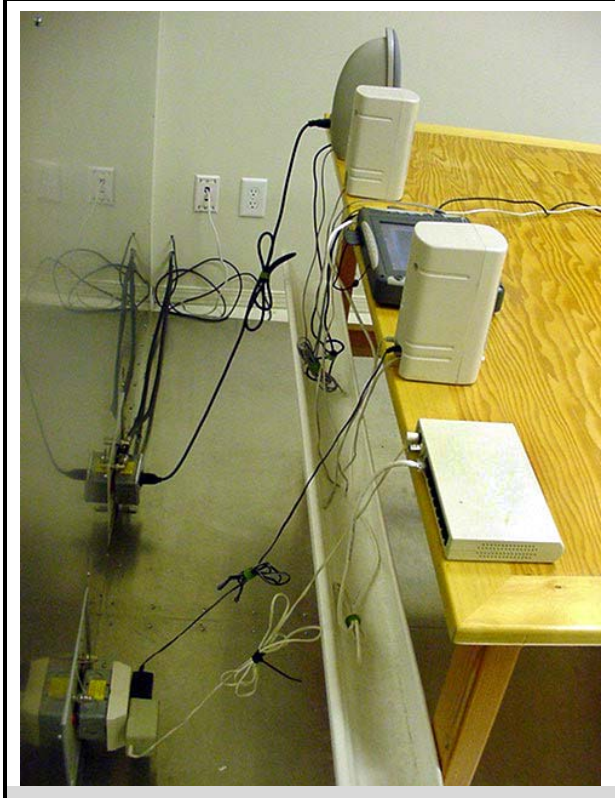

Applicant:	Itronix Corporation	FCC ID:	KBCIX325-CWL	IC ID:	1943A-IX325ab	
Model(s):	IX325-CWL	IX325 Series Rugged Tablet PC with Cisco AIR-CB21AG-A-K9 802.11 abg WLAN				
2006 Celltech Labs Inc.		This document is not to be reproduced in whole or in part without the prior written permission of Celltech Labs Inc.				Page 79 of 83



Test Report Serial No.:	040505KBC-F632-E15CW	Report Issue No.:	E632CW-032906-R0
Test Date(s):	13Sep05 - 27Nov05	Report Issue Date:	March 29, 2006
Test Rule Part(s):	FCC 47 CFR §15.247	Industry Canada RSS-210 Issue 6	
Lab Registration(s):	FCC Lab Reg. # 714830	Industry Canada Lab File # IC 3874	

I.9. TEST RESULTS

I.9.1. Line 1 Conducted Emissions

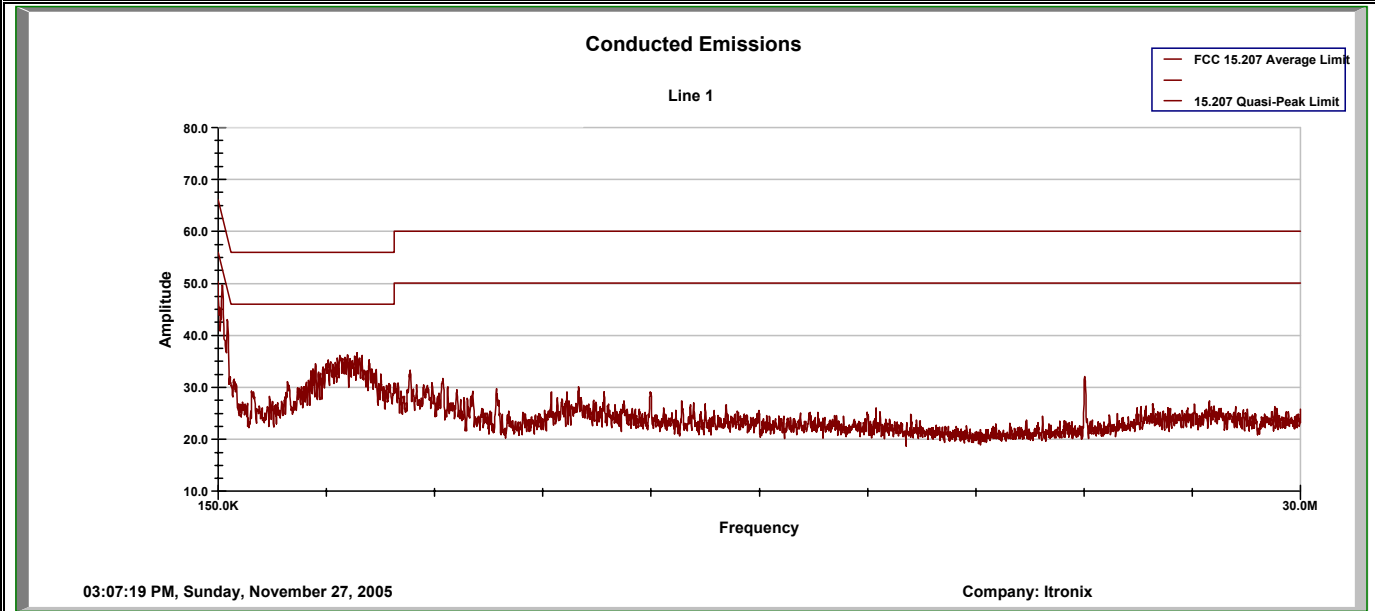

Project Number: 632
Company: Itronix
Product: IX325 with Cisco abg WLAN

Standard: FCC 15.207
Test Start Date: 27-Nov-05
Test End Date: 27-Nov-05

Line 1 Conducted Emissions

Frequency MHz	Uncorrected Reading			Correction Factor dB	Corrected Emission Level			Quasi-Peak Limit dBuV	Quasi-Peak Margin dB	Average Limit dBuV	Average Margin dB	Pass/Fail
	Peak dBuV	Quasi-Peak dBuV	Average dBuV		Peak dBuV	Quasi-Peak dBuV	Average dBuV					
0.150	65.90	56.94	27.86	-2.14	63.76	54.80	11.20	66.00	11.20	56.00	44.80	Pass
0.157	64.90	55.94	27.28	-2.01	62.89	53.93	25.27	65.59	11.67	55.59	30.33	Pass
0.166	64.40	55.12	25.73	-1.87	62.53	53.25	23.87	65.16	11.91	55.16	31.29	Pass
0.189	60.50	51.03	21.77	-1.55	58.95	49.48	20.23	64.09	14.61	54.09	33.87	Pass
0.247	54.80	44.76	19.89	-1.07	53.73	43.69	18.82	61.84	18.15	51.84	33.02	Pass
0.254	54.50	44.63	18.47	-1.03	53.47	43.60	17.44	61.62	18.01	51.62	34.18	Pass
0.262	53.60	44.10	20.07	-0.98	52.62	43.12	19.09	61.36	18.24	51.36	32.27	Pass
0.269	52.90	43.73	29.52	-0.95	51.95	42.78	28.57	61.14	18.36	51.14	22.57	Pass
0.279	52.70	42.19	15.93	-0.90	51.80	41.29	15.03	60.84	19.55	50.84	35.81	Pass
0.285	51.90	42.23	15.62	-0.88	51.02	41.35	14.73	60.67	19.32	50.67	35.94	Pass
0.403	46.20	38.25	35.36	-0.58	45.62	37.67	34.78	57.79	20.12	47.79	13.01	Pass
3.952	41.90	40.01	37.76	-0.30	41.60	39.71	37.46	56.00	16.29	46.00	8.54	Pass

Calculations

CF = Correction Factor
Emission Level = Measured Level + correction factor
Margin = Limit - Emission Level

Applicant:	Itronix Corporation	FCC ID:	KBCIX325-CWL	IC ID:	1943A-IX325ab	ITRONIX A GENERAL DYNAMICS COMPANY
Model(s):	IX325-CWL	IX325 Series Rugged Tablet PC with Cisco AIR-CB21AG-A-K9 802.11 abg WLAN				
2006 Celltech Labs Inc.		This document is not to be reproduced in whole or in part without the prior written permission of Celltech Labs Inc.				Page 80 of 83



Test Report Serial No.:	040505KBC-F632-E15CW	Report Issue No.:	E632CW-032906-R0
Test Date(s):	13Sep05 - 27Nov05	Report Issue Date:	March 29, 2006
Test Rule Part(s):	FCC 47 CFR §15.247	Industry Canada RSS-210 Issue 6	
Lab Registration(s):	FCC Lab Reg. # 714830	Industry Canada Lab File # IC 3874	

I.9.2. Line 2 Conducted Emissions

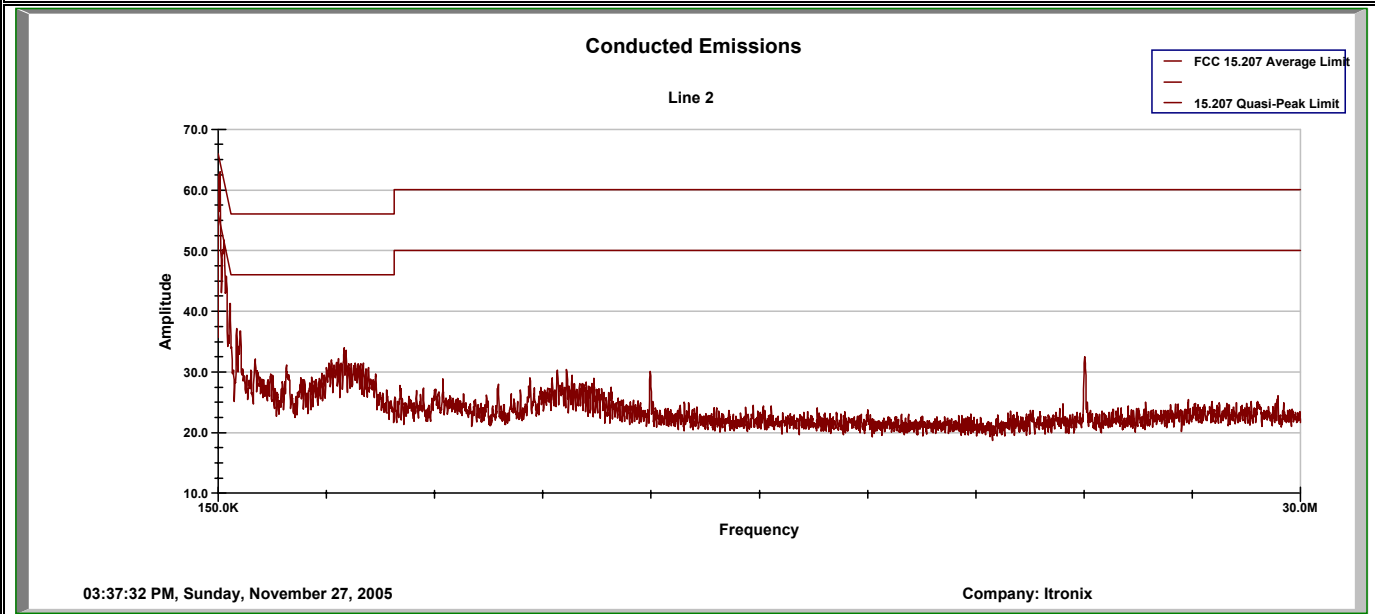

Project Number:	632.00	Standard:	FCC 15.207
Company:	Itronix	Test Start Date:	27-Nov-05
Product:	IX325 with Cisco abg WLAN	Test End Date:	27-Nov-05

Line 2 Conducted Emissions

Frequency MHz	Uncorrected Reading			Correction Factor dB	Corrected Emission Level			Quasi-Peak Limit dBuV	Quasi-Peak Margin dB	Average Limit dBuV	Average Margin dB	Pass/Fail
	Peak dBuV	Quasi-Peak dBuV	Average dBuV		Peak dBuV	Quasi-Peak dBuV	Average dBuV					
0.157	66.60	56.20	27.50	-2.03	64.57	54.17	11.44	65.61	11.44	55.61	44.17	Pass
0.164	65.10	55.16	26.33	-1.90	63.20	53.26	24.43	65.24	11.99	55.24	30.81	Pass
0.172	63.10	54.70	23.72	-1.78	61.32	52.92	21.94	64.86	11.94	54.86	32.92	Pass
0.182	62.30	52.73	23.20	-1.65	60.65	51.08	21.54	64.41	13.33	54.41	32.87	Pass
0.187	62.00	52.35	23.02	-1.58	60.42	50.77	21.44	64.16	13.39	54.16	32.72	Pass
0.194	60.60	51.26	21.38	-1.50	59.10	49.76	19.88	63.86	14.11	53.86	33.99	Pass
0.204	60.80	50.26	27.37	-1.40	59.40	48.86	25.98	63.45	14.58	53.45	27.47	Pass
0.210	59.10	50.50	19.30	-1.35	57.75	49.15	17.95	63.22	14.07	53.22	35.27	Pass
0.304	51.10	41.33	9.10	-0.81	50.29	40.52	8.29	60.14	19.63	50.14	41.85	Pass
0.314	51.10	41.26	8.73	-0.77	50.33	40.49	7.95	59.87	19.38	49.87	41.92	Pass
3.627	39.50	36.57	34.47	-0.30	39.20	36.27	34.18	56.00	19.73	46.00	11.83	Pass

Calculations

CF = Correction Factor
Emission Level = Measured Level + correction factor
Margin = Limit - Emission Level

Applicant:	Itronix Corporation	FCC ID:	KBCIX325-CWL	IC ID:	1943A-IX325ab	ITRONIX A GENERAL DYNAMICS COMPANY
Model(s):	IX325-CWL	IX325 Series Rugged Tablet PC with Cisco AIR-CB21AG-A-K9 802.11 abg WLAN				
2006 Celltech Labs Inc.		This document is not to be reproduced in whole or in part without the prior written permission of Celltech Labs Inc.				Page 81 of 83

	Test Report Serial No.:	040505KBC-F632-E15CW	Report Issue No.:	E632CW-032906-R0
	Test Date(s):	13Sep05 - 27Nov05	Report Issue Date:	March 29, 2006
	Test Rule Part(s):	FCC 47 CFR §15.247	Industry Canada RSS-210 Issue 6	
	Lab Registration(s):	FCC Lab Reg. # 714830	Industry Canada Lab File # IC 3874	

I.10. PASS/FAIL

In reference to the results outlined in I.9 the DUT passes the requirements as stated in the reference standards as follows:

The RF voltage measured in reference to ground on each of the power line conductors must not exceed the limits as outline in FCC 15.207 (a).

The emission measured on Line 1 with the least margin to the limit measured with an AV detector at 3.952 MHz and a margin of 8.54 dB. The emission measured on Line 2 with the least margin to the limit was measured with a QP detector at 157 kHz with a margin of 11.44 dB.

I.11. SIGN-OFF

I attest to the accuracy of the data. All measurements reported herein were performed by me and are correct to the best of my knowledge and belief. I assume full responsibility for the completeness of these measurements.



Duane M. Friesen, C.E.T.
EMC Manager
Celltech Labs Inc

27Nov05

Date

Applicant:	Itronix Corporation	FCC ID:	KBCIX325-CWL	IC ID:	1943A-IX325ab	
Model(s):	IX325-CWL	IX325 Series Rugged Tablet PC with Cisco AIR-CB21AG-A-K9 802.11 abg WLAN				
2006 Celltech Labs Inc.		This document is not to be reproduced in whole or in part without the prior written permission of Celltech Labs Inc.				Page 82 of 83

	Test Report Serial No.:	040505KBC-F632-E15CW	Report Issue No.:	E632CW-032906-R0
	Test Date(s):	13Sep05 - 27Nov05	Report Issue Date:	March 29, 2006
	Test Rule Part(s):	FCC 47 CFR §15.247	Industry Canada RSS-210 Issue 6	
	Lab Registration(s):	FCC Lab Reg. # 714830	Industry Canada Lab File # IC 3874	

END OF DOCUMENT

Applicant:	Itronix Corporation	FCC ID:	KBCIX325-CWL	IC ID:	1943A-IX325ab	
Model(s):	IX325-CWL	IX325 Series Rugged Tablet PC with Cisco AIR-CB21AG-A-K9 802.11 abg WLAN				
2006 Celltech Labs Inc.		This document is not to be reproduced in whole or in part without the prior written permission of Celltech Labs Inc.				Page 83 of 83