

	Test Report Serial No.:	040505KBC-T627-S24G		Report Issue Date:	Nov. 01, 2005
	Dates of Evaluation:	April 13-14, May 03 & 09, 2005		Report Rev. No.:	Revision 0
	Type of Evaluation:	RF Exposure	SAR	FCC §2.1093	IC RSS-102

APPENDIX E - SYSTEM VALIDATION

Applicant:	Itronix Corporation	FCC ID:	KBCIX325-AC775BT	IC ID:	1943A-IX325e	Model:	IX325-AC775BT
IX325 Rugged Tablet PC with PCS/Cellular GSM GPRS/EDGE PCMCIA Modem and co-located Bluetooth							
2005 Celltech Labs Inc.	This document is not to be reproduced in whole or in part without the prior written permission of Celltech Labs Inc.					Page 58 of 61	

835 MHz SYSTEM VALIDATION DIPOLE

Type:

835 MHz Validation Dipole

Serial Number:

411

Place of Calibration:

Celltech Labs Inc.

Date of Calibration:

March 30, 2005

Celltech Labs Inc. hereby certifies that this device has been calibrated on the date indicated above.

Calibrated by:



Approved by:



1. Validation Dipole Construction & Electrical Characteristics

The validation dipole was constructed in accordance with the IEEE Standard “Annex G (informative) Reference dipoles for use in system validation”. The electrical properties were measured using an HP 8753ET Network Analyzer. The network analyzer was calibrated to the validation dipole N-type connector feed point using an HP85032E Type N calibration kit. The dipole was placed parallel to a planar phantom at a separation distance of 15.0mm from the simulating fluid using a loss-less dielectric spacer. The measured input impedance is:

Feed point impedance at 835MHz	$Re\{Z\} = 47.627\Omega$ $Im\{Z\} = -0.67188\Omega$
Return Loss at 835MHz	-31.954dB

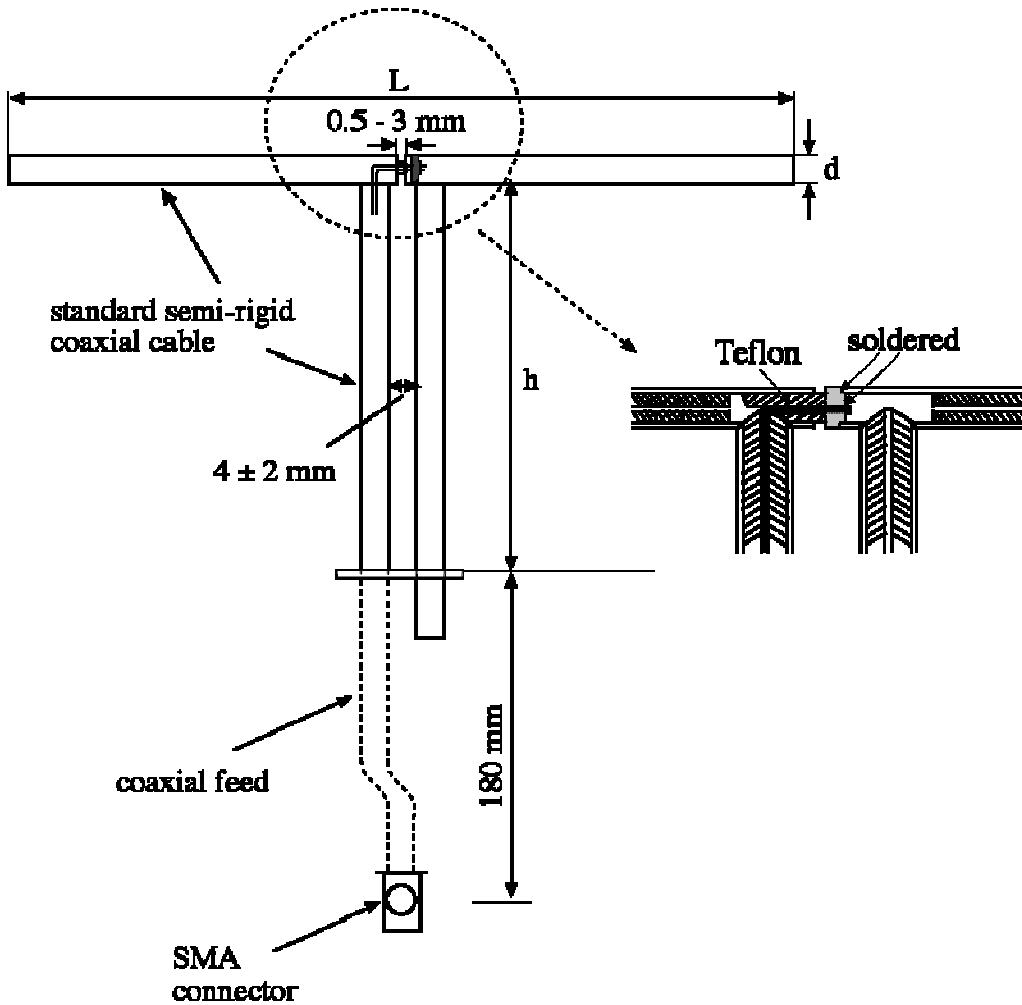

2. Validation Dipole VSWR Data

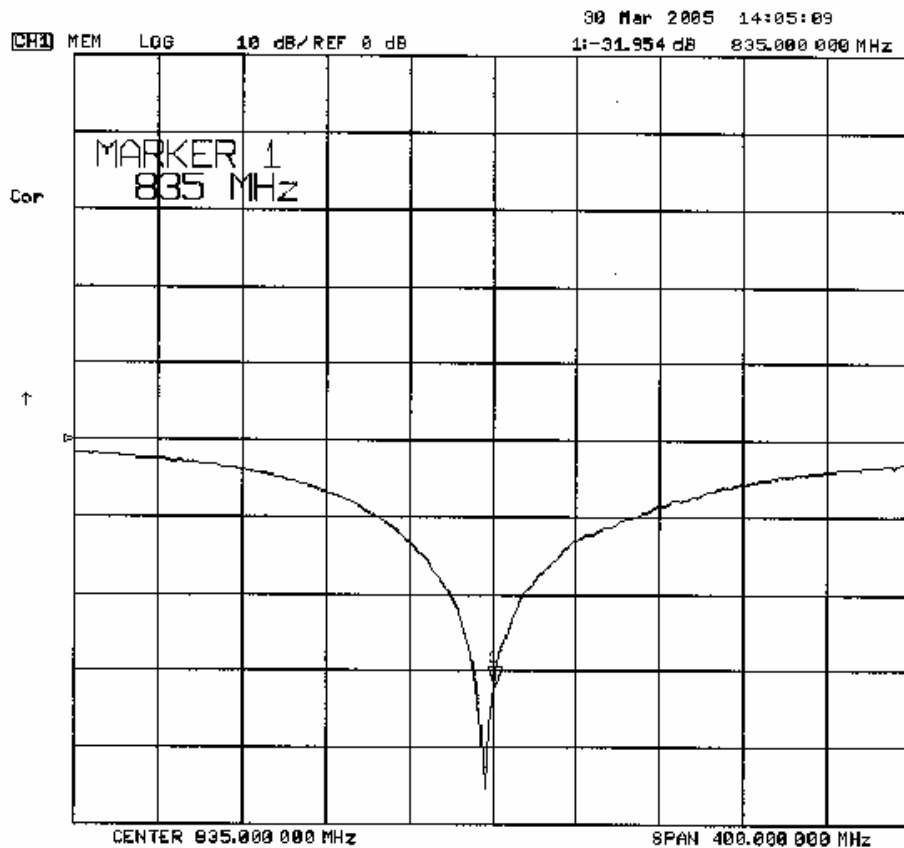
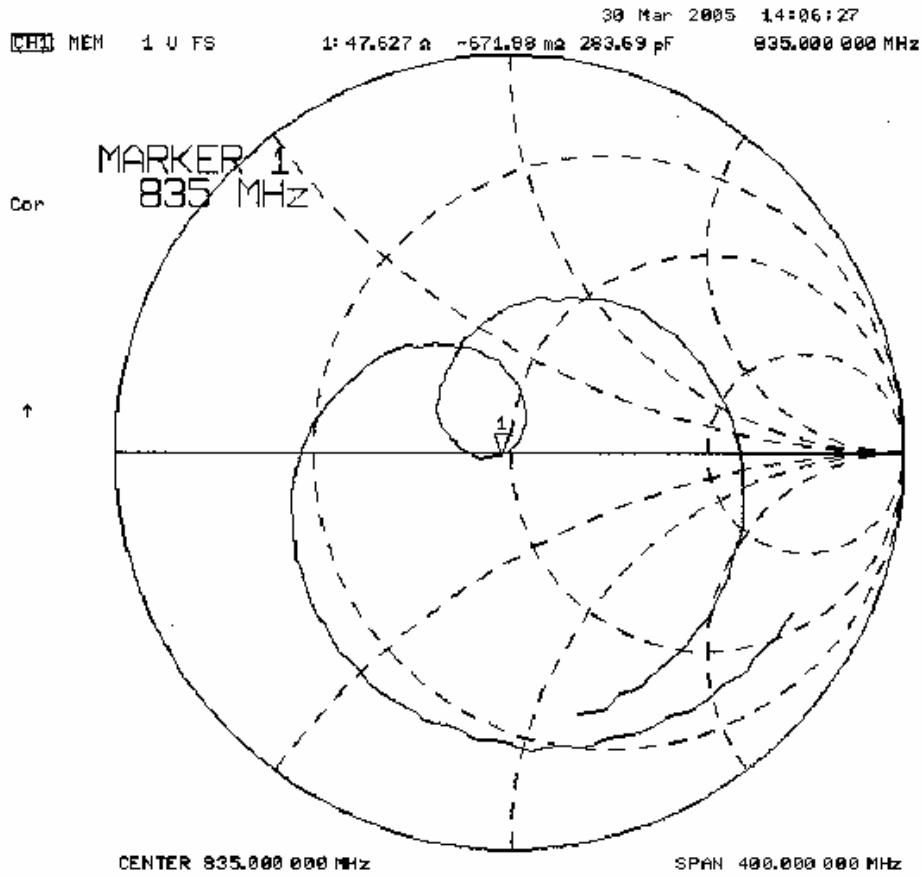

3. Validation Dipole Dimensions

Frequency (MHz)	L (mm)	h (mm)	d (mm)
300	420.0	250.0	6.2
450	288.0	167.0	6.2
835	161.0	89.8	3.6
900	149.0	83.3	3.6
1450	89.1	51.7	3.6
1800	72.0	41.7	3.6
1900	68.0	39.5	3.6
2000	64.5	37.5	3.6
2450	51.8	30.6	3.6
3000	41.5	25.0	3.6

4. Validation Phantom

The validation phantom is the SAM (Specific Anthropomorphic Mannequin) phantom manufactured by Schmid & Partner Engineering AG. The SAM phantom is a Fiberglass shell integrated in a wooden table. The shape of the shell corresponds to the phantom defined by SCC34-SC2. It enables the dosimetric evaluation of left and right hand phone usage as well as body mounted usage at the flat phantom region. A cover prevents evaporation of the liquid. Reference markings on the phantom allow the complete setup of all predefined phantom positions and measurement grids by manually teaching three points in the robot.

Shell Thickness: 2.0 ± 0.1 mm
Filling Volume: Approx. 25 liters
Dimensions: 50 cm (W) x 100 cm (L)

5. 835 MHz System Validation Setup



6. 835 MHz Validation Dipole Setup



7. Measurement Conditions

The SAM phantom was filled with 835 MHz simulated brain tissue mixture having the following parameters:

Relative Permittivity: 39.5
 Conductivity: 0.90 mho/m
 Fluid Temperature: 20.4 °C
 Fluid Depth: ≥ 15.0 cm

Environmental Conditions:
 Ambient Temperature: 20.5 °C
 Barometric Pressure: 102.2 kPa
 Humidity: 32 %

Measurements were made at the planar section of the SAM phantom using a dosimetric E-field probe ET3DV5 (S/N: 1590, conversion factor 6.71).

The 835 MHz simulated brain tissue mixture consisted of the following ingredients:

Ingredient	Percentage by weight
Water	40.71%
Sugar	56.63%
Salt	1.48%
HEC	0.99%
Dowicil 75	0.19%
Target Dielectric Parameters at 22 °C	$\epsilon_r = 41.5$ $\sigma = 0.90 \text{ S/m}$

8. SAR Measurement

The SAR measurement was performed with the E-field probe in mechanical detection mode only. The setup and determination of the forward power into the dipole was performed using the following procedures.

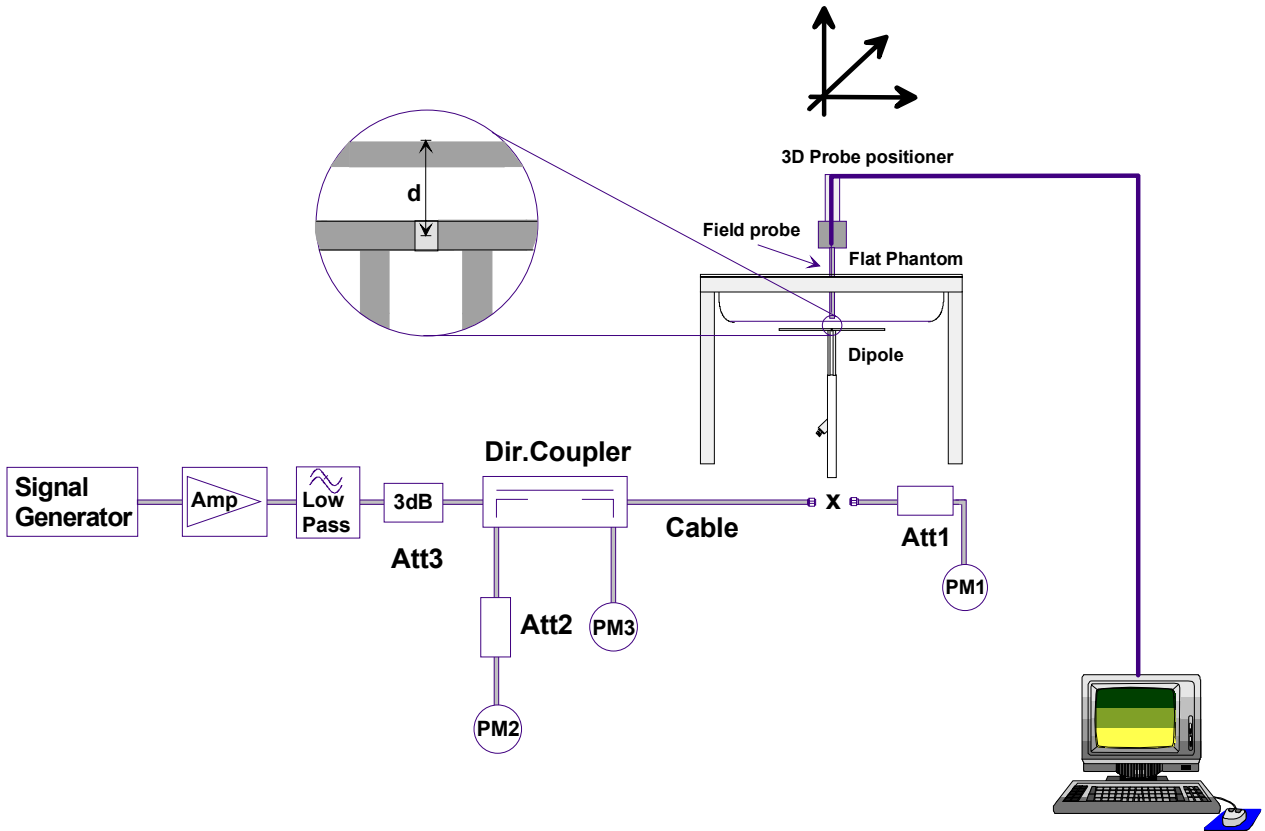

First the power meter PM1 (including attenuator Att1) is connected to the cable to measure the forward power at the location of the dipole connector (X). The signal generator is adjusted for the desired forward power at the dipole connector (taking into account the attenuation of Att1) as read by power meter PM2. After connecting the cable to the dipole, the signal generator is readjusted for the same reading at power meter PM2. If the signal generator does not allow adjustment in 0.01dB steps, the remaining difference at PM2 must be taken into consideration. PM3 records the reflected power from the dipole to ensure that the value is not changed from the previous value. The reflected power should be 20dB below the forward power.

9. Validation Dipole SAR Test Results

Ten SAR measurements were performed in order to achieve repeatability and to establish an average target value.

Validation Measurement	SAR @ 0.25W Input averaged over 1g	SAR @ 1W Input averaged over 1g	SAR @ 0.25W Input averaged over 10g	SAR @ 1W Input averaged over 10g	Peak SAR @ 0.25W Input
Test 1	2.45	9.80	1.60	6.40	3.65
Test 2	2.44	9.76	1.59	6.36	3.66
Test 3	2.45	9.80	1.60	6.40	3.67
Test 4	2.44	9.76	1.59	6.36	3.64
Test 5	2.44	9.76	1.59	6.36	3.62
Test 6	2.43	9.72	1.59	6.36	3.61
Test 7	2.45	9.80	1.60	6.40	3.65
Test 8	2.43	9.72	1.59	6.36	3.62
Test 9	2.43	9.72	1.59	6.36	3.61
Test10	2.45	9.80	1.60	6.40	3.65
Average SAR	2.44	9.76	1.59	6.38	3.64

IEEE Target SAR @ 1 Watt Input averaged over 1 gram (W/kg)		Measured SAR @ 1 Watt Input averaged over 1 gram (W/kg)	Deviation from Target (%)	IEEE Target SAR @ 1 Watt Input averaged over 10 grams (W/kg)		Measured SAR @ 1 Watt Input averaged over 10 grams (W/kg)	Deviation from Target (%)
9.5	+/- 10%	9.76	+ 2.7	6.2	+/- 10%	6.38	+ 2.9

835 MHz System Validation (Brain) - March 30, 2005

DUT: Dipole 835 MHz; Type: D835V2; Serial: 411
Ambient Temp: 20.5°C; Fluid Temp: 20.4°C; Barometric Pressure: 102.2 kPa; Humidity: 32%
Communication System: CW
Frequency: 835 MHz; Duty Cycle: 1:1
Medium: HSL835 Medium parameters used: $f = 835$ MHz; $\sigma = 0.90$ mho/m; $\epsilon_r = 39.5$; $\rho = 1000$ kg/m³
- Probe: ET3DV6 - SN1590; ConvF(6.71, 6.71, 6.71); Calibrated: 24/05/2004
- Sensor-Surface: 4mm (Mechanical And Optical Surface Detection)
- Electronics: DAE3 Sn370; Calibrated: 25/01/2005
- Phantom: SAM 4.0; Type: Fiberglass; Serial: 1033
- Measurement SW: DASY4, V4.5 Build 19; Postprocessing SW: SEMCAD, V1.8 Build 146

835 MHz System Validation/Area Scan (6x10x1): Measurement grid: dx=10mm, dy=10mm
Reference Value = 56.5 V/m; Power Drift = -0.031 dB

835 MHz System Validation/Zoom Scan (7x7x7)/Cube 0: Measurement grid: dx=5mm, dy=5mm, dz=5mm
Reference Value = 56.5 V/m; Power Drift = -0.031 dB
Peak SAR (extrapolated) = 3.65 W/kg
SAR(1 g) = 2.45 mW/g; SAR(10 g) = 1.6 mW/g

835 MHz System Validation/Zoom Scan 2 (7x7x7)/Cube 0: Measurement grid: dx=5mm, dy=5mm, dz=5mm
Reference Value = 56.1 V/m; Power Drift = -0.00 dB
Peak SAR (extrapolated) = 3.66 W/kg
SAR(1 g) = 2.44 mW/g; SAR(10 g) = 1.59 mW/g

835 MHz System Validation/Zoom Scan 3 (7x7x7)/Cube 0: Measurement grid: dx=5mm, dy=5mm, dz=5mm
Reference Value = 55.9 V/m; Power Drift = -0.013 dB
Peak SAR (extrapolated) = 3.67 W/kg
SAR(1 g) = 2.45 mW/g; SAR(10 g) = 1.6 mW/g

835 MHz System Validation/Zoom Scan 4 (7x7x7)/Cube 0: Measurement grid: dx=5mm, dy=5mm, dz=5mm
Reference Value = 55.9 V/m; Power Drift = 0.00 dB
Peak SAR (extrapolated) = 3.64 W/kg
SAR(1 g) = 2.44 mW/g; SAR(10 g) = 1.59 mW/g

835 MHz System Validation/Zoom Scan 5 (7x7x7)/Cube 0: Measurement grid: dx=5mm, dy=5mm, dz=5mm
Reference Value = 56.0 V/m; Power Drift = -0.017 dB
Peak SAR (extrapolated) = 3.62 W/kg
SAR(1 g) = 2.44 mW/g; SAR(10 g) = 1.59 mW/g

835 MHz System Validation/Zoom Scan 6 (7x7x7)/Cube 0: Measurement grid: dx=5mm, dy=5mm, dz=5mm
Reference Value = 55.8 V/m; Power Drift = -0.01 dB
Peak SAR (extrapolated) = 3.61 W/kg
SAR(1 g) = 2.43 mW/g; SAR(10 g) = 1.59 mW/g

835 MHz System Validation/Zoom Scan 7 (7x7x7)/Cube 0: Measurement grid: dx=5mm, dy=5mm, dz=5mm
Reference Value = 56.2 V/m; Power Drift = 0.00 dB
Peak SAR (extrapolated) = 3.65 W/kg
SAR(1 g) = 2.45 mW/g; SAR(10 g) = 1.6 mW/g

835 MHz System Validation/Zoom Scan 8 (7x7x7)/Cube 0: Measurement grid: dx=5mm, dy=5mm, dz=5mm
Reference Value = 56.2 V/m; Power Drift = 0.00 dB
Peak SAR (extrapolated) = 3.62 W/kg
SAR(1 g) = 2.43 mW/g; SAR(10 g) = 1.59 mW/g

835 MHz System Validation/Zoom Scan 9 (7x7x7)/Cube 0: Measurement grid: dx=5mm, dy=5mm, dz=5mm
Reference Value = 55.8 V/m; Power Drift = -0.00 dB
Peak SAR (extrapolated) = 3.61 W/kg
SAR(1 g) = 2.43 mW/g; SAR(10 g) = 1.59 mW/g

835 MHz System Validation/Zoom Scan 10 (7x7x7)/Cube 0: Measurement grid: dx=5mm, dy=5mm, dz=5mm
Reference Value = 56.2 V/m; Power Drift = -0.00 dB
Peak SAR (extrapolated) = 3.65 W/kg
SAR(1 g) = 2.45 mW/g; SAR(10 g) = 1.6 mW/g

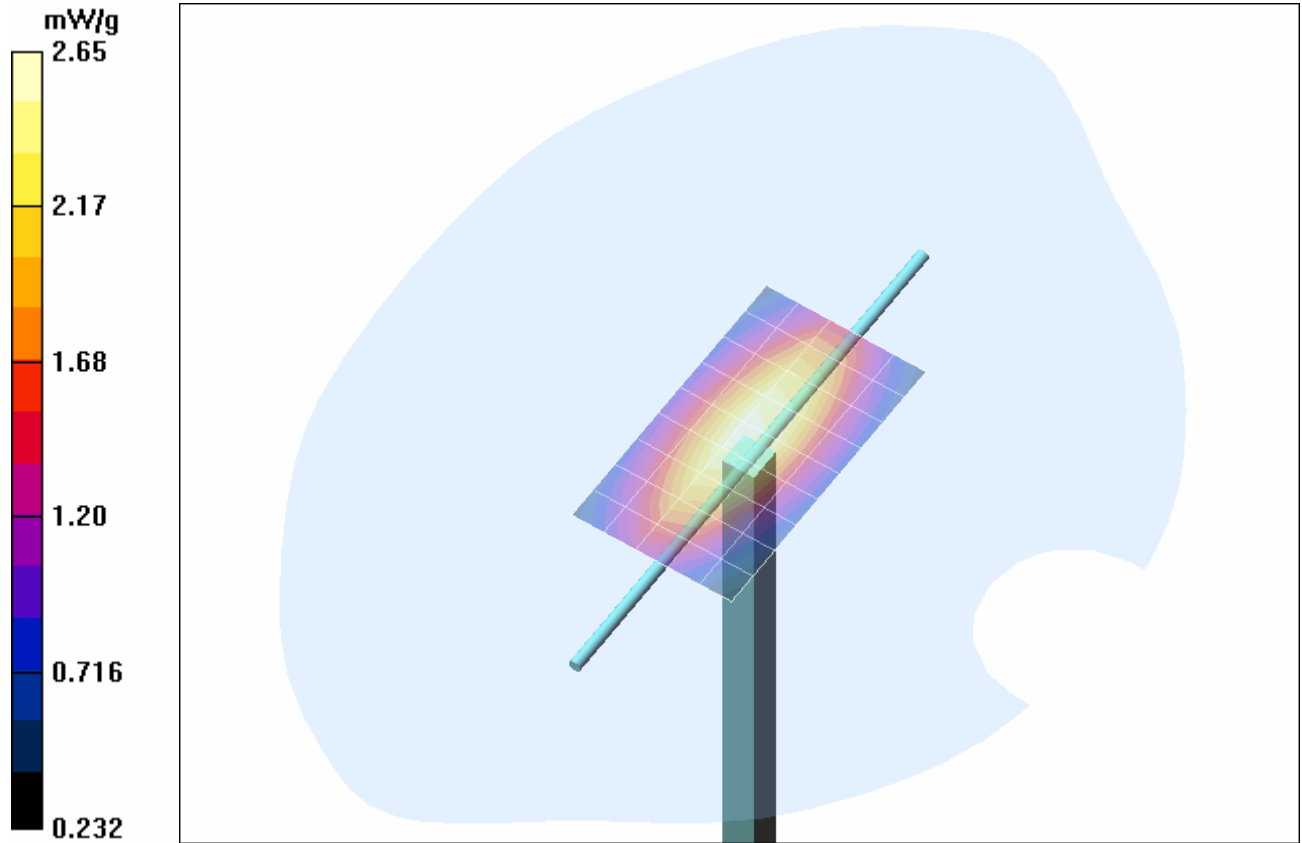

1 g average of 10 measurements: 2.44 mW/g
 10 g average of 10 measurements: 1.59 mW/g

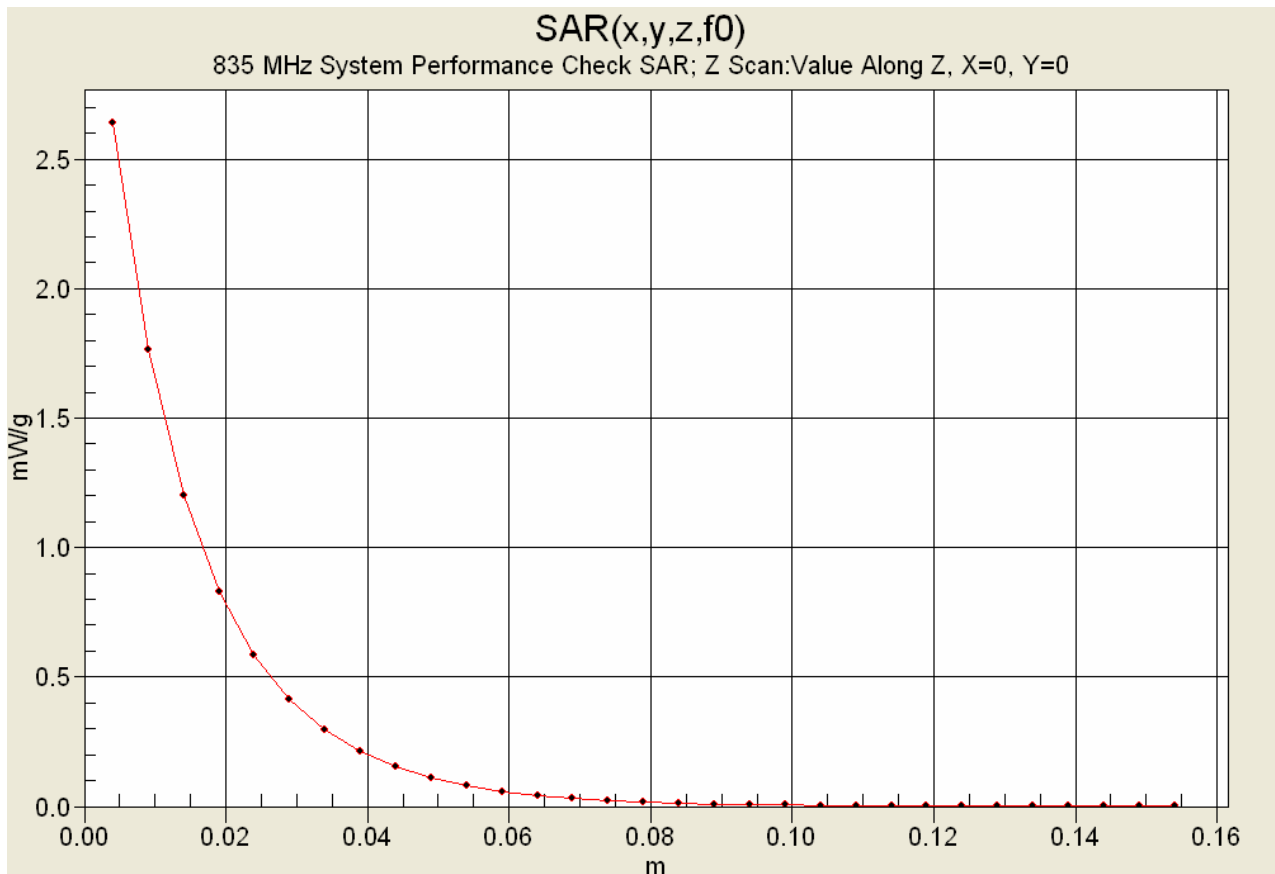

10. Measured Fluid Dielectric Parameters

System Validation - 835 MHz Dipole

Measured Fluid Dielectric Parameters (Brain)

March 30, 2005

Frequency	e'	e''
735.000000 MHz	40.7992	19.7090
745.000000 MHz	40.6764	19.6562
755.000000 MHz	40.5150	19.6147
765.000000 MHz	40.3469	19.5936
775.000000 MHz	40.2286	19.5727
785.000000 MHz	40.1120	19.5413
795.000000 MHz	39.9862	19.4590
805.000000 MHz	39.8373	19.4821
815.000000 MHz	39.7113	19.4303
825.000000 MHz	39.5956	19.3828
835.000000 MHz	39.4525	19.3180
845.000000 MHz	39.3521	19.3009
855.000000 MHz	39.2084	19.3013
865.000000 MHz	39.0910	19.2701
875.000000 MHz	38.9606	19.2337
885.000000 MHz	38.8205	19.2213
895.000000 MHz	38.7043	19.1737
905.000000 MHz	38.6586	19.1569
915.000000 MHz	38.4783	19.1542
925.000000 MHz	38.3777	19.0771
935.000000 MHz	38.2585	19.0264

1900 MHz SYSTEM VALIDATION DIPOLE

Type:

1900 MHz Validation Dipole

Serial Number:

151

Place of Calibration:

Celltech Labs Inc.

Date of Calibration:

June 18, 2004

Celltech Labs Inc. hereby certifies that this device has been calibrated on the date indicated above.

Calibrated by:

Spencer Watson

Approved by:

Russell W. Pipe

18 Jun 2004 09:26:48

CH1 S11 1 U FS

1: 50.115 Ω 6.2070 Ω 519.94 μH

1 900.000 000 MHz

γ

PRm

Cor

\uparrow

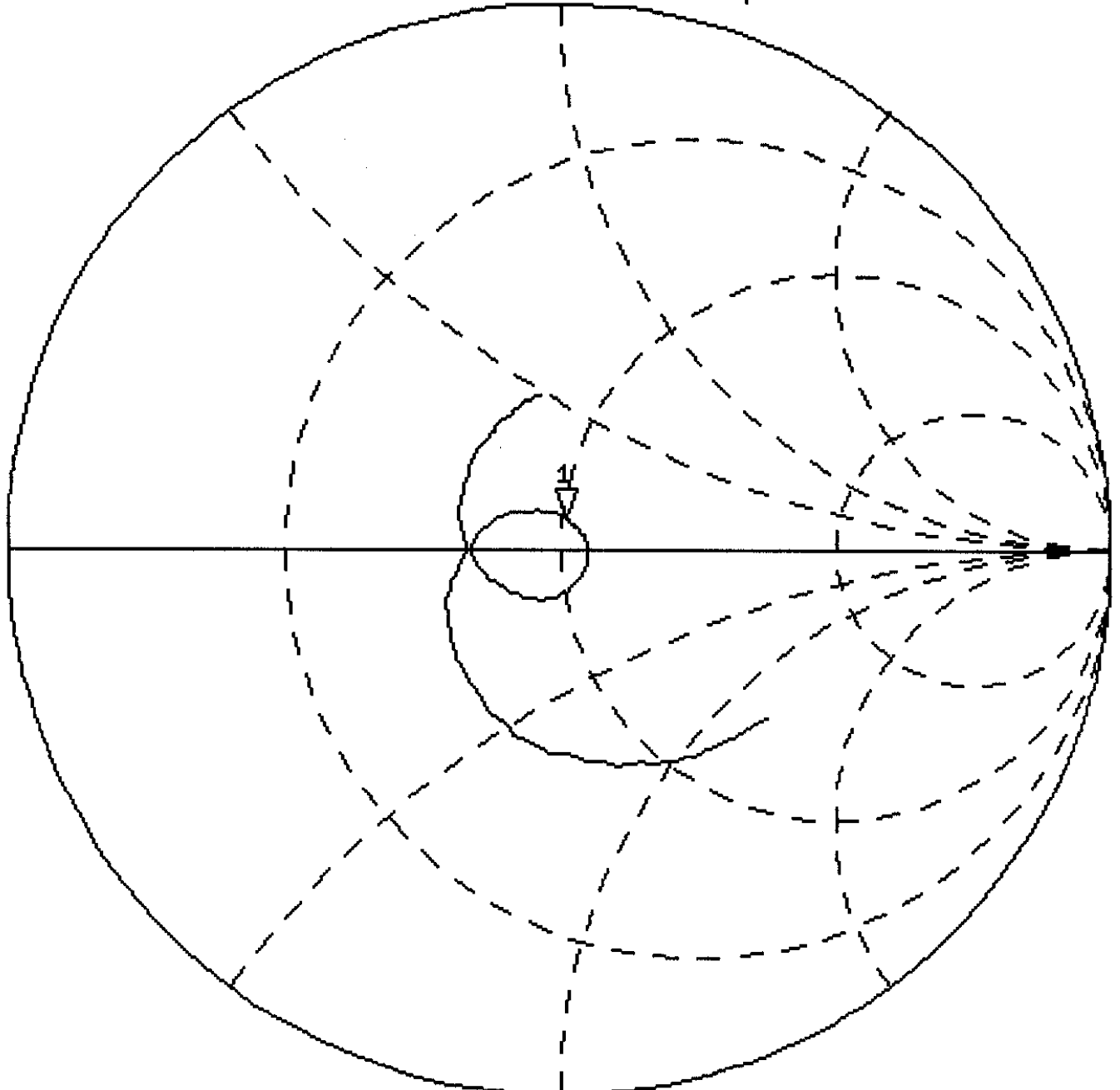

START 1 700.000 000 MHz

STOP 2 100.000 000 MHz

18 Jun 2004 09:25:56

[CH1] S11 LOG 10 dB/REF 0 dB 1:-24.205 dB 1 900.000 000 MHz

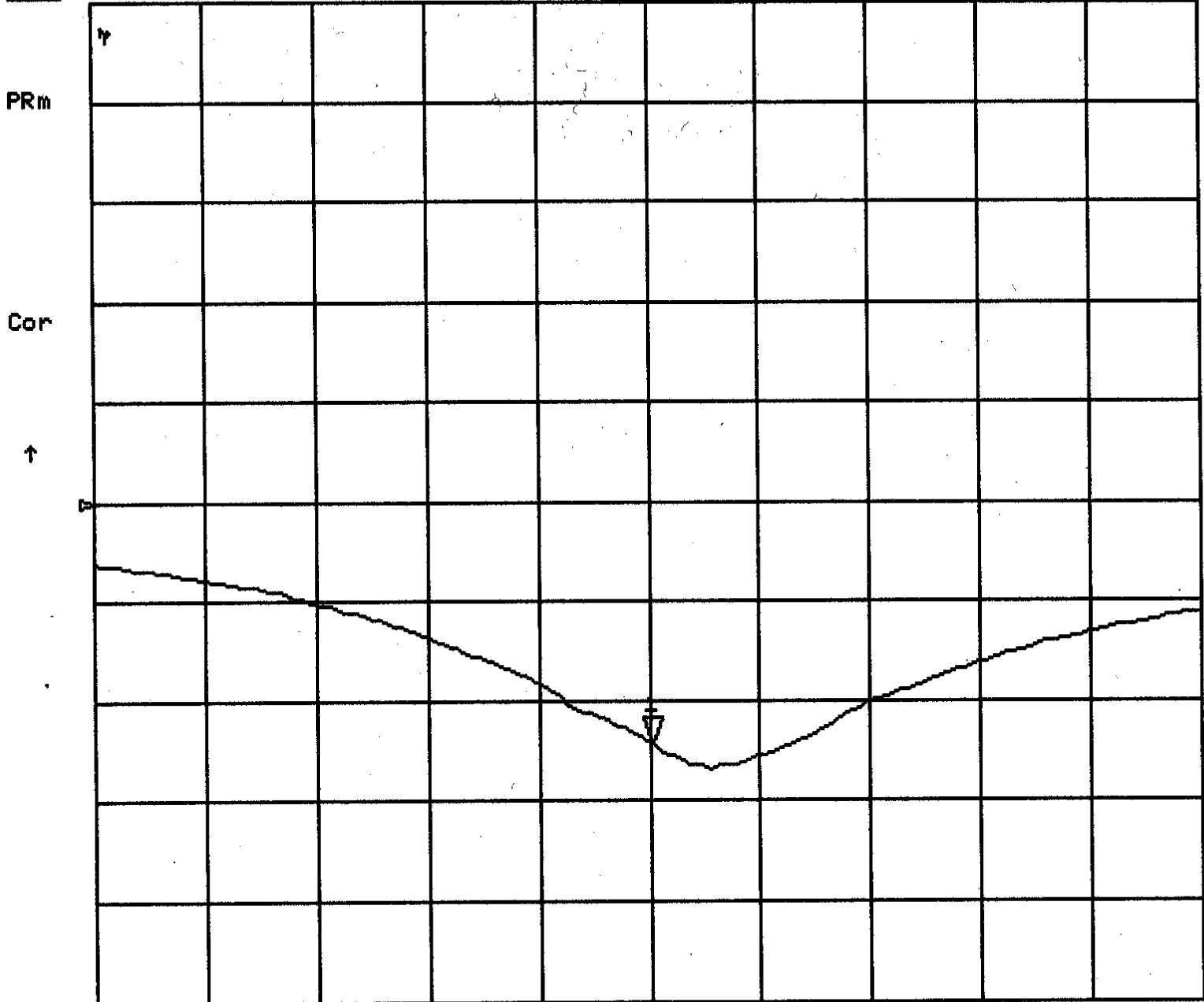

START 1 700.000 000 MHz

STOP 2 100.000 000 MHz

Validation Dipole Dimensions

Frequency (MHz)	L (mm)	h (mm)	d (mm)
300	420.0	250.0	6.2
450	288.0	167.0	6.2
835	161.0	89.8	3.6
900	149.0	83.3	3.6
1450	89.1	51.7	3.6
1800	72.0	41.7	3.6
1900	68.0	39.5	3.6
2000	64.5	37.5	3.6
2450	51.8	30.6	3.6
3000	41.5	25.0	3.6

2. Validation Phantom

The validation phantom is the SAM (Specific Anthropomorphic Mannequin) phantom manufactured by Schmid & Partner Engineering AG. The SAM phantom is a Fiberglass shell integrated in a wooden table. The shape of the shell corresponds to the phantom defined by SCC34-SC2. It enables the dosimetric evaluation of left and right hand phone usage as well as body mounted usage at the flat phantom region. A cover prevents evaporation of the liquid. Reference markings on the phantom allow the complete setup of all predefined phantom positions and measurement grids by manually teaching three points in the robot.

Shell Thickness: 2.0 ± 0.1 mm
Filling Volume: Approx. 20 liters
Dimensions: 50 cm (W) x 100 cm (L)

1900 MHz System Validation Setup



1900 MHz System Validation Setup



3. Measurement Conditions

The SAM phantom was filled with 1900 MHz brain simulating tissue.

Relative Permittivity: 38.3
Conductivity: 1.43 mho/m
Ambient Temperature: 24.0 °C
Fluid Temperature: 22.6 °C
Fluid Depth: ≥ 15.0 cm
Barometric Pressure: 103.0 kPa
Humidity: 37%

The 1900 MHz tissue simulant consists of the following ingredients:

Ingredient	Percentage by weight
Water	55.85%
Glycol	44.00%
Salt	0.15%
Target Dielectric Parameters at 22 °C	$\epsilon_r = 40.0$ $\sigma = 1.40$ S/m

4. SAR Measurement

The SAR measurement was performed with the E-field probe in mechanical detection mode only. The setup and determination of the forward power into the dipole was performed using the following procedures.

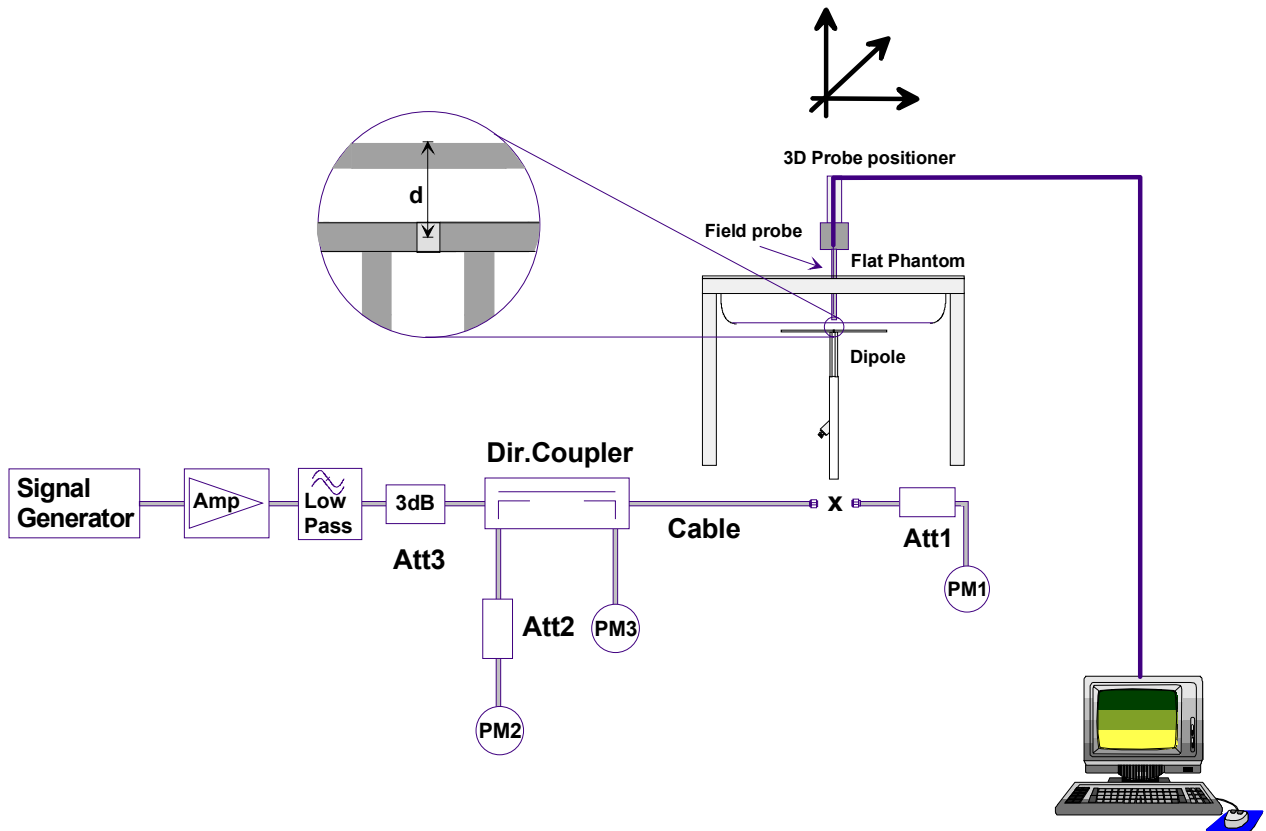

First the power meter PM1 (including attenuator Att1) is connected to the cable to measure the forward power at the location of the dipole connector (X). The signal generator is adjusted for the desired forward power at the dipole connector (taking into account the attenuation of Att1) as read by power meter PM2. After connecting the cable to the dipole, the signal generator is readjusted for the same reading at power meter PM2. If the signal generator does not allow adjustment in 0.01dB steps, the remaining difference at PM2 must be taken into consideration. PM3 records the reflected power from the dipole to ensure that the value is not changed from the previous value. The reflected power should be 50dB below the forward power.

Ten SAR measurements were performed in order to achieve repeatability and to establish an average target value.

Validation Dipole SAR Test Results

Validation Measurement	SAR @ 0.25W Input averaged over 1g	SAR @ 1W Input averaged over 1g	SAR @ 0.25W Input averaged over 10g	SAR @ 1W Input averaged over 10g	Peak SAR @ 0.25W Input
Test 1	10.1	40.40	5.30	21.20	17.4
Test 2	9.93	39.72	5.21	20.84	17.2
Test 3	9.98	39.92	5.23	20.92	17.3
Test 4	9.99	39.96	5.21	20.84	17.4
Test 5	9.97	39.88	5.22	20.88	17.4
Test 6	9.90	39.60	5.20	20.80	17.1
Test 7	9.93	39.72	5.21	20.84	17.2
Test 8	9.96	39.84	5.20	20.80	17.3
Test 9	9.94	39.76	5.20	20.80	17.2
Test 10	9.96	39.84	5.21	20.84	17.2
Average	9.966	39.864	5.219	20.876	17.27

The results have been normalized to 1W (forward power) into the dipole.

1g/10g Averaged	Average Measured SAR @ 1W Input	IEEE Target SAR @ 1W Input	Deviation (%)
1 gram	39.864	39.7	+ 0.413
10 gram	20.876	20.5	+ 1.835

1900 MHz System Validation - June 18, 2004

DUT: Dipole 1900 MHz; Type: D1900V2; Serial: 151

Ambient Temp: 24.0°C; Fluid Temp: 22.6°C; Barometric Pressure: 103.0 kPa; Humidity: 37%

Communication System: CW

Frequency: 1900 MHz; Duty Cycle: 1:1

Medium: HSL1900 ($\sigma = 1.43$ mho/m; $\epsilon_r = 38.3$; $\rho = 1000$ kg/m³)

- Probe: ET3DV6 - SN1387; ConvF(5.25, 5.25, 5.25); Calibrated: 18/03/2004

- Sensor-Surface: 4mm (Mechanical And Optical Surface Detection)

- Electronics: DAE3 Sn370; Calibrated: 14/05/2004

- Phantom: SAM 4.0; Type: Fiberglass; Serial: 1033

- Measurement SW: DASY4, V4.2 Build 44; Postprocessing SW: SEMCAD, V1.8 Build 112

1900 MHz System Validation/Area Scan (5x8x1): Measurement grid: dx=15mm, dy=15mm

Reference Value = 96.9 V/m; Power Drift = 0.1 dB

1900 MHz System Validation/Zoom Scan (7x7x7)/Cube 0: Measurement grid: dx=5mm, dy=5mm, dz=5mm

Reference Value = 96.9 V/m; Power Drift = 0.1 dB

Peak SAR (extrapolated) = 17.4 W/kg

SAR(1 g) = 10.1 mW/g; SAR(10 g) = 5.3 mW/g

1900 MHz System Validation/Zoom Scan 2 (7x7x7)/Cube 0:

Measurement grid: dx=5mm, dy=5mm, dz=5mm

Reference Value = 94.8 V/m; Power Drift = 0.0 dB

Peak SAR (extrapolated) = 17.2 W/kg

SAR(1 g) = 9.93 mW/g; SAR(10 g) = 5.21 mW/g

1900 MHz System Validation/Zoom Scan 3 (7x7x7)/Cube 0:

Measurement grid: dx=5mm, dy=5mm, dz=5mm

Reference Value = 94.2 V/m; Power Drift = 0.009 dB

Peak SAR (extrapolated) = 17.3 W/kg

SAR(1 g) = 9.98 mW/g; SAR(10 g) = 5.23 mW/g

1900 MHz System Validation/Zoom Scan 4 (7x7x7)/Cube 0:

Measurement grid: dx=5mm, dy=5mm, dz=5mm

Reference Value = 94.9 V/m; Power Drift = 0.001 dB

Peak SAR (extrapolated) = 17.4 W/kg

SAR(1 g) = 9.99 mW/g; SAR(10 g) = 5.21 mW/g

1900 MHz System Validation/Zoom Scan 5 (7x7x7)/Cube 0:

Measurement grid: dx=5mm, dy=5mm, dz=5mm

Reference Value = 95.2 V/m; Power Drift = -0.003 dB

Peak SAR (extrapolated) = 17.4 W/kg

SAR(1 g) = 9.97 mW/g; SAR(10 g) = 5.22 mW/g

1900 MHz System Validation/Zoom Scan 6 (7x7x7)/Cube 0:

Measurement grid: dx=5mm, dy=5mm, dz=5mm

Reference Value = 94.8 V/m; Power Drift = -0.0 dB

Peak SAR (extrapolated) = 17.1 W/kg

SAR(1 g) = 9.9 mW/g; SAR(10 g) = 5.2 mW/g

1900 MHz System Validation/Zoom Scan 7 (7x7x7)/Cube 0:

Measurement grid: dx=5mm, dy=5mm, dz=5mm

Reference Value = 94.8 V/m; Power Drift = -0.01 dB

Peak SAR (extrapolated) = 17.2 W/kg

SAR(1 g) = 9.93 mW/g; SAR(10 g) = 5.21 mW/g

1900 MHz System Validation/Zoom Scan 8 (7x7x7)/Cube 0:

Measurement grid: dx=5mm, dy=5mm, dz=5mm

Reference Value = 95.1 V/m; Power Drift = -0.007 dB

Peak SAR (extrapolated) = 17.3 W/kg

SAR(1 g) = 9.96 mW/g; SAR(10 g) = 5.2 mW/g

1900 MHz System Validation/Zoom Scan 9 (7x7x7)/Cube 0:

Measurement grid: dx=5mm, dy=5mm, dz=5mm

Reference Value = 94.7 V/m; Power Drift = -0.0 dB

Peak SAR (extrapolated) = 17.2 W/kg

SAR(1 g) = 9.94 mW/g; SAR(10 g) = 5.2 mW/g

1900 MHz System Validation/Zoom Scan 10 (7x7x7)/Cube 0:

Measurement grid: dx=5mm, dy=5mm, dz=5mm

Reference Value = 95.1 V/m; Power Drift = -0.0 dB

Peak SAR (extrapolated) = 17.2 W/kg

SAR(1 g) = 9.96 mW/g; SAR(10 g) = 5.21 mW/g

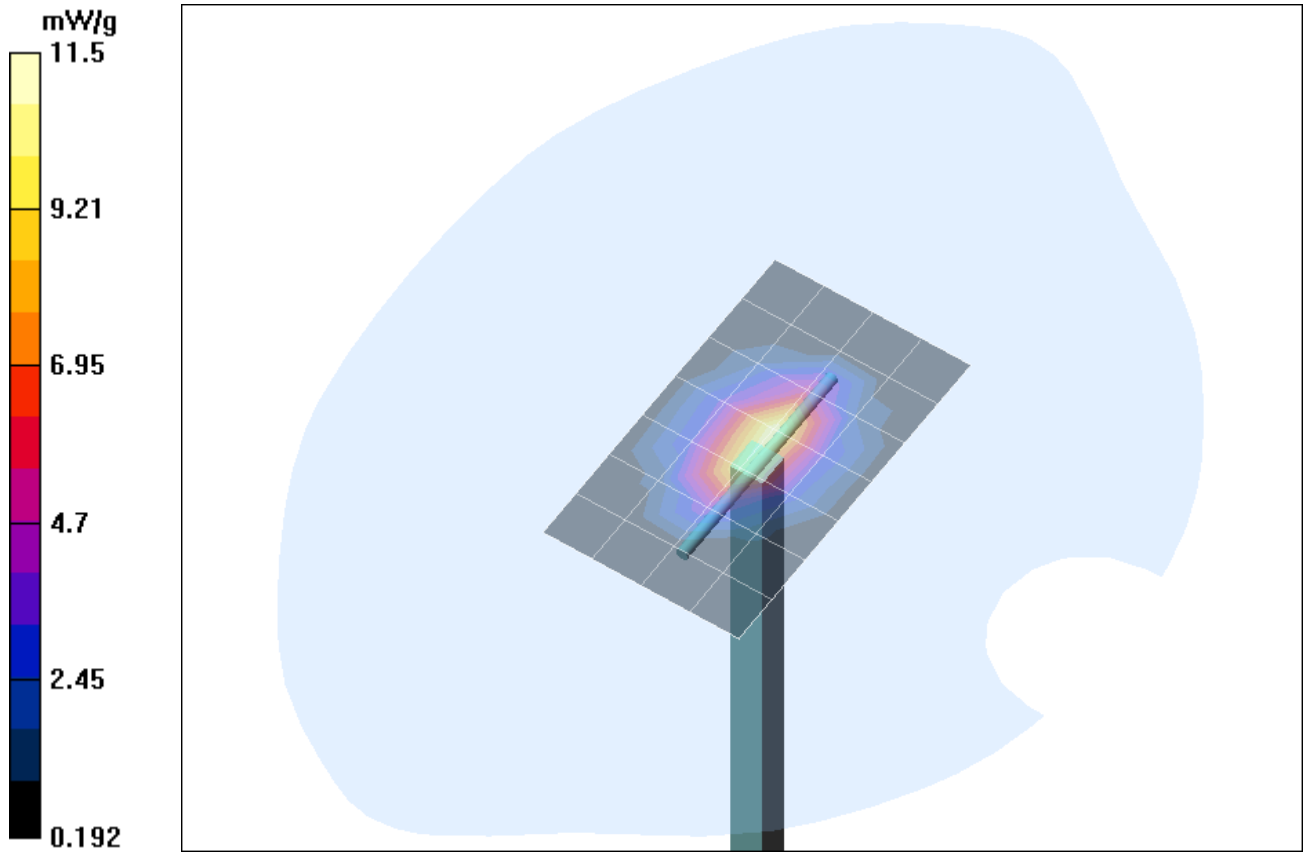

1 g average of 10 measurements: 9.966 mW/g
 10 g average of 10 measurements: 5.219 mW/g

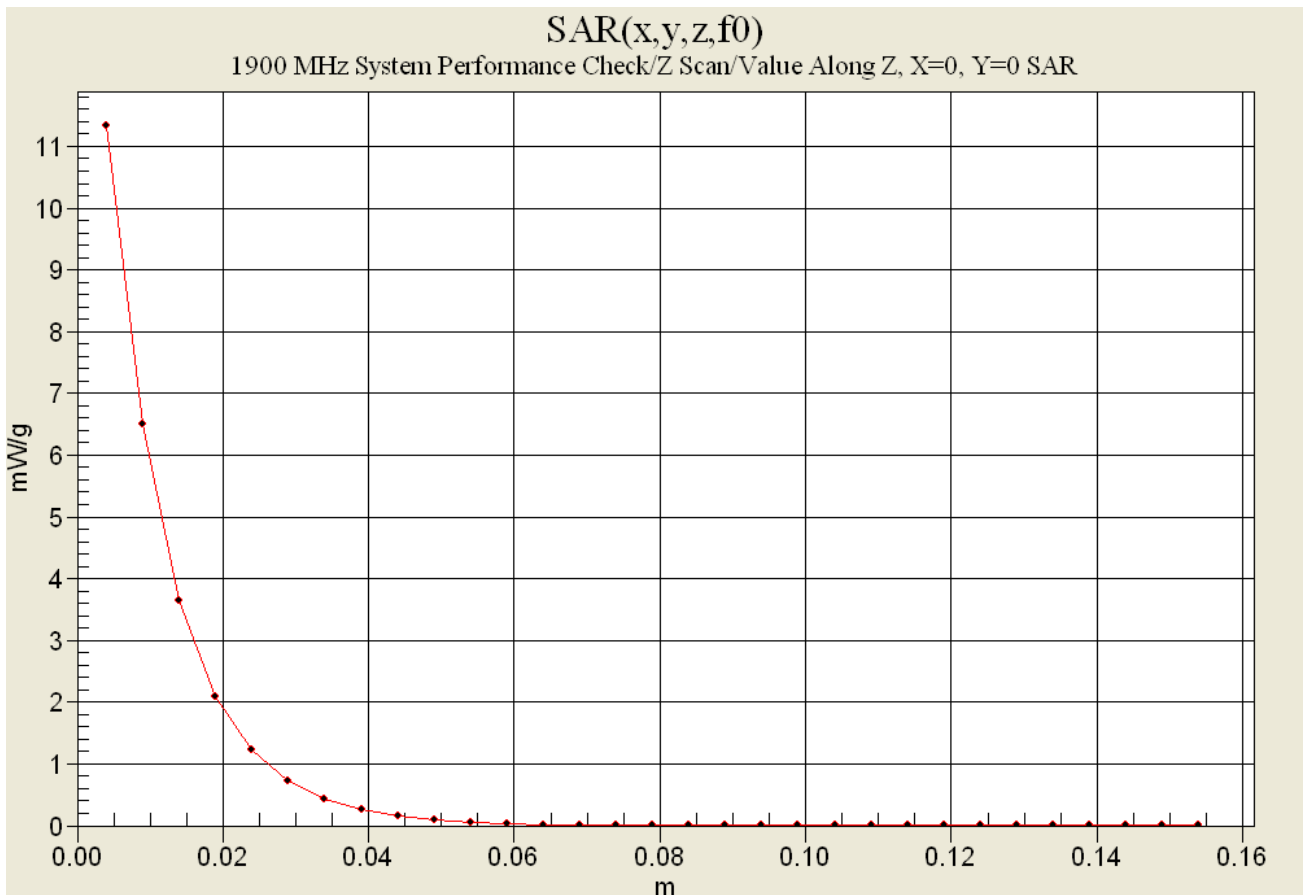

1900 MHz System Validation

Measured Fluid Dielectric Parameters (Brain)

June 18, 2004

Frequency	ϵ'	ϵ''
1.800000000 GHz	38.7685	13.2945
1.810000000 GHz	38.7232	13.3253
1.820000000 GHz	38.6647	13.3519
1.830000000 GHz	38.6047	13.3737
1.840000000 GHz	38.5593	13.4078
1.850000000 GHz	38.5136	13.4244
1.860000000 GHz	38.4736	13.4289
1.870000000 GHz	38.4328	13.4399
1.880000000 GHz	38.3934	13.4856
1.890000000 GHz	38.3637	13.4872
1.900000000 GHz	38.3205	13.5178
1.910000000 GHz	38.2981	13.5327
1.920000000 GHz	38.2590	13.5755
1.930000000 GHz	38.2344	13.5976
1.940000000 GHz	38.2172	13.6297
1.950000000 GHz	38.1838	13.6574
1.960000000 GHz	38.1575	13.6807
1.970000000 GHz	38.1070	13.6962
1.980000000 GHz	38.0516	13.7296
1.990000000 GHz	38.0093	13.7634
2.000000000 GHz	37.9485	13.7978