

RF EXPOSURE EVALUATION
SPECIFIC ABSORPTION RATE

SAR TEST REPORT

FOR THE

ITRONIX CORPORATION

IX325 SERIES RUGGED TABLET PC

WITH

802.11b/g WLAN MINI-PCI CARD

AND

DUAL INTERNAL PIFA ANTENNA

FCC ID: KBCIX325-AC580IWL

IC: 1943A-IX325f

Test Report Serial Number

100305KBC-T673-S15W

Test Report Issue No.

S673W-021306-R0

Test Lab

Celltech Compliance Testing & Engineering Lab

(Celltech Labs Inc.)

1955 Moss Court

Kelowna, BC

Canada

V1Y 9L3

Test Report Prepared By:

Cheri Frangiadakis

**Cheri Frangiadakis
Test Report Writer
Celltech Labs Inc.**

Test Report Approved By:

[Signature]

**Jonathan Hughes
General Manager
Celltech Labs Inc.**



Test Report Serial No.:	100305KBC-T673-S15W	Report Issue No.:	S673W-021306-R0
Date(s) of Evaluation:	June 09, 2005	Report Issue Date:	February 13, 2006
Type of Evaluation:	RF Exposure SAR	FCC 47 CFR 2.1093	IC RSS-102 Issue 2

DECLARATION OF COMPLIANCE SAR RF EXPOSURE EVALUATION

Test Lab

CELLTECH LABS INC.
Testing and Engineering Services
1955 Moss Court
Kelowna, B.C.
Canada V1Y 9L3
Phone: 250-448-7047
Fax: 250-448-7046
e-mail: info@celltechlabs.com
web site: www.celltechlabs.com

Applicant Information

ITRONIX CORPORATION
12825 E. Mirabeau Parkway
Spokane Valley, WA 99216
United States

FCC IDENTIFIER: KBCIX325-AC580IWL
IC IDENTIFER: 1943A-IX325f
Model(s): IX325-AC580IWL

Rule Part(s): FCC 47 CFR §2.1093; Health Canada Safety Code 6
Test Procedure(s): FCC OET Bulletin 65, Supplement C (Edition 01-01)
Industry Canada RSS-102 Issue 2
FCC Device Classification: Digital Transmission System (DTS)
IC Device Classification: Low Power License-Exempt Radiocommunication Device (RSS-210 Issue 6)



Device Description: Rugged Tablet PC
Internal Transmitter: Intel Pro 2200BG 802.11b/g WLAN Mini-PCI Card
Mode(s) of Operation: DSSS (Direct Sequence Spread Spectrum) - 802.11b/g
Modulation Type(s): OFDM with BPSK, QPSK, 16QAM, 64QAM, DBPSK, DQPSK, CCK
Data Rate(s): 802.11b: 1 / 2 / 5.5 / 11 Mbps
802.11g: 6 / 9 / 12 / 18 / 24 / 36 / 48 / 54 Mbps
Tx Frequency Range(s): 2412 - 2462 MHz (802.11b/g)
Max. RF Output Power Tested: 18.6 dBm (72 mW) Peak Conducted (802.11b, 1 Mbps)
Power Source(s) Tested: Internal Lithium-ion Battery 11.1 V, 3600 mAh (Model: T8M-E)
75 W AC Power Adapter (Delta Electronics Model: ADP-75FB B)
Antenna Type(s) Tested: Dual Internal PIFA (Transmit - Upper Right Side of LCD Display)

Max. SAR Level(s) Evaluated: Body: 0.00201 W/kg (Peak SAR measured from Area Scan)

Celltech Labs Inc. declares under its sole responsibility that this wireless device was compliant with the Specific Absorption Rate (SAR) RF exposure requirements specified in FCC 47 CFR §2.1093 and Health Canada's Safety Code 6. The device was tested in accordance with the measurement standards and procedures specified in FCC OET Bulletin 65, Supplement C (Edition 01-01) and Industry Canada RSS-102 Issue 2 for the General Population / Uncontrolled Exposure environment. All measurements were performed in accordance with the SAR system manufacturer recommendations.

I attest to the accuracy of data. All measurements were performed by me or were made under my supervision and are correct to the best of my knowledge and belief. I assume full responsibility for the completeness of these measurements and vouch for the qualifications of all persons taking them.

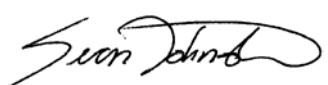
This test report shall not be reproduced partially, or in full, without the prior written approval of Celltech Labs Inc. The results and statements contained in this report pertain only to the device(s) evaluated.

<p>Tested By:</p>  <p>Sean Johnston Compliance Technologist Celltech Labs Inc.</p>	<p>Reviewed By:</p>  <p>Spencer Watson Senior Compliance Technologist Celltech Labs Inc.</p>
--	--



Applicant: Itronix Corporation	FCC ID: KBCIX325-AC580IWL	IC ID: 1943A-IX325f	
Model: IX325-AC580IWL	Rugged Tablet PC with Intel Pro 2200BG 802.11b/g WLAN Mini-PCI Card		
2006 Celltech Labs Inc.	This document is not to be reproduced in whole or in part without the prior written permission of Celltech Labs Inc.		Page 2 of 32

TABLE OF CONTENTS

1.0 INTRODUCTION	4
2.0 DESCRIPTION of DEVICE UNDER TEST (DUT)	4
3.0 SAR MEASUREMENT SYSTEM	5
4.0 MEASUREMENT SUMMARY	6
5.0 DETAILS OF SAR EVALUATION	7
6.0 EVALUATION PROCEDURES	7
7.0 SYSTEM PERFORMANCE CHECK	8
8.0 SIMULATED EQUIVALENT TISSUES	9
9.0 SAR SAFETY LIMITS	9
10.0 ROBOT SYSTEM SPECIFICATIONS	10
11.0 PROBE SPECIFICATION (ET3DV6)	11
12.0 SAM PHANTOM V4.0C	11
13.0 PLANAR PHANTOM	11
14.0 DEVICE HOLDER	11
15.0 TEST EQUIPMENT LIST	12
16.0 MEASUREMENT UNCERTAINTIES	13
17.0 REFERENCES	15
APPENDIX A - SAR MEASUREMENT DATA	16
APPENDIX B - SYSTEM PERFORMANCE CHECK DATA	20
APPENDIX C - MEASURED FLUID DIELECTRIC PARAMETERS	23
APPENDIX D - SAR TEST SETUP PHOTOGRAPHS	26
APPENDIX E - SYSTEM VALIDATION	29
APPENDIX F - PROBE CALIBRATION	30
APPENDIX G - SAM PHANTOM CERTIFICATE OF CONFORMITY	31
APPENDIX H - PLANAR PHANTOM CERTIFICATE OF CONFORMITY	32

1.0 INTRODUCTION

This measurement report demonstrates that ITRONIX CORPORATION Model: IX325-AC580IWL Rugged Tablet PC FCC ID: KBCIX325-AC580IWL incorporating the Intel Pro 2200BG 802.11b/g WLAN Mini-PCI Card complies with the SAR (Specific Absorption Rate) RF exposure requirements specified in FCC 47 CFR §2.1093 (see reference [1]), and Health Canada's Safety Code 6 (see reference [2]) for the General Population / Uncontrolled Exposure environment. The test procedures described in FCC OET Bulletin 65, Supplement C, Edition 01-01 (see reference [3]), and IC RSS-102 Issue 2 (see reference [4]), were employed. A description of the product and operating configuration, detailed summary of the test results, methodology and procedures used in the evaluation, equipment used, and the various provisions of the rules are included within this test report.

2.0 DESCRIPTION of DEVICE UNDER TEST (DUT)

FCC Rule Part(s)	47 CFR §2.1093					
IC Rule Part(s)	Health Canada Safety Code 6					
Test Procedure(s)	FCC OET Bulletin 65, Supplement C (01-01)			Industry Canada RSS-102 Issue 2		
FCC Device Classification	Digital Transmission System (DTS)				47 CFR Part 15C	
IC Device Classification	Low Power License-Exempt Radiocommunication Device				RSS-210 Issue 6	
Device Description	Rugged Tablet PC					
Internal Transmitter(s)	Intel Pro 2200BG 802.11b/g WLAN Mini-PCI Card					
RF Exposure Category	General Population / Uncontrolled Environment					
FCC IDENTIFIER	KBCIX325-AC580IWL			IC IDENTIFIER	1943A-IX325f	
Model(s)	IX325-AC580IWL					
Serial No.(s)	ZZGEG5074ZZ9799			Rugged Tablet PC		Identical Prototype
	06036C074ADC54906006			Intel 802.11b/g		Production Unit
Mode(s) of Operation	DSSS (Direct Sequence Spread Spectrum)					
Modulation Type(s)	OFDM with BPSK, QPSK, 16QAM, 64QAM, DBPSK, DQPSK, CCK					
Data Rate(s)	802.11b			1 / 2 / 5.5 / 11 Mbps		
	802.11g			6 / 9 / 12 / 18 / 24 / 36 / 48 / 54 Mbps		
Transmit Frequency Range(s)	2412 - 2462 MHz			802.11b/g		
Max. Conducted RF Output Power Level(s) Tested	Freq. (MHz)	Chan.	Test Mode	Data Rate	Peak Conducted	
	2442	6	802.11b	1Mbps	18.6 dBm	0.072 Watts
Note: A SAR evaluation was performed for the bottom side of DUT in 802.11b mode at 11 Mbps data rate, which measured 20.5 dBm peak conducted RF output power level (see EMC test report). The SAR result for 11 Mbps was lower than the SAR levels reported for 1 Mbps data rate.						
Antenna Type(s) Tested	Internal PIFA (Transmit)			Upper Right Side of LCD Display	802.11b/g WLAN	
Power Source(s) Tested	Internal Lithium-ion Battery			11.1 V, 3600 mAh		Model: T8M-E
	Delta Electronics AC Power Adapter			75 Watts AC		Model: ADP-75FB B
Additional Power Source(s) (Not Tested)	External Second Lithium-ion Battery			11.1 V, 3600 mAh		Model: T8S-E
	Note: The external second lithium-ion battery was not evaluated for SAR due to the fact that it has exactly the same power specifications as the internal battery and provides increased separation.					
DUT Configuration(s) Evaluated	Bottom Side			0.0 cm spacing		

3.0 SAR MEASUREMENT SYSTEM

Celltech Labs Inc. SAR measurement facility utilizes the Dosimetric Assessment System (DASY™) manufactured by Schmid & Partner Engineering AG (SPEAG™) of Zurich, Switzerland. The DASY4 measurement system is comprised of the measurement server, robot controller, computer, near-field probe, probe alignment sensor, specific anthropomorphic mannequin (SAM) phantom, and various planar phantoms for brain and/or body SAR evaluations. The robot is a six-axis industrial robot performing precise movements to position the probe to the location (points) of maximum electromagnetic field (EMF). A cell controller system contains the power supply, robot controller, teach pendant (Joystick), and remote control, is used to drive the robot motors. The Staubli robot is connected to the cell controller to allow software manipulation of the robot. A data acquisition electronic (DAE) circuit performs the signal amplification, signal multiplexing, AD-conversion, offset measurements, mechanical surface detection, collision detection, etc. is connected to the Electro-optical coupler (EOC). The EOC performs the conversion from the optical into digital electric signal of the DAE and transfers data to the DASY4 measurement server. The DAE3 utilizes a highly sensitive electrometer-grade preamplifier with auto-zeroing, a channel and gain-switching multiplexer, a fast 16-bit AD-converter and a command decoder and control logic unit. Transmission to the DASY4 measurement server is accomplished through an optical downlink for data and status information and an optical uplink for commands and clock lines. The mechanical probe-mounting device includes two different sensor systems for frontal and sidewise probe contacts. The sensor systems are also used for mechanical surface detection and probe collision detection. The robot uses its own controller with a built in VME-bus computer.



DASY4 SAR Measurement System with planar phantom



DASY4 SAR Measurement System with SAM phantom

4.0 MEASUREMENT SUMMARY

BODY SAR MEASUREMENT RESULTS										
Freq.	Chan.	Test Mode	Data Rate (Mbps)	Power Source	Antenna Type	DUT Position to Planar Phantom	Separation Distance to Planar Phantom (cm)	Conducted Power Before Test (dBm)	Peak SAR Measured from Area Scan (W/kg)	
2442	6	802.11b	1	Internal Li-ion Battery	Internal PIFA	Bottom Side	0.0	18.6	0.00201	
2442	6	802.11b	1	AC Power	Internal PIFA	Bottom Side	0.0	18.6	0.00148	
ANSI / IEEE C95.1 1999 - SAFETY LIMIT BODY: 1.6 W/kg (averaged over 1 gram) Spatial Peak - Uncontrolled Exposure / General Population										
Test Date(s)		June 09, 2005				Relative Humidity		34	%	
Measured Fluid Type		2450 MHz Body				Atmospheric Pressure		101.4	kPa	
Dielectric Constant ϵ_r		IEEE Target		Measured	Deviation	Ambient Temperature		24.7	°C	
		52.7	±5%	51.2	-2.8%	Fluid Temperature		23.4	°C	
Conductivity σ (mho/m)		IEEE Target		Measured	Deviation	Fluid Depth		≥ 15		
		1.95	±5%	1.99	+2.1%	ρ (Kg/m³)		1000		

Note(s):

- The measurement results were obtained with the DUT tested in the conditions described in this report. Detailed measurement data and plots showing the maximum SAR location of the DUT are reported in Appendix A.
- The 1g averaged SAR was not measured because the peak SAR value from the area scan evaluations for each test configuration was less than 1% of the 1g average limit. The peak SAR values measured during the area scan evaluations for each test configuration are reported. The mathematical formula used to extrapolate the SAR value at the surface from the Zoom Scan SAR values measured at 5 mm steps leading away from the surface assumes a curving slope (i.e. the SAR values gradually decrease as the probe moves away from the surface). When the peak SAR of a device is so low that the RF noise level is competing with the level of the SAR, the Zoom Scan measurements leading away from the surface are no longer a curving slope and the extrapolation formula cannot accurately estimate the 1g average SAR. In this manner, we have reported the peak values from the Area Scan in place of the 1g averaged SAR values whenever the peak values are less than 1% of the average limit. This avoids gross uncertainties in the 1g average SAR calculation while maintaining a conservative estimation of the SAR level. It is the engineering judgment of Celltech Labs Inc. that no device operating in this frequency band could have a peak SAR value (measured on an Area Scan) less than 0.016 mW/g and simultaneously have a 1g average value greater than 1.6 mW/g (1g average limit).
- 802.11g mode was not evaluated for SAR based on the measured RF conducted output power levels were lower than the power levels measured in 802.11b mode (per Oct. 2005 TCB Council Workshop - see reference [6]).
- The DUT battery was fully charged prior to the SAR evaluations.
- The ambient and fluid temperatures were measured prior to, and during, the fluid dielectric parameter check and the SAR evaluations. The temperatures reported were consistent for all measurement periods.
- The dielectric parameters of the simulated tissue mixture were measured prior to the SAR evaluations using an ALS-PR-DIEL Dielectric Probe Kit and an HP 8753ET Network Analyzer (see Appendix C).
- The SAR evaluations were performed within 24 hours of the system performance check.

	Test Report Serial No.:	100305KBC-T673-S15W	Report Issue No.:	S673W-021306-R0
	Date(s) of Evaluation:	June 09, 2005	Report Issue Date:	February 13, 2006
	Type of Evaluation:	RF Exposure	SAR	FCC 47 CFR 2.1093

5.0 DETAILS OF SAR EVALUATION

The ITRONIX CORPORATION Model: IX325-AC580IWL Rugged Tablet PC FCC ID: KBCIX325-AC580IWL with Intel Pro 2200BG 802.11b/g WLAN Mini-PCI Card was compliant for localized Specific Absorption Rate (Uncontrolled Exposure) based on the test provisions and conditions described below. The detailed test setup photographs are shown in Appendix D.

Test Configuration

1. The DUT was evaluated for body SAR with the bottom side of the tablet PC placed parallel to, and touching, the outer surface of the planar phantom. The DUT was evaluated with internal lithium-ion battery and AC power supply.
2. The ambient and fluid temperatures were measured prior to, and during, the fluid dielectric parameter check and the SAR evaluations. The temperatures reported were consistent for all measurement periods.
3. The dielectric parameters of the simulated tissue mixture were measured prior to the SAR evaluations using an ALS-PR-DIEL Dielectric Probe Kit and an HP 8753ET Network Analyzer (see Appendix C).
4. The SAR evaluations were performed within 24 hours of the daily system performance check.

Test Modes & Power Settings

5. The DUT was controlled in test mode via internal software. SAR measurements were performed with the DUT transmitting continuously at maximum power with a modulated DSSS signal.
6. The peak conducted power levels were measured prior to the SAR evaluations using a Gigatronics 8652A Universal Power Meter according to the procedures described in FCC 47 CFR §2.1046.
7. 802.11g mode was not evaluated for SAR based on the measured RF conducted output power levels were lower than the power levels measured in 802.11b mode (per Oct. 2005 TCB Council Workshop - see reference [6]).
8. The DUT battery was fully charged prior to the SAR evaluations.

6.0 EVALUATION PROCEDURES

- (i) The evaluation was performed in the applicable area of the phantom depending on the type of device being tested. For devices held to the ear during normal operation, both the left and right ear positions were evaluated using the SAM phantom.
- (ii) For body-worn and face-held devices a planar phantom was used.
- The SAR was determined by a pre-defined procedure within the DASY4 software. Upon completion of a reference and optical surface check, the exposed region of the phantom was scanned near the inner surface with a grid spacing of 15mm x 15mm.
An area scan was determined as follows:
 - Based on the defined area scan grid, a more detailed grid is created to increase the points by a factor of 10. The interpolation function then evaluates all field values between corresponding measurement points.
 - A linear search is applied to find all the candidate maxima. Subsequently, all maxima are removed that are >2 dB from the global maximum. The remaining maxima are then used to position the cube scans.
A 1g and 10g spatial peak SAR was determined as follows:
- Extrapolation is used to find the points between the dipole center of the probe and the surface of the phantom. This data cannot be measured, since the center of the dipoles is 2.7 mm away from the tip of the probe and the distance between the surface and the lowest measuring point is 1.4 mm (see probe calibration document in Appendix F). The extrapolation was based on trivariate quadratics computed from the previously calculated 3D interpolated points nearest the phantom surface.
- Interpolated data is used to calculate the average SAR over 1g and 10g cubes by spatially discretizing the entire measured cube. The volume used to determine the averaged SAR is a 1mm grid (42875 interpolated points).
- A zoom scan volume of 32 mm x 32 mm x 30 mm (5 x 5 x 7 points) centered at the peak SAR location determined from the area scan is used for all zoom scans for devices with a transmit frequency < 800 MHz. Zoom scans for frequencies ≥ 800 MHz are determined with a scan volume of 30 mm x 30 mm x 30 mm (7 x 7 x 7) to ensure complete capture of the peak spatial-average SAR.

Applicant:	Itronix Corporation	FCC ID:	KBCIX325-AC580IWL	IC ID:	1943A-IX325f	
Model:	IX325-AC580IWL	Rugged Tablet PC with Intel Pro 2200BG 802.11b/g WLAN Mini-PCI Card				
2006 Celltech Labs Inc.	This document is not to be reproduced in whole or in part without the prior written permission of Celltech Labs Inc.					Page 7 of 32

7.0 SYSTEM PERFORMANCE CHECK

Prior to the SAR evaluations a system check was performed with a 2450MHz dipole (see Appendix E for system validation procedures) evaluated at the planar section of the SAM phantom. The dielectric parameters of the simulated tissue mixture were measured prior to the system performance check using an ALS-PR-DIEL Dielectric Probe Kit and an HP 8753ET Network Analyzer (see Appendix C). A forward power of 250 mW was applied to the dipole and the system was verified to a tolerance of $\pm 10\%$ (see Appendix B for system performance check test plot).

SYSTEM PERFORMANCE CHECK EVALUATION																
Test Date	2450MHz Equiv. Tissue	SAR 1g (W/kg)			Dielectric Constant ϵ_r			Conductivity σ (mho/m)			ρ (Kg/m ³)	Amb. Temp. (°C)	Fluid Temp. (°C)	Fluid Depth (cm)	Humid. (%)	Barom. Press. (kPa)
		IEEE Target	Meas.	Dev.	IEEE Target	Meas.	Dev.	IEEE Target	Meas.	Dev.						
6/9/05	Brain	13.1 $\pm 10\%$	13.9	+6.1%	39.2 $\pm 5\%$	37.4	-4.6%	1.80 $\pm 5\%$	1.87	+3.9%	1000	22.0	24.8	≥ 15	38	101.7

Note(s):
 1. The ambient and fluid temperatures were measured prior to, and during, the fluid dielectric parameter check and the system performance check. The temperatures listed in the table above were consistent for all measurement periods.

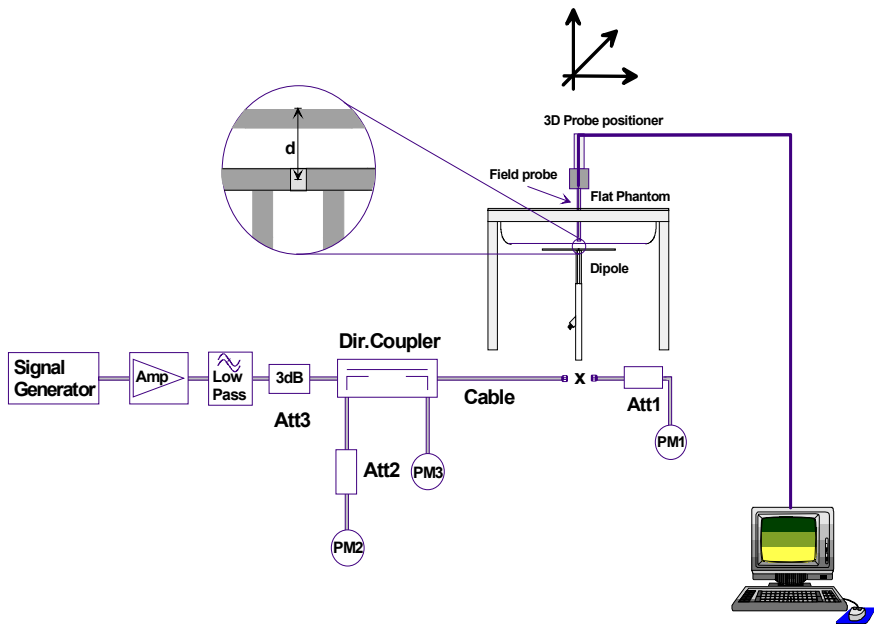

Figure 1. System Performance Check Setup Diagram



2450MHz Dipole Setup

8.0 SIMULATED EQUIVALENT TISSUES

The 2450MHz simulated tissue mixtures consist of Glycol-monobutyl, water, and salt (body mixture only). The fluids were prepared according to standardized procedures and measured for dielectric parameters (permittivity and conductivity).

SIMULATED TISSUE MIXTURES		
INGREDIENT	2450 MHz Brain	2450 MHz Body
	System Performance Check	DUT Evaluation
Water	52.00 %	69.98 %
Glycol Monobutyl	48.00 %	30.00 %
Salt	-	0.02 %

9.0 SAR SAFETY LIMITS

EXPOSURE LIMITS	SAR (W/kg)	
	(General Population / Uncontrolled Exposure Environment)	(Occupational / Controlled Exposure Environment)
Spatial Average (averaged over the whole body)	0.08	0.4
Spatial Peak (averaged over any 1 g of tissue)	1.60	8.0
Spatial Peak (hands/wrists/feet/ankles averaged over 10 g)	4.0	20.0

Notes:

1. Uncontrolled environments are defined as locations where there is potential exposure of individuals who have no knowledge or control of their potential exposure.
2. Controlled environments are defined as locations where there is potential exposure of individuals who have knowledge of their potential exposure and can exercise control over their exposure.

10.0 ROBOT SYSTEM SPECIFICATIONS

Specifications

POSITIONER: Stäubli Unimation Corp. Robot Model: RX60L
Repeatability: 0.02 mm
No. of axis: 6

Data Acquisition Electronic (DAE) System

Cell Controller

Processor: AMD Athlon XP 2400+
Clock Speed: 2.0 GHz
Operating System: Windows XP Professional

Data Converter

Features: Signal Amplifier, multiplexer, A/D converter, and control logic
Software: DASY4 software
Connecting Lines: Optical downlink for data and status info.
 Optical uplink for commands and clock

DASY4 Measurement Server

Function: Real-time data evaluation for field measurements and surface detection
Hardware: PC/104 166MHz Pentium CPU; 32 MB chipdisk; 64 MB RAM
Connections: COM1, COM2, DAE, Robot, Ethernet, Service Interface

E-Field Probe

Model: ET3DV6
Serial No.(s): 1590
Construction: Triangular core fiber optic detection system
Frequency: 10 MHz to 6 GHz
Linearity: ± 0.2 dB (30 MHz to 3 GHz)

Phantom(s)

Type: Planar Phantom
Shell Material: Fiberglass
Thickness: 2.0 ± 0.1 mm
Volume: Approx. 72 liters

Type: SAM V4.0C
Shell Material: Fiberglass
Thickness: 2.0 ± 0.1 mm
Volume: Approx. 25 liters

11.0 PROBE SPECIFICATION (ET3DV6)

Construction:	Symmetrical design with triangular core Built-in shielding against static charges PEEK enclosure material (resistant to organic solvents, e.g. glycol)
Calibration:	In air from 10 MHz to 2.5 GHz In brain simulating tissue at frequencies of 900 MHz and 1.8 GHz (accuracy $\pm 8\%$)
Frequency:	10 MHz to >6 GHz; Linearity: ± 0.2 dB (30 MHz to 3 GHz)
Directivity:	± 0.2 dB in brain tissue (rotation around probe axis) ± 0.4 dB in brain tissue (rotation normal to probe axis)
Dynamic Range:	5 μ W/g to >100 mW/g; Linearity: ± 0.2 dB
Surface Detection:	± 0.2 mm repeatability in air and clear liquids over diffuse reflecting surfaces
Dimensions:	Overall length: 330 mm Tip length: 16 mm Body diameter: 12 mm Tip diameter: 6.8 mm Distance from probe tip to dipole centers: 2.7 mm
Application:	General dosimetry up to 3 GHz Compliance tests of portable devices



**ET3DV6
E-Field Probe**

12.0 SAM PHANTOM V4.0C

The SAM phantom V4.0C is a fiberglass shell phantom with a 2.0 mm (+/-0.2 mm) shell thickness for left and right head and flat planar area integrated in a wooden table. The shape of the fiberglass shell corresponds to the phantom defined by SCC34-SC2. The device holder positions are adjusted to the standard measurement positions in the three sections (see Appendix G for specifications of the SAM phantom V4.0C).

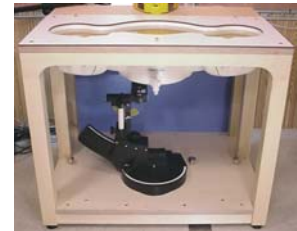

SAM Phantom

13.0 PLANAR PHANTOM

The planar phantom is a fiberglass shell phantom with a 2.0 mm (+/-0.2mm) thick device measurement area at the center of the phantom for SAR evaluations of devices with a larger surface area than the planar section of the SAM phantom. The planar phantom is integrated in a wooden table (see Appendix H for dimensions and specifications of the planar phantom).



Planar Phantom

14.0 DEVICE HOLDER

The DASY4 device holder has two scales for device rotation (with respect to the body axis) and the device inclination (with respect to the line between the ear openings). The plane between the ear openings and the mouth tip has a rotation angle of 65°. The bottom plate contains three pair of bolts for locking the device holder. The device holder positions are adjusted to the standard measurement positions in the three sections. For evaluations of larger devices such as Laptop and Tablet PCs, a Plexiglas platform is attached to the device holder.



Device Holder

15.0 TEST EQUIPMENT LIST

USED	TEST EQUIPMENT DESCRIPTION	ASSET NO.	SERIAL NO.	DATE CALIBRATED	CALIBRATION DUE DATE	
x	Schmid & Partner DASY4 System	-	-	-	-	
x	-DASY4 Measurement Server	00158	1078	N/A	N/A	
x	-Robot	00046	599396-01	N/A	N/A	
	-DAE3	00019	353	06Jul04	06Jul05	
	-DAE4			15Jun05	15Jun06	
x	-DAE3	00018	370	25Jan05	25Jan06	
	-ET3DV6 E-Field Probe	00016	1387	18Mar05	18Mar06	
x	-ET3DV6 E-Field Probe	00017	1590	20May05	20May06	
	-EX3DV4 E-Field Probe	00125	3547	21Jan05	21Jan06	
	-300MHz Validation Dipole	00023	135	26Oct04	26Oct05	
	-450MHz Validation Dipole	00024	136	04Nov04	04Nov05	
	-835MHz Validation Dipole	00022	411	Brain	30Mar05	30Mar06
				Body	12Apr05	12Apr06
	-900MHz Validation Dipole	00020	054	Brain	10Jun04	10Jun05
				Brain	10Jun05	10Jun06
				Body	10Jun05	10Jun06
				Body	10Jun05	10Jun06
	-1800MHz Validation Dipole	00021	247	Brain	08Jun04	08Jun05
				Brain	14Jun05	14Jun06
				Body	14Jun05	14Jun06
				Body	14Jun05	14Jun06
	-1900MHz Validation Dipole	00032	151	Brain	18Jun04	18Jun05
				Brain	17Jun05	17Jun06
				Body	22Apr05	22Apr06
				Body	22Apr05	22Apr06
x	-2450MHz Validation Dipole	00025	150	Brain	30Sep04	30Sep05
				Body	22Apr05	22Apr06
	-5000MHz Validation Dipole	00126	1031	Brain	11Jan05	11Jan06
				Body	11Jan05	11Jan06
x	-SAM Phantom V4.0C	00154	1033	N/A	N/A	
x	-Barski Planar Phantom	00155	03-01	N/A	N/A	
	-Plexiglas Side Planar Phantom	00156	161	N/A	N/A	
	-Plexiglas Validation Planar Phantom	00157	137	N/A	N/A	
	HP 85070C Dielectric Probe Kit	00033	N/A	N/A	N/A	
x	ALS-PR-DIEL Dielectric Probe Kit	00160	260-00953	N/A	N/A	
x	Gigatronics 8652A Power Meter	00110	1835801	16Apr05	16Apr06	
	Gigatronics 8652A Power Meter	00008	1835267	29Apr05	29Apr06	
	Gigatronics 8652A Power Meter	00007	1835272	18Oct04	18Oct05	
x	Gigatronics 80701A Power Sensor	00013	1833713	11Oct04	11Oct05	
	Gigatronics 80701A Power Sensor	00011	1833542	08Oct04	08Oct05	
x	Gigatronics 80701A Power Sensor	00109	1834366	16Apr05	16Apr06	
x	HP 8753ET Network Analyzer	00134	US39170292	04May05	04May06	
x	HP 8648D Signal Generator	00005	3847A00611	29Apr05	29Apr06	
	Rohde & Schwarz SMR40 Signal Generator	00006	100104	12Apr05	12Apr06	
x	Amplifier Research 5S1G4 Power Amplifier	00106	26235	N/A	N/A	

16.0 MEASUREMENT UNCERTAINTIES

UNCERTAINTY BUDGET FOR DEVICE EVALUATION						
Error Description	Uncertainty Value ±%	Probability Distribution	Divisor	ci 1g	Uncertainty Value ±% (1g)	V _i or V _{eff}
Measurement System						
Probe calibration	5.9	Normal	1	1	5.9	∞
Axial isotropy of the probe	4.7	Rectangular	1.732050808	0.7	1.9	∞
Spherical isotropy of the probe	9.6	Rectangular	1.732050808	0.7	3.9	∞
Spatial resolution	0	Rectangular	1.732050808	1	0.0	∞
Boundary effects	1	Rectangular	1.732050808	1	0.6	∞
Probe linearity	4.7	Rectangular	1.732050808	1	2.7	∞
Detection limit	1	Rectangular	1.732050808	1	0.6	∞
Readout electronics	0.3	Normal	1	1	0.3	∞
Response time	0.8	Rectangular	1.732050808	1	0.5	∞
Integration time	2.6	Rectangular	1.732050808	1	1.5	∞
RF ambient conditions	3	Rectangular	1.732050808	1	1.7	∞
Mech. constraints of robot	0.4	Rectangular	1.732050808	1	0.2	∞
Probe positioning	2.9	Rectangular	1.732050808	1	1.7	∞
Extrapolation & integration	1	Rectangular	1.732050808	1	0.6	∞
Test Sample Related						
Device positioning	2.9	Normal	1	1	2.9	12
Device holder uncertainty	3.6	Normal	1	1	3.6	8
Power drift	5	Rectangular	1.732050808	1	2.9	∞
Phantom and Setup						
Phantom uncertainty	4	Rectangular	1.732050808	1	2.3	∞
Liquid conductivity (target)	5	Rectangular	1.732050808	0.64	1.8	∞
Liquid conductivity (measured)	2.5	Normal	1	0.64	1.6	∞
Liquid permittivity (target)	5	Rectangular	1.732050808	0.6	1.7	∞
Liquid permittivity (measured)	2.5	Normal	1	0.6	1.5	∞
Combined Standard Uncertainty					10.79	
Expanded Uncertainty (k=2)					21.59	

Measurement Uncertainty Table in accordance with IEEE Standard 1528-2003 (see reference [5])

MEASUREMENT UNCERTAINTIES (Cont.)

UNCERTAINTY BUDGET FOR SYSTEM VALIDATION						
Error Description	Uncertainty Value ±%	Probability Distribution	Divisor	ci 1g	Uncertainty Value ±% (1g)	V _i or V _{eff}
Measurement System						
Probe calibration	5.9	Normal	1	1	5.9	∞
Axial isotropy of the probe	4.7	Rectangular	1.732050808	1	2.7	∞
Spherical isotropy of the probe	0	Rectangular	1.732050808	1	0.0	∞
Spatial resolution	0	Rectangular	1.732050808	1	0.0	∞
Boundary effects	1	Rectangular	1.732050808	1	0.6	∞
Probe linearity	4.7	Rectangular	1.732050808	1	2.7	∞
Detection limit	1	Rectangular	1.732050808	1	0.6	∞
Readout electronics	0.3	Normal	1	1	0.3	∞
Response time	0	Rectangular	1.732050808	1	0.0	∞
Integration time	0	Rectangular	1.732050808	1	0.0	∞
RF ambient conditions	3	Rectangular	1.732050808	1	1.7	∞
Mech. constraints of robot	0.4	Rectangular	1.732050808	1	0.2	∞
Probe positioning	2.9	Rectangular	1.732050808	1	1.7	∞
Extrapolation & integration	1	Rectangular	1.732050808	1	0.6	∞
Test Sample Related						
Dipole Positioning	2	Normal	1.732050808	1	1.2	∞
Power & Power Drift	4.7	Normal	1.732050808	1	2.7	∞
Phantom and Setup						
Phantom uncertainty	4	Rectangular	1.732050808	1	2.3	∞
Liquid conductivity (target)	5	Rectangular	1.732050808	0.64	1.8	∞
Liquid conductivity (measured)	2.5	Normal	1	0.64	1.6	∞
Liquid permittivity (target)	5	Rectangular	1.732050808	0.6	1.7	∞
Liquid permittivity (measured)	2.5	Normal	1	0.6	1.5	∞
Combined Standard Uncertainty					9.04	
Expanded Uncertainty (k=2)					18.08	

Measurement Uncertainty Table in accordance with IEEE Standard 1528-2003 (see reference [5])

	Test Report Serial No.:	100305KBC-T673-S15W	Report Issue No.:	S673W-021306-R0
	Date(s) of Evaluation:	June 09, 2005	Report Issue Date:	February 13, 2006
	Type of Evaluation:	RF Exposure	SAR	FCC 47 CFR 2.1093

17.0 REFERENCES

- [1] Federal Communications Commission, "Radiofrequency radiation exposure evaluation: portable devices", Rule Part 47 CFR §2.1093: 1999.
- [2] Health Canada, "Limits of Human Exposure to Radiofrequency Electromagnetic Fields in the Frequency Range from 3 kHz to 300 GHz", Safety Code 6: 1999.
- [3] Federal Communications Commission, "Evaluating Compliance with FCC Guidelines for Human Exposure to Radio frequency Electromagnetic Fields", OET Bulletin 65, Supplement C (Edition 01-01), FCC, Washington, D.C.: June 2001.
- [4] Industry Canada, "Radio Frequency Exposure Compliance of Radiocommunication Apparatus (All Frequency Bands)", Radio Standards Specification RSS-102 Issue 2: November 2005.
- [5] IEEE Standard 1528-2003, "Recommended Practice for Determining the Peak Spatial-Average Specific Absorption Rate (SAR) in the Human Head from Wireless Communications Devices: Measurement Techniques": December 2003.
- [6] FCC TCB Council Workshop, "RF Exposure (RFx) Mobile and Portable Device Review and Approval Procedures": October 2005.

Applicant:	Itronix Corporation	FCC ID:	KBCIX325-AC580IWL	IC ID:	1943A-IX325f	
Model:	IX325-AC580IWL	Rugged Tablet PC with Intel Pro 2200BG 802.11b/g WLAN Mini-PCI Card				
2006 Celltech Labs Inc.	This document is not to be reproduced in whole or in part without the prior written permission of Celltech Labs Inc.					Page 15 of 32

	Test Report Serial No.:	100305KBC-T673-S15W	Report Issue No.:	S673W-021306-R0
	Date(s) of Evaluation:	June 09, 2005	Report Issue Date:	February 13, 2006
	Type of Evaluation:	RF Exposure	SAR	FCC 47 CFR 2.1093

APPENDIX A - SAR MEASUREMENT DATA

Applicant:	Itronix Corporation	FCC ID:	KBCIX325-AC580IWL	IC ID:	1943A-IX325f	
Model:	IX325-AC580IWL	Rugged Tablet PC with Intel Pro 2200BG 802.11b/g WLAN Mini-PCI Card				
2006 Celltech Labs Inc.	This document is not to be reproduced in whole or in part without the prior written permission of Celltech Labs Inc.					Page 16 of 32

	Test Report Serial No.:	100305KBC-T673-S15W	Report Issue No.:	S673W-021306-R0
	Date(s) of Evaluation:	June 09, 2005	Report Issue Date:	February 13, 2006
	Type of Evaluation:	RF Exposure	SAR	FCC 47 CFR 2.1093

Date Tested: 06/09/2005

Body SAR - 802.11b - 1Mbps - Bottom Side of DUT - 0.0 cm Spacing - Internal Battery Power

DUT: Itronix Model: IX325-AC580IWL; Type: Rugged Tablet PC with 802.11b/g WLAN & Co-located GSM; Serial: ZZGEG5074ZZ9799

Ambient Temp: 24.7 °C; Fluid Temp: 23.4 °C; Barometric Pressure: 101.4 kPa; Humidity: 34%

11.1V, 3600mAh Internal Li-ion Battery Pack (Model: T8M-E)

Communication System: DSSS WLAN

Frequency: 2442 MHz; Duty Cycle: 1:1

RF Output Power: 18.6 dBm (Peak Conducted)

Medium: M2450 ($\sigma = 1.99$ mho/m; $\epsilon_r = 51.2$; $\rho = 1000$ kg/m³)

- Probe: ET3DV6 - SN1590; ConvF(4.22, 4.22, 4.22); Calibrated: 20/05/2005
- Sensor-Surface: 4mm (Mechanical Surface Detection)
- Electronics: DAE3 Sn370; Calibrated: 25/01/2005
- Phantom: Barski Industries; Type: Fiberglas Planar; Serial: 03-01
- Measurement SW: DASY4, V4.5 Build 19; Postprocessing SW: SEMCAD, V1.8 Build 146

Body SAR - 802.11b - 0.0 cm Separation Distance from Bottom Side of DUT to Planar Phantom - Mid Channel

Area Scan (16x23x1): Measurement grid: dx=15mm, dy=15mm

Maximum Peak Value of SAR (measured) = 0.00201 mW/g

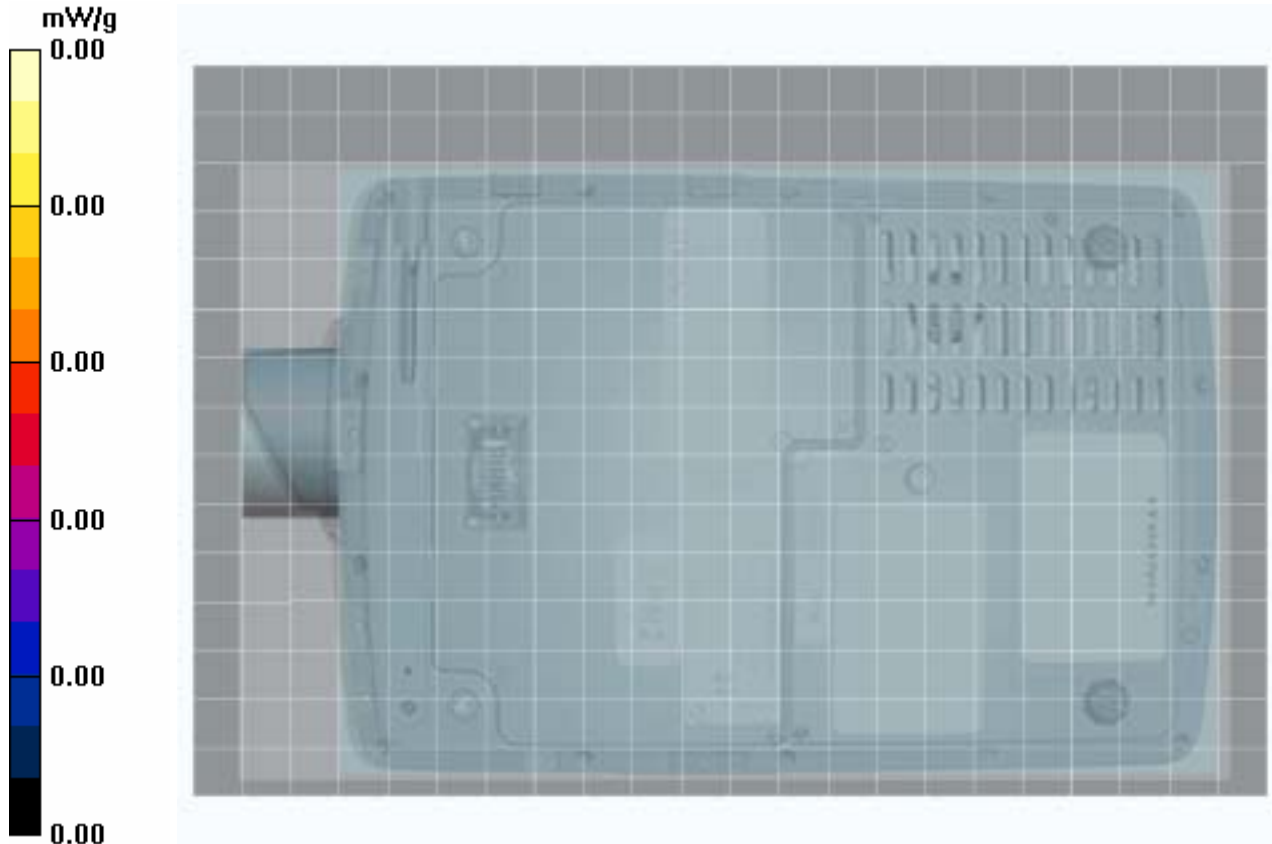

Applicant:	Itronix Corporation	FCC ID:	KBCIX325-AC580IWL	IC ID:	1943A-IX325f	
Model:	IX325-AC580IWL	Rugged Tablet PC with Intel Pro 2200BG 802.11b/g WLAN Mini-PCI Card				
2006 Celltech Labs Inc.		This document is not to be reproduced in whole or in part without the prior written permission of Celltech Labs Inc.				Page 17 of 32

Test Report Serial No.:	100305KBC-T673-S15W	Report Issue No.:	S673W-021306-R0
Date(s) of Evaluation:	June 09, 2005	Report Issue Date:	February 13, 2006
Type of Evaluation:	RF Exposure	SAR	FCC 47 CFR 2.1093
			IC RSS-102 Issue 2

Date Tested: 06/09/2005

Body SAR - 802.11b - 1Mbps - Bottom Side of DUT - 0.0 cm Spacing - AC Power Supply

DUT: Itronix Model: IX325-AC580IWL; Type: Rugged Tablet PC with 802.11b/g WLAN & Co-located GSM; Serial: ZZGEG5074ZZ9799

Ambient Temp: 24.7 °C; Fluid Temp: 23.4 °C; Barometric Pressure: 101.4 kPa; Humidity: 34%

75 W AC Power Adapter (Delta Electronics Model: ADP-75FB B)

Communication System: DSSS WLAN

Frequency: 2442 MHz; Duty Cycle: 1:1

RF Output Power: 18.6 dBm (Peak Conducted)

Medium: M2450 ($\sigma = 1.99$ mho/m; $\epsilon_r = 51.2$; $\rho = 1000$ kg/m³)

- Probe: ET3DV6 - SN1590; ConvF(4.22, 4.22, 4.22); Calibrated: 20/05/2005
- Sensor-Surface: 4mm (Mechanical Surface Detection (Locations From Previous Scan Used))
- Electronics: DAE3 Sn370; Calibrated: 25/01/2005
- Phantom: Barski Industries; Type: Fiberglas Planar; Serial: 03-01
- Measurement SW: DASY4, V4.5 Build 19; Postprocessing SW: SEMCAD, V1.8 Build 146

Body SAR - 802.11b - 0.0 cm Separation Distance from Bottom Side of DUT to Planar Phantom - Mid Channel

Area Scan (16x23x1): Measurement grid: dx=15mm, dy=15mm

Maximum Peak Value of SAR (measured) = 0.00148 mW/g

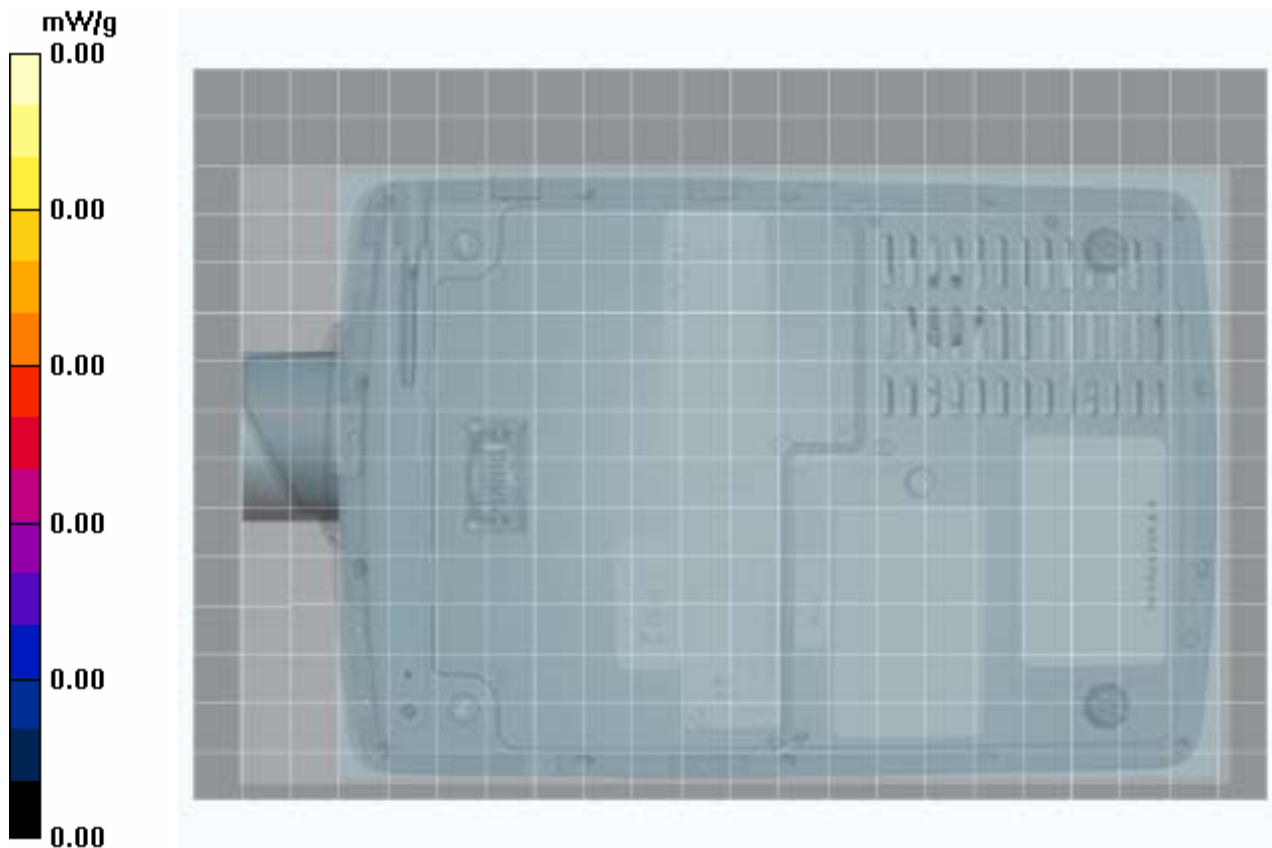

Fluid Depth ($\geq 15\text{cm}$)

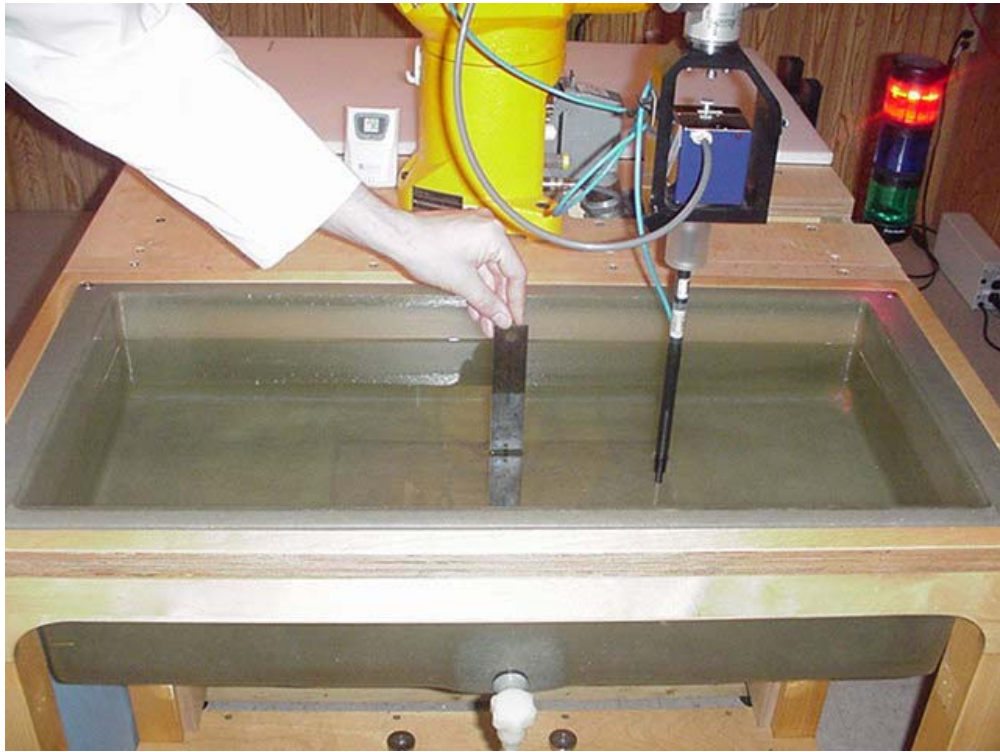

	Test Report Serial No.:	100305KBC-T673-S15W	Report Issue No.:	S673W-021306-R0
	Date(s) of Evaluation:	June 09, 2005	Report Issue Date:	February 13, 2006
	Type of Evaluation:	RF Exposure	SAR	FCC 47 CFR 2.1093

APPENDIX B - SYSTEM PERFORMANCE CHECK DATA

Applicant:	Itronix Corporation	FCC ID:	KBCIX325-AC580IWL	IC ID:	1943A-IX325f	
Model:	IX325-AC580IWL	Rugged Tablet PC with Intel Pro 2200BG 802.11b/g WLAN Mini-PCI Card				
2006 Celltech Labs Inc.	This document is not to be reproduced in whole or in part without the prior written permission of Celltech Labs Inc.					Page 20 of 32

Date Tested: 06/09/2005

System Performance Check (Brain) - 2450 MHz Dipole

DUT: Dipole 2450 MHz; Model: D2450V2; Type: System Performance Check; Serial: 150; Calibrated: 09/30/2004

Ambient Temp: 22.0 °C; Fluid Temp: 24.8 °C; Barometric Pressure: 101.7 kPa; Humidity: 38%

Communication System: CW
 Forward Conducted Power: 250 mW
 Frequency: 2450 MHz; Duty Cycle: 1:1
 Medium: HSL2450 ($\sigma = 1.87 \text{ mho/m}$; $\epsilon_r = 37.4$; $\rho = 1000 \text{ kg/m}^3$)

- Probe: ET3DV6 - SN1590; ConvF(4.56, 4.56, 4.56); Calibrated: 20/05/2005
- Sensor-Surface: 4mm (Mechanical And Optical Surface Detection)
- Electronics: DAE3 Sn370; Calibrated: 25/01/2005
- Phantom: SAM 4.0; Type: Fiberglass; Serial: 1033
- Measurement SW: DASY4, V4.5 Build 19; Postprocessing SW: SEMCAD, V1.8 Build 146

2450 MHz Dipole - System Performance Check/Area Scan (6x10x1):

Measurement grid: dx=10mm, dy=10mm

2450 MHz Dipole - System Performance Check/Zoom Scan (7x7x7)/Cube 0:

Measurement grid: dx=5mm, dy=5mm, dz=5mm
 Reference Value = 96.5 V/m; Power Drift = -0.025 dB
 Peak SAR (extrapolated) = 30.2 W/kg
SAR(1 g) = 13.9 mW/g; SAR(10 g) = 6.41 mW/g

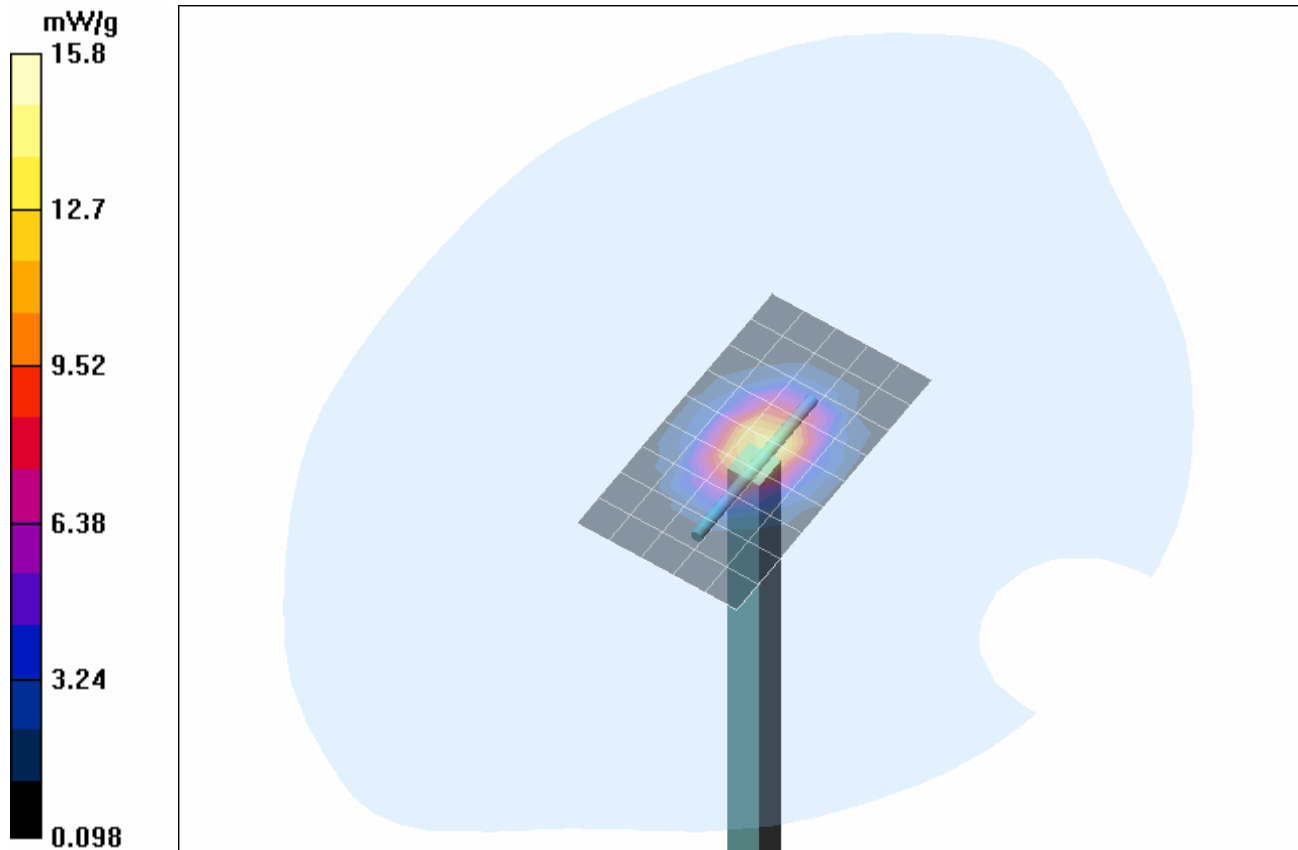

Z-Axis Scan

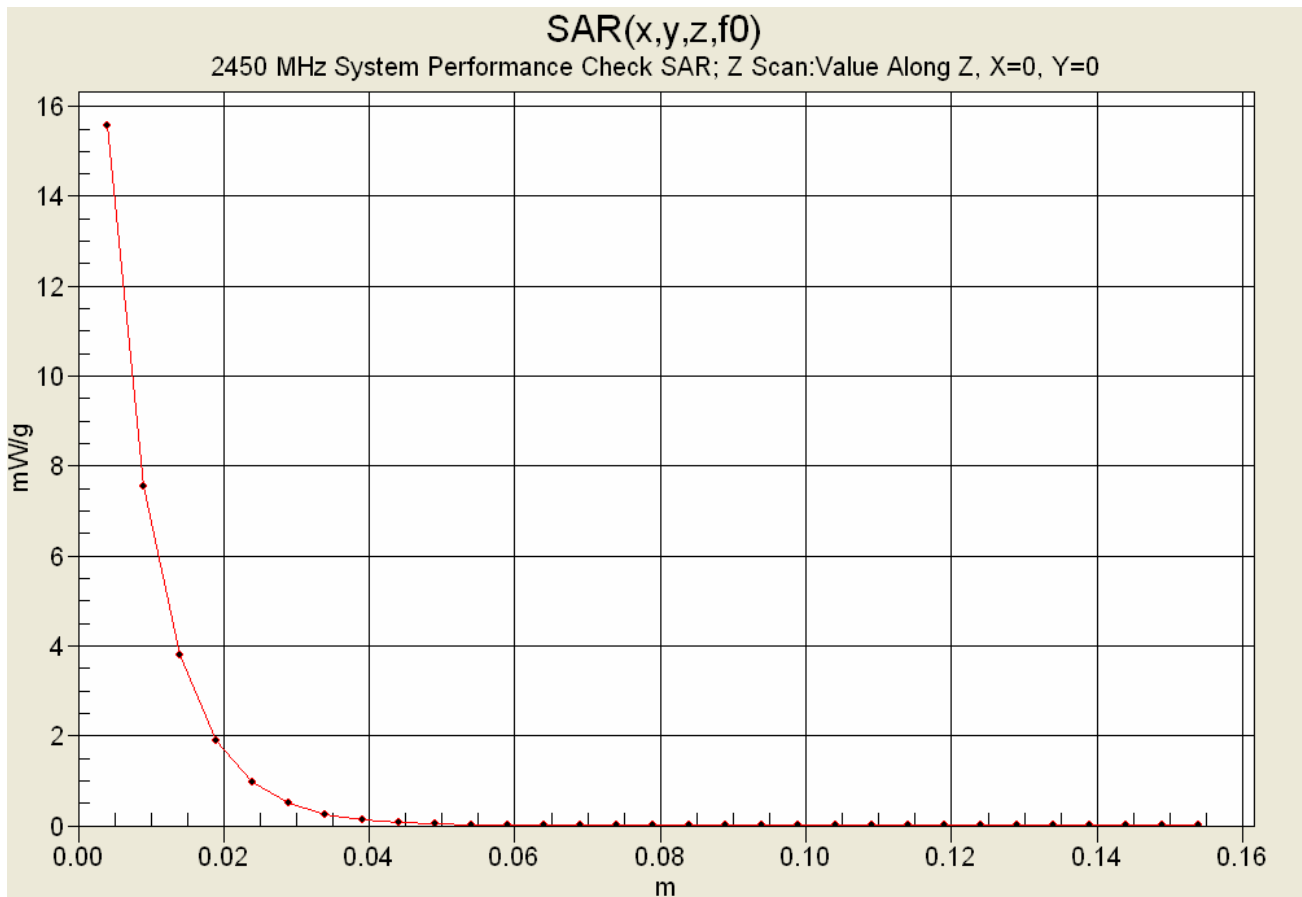

	Test Report Serial No.:	100305KBC-T673-S15W	Report Issue No.:	S673W-021306-R0
	Date(s) of Evaluation:	June 09, 2005	Report Issue Date:	February 13, 2006
	Type of Evaluation:	RF Exposure	SAR	FCC 47 CFR 2.1093

APPENDIX C - MEASURED FLUID DIELECTRIC PARAMETERS

Applicant:	Itronix Corporation	FCC ID:	KBCIX325-AC580IWL	IC ID:	1943A-IX325f	
Model:	IX325-AC580IWL	Rugged Tablet PC with Intel Pro 2200BG 802.11b/g WLAN Mini-PCI Card				
2006 Celltech Labs Inc.	This document is not to be reproduced in whole or in part without the prior written permission of Celltech Labs Inc.					Page 23 of 32



Test Report Serial No.:	100305KBC-T673-S15W	Report Issue No.:	S673W-021306-R0
Date(s) of Evaluation:	June 09, 2005	Report Issue Date:	February 13, 2006
Type of Evaluation:	RF Exposure	SAR	FCC 47 CFR 2.1093
			IC RSS-102 Issue 2

2450 MHz DUT Evaluation (Body)

Celltech Labs Inc.

Test Result for UIM Dielectric Parameter

Thu 09/Jun/2005

Freq Frequency(GHz)

FCC_eH FCC Bulletin 65 Supplement C (June 2001) Limits for Head Epsilon

FCC_sH FCC Bulletin 65 Supplement C (June 2001) Limits for Head Sigma

FCC_eB FCC Limits for Body Epsilon

FCC_sB FCC Limits for Body Sigma

Test_e Epsilon of UIM

Test_s Sigma of UIM

Freq	FCC_eB	FCC_sB	Test_e	Test_s
2.3500	52.83	1.85	51.45	1.82
2.3600	52.82	1.86	51.45	1.84
2.3700	52.81	1.87	51.37	1.87
2.3800	52.79	1.88	51.40	1.88
2.3900	52.78	1.89	51.26	1.90
2.4000	52.77	1.90	51.29	1.89
2.4100	52.75	1.91	51.19	1.93
2.4200	52.74	1.92	51.25	1.93
2.4300	52.73	1.93	51.33	1.96
2.4400	52.71	1.94	51.17	1.96
2.4500	52.70	1.95	51.23	1.99
2.4600	52.69	1.96	51.05	1.98
2.4700	52.67	1.98	50.99	2.00
2.4800	52.66	1.99	51.08	2.01
2.4900	52.65	2.01	50.82	2.04
2.5000	52.64	2.02	50.76	2.04
2.5100	52.62	2.04	50.83	2.06
2.5200	52.61	2.05	50.83	2.07
2.5300	52.60	2.06	50.72	2.08
2.5400	52.59	2.08	50.79	2.09
2.5500	52.57	2.09	50.79	2.11

Applicant:	Itronix Corporation	FCC ID:	KBCIX325-AC580IWL	IC ID:	1943A-IX325f	
Model:	IX325-AC580IWL	Rugged Tablet PC with Intel Pro 2200BG 802.11b/g WLAN Mini-PCI Card				
2006 Celltech Labs Inc.		This document is not to be reproduced in whole or in part without the prior written permission of Celltech Labs Inc.				Page 24 of 32



Test Report Serial No.:	100305KBC-T673-S15W	Report Issue No.:	S673W-021306-R0
Date(s) of Evaluation:	June 09, 2005	Report Issue Date:	February 13, 2006
Type of Evaluation:	RF Exposure	SAR	FCC 47 CFR 2.1093
			IC RSS-102 Issue 2

2450 MHz System Performance Check (Brain)

Celltech Labs Inc.

Test Result for UIM Dielectric Parameter

Thu 09/Jun/2005

Freq Frequency(GHz)

FCC_eH FCC OET 65 Supplement C (June 2001) Limits for Head Epsilon

FCC_sH FCC OET 65 Supplement C (June 2001) Limits for Head Sigma

Test_e Epsilon of UIM

Test_s Sigma of UIM

Freq	FCC_eH	FCC_sH	Test_e	Test_s
2.3500	39.38	1.71	38.04	1.75
2.3600	39.36	1.72	37.94	1.78
2.3700	39.34	1.73	37.91	1.78
2.3800	39.32	1.74	37.86	1.80
2.3900	39.31	1.75	37.74	1.82
2.4000	39.29	1.76	37.71	1.82
2.4100	39.27	1.76	37.74	1.84
2.4200	39.25	1.77	37.66	1.85
2.4300	39.24	1.78	37.56	1.84
2.4400	39.22	1.79	37.57	1.87
2.4500	39.20	1.80	37.44	1.87
2.4600	39.19	1.81	37.48	1.89
2.4700	39.17	1.82	37.30	1.90
2.4800	39.16	1.83	37.26	1.90
2.4900	39.15	1.84	37.15	1.92
2.5000	39.14	1.85	37.13	1.93
2.5100	39.12	1.87	37.08	1.94
2.5200	39.11	1.88	36.97	1.96
2.5300	39.10	1.89	37.02	1.96
2.5400	39.09	1.90	37.00	1.97
2.5500	39.07	1.91	36.89	1.99

	Test Report Serial No.:	100305KBC-T673-S15W	Report Issue No.:	S673W-021306-R0
	Date(s) of Evaluation:	June 09, 2005	Report Issue Date:	February 13, 2006
	Type of Evaluation:	RF Exposure	SAR	FCC 47 CFR 2.1093

APPENDIX D - SAR TEST SETUP PHOTOGRAPHS

Applicant:	Itronix Corporation	FCC ID:	KBCIX325-AC580IWL	IC ID:	1943A-IX325f	
Model:	IX325-AC580IWL	Rugged Tablet PC with Intel Pro 2200BG 802.11b/g WLAN Mini-PCI Card				
2006 Celltech Labs Inc.	This document is not to be reproduced in whole or in part without the prior written permission of Celltech Labs Inc.					Page 26 of 32

BODY SAR TEST SETUP PHOTOGRAPHS
0.0 cm Separation Distance from Bottom of DUT to Planar Phantom
Internal Lithium-ion Battery Pack (Model: T8M-E)

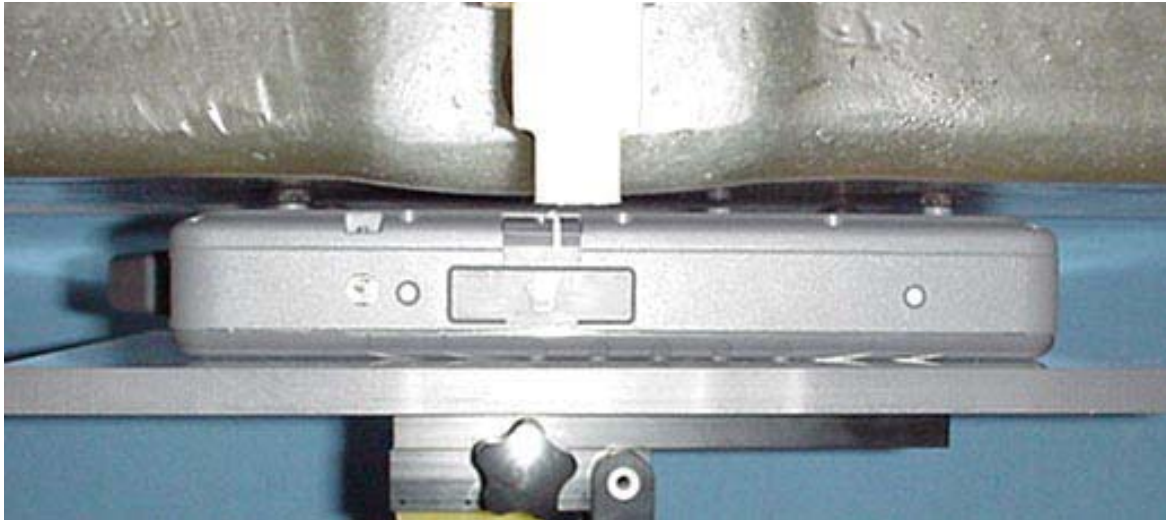

BODY SAR TEST SETUP PHOTOGRAPHS
0.0 cm Separation Distance from Bottom of DUT to Planar Phantom
75 W AC Power Adapter (Delta Electronics Model: ADP-75FB B)

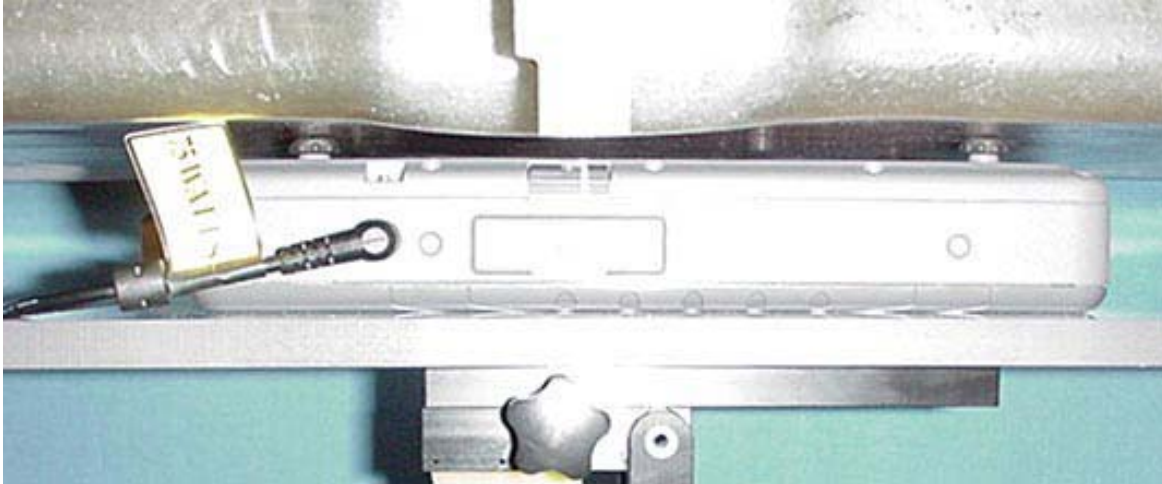

	Test Report Serial No.:	100305KBC-T673-S15W	Report Issue No.:	S673W-021306-R0
	Date(s) of Evaluation:	June 09, 2005	Report Issue Date:	February 13, 2006
	Type of Evaluation:	RF Exposure	SAR	FCC 47 CFR 2.1093

APPENDIX E - SYSTEM VALIDATION

Applicant:	Itronix Corporation	FCC ID:	KBCIX325-AC580IWL	IC ID:	1943A-IX325f	
Model:	IX325-AC580IWL	Rugged Tablet PC with Intel Pro 2200BG 802.11b/g WLAN Mini-PCI Card				
2006 Celltech Labs Inc.	This document is not to be reproduced in whole or in part without the prior written permission of Celltech Labs Inc.					Page 29 of 32

2450 MHz SYSTEM VALIDATION DIPOLE

Type:

2450 MHz Validation Dipole

Serial Number:

150

Place of Calibration:

Celltech Labs Inc.

Date of Calibration:

September 30, 2004

Celltech Labs Inc. hereby certifies that this device has been calibrated on the date indicated above.

Calibrated by:

Spencer Watson

Approved by:

Russell W. Pipe

1. Dipole Construction & Electrical Characteristics

The validation dipole was constructed in accordance with the IEEE Std “Recommended Practice for Determining the Spatial-Peak Specific Absorption Rate (SAR) in the Human Body Due to Wireless Communications Devices: Experimental Techniques”. The electrical properties were measured using an HP 8753E Network Analyzer. The network analyzer was calibrated to the validation dipole N-type connector feed point using an HP85032E Type N calibration kit. The dipole was placed parallel to a planar phantom at a separation distance of 10.0mm from the simulating fluid using a loss-less dielectric spacer. The measured input impedance is:

Feed point impedance at 2450 MHz	$\text{Re}\{Z\} = 48.246\Omega$
	$\text{Im}\{Z\} = 1.0996\Omega$
Return Loss at 2450 MHz	-33.519 dB

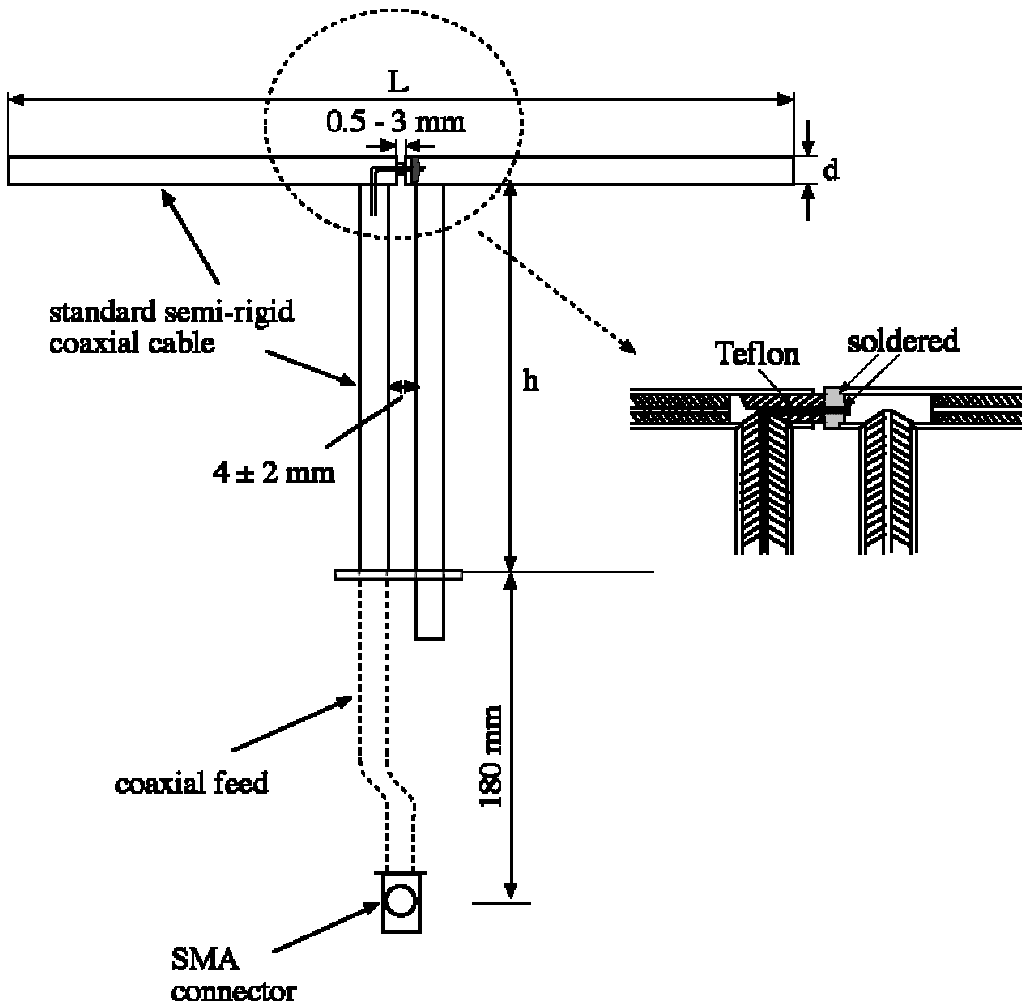

30 Sep 2004 16:28:38

[CH1] MEM LOG 10 dB/REF 0 dB

1:-33.519 dB 2 450.000 000 MHz

PRm

Cor

↑

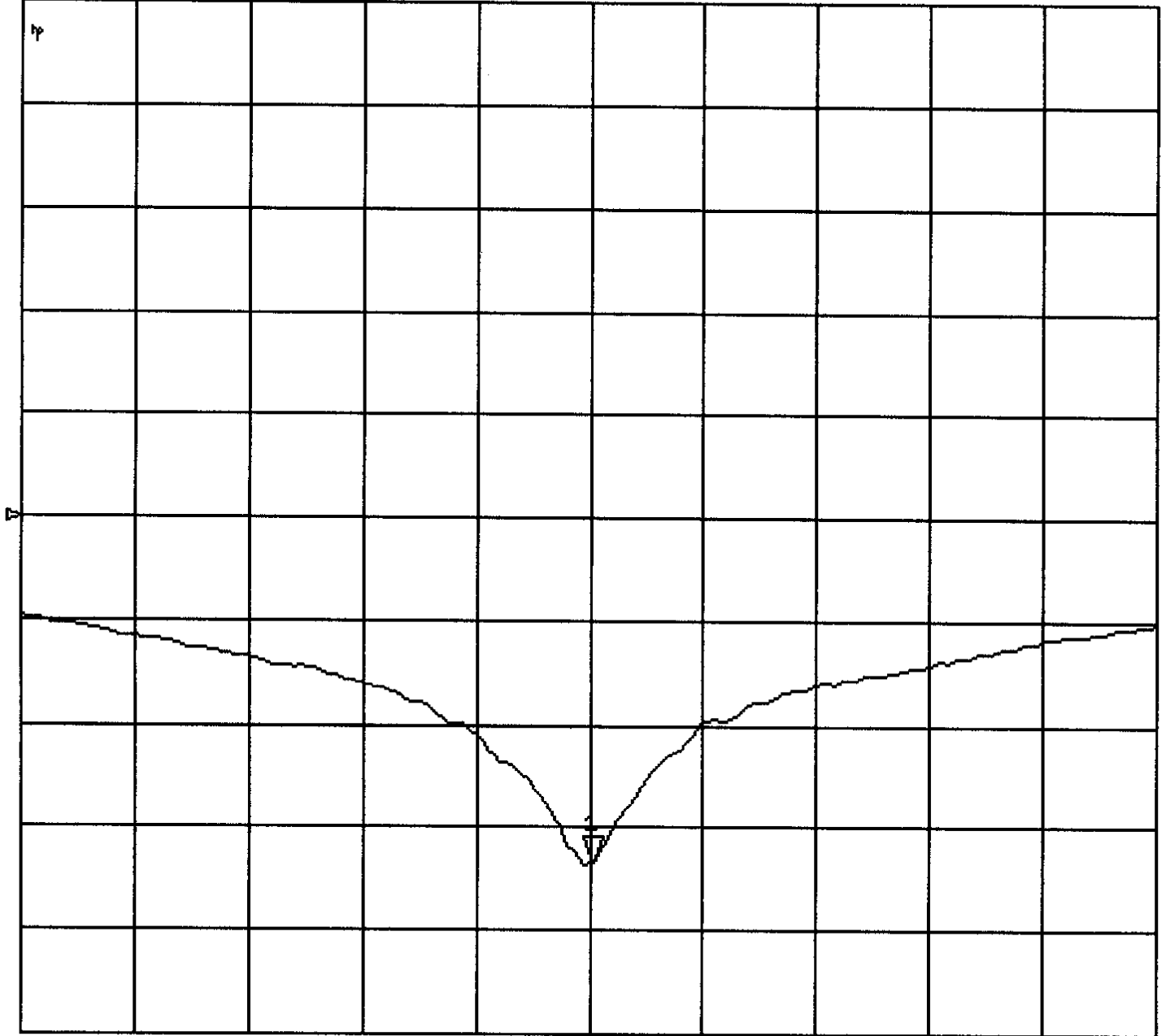

CENTER 2 450.000 000 MHz

SPAN 400.000 000 MHz

2. Validation Dipole Dimensions

Frequency (MHz)	L (mm)	h (mm)	d (mm)
300	420.0	250.0	6.2
450	288.0	167.0	6.2
835	161.0	89.8	3.6
900	149.0	83.3	3.6
1450	89.1	51.7	3.6
1800	72.0	41.7	3.6
1900	68.0	39.5	3.6
2000	64.5	37.5	3.6
2450	51.8	30.6	3.6
3000	41.5	25.0	3.6

3. Validation Phantom

The validation phantom is the SAM (Specific Anthropomorphic Mannequin) phantom manufactured by Schmid & Partner Engineering AG. The SAM phantom is a Fiberglass shell integrated in a wooden table. The shape of the shell corresponds to the phantom defined by SCC34-SC2. It enables the dosimetric evaluation of left and right hand phone usage as well as body mounted usage at the flat phantom region. A cover prevents evaporation of the liquid. Reference markings on the phantom allow the complete setup of all predefined phantom positions and measurement grids by manually teaching three points in the robot.

Shell Thickness: 2.0 ± 0.1 mm
Filling Volume: Approx. 25 liters
Dimensions: 50 cm (W) x 100 cm (L)

4. 2450 MHz System Validation Setup



5. 2450 MHz Dipole Setup



6. Measurement Conditions

The phantom was filled with brain simulating tissue having the following electrical parameters at 2450 MHz:

Relative Permittivity: 38.5
 Conductivity: 1.86 mho/m
 Fluid Temperature: 23.7 °C
 Fluid Depth: ≥ 15.0 cm

Environmental Conditions:

Ambient Temperature: 25.3 °C
 Humidity: 32 %
 Barometric Pressure: 102.7 kPa

The 2450 MHz simulated brain tissue mixture consists of the following ingredients:

Ingredient	Percentage by weight
Water	52.00%
Glycol Monobutyl	48.00%
Target Dielectric Parameters at 22°C	$\epsilon_r = 39.2 (+/-5\%)$ $\sigma = 1.80 \text{ S/m } (+/-5\%)$

7. SAR Measurement

The SAR measurement was performed with the E-field probe in mechanical detection mode only. The setup and determination of the forward power into the dipole was performed using the following procedures.

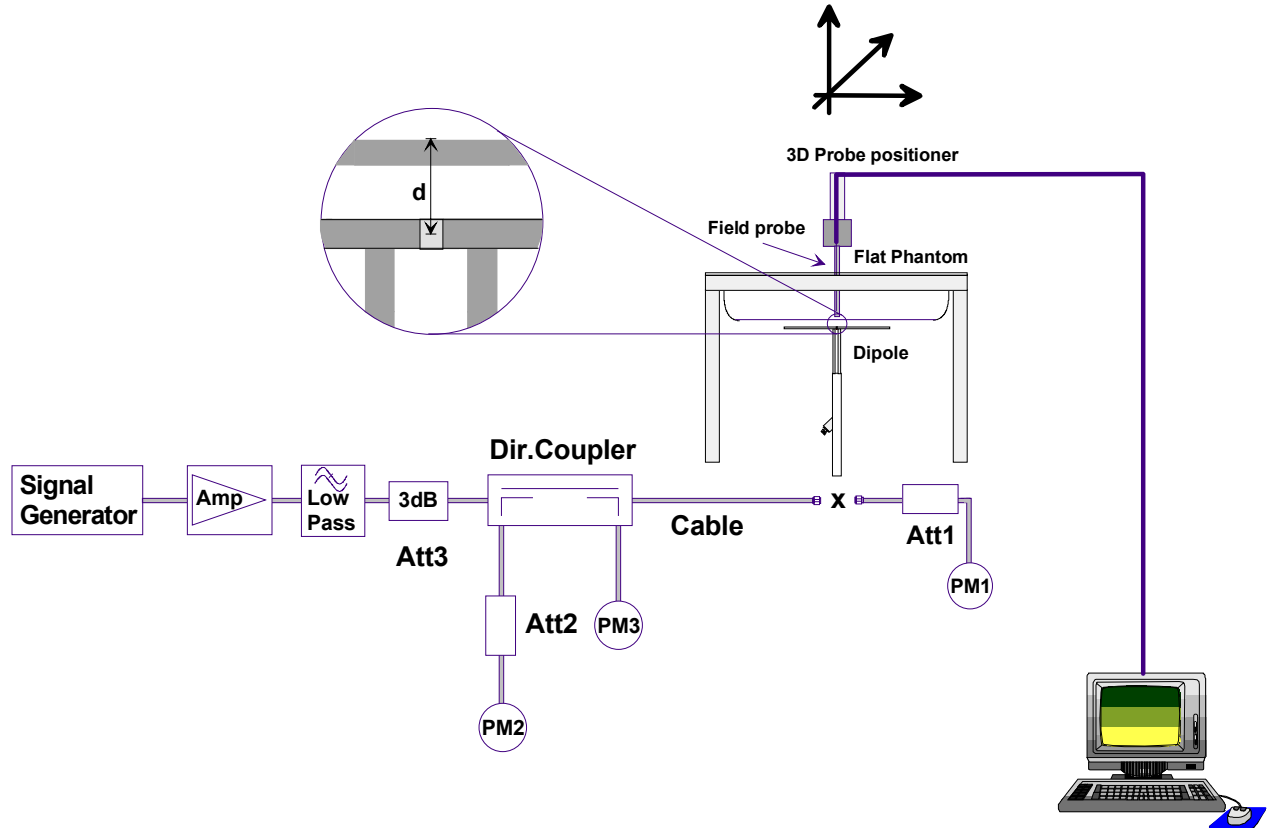

First, the power meter PM1 (including attenuator Att1) is connected to the cable to measure the forward power at the location of the dipole connector (X). The signal generator is adjusted for the desired forward power at the dipole connector (taking into account the attenuation of Att1) as read by power meter PM2. After connecting the cable to the dipole, the signal generator is readjusted for the same reading at power meter PM2. If the signal generator does not allow adjustment in 0.01dB steps, the remaining difference at PM2 must be taken into consideration. PM3 records the reflected power from the dipole to ensure that the value is not changed from the previous value. The reflected power should be 20dB below the forward power.

8. Validation Dipole SAR Test Results

Ten SAR measurements were performed in order to achieve repeatability and to establish an average target value.

Validation Measurement	SAR @ 0.25W Input averaged over 1g	SAR @ 1W Input averaged over 1g	SAR @ 0.25W Input averaged over 10g	SAR @ 1W Input averaged over 10g	Peak SAR @ 0.25W Input
Test 1	14.2	56.8	6.58	26.32	30.4
Test 2	14.1	56.4	6.54	26.16	30.2
Test 3	14.1	56.4	6.54	26.16	30.4
Test 4	14.1	56.4	6.51	26.04	30.6
Test 5	14.0	56.0	6.51	26.04	29.8
Test 6	14.0	56.0	6.49	25.96	29.6
Test 7	14.1	56.4	6.54	26.16	30.0
Test 8	14.1	56.4	6.53	26.12	30.1
Test 9	14.0	56.0	6.50	26.00	29.8
Test10	14.0	56.0	6.47	25.88	30.0
Average Value	14.07	56.28	6.52	26.08	30.09

The results have been normalized to 1W (forward power) into the dipole.

IEEE Target over 1cm³ (1g) of tissue: 52.4 mW/g (+/- 10%)

Averaged over 1cm (1g) of tissue: 56.28 mW/g (+ 7.4% deviation)

IEEE Target over 10cm³ (10g) of tissue: 24.0 mW/g (+/- 10%)

Averaged over 10cm (10g) of tissue: 26.08 mW/g (+ 8.7% deviation)

2540 MHz System Validation - September 30, 2004

DUT: Dipole 2450 MHz; Model: D2450V2; Serial: 150; Calibrated: 09/30/2004

Ambient Temp: 25.3 °C; Fluid Temp: 23.7 °C; Barometric Pressure: 102.7 kPa; Humidity: 32%

Communication System: CW

Frequency: 2450 MHz; Duty Cycle: 1:1

Medium: HSL2450 ($\sigma = 1.86$ mho/m; $\epsilon_r = 38.5$; $\rho = 1000$ kg/m³)

- Probe: ET3DV6 - SN1590; ConvF(4.44, 4.44, 4.44); Calibrated: 24/05/2004

- Sensor-Surface: 4mm (Mechanical And Optical Surface Detection)

- Electronics: DAE3 Sn370; Calibrated: 14/05/2004

- Phantom: SAM 4.0; Type: Fiberglass; Serial: 1033

- Measurement SW: DASY4, V4.3 Build 22; Postprocessing SW: SEMCAD, V1.8 Build 127

2450 MHz System Validation/Area Scan (6x10x1): Measurement grid: dx=10mm, dy=10mm

2450 MHz System Validation/Zoom Scan (7x7x7)/Cube 0: Measurement grid: dx=5mm, dy=5mm, dz=5mm

Reference Value = 96.9 V/m; Power Drift = 0.0 dB

Peak SAR (extrapolated) = 30.4 W/kg

SAR(1 g) = 14.2 mW/g; SAR(10 g) = 6.58 mW/g

2450 MHz System Validation/Zoom Scan 2 (7x7x7)/Cube 0: Measurement grid: dx=5mm, dy=5mm, dz=5mm

Reference Value = 96.9 V/m; Power Drift = -0.002 dB

Peak SAR (extrapolated) = 30.2 W/kg

SAR(1 g) = 14.1 mW/g; SAR(10 g) = 6.54 mW/g

2450 MHz System Validation/Zoom Scan 3 (7x7x7)/Cube 0: Measurement grid: dx=5mm, dy=5mm, dz=5mm

Reference Value = 96.5 V/m; Power Drift = -0.001 dB

Peak SAR (extrapolated) = 30.4 W/kg

SAR(1 g) = 14.1 mW/g; SAR(10 g) = 6.54 mW/g

2450 MHz System Validation/Zoom Scan 4 (7x7x7)/Cube 0: Measurement grid: dx=5mm, dy=5mm, dz=5mm

Reference Value = 94.1 V/m; Power Drift = 0.008 dB

Peak SAR (extrapolated) = 30.6 W/kg

SAR(1 g) = 14.1 mW/g; SAR(10 g) = 6.51 mW/g

2450 MHz System Validation/Zoom Scan 5 (7x7x7)/Cube 0: Measurement grid: dx=5mm, dy=5mm, dz=5mm

Reference Value = 96.9 V/m; Power Drift = -0.009 dB

Peak SAR (extrapolated) = 29.8 W/kg

SAR(1 g) = 14.0 mW/g; SAR(10 g) = 6.51 mW/g

2450 MHz System Validation/Zoom Scan 6 (7x7x7)/Cube 0: Measurement grid: dx=5mm, dy=5mm, dz=5mm

Reference Value = 96.4 V/m; Power Drift = -0.0 dB

Peak SAR (extrapolated) = 29.6 W/kg

SAR(1 g) = 14.0 mW/g; SAR(10 g) = 6.49 mW/g

2450 MHz System Validation/Zoom Scan 7 (7x7x7)/Cube 0: Measurement grid: dx=5mm, dy=5mm, dz=5mm

Reference Value = 96.4 V/m; Power Drift = -0.008 dB

Peak SAR (extrapolated) = 30 W/kg

SAR(1 g) = 14.1 mW/g; SAR(10 g) = 6.54 mW/g

2450 MHz System Validation/Zoom Scan 8 (7x7x7)/Cube 0: Measurement grid: dx=5mm, dy=5mm, dz=5mm

Reference Value = 96.4 V/m; Power Drift = -0.004 dB

Peak SAR (extrapolated) = 30.1 W/kg

SAR(1 g) = 14.1 mW/g; SAR(10 g) = 6.53 mW/g

2450 MHz System Validation/Zoom Scan 9 (7x7x7)/Cube 0: Measurement grid: dx=5mm, dy=5mm, dz=5mm

Reference Value = 96.3 V/m; Power Drift = -0.0 dB

Peak SAR (extrapolated) = 29.8 W/kg

SAR(1 g) = 14.0 mW/g; SAR(10 g) = 6.5 mW/g

2450 MHz System Validation/Zoom Scan 10 (7x7x7)/Cube 0: Measurement grid: dx=5mm, dy=5mm, dz=5mm

Reference Value = 96.4 V/m; Power Drift = -0.1 dB

Peak SAR (extrapolated) = 30 W/kg

SAR(1 g) = 14.0 mW/g; SAR(10 g) = 6.47 mW/g

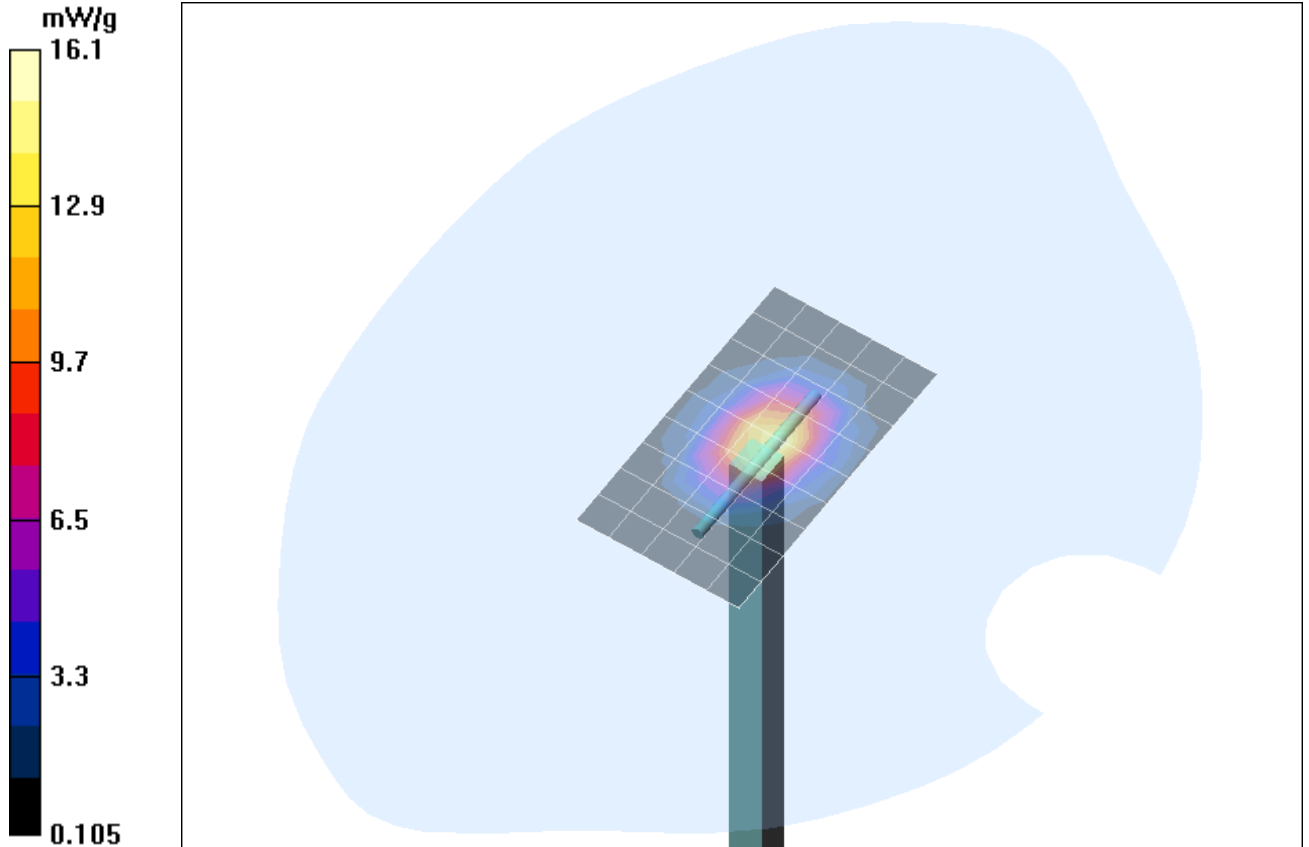

1 g average of 10 measurements: 14.07 mW/g
10 g average of 10 measurements: 6.521 mW/g

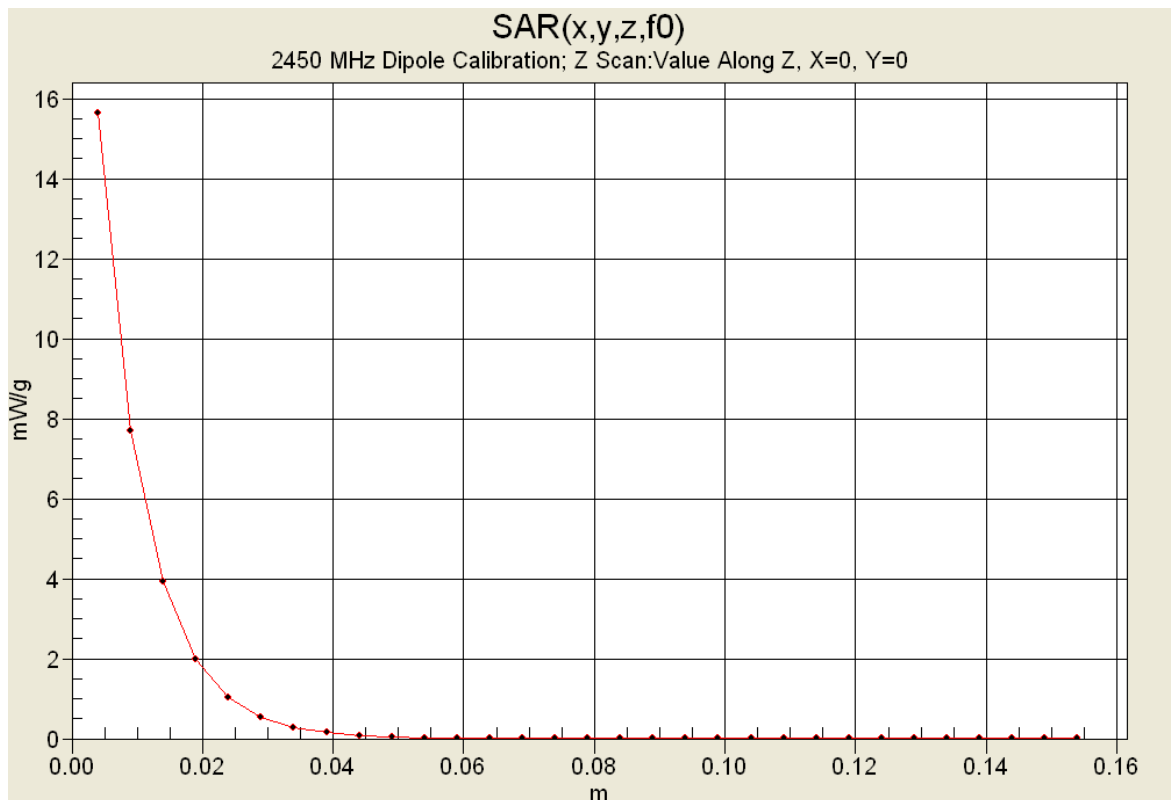

2450 MHz System Validation

Measured Fluid Dielectric Parameters (Brain)

September 30, 2004

Frequency	ϵ'	ϵ''
2.350000000 GHz	38.9044	13.2920
2.360000000 GHz	38.8598	13.3262
2.370000000 GHz	38.8346	13.3589
2.380000000 GHz	38.7702	13.3903
2.390000000 GHz	38.7465	13.4360
2.400000000 GHz	38.6987	13.4546
2.410000000 GHz	38.6553	13.4975
2.420000000 GHz	38.6023	13.5376
2.430000000 GHz	38.5771	13.5800
2.440000000 GHz	38.5403	13.6072
2.450000000 GHz	38.5010	13.6535
2.460000000 GHz	38.4824	13.6770
2.470000000 GHz	38.4488	13.7080
2.480000000 GHz	38.4153	13.7445
2.490000000 GHz	38.3700	13.7692
2.500000000 GHz	38.3378	13.7887
2.510000000 GHz	38.2798	13.8028
2.520000000 GHz	38.2288	13.8500
2.530000000 GHz	38.1683	13.8945
2.540000000 GHz	38.1113	13.9420
2.550000000 GHz	38.0791	13.9851

	Test Report Serial No.:	100305KBC-T673-S15W	Report Issue No.:	S673W-021306-R0
	Date(s) of Evaluation:	June 09, 2005	Report Issue Date:	February 13, 2006
	Type of Evaluation:	RF Exposure	SAR	FCC 47 CFR 2.1093

APPENDIX F - PROBE CALIBRATION

Applicant:	Itronix Corporation	FCC ID:	KBCIX325-AC580IWL	IC ID:	1943A-IX325f	
Model:	IX325-AC580IWL	Rugged Tablet PC with Intel Pro 2200BG 802.11b/g WLAN Mini-PCI Card				
2006 Celltech Labs Inc.	This document is not to be reproduced in whole or in part without the prior written permission of Celltech Labs Inc.					Page 30 of 32



Accredited by the Swiss Federal Office of Metrology and Accreditation
The Swiss Accreditation Service is one of the signatories to the EA
Multilateral Agreement for the recognition of calibration certificates

Accreditation No.: **SCS 108**

Client **Celltech**

Certificate No: **ET3-1590_May05**

CALIBRATION CERTIFICATE

Object **ET3DV6 - SN:1590**

Calibration procedure(s) **QA CAL-01.v5
Calibration procedure for dosimetric E-field probes**

Calibration date: **May 20, 2005**

Condition of the calibrated item **In Tolerance**

This calibration certificate documents the traceability to national standards, which realize the physical units of measurements (SI).
The measurements and the uncertainties with confidence probability are given on the following pages and are part of the certificate.

All calibrations have been conducted in the closed laboratory facility: environment temperature $(22 \pm 3)^\circ\text{C}$ and humidity $< 70\%$.

Calibration Equipment used (M&TE critical for calibration)

Primary Standards	ID #	Cal Date (Calibrated by, Certificate No.)	Scheduled Calibration
Power meter E4419B	GB41293874	3-May-05 (METAS, No. 251-00466)	May-06
Power sensor E4412A	MY41495277	3-May-05 (METAS, No. 251-00466)	May-06
Power sensor E4412A	MY41498087	3-May-05 (METAS, No. 251-00466)	May-06
Reference 3 dB Attenuator	SN: S5054 (3c)	10-Aug-04 (METAS, No. 251-00403)	Aug-05
Reference 20 dB Attenuator	SN: S5086 (20b)	3-May-05 (METAS, No. 251-00467)	May-06
Reference 30 dB Attenuator	SN: S5129 (30b)	10-Aug-04 (METAS, No. 251-00404)	Aug-05
Reference Probe ES3DV2	SN: 3013	7-Jan-05 (SPEAG, No. ES3-3013_Jan05)	Jan-06
DAE4	SN: 617	19-Jan-05 (SPEAG, No. DAE4-617_Jan05)	Jan-06
Secondary Standards	ID #	Check Date (in house)	Scheduled Check
RF generator HP 8648C	US3642U01700	4-Aug-99 (SPEAG, in house check Dec-03)	In house check: Dec-05
Network Analyzer HP 8753E	US37390585	18-Oct-01 (SPEAG, in house check Nov-04)	In house check: Nov 05

Calibrated by: **Nico Vetterli** Function: **Laboratory Technician** Signature:

Approved by: **Katja Pokovic** Technical Manager

Issued: May 21, 2005

This calibration certificate shall not be reproduced except in full without written approval of the laboratory.



Accredited by the Swiss Federal Office of Metrology and Accreditation
The Swiss Accreditation Service is one of the signatories to the EA
Multilateral Agreement for the recognition of calibration certificates

Accreditation No.: **SCS 108**

Glossary:

TSL	tissue simulating liquid
NORM _{x,y,z}	sensitivity in free space
ConF	sensitivity in TSL / NORM _{x,y,z}
DCP	diode compression point
Polarization φ	φ rotation around probe axis
Polarization ϑ	ϑ rotation around an axis that is in the plane normal to probe axis (at measurement center), i.e., $\vartheta = 0$ is normal to probe axis

Calibration is Performed According to the Following Standards:

- IEEE Std 1528-2003, "IEEE Recommended Practice for Determining the Peak Spatial-Averaged Specific Absorption Rate (SAR) in the Human Head from Wireless Communications Devices: Measurement Techniques", December 2003
- CENELEC EN 50361, "Basic standard for the measurement of Specific Absorption Rate related to human exposure to electromagnetic fields from mobile phones (300 MHz - 3 GHz), July 2001

Methods Applied and Interpretation of Parameters:

- NORM_{x,y,z}**: Assessed for E-field polarization $\vartheta = 0$ ($f \leq 900$ MHz in TEM-cell; $f > 1800$ MHz: R22 waveguide). NORM_{x,y,z} are only intermediate values, i.e., the uncertainties of NORM_{x,y,z} does not effect the E^2 -field uncertainty inside TSL (see below *ConvF*).
- NORM(f)_{x,y,z}** = NORM_{x,y,z} * *frequency_response* (see Frequency Response Chart). This linearization is implemented in DASY4 software versions later than 4.2. The uncertainty of the frequency response is included in the stated uncertainty of *ConvF*.
- DCP_{x,y,z}**: DCP are numerical linearization parameters assessed based on the data of power sweep (no uncertainty required). DCP does not depend on frequency nor media.
- ConvF and Boundary Effect Parameters**: Assessed in flat phantom using E-field (or Temperature Transfer Standard for $f \leq 800$ MHz) and inside waveguide using analytical field distributions based on power measurements for $f > 800$ MHz. The same setups are used for assessment of the parameters applied for boundary compensation (alpha, depth) of which typical uncertainty values are given. These parameters are used in DASY4 software to improve probe accuracy close to the boundary. The sensitivity in TSL corresponds to NORM_{x,y,z} * *ConvF* whereby the uncertainty corresponds to that given for *ConvF*. A frequency dependent *ConvF* is used in DASY version 4.4 and higher which allows extending the validity from ± 50 MHz to ± 100 MHz.
- Spherical isotropy (3D deviation from isotropy)**: in a field of low gradients realized using a flat phantom exposed by a patch antenna.
- Sensor Offset**: The sensor offset corresponds to the offset of virtual measurement center from the probe tip (on probe axis). No tolerance required.

Probe ET3DV6

SN:1590

Manufactured:	March 19, 2001
Last calibrated:	May 24, 2004
Recalibrated:	May 20, 2005

Calibrated for DASY Systems

(Note: non-compatible with DASY2 system!)

DASY - Parameters of Probe: ET3DV6 SN:1590

Sensitivity in Free Space^A

Diode Compression^B

NormX	1.82 ± 10.1%	$\mu\text{V}/(\text{V}/\text{m})^2$	DCP X	87 mV
NormY	1.97 ± 10.1%	$\mu\text{V}/(\text{V}/\text{m})^2$	DCP Y	87 mV
NormZ	1.70 ± 10.1%	$\mu\text{V}/(\text{V}/\text{m})^2$	DCP Z	87 mV

Sensitivity in Tissue Simulating Liquid (Conversion Factors)

Please see Page 8.

Boundary Effect

TSL **900 MHz** **Typical SAR gradient: 5 % per mm**

Sensor Center to Phantom Surface Distance		3.7 mm	4.7 mm
SAR _{be} [%]	Without Correction Algorithm	7.6	3.9
SAR _{be} [%]	With Correction Algorithm	0.1	0.2

TSL **1810 MHz** **Typical SAR gradient: 10 % per mm**

Sensor Center to Phantom Surface Distance		3.7 mm	4.7 mm
SAR _{be} [%]	Without Correction Algorithm	11.8	8.3
SAR _{be} [%]	With Correction Algorithm	0.6	0.1

Sensor Offset

Probe Tip to Sensor Center **2.7 mm**

The reported uncertainty of measurement is stated as the standard uncertainty of measurement multiplied by the coverage factor k=2, which for a normal distribution corresponds to a coverage probability of approximately 95%.

^A The uncertainties of NormX,Y,Z do not affect the E²-field uncertainty inside TSL (see Page 8).

^B Numerical linearization parameter: uncertainty not required.

Frequency Response of E-Field

(TEM-Cell:ifi110 EXX, Waveguide: R22)

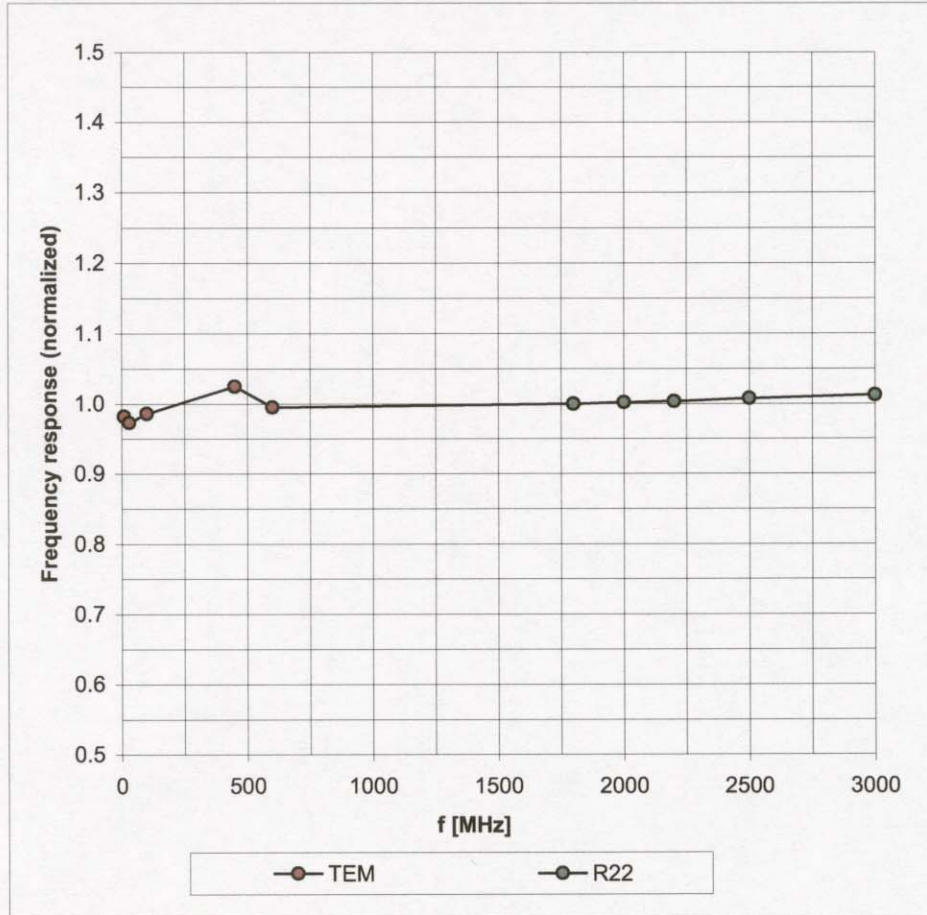

Uncertainty of Frequency Response of E-field: $\pm 6.3\%$ ($k=2$)

Receiving Pattern (ϕ), $\vartheta = 0^\circ$

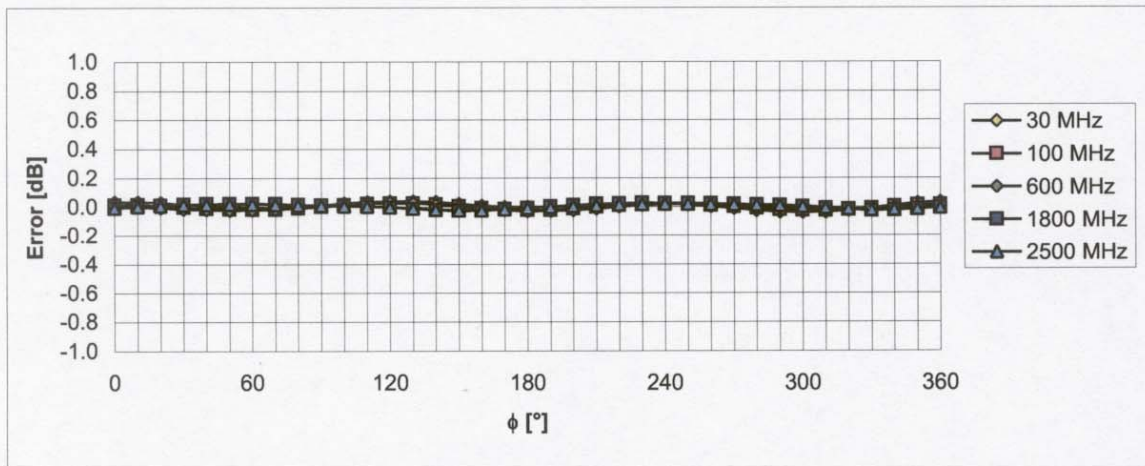
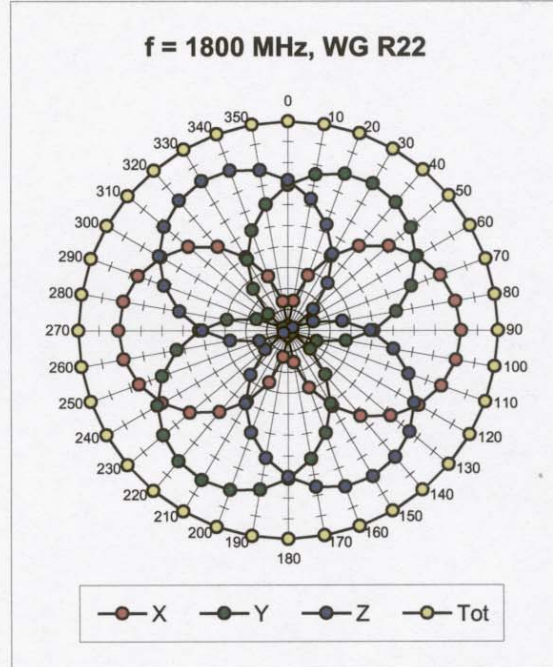
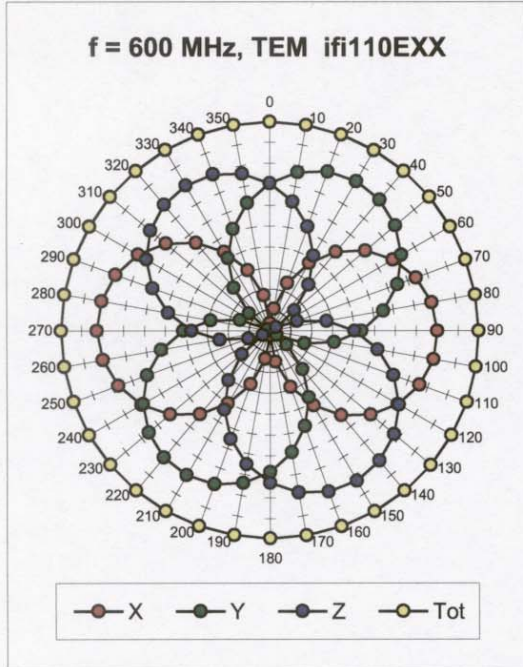

Uncertainty of Axial Isotropy Assessment: $\pm 0.5\%$ (k=2)

Dynamic Range f(SAR_{head}) (Waveguide R22, f = 1800 MHz)

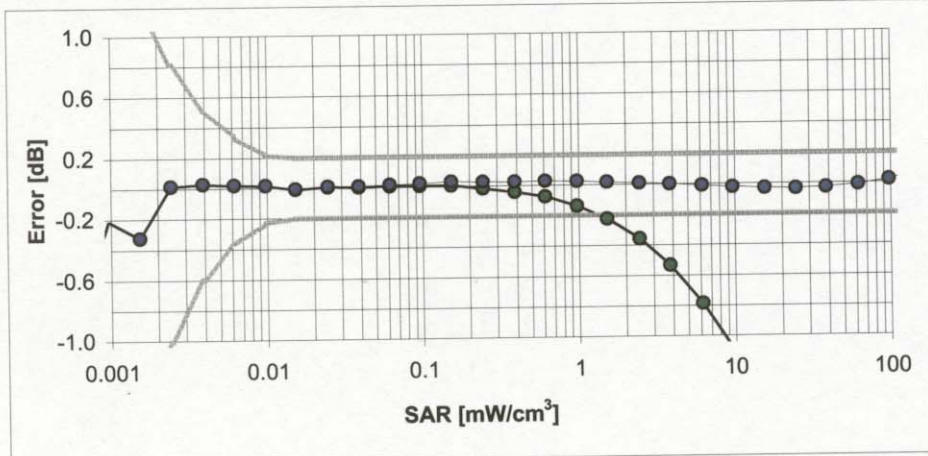
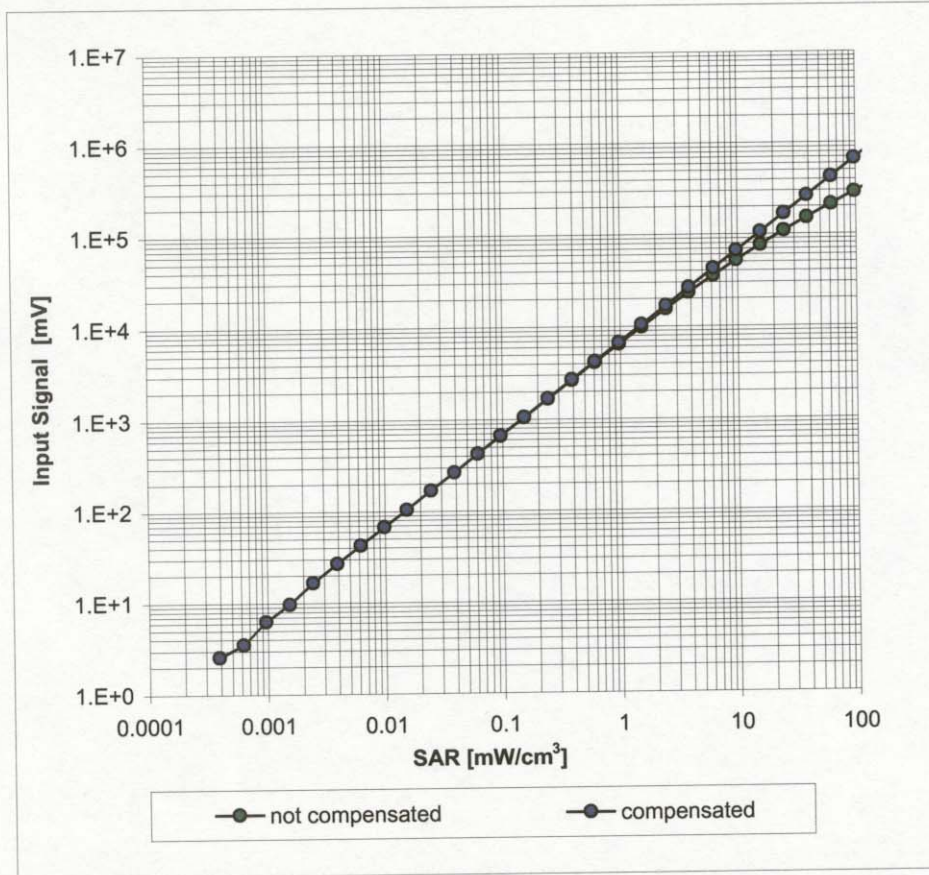

Uncertainty of Linearity Assessment: ± 0.6% (k=2)

Conversion Factor Assessment

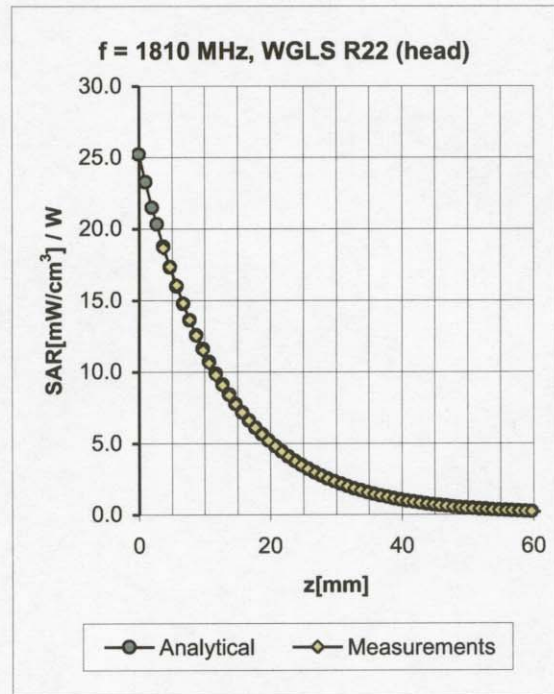
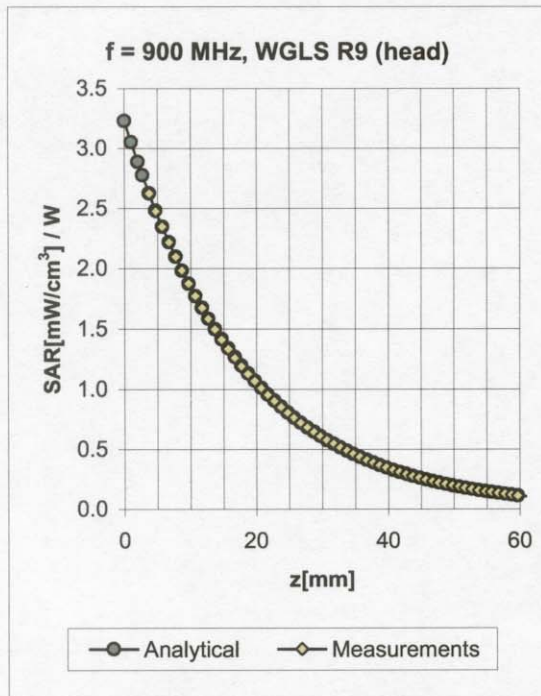

f [MHz]	Validity [MHz] ^c	TSL	Permittivity	Conductivity	Alpha	Depth	ConvF Uncertainty
900	± 50 / ± 100	Head	41.5 ± 5%	0.97 ± 5%	0.54	1.81	6.67 ± 11.0% (k=2)
1810	± 50 / ± 100	Head	40.0 ± 5%	1.40 ± 5%	0.46	2.62	5.44 ± 11.0% (k=2)
2450	± 50 / ± 100	Head	39.2 ± 5%	1.80 ± 5%	0.50	2.53	4.56 ± 11.8% (k=2)
900	± 50 / ± 100	Body	55.0 ± 5%	1.05 ± 5%	0.46	2.09	6.47 ± 11.0% (k=2)
1810	± 50 / ± 100	Body	53.3 ± 5%	1.52 ± 5%	0.44	3.00	4.85 ± 11.0% (k=2)
2450	± 50 / ± 100	Body	52.7 ± 5%	1.95 ± 5%	0.50	2.42	4.22 ± 11.8% (k=2)

^c The validity of ± 100 MHz only applies for DASY v4.4 and higher (see Page 2). The uncertainty is the RSS of the ConvF uncertainty at calibration frequency and the uncertainty for the indicated frequency band.

Deviation from Isotropy in HSL

Error (ϕ, ϑ), $f = 900$ MHz

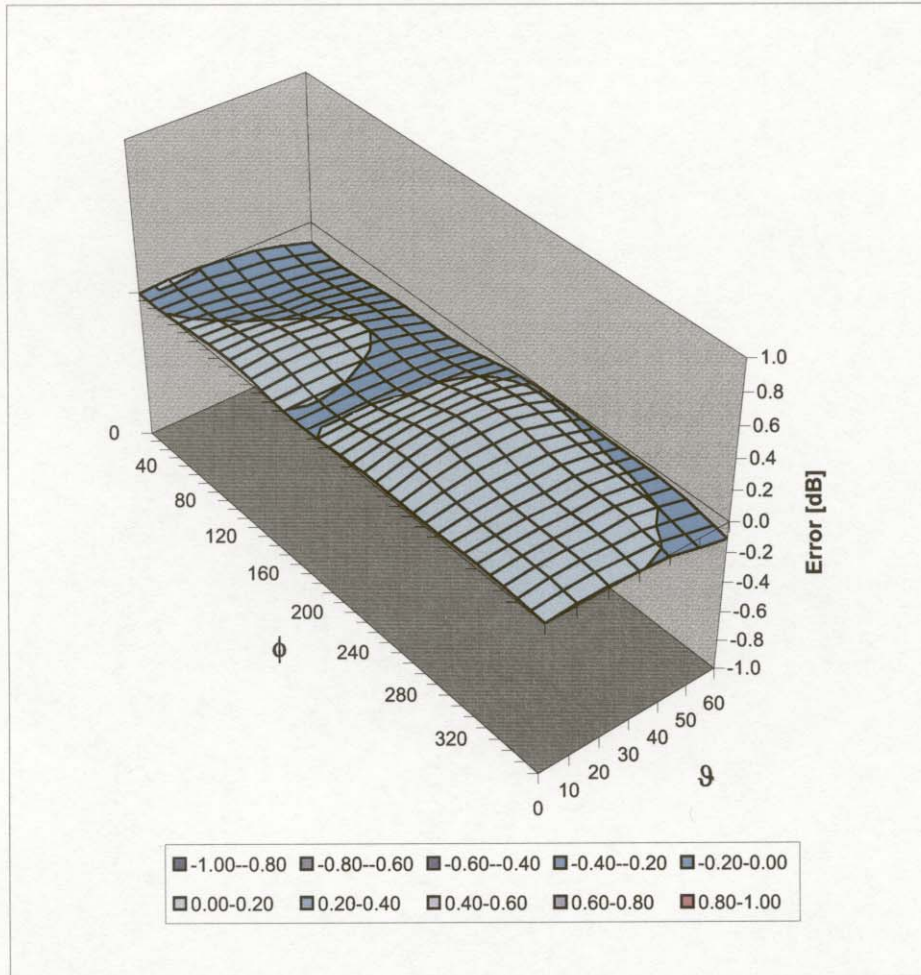

Uncertainty of Spherical Isotropy Assessment: $\pm 2.6\%$ ($k=2$)

Additional Conversion Factors for Dosimetric E-Field Probe

Type:

ET3DV6

Serial Number:

1590

Place of Assessment:

Zurich

Date of Assessment:

May 23, 2005

Probe Calibration Date:

May 20, 2005

Schmid & Partner Engineering AG hereby certifies that conversion factor(s) of this probe have been evaluated on the date indicated above. The assessment was performed using the FDTD numerical code SEMCAD of Schmid & Partner Engineering AG. Since the evaluation is coupled with measured conversion factors, it has to be recalculated yearly, i.e., following the re-calibration schedule of the probe. The uncertainty of the numerical assessment is based on the extrapolation from measured value at 900 MHz or at 1800 MHz.

Assessed by:

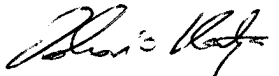

Dosimetric E-Field Probe ET3DV6 SN:1590

Conversion factor (\pm standard deviation)

f = 150 MHz	ConvF	9.1 \pm 10%	$\epsilon_r = 52.3 \pm 5\%$ $\sigma = 0.76 \pm 5\%$ mho/m (head tissue)
f = 300 MHz	ConvF	8.1 \pm 9%	$\epsilon_r = 45.3 \pm 5\%$ $\sigma = 0.87 \pm 5\%$ mho/m (head tissue)
f = 450 MHz	ConvF	7.8 \pm 8%	$\epsilon_r = 43.5 \pm 5\%$ $\sigma = 0.87 \pm 5\%$ mho/m (head tissue)
f = 150 MHz	ConvF	8.6 \pm 10%	$\epsilon_r = 61.9 \pm 5\%$ $\sigma = 0.80 \pm 5\%$ mho/m (body tissue)
f = 450 MHz	ConvF	7.7 \pm 8%	$\epsilon_r = 56.7 \pm 5\%$ $\sigma = 0.94 \pm 5\%$ mho/m (body tissue)

Important Note:

For numerically assessed probe conversion factors, parameters Alpha and Delta in the DASY software must have the following entries: Alpha = 0 and Delta = 1.

Please see also Section 4.7 of the DASY4 Manual.

	Test Report Serial No.:	100305KBC-T673-S15W	Report Issue No.:	S673W-021306-R0
	Date(s) of Evaluation:	June 09, 2005	Report Issue Date:	February 13, 2006
	Type of Evaluation:	RF Exposure	SAR	FCC 47 CFR 2.1093

APPENDIX G - SAM PHANTOM CERTIFICATE OF CONFORMITY

Applicant:	Itronix Corporation	FCC ID:	KBCIX325-AC580IWL	IC ID:	1943A-IX325f	
Model:	IX325-AC580IWL	Rugged Tablet PC with Intel Pro 2200BG 802.11b/g WLAN Mini-PCI Card				
2006 Celltech Labs Inc.	This document is not to be reproduced in whole or in part without the prior written permission of Celltech Labs Inc.					Page 31 of 32

Schmid & Partner Engineering AG

Zeughausstrasse 43, 8004 Zurich, Switzerland, Phone +41 1 245 97 00, Fax +41 1 245 97 79

Certificate of conformity / First Article Inspection

Item	SAM Twin Phantom V4.0
Type No	QD 000 P40 BA
Series No	TP-1002 and higher
Manufacturer / Origin	Untersee Composites Hauptstr. 69 CH-8559 Fruthwilen Switzerland

Tests

The series production process used allows the limitation to test of first articles. Complete tests were made on the pre-series Type No. QD 000 P40 AA, Serial No. TP-1001 and on the series first article Type No. QD 000 P40 BA, Serial No. TP-1006. Certain parameters have been retested using further series units (called samples).

Test	Requirement	Details	Units tested
Shape	Compliance with the geometry according to the CAD model.	IT'IS CAD File (*)	First article, Samples
Material thickness	Compliant with the requirements according to the standards	2mm +/- 0.2mm in specific areas	First article, Samples
Material parameters	Dielectric parameters for required frequencies	200 MHz – 3 GHz Relative permittivity < 5 Loss tangent < 0.05.	Material sample TP 104-5
Material resistivity	The material has been tested to be compatible with the liquids defined in the standards	Liquid type HSL 1800 and others according to the standard.	Pre-series, First article

Standards

- [1] CENELEC EN 50361
- [2] IEEE P1528-200x draft 6.5
- [3] IEC PT 62209 draft 0.9

(*) The IT'IS CAD file is derived from [2] and is also within the tolerance requirements of the shapes of [1] and [3].

Conformity

Based on the sample tests above, we certify that this item is in compliance with the uncertainty requirements of SAR measurements specified in standard [1] and draft standards [2] and [3].

Date 18.11.2001

Signature / Stamp

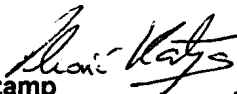

**Schmid & Partner
Engineering AG**



Zeughausstrasse 43, CH-8004 Zurich
Tel. +41 1 245 97 00, Fax +41 1 245 97 79

	Test Report Serial No.:	100305KBC-T673-S15W	Report Issue No.:	S673W-021306-R0
	Date(s) of Evaluation:	June 09, 2005	Report Issue Date:	February 13, 2006
	Type of Evaluation:	RF Exposure	SAR	FCC 47 CFR 2.1093

APPENDIX H - PLANAR PHANTOM CERTIFICATE OF CONFORMITY

Applicant:	Itronix Corporation	FCC ID:	KBCIX325-AC580IWL	IC ID:	1943A-IX325f	
Model:	IX325-AC580IWL	Rugged Tablet PC with Intel Pro 2200BG 802.11b/g WLAN Mini-PCI Card				
2006 Celltech Labs Inc.	This document is not to be reproduced in whole or in part without the prior written permission of Celltech Labs Inc.					Page 32 of 32

2378 Westlake Road
Kelowna, B.C. Canada
V1Z-2V2

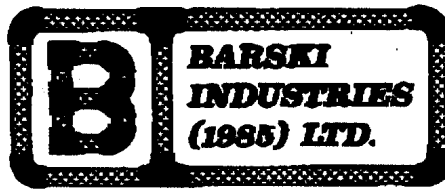

Ph. # 250-769-6848
Fax # 250-769-6334
E-mail: barskiind@shaw.ca
Web: www.bcfiberglass.com

FIBERGLASS FABRICATORS

Certificate of Conformity

Item : Flat Planar Phantom Unit # 03-01
Date: June 16, 2003
Manufacturer: Barski Industries (1985 Ltd)

Test	Requirement	Details
Shape	Compliance to geometry according to drawing	Supplied CAD drawing
Material Thickness	Compliant with the requirements	2mm +/- 0.2mm in measurement area
Material Parameters	Dielectric parameters for required frequencies Based on Dow Chemical technical data	100 MHz-5 GHz Relative permittivity < 5 Loss Tangent < 0.05

Conformity

Based on the above information, we certify this product to be compliant to the requirements specified.

Signature: _____

A handwritten signature in black ink, appearing to read 'Daniel Chailier', is written over a horizontal line.

Daniel Chailier



Fiberglass Planar Phantom - Top View



Fiberglass Planar Phantom - Front View



Fiberglass Planar Phantom - Back View



Fiberglass Planar Phantom - Bottom View

Dimensions of Fiberglass Planar Phantom

(Manufactured by Barski Industries Ltd. - Unit# 03-01)

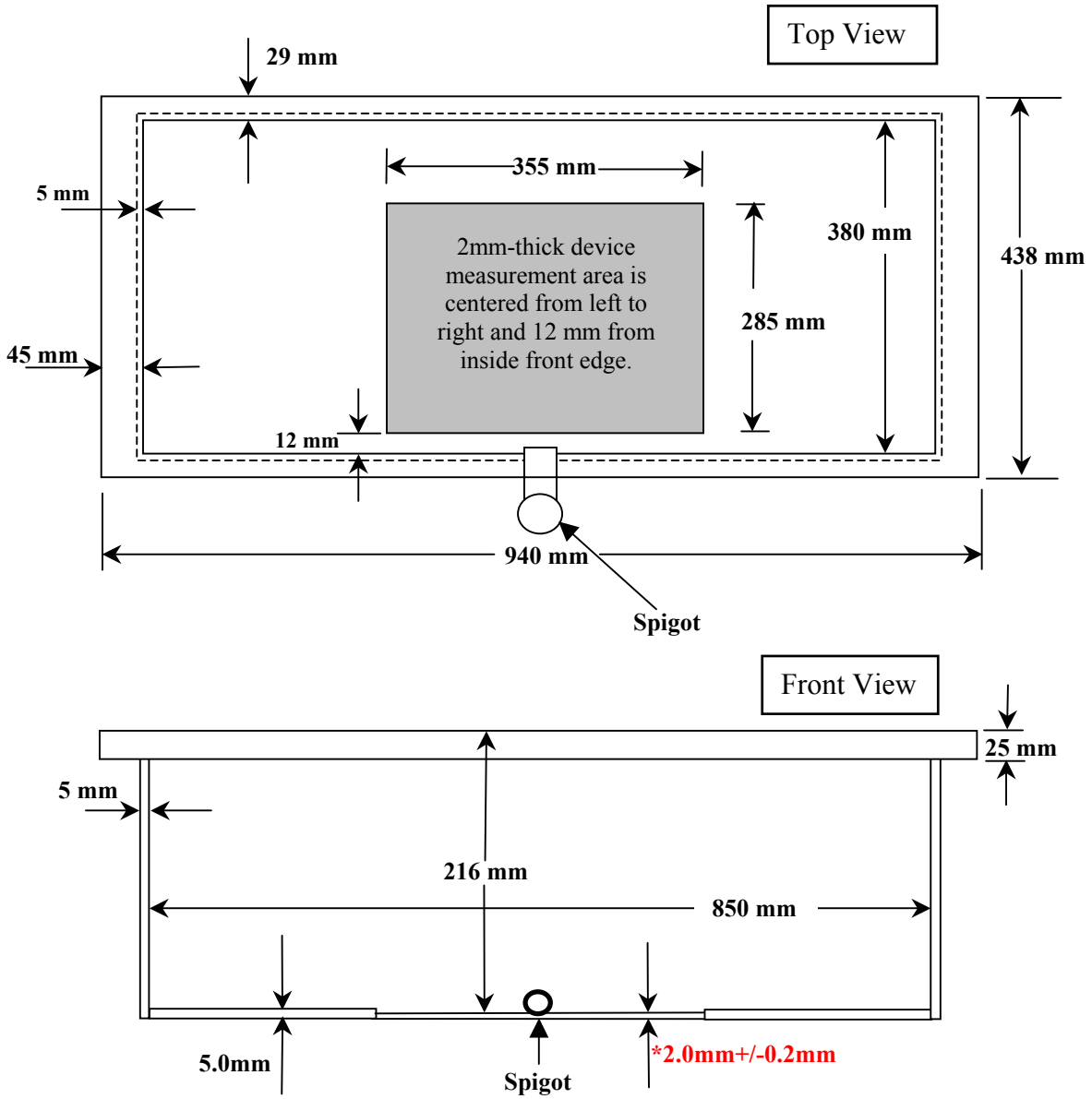

**Note: Measurements that aren't repeated for the opposite sides are the same as the side measured.
This drawing is not to scale.**