



Test Report Serial No.:	100305KBC-T672-S24C	Report Issue No.:	S672C-020906-R0
Dates of Evaluation:	October 04, 21 & 24, 2005	Report Issue Date:	February 09, 2006
Type of Evaluation:	RF Exposure SAR	FCC 47 CFR §2.1093	IC RSS-102 Issue 2

**RF EXPOSURE EVALUATION**

**SPECIFIC ABSORPTION RATE**

**SAR TEST REPORT**

FOR

**ITRONIX CORPORATION**

**MODEL: IX325-AC580**

**IX325 SERIES RUGGED TABLET PC**

WITH

**DUAL-BAND PCS/CELLULAR CDMA PCMCIA MODEM**

**FCC ID: KBCIX325-AC580**

**IC: 1943A-IX325f**

**Test Report Serial Number**

**100305KBC-T672-S24C**

**Test Report Issue No.**

**S672C-020906-R0**

**Test Lab**

**Celltech Compliance Testing & Engineering Lab**

**(Celltech Labs Inc.)**

**1955 Moss Court**

**Kelowna, BC**

**Canada**

**V1Y 9L3**

**Test Report Prepared By:**

*Cheri Frangiadakis*

**Cheri Frangiadakis  
Test Report Writer  
Celltech Labs Inc.**

**Test Report Approved By:**

*[Signature]*

**Jonathan Hughes  
General Manager  
Celltech Labs Inc.**

<b>Applicant:</b>	<b>Itronix Corporation</b>	<b>FCC ID:</b>	<b>KBCIX325-AC580</b>	<b>IC ID:</b>	<b>1943A-IX325f</b>	
<b>Model:</b>	<b>IX325-AC580</b>	<b>Type:</b>	<b>IX325 Rugged Tablet PC with Dual-Band CDMA PCMCIA Modem</b>			
2006 Celltech Labs Inc.	This document is not to be reproduced in whole or in part without the prior written permission of Celltech Labs Inc.					Page 1 of 47



Test Report Serial No.:	100305KBC-T672-S24C	Report Issue No.:	S672C-020906-R0
Dates of Evaluation:	October 04, 21 & 24, 2005	Report Issue Date:	February 09, 2006
Type of Evaluation:	RF Exposure SAR	FCC 47 CFR §2.1093	IC RSS-102 Issue 2

## DECLARATION OF COMPLIANCE SAR RF EXPOSURE EVALUATION

### Test Lab

**CELLTECH LABS INC.**  
Testing and Engineering Services  
1955 Moss Court  
Kelowna, B.C.  
Canada V1Y 9L3  
Phone: 250-448-7047  
Fax: 250-448-7046  
e-mail: info@celltechlabs.com  
web site: www.celltechlabs.com

### Applicant Information

**ITRONIX CORPORATION**  
12825 E. Mirabeau Parkway  
Spokane Valley, WA 99216  
United States

**FCC IDENTIFIER:** KBCIX325-AC580  
**IC IDENTIFIER:** 1943A-IX325f  
**Model(s):** IX325-AC580

**Rule Part(s):** FCC 47 CFR §2.1093; Health Canada Safety Code 6  
**Test Procedure(s):** FCC OET Bulletin 65, Supplement C (Edition 01-01)  
Industry Canada RSS-102 Issue 2  
**FCC Device Classification:** PCS Licensed Transmitter (PCB)  
**IC Device Classification:** 2 GHz Personal Communication Services (RSS-133 Issue 3)  
800 MHz Cellular Telephones Employing New Technologies (RSS-132 Issue 2)



**Device Description:** Rugged Tablet PC  
**User Orientation(s):** 0 Degrees Landscape, -90 Degrees Portrait  
**Internal Transmitter:** Sierra Wireless AirCard 580 Dual-Band PCS/Cellular CDMA PCMCIA Modem  
**Modulation Scheme(s):** QPSK  
**Tx Frequency Range(s):** 1851.25 - 1908.75 MHz (PCS Band)  
824.70 - 848.31 MHz (Cellular Band)  
**Max. RF Output Power Tested:** 24.2 dBm (0.263 Watts) Conducted (PCS CDMA)  
23.2 dBm (0.209 Watts) Conducted (Cellular CDMA)  
**Power Source(s) Tested:** Internal Lithium-ion Battery - 11.1 V, 3600 mAh (Model: T8M-E)  
**Antenna Type(s) Tested:** External Hinged Dipole

**Max. SAR Level(s) Evaluated:** Body: 0.130 W/kg (1g average) - PCS Band  
Body: 0.0673 W/kg (1g average) - Cellular Band

Celltech Labs Inc. declares under its sole responsibility that this wireless device was compliant with the Specific Absorption Rate (SAR) RF exposure requirements specified in FCC 47 CFR §2.1093 and Health Canada's Safety Code 6. The device was tested in accordance with the measurement standards and procedures specified in FCC OET Bulletin 65, Supplement C (Edition 01-01) and Industry Canada RSS-102 Issue 2 for the General Population / Uncontrolled Exposure environment. All measurements were performed in accordance with the SAR system manufacturer recommendations.

I attest to the accuracy of data. All measurements were performed by me or were made under my supervision and are correct to the best of my knowledge and belief. I assume full responsibility for the completeness of these measurements and vouch for the qualifications of all persons taking them.

This test report shall not be reproduced partially, or in full, without the prior written approval of Celltech Labs Inc. The results and statements contained in this report pertain only to the device(s) evaluated.

<b>Tested By:</b>   <hr/> <b>Sean Johnston</b> Compliance Technologist Celltech Labs Inc.	<b>Reviewed By:</b>   <hr/> <b>Spencer Watson</b> Senior Compliance Technologist Celltech Labs Inc.
---	---



<b>Applicant:</b> Itronix Corporation	<b>FCC ID:</b> KBCIX325-AC580	<b>IC ID:</b> 1943A-IX325f	
<b>Model:</b> IX325-AC580	<b>Type:</b> IX325 Rugged Tablet PC with Dual-Band CDMA PCMCIA Modem		
2006 Celltech Labs Inc.	This document is not to be reproduced in whole or in part without the prior written permission of Celltech Labs Inc.		Page 2 of 47

<b>TABLE OF CONTENTS</b>	
<b>1.0 INTRODUCTION</b>	<b>4</b>
<b>2.0 DESCRIPTION of DEVICE UNDER TEST (DUT)</b>	<b>4</b>
<b>3.0 SAR MEASUREMENT SYSTEM</b>	<b>5</b>
<b>4.0 MEASUREMENT SUMMARY</b>	<b>6</b>
<b>5.0 DETAILS OF SAR EVALUATION</b>	<b>8</b>
<b>6.0 EVALUATION PROCEDURES</b>	<b>9</b>
<b>7.0 SYSTEM PERFORMANCE CHECK</b>	<b>10</b>
<b>8.0 SIMULATED EQUIVALENT TISSUES</b>	<b>11</b>
<b>9.0 SAR SAFETY LIMITS</b>	<b>11</b>
<b>10.0 ROBOT SYSTEM SPECIFICATIONS</b>	<b>12</b>
<b>11.0 PROBE SPECIFICATION (ET3DV6)</b>	<b>13</b>
<b>12.0 PLANAR PHANTOM</b>	<b>13</b>
<b>13.0 DEVICE HOLDER</b>	<b>13</b>
<b>14.0 TEST EQUIPMENT LIST</b>	<b>14</b>
<b>15.0 MEASUREMENT UNCERTAINTIES</b>	<b>15</b>
<b>16.0 REFERENCES</b>	<b>17</b>
<b>APPENDIX A - SAR MEASUREMENT DATA</b>	<b>18</b>
<b>APPENDIX B - SYSTEM PERFORMANCE CHECK DATA</b>	<b>29</b>
<b>APPENDIX C - MEASURED FLUID DIELECTRIC PARAMETERS</b>	<b>36</b>
<b>APPENDIX D - SAR TEST SETUP PHOTOGRAPHS</b>	<b>40</b>
<b>APPENDIX E - SYSTEM VALIDATION</b>	<b>45</b>
<b>APPENDIX F - PROBE CALIBRATION</b>	<b>46</b>
<b>APPENDIX G - PLANAR PHANTOM CERTIFICATE OF CONFORMITY</b>	<b>47</b>

	Test Report Serial No.:	100305KBC-T672-S24C	Report Issue No.:	S672C-020906-R0
	Dates of Evaluation:	October 04, 21 & 24, 2005	Report Issue Date:	February 09, 2006
	Type of Evaluation:	RF Exposure	SAR	FCC 47 CFR §2.1093

## 1.0 INTRODUCTION

This measurement report demonstrates that ITRONIX CORPORATION Model: IX325-AC580 Rugged Tablet PC FCC ID: KBCIX325-AC580, incorporating the Sierra Wireless AirCard 580 Dual-Band PCS/Cellular CDMA PCMCIA Modem, complies with the SAR (Specific Absorption Rate) RF exposure requirements specified in FCC 47 CFR §2.1093 (see reference [1]), and Health Canada's Safety Code 6 (see reference [2]) for the General Population / Uncontrolled Exposure environment. The test procedures described in FCC OET Bulletin 65, Supplement C, Edition 01-01 (see reference [3]), and IC RSS-102 Issue 2 (see reference [4]) were employed. A description of the product and operating configuration, detailed summary of the test results, methodology and procedures used in the evaluation, equipment used, and the various provisions of the rules are included within this test report.

## 2.0 DESCRIPTION of DEVICE UNDER TEST (DUT)

<b>FCC Rule Part(s)</b>	47 CFR §2.1093		<b>IC Rule Part(s)</b>	Health Canada Safety Code 6
<b>Test Procedure(s)</b>	FCC OET Bulletin 65, Supplement C (01-01)			
	Industry Canada RSS-102 Issue 2			
<b>RF Exposure Category</b>	General Population / Uncontrolled Environment			
<b>FCC Device Classification</b>	PCS Licensed Transmitter (PCB)			24E, 22H
<b>IC Device Classification</b>	2 GHz Personal Communication Services			RSS 133 Issue 3
	800MHz Cellular Telephones Employing New Technologies			RSS-132 Issue 2
<b>Device Description</b>	Rugged Tablet PC	<b>LCD Display User Orientation(s)</b>	0 Degrees Landscape, -90 Degrees Portrait	
<b>Internal Transmitter(s)</b>	Sierra Wireless AirCard 580 Dual-Band PCS/Cellular CDMA PCMCIA Modem			
<b>FCC IDENTIFIER</b>	KBCIX325-AC580		<b>IC IDENTIFIER</b>	1943A-IX325f
<b>Model(s)</b>	IX325-AC580			
<b>Test Sample Serial No.(s)</b>	ZZGEG5073ZZ9782	IX325 Tablet PC		Identical Prototype
	60209FBS	AirCard 580		Production Unit
<b>Modulation Scheme(s)</b>	QPSK	Quadrature Phase Shift Keying		
<b>Transmitter Frequency Range(s)</b>	1851.25 - 1908.75 MHz	PCS Band	824.70 - 848.31 MHz	Cellular Band
<b>Max. Conducted RF Output Power Level(s) Measured</b>	23.2 dBm	0.209 Watts	1851.25 MHz	PCS CDMA
	24.2 dBm	0.263 Watts	1880.00 MHz	PCS CDMA
	24.2 dBm	0.263 Watts	1909.75 MHz	PCS CDMA
	23.2 dBm	0.209 Watts	824.70 MHz	Cellular CDMA
	23.2 dBm	0.209 Watts	836.52 MHz	Cellular CDMA
	23.2 dBm	0.209 Watts	848.31 MHz	Cellular CDMA
<b>Antenna Type(s) Tested</b>	External Hinged Dipole			
<b>Device Position(s) Tested</b>	Bottom Side of Tablet PC			
<b>Antenna Positions Tested</b>	Position 1	Parallel Straight		Antenna 180° to card
	Position 2	Parallel Bent		Antenna 180° to card
	Position 3	Perpendicular		Antenna 90° to card
<b>Power Source(s) Tested</b>	Internal Lithium-ion Battery		11.1 V, 3600 mAh	Model: T8M-E
<b>Additional Power Source(s) Testing Not Required</b>	External Second Lithium-ion Battery		11.1 V, 3600 mAh	Model: T8S-E
	Note: The external second lithium-ion battery was not evaluated for SAR due to the fact that it has exactly the same power specifications as the internal battery and provides additional separation distance to user.			

<b>Applicant:</b>	Itronix Corporation	<b>FCC ID:</b>	KBCIX325-AC580	<b>IC ID:</b>	1943A-IX325f	
<b>Model:</b>	IX325-AC580	<b>Type:</b>	IX325 Rugged Tablet PC with Dual-Band CDMA PCMCIA Modem			
2006 Celltech Labs Inc.	This document is not to be reproduced in whole or in part without the prior written permission of Celltech Labs Inc.					Page 4 of 47

	Test Report Serial No.:	100305KBC-T672-S24C	Report Issue No.:	S672C-020906-R0
	Dates of Evaluation:	October 04, 21 & 24, 2005	Report Issue Date:	February 09, 2006
	Type of Evaluation:	RF Exposure	SAR	FCC 47 CFR §2.1093

### 3.0 SAR MEASUREMENT SYSTEM

Celltech Labs Inc. SAR measurement facility utilizes the Dosimetric Assessment System (DASY™) manufactured by Schmid & Partner Engineering AG (SPEAG™) of Zurich, Switzerland. The DASY4 measurement system is comprised of the measurement server, robot controller, computer, near-field probe, probe alignment sensor, specific anthropomorphic mannequin (SAM) phantom, and various planar phantoms for brain and/or body SAR evaluations. The robot is a six-axis industrial robot performing precise movements to position the probe to the location (points) of maximum electromagnetic field (EMF). A cell controller system contains the power supply, robot controller, teach pendant (Joystick), and remote control, is used to drive the robot motors. The Staubli robot is connected to the cell controller to allow software manipulation of the robot. A data acquisition electronic (DAE) circuit performs the signal amplification, signal multiplexing, AD-conversion, offset measurements, mechanical surface detection, collision detection, etc. is connected to the Electro-optical coupler (EOC). The EOC performs the conversion from the optical into digital electric signal of the DAE and transfers data to the DASY4 measurement server. The DAE4 utilizes a highly sensitive electrometer-grade preamplifier with auto-zeroing, a channel and gain-switching multiplexer, a fast 16-bit AD-converter and a command decoder and control logic unit. Transmission to the DASY4 measurement server is accomplished through an optical downlink for data and status information and an optical uplink for commands and clock lines. The mechanical probe-mounting device includes two different sensor systems for frontal and sidewise probe contacts. The sensor systems are also used for mechanical surface detection and probe collision detection. The robot uses its own controller with a built in VME-bus computer.



DASY4 SAR Measurement System with planar phantom



DASY4 SAR Measurement System with planar phantom and validation dipole

<b>Applicant:</b>	Itronix Corporation	<b>FCC ID:</b>	KBCIX325-AC580	<b>IC ID:</b>	1943A-IX325f	
<b>Model:</b>	IX325-AC580	<b>Type:</b>	IX325 Rugged Tablet PC with Dual-Band CDMA PCMCIA Modem			
2006 Celltech Labs Inc.	This document is not to be reproduced in whole or in part without the prior written permission of Celltech Labs Inc.					Page 5 of 47



Test Report Serial No.:	100305KBC-T672-S24C	Report Issue No.:	S672C-020906-R0
Dates of Evaluation:	October 04, 21 & 24, 2005	Report Issue Date:	February 09, 2006
Type of Evaluation:	RF Exposure SAR	FCC 47 CFR §2.1093	IC RSS-102 Issue 2

## 4.0 MEASUREMENT SUMMARY

BODY-WORN SAR EVALUATION RESULTS - CELLULAR CDMA											
Test Mode	Freq. (MHz)	Channel	Antenna Position	Power Source	DUT Position to Planar Phantom	Separation Distance to Planar Phantom (cm)	Cond. Power Before Test (dBm)	SAR Drift During Test (dB)	Measured SAR 1g (W/kg)		
Cellular CDMA	836.52	384	Perpendicular	Li-ion Battery	Bottom Side	0.0	23.2	-0.503 <sup>3</sup>	0.0305		
Cellular CDMA	836.52	384	Parallel Straight	Li-ion Battery	Bottom Side	0.0	23.2	-0.140	<b>0.0673</b>		
Cellular CDMA	836.52	384	Parallel Bent	Li-ion Battery	Bottom Side	0.0	23.2	-0.498 <sup>3</sup>	0.0394		
<b>ANSI / IEEE C95.1 1999 - SAFETY LIMIT</b>			<b>BODY: 1.6 W/kg (averaged over 1 gram)</b>			<b>Spatial Peak Uncontrolled Exposure / General Population</b>					
<b>Test Date(s)</b>		October 04, 2005			<b>Relative Humidity</b>		32	%			
<b>Dielectric Constant <math>\epsilon_r</math></b>		<b>835 MHz Body</b>				<b>Atmospheric Pressure</b>		101.6	kPa		
		<b>IEEE Target</b>		<b>Measured</b>		<b>Deviation</b>		<b>Ambient Temperature</b>		22.8	°C
		55.2	± 5%	53.3	-3.4%	<b>Fluid Temperature</b>		22.4	°C		
<b>Conductivity <math>\sigma</math> (mho/m)</b>		<b>IEEE Target</b>		<b>Measured</b>		<b>Deviation</b>		<b>Fluid Depth</b>		≥ 15	cm
		0.97	± 5%	0.99	+2.1%	<b><math>\rho</math> (Kg/m<sup>3</sup>)</b>		1000			

Note(s):

1. The measurement results were obtained with the DUT tested in the conditions described in this report. Detailed measurement data and plots showing the maximum SAR location of the DUT are reported in Appendix A.
2. If the scaled SAR levels evaluated at the mid channel were  $\geq 3$  dB below the SAR limit, SAR evaluation for the low and high channels was optional (per FCC OET Bulletin 65, Supplement C, Edition 01-01 - see reference [3]).
3. The power drifts reported were measured at the reference point of the phantom with low SAR. The drift values shown are inaccurate due to the SAR value at the reference point is close to the measurement noise floor; therefore power drift scaling was not applied in this case.
4. The DUT battery was fully charged prior to the SAR evaluations.
5. The ambient and fluid temperatures were measured prior to, and during, the fluid dielectric parameter check and the SAR evaluations. The temperatures reported in the table above were consistent for all measurement periods.
6. The dielectric parameters of the simulated tissue mixture were measured prior to the SAR evaluations using an ALS-PR-DIEL Dielectric Probe Kit and an HP 8753ET Network Analyzer (see Appendix C).
7. The SAR evaluations were performed within 24 hours of the system performance check.

	Test Report Serial No.:	100305KBC-T672-S24C	Report Issue No.:	S672C-020906-R0
	Dates of Evaluation:	October 04, 21 & 24, 2005	Report Issue Date:	February 09, 2006
	Type of Evaluation:	RF Exposure SAR	FCC 47 CFR §2.1093	IC RSS-102 Issue 2

## MEASUREMENT SUMMARY (Cont.)

BODY-WORN SAR EVALUATION RESULTS - PCS CDMA									
Test Mode	Freq. (MHz)	Chan.	Antenna Position	Power Source	DUT Position to Planar Phantom	Separation Distance to Planar Phantom (cm)	Cond. Power Before Test (dBm)	SAR Drift During Test (dB)	Measured SAR 1g (W/kg)
PCS CDMA	1880.00	600	Parallel Straight	Li-ion Battery	Bottom Side	0.0	24.2	-0.0483	<b>0.130</b>
PCS CDMA	1880.00	600	Parallel Bent	Li-ion Battery	Bottom Side	0.0	24.2	0.000159	0.0939
PCS CDMA	1880.00	600	Perpendicular	Li-ion Battery	Bottom Side	0.0	24.2	-0.134	0.0882
<b>ANSI / IEEE C95.1 1999 - SAFETY LIMIT</b>			<b>BODY: 1.6 W/kg (averaged over 1 gram)</b>			<b>Spatial Peak Uncontrolled Exposure / General Population</b>			
<b>Test Date(s)</b>	October 21, 2005				<b>Relative Humidity</b>		31	%	
<b>Measured Fluid Type</b>	1880 MHz Body				<b>Atmospheric Pressure</b>		103.0	kPa	
<b>Dielectric Constant <math>\epsilon_r</math></b>	<b>IEEE Target</b>		<b>Measured</b>	<b>Deviation</b>	<b>Ambient Temperature</b>		23.4	°C	
	53.3	± 5%	50.8	-4.7%	<b>Fluid Temperature</b>		22.0	°C	
<b>Conductivity <math>\sigma</math> (mho/m)</b>	<b>IEEE Target</b>		<b>Measured</b>	<b>Deviation</b>	<b>Fluid Depth</b>		≥ 15	cm	
	1.52	± 5%	1.46	-3.9%	<b><math>\rho</math> (Kg/m<sup>3</sup>)</b>		1000		

Note(s):

- The measurement results were obtained with the DUT tested in the conditions described in this report. Detailed measurement data and plots showing the maximum SAR location of the DUT are reported in Appendix A.
- If the scaled SAR levels evaluated at the mid channel were  $\geq 3$  dB below the SAR limit, SAR evaluation for the low and high channels was optional (per FCC OET Bulletin 65, Supplement C, Edition 01-01 - see reference [3]).
- The power drifts measured by the DASY4 system for the duration of the SAR evaluations were  $<5\%$  from the start power.
- The DUT battery was fully charged prior to the SAR evaluations.
- The ambient and fluid temperatures were measured prior to, and during, the fluid dielectric parameter check and the SAR evaluations. The temperatures reported in the table above were consistent for all measurement periods.
- The dielectric parameters of the simulated tissue mixture were measured prior to the SAR evaluations using an ALS-PR-DIEL Dielectric Probe Kit and an HP 8753ET Network Analyzer (see Appendix C).
- The SAR evaluations were performed within 24 hours of the system performance check.

<b>Applicant:</b>	Itronix Corporation	<b>FCC ID:</b>	KBCIX325-AC580	<b>IC ID:</b>	1943A-IX325f	
<b>Model:</b>	IX325-AC580	<b>Type:</b>	IX325 Rugged Tablet PC with Dual-Band CDMA PCMCIA Modem			
2006 Celltech Labs Inc.	This document is not to be reproduced in whole or in part without the prior written permission of Celltech Labs Inc.					Page 7 of 47

## 5.0 DETAILS OF SAR EVALUATION

The ITRONIX CORPORATION Model: IX325-AC580 Rugged Tablet PC FCC ID: KBCIX325-AC580, with internal Sierra Wireless AirCard 580 Dual-Band PCS/Cellular CDMA PCMCIA Modem, was compliant for localized Specific Absorption Rate (Uncontrolled Exposure) based on the test provisions and conditions described below. The detailed test setup photographs are shown in Appendix D.

### Body SAR Test Configuration

1. The DUT was tested for body SAR with the bottom side of the Tablet PC placed parallel to, and touching, the outer surface of the planar phantom. The DUT was evaluated with the AirCard 580 antenna placed in the "Parallel Straight" position, "Parallel Bent" position, and "Perpendicular" position (see photos below).
2. A 2<sup>nd</sup> SAR scan was performed over the entire surface of the tablet PC bottom side in the worst-case SAR test configurations for both PCS and Cellular bands in order to show there was no SAR distribution over bottom surface area of the DUT.
3. The ambient and fluid temperatures were measured prior to, and during, the fluid dielectric parameter check and the SAR evaluations. The temperatures reported were consistent for all measurement periods.
4. The dielectric parameters of the simulated tissue mixtures were measured prior to the SAR evaluations using an ALS-PR-DIEL Dielectric Probe Kit and an HP 8753ET Network Analyzer (see Appendix C).
5. The SAR evaluations were performed within 24 hours of the system performance check.

### Test Modes & Power Settings

6. The DUT was controlled in test mode via internal software with the DUT transmitting in the "always up" power control mode with a modulated CDMA signal.
7. The conducted power levels of the DUT were measured at the AirCard 580 hatch antenna port prior to the SAR evaluations using a Gigatronics 8652A Universal Power Meter according to the procedures described in FCC 47 CFR §2.1046.
8. The power drift was measured by the DASY4 system for the duration of the SAR evaluations.
9. The DUT battery was fully charged prior to each SAR evaluation.



Antenna "Parallel Straight"  
("0 Degrees Landscape"  
Device User Orientation)



Antenna "Parallel Bent"  
("90 Degrees Portrait"  
Device User Orientation)



Antenna "Perpendicular"  
("0 Degrees Landscape"  
Device User Orientation)



	Test Report Serial No.:	100305KBC-T672-S24C	Report Issue No.:	S672C-020906-R0
	Dates of Evaluation:	October 04, 21 & 24, 2005	Report Issue Date:	February 09, 2006
	Type of Evaluation:	RF Exposure	SAR	FCC 47 CFR §2.1093

## 6.0 EVALUATION PROCEDURES

- a. (i) The evaluation was performed in the applicable area of the phantom depending on the type of device being tested. For devices held to the ear during normal operation, both the left and right ear positions were evaluated using the SAM phantom.
- (ii) For body-worn and face-held devices a planar phantom was used.
- b. The SAR was determined by a pre-defined procedure within the DASY4 software. Upon completion of a reference and optical surface check, the exposed region of the phantom was scanned near the inner surface with a grid spacing of 15mm x 15mm.

An area scan was determined as follows:

- c. Based on the defined area scan grid, a more detailed grid is created to increase the points by a factor of 10. The interpolation function then evaluates all field values between corresponding measurement points.
- d. A linear search is applied to find all the candidate maxima. Subsequently, all maxima are removed that are >2 dB from the global maximum. The remaining maxima are then used to position the cube scans.

A 1g and 10g spatial peak SAR was determined as follows:

- e. Extrapolation is used to find the points between the dipole center of the probe and the surface of the phantom. This data cannot be measured, since the center of the dipoles is 2.7 mm away from the tip of the probe and the distance between the surface and the lowest measuring point is 1.4 mm (see probe calibration document in Appendix F). The extrapolation was based on trivariate quadratics computed from the previously calculated 3D interpolated points nearest the phantom surface.
- f. Interpolated data is used to calculate the average SAR over 1g and 10g cubes by spatially discretizing the entire measured cube. The volume used to determine the averaged SAR is a 1mm grid (42875 interpolated points).
- g. A zoom scan volume of 32 mm x 32 mm x 30 mm (5 x 5 x 7 points) centered at the peak SAR location determined from the area scan is used for all zoom scans for devices with a transmit frequency < 800 MHz. Zoom scans for frequencies ≥ 800 MHz are determined with a scan volume of 30 mm x 30 mm x 30 mm (7 x 7 x 7) to ensure complete capture of the peak spatial-average SAR.

<b>Applicant:</b>	Itronix Corporation	<b>FCC ID:</b>	KBCIX325-AC580	<b>IC ID:</b>	1943A-IX325f	
<b>Model:</b>	IX325-AC580	<b>Type:</b>	IX325 Rugged Tablet PC with Dual-Band CDMA PCMCIA Modem			
2006 Celltech Labs Inc.	This document is not to be reproduced in whole or in part without the prior written permission of Celltech Labs Inc.					Page 9 of 47

## 7.0 SYSTEM PERFORMANCE CHECK

Prior to the SAR evaluations a system check was performed using a planar phantom with an 835MHz dipole and a 1900MHz dipole (see Appendix E for system validation procedures). The dielectric parameters of the simulated tissue mixtures were measured prior to the system performance check using an ALS-PR-DIEL Dielectric Probe Kit and an HP 8753ET Network Analyzer (see Appendix C). A forward power of 250 mW was applied to the dipole and the system was verified to a tolerance of  $\pm 10\%$  (see Appendix B for system performance check test plots). See Table 1 below for the SAR system manufacturer's reference body SAR values from the DASY4 Operation Manual, March 2005 (see reference [6]).

### SYSTEM PERFORMANCE CHECK EVALUATIONS

Test Date	Equiv. Tissue Body (MHz)	SAR 1g (W/kg)			Dielectric Constant $\epsilon_r$			Conductivity $\sigma$ (mho/m)			$\rho$ (Kg/m <sup>3</sup> )	Amb. Temp. (°C)	Fluid Temp. (°C)	Fluid Depth (cm)	Humid. (%)	Barom. Press. (kPa)
		IEEE Target	Meas.	Dev.	IEEE Target	Meas.	Dev.	IEEE Target	Meas.	Dev.						
10/04/05	835	2.43 $\pm 10\%$	2.61	+7.4%	55.2 $\pm 5\%$	53.3	-3.4%	0.97 $\pm 5\%$	0.99	+2.1%	1000	24.1	22.4	$\geq 15$	31	101.5
10/21/05	1900	9.95 $\pm 10\%$	10.2	+2.5%	53.3 $\pm 5\%$	50.7	-4.9%	1.52 $\pm 5\%$	1.48	-2.6%	1000	23.0	22.0	$\geq 15$	31	103.0
10/24/05	835	2.43 $\pm 10\%$	2.63	+8.2%	55.2 $\pm 5\%$	52.6	-4.7%	0.97 $\pm 5\%$	0.98	+1.0%	1000	23.4	22.4	$\geq 15$	32	102.3

Note(s):

1. The ambient and fluid temperatures were measured prior to, and during, the fluid dielectric parameter check and the system performance check. The temperatures listed in the table above were consistent for all measurement periods.

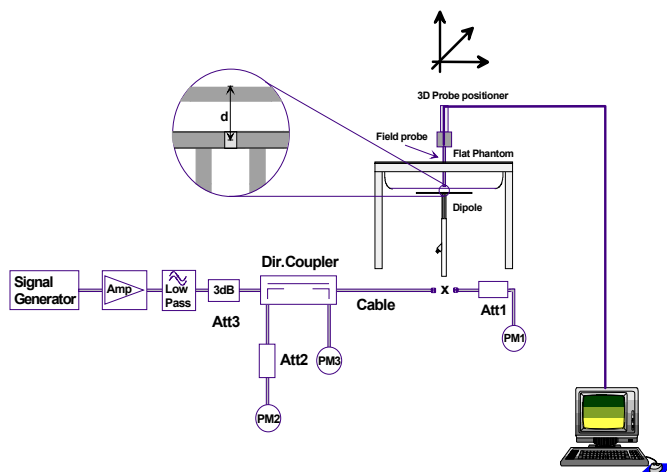

Figure 1. System Performance Check Setup Diagram

Dipole Type	Distance [mm]	Frequency [MHz]	SAR (1g) [W/kg]	SAR (10g) [W/kg]	SAR (peak) [W/kg]
D300V2	15	300	3.02	2.06	4.36
D450V2	15	450	5.01	3.36	7.22
D835V2	15	835	9.71	6.38	14.1
D900V2	15	900	11.1	7.17	16.3
D1450V2	10	1450	29.6	16.6	49.8
D1500V2	10	1500	30.8	17.1	52.1
D1640V2	10	1640	34.4	18.7	59.4
D1800V2	10	1800	38.5	20.3	67.5
D1900V2	10	1900	39.8	20.8	69.6
D2000V2	10	2000	40.9	21.2	71.5
D2450V2	10	2450	51.2	23.7	97.6
D3000V2	10	3000	61.9	24.8	136.7

Table 32.1: Numerical reference SAR values for SPEAG dipoles and flat phantom filled with body-tissue simulating liquid. Note: All SAR values normalized to 1 W forward power.

Table 1. SAR system manufacturer's reference body SAR values



1900MHz Dipole Setup



835MHz Dipole Setup

	Test Report Serial No.:	100305KBC-T672-S24C	Report Issue No.:	S672C-020906-R0
	Dates of Evaluation:	October 04, 21 & 24, 2005	Report Issue Date:	February 09, 2006
	Type of Evaluation:	RF Exposure    SAR	FCC 47 CFR §2.1093	IC RSS-102 Issue 2

## 8.0 SIMULATED EQUIVALENT TISSUES

The 1880/1900MHz simulated equivalent tissue mixture consisted of Glycol-monobutyl, water, and salt. The 835MHz simulated equivalent tissue mixture consisted of a viscous gel using hydroxethylcellulose (HEC) gelling agent and saline solution. Preservation with a bactericide was added and visual inspection was made to ensure air bubbles were not trapped during the mixing process. The fluids were prepared according to standardized procedures and measured for dielectric parameters (permittivity and conductivity).

1880/1900MHz TISSUE MIXTURES		
INGREDIENT	1900 MHz Body	1880 MHz Body
	System Performance Check	DUT Evaluation
Water	69.85 %	69.85 %
Glycol Monobutyl	29.89 %	29.89 %
Salt	0.26 %	0.26 %

835MHz TISSUE MIXTURES		
INGREDIENT	835 MHz Body	835 MHz Body
	System Performance Check	DUT Evaluation
Water	53.79 %	53.79 %
Sugar	45.13 %	45.13 %
Salt	0.98 %	0.98 %
HEC	--	--
Bactericide	0.10 %	0.10 %

## 9.0 SAR SAFETY LIMITS

EXPOSURE LIMITS	SAR (W/kg)	
	(General Population / Uncontrolled Exposure Environment)	(Occupational / Controlled Exposure Environment)
Spatial Average (averaged over the whole body)	0.08	0.4
Spatial Peak (averaged over any 1 g of tissue)	1.60	8.0
Spatial Peak (hands/wrists/feet/ankles averaged over 10 g)	4.0	20.0

Notes:

1. Uncontrolled environments are defined as locations where there is potential exposure of individuals who have no knowledge or control of their potential exposure.
2. Controlled environments are defined as locations where there is potential exposure of individuals who have knowledge of their potential exposure and can exercise control over their exposure.

Applicant:	Itronix Corporation	FCC ID:	KBCIX325-AC580	IC ID:	1943A-IX325f	
Model:	IX325-AC580	Type:	IX325 Rugged Tablet PC with Dual-Band CDMA PCMCIA Modem			
2006 Celltech Labs Inc.	This document is not to be reproduced in whole or in part without the prior written permission of Celltech Labs Inc.					Page 11 of 47

	Test Report Serial No.:	100305KBC-T672-S24C	Report Issue No.:	S672C-020906-R0
	Dates of Evaluation:	October 04, 21 & 24, 2005	Report Issue Date:	February 09, 2006
	Type of Evaluation:	RF Exposure      SAR	FCC 47 CFR §2.1093	IC RSS-102 Issue 2

## 10.0 ROBOT SYSTEM SPECIFICATIONS

### Specifications

**POSITIONER:** Stäubli Unimation Corp. Robot Model: RX60L  
**Repeatability:** 0.02 mm  
**No. of axis:** 6

### Data Acquisition Electronic (DAE) System

#### Cell Controller

**Processor:** AMD Athlon XP 2400+  
**Clock Speed:** 2.0 GHz  
**Operating System:** Windows XP Professional

#### Data Converter

**Features:** Signal Amplifier, multiplexer, A/D converter, and control logic  
**Software:** DASY4 software  
**Connecting Lines:** Optical downlink for data and status info.  
 Optical uplink for commands and clock

### DASY4 Measurement Server

**Function:** Real-time data evaluation for field measurements and surface detection  
**Hardware:** PC/104 166MHz Pentium CPU; 32 MB chipdisk; 64 MB RAM  
**Connections:** COM1, COM2, DAE, Robot, Ethernet, Service Interface

### E-Field Probe

**Model:** ET3DV6  
**Serial No.(s):** 1387  
**Construction:** Triangular core fiber optic detection system  
**Frequency:** 10 MHz to 6 GHz  
**Linearity:**  $\pm 0.2$  dB (30 MHz to 3 GHz)

### Phantom(s)

**Type:** Planar Phantom  
**Shell Material:** Fiberglass  
**Thickness:**  $2.0 \pm 0.1$  mm  
**Volume:** Approx. 72 liters

<b>Applicant:</b>	Itronix Corporation	<b>FCC ID:</b>	KBCIX325-AC580	<b>IC ID:</b>	1943A-IX325f	
<b>Model:</b>	IX325-AC580	<b>Type:</b>	IX325 Rugged Tablet PC with Dual-Band CDMA PCMCIA Modem			
2006 Celltech Labs Inc.	This document is not to be reproduced in whole or in part without the prior written permission of Celltech Labs Inc.					Page 12 of 47

	Test Report Serial No.:	100305KBC-T672-S24C	Report Issue No.:	S672C-020906-R0
	Dates of Evaluation:	October 04, 21 & 24, 2005	Report Issue Date:	February 09, 2006
	Type of Evaluation:	RF Exposure	SAR	FCC 47 CFR §2.1093

## 11.0 PROBE SPECIFICATION (ET3DV6)

Construction:	Symmetrical design with triangular core Built-in shielding against static charges PEEK enclosure material (resistant to organic solvents, e.g. glycol)
Calibration:	In air from 10 MHz to 2.5 GHz In brain simulating tissue at frequencies of 900 MHz and 1.8 GHz (accuracy $\pm 8\%$ )
Frequency:	10 MHz to >6 GHz; Linearity: $\pm 0.2$ dB (30 MHz to 3 GHz)
Directivity:	$\pm 0.2$ dB in brain tissue (rotation around probe axis) $\pm 0.4$ dB in brain tissue (rotation normal to probe axis)
Dynamic Range:	5 $\mu$ W/g to >100 mW/g; Linearity: $\pm 0.2$ dB
Surface Detection:	$\pm 0.2$ mm repeatability in air and clear liquids over diffuse reflecting surfaces
Dimensions:	Overall length: 330 mm Tip length: 16 mm Body diameter: 12 mm Tip diameter: 6.8 mm Distance from probe tip to dipole centers: 2.7 mm
Application:	General dosimetry up to 3 GHz Compliance tests of portable devices



ET3DV6 E-Field Probe

## 12.0 PLANAR PHANTOM

The planar phantom is a fiberglass shell phantom with a 2.0 mm (+/-0.2mm) thick device measurement area at the center of the phantom for SAR evaluations of devices with a larger surface area than the planar section of the SAM phantom. The planar phantom is integrated in a wooden table (see Appendix G for dimensions and specifications of the planar phantom).



Planar Phantom

## 13.0 DEVICE HOLDER

The DASY4 device holder has two scales for device rotation (with respect to the body axis) and the device inclination (with respect to the line between the ear openings). The plane between the ear openings and the mouth tip has a rotation angle of 65°. The bottom plate contains three pair of bolts for locking the device holder. The device holder positions are adjusted to the standard measurement positions in the three sections. For evaluations of larger devices such as Laptop and Tablet PCs, a Plexiglas platform is attached to the device holder.



Device Holder

Applicant:	Itronix Corporation	FCC ID:	KBCIX325-AC580	IC ID:	1943A-IX325f	
Model:	IX325-AC580	Type:	IX325 Rugged Tablet PC with Dual-Band CDMA PCMCIA Modem			
2006 Celltech Labs Inc.	This document is not to be reproduced in whole or in part without the prior written permission of Celltech Labs Inc.					Page 13 of 47

	Test Report Serial No.:	100305KBC-T672-S24C	Report Issue No.:	S672C-020906-R0
	Dates of Evaluation:	October 04, 21 & 24, 2005	Report Issue Date:	February 09, 2006
	Type of Evaluation:	RF Exposure	SAR	FCC 47 CFR §2.1093

## 14.0 TEST EQUIPMENT LIST

USED	TEST EQUIPMENT DESCRIPTION	ASSET NO.	SERIAL NO.	DATE CALIBRATED		CALIBRATION DUE DATE
x	Schmid & Partner DASY4 System	-	-	-	-	-
x	-DASY4 Measurement Server	00158	1078	N/A	N/A	N/A
x	-Robot	00046	599396-01	N/A	N/A	N/A
x	-DAE4	00019	353	15Jun05		15Jun06
x	-ET3DV6 E-Field Probe	00016	1387	18Mar05		18Mar06
	-ET3DV6 E-Field Probe	00017	1590	20May05		20May06
x	-835MHz Validation Dipole	00022	411	Brain	30Mar05	30Mar06
				Body	12Apr05	12Apr06
	-900MHz Validation Dipole	00020	054	Brain	10Jun05	10Jun06
				Body	10Jun05	10Jun06
	-1800MHz Validation Dipole	00021	247	Brain	14Jun05	14Jun06
				Body	14Jun05	14Jun06
x	-1900MHz Validation Dipole	00032	151	Brain	17Jun05	17Jun06
				Body	22Apr05	22Apr06
	-2450MHz Validation Dipole	00025	150	Brain	20Sep05	20Sep06
				Body	22Apr05	22Apr06
	-SAM Phantom V4.0C	00154	1033	N/A		N/A
x	-Barski Planar Phantom	00155	03-01	N/A		N/A
	-Plexiglas Side Planar Phantom	00156	161	N/A		N/A
	-Plexiglas Validation Planar Phantom	00157	137	N/A		N/A
	HP 85070C Dielectric Probe Kit	00033	N/A	N/A		N/A
x	ALS-PR-DIEL Dielectric Probe Kit	00160	260-00953	N/A		N/A
x	Gigatronics 8652A Power Meter	00110	1835801	16Apr05		16Apr06
	Gigatronics 8652A Power Meter	00008	1835267	29Apr05		29Apr06
x	Gigatronics 80701A Power Sensor	00012	1834350	12Sep05		12Sep06
x	Gigatronics 80701A Power Sensor	00014	1833699	07Sep05		07Sep06
x	Gigatronics 80701A Power Sensor	00109	1834366	16Apr05		16Apr06
x	HP 8753ET Network Analyzer	00134	US39170292	04May05		04May06
x	HP 8648D Signal Generator	00005	3847A00611	29Apr05		29Apr06
	Rohde & Schwarz SMR40 Signal Generator	00006	100104	12Apr05		12Apr06
x	Amplifier Research 5S1G4 Power Amplifier	00106	26235	N/A		N/A

Applicant:	Itronix Corporation	FCC ID:	KBCIX325-AC580	IC ID:	1943A-IX325f	
Model:	IX325-AC580	Type:	IX325 Rugged Tablet PC with Dual-Band CDMA PCMCIA Modem			
2006 Celltech Labs Inc.		This document is not to be reproduced in whole or in part without the prior written permission of Celltech Labs Inc.				Page 14 of 47

	Test Report Serial No.:	100305KBC-T672-S24C	Report Issue No.:	S672C-020906-R0
	Dates of Evaluation:	October 04, 21 & 24, 2005	Report Issue Date:	February 09, 2006
	Type of Evaluation:	RF Exposure    SAR	FCC 47 CFR §2.1093	IC RSS-102 Issue 2

## 15.0 MEASUREMENT UNCERTAINTIES

UNCERTAINTY BUDGET FOR DEVICE EVALUATION						
Error Description	Uncertainty Value ±%	Probability Distribution	Divisor	ci 1g	Uncertainty Value ±% (1g)	V <sub>i</sub> or V <sub>eff</sub>
<b>Measurement System</b>						
Probe calibration	5.5	Normal	1	1	5.5	∞
Axial isotropy of the probe	4.7	Rectangular	1.732050808	0.7	1.9	∞
Spherical isotropy of the probe	9.6	Rectangular	1.732050808	0.7	3.9	∞
Spatial resolution	0	Rectangular	1.732050808	1	0.0	∞
Boundary effects	1	Rectangular	1.732050808	1	0.6	∞
Probe linearity	4.7	Rectangular	1.732050808	1	2.7	∞
Detection limit	1	Rectangular	1.732050808	1	0.6	∞
Readout electronics	0.3	Normal	1	1	0.3	∞
Response time	0.8	Rectangular	1.732050808	1	0.5	∞
Integration time	2.6	Rectangular	1.732050808	1	1.5	∞
RF ambient conditions	3	Rectangular	1.732050808	1	1.7	∞
Mech. constraints of robot	0.4	Rectangular	1.732050808	1	0.2	∞
Probe positioning	2.9	Rectangular	1.732050808	1	1.7	∞
Extrapolation & integration	1	Rectangular	1.732050808	1	0.6	∞
<b>Test Sample Related</b>						
Device positioning	2.9	Normal	1	1	2.9	12
Device holder uncertainty	3.6	Normal	1	1	3.6	8
Power drift	5	Rectangular	1.732050808	1	2.9	∞
<b>Phantom and Setup</b>						
Phantom uncertainty	4	Rectangular	1.732050808	1	2.3	∞
Liquid conductivity (target)	5	Rectangular	1.732050808	0.64	1.8	∞
Liquid conductivity (measured)	2.5	Normal	1	0.64	1.6	∞
Liquid permittivity (target)	5	Rectangular	1.732050808	0.6	1.7	∞
Liquid permittivity (measured)	2.5	Normal	1	0.6	1.5	∞
<b>Combined Standard Uncertainty</b>					<b>10.58</b>	
<b>Expanded Uncertainty (k=2)</b>					<b>21.16</b>	

Measurement Uncertainty Table in accordance with IEEE Standard 1528-2003 (see reference [5])

<b>Applicant:</b>	<b>Itronix Corporation</b>	<b>FCC ID:</b>	<b>KBCIX325-AC580</b>	<b>IC ID:</b>	<b>1943A-IX325f</b>	
<b>Model:</b>	<b>IX325-AC580</b>	<b>Type:</b>	<b>IX325 Rugged Tablet PC with Dual-Band CDMA PCMCIA Modem</b>			
2006 Celltech Labs Inc.	This document is not to be reproduced in whole or in part without the prior written permission of Celltech Labs Inc.					Page 15 of 47

	Test Report Serial No.:	100305KBC-T672-S24C	Report Issue No.:	S672C-020906-R0
	Dates of Evaluation:	October 04, 21 & 24, 2005	Report Issue Date:	February 09, 2006
	Type of Evaluation:	RF Exposure SAR	FCC 47 CFR §2.1093	IC RSS-102 Issue 2

## MEASUREMENT UNCERTAINTIES (Cont.)

UNCERTAINTY BUDGET FOR SYSTEM VALIDATION						
Error Description	Uncertainty Value ±%	Probability Distribution	Divisor	ci 1g	Uncertainty Value ±% (1g)	V <sub>i</sub> or V <sub>eff</sub>
<b>Measurement System</b>						
Probe calibration	5.5	Normal	1	1	5.5	∞
Axial isotropy of the probe	4.7	Rectangular	1.732050808	1	2.7	∞
Spherical isotropy of the probe	0	Rectangular	1.732050808	1	0.0	∞
Spatial resolution	0	Rectangular	1.732050808	1	0.0	∞
Boundary effects	1	Rectangular	1.732050808	1	0.6	∞
Probe linearity	4.7	Rectangular	1.732050808	1	2.7	∞
Detection limit	1	Rectangular	1.732050808	1	0.6	∞
Readout electronics	0.3	Normal	1	1	0.3	∞
Response time	0	Rectangular	1.732050808	1	0.0	∞
Integration time	0	Rectangular	1.732050808	1	0.0	∞
RF ambient conditions	3	Rectangular	1.732050808	1	1.7	∞
Mech. constraints of robot	0.4	Rectangular	1.732050808	1	0.2	∞
Probe positioning	2.9	Rectangular	1.732050808	1	1.7	∞
Extrapolation & integration	1	Rectangular	1.732050808	1	0.6	∞
<b>Test Sample Related</b>						
Dipole Positioning	2	Normal	1.732050808	1	1.2	∞
Power & Power Drift	4.7	Normal	1.732050808	1	2.7	∞
<b>Phantom and Setup</b>						
Phantom uncertainty	4	Rectangular	1.732050808	1	2.3	∞
Liquid conductivity (target)	5	Rectangular	1.732050808	0.64	1.8	∞
Liquid conductivity (measured)	2.5	Normal	1	0.64	1.6	∞
Liquid permittivity (target)	5	Rectangular	1.732050808	0.6	1.7	∞
Liquid permittivity (measured)	2.5	Normal	1	0.6	1.5	∞
<b>Combined Standard Uncertainty</b>					<b>8.79</b>	
<b>Expanded Uncertainty (k=2)</b>					<b>17.57</b>	

Measurement Uncertainty Table in accordance with IEEE Standard 1528-2003 (see reference [5])

<b>Applicant:</b>	Itronix Corporation	<b>FCC ID:</b>	KBCIX325-AC580	<b>IC ID:</b>	1943A-IX325f	
<b>Model:</b>	IX325-AC580	<b>Type:</b>	IX325 Rugged Tablet PC with Dual-Band CDMA PCMCIA Modem			
2006 Celltech Labs Inc.	This document is not to be reproduced in whole or in part without the prior written permission of Celltech Labs Inc.					Page 16 of 47



	Test Report Serial No.:	100305KBC-T672-S24C	Report Issue No.:	S672C-020906-R0
	Dates of Evaluation:	October 04, 21 & 24, 2005	Report Issue Date:	February 09, 2006
	Type of Evaluation:	RF Exposure      SAR	FCC 47 CFR §2.1093	IC RSS-102 Issue 2

## 16.0 REFERENCES

- [1] Federal Communications Commission, "Radiofrequency radiation exposure evaluation: portable devices", Rule Part 47 CFR §2.1093: 1999.
- [2] Health Canada, "Limits of Human Exposure to Radiofrequency Electromagnetic Fields in the Frequency Range from 3 kHz to 300 GHz", Safety Code 6: 1999.
- [3] Federal Communications Commission, "Evaluating Compliance with FCC Guidelines for Human Exposure to Radio frequency Electromagnetic Fields", OET Bulletin 65, Supplement C (Edition 01-01), FCC, Washington, D.C.: June 2001.
- [4] Industry Canada, "Radio Frequency Exposure Compliance of Radiocommunication Apparatus (All Frequency Bands)", Radio Standards Specification RSS-102 Issue 2: November 2005.
- [5] IEEE Standard 1528-2003, "Recommended Practice for Determining the Peak Spatial-Average Specific Absorption Rate (SAR) in the Human Head from Wireless Communications Devices: Measurement Techniques": December 2003.
- [6] Schmid & Partner Engineering AG, "DASY4 Manual", V4.5 March 2005.

<b>Applicant:</b>	<b>Itronix Corporation</b>	<b>FCC ID:</b>	<b>KBCIX325-AC580</b>	<b>IC ID:</b>	<b>1943A-IX325f</b>	
<b>Model:</b>	<b>IX325-AC580</b>	<b>Type:</b>	<b>IX325 Rugged Tablet PC with Dual-Band CDMA PCMCIA Modem</b>			
2006 Celltech Labs Inc.	This document is not to be reproduced in whole or in part without the prior written permission of Celltech Labs Inc.					Page 17 of 47



Test Report Serial No.:	100305KBC-T672-S24C	Report Issue No.:	S672C-020906-R0	
Dates of Evaluation:	October 04, 21 & 24, 2005	Report Issue Date:	February 09, 2006	
Type of Evaluation:	RF Exposure	SAR	FCC 47 CFR §2.1093	IC RSS-102 Issue 2

**APPENDIX A - SAR MEASUREMENT DATA**

<b>Applicant:</b>	<b>Itronix Corporation</b>	<b>FCC ID:</b>	<b>KBCIX325-AC580</b>	<b>IC ID:</b>	<b>1943A-IX325f</b>	
<b>Model:</b>	<b>IX325-AC580</b>	<b>Type:</b>	<b>IX325 Rugged Tablet PC with Dual-Band CDMA PCMCIA Modem</b>			
2006 Celltech Labs Inc.	This document is not to be reproduced in whole or in part without the prior written permission of Celltech Labs Inc.					Page 18 of 47

	Test Report Serial No.:	100305KBC-T672-S24C	Report Issue No.:	S672C-020906-R0
	Dates of Evaluation:	October 04, 21 & 24, 2005	Report Issue Date:	February 09, 2006
	Type of Evaluation:	RF Exposure    SAR	FCC 47 CFR §2.1093	IC RSS-102 Issue 2

Date Tested: 10/04/2005

**Body SAR - Cellular CDMA - Bottom Side of DUT - Antenna “Perpendicular” - Channel 384**

**DUT: Itronix Model: IX325-AC580; Type: Tablet PC with PCS/Cellular CDMA PCMCIA Modem; Serial: ZZGEG5073ZZ9782**

Ambient Temp: 22.8 °C; Fluid Temp: 22.4 °C; Barometric Pressure: 101.6 kPa; Humidity: 32%

11.1V, 3600mAh Internal Lithium-ion Battery Pack (Model: T8M-E)

Communication System: Cellular CDMA

RF Output Power: 23.2 dBm (Conducted)

Frequency: 836.52 MHz; Channel 384; Duty Cycle: 1:1

Medium: M835 ( $\sigma = 0.99$  mho/m;  $\epsilon_r = 53.3$ ;  $\rho = 1000$  kg/m<sup>3</sup>)

- Probe: ET3DV6 - SN1387; ConvF(6.1, 6.1, 6.1); Calibrated: 18/03/2005
- Sensor-Surface: 4mm (Mechanical Surface Detection)
- Electronics: DAE4 Sn353; Calibrated: 15/06/2005
- Phantom: Barski Industries; Type: Fiberglass Planar; Serial: 03-01
- Measurement SW: DASY4, V4.6 Build 19; Postprocessing SW: SEMCAD, V1.8 Build 159

**Body SAR - Cellular CDMA - 0.0 cm Separation Distance from Bottom of DUT to Planar Phantom - Channel 384**  
**Area Scan (8x9x1):** Measurement grid: dx=15mm, dy=15mm

**Body SAR - Cellular CDMA - 0.0 cm Separation Distance from Bottom of DUT to Planar Phantom - Channel 384**  
**Zoom Scan (7x7x7)/Cube 0:** Measurement grid: dx=5mm, dy=5mm, dz=5mm  
Reference Value = 5.81 V/m; Power Drift = -0.503 dB  
Peak SAR (extrapolated) = 0.049 W/kg  
**SAR(1 g) = 0.0305 mW/g; SAR(10 g) = 0.0209 mW/g**

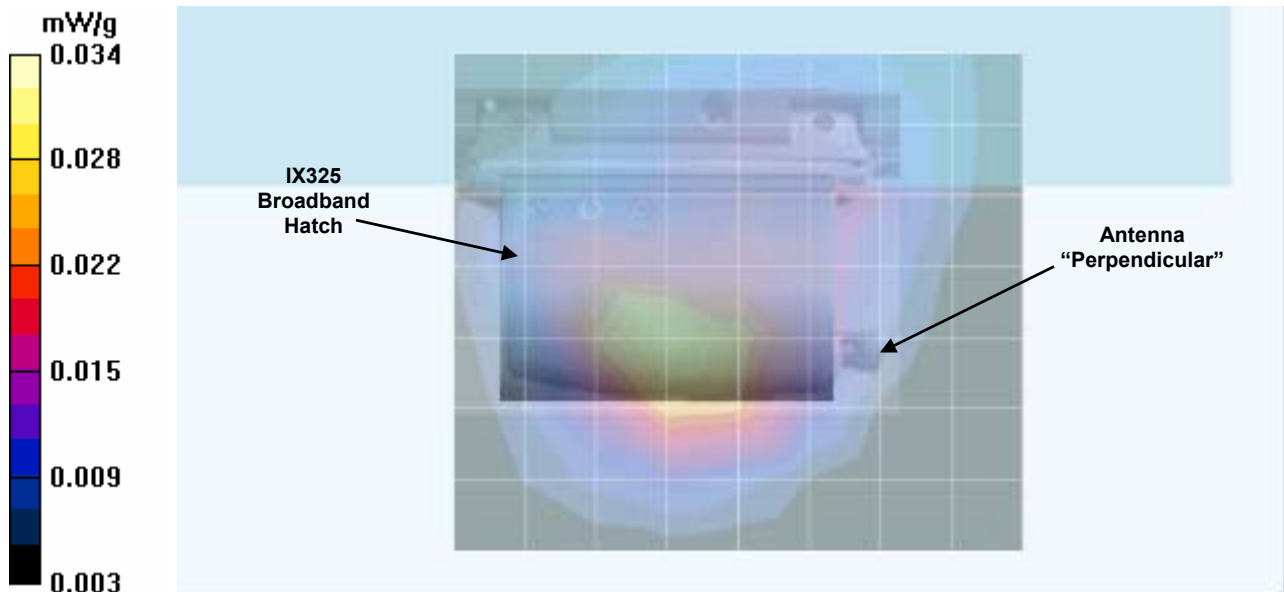

<b>Applicant:</b>	Itronix Corporation	<b>FCC ID:</b>	KBCIX325-AC580	<b>IC ID:</b>	1943A-IX325f	
<b>Model:</b>	IX325-AC580	<b>Type:</b>	IX325 Rugged Tablet PC with Dual-Band CDMA PCMCIA Modem			
2006 Celltech Labs Inc.	This document is not to be reproduced in whole or in part without the prior written permission of Celltech Labs Inc.					Page 19 of 47

Test Report Serial No.:	100305KBC-T672-S24C	Report Issue No.:	S672C-020906-R0
Dates of Evaluation:	October 04, 21 & 24, 2005	Report Issue Date:	February 09, 2006
Type of Evaluation:	RF Exposure	SAR	FCC 47 CFR §2.1093
			IC RSS-102 Issue 2

Date Tested: 10/04/2005

**Body SAR - Cellular CDMA - Bottom Side of DUT - Antenna “Parallel Straight” - Channel 384**

**DUT: Itronix Model: IX325-AC580; Type: Tablet PC with PCS/Cellular CDMA PCMCIA Modem; Serial: ZZGEG5073ZZ9782**

Ambient Temp: 22.8 °C; Fluid Temp: 22.4 °C; Barometric Pressure: 101.6 kPa; Humidity: 32%

11.1V, 3600mAh Internal Lithium-ion Battery Pack (Model: T8M-E)  
 Communication System: Cellular CDMA  
 RF Output Power: 23.2 dBm (Conducted)  
 Frequency: 836.52 MHz; Channel 384; Duty Cycle: 1:1  
 Medium: M835 ( $\sigma = 0.99$  mho/m;  $\epsilon_r = 53.3$ ;  $\rho = 1000$  kg/m<sup>3</sup>)

- Probe: ET3DV6 - SN1387; ConvF(6.1, 6.1, 6.1); Calibrated: 18/03/2005
- Sensor-Surface: 4mm (Mechanical Surface Detection)
- Electronics: DAE4 Sn353; Calibrated: 15/06/2005
- Phantom: Barski Industries; Type: Fiberglas Planar; Serial: 03-01
- Measurement SW: DASY4, V4.6 Build 19; Postprocessing SW: SEMCAD, V1.8 Build 159

**Body SAR - Cellular CDMA - 0.0 cm Separation Distance from Bottom of DUT to Planar Phantom - Channel 384  
 Area Scan (16x9x1): Measurement grid: dx=15mm, dy=15mm**

**Body SAR - Cellular CDMA - 0.0 cm Separation Distance from Bottom of DUT to Planar Phantom - Channel 384  
 Zoom Scan (7x7x7)/Cube 0: Measurement grid: dx=5mm, dy=5mm, dz=5mm**  
 Reference Value = 8.83 V/m; Power Drift = -0.140 dB  
 Peak SAR (extrapolated) = 0.094 W/kg  
**SAR(1 g) = 0.0673 mW/g; SAR(10 g) = 0.0449 mW/g**

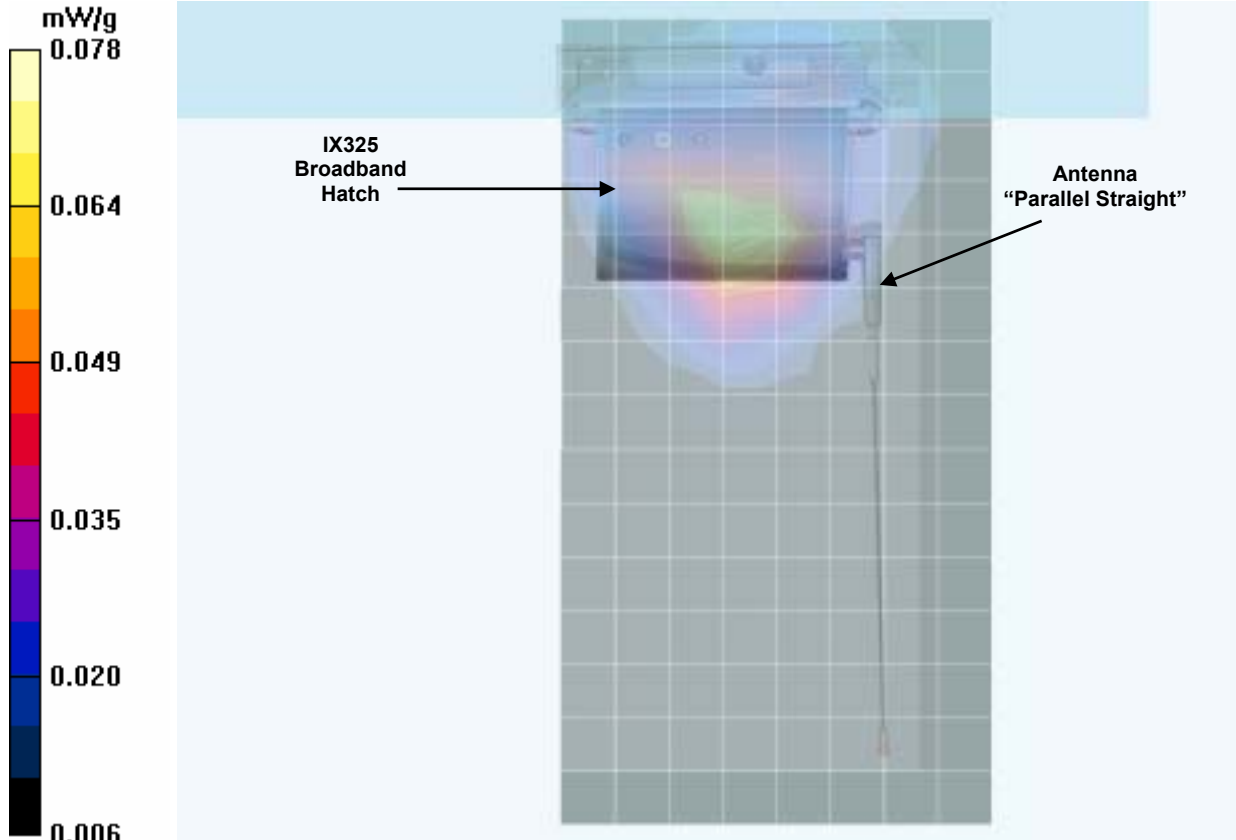

**Fluid Depth (≥ 15 cm)**



Date Tested: 10/24/2005

**2<sup>nd</sup> Scan**

**Body SAR - Cellular CDMA - Bottom Side of DUT - Antenna “Parallel Straight” - Channel 384**

**DUT: Itronix Model: IX325-AC580; Type: Tablet PC with PCS/Cellular CDMA PCMCIA Modem; Serial: ZZGEG5073ZZ9782**

Ambient Temp: 23.7 °C; Fluid Temp: 22.4 °C; Barometric Pressure: 102.3 kPa; Humidity: 32%

11.1V, 3600mAh Internal Lithium-ion Battery Pack (Model: T8M-E)  
 Communication System: Cellular CDMA  
 RF Output Power: 23.2 dBm (Conducted)  
 Frequency: 836.52 MHz; Channel 384; Duty Cycle: 1:1  
 Medium: M835 ( $\sigma = 0.98 \text{ mho/m}$ ;  $\epsilon_r = 52.6$ ;  $\rho = 1000 \text{ kg/m}^3$ )

- Probe: ET3DV6 - SN1387; ConvF(6.1, 6.1, 6.1); Calibrated: 18/03/2005
- Sensor-Surface: 4mm (Mechanical Surface Detection)
- Electronics: DAE4 Sn353; Calibrated: 15/06/2005
- Phantom: Barski Industries; Type: Fiberglass Planar; Serial: 03-01
- Measurement SW: DASy4, V4.6 Build 19; Postprocessing SW: SEMCAD, V1.8 Build 159

**Body SAR - Cellular CDMA - 0.0 cm Separation Distance from Bottom of DUT to Planar Phantom - Channel 384**  
**Area Scan (18x23x1):** Measurement grid: dx=15mm, dy=15mm

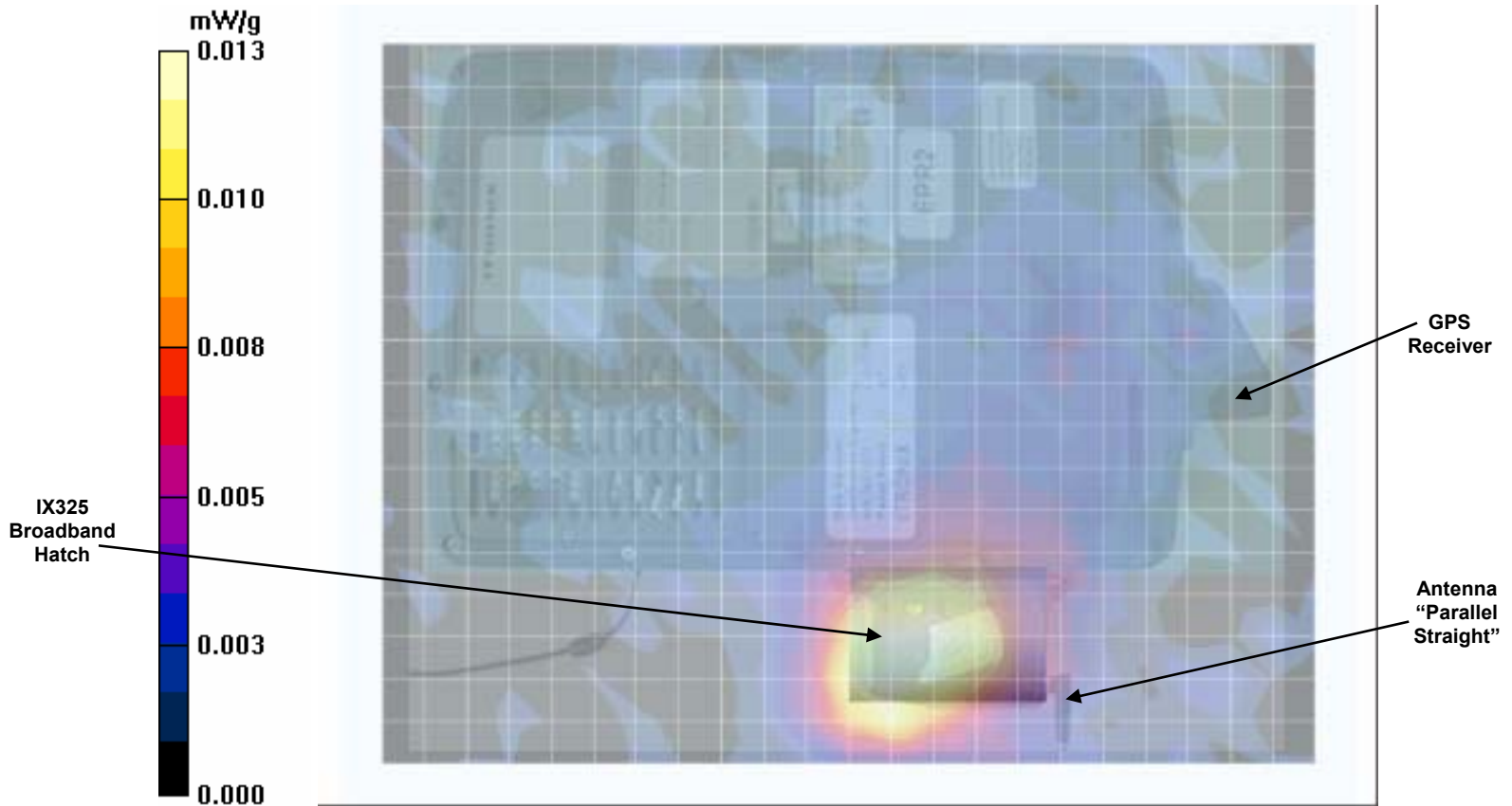

**2<sup>nd</sup> Scan to show SAR Distribution over the entire bottom surface of the Tablet PC**

Date Tested: 10/04/2005

**Body SAR - Cellular CDMA - Bottom Side of DUT - Antenna “Parallel Bent” - Channel 384**

**DUT: Itronix Model: IX325-AC580; Type: Tablet PC with PCS/Cellular CDMA PCMCIA Modem; Serial: ZZGEG5073ZZ9782**

Ambient Temp: 22.8 °C; Fluid Temp: 22.4 °C; Barometric Pressure: 101.6 kPa; Humidity: 32%

11.1V, 3600mAh Internal Lithium-ion Battery Pack (Model: T8M-E)  
 Communication System: Cellular CDMA  
 RF Output Power: 23.2 dBm (Conducted)  
 Frequency: 836.52 MHz; Channel 384; Duty Cycle: 1:1  
 Medium: M835 ( $\sigma = 0.99$  mho/m;  $\epsilon_r = 53.3$ ;  $\rho = 1000$  kg/m<sup>3</sup>)

- Probe: ET3DV6 - SN1387; ConvF(6.1, 6.1, 6.1); Calibrated: 18/03/2005
- Sensor-Surface: 4mm (Mechanical Surface Detection)
- Electronics: DAE4 Sn353; Calibrated: 15/06/2005
- Phantom: Barski Industries; Type: Fiberglass Planar; Serial: 03-01
- Measurement SW: DASY4, V4.6 Build 19; Postprocessing SW: SEMCAD, V1.8 Build 159

**Body SAR - Cellular CDMA - 0.0 cm Separation Distance from Bottom of DUT to Planar Phantom - Channel 384 Area Scan (8x16x1): Measurement grid: dx=15mm, dy=15mm**

**Body SAR - Cellular CDMA - 0.0 cm Separation Distance from Bottom of DUT to Planar Phantom - Channel 384 Zoom Scan (7x7x7)/Cube 0: Measurement grid: dx=5mm, dy=5mm, dz=5mm**  
 Reference Value = 6.28 V/m; Power Drift = -0.498 dB  
 Peak SAR (extrapolated) = 0.058 W/kg  
**SAR(1 g) = 0.0394 mW/g; SAR(10 g) = 0.0274 mW/g**

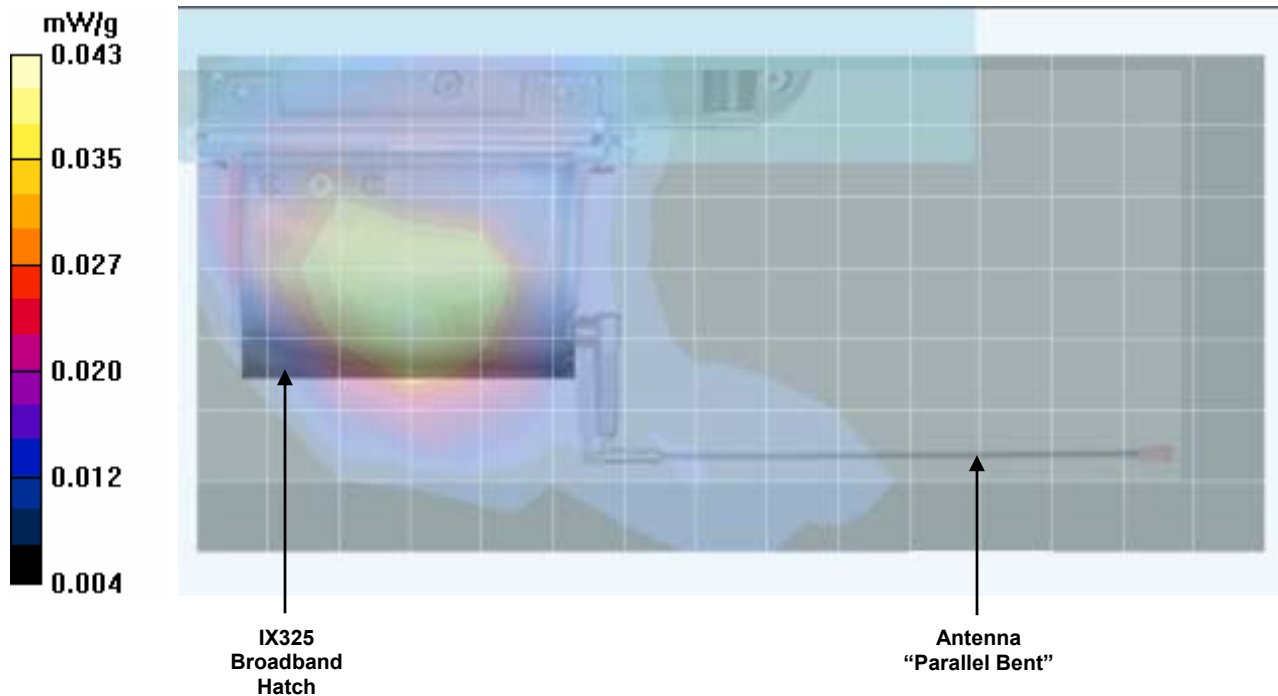

Test Report Serial No.:	100305KBC-T672-S24C	Report Issue No.:	S672C-020906-R0
Dates of Evaluation:	October 04, 21 & 24, 2005	Report Issue Date:	February 09, 2006
Type of Evaluation:	RF Exposure	SAR	FCC 47 CFR §2.1093 IC RSS-102 Issue 2

Date Tested: 10/21/2005

**Body SAR - PCS CDMA - Bottom Side of DUT - Antenna "Parallel Straight" - Channel 600**

**DUT: Itronix Model: IX325-AC580; Type: Tablet PC with PCS/Cellular CDMA PCMCIA Modem; Serial: ZZGEG5073ZZ9782**

Ambient Temp: 23.4 °C; Fluid Temp: 22.0 °C; Barometric Pressure: 103.0 kPa; Humidity: 31%

11.1V, 3600mAh Internal Lithium-ion Battery Pack (Model: T8M-E)  
 Communication System: PCS CDMA  
 RF Output Power: 24.2 dBm (Conducted)  
 Frequency: 1880.00 MHz; Channel 600; Duty Cycle: 1:1  
 Medium: M1880 ( $\sigma = 1.46 \text{ mho/m}$ ;  $\epsilon_r = 50.8$ ;  $\rho = 1000 \text{ kg/m}^3$ )

- Probe: ET3DV6 - SN1387; ConvF(4.75, 4.75, 4.75); Calibrated: 18/03/2005
- Sensor-Surface: 4mm (Mechanical Surface Detection)
- Electronics: DAE4 Sn353; Calibrated: 15/06/2005
- Phantom: Barski Industries; Type: Fiberglass Planar; Serial: 03-01
- Measurement SW: DASY4, V4.6 Build 19; Postprocessing SW: SEMCAD, V1.8 Build 159

**Body SAR - PCS CDMA - 0.0 cm Separation Distance from Bottom of DUT to Planar Phantom - Channel 600**  
**Area Scan (16x9x1):** Measurement grid: dx=15mm, dy=15mm

**Body SAR - PCS CDMA - 0.0 cm Separation Distance from Bottom of DUT to Planar Phantom - Channel 600**  
**Zoom Scan (7x7x7)/Cube 0:** Measurement grid: dx=5mm, dy=5mm, dz=5mm  
 Reference Value = 10.2 V/m; Power Drift = -0.0483 dB  
 Peak SAR (extrapolated) = 0.202 W/kg  
**SAR(1 g) = 0.130 mW/g; SAR(10 g) = 0.079 mW/g**

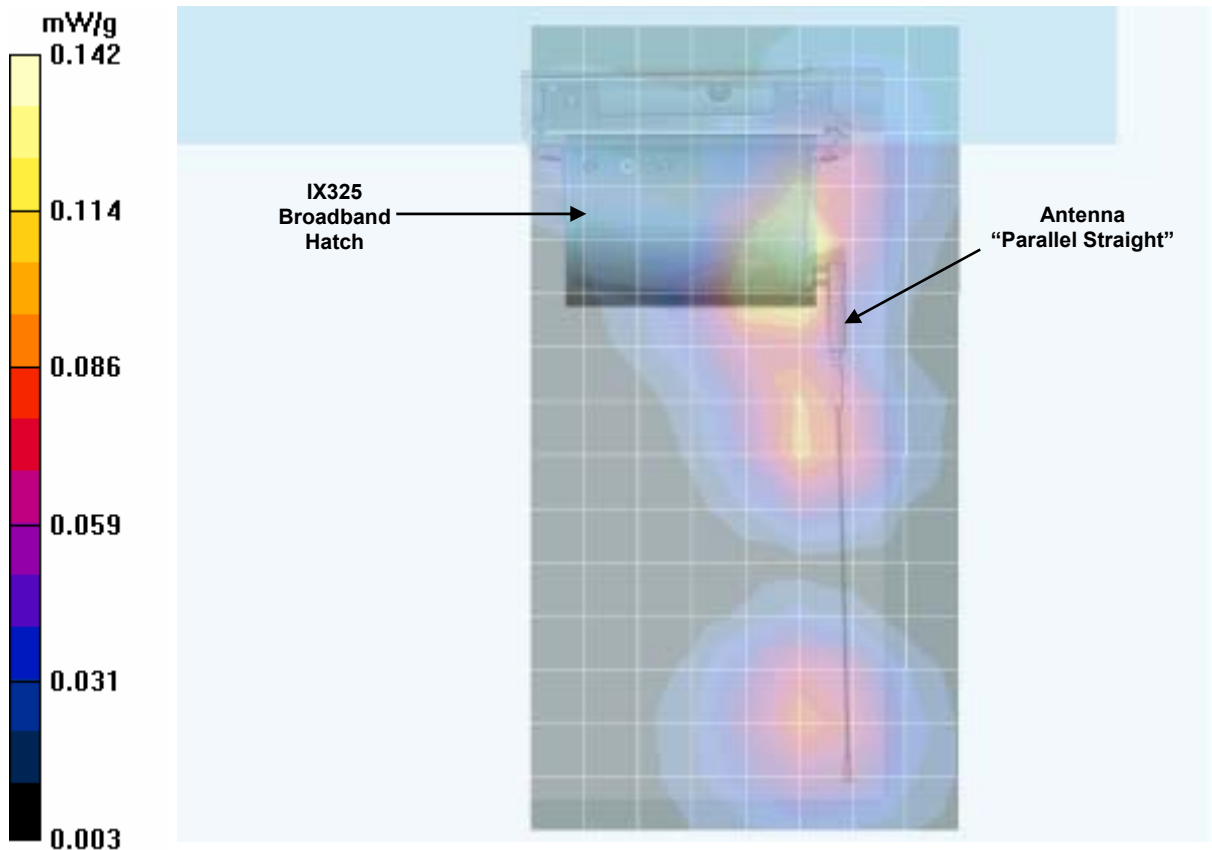



### Z-Axis Scan

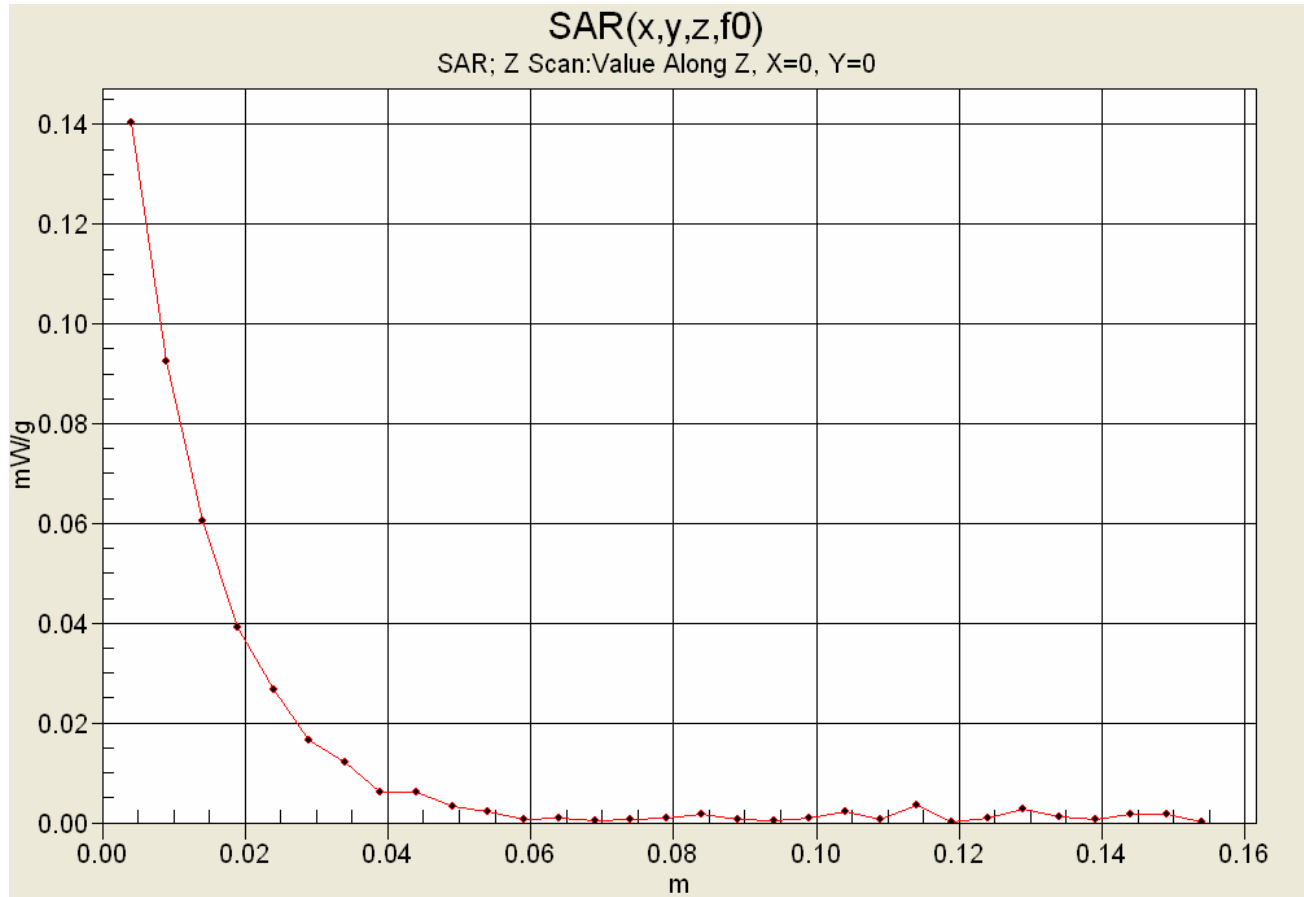

Date Tested: 10/21/2005

## 2<sup>nd</sup> Scan

### Body SAR - PCS CDMA - Bottom Side of DUT - Antenna "Parallel Straight" - Channel 600

DUT: Itronix Model: IX325-AC580; Type: Tablet PC with PCS/Cellular CDMA PCMCIA Modem; Serial: ZZGEG5073ZZ9782

Ambient Temp: 23.4 °C; Fluid Temp: 22.0 °C; Barometric Pressure: 103.0 kPa; Humidity: 31%

11.1V, 3600mAh Internal Lithium-ion Battery Pack (Model: T8M-E)

Communication System: PCS CDMA

RF Output Power: 24.2 dBm (Conducted)

Frequency: 1880.00 MHz; Channel 600; Duty Cycle: 1:1

Medium: M1880 ( $\sigma = 1.46 \text{ mho/m}$ ;  $\epsilon_r = 50.8$ ;  $\rho = 1000 \text{ kg/m}^3$ )

- Probe: ET3DV6 - SN1387; ConvF(4.75, 4.75, 4.75); Calibrated: 18/03/2005
- Sensor-Surface: 4mm (Mechanical Surface Detection)
- Electronics: DAE4 Sn353; Calibrated: 15/06/2005
- Phantom: Barski Industries; Type: Fiberglas Planar; Serial: 03-01
- Measurement SW: DASY4, V4.6 Build 19; Postprocessing SW: SEMCAD, V1.8 Build 159

### Body SAR - PCS CDMA - 0.0 cm Separation Distance from Bottom of DUT to Planar Phantom - Channel 600

Area Scan (18x23x1): Measurement grid: dx=15mm, dy=15mm

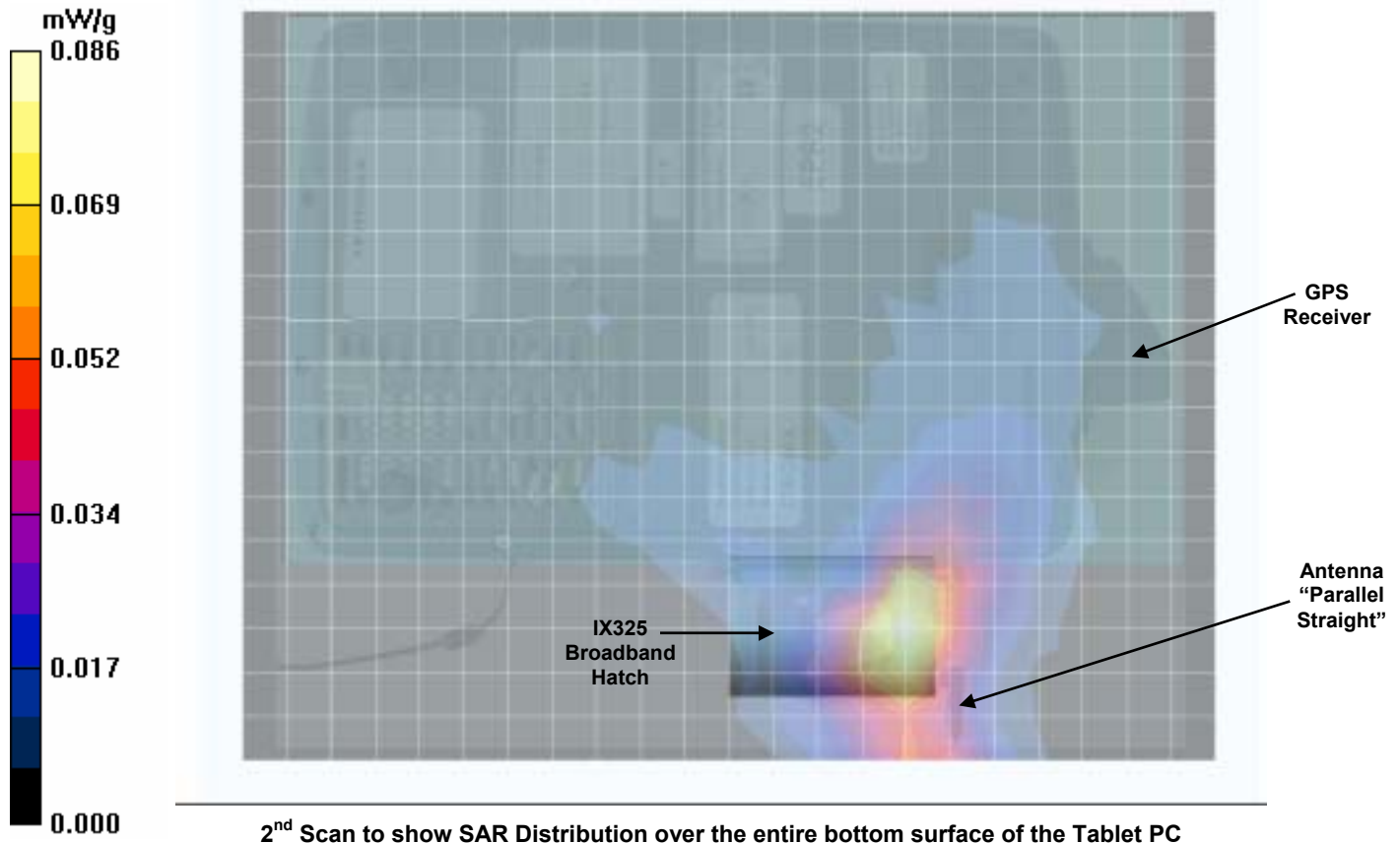

Test Report Serial No.:	100305KBC-T672-S24C	Report Issue No.:	S672C-020906-R0
Dates of Evaluation:	October 04, 21 & 24, 2005	Report Issue Date:	February 09, 2006
Type of Evaluation:	RF Exposure	SAR	FCC 47 CFR §2.1093
			IC RSS-102 Issue 2

Date Tested: 10/21/2005

**Body SAR - PCS CDMA - Bottom Side of DUT - Antenna “Parallel Bent” - Channel 600**

**DUT: Itronix Model: IX325-AC580; Type: Tablet PC with PCS/Cellular CDMA PCMCIA Modem; Serial: ZZGEG5073ZZ9782**

Ambient Temp: 23.4 °C; Fluid Temp: 22.0 °C; Barometric Pressure: 103.0 kPa; Humidity: 31%

11.1V, 3600mAh Internal Lithium-ion Battery Pack (Model: T8M-E)  
 Communication System: PCS CDMA  
 RF Output Power: 24.2 dBm (Conducted)  
 Frequency: 1880.00 MHz; Channel 600; Duty Cycle: 1:1  
 Medium: M1880 ( $\sigma = 1.46 \text{ mho/m}$ ;  $\epsilon_r = 50.8$ ;  $\rho = 1000 \text{ kg/m}^3$ )

- Probe: ET3DV6 - SN1387; ConvF(4.75, 4.75, 4.75); Calibrated: 18/03/2005
- Sensor-Surface: 4mm (Mechanical Surface Detection)
- Electronics: DAE4 Sn353; Calibrated: 15/06/2005
- Phantom: Barski Industries; Type: Fiberglass Planar; Serial: 03-01
- Measurement SW: DASY4, V4.6 Build 19; Postprocessing SW: SEMCAD, V1.8 Build 159

**Body SAR - PCS CDMA - 0.0 cm Separation Distance from Bottom of DUT to Planar Phantom - Channel 600  
 Area Scan (8x16x1): Measurement grid: dx=15mm, dy=15mm**

**Body SAR - PCS CDMA - 0.0 cm Separation Distance from Bottom of DUT to Planar Phantom - Channel 600  
 Zoom Scan (7x7x7)/Cube 0: Measurement grid: dx=5mm, dy=5mm, dz=5mm**  
 Reference Value = 8.79 V/m; Power Drift = 0.000159 dB  
 Peak SAR (extrapolated) = 0.141 W/kg  
**SAR(1 g) = 0.0939 mW/g; SAR(10 g) = 0.059 mW/g**

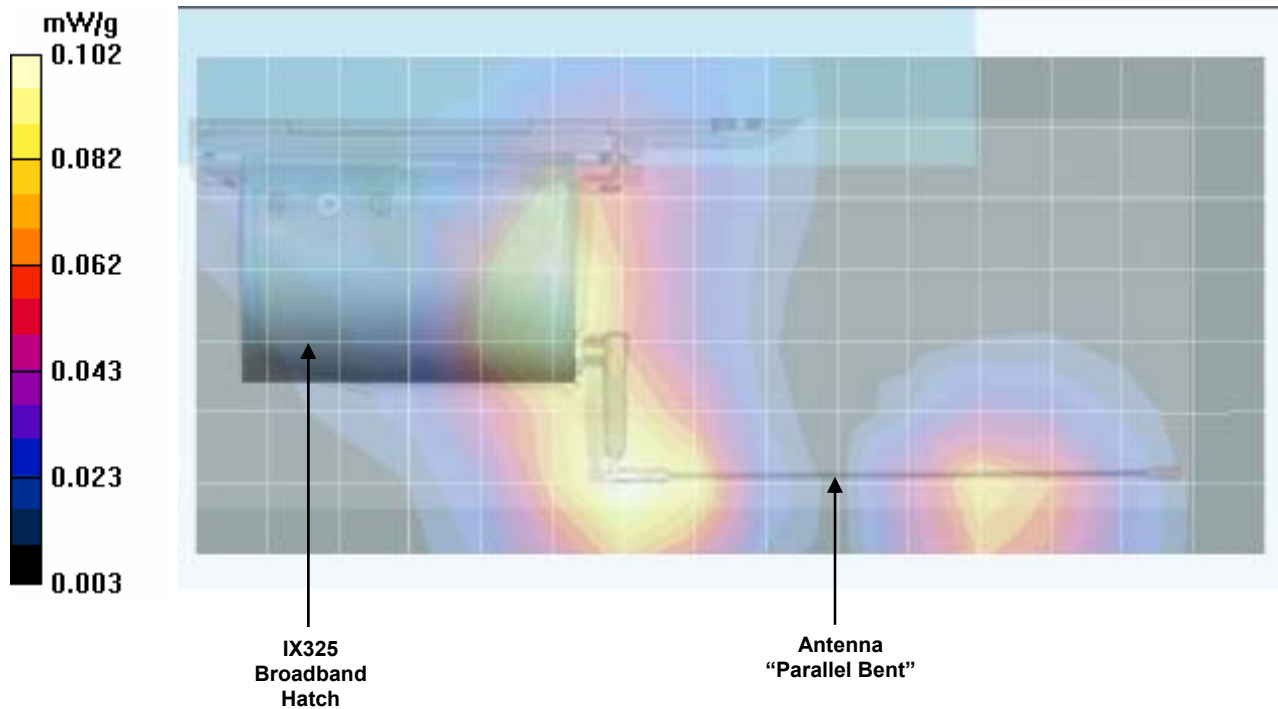

Date Tested: 10/21/2005

**Body SAR - PCS CDMA - Bottom Side of DUT - Antenna “Perpendicular” - Channel 600**

**DUT: Itronix Model: IX325-AC580; Type: Tablet PC with PCS/Cellular CDMA PCMCIA Modem; Serial: ZZGEG5073ZZ9782**

Ambient Temp: 23.4 °C; Fluid Temp: 22.0 °C; Barometric Pressure: 103.0 kPa; Humidity: 31%

11.1V, 3600mAh Internal Lithium-ion Battery Pack (Model: T8M-E)

Communication System: PCS CDMA

RF Output Power: 24.2 dBm (Conducted)

Frequency: 1880.00 MHz; Channel 600; Duty Cycle: 1:1

Medium: M1880 ( $\sigma = 1.46 \text{ mho/m}$ ;  $\epsilon_r = 50.8$ ;  $\rho = 1000 \text{ kg/m}^3$ )

- Probe: ET3DV6 - SN1387; ConvF(4.75, 4.75, 4.75); Calibrated: 18/03/2005
- Sensor-Surface: 4mm (Mechanical Surface Detection)
- Electronics: DAE4 Sn353; Calibrated: 15/06/2005
- Phantom: Barski Industries; Type: Fiberglass Planar; Serial: 03-01
- Measurement SW: DASY4, V4.6 Build 19; Postprocessing SW: SEMCAD, V1.8 Build 159

**Body SAR - PCS CDMA - 0.0 cm Separation Distance from Bottom of DUT to Planar Phantom - Channel 600**  
**Area Scan (8x9x1):** Measurement grid: dx=15mm, dy=15mm

**Body SAR - PCS CDMA - 0.0 cm Separation Distance from Bottom of DUT to Planar Phantom - Channel 600**  
**Zoom Scan (7x7x7)/Cube 0:** Measurement grid: dx=5mm, dy=5mm, dz=5mm  
 Reference Value = 8.44 V/m; Power Drift = -0.134 dB  
 Peak SAR (extrapolated) = 0.133 W/kg  
**SAR(1 g) = 0.0882 mW/g; SAR(10 g) = 0.055 mW/g**

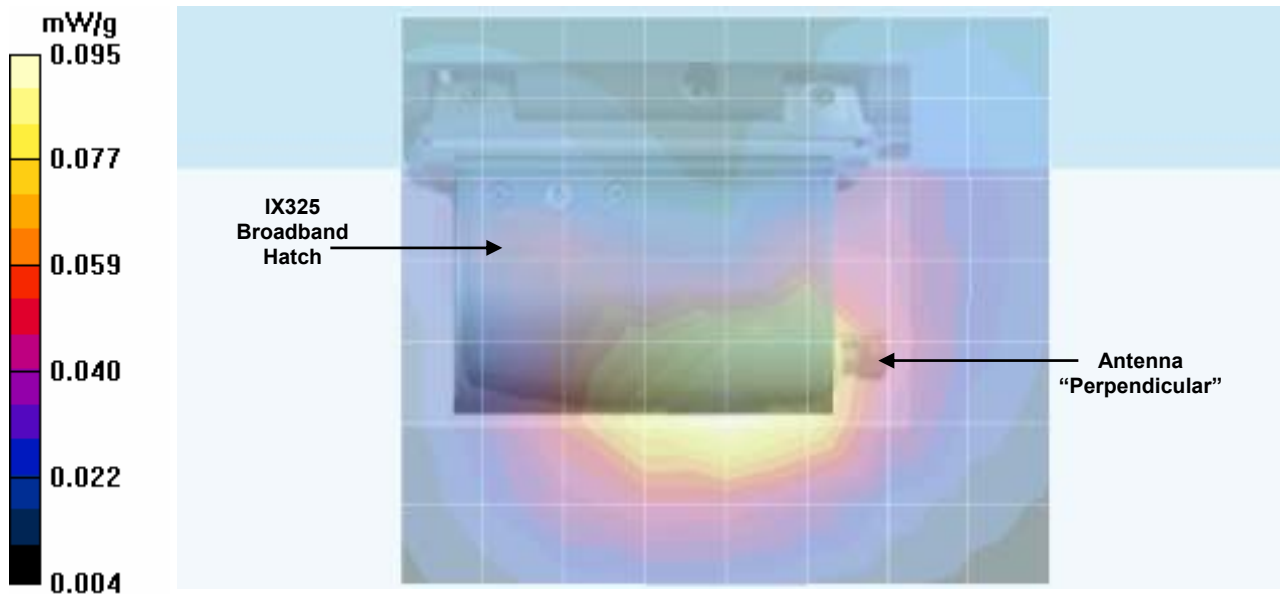

	Test Report Serial No.:	100305KBC-T672-S24C	Report Issue No.:	S672C-020906-R0
	Dates of Evaluation:	October 04, 21 & 24, 2005	Report Issue Date:	February 09, 2006
	Type of Evaluation:	RF Exposure	SAR	FCC 47 CFR §2.1093

## APPENDIX B - SYSTEM PERFORMANCE CHECK DATA

<b>Applicant:</b>	Itronix Corporation	<b>FCC ID:</b>	KBCIX325-AC580	<b>IC ID:</b>	1943A-IX325f	
<b>Model:</b>	IX325-AC580	<b>Type:</b>	IX325 Rugged Tablet PC with Dual-Band CDMA PCMCIA Modem			
2006 Celltech Labs Inc.	This document is not to be reproduced in whole or in part without the prior written permission of Celltech Labs Inc.					Page 29 of 47

	Test Report Serial No.:	100305KBC-T672-S24C	Report Issue No.:	S672C-020906-R0
	Dates of Evaluation:	October 04, 21 & 24, 2005	Report Issue Date:	February 09, 2006
	Type of Evaluation:	RF Exposure    SAR	FCC 47 CFR §2.1093	IC RSS-102 Issue 2

Date Tested: 10/04/2005

### System Performance Check (Body) - 835 MHz Dipole

**DUT: Dipole 835 MHz; Model: D835V2; Type; System Performance Check; Serial: 411; Calibrated: 04/12/2005**

Ambient Temp: 24.1 °C; Fluid Temp: 22.4 °C; Barometric Pressure: 101.5 kPa; Humidity: 31%

Communication System: CW  
 Forward Conducted Power: 250 mW  
 Frequency: 835 MHz; Duty Cycle: 1:1  
 Medium: M835 ( $\sigma = 0.99$  mho/m;  $\epsilon_r = 53.3$ ;  $\rho = 1000$  kg/m<sup>3</sup>)

- Probe: ET3DV6 - SN1387; ConvF(6.1, 6.1, 6.1); Calibrated: 18/03/2005
- Sensor-Surface: 4mm (Mechanical Surface Detection)
- Electronics: DAE4 Sn353; Calibrated: 15/06/2005
- Phantom: Barski Industries; Type: Fiberglass Planar; Serial: 03-01
- Measurement SW: DASY4, V4.6 Build 19; Postprocessing SW: SEMCAD, V1.8 Build 159

#### 835 MHz Dipole - System Performance Check/Area Scan (6x10x1):

Measurement grid: dx=10mm, dy=10mm

#### 835 MHz Dipole - System Performance Check/Zoom Scan (7x7x7)/Cube 0:

Measurement grid: dx=5mm, dy=5mm, dz=5mm  
 Reference Value = 55.2 V/m; Power Drift = -0.049 dB  
 Peak SAR (extrapolated) = 3.80 W/kg  
**SAR(1 g) = 2.61 mW/g; SAR(10 g) = 1.71 mW/g**

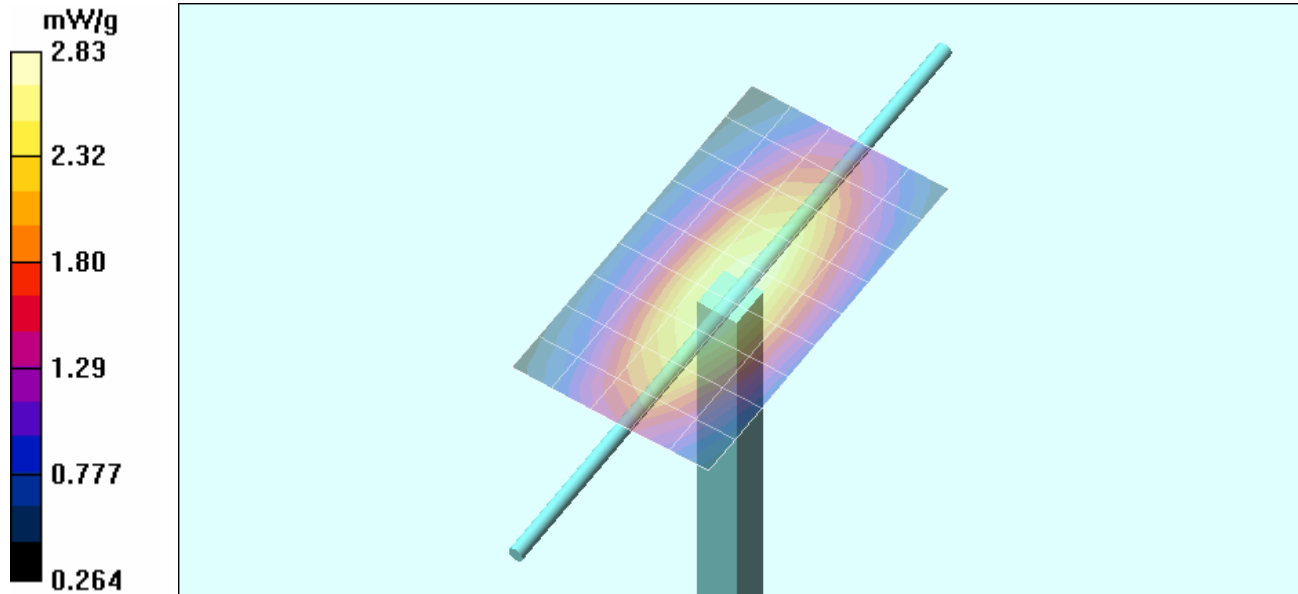

<b>Applicant:</b>	Itronix Corporation	<b>FCC ID:</b>	KBCIX325-AC580	<b>IC ID:</b>	1943A-IX325f	
<b>Model:</b>	IX325-AC580	<b>Type:</b>	IX325 Rugged Tablet PC with Dual-Band CDMA PCMCIA Modem			
2006 Celltech Labs Inc.	This document is not to be reproduced in whole or in part without the prior written permission of Celltech Labs Inc.					Page 30 of 47

	Test Report Serial No.:	100305KBC-T672-S24C	Report Issue No.:	S672C-020906-R0
	Dates of Evaluation:	October 04, 21 & 24, 2005	Report Issue Date:	February 09, 2006
	Type of Evaluation:	RF Exposure SAR	FCC 47 CFR §2.1093	IC RSS-102 Issue 2

### Z-Axis Scan

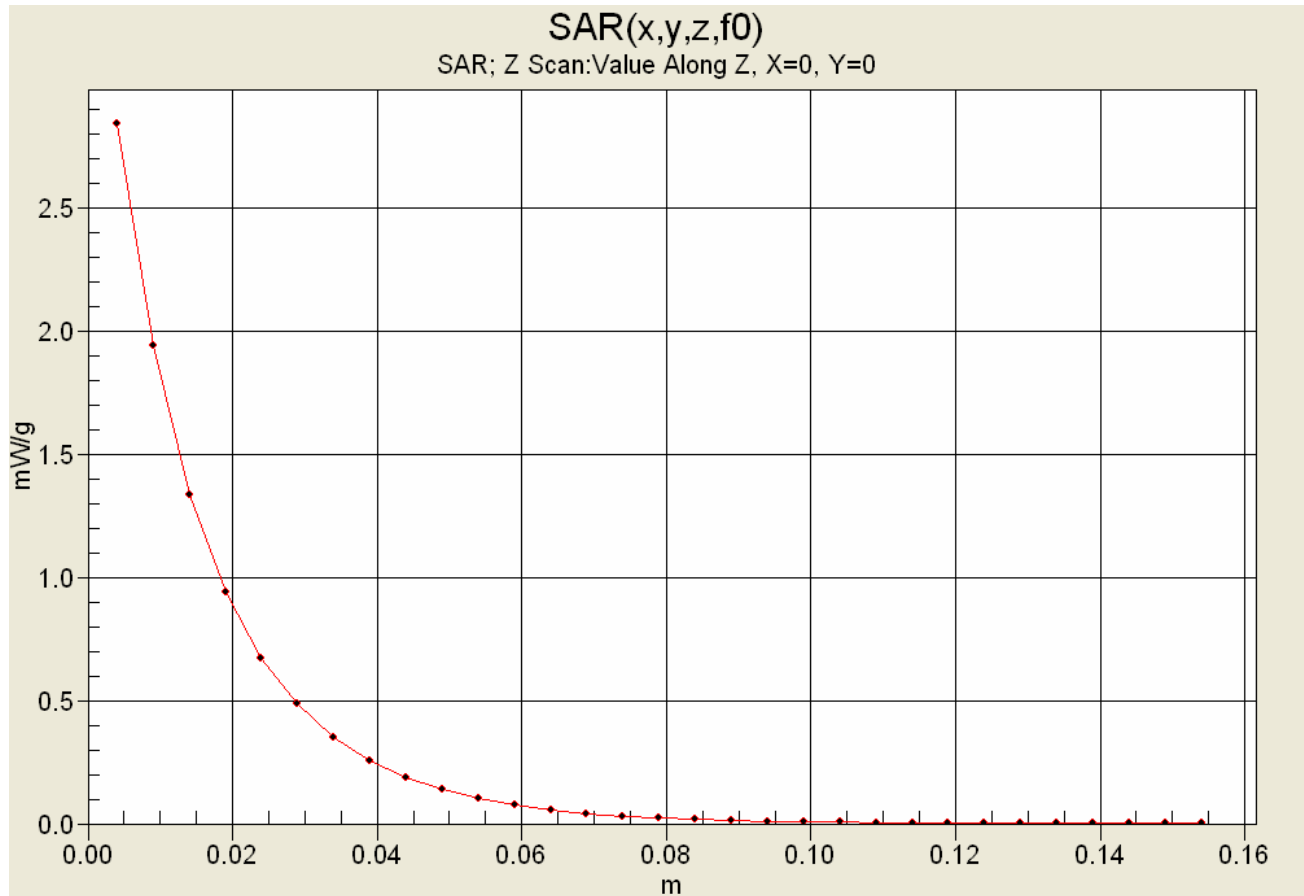

<b>Applicant:</b>	Itronix Corporation	<b>FCC ID:</b>	KBCIX325-AC580	<b>IC ID:</b>	1943A-IX325f	
<b>Model:</b>	IX325-AC580	<b>Type:</b>	IX325 Rugged Tablet PC with Dual-Band CDMA PCMCIA Modem			
2006 Celltech Labs Inc.		This document is not to be reproduced in whole or in part without the prior written permission of Celltech Labs Inc.				Page 31 of 47

Date Tested: 10/21/2005

### System Performance Check (Body) - 1900 MHz Dipole

**DUT: Dipole 1900 MHz; Model: D1900V2; Type: System Performance Check; Serial: 151; Calibrated: 06/17/2005**

Ambient Temp: 23.0 °C; Fluid Temp: 22.0 °C; Barometric Pressure: 103.0 kPa; Humidity: 31%

Communication System: CW  
 Forward Conducted Power: 250 mW  
 Frequency: 1900 MHz; Duty Cycle: 1:1  
 Medium: M1900 ( $\sigma = 1.48$  mho/m;  $\epsilon_r = 50.7$ ;  $\rho = 1000$  kg/m<sup>3</sup>)

- Probe: ET3DV6 - SN1387; ConvF(4.75, 4.75, 4.75); Calibrated: 18/03/2005
- Sensor-Surface: 4mm (Mechanical Surface Detection)
- Electronics: DAE4 Sn353; Calibrated: 15/06/2005
- Phantom: Barski Industries; Type: Fiberglass Planar; Serial: 03-01
- Measurement SW: DASY4, V4.6 Build 19; Postprocessing SW: SEMCAD, V1.8 Build 159

#### 1900 MHz Dipole - System Performance Check/Area Scan (5x8x1):

Measurement grid: dx=15mm, dy=15mm

#### 1900 MHz Dipole - System Performance Check/Zoom Scan (7x7x7)/Cube 0:

Measurement grid: dx=5mm, dy=5mm, dz=5mm  
 Reference Value = 91.5 V/m; Power Drift = 0.027 dB  
 Peak SAR (extrapolated) = 17.6 W/kg  
**SAR(1 g) = 10.2 mW/g; SAR(10 g) = 5.35 mW/g**

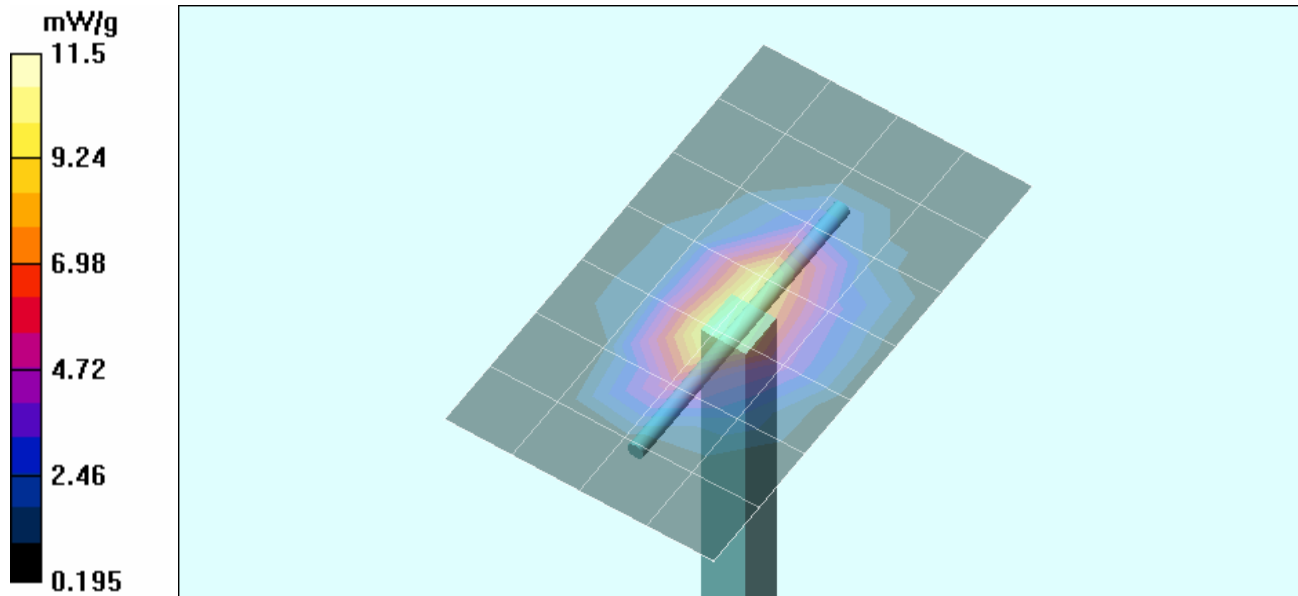



### Z-Axis Scan

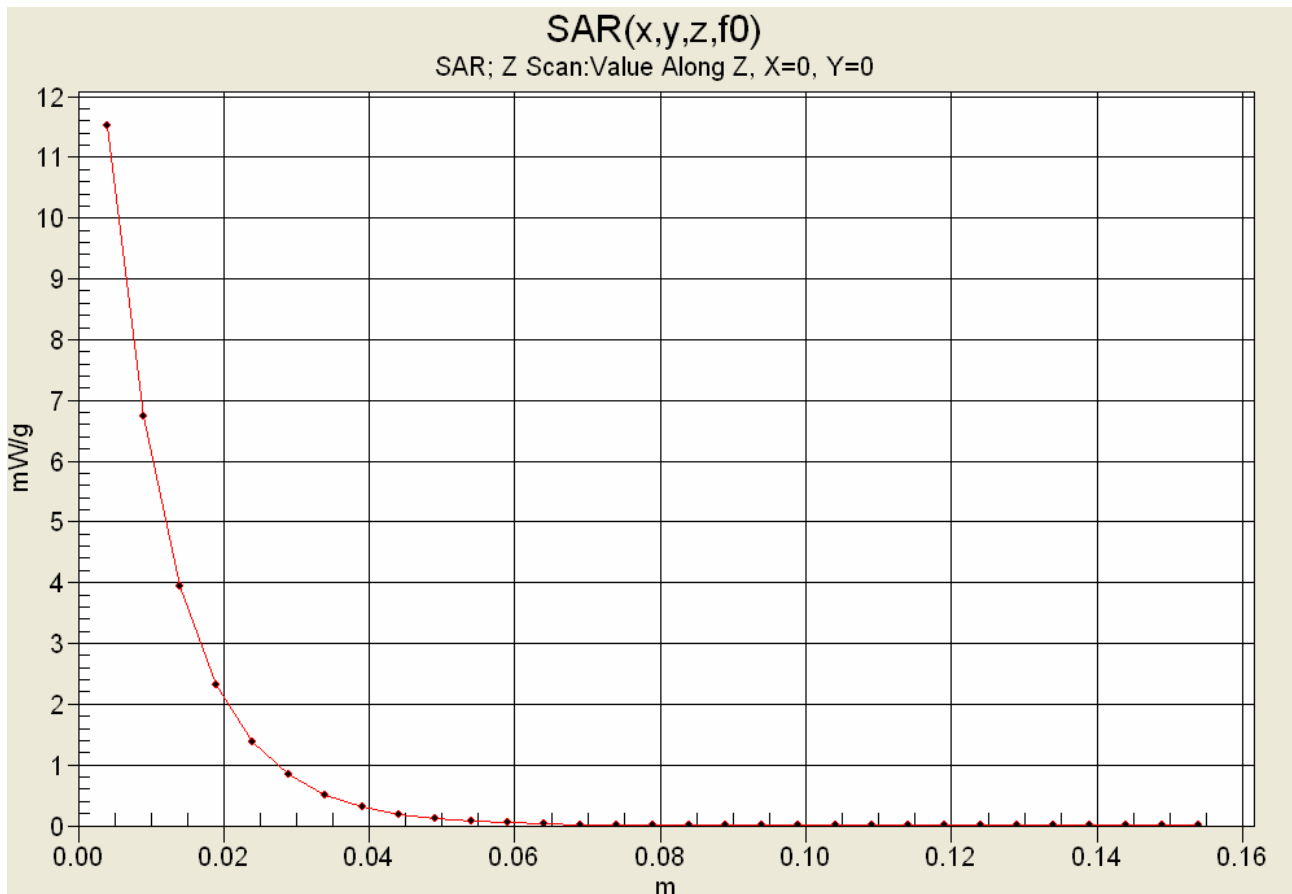

Date Tested: 10/24/2005

### System Performance Check (Body) - 835 MHz Dipole

**DUT: Dipole 835 MHz; Model: D835V2; Type: System Performance Check; Serial: 411; Calibrated: 04/12/2005**

Ambient Temp: 23.4 °C; Fluid Temp: 22.4 °C; Barometric Pressure: 102.3 kPa; Humidity: 32%

Communication System: CW

Forward Conducted Power: 250 mW

Frequency: 835 MHz; Duty Cycle: 1:1

Medium: M835 ( $\sigma = 0.98$  mho/m;  $\epsilon_r = 52.6$ ;  $\rho = 1000$  kg/m<sup>3</sup>)

- Probe: ET3DV6 - SN1387; ConvF(6.1, 6.1, 6.1); Calibrated: 18/03/2005
- Sensor-Surface: 4mm (Mechanical Surface Detection)
- Electronics: DAE4 Sn353; Calibrated: 15/06/2005
- Phantom: Barski Industries; Type: Fiberglass Planar; Serial: 03-01
- Measurement SW: DASY4, V4.6 Build 19; Postprocessing SW: SEMCAD, V1.8 Build 159

#### 835 MHz Dipole - System Performance Check/Area Scan (6x10x1):

Measurement grid: dx=10mm, dy=10mm

#### 835 MHz Dipole - System Performance Check/Zoom Scan (7x7x7)/Cube 0:

Measurement grid: dx=5mm, dy=5mm, dz=5mm

Reference Value = 55.5 V/m; Power Drift = -0.060 dB

Peak SAR (extrapolated) = 3.82 W/kg

**SAR(1 g) = 2.63 mW/g; SAR(10 g) = 1.72 mW/g**

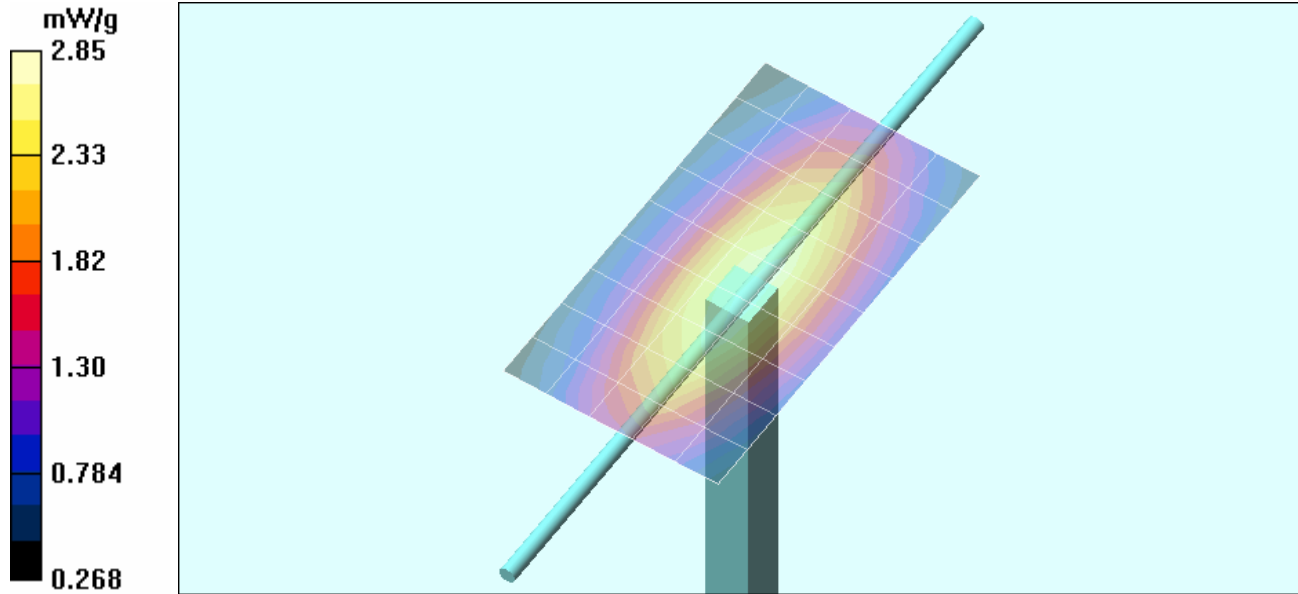

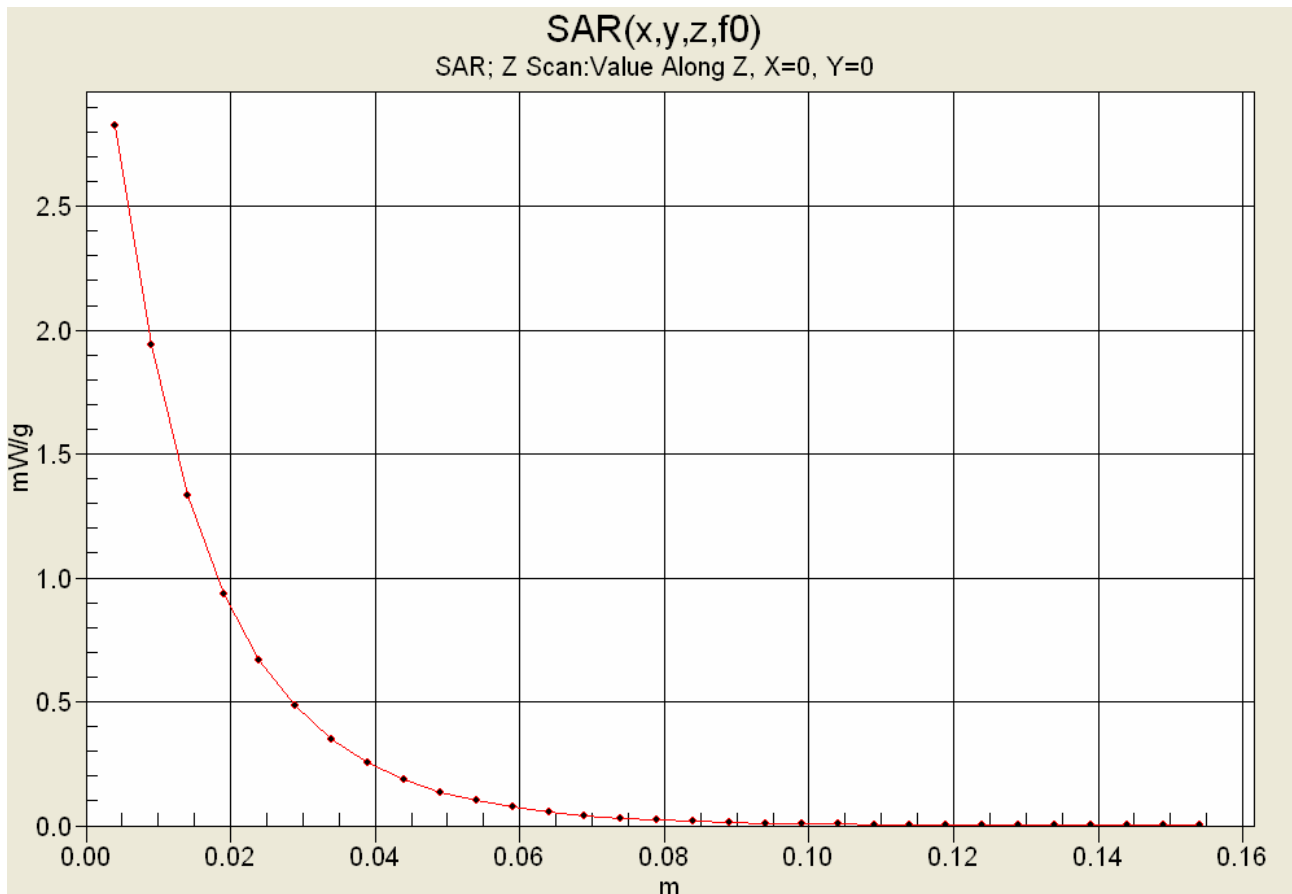

### Z-Axis Scan



	Test Report Serial No.:	100305KBC-T672-S24C	Report Issue No.:	S672C-020906-R0
	Dates of Evaluation:	October 04, 21 & 24, 2005	Report Issue Date:	February 09, 2006
	Type of Evaluation:	RF Exposure      SAR	FCC 47 CFR §2.1093	IC RSS-102 Issue 2

**APPENDIX C - MEASURED FLUID DIELECTRIC PARAMETERS**

<b>Applicant:</b>	Itronix Corporation	<b>FCC ID:</b>	KBCIX325-AC580	<b>IC ID:</b>	1943A-IX325f	
<b>Model:</b>	IX325-AC580	<b>Type:</b>	IX325 Rugged Tablet PC with Dual-Band CDMA PCMCIA Modem			
2006 Celltech Labs Inc.	This document is not to be reproduced in whole or in part without the prior written permission of Celltech Labs Inc.					Page 36 of 47

	Test Report Serial No.:	100305KBC-T672-S24C	Report Issue No.:	S672C-020906-R0
	Dates of Evaluation:	October 04, 21 & 24, 2005	Report Issue Date:	February 09, 2006
	Type of Evaluation:	RF Exposure	SAR	FCC 47 CFR §2.1093

### 835 MHz System Performance Check & DUT Evaluation (Body)

\*\*\*\*\*

Celltech Labs Inc.  
 Test Result for UIM Dielectric Parameter  
 Tue 04/Oct/2005  
 Frequency(GHz)

FCC\_eHFCC Bulletin 65 Supplement C ( June 2001) Limits for Head Epsilon  
 FCC\_sHFCC Bulletin 65 Supplement C (June 2001) Limits for Head Sigma  
 FCC\_eB FCC Limits for Body Epsilon  
 FCC\_sB FCC Limits for Body Sigma  
 Test\_e Epsilon of UIM  
 Test\_s Sigma of UIM

\*\*\*\*\*

Freq	FCC_eB	FCC_sB	Test_e	Test_s
0.7350	55.59	0.96	54.12	0.8750
0.7450	55.55	0.96	53.82	0.8928
0.7550	55.51	0.96	53.94	0.8994
0.7650	55.47	0.96	53.89	0.9165
0.7750	55.43	0.97	53.75	0.9179
0.7850	55.39	0.97	53.80	0.9318
0.7950	55.36	0.97	53.88	0.9398
0.8050	55.32	0.97	53.64	0.9533
0.8150	55.28	0.97	53.44	0.9641
0.8250	55.24	0.97	53.34	0.9793
<b>0.8350</b>	<b>55.20</b>	<b>0.97</b>	<b>53.30</b>	<b>0.9880</b>
0.8450	55.17	0.98	53.11	1.005
0.8550	55.14	0.99	53.12	1.008
0.8650	55.11	1.01	52.93	1.021
0.8750	55.08	1.02	52.72	1.033
0.8850	55.05	1.03	52.62	1.043
0.8950	55.02	1.04	52.69	1.054
0.9050	55.00	1.05	52.60	1.067
0.9150	55.00	1.06	52.43	1.075
0.9250	54.98	1.06	52.34	1.092

Applicant:	Itronix Corporation	FCC ID:	KBCIX325-AC580	IC ID:	1943A-IX325f	
Model:	IX325-AC580	Type:	IX325 Rugged Tablet PC with Dual-Band CDMA PCMCIA Modem			
2006 Celltech Labs Inc.		This document is not to be reproduced in whole or in part without the prior written permission of Celltech Labs Inc.				Page 37 of 47

	Test Report Serial No.:	100305KBC-T672-S24C	Report Issue No.:	S672C-020906-R0
	Dates of Evaluation:	October 04, 21 & 24, 2005	Report Issue Date:	February 09, 2006
	Type of Evaluation:	RF Exposure	SAR	FCC 47 CFR §2.1093

## 1900 MHz System Performance Check & 1880 MHz DUT Evaluation (Body)

\*\*\*\*\*

Celltech Labs Inc.  
 Test Result for UIM Dielectric Parameter  
 Fri 21/Oct/2005  
 Frequency(GHz)

FCC\_eHFCC Bulletin 65 Supplement C ( June 2001) Limits for Head Epsilon  
 FCC\_sHFCC Bulletin 65 Supplement C (June 2001) Limits for Head Sigma  
 FCC\_eB FCC Limits for Body Epsilon  
 FCC\_sB FCC Limits for Body Sigma  
 Test\_e Epsilon of UIM  
 Test\_s Sigma of UIM

\*\*\*\*\*

Freq	FCC_eB	FCC_sB	Test_e	Test_s
1.8000	53.30	1.52	51.08	1.376
1.8100	53.30	1.52	51.08	1.390
1.8200	53.30	1.52	50.95	1.412
1.8300	53.30	1.52	50.93	1.415
1.8400	53.30	1.52	50.92	1.434
1.8500	53.30	1.52	50.94	1.441
1.8600	53.30	1.52	50.72	1.448
1.8700	53.30	1.52	50.74	1.461
1.8800	53.30	1.52	50.79	1.463
1.8900	53.30	1.52	50.67	1.483
1.9000	53.30	1.52	50.70	1.480
1.9100	53.30	1.52	50.65	1.509
1.9200	53.30	1.52	50.69	1.512
1.9300	53.30	1.52	50.61	1.522
1.9400	53.30	1.52	50.61	1.531
1.9500	53.30	1.52	50.63	1.545
1.9600	53.30	1.52	50.63	1.550
1.9700	53.30	1.52	50.51	1.555
1.9800	53.30	1.52	50.43	1.572
1.9900	53.30	1.52	50.36	1.583

Applicant:	Itronix Corporation	FCC ID:	KBCIX325-AC580	IC ID:	1943A-IX325f	
Model:	IX325-AC580	Type:	IX325 Rugged Tablet PC with Dual-Band CDMA PCMCIA Modem			
2006 Celltech Labs Inc.		This document is not to be reproduced in whole or in part without the prior written permission of Celltech Labs Inc.				Page 38 of 47

	Test Report Serial No.:	100305KBC-T672-S24C	Report Issue No.:	S672C-020906-R0
	Dates of Evaluation:	October 04, 21 & 24, 2005	Report Issue Date:	February 09, 2006
	Type of Evaluation:	RF Exposure	SAR	FCC 47 CFR §2.1093

### 835 MHz System Performance Check & DUT Evaluation (Body)

\*\*\*\*\*

Celltech Labs Inc.  
 Test Result for UIM Dielectric Parameter  
 Mon 24/Oct/2005  
 Frequency(GHz)

FCC\_eHFCC Bulletin 65 Supplement C ( June 2001) Limits for Head Epsilon  
 FCC\_sHFCC Bulletin 65 Supplement C (June 2001) Limits for Head Sigma  
 FCC\_eB FCC Limits for Body Epsilon  
 FCC\_sB FCC Limits for Body Sigma  
 Test\_e Epsilon of UIM  
 Test\_s Sigma of UIM

\*\*\*\*\*

Freq	FCC_eB	FCC_sB	Test_e	Test_s
0.7350	55.59	0.96	53.75	0.8750
0.7450	55.55	0.96	53.60	0.8815
0.7550	55.51	0.96	53.32	0.8933
0.7650	55.47	0.96	53.20	0.8996
0.7750	55.43	0.97	53.20	0.9097
0.7850	55.39	0.97	53.15	0.9171
0.7950	55.36	0.97	52.91	0.9291
0.8050	55.32	0.97	52.78	0.9395
0.8150	55.28	0.97	52.89	0.9502
0.8250	55.24	0.97	52.65	0.9634
0.8350	55.20	0.97	52.58	0.9763
0.8450	55.17	0.98	52.51	0.9864
0.8550	55.14	0.99	52.43	0.9898
0.8650	55.11	1.01	52.41	1.009
0.8750	55.08	1.02	52.26	1.009
0.8850	55.05	1.03	52.01	1.024
0.8950	55.02	1.04	52.04	1.026
0.9050	55.00	1.05	51.69	1.037
0.9150	55.00	1.06	51.72	1.049
0.9250	54.98	1.06	51.63	1.056
0.9350	54.96	1.07	51.58	1.066

Applicant:	Itronix Corporation	FCC ID:	KBCIX325-AC580	IC ID:	1943A-IX325f	
Model:	IX325-AC580	Type:	IX325 Rugged Tablet PC with Dual-Band CDMA PCMCIA Modem			
2006 Celltech Labs Inc.		This document is not to be reproduced in whole or in part without the prior written permission of Celltech Labs Inc.				Page 39 of 47

	Test Report Serial No.:	100305KBC-T672-S24C	Report Issue No.:	S672C-020906-R0
	Dates of Evaluation:	October 04, 21 & 24, 2005	Report Issue Date:	February 09, 2006
	Type of Evaluation:	RF Exposure	SAR	FCC 47 CFR §2.1093

## APPENDIX D - SAR TEST SETUP PHOTOGRAPHS

<b>Applicant:</b>	Itronix Corporation	<b>FCC ID:</b>	KBCIX325-AC580	<b>IC ID:</b>	1943A-IX325f	
<b>Model:</b>	IX325-AC580	<b>Type:</b>	IX325 Rugged Tablet PC with Dual-Band CDMA PCMCIA Modem			
2006 Celltech Labs Inc.	This document is not to be reproduced in whole or in part without the prior written permission of Celltech Labs Inc.					Page 40 of 47



	Test Report Serial No.:	100305KBC-T672-S24C	Report Issue No.:	S672C-020906-R0
	Dates of Evaluation:	October 04, 21 & 24, 2005	Report Issue Date:	February 09, 2006
	Type of Evaluation:	RF Exposure SAR	FCC 47 CFR §2.1093	IC RSS-102 Issue 2

**BODY SAR TEST SETUP PHOTOGRAPHS**  
**0.0 cm Separation Distance from Bottom of DUT to Planar Phantom**  
**Antenna "Parallel Straight" Position**





Applicant:	Itronix Corporation	FCC ID:	KBCIX325-AC580	IC ID:	1943A-IX325f	
Model:	IX325-AC580	Type:	IX325 Rugged Tablet PC with Dual-Band CDMA PCMCIA Modem			
2006 Celltech Labs Inc.		This document is not to be reproduced in whole or in part without the prior written permission of Celltech Labs Inc.				Page 41 of 47

	Test Report Serial No.:	100305KBC-T672-S24C	Report Issue No.:	S672C-020906-R0
	Dates of Evaluation:	October 04, 21 & 24, 2005	Report Issue Date:	February 09, 2006
	Type of Evaluation:	RF Exposure SAR	FCC 47 CFR §2.1093	IC RSS-102 Issue 2

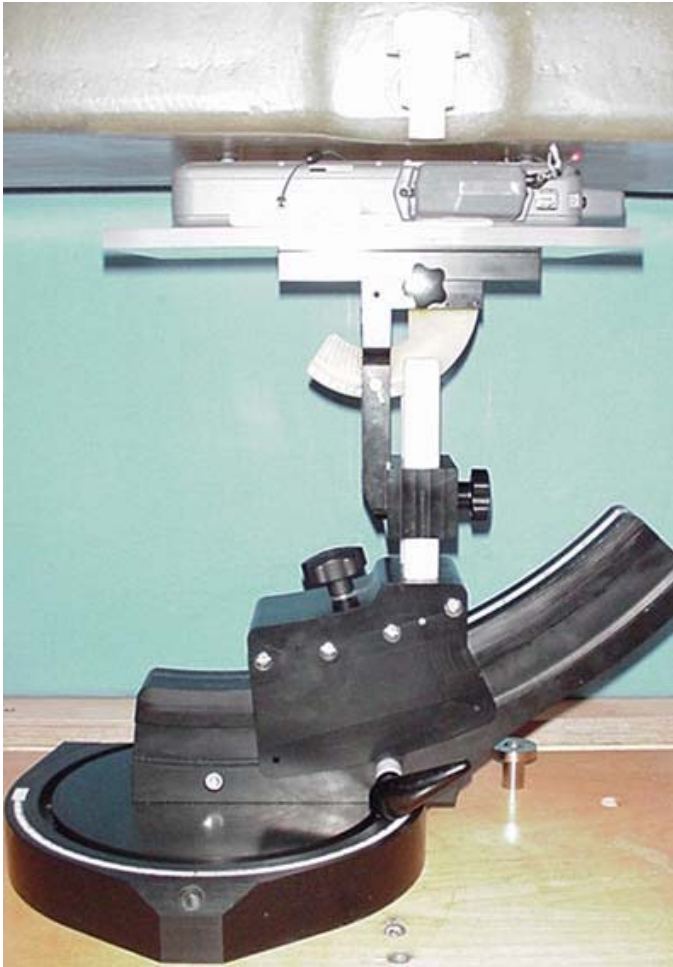
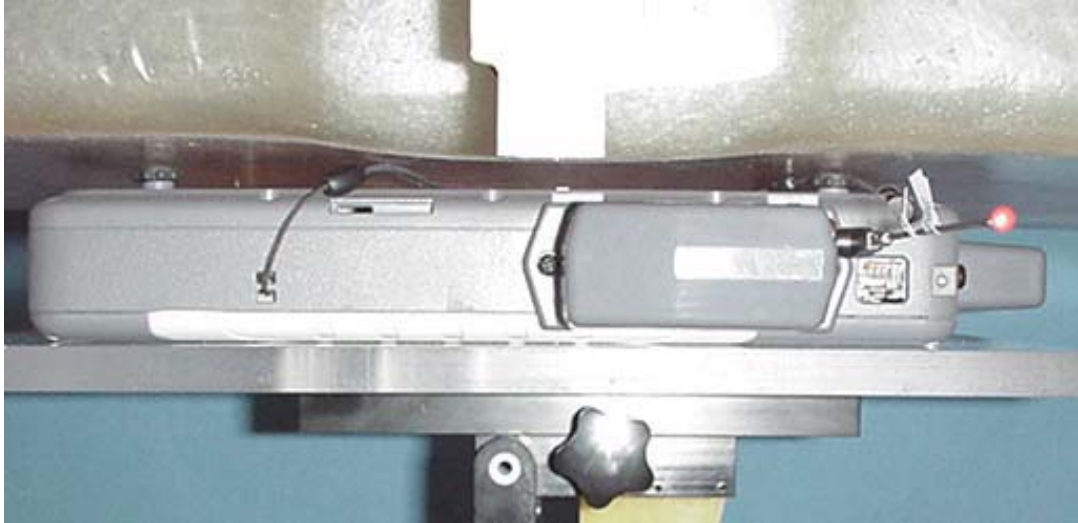
**BODY SAR TEST SETUP PHOTOGRAPHS**  
**0.0 cm Separation Distance from Bottom of DUT to Planar Phantom**  
**Antenna "Parallel Straight" Position**  
**2<sup>nd</sup> Area Scan**





Applicant:	Itronix Corporation	FCC ID:	KBCIX325-AC580	IC ID:	1943A-IX325f	
Model:	IX325-AC580	Type:	IX325 Rugged Tablet PC with Dual-Band CDMA PCMCIA Modem			
2006 Celltech Labs Inc.		This document is not to be reproduced in whole or in part without the prior written permission of Celltech Labs Inc.				Page 42 of 47

	Test Report Serial No.:	100305KBC-T672-S24C	Report Issue No.:	S672C-020906-R0
	Dates of Evaluation:	October 04, 21 & 24, 2005	Report Issue Date:	February 09, 2006
	Type of Evaluation:	RF Exposure SAR	FCC 47 CFR §2.1093	IC RSS-102 Issue 2

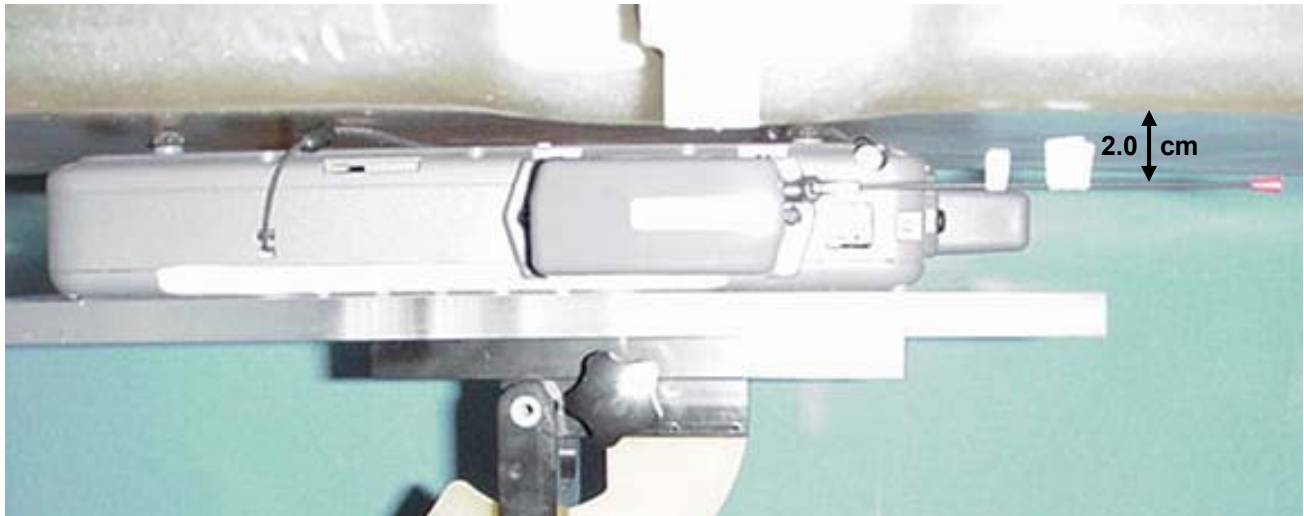
**BODY SAR TEST SETUP PHOTOGRAPHS**  
**0.0 cm Separation Distance from Bottom of DUT to Planar Phantom**  
**Antenna "Parallel Bent" Position**



Applicant:	Itronix Corporation	FCC ID:	KBCIX325-AC580	IC ID:	1943A-IX325f	
Model:	IX325-AC580	Type:	IX325 Rugged Tablet PC with Dual-Band CDMA PCMCIA Modem			
2006 Celltech Labs Inc.		This document is not to be reproduced in whole or in part without the prior written permission of Celltech Labs Inc.				Page 43 of 47

	Test Report Serial No.:	100305KBC-T672-S24C	Report Issue No.:	S672C-020906-R0
	Dates of Evaluation:	October 04, 21 & 24, 2005	Report Issue Date:	February 09, 2006
	Type of Evaluation:	RF Exposure SAR	FCC 47 CFR §2.1093	IC RSS-102 Issue 2

**BODY SAR TEST SETUP PHOTOGRAPHS**  
**0.0 cm Separation Distance from Bottom of DUT to Planar Phantom**  
**Antenna "Perpendicular" Position**

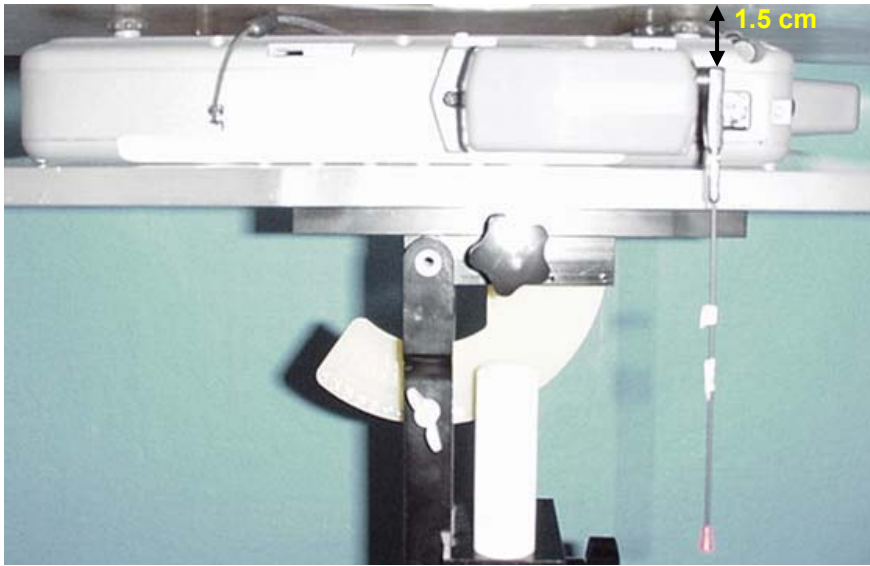

Applicant:	Itronix Corporation	FCC ID:	KBCIX325-AC580	IC ID:	1943A-IX325f	
Model:	IX325-AC580	Type:	IX325 Rugged Tablet PC with Dual-Band CDMA PCMCIA Modem			
2006 Celltech Labs Inc.		This document is not to be reproduced in whole or in part without the prior written permission of Celltech Labs Inc.				Page 44 of 47



Test Report Serial No.:	100305KBC-T672-S24C	Report Issue No.:	S672C-020906-R0	
Dates of Evaluation:	October 04, 21 & 24, 2005	Report Issue Date:	February 09, 2006	
Type of Evaluation:	RF Exposure	SAR	FCC 47 CFR §2.1093	IC RSS-102 Issue 2

**APPENDIX E - SYSTEM VALIDATION**

<b>Applicant:</b>	<b>Itronix Corporation</b>	<b>FCC ID:</b>	<b>KBCIX325-AC580</b>	<b>IC ID:</b>	<b>1943A-IX325f</b>	
<b>Model:</b>	<b>IX325-AC580</b>	<b>Type:</b>	<b>IX325 Rugged Tablet PC with Dual-Band CDMA PCMCIA Modem</b>			
2006 Celltech Labs Inc.	This document is not to be reproduced in whole or in part without the prior written permission of Celltech Labs Inc.					Page 45 of 47

## 835 MHz SYSTEM VALIDATION DIPOLE

Type:

**835 MHz Validation Dipole**

Serial Number:

**411**

Place of Calibration:

**Celltech Labs Inc.**

Date of Calibration:

**April 12, 2005**

**Celltech Labs Inc. hereby certifies that this device has been calibrated on the date indicated above.**

Calibrated by:



Approved by:



### 1. Validation Dipole Construction & Electrical Characteristics

The validation dipole was constructed in accordance with the IEEE Standard “Annex G (informative) Reference dipoles for use in system validation”. The electrical properties were measured using an HP 8753ET Network Analyzer. The network analyzer was calibrated to the validation dipole N-type connector feed point using an HP85032E Type N calibration kit. The dipole was placed parallel to a planar phantom at a separation distance of 15.0mm from the simulating fluid using a loss-less dielectric spacer. The measured input impedance is:

Feed point impedance at 835MHz	$Re\{Z\} = 47.627\Omega$ $Im\{Z\} = -0.67188\Omega$
Return Loss at 835MHz	-31.954dB

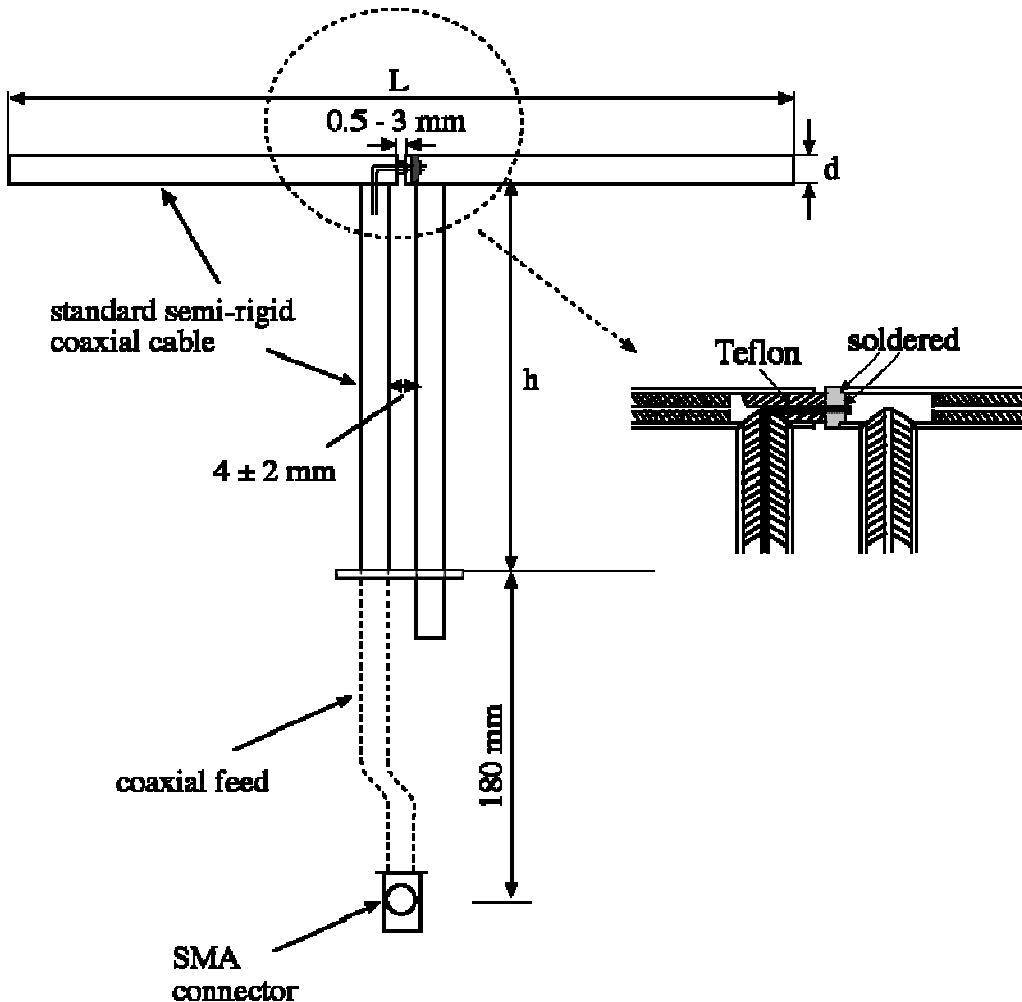

**2. Validation Dipole VSWR Data**

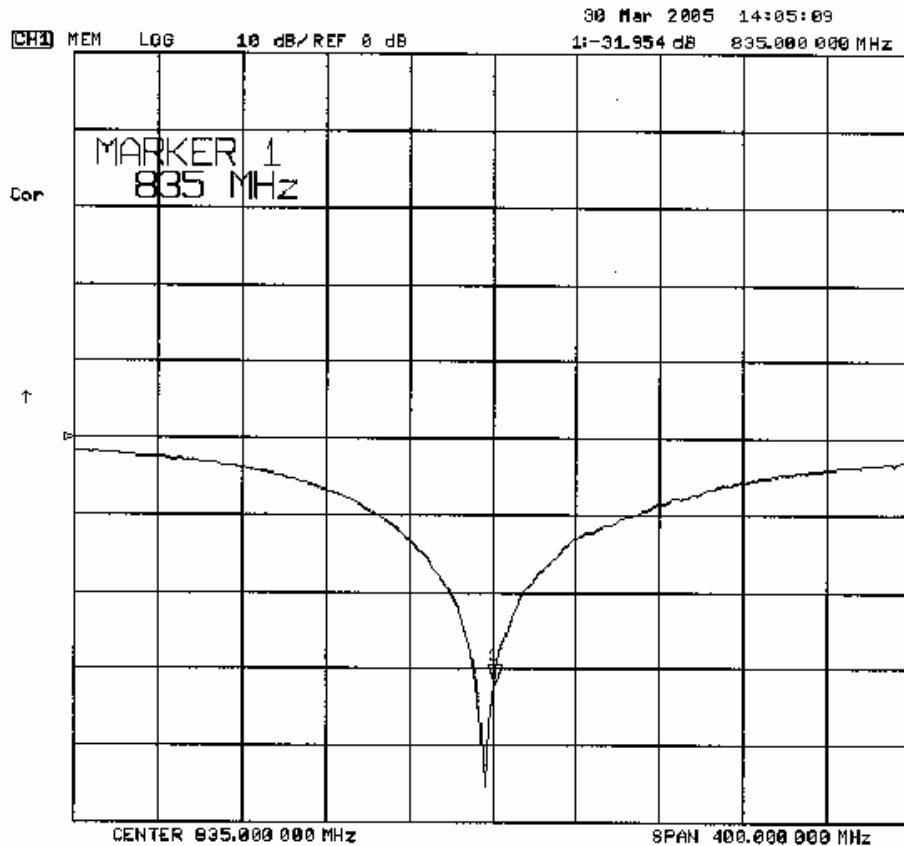
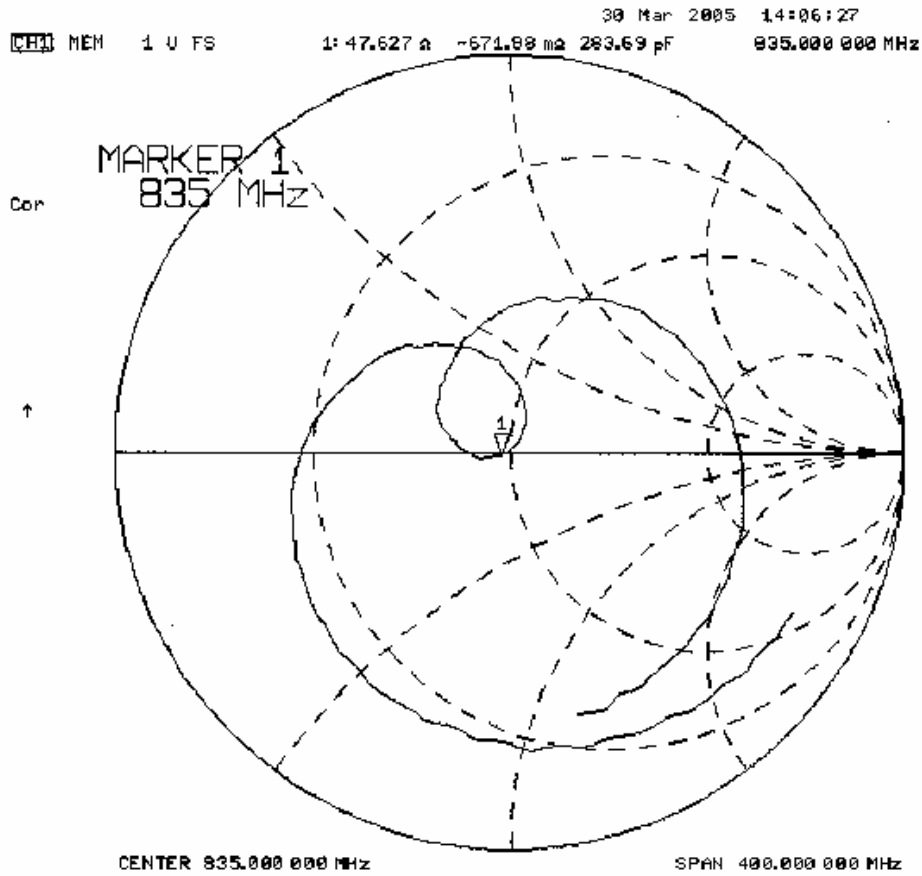



### 3. Validation Dipole Dimensions

Frequency (MHz)	L (mm)	h (mm)	d (mm)
300	420.0	250.0	6.2
450	288.0	167.0	6.2
835	161.0	89.8	3.6
900	149.0	83.3	3.6
1450	89.1	51.7	3.6
1800	72.0	41.7	3.6
1900	68.0	39.5	3.6
2000	64.5	37.5	3.6
2450	51.8	30.6	3.6
3000	41.5	25.0	3.6

### 4. Validation Phantom

The validation phantom is the SAM (Specific Anthropomorphic Mannequin) phantom manufactured by Schmid & Partner Engineering AG. The SAM phantom is a Fiberglass shell integrated in a wooden table. The shape of the shell corresponds to the phantom defined by SCC34-SC2. It enables the dosimetric evaluation of left and right hand phone usage as well as body mounted usage at the flat phantom region. A cover prevents evaporation of the liquid. Reference markings on the phantom allow the complete setup of all predefined phantom positions and measurement grids by manually teaching three points in the robot.

**Shell Thickness:** 2.0 ± 0.1 mm  
**Filling Volume:** Approx. 25 liters  
**Dimensions:** 50 cm (W) x 100 cm (L)

**5. 835 MHz System Validation Setup**



**6. 835 MHz Validation Dipole Setup**



## 7. Measurement Conditions

The SAM phantom was filled with 835 MHz simulated body tissue mixture having the following parameters:

Relative Permittivity: 53.0  
 Conductivity: 0.98 mho/m  
 Fluid Temperature: 21.2 °C  
 Fluid Depth:  $\geq 15.0$  cm

Environmental Conditions:  
 Ambient Temperature: 22.6 °C  
 Barometric Pressure: 103.4 kPa  
 Humidity: 36 %

Measurements were made at the planar section of the SAM phantom using a dosimetric E-field probe ET3DV5 (S/N: 1590, conversion factor 6.71).

The 835 MHz simulated body tissue mixture consisted of the following ingredients:

<b>Ingredient</b>	<b>Percentage by weight</b>
Water	53.79%
Sugar	45.13%
Salt	0.98%
Dowicil 75	0.10%
Target Dielectric Parameters at 22 °C	$\epsilon_r = 55.2$ $\sigma = 0.97$ S/m

### 8. SAR Measurement

The SAR measurement was performed with the E-field probe in mechanical detection mode only. The setup and determination of the forward power into the dipole was performed using the following procedures.

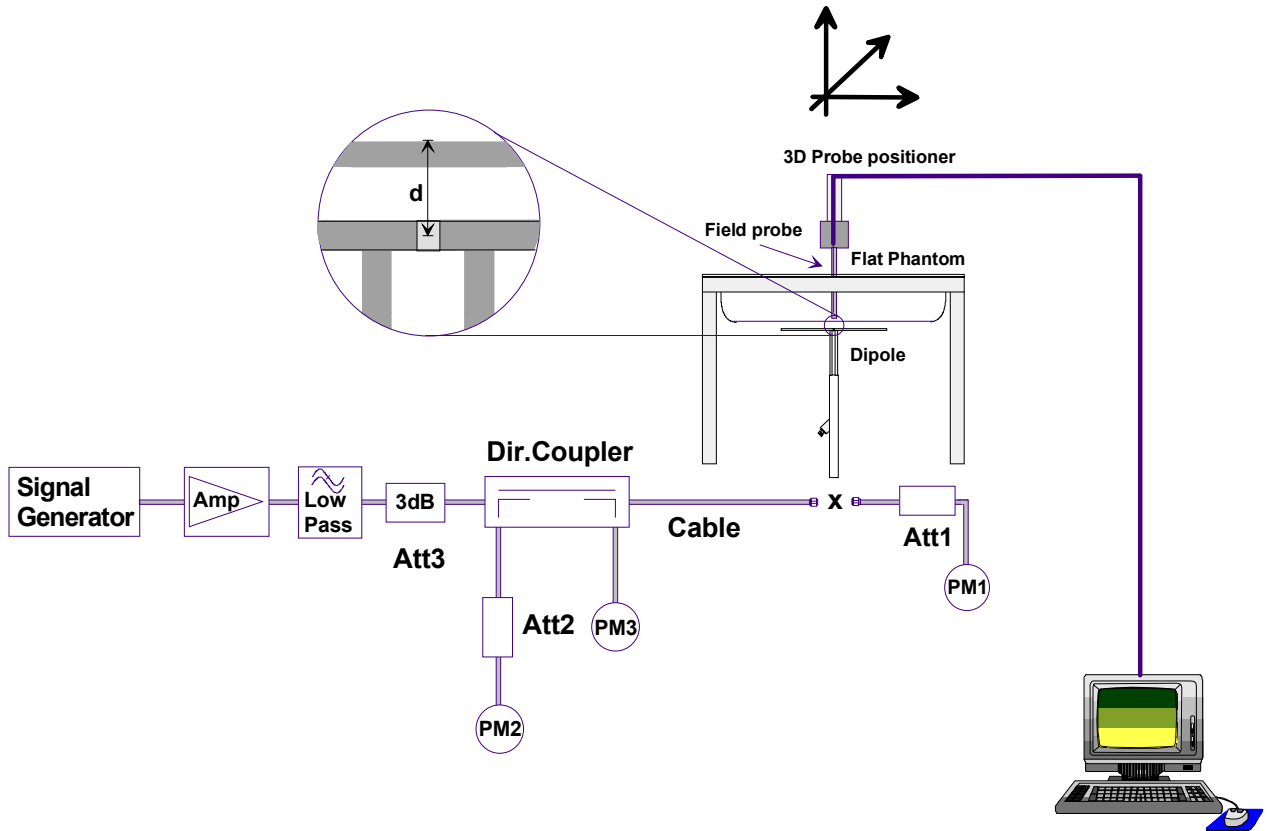

First the power meter PM1 (including attenuator Att1) is connected to the cable to measure the forward power at the location of the dipole connector (X). The signal generator is adjusted for the desired forward power at the dipole connector (taking into account the attenuation of Att1) as read by power meter PM2. After connecting the cable to the dipole, the signal generator is readjusted for the same reading at power meter PM2. If the signal generator does not allow adjustment in 0.01dB steps, the remaining difference at PM2 must be taken into consideration. PM3 records the reflected power from the dipole to ensure that the value is not changed from the previous value. The reflected power should be 20dB below the forward power.

### 9. Validation Dipole SAR Test Results

Ten SAR measurements were performed in order to achieve repeatability and to establish an average target value.

Validation Measurement	SAR @ 0.25W Input averaged over 1g	SAR @ 1W Input averaged over 1g	SAR @ 0.25W Input averaged over 10g	SAR @ 1W Input averaged over 10g	Peak SAR @ 0.25W Input
Test 1	2.61	10.44	1.72	6.88	3.79
Test 2	2.61	10.44	1.72	6.88	3.83
Test 3	2.60	10.40	1.71	6.84	3.79
Test 4	2.60	10.40	1.71	6.84	3.80
Test 5	2.59	10.36	1.71	6.84	3.77
Test 6	2.60	10.40	1.71	6.84	3.77
Test 7	2.60	10.40	1.71	6.84	3.78
Test 8	2.60	10.40	1.71	6.84	3.81
Test 9	2.59	10.36	1.71	6.84	3.76
Test10	2.61	10.44	1.72	6.88	3.80
Average SAR	2.60	10.40	1.71	6.85	3.79

Target SAR @ 1 Watt Input averaged over 1 gram (W/kg)		Measured SAR @ 1 Watt Input averaged over 1 gram (W/kg)	Deviation from Target (%)	Target SAR @ 1 Watt Input averaged over 10 grams (W/kg)		Measured SAR @ 1 Watt Input averaged over 10 grams (W/kg)	Deviation from Target (%)
9.71	+/- 10%	10.4	+ 7.2	6.38	+/- 10%	6.85	+ 7.4

Dipole Type	Distance [mm]	Frequency [MHz]	SAR (1g) [W/kg]	SAR (10g) [W/kg]	SAR (peak) [W/kg]
D300V2	15	300	3.02	2.06	4.36
D450V2	15	450	5.01	3.36	7.22
D835V2	15	835	9.71	6.38	14.1
D900V2	15	900	11.1	7.17	16.3
D1450V2	10	1450	29.6	16.6	49.8
D1500V2	10	1500	30.8	17.1	52.1
D1640V2	10	1640	34.4	18.7	59.4
D1800V2	10	1800	38.5	20.3	67.5
D1900V2	10	1900	39.8	20.8	69.6
D2000V2	10	2000	40.9	21.2	71.5
D2450V2	10	2450	51.2	23.7	97.6
D3000V2	10	3000	61.9	24.8	136.7

Table 32.1: Numerical reference SAR values for SPEAG dipoles and flat phantom filled with body-tissue simulating liquid. Note: All SAR values normalized to 1 W forward power.

### 835 MHz System Validation (Body) - April 12, 2005

DUT: Dipole 835 MHz; Type: D835V2; Serial: 411  
Ambient Temp: 22.6°C; Fluid Temp: 21.2°C; Barometric Pressure: 103.4 kPa; Humidity: 36%  
Communication System: CW  
Forward Conducted Power: 250 mW  
Frequency: 835 MHz; Duty Cycle: 1:1  
Medium: MSL835 Medium parameters used:  $f = 835$  MHz;  $\sigma = 0.98$  mho/m;  $\epsilon_r = 53$ ;  $\rho = 1000$  kg/m<sup>3</sup>  
- Probe: ET3DV6 - SN1590; ConvF(6.54, 6.54, 6.54); Calibrated: 24/05/2004  
- Sensor-Surface: 4mm (Mechanical Surface Detection)  
- Electronics: DAE3 Sn353; Calibrated: 06/07/2004  
- Phantom: SAM 4.0; Type: Fiberglass; Serial: 1033  
- Measurement SW: DASY4, V4.5 Build 19; Postprocessing SW: SEMCAD, V1.8 Build 146

**835 MHz System Performance Check/Area Scan (6x10x1):** Measurement grid: dx=10mm, dy=10mm

**835 MHz System Performance Check/Zoom Scan (7x7x7)/Cube 0:** Measurement grid: dx=5mm, dy=5mm, dz=5mm  
Reference Value = 55.2 V/m; Power Drift = 0.020 dB  
Peak SAR (extrapolated) = 3.79 W/kg  
**SAR(1 g) = 2.61 mW/g; SAR(10 g) = 1.72 mW/g**

**835 MHz System Performance Check/Zoom Scan 2 (7x7x7)/Cube 0:** Measurement grid: dx=5mm, dy=5mm, dz=5mm  
Reference Value = 55.7 V/m; Power Drift = -0.054 dB  
Peak SAR (extrapolated) = 3.83 W/kg  
**SAR(1 g) = 2.61 mW/g; SAR(10 g) = 1.72 mW/g**

**835 MHz System Performance Check/Zoom Scan 3 (7x7x7)/Cube 0:** Measurement grid: dx=5mm, dy=5mm, dz=5mm  
Reference Value = 55.4 V/m; Power Drift = -0.025 dB  
Peak SAR (extrapolated) = 3.79 W/kg  
**SAR(1 g) = 2.60 mW/g; SAR(10 g) = 1.71 mW/g**

**835 MHz System Performance Check/Zoom Scan 4 (7x7x7)/Cube 0:** Measurement grid: dx=5mm, dy=5mm, dz=5mm  
Reference Value = 55.3 V/m; Power Drift = -0.010 dB  
Peak SAR (extrapolated) = 3.80 W/kg  
**SAR(1 g) = 2.60 mW/g; SAR(10 g) = 1.71 mW/g**

**835 MHz System Performance Check/Zoom Scan 5 (7x7x7)/Cube 0:** Measurement grid: dx=5mm, dy=5mm, dz=5mm  
Reference Value = 55.2 V/m; Power Drift = -0.00 dB  
Peak SAR (extrapolated) = 3.77 W/kg  
**SAR(1 g) = 2.59 mW/g; SAR(10 g) = 1.71 mW/g**

**835 MHz System Performance Check/Zoom Scan 6 (7x7x7)/Cube 0:** Measurement grid: dx=5mm, dy=5mm, dz=5mm  
Reference Value = 55.2 V/m; Power Drift = 0.00 dB  
Peak SAR (extrapolated) = 3.77 W/kg  
**SAR(1 g) = 2.60 mW/g; SAR(10 g) = 1.71 mW/g**

**835 MHz System Performance Check/Zoom Scan 7 (7x7x7)/Cube 0:** Measurement grid: dx=5mm, dy=5mm, dz=5mm  
Reference Value = 55.4 V/m; Power Drift = -0.00 dB  
Peak SAR (extrapolated) = 3.78 W/kg  
**SAR(1 g) = 2.60 mW/g; SAR(10 g) = 1.71 mW/g**

**835 MHz System Performance Check/Zoom Scan 8 (7x7x7)/Cube 0:** Measurement grid: dx=5mm, dy=5mm, dz=5mm  
Reference Value = 55.1 V/m; Power Drift = 0.013 dB  
Peak SAR (extrapolated) = 3.81 W/kg  
**SAR(1 g) = 2.60 mW/g; SAR(10 g) = 1.71 mW/g**

**835 MHz System Performance Check/Zoom Scan 9 (7x7x7)/Cube 0:** Measurement grid: dx=5mm, dy=5mm, dz=5mm  
Reference Value = 55.5 V/m; Power Drift = -0.00 dB  
Peak SAR (extrapolated) = 3.76 W/kg  
**SAR(1 g) = 2.59 mW/g; SAR(10 g) = 1.71 mW/g**

**835 MHz System Performance Check/Zoom Scan 10 (7x7x7)/Cube 0:** Measurement grid: dx=5mm, dy=5mm, dz=5mm  
Reference Value = 55.2 V/m; Power Drift = 0.01 dB  
Peak SAR (extrapolated) = 3.80 W/kg  
**SAR(1 g) = 2.61 mW/g; SAR(10 g) = 1.72 mW/g**

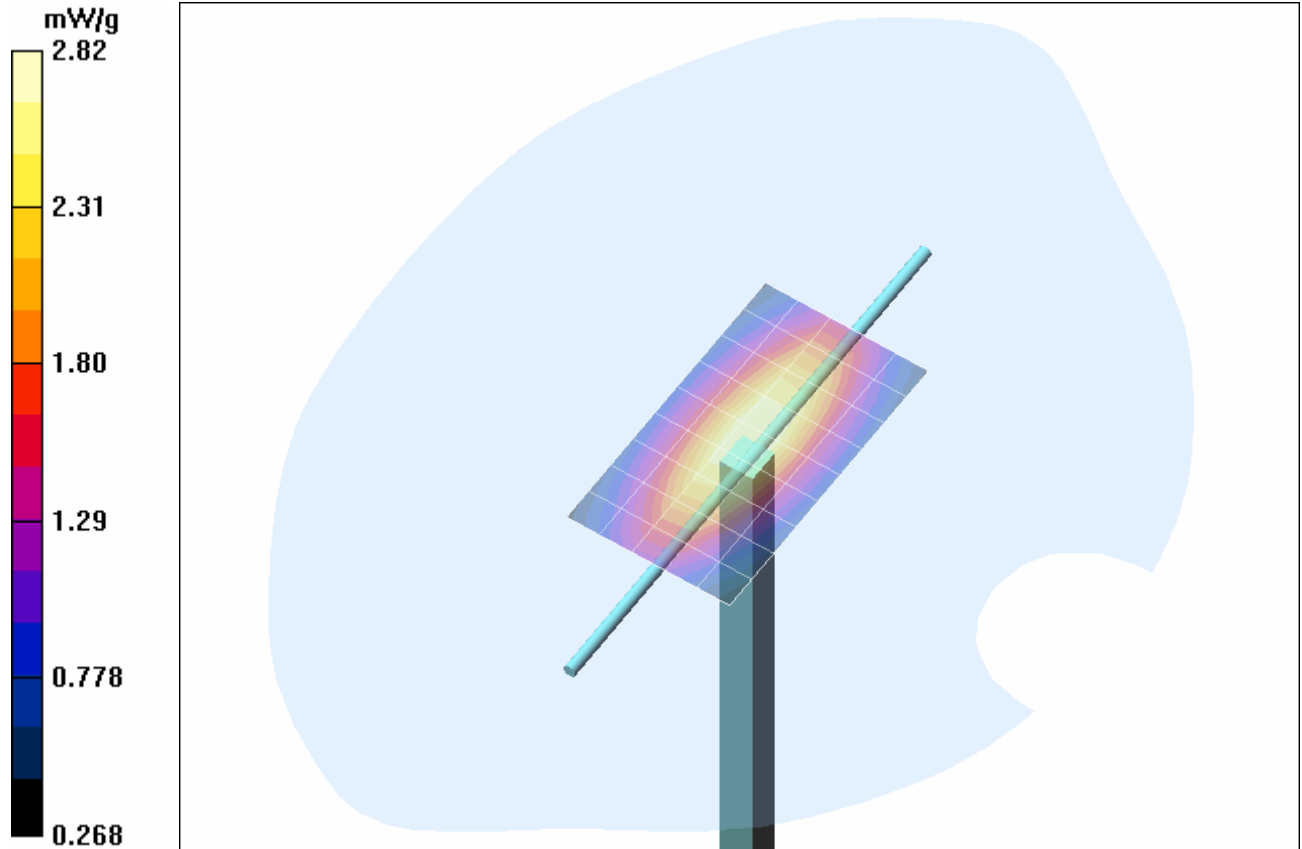

1 g average of 10 measurements: 2.60 mW/g  
10 g average of 10 measurements: 1.71 mW/g

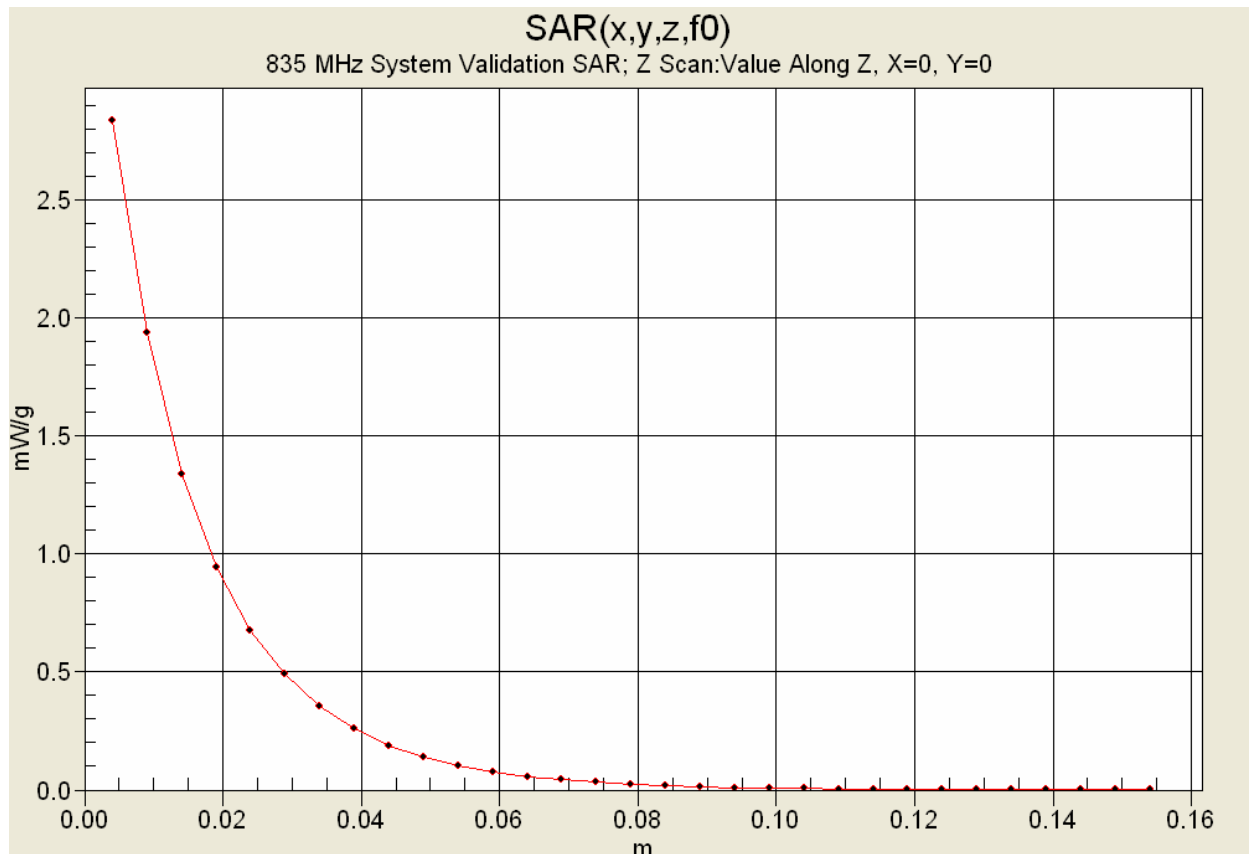



## 10. Measured Fluid Dielectric Parameters

### 835 MHz System Validation (Body)

#### Measured Fluid Dielectric Parameters (Muscle)

April 12, 2005

Frequency	$\epsilon'$	$\epsilon''$
735.000000 MHz	54.0378	21.6286
745.000000 MHz	53.8896	21.5691
755.000000 MHz	53.8006	21.4920
765.000000 MHz	53.6592	21.4574
775.000000 MHz	53.5651	21.4082
785.000000 MHz	53.4598	21.3813
795.000000 MHz	53.3996	21.3224
805.000000 MHz	53.2805	21.2791
815.000000 MHz	53.2061	21.2382
825.000000 MHz	53.1022	21.1974
<b>835.000000 MHz</b>	<b>52.9838</b>	<b>21.1959</b>
845.000000 MHz	52.8546	21.1661
855.000000 MHz	52.7335	21.1454
865.000000 MHz	52.5991	21.1198
875.000000 MHz	52.4868	21.0980
885.000000 MHz	52.4035	21.0714
895.000000 MHz	52.3499	21.0447
905.000000 MHz	52.2262	21.0295
915.000000 MHz	52.1465	20.9572
925.000000 MHz	52.0498	20.9643
935.000000 MHz	51.9344	20.8879

## 1900 MHz SYSTEM VALIDATION DIPOLE

Type:

**1900 MHz Validation Dipole**

Serial Number:

**151**

Place of Calibration:

**Celltech Labs Inc.**

Date of Calibration:

**April 22, 2005**

**Celltech Labs Inc. hereby certifies that this device has been calibrated on the date indicated above.**

Calibrated by:



Approved by:





**2. Validation Dipole VSWR Data**

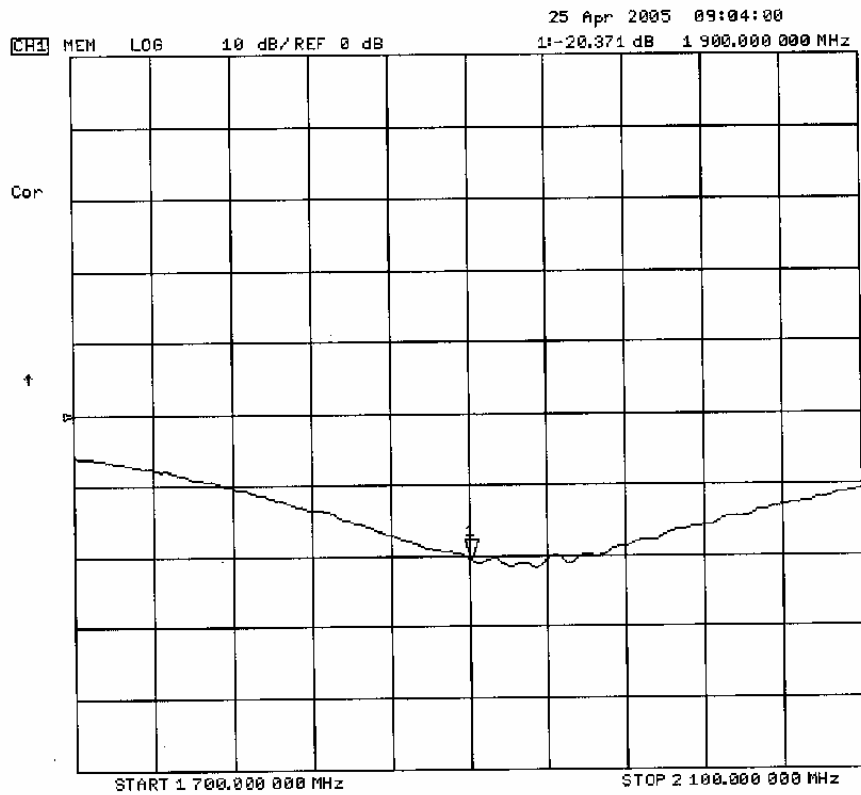
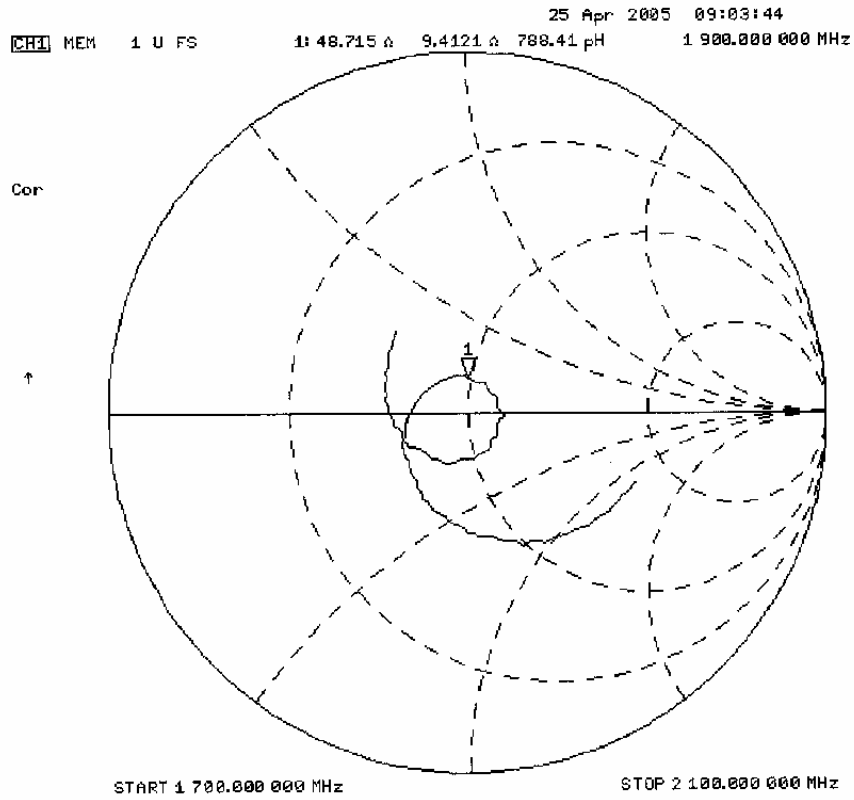

### 3. Validation Dipole Dimensions

Frequency (MHz)	L (mm)	h (mm)	d (mm)
300	420.0	250.0	6.2
450	288.0	167.0	6.2
835	161.0	89.8	3.6
900	149.0	83.3	3.6
1450	89.1	51.7	3.6
1800	72.0	41.7	3.6
1900	68.0	39.5	3.6
2000	64.5	37.5	3.6
2450	51.8	30.6	3.6
3000	41.5	25.0	3.6

### 4. Validation Phantom

The validation phantom is a Fiberglass shell planar phantom manufactured by Barski Industries Ltd. The phantom is in conformance with the requirements defined by IEEE SCC34-SC2 for the dosimetric evaluations of body-worn and lap-held operating configurations. Reference markings on the phantom allow the complete setup of all predefined phantom positions and measurement grids.

**Shell Thickness:** 2.0 ± 0.1 mm  
**Filling Volume:** Approx. 55 liters  
**Dimensions:** 44 cm (W) x 94 cm (L)

**5. 1900 MHz System Validation Setup**



**6. 1900 MHz System Validation Setup**



## 7. Measurement Conditions

The phantom was filled with 1900 MHz Body simulating tissue.

Relative Permittivity:	50.7
Conductivity:	1.59 mho/m
Fluid Temperature:	23.8 °C
Fluid Depth:	≥ 15.0 cm

Environmental Conditions:

Ambient Temperature:	25.6 °C
Barometric Pressure:	102.1 kPa
Humidity:	30%

The 1900 MHz simulated Body tissue mixture consists of the following ingredients:

<b>Ingredient</b>	<b>Percentage by weight</b>
Water	69.85%
Glycol	29.89%
Salt	0.26%
Target Dielectric Parameters at 22 °C	$\epsilon_r = 53.3$ $\sigma = 1.52 \text{ S/m}$



### 8. SAR Measurement

The SAR measurement was performed with the E-field probe in mechanical detection mode only. The setup and determination of the forward power into the dipole was performed using the following procedures.

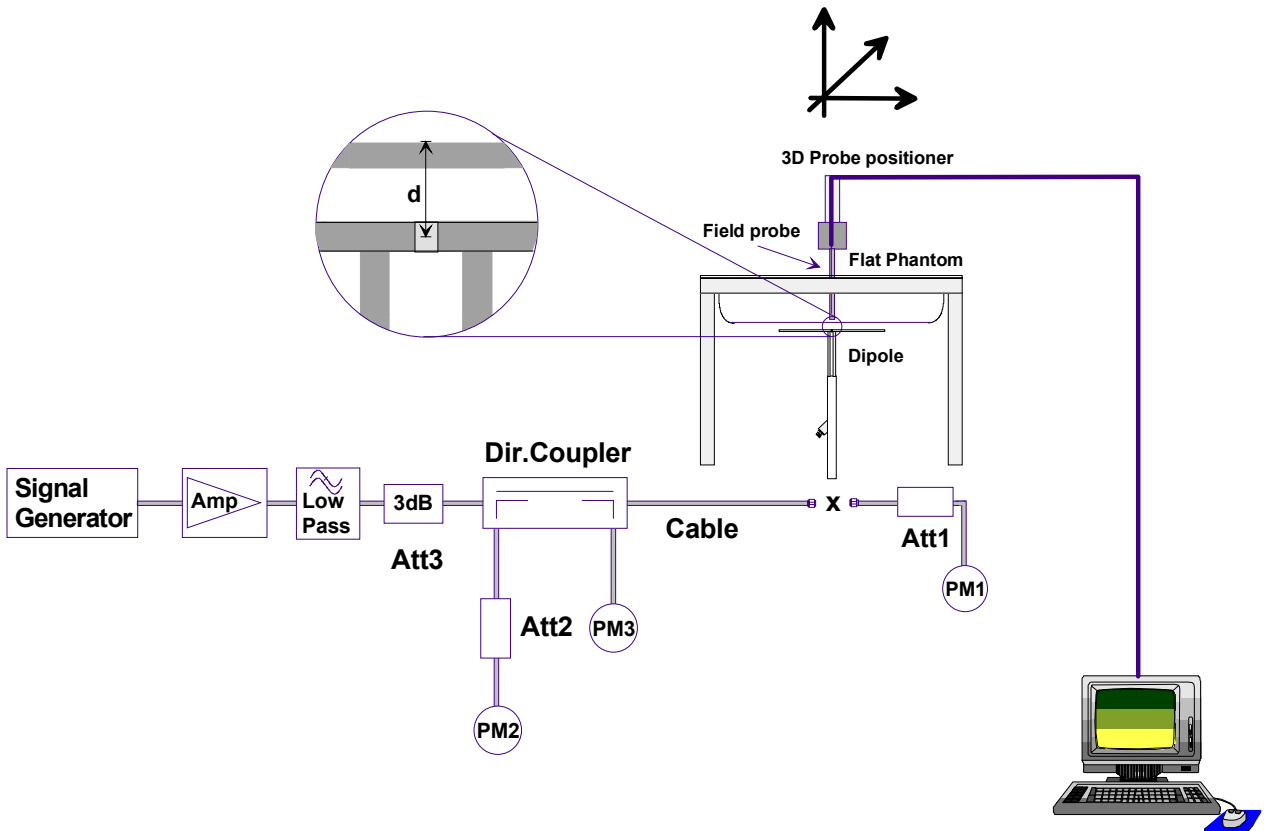

First the power meter PM1 (including attenuator Att1) is connected to the cable to measure the forward power at the location of the dipole connector (X). The signal generator is adjusted for the desired forward power at the dipole connector (taking into account the attenuation of Att1) as read by power meter PM2. After connecting the cable to the dipole, the signal generator is readjusted for the same reading at power meter PM2. If the signal generator does not allow adjustment in 0.01dB steps, the remaining difference at PM2 must be taken into consideration. PM3 records the reflected power from the dipole to ensure that the value is not changed from the previous value. The reflected power should be 50dB below the forward power.

### 9. Validation Dipole SAR Test Results

Ten SAR measurements were performed in order to achieve repeatability and to establish an average target value.

Validation Measurement	SAR @ 0.25W Input averaged over 1g	SAR @ 1W Input averaged over 1g	SAR @ 0.25W Input averaged over 10g	SAR @ 1W Input averaged over 10g	Peak SAR @ 0.25W Input
Test 1	10.7	42.80	5.71	22.84	17.7
Test 2	10.7	42.80	5.72	22.88	17.6
Test 3	10.7	42.80	5.73	22.92	17.6
Test 4	10.7	42.80	5.73	22.92	17.6
Test 5	10.7	42.80	5.72	22.88	17.6
Test 6	10.7	42.80	5.70	22.80	17.5
Test 7	10.7	42.80	5.70	22.80	17.5
Test 8	10.6	42.40	5.69	22.76	17.4
Test 9	10.6	42.40	5.69	22.76	17.4
Test 10	10.6	42.40	5.69	22.76	17.5
Average	10.67	42.68	5.71	22.83	17.54

The results have been normalized to 1W (forward power) into the dipole.

Target SAR @ 1 Watt Input averaged over 1 gram (W/kg)		Measured SAR @ 1 Watt Input averaged over 1 gram (W/kg)	Deviation from Target (%)	Target SAR @ 1 Watt Input averaged over 10 grams (W/kg)		Measured SAR @ 1 Watt Input averaged over 10 grams (W/kg)	Deviation from Target (%)
39.8	+/- 10%	42.68	+7.24	20.8	+/- 10%	22.83	+9.76

Dipole Type	Distance [mm]	Frequency [MHz]	SAR (1g) [W/kg]	SAR (10g) [W/kg]	SAR (peak) [W/kg]
D300V2	15	300	3.02	2.06	4.36
D450V2	15	450	5.01	3.36	7.22
D835V2	15	835	9.71	6.38	14.1
D900V2	15	900	11.1	7.17	16.3
D1450V2	10	1450	29.6	16.6	49.8
D1500V2	10	1500	30.8	17.1	52.1
D1640V2	10	1640	34.4	18.7	59.4
D1800V2	10	1800	38.5	20.3	67.5
D1900V2	10	1900	39.8	20.8	69.6
D2000V2	10	2000	40.9	21.2	71.5
D2450V2	10	2450	51.2	23.7	97.6
D3000V2	10	3000	61.9	24.8	136.7

Table 32.1: Numerical reference SAR values for SPEAG dipoles and flat phantom filled with body-tissue simulating liquid. Note: All SAR values normalized to 1 W forward power.

### 1900 MHz System Validation (Body) - April 22, 2005

DUT: Dipole 1900 MHz; Type: D1900V2; Serial: 151; Calibrated: 04/22/2005  
Ambient Temp: 25.6 °C; Fluid Temp: 23.8 °C; Barometric Pressure: 102.1 kPa; Humidity: 30%  
Communication System: CW  
Frequency: 1900 MHz; Duty Cycle: 1:1  
Medium: M1900 Medium parameters used:  $f = 1900$  MHz;  $\sigma = 1.59$  mho/m;  $\epsilon_r = 50.7$ ;  $\rho = 1000$  kg/m<sup>3</sup>  
- Probe: ET3DV6 - SN1590; ConvF(4.58, 4.58, 4.58); Calibrated: 24/05/2004  
- Sensor-Surface: 4mm (Mechanical Surface Detection)  
- Electronics: DAE3 Sn353; Calibrated: 06/07/2004  
- Phantom: Barski Industries; Type: Fiberglass Planar; Serial: 03-01  
- Measurement SW: DASY4, V4.5 Build 19; Postprocessing SW: SEMCAD, V1.8 Build 146

**1900 MHz System Validation/Area Scan (5x8x1):** Measurement grid: dx=15mm, dy=15mm

**1900 MHz System Validation/Zoom Scan (7x7x7)/Cube 0:** Measurement grid: dx=5mm, dy=5mm, dz=5mm  
Reference Value = 93.9 V/m; Power Drift = -0.079 dB  
Peak SAR (extrapolated) = 17.7 W/kg  
**SAR(1 g) = 10.7 mW/g; SAR(10 g) = 5.71 mW/g**

**1900 MHz System Validation/Zoom Scan 2 (7x7x7)/Cube 0:** Measurement grid: dx=5mm, dy=5mm, dz=5mm  
Reference Value = 93.7 V/m; Power Drift = -0.026 dB  
Peak SAR (extrapolated) = 17.6 W/kg  
**SAR(1 g) = 10.7 mW/g; SAR(10 g) = 5.72 mW/g**

**1900 MHz System Validation/Zoom Scan 3 (7x7x7)/Cube 0:** Measurement grid: dx=5mm, dy=5mm, dz=5mm  
Reference Value = 94.3 V/m; Power Drift = -0.026 dB  
Peak SAR (extrapolated) = 17.6 W/kg  
**SAR(1 g) = 10.7 mW/g; SAR(10 g) = 5.73 mW/g**

**1900 MHz System Validation/Zoom Scan 4 (7x7x7)/Cube 0:** Measurement grid: dx=5mm, dy=5mm, dz=5mm  
Reference Value = 94.2 V/m; Power Drift = -0.025 dB  
Peak SAR (extrapolated) = 17.6 W/kg  
**SAR(1 g) = 10.7 mW/g; SAR(10 g) = 5.73 mW/g**

**1900 MHz System Validation/Zoom Scan 5 (7x7x7)/Cube 0:** Measurement grid: dx=5mm, dy=5mm, dz=5mm  
Reference Value = 94.2 V/m; Power Drift = -0.027 dB  
Peak SAR (extrapolated) = 17.6 W/kg  
**SAR(1 g) = 10.7 mW/g; SAR(10 g) = 5.72 mW/g**

**1900 MHz System Validation/Zoom Scan 6 (7x7x7)/Cube 0:** Measurement grid: dx=5mm, dy=5mm, dz=5mm  
Reference Value = 93.8 V/m; Power Drift = -0.056 dB  
Peak SAR (extrapolated) = 17.5 W/kg  
**SAR(1 g) = 10.7 mW/g; SAR(10 g) = 5.70 mW/g**

**1900 MHz System Validation/Zoom Scan 7 (7x7x7)/Cube 0:** Measurement grid: dx=5mm, dy=5mm, dz=5mm  
Reference Value = 93.8 V/m; Power Drift = -0.043 dB  
Peak SAR (extrapolated) = 17.5 W/kg  
**SAR(1 g) = 10.7 mW/g; SAR(10 g) = 5.70 mW/g**

**1900 MHz System Validation/Zoom Scan 8 (7x7x7)/Cube 0:** Measurement grid: dx=5mm, dy=5mm, dz=5mm  
Reference Value = 93.6 V/m; Power Drift = -0.050 dB  
Peak SAR (extrapolated) = 17.4 W/kg  
**SAR(1 g) = 10.6 mW/g; SAR(10 g) = 5.69 mW/g**

**1900 MHz System Validation/Zoom Scan 9 (7x7x7)/Cube 0:** Measurement grid: dx=5mm, dy=5mm, dz=5mm  
Reference Value = 93.7 V/m; Power Drift = -0.033 dB  
Peak SAR (extrapolated) = 17.4 W/kg  
**SAR(1 g) = 10.6 mW/g; SAR(10 g) = 5.69 mW/g**

**1900 MHz System Validation/Zoom Scan 10 (7x7x7)/Cube 0:** Measurement grid: dx=5mm, dy=5mm, dz=5mm  
Reference Value = 93.5 V/m; Power Drift = -0.045 dB  
Peak SAR (extrapolated) = 17.5 W/kg  
**SAR(1 g) = 10.6 mW/g; SAR(10 g) = 5.69 mW/g**

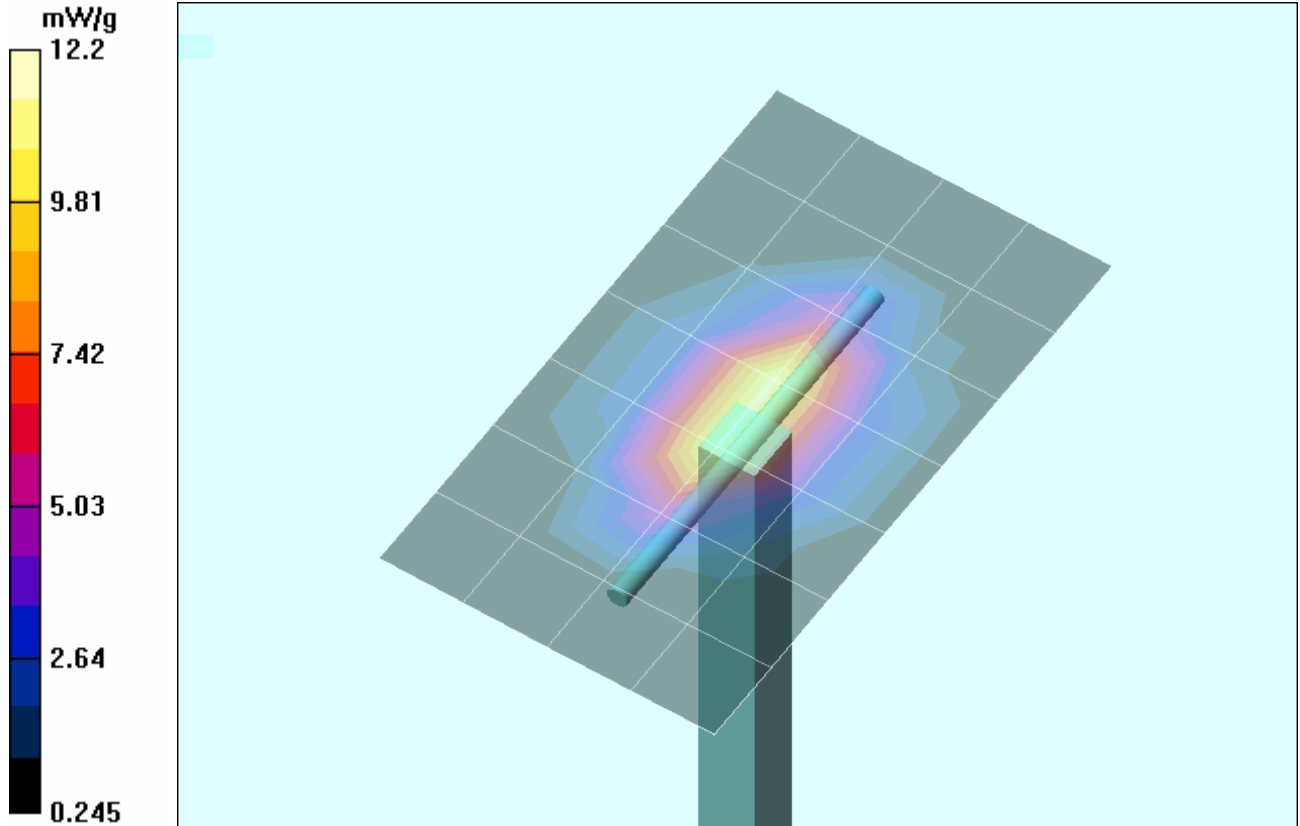

1 g average of 10 measurements: 10.67 mW/g  
10 g average of 10 measurements: 5.71 mW/g

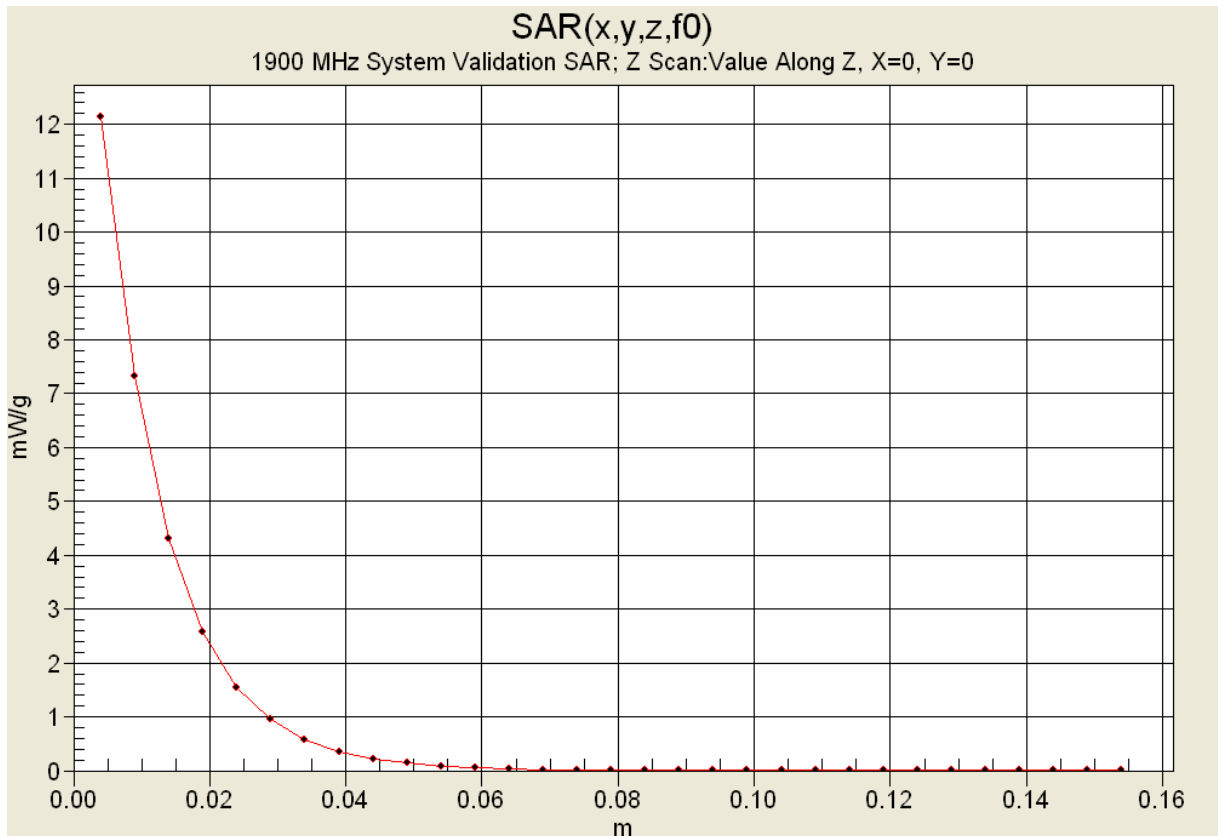

## 10. Measured Fluid Dielectric Parameters

### System Validation - 1900 MHz Dipole

#### Measured Fluid Dielectric Parameters (Muscle)

April 22, 2005

Frequency	$e'$	$e''$
1.800000000 GHz	51.0964	14.7202
1.810000000 GHz	51.0396	14.7503
1.820000000 GHz	51.0220	14.7911
1.830000000 GHz	50.9811	14.8228
1.840000000 GHz	50.9466	14.8388
1.850000000 GHz	50.9152	14.8773
1.860000000 GHz	50.8658	14.8924
1.870000000 GHz	50.8337	14.9214
1.880000000 GHz	50.7654	14.9640
1.890000000 GHz	50.7233	15.0059
1.900000000 GHz	50.6734	15.0407
1.910000000 GHz	50.6457	15.0744
1.920000000 GHz	50.6058	15.1083
1.930000000 GHz	50.5785	15.1423
1.940000000 GHz	50.5378	15.1671
1.950000000 GHz	50.4983	15.1913
1.960000000 GHz	50.4575	15.2240
1.970000000 GHz	50.4075	15.2443
1.980000000 GHz	50.3458	15.2616
1.990000000 GHz	50.3079	15.3071
2.000000000 GHz	50.2546	15.3145

	Test Report Serial No.:	100305KBC-T672-S24C	Report Issue No.:	S672C-020906-R0
	Dates of Evaluation:	October 04, 21 & 24, 2005	Report Issue Date:	February 09, 2006
	Type of Evaluation:	RF Exposure	SAR	FCC 47 CFR §2.1093

## APPENDIX F - PROBE CALIBRATION

<b>Applicant:</b>	Itronix Corporation	<b>FCC ID:</b>	KBCIX325-AC580	<b>IC ID:</b>	1943A-IX325f	
<b>Model:</b>	IX325-AC580	<b>Type:</b>	IX325 Rugged Tablet PC with Dual-Band CDMA PCMCIA Modem			
2006 Celltech Labs Inc.	This document is not to be reproduced in whole or in part without the prior written permission of Celltech Labs Inc.					Page 46 of 47



Accredited by the Swiss Federal Office of Metrology and Accreditation  
The Swiss Accreditation Service is one of the signatories to the EA  
Multilateral Agreement for the recognition of calibration certificates

Accreditation No.: **SCS 108**

Client **Celltech Labs**

Certificate No: **ET3-1387\_Mar05**

## CALIBRATION CERTIFICATE

Object **ET3DV6 - SN:1387**

Calibration procedure(s) **QA CAL-01.v5  
Calibration procedure for dosimetric E-field probes**

Calibration date: **March 18, 2005**

Condition of the calibrated item **In Tolerance**

This calibration certificate documents the traceability to national standards, which realize the physical units of measurements (SI).  
The measurements and the uncertainties with confidence probability are given on the following pages and are part of the certificate.

All calibrations have been conducted in the closed laboratory facility: environment temperature (22 ± 3)°C and humidity < 70%.

Calibration Equipment used (M&TE critical for calibration)

Primary Standards	ID #	Cal Date (Calibrated by, Certificate No.)	Scheduled Calibration
Power meter E4419B	GB41293874	5-May-04 (METAS, No. 251-00388)	May-05
Power sensor E4412A	MY41495277	5-May-04 (METAS, No. 251-00388)	May-05
Reference 3 dB Attenuator	SN: S5054 (3c)	10-Aug-04 (METAS, No. 251-00403)	Aug-05
Reference 20 dB Attenuator	SN: S5086 (20b)	3-May-04 (METAS, No. 251-00389)	May-05
Reference 30 dB Attenuator	SN: S5129 (30b)	10-Aug-04 (METAS, No. 251-00404)	Aug-05
Reference Probe ES3DV2	SN: 3013	7-Jan-05 (SPEAG, No. ES3-3013_Jan05)	Jan-06
DAE4	SN: 617	19-Jan-05 (SPEAG, No. DAE4-617_Jan05)	Jan-06
Secondary Standards	ID #	Check Date (in house)	Scheduled Check
Power sensor HP 8481A	MY41092180	18-Sep-02 (SPEAG, in house check Oct-03)	In house check: Oct 05
RF generator HP 8648C	US3642U01700	4-Aug-99 (SPEAG, in house check Dec-03)	In house check: Dec-05
Network Analyzer HP 8753E	US37390585	18-Oct-01 (SPEAG, in house check Nov-04)	In house check: Nov 05

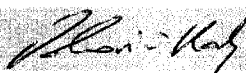
Calibrated by:	Name <b>Nico Vetterli</b>	Function <b>Laboratory Technician</b>	Signature 
Approved by:	Name <b>Katja Pokovic</b>	Function <b>Technical Manager</b>	Signature 

Issued: March 18, 2005

This calibration certificate shall not be reproduced except in full without written approval of the laboratory.



Accredited by the Swiss Federal Office of Metrology and Accreditation  
The Swiss Accreditation Service is one of the signatories to the EA  
Multilateral Agreement for the recognition of calibration certificates

Accreditation No.: **SCS 108**

### Glossary:

TSL	tissue simulating liquid
NORM <sub>x,y,z</sub>	sensitivity in free space
ConF	sensitivity in TSL / NORM <sub>x,y,z</sub>
DCP	diode compression point
Polarization $\varphi$	$\varphi$ rotation around probe axis
Polarization $\vartheta$	$\vartheta$ rotation around an axis that is in the plane normal to probe axis (at measurement center), i.e., $\vartheta = 0$ is normal to probe axis

### Calibration is Performed According to the Following Standards:

- IEEE Std 1528-2003, "IEEE Recommended Practice for Determining the Peak Spatial-Averaged Specific Absorption Rate (SAR) in the Human Head from Wireless Communications Devices: Measurement Techniques", December 2003
- CENELEC EN 50361, "Basic standard for the measurement of Specific Absorption Rate related to human exposure to electromagnetic fields from mobile phones (300 MHz - 3 GHz), July 2001

### Methods Applied and Interpretation of Parameters:

- NORM<sub>x,y,z</sub>**: Assessed for E-field polarization  $\vartheta = 0$  ( $f \leq 900$  MHz in TEM-cell;  $f > 1800$  MHz: R22 waveguide). NORM<sub>x,y,z</sub> are only intermediate values, i.e., the uncertainties of NORM<sub>x,y,z</sub> does not effect the E<sup>2</sup>-field uncertainty inside TSL (see below *ConvF*).
- NORM(f)<sub>x,y,z</sub>** = NORM<sub>x,y,z</sub> \* *frequency\_response* (see Frequency Response Chart). This linearization is implemented in DASY4 software versions later than 4.2. The uncertainty of the frequency response is included in the stated uncertainty of *ConvF*.
- DCP<sub>x,y,z</sub>**: DCP are numerical linearization parameters assessed based on the data of power sweep (no uncertainty required). DCP does not depend on frequency nor media.
- ConvF and Boundary Effect Parameters**: Assessed in flat phantom using E-field (or Temperature Transfer Standard for  $f \leq 800$  MHz) and inside waveguide using analytical field distributions based on power measurements for  $f > 800$  MHz. The same setups are used for assessment of the parameters applied for boundary compensation (alpha, depth) of which typical uncertainty values are given. These parameters are used in DASY4 software to improve probe accuracy close to the boundary. The sensitivity in TSL corresponds to NORM<sub>x,y,z</sub> \* *ConvF* whereby the uncertainty corresponds to that given for *ConvF*. A frequency dependent *ConvF* is used in DASY version 4.4 and higher which allows extending the validity from  $\pm 50$  MHz to  $\pm 100$  MHz.
- Spherical isotropy (3D deviation from isotropy)**: in a field of low gradients realized using a flat phantom exposed by a patch antenna.
- Sensor Offset**: The sensor offset corresponds to the offset of virtual measurement center from the probe tip (on probe axis). No tolerance required.



# Probe ET3DV6

## SN:1387

Manufactured:	September 21, 1999
Last calibrated:	March 18, 2004
Recalibrated:	March 18, 2005

Calibrated for DASY Systems

(Note: non-compatible with DASY2 system!)

## DASY - Parameters of Probe: ET3DV6 SN:1387

### Sensitivity in Free Space<sup>A</sup>

NormX	1.61 ± 10.1%	$\mu\text{V}/(\text{V}/\text{m})^2$	DCP X	92 mV
NormY	1.70 ± 10.1%	$\mu\text{V}/(\text{V}/\text{m})^2$	DCP Y	92 mV
NormZ	1.70 ± 10.1%	$\mu\text{V}/(\text{V}/\text{m})^2$	DCP Z	92 mV

### Diode Compression<sup>B</sup>

### Sensitivity in Tissue Simulating Liquid (Conversion Factors)

Please see Page 8.

### Boundary Effect

**TSL**                      **900 MHz**      **Typical SAR gradient: 5 % per mm**

Sensor Center to Phantom Surface Distance		<b>3.7 mm</b>	<b>4.7 mm</b>
SAR <sub>be</sub> [%]	Without Correction Algorithm	9.4	4.9
SAR <sub>be</sub> [%]	With Correction Algorithm	0.1	0.3

**TSL**                      **1810 MHz**      **Typical SAR gradient: 10 % per mm**

Sensor Center to Phantom Surface Distance		<b>3.7 mm</b>	<b>4.7 mm</b>
SAR <sub>be</sub> [%]	Without Correction Algorithm	14.3	9.6
SAR <sub>be</sub> [%]	With Correction Algorithm	0.6	0.1

### Sensor Offset

Probe Tip to Sensor Center                      **2.7 mm**

**The reported uncertainty of measurement is stated as the standard uncertainty of measurement multiplied by the coverage factor k=2, which for a normal distribution corresponds to a coverage probability of approximately 95%.**

<sup>A</sup> The uncertainties of NormX,Y,Z do not affect the E<sup>2</sup>-field uncertainty inside TSL (see Page 8).

<sup>B</sup> Numerical linearization parameter: uncertainty not required.

# Frequency Response of E-Field

(TEM-Cell:ifi110 EXX, Waveguide: R22)

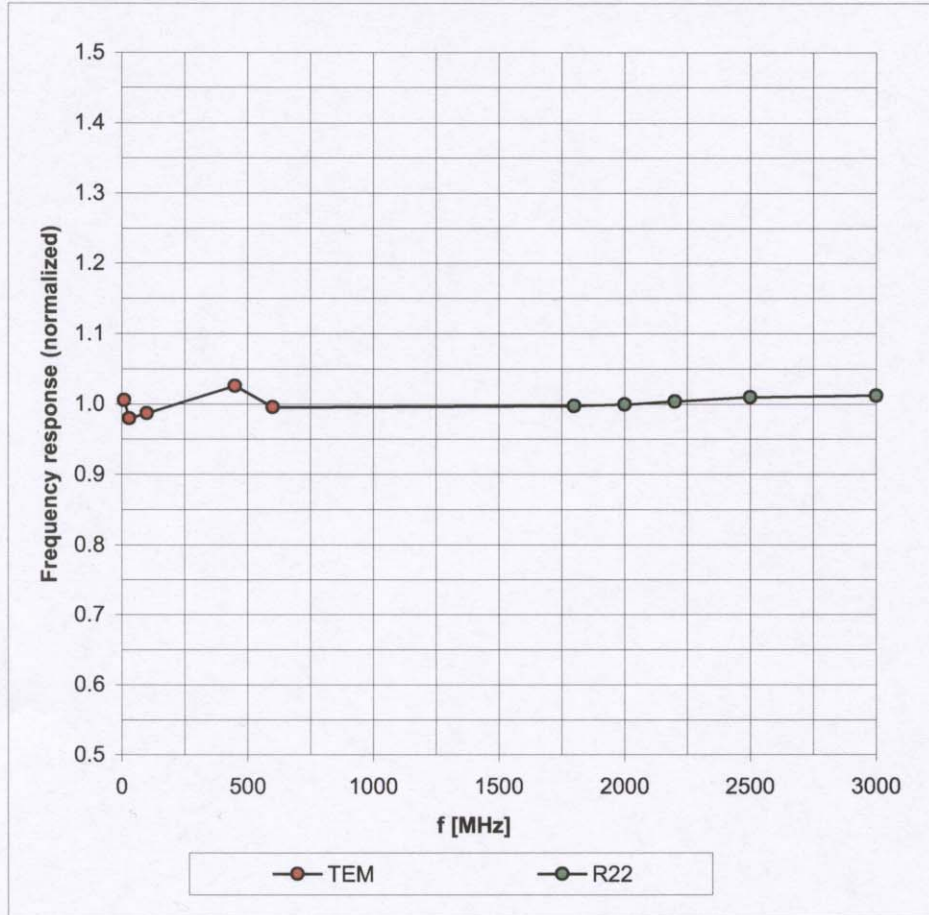

Uncertainty of Frequency Response of E-field:  $\pm 6.3\%$  ( $k=2$ )

### Receiving Pattern ( $\phi$ ), $\vartheta = 0^\circ$

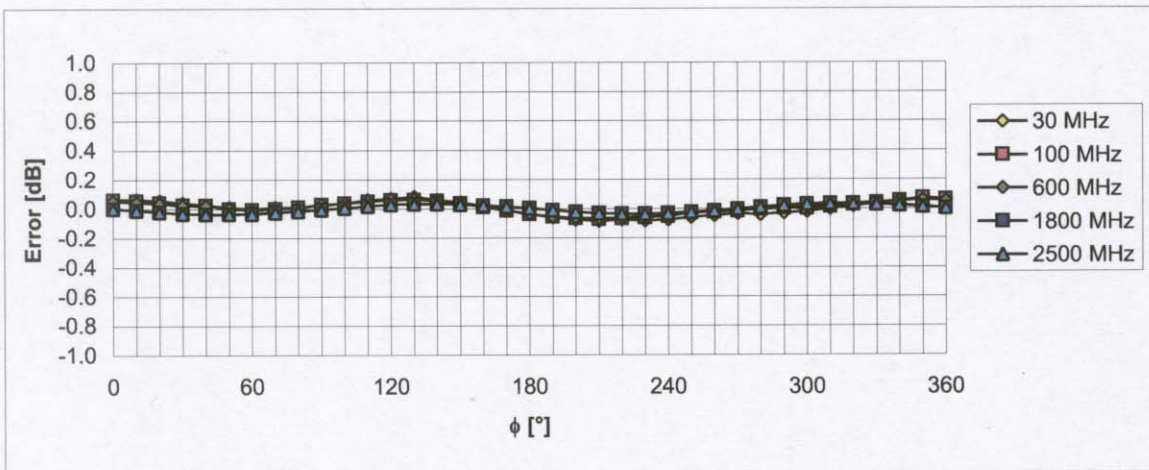
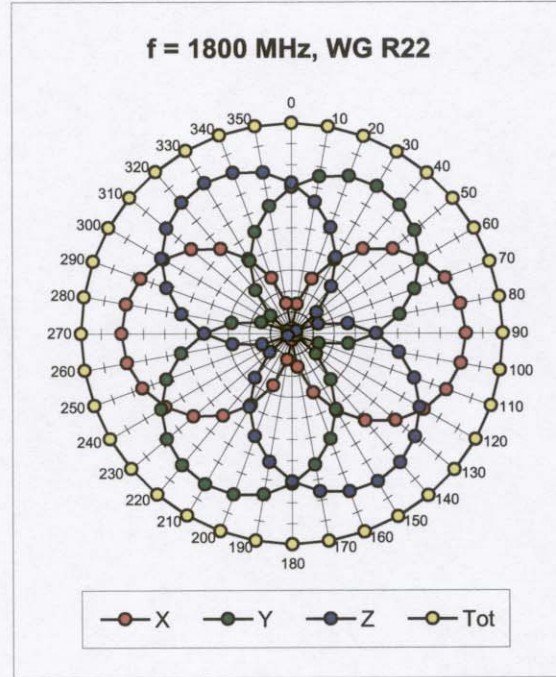
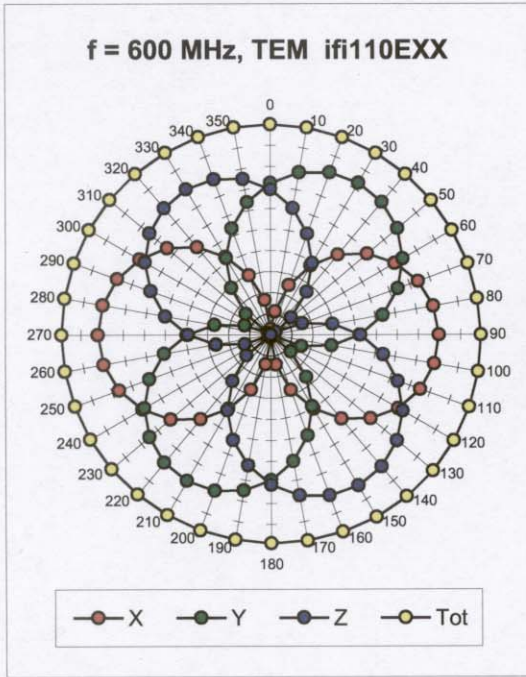

Uncertainty of Axial Isotropy Assessment:  $\pm 0.5\%$  ( $k=2$ )

## Dynamic Range $f(\text{SAR}_{\text{head}})$ (Waveguide R22, $f = 1800 \text{ MHz}$ )

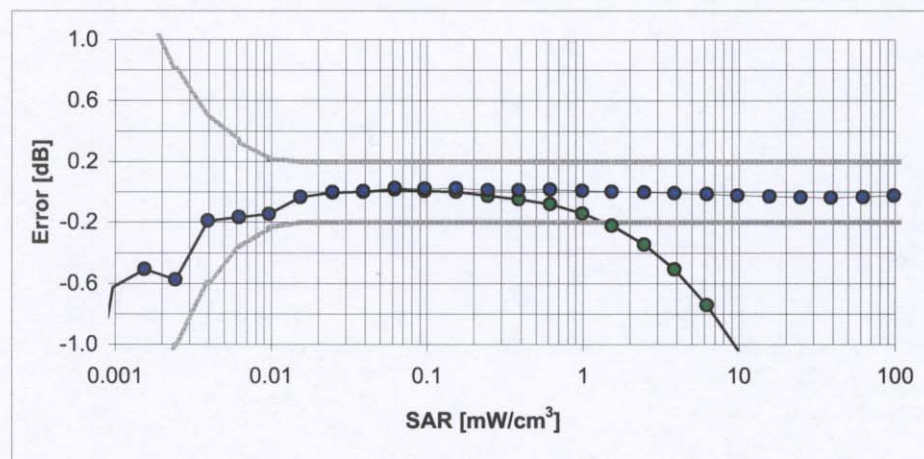
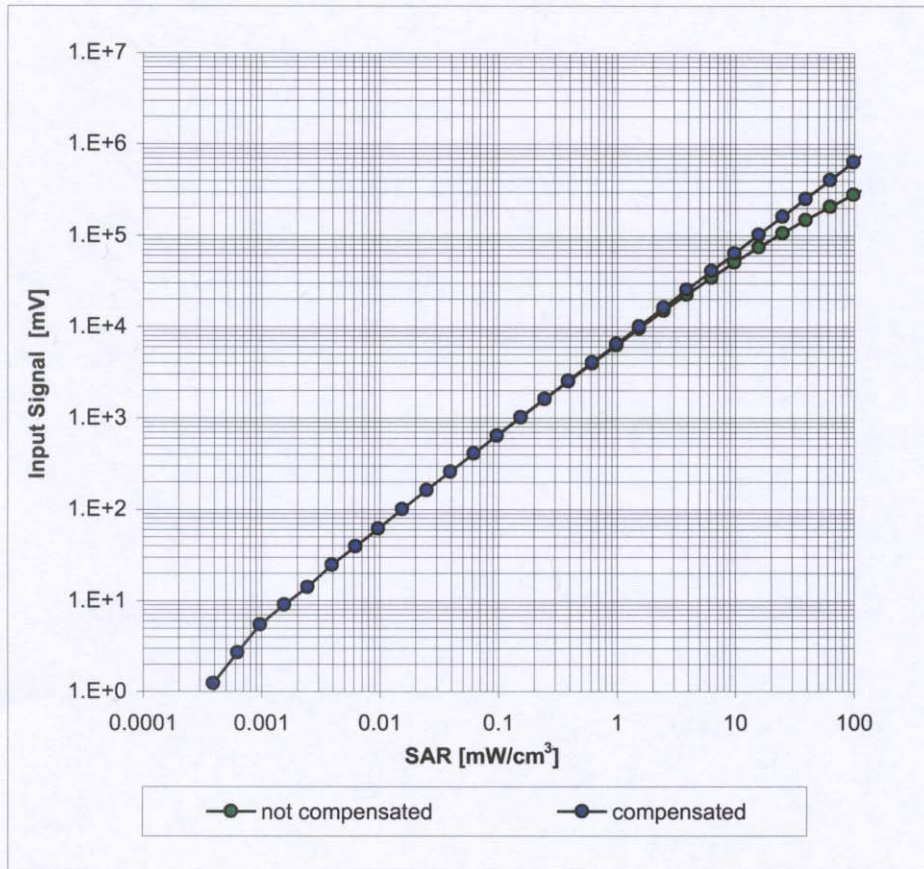

Uncertainty of Linearity Assessment:  $\pm 0.6\%$  ( $k=2$ )

## Conversion Factor Assessment

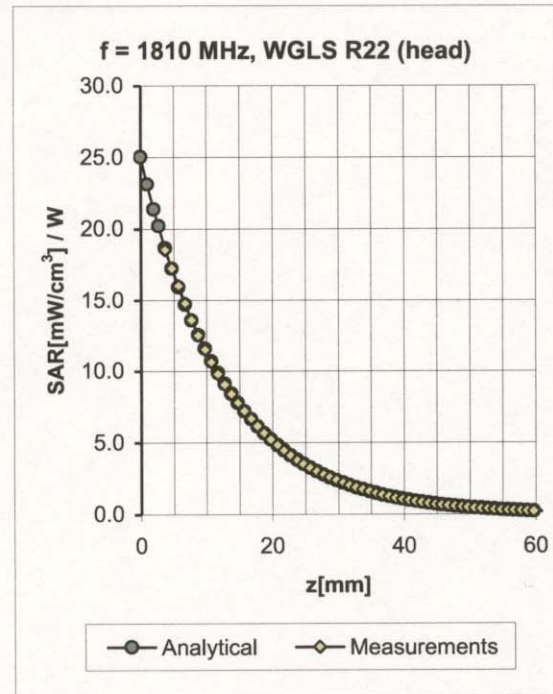
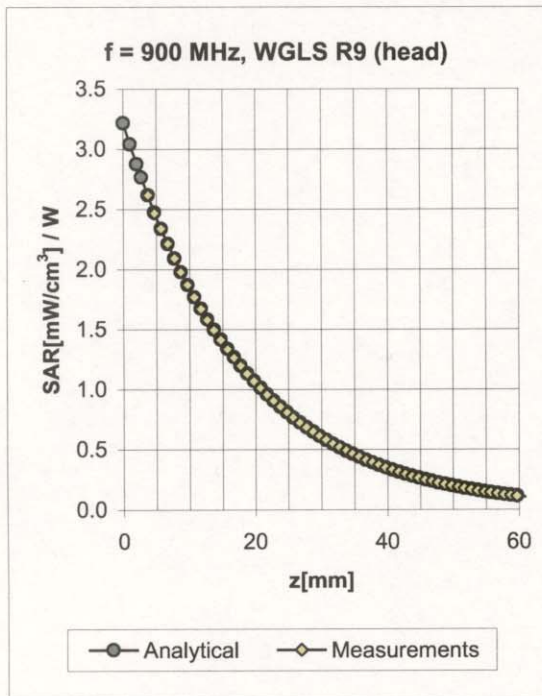

f [MHz]	Validity [MHz] <sup>c</sup>	TSL	Permittivity	Conductivity	Alpha	Depth	ConvF Uncertainty
900	± 50 / ± 100	Head	41.5 ± 5%	0.97 ± 5%	0.65	1.81	6.47 ± 11.0% (k=2)
1810	± 50 / ± 100	Head	40.0 ± 5%	1.40 ± 5%	0.62	2.39	5.18 ± 11.0% (k=2)
2450	± 50 / ± 100	Head	39.2 ± 5%	1.80 ± 5%	0.76	2.09	4.56 ± 11.8% (k=2)
900	± 50 / ± 100	Body	55.0 ± 5%	1.05 ± 5%	0.60	2.01	6.10 ± 11.0% (k=2)
1810	± 50 / ± 100	Body	53.3 ± 5%	1.52 ± 5%	0.60	2.67	4.75 ± 11.0% (k=2)
2450	± 50 / ± 100	Body	52.7 ± 5%	1.95 ± 5%	0.82	1.82	4.30 ± 11.8% (k=2)

<sup>c</sup> The validity of ± 100 MHz only applies for DASY v4.4 and higher (see Page 2). The uncertainty is the RSS of the ConvF uncertainty at calibration frequency and the uncertainty for the indicated frequency band.

# Deviation from Isotropy in HSL

Error ( $\phi$ ,  $\vartheta$ ),  $f = 900$  MHz

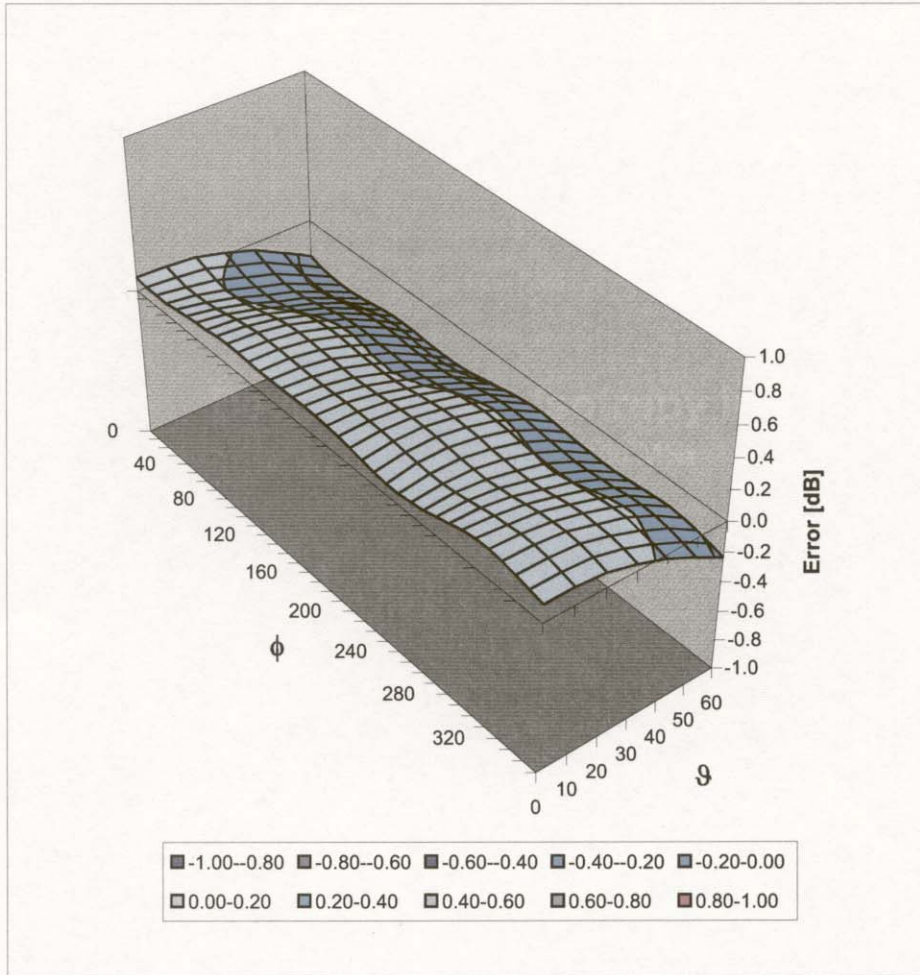

Uncertainty of Spherical Isotropy Assessment:  $\pm 2.6\%$  ( $k=2$ )

## Additional Conversion Factors for Dosimetric E-Field Probe

Type:	<b>ET3DV6</b>
Serial Number:	<b>1387</b>
Place of Assessment:	<b>Zurich</b>
Date of Assessment:	<b>March 21, 2005</b>
Probe Calibration Date:	<b>March 18, 2005</b>

Schmid & Partner Engineering AG hereby certifies that conversion factor(s) of this probe have been evaluated on the date indicated above. The assessment was performed using the FDTD numerical code SEMCAD of Schmid & Partner Engineering AG. Since the evaluation is coupled with measured conversion factors, it has to be recalculated yearly, i.e., following the re-calibration schedule of the probe. The uncertainty of the numerical assessment is based on the extrapolation from measured value at 900 MHz or at 1800 MHz.

Assessed by:

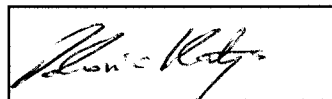



**Dosimetric E-Field Probe ET3DV6 SN:1387**Conversion factor ( $\pm$  standard deviation)

<b>f = 150 MHz</b>	ConvF	<b>8.8 <math>\pm</math> 10%</b>	$\epsilon_r = 52.3 \pm 5\%$ $\sigma = 0.76 \pm 5\%$ mho/m (head tissue)
<b>f = 300 MHz</b>	ConvF	<b>7.9 <math>\pm</math> 9%</b>	$\epsilon_r = 45.3 \pm 5\%$ $\sigma = 0.87 \pm 5\%$ mho/m (head tissue)
<b>f = 450 MHz</b>	ConvF	<b>7.5 <math>\pm</math> 8%</b>	$\epsilon_r = 43.5 \pm 5\%$ $\sigma = 0.87 \pm 5\%$ mho/m (head tissue)
<b>f = 150 MHz</b>	ConvF	<b>8.4 <math>\pm</math> 10%</b>	$\epsilon_r = 61.9 \pm 5\%$ $\sigma = 0.80 \pm 5\%$ mho/m (body tissue)
<b>f = 450 MHz</b>	ConvF	<b>7.5 <math>\pm</math> 8%</b>	$\epsilon_r = 56.7 \pm 5\%$ $\sigma = 0.94 \pm 5\%$ mho/m (body tissue)

**Important Note:**

For numerically assessed probe conversion factors, parameters Alpha and Delta in the DASY software must have the following entries: Alpha = 0 and Delta = 1.

Please see also Section 4.7 of the DASY4 Manual.

	Test Report Serial No.:	100305KBC-T672-S24C	Report Issue No.:	S672C-020906-R0
	Dates of Evaluation:	October 04, 21 & 24, 2005	Report Issue Date:	February 09, 2006
	Type of Evaluation:	RF Exposure	SAR	FCC 47 CFR §2.1093

## APPENDIX G - PLANAR PHANTOM CERTIFICATE OF CONFORMITY

<b>Applicant:</b>	Itronix Corporation	<b>FCC ID:</b>	KBCIX325-AC580	<b>IC ID:</b>	1943A-IX325f	
<b>Model:</b>	IX325-AC580	<b>Type:</b>	IX325 Rugged Tablet PC with Dual-Band CDMA PCMCIA Modem			
2006 Celltech Labs Inc.	This document is not to be reproduced in whole or in part without the prior written permission of Celltech Labs Inc.					Page 47 of 47

2378 Westlake Road  
Kelowna, B.C. Canada  
V1Z-2V2



Ph. # 250-769-6848  
Fax # 250-769-6334  
E-mail: [barskiind@shaw.ca](mailto:barskiind@shaw.ca)  
Web: [www.bcfiberglass.com](http://www.bcfiberglass.com)

## FIBERGLASS FABRICATORS

### Certificate of Conformity

Item : Flat Planar Phantom Unit # 03-01  
Date: June 16, 2003  
Manufacturer: Barski Industries (1985 Ltd)

Test	Requirement	Details
Shape	Compliance to geometry according to drawing	Supplied CAD drawing
Material Thickness	Compliant with the requirements	2mm +/- 0.2mm in measurement area
Material Parameters	Dielectric parameters for required frequencies Based on Dow Chemical technical data	100 MHz-5 GHz Relative permittivity < 5 Loss Tangent < 0.05

#### Conformity

Based on the above information, we certify this product to be compliant to the requirements specified.

Signature: \_\_\_\_\_

A handwritten signature in black ink, appearing to read 'Daniel Chailier', is written over a horizontal line.

Daniel Chailier



**Fiberglass Planar Phantom - Top View**



**Fiberglass Planar Phantom - Front View**



**Fiberglass Planar Phantom - Back View**



**Fiberglass Planar Phantom - Bottom View**

## Dimensions of Fiberglass Planar Phantom

(Manufactured by Barski Industries Ltd. - Unit# 03-01)

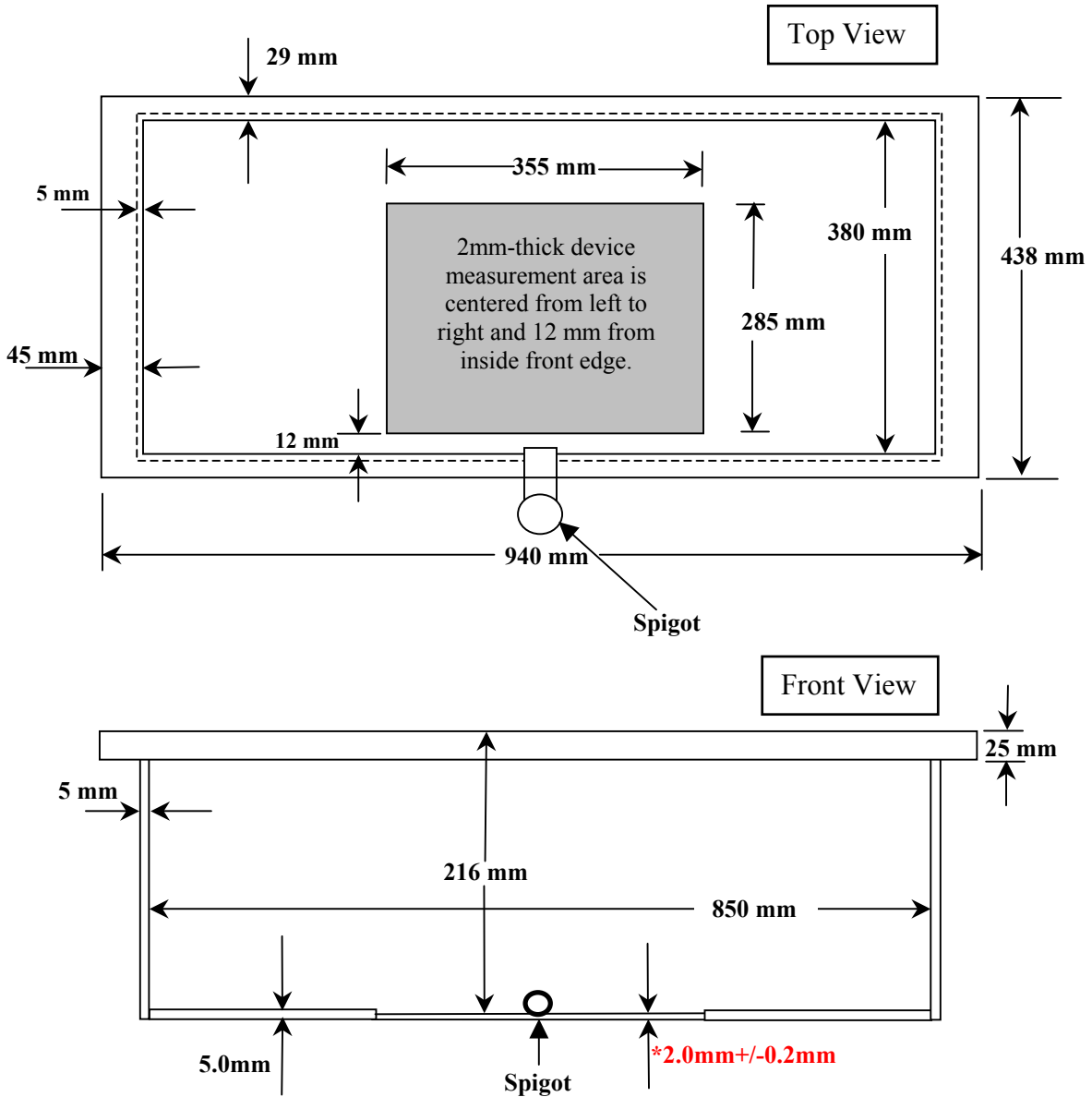

**Note: Measurements that aren't repeated for the opposite sides are the same as the side measured.  
This drawing is not to scale.**