	Test Report Serial No.:	100305KBC-T672-E24C	Report Issue No.:	E672C-020106-R0
	Test Date(s):	07Oct05 - 10Dec05	Report Issue Date:	February 1, 2006
	Test Standard(s):	FCC 47 CFR §2, §22H, §24E	Industry Canada RSS-132/133	
	Lab Registration(s):	FCC Registration #714830	Industry Canada Lab File #3874	

ELECTRO-MAGNETIC COMPATIBILITY

EMC TEST REPORT

FOR

ITRONIX CORPORATION

IX325 SERIES RUGGED TABLET PC

INCLUDING

DUAL-BAND PCS/CELLULAR CDMA PCMCIA MODEM

WITH

EXTERNAL HINGED DIPOLE ANTENNA

AND

VEHICLE-MOUNT ANTENNA WITH CRADLE

FCC ID: KBCIX325-AC580

IC: 1943A-IX325f

Test Report Serial Number

100305KBC-T672-E24C

Test Report Issue No.

E672C-020106-R0

Test Lab

**Celltech Compliance Testing & Engineering Lab
(Celltech Labs Inc.)
1955 Moss Court
Kelowna, BC
Canada
V1Y 9L3**

	Test Report Serial No.:	100305KBC-T672-E24C	Report Issue No.:	E672C-020106-R0
	Test Date(s):	07Oct05 - 10Dec05	Report Issue Date:	February 1, 2006
	Test Standard(s):	FCC 47 CFR §2, §22H, §24E	Industry Canada RSS-132/133	
	Lab Registration(s):	FCC Registration #714830	Industry Canada Lab File #3874	



DECLARATION OF COMPLIANCE

Test Lab	CELLTECH LABS INC. Testing and Engineering Services 1955 Moss Court Kelowna, B.C. Canada V1Y 9L3			Applicant Information	ITRONIX CORPORATION 12825 E. Mirabeau Parkway Spokane Valley, WA 99216 United States		
Phone:	250-448-7047						
Fax:	250-448-7048						
e-mail:	info@celltechlabs.com						
web site:	www.celltechlabs.com						
Laboratory Registration No.(s):	FCC:	714830	IC:	3874			
Rule Part(s):	FCC:	Dual-Band CDMA	§2; §22H; §24E				
	IC:	Dual-Band CDMA	RSS-133 Issue 3, RSS-132 Issue 2				
Device Classification:	FCC:	Dual-Band CDMA	PCS Licensed Transmitter (PCB)				
	IC:	Dual-Band CDMA	800 MHz Cellular Telephones Employing New Technologies 2 GHz Personal Communication Services				
Device Identification:	FCC ID:	KBCIX325-AC580	IC:	1943A-IX325f			
DUT Description:							
Model(s):	IX325-AC580						
Device Description:	Rugged Tablet PC						
RF Exposure Category:	Portable (with externally-mounted antenna)			Mobile (with vehicle cradle and vehicle antenna)			
Internal Transmitter(s):	Sierra Wireless AirCard 580 Dual-Band CDMA PCMCIA Modem						
Tx Frequency Range(s):	Dual Band CDMA	Cellular	824.70 - 848.31 MHz				
		PCS	1851.25 - 1908.75 MHz				
Max. RF Output Power Measured:	Dual Band CDMA	Cellular	Conducted	+23.24 dBm	0.211 Watts		
			ERP	+23.10 dBm	0.204 Watts		
		PCS	Conducted	+23.98 dBm	0.250 Watts		
			EIRP	+28.99 dBm	0.793 Watts		
Antenna Type(s) Tested:	Sierra Wireless Hinged Dipole		MaxRad 3dBi Gain Vehicle-Mount (P/N: WMLPVDB800/1900)				
Power Source(s) Tested:	Stationary: 75 Watt AC Power Adapter (Model: ADP-75FB B)						
	11.1 V Internal Lithium-ion Battery, 3600 mAh (Model: T8M-E)						

This wireless device has demonstrated compliance with the applicable technical standards as indicated in the measurement report and was tested in accordance with the measurement procedures specified in FCC 47 CFR Parts 2, 22H, 24E, Industry Canada RSS-132 Issue 2, RSS 133 Issue 3; and ANSI TIA/EIA-603-C-2004.

I attest to the accuracy of the data. All measurements reported herein were performed by me or were under my supervision and are correct to the best of my knowledge and belief. I assume full responsibility for the completeness of these measurements and vouch for the qualifications of all persons taking them.

This test report shall not be reproduced partially, or in full, without the prior written approval of Celltech Labs Inc. The results and statements contained in this report pertain only to the device(s) evaluated.

Tested By: 	Reviewed By: 
for Russell Pipe Senior Compliance Technologist Celltech Labs Inc.	Duane M. Friesen EMC Manager Celltech Labs Inc.



Applicant:	Itronix Corporation	FCC ID:	KBCIX325-AC580	IC ID:	1943A-IX325f	
Rugged Tablet PC with Sierra Wireless AirCard 580 Dual-Band CDMA Modem				Model:	IX325-AC580	
2006 Celltech Labs Inc.	This document is not to be reproduced in whole or in part without the prior written permission of Celltech Labs Inc.					Page 2 of 70



	Test Report Serial No.:	100305KBC-T672-E24C	Report Issue No.:	E672C-020106-R0
	Test Date(s):	07Oct05 - 10Dec05	Report Issue Date:	February 1, 2006
	Test Standard(s):	FCC 47 CFR §2, §22H, §24E	Industry Canada RSS-132/133	
	Lab Registration(s):	FCC Registration #714830	Industry Canada Lab File #3874	

TABLE OF CONTENTS

1.0 SCOPE	6
2.0 REFERENCES	6
2.1 Normative References	6
3.0 TERMS AND DEFINITIONS	7
4.0 FACILITIES AND ACCREDITATIONS	7
5.0 GENERAL INFORMATION	8
5.1 Applicant Information	8
5.2 DUT Description	8
5.3 Co-Located Equipment	8
5.4 Cable Descriptions	9
5.5 Support Equipment	9
5.6 Clock Frequencies	9
5.7 Mode(s) of Operation Tested	10
5.8 Configuration Description	10
6.0 PASS/FAIL CRITERIA	11
APPENDICES	12
Appendix A - Photographs	13
Appendix B - Cellular Band Conducted TX RF Output Power Measurement	14
Appendix C - Conducted Cellular TX Spurious Emissions Measurement	17
Appendix D - Conducted Cellular RX Spurious Emissions Measurement	22
Appendix E - Cellular Band Effective Radiated Power Measurement	26
Appendix F - Radiated Cellular TX Spurious Emissions Measurement	31
Appendix G - PCS Band Conducted TX RF Output Power Measurement	42
Appendix H - Conducted PCS TX Spurious Emissions Measurement	45
Appendix I - Conducted PCS RX Spurious Emissions Measurement	50
Appendix J - PCS Band Effective Isotropic Radiated Power Measurement	54
Appendix K - Radiated PCS TX Spurious Emissions Measurement	59
END OF DOCUMENT	70

	Test Report Serial No.:	100305KBC-T672-E24C	Report Issue No.:	E672C-020106-R0
	Test Date(s):	07Oct05 - 10Dec05	Report Issue Date:	February 1, 2006
	Test Standard(s):	FCC 47 CFR §2, §22H, §24E	Industry Canada RSS-132/133	
	Lab Registration(s):	FCC Registration #714830	Industry Canada Lab File #3874	

FIGURES

Figure B.6-1 - Setup Drawing	15
Figure C.6-1 - Setup Drawing	18
Figure D.6-1 - Setup Drawing	23
Figure E.6-1 - Field Strength Setup Drawing	27
Figure E.6-2 - Signal Substitution Setup Drawing	27
Figure F.6-1 - Field Strength Setup Drawing	33
Figure F.6-2 - Signal Substitution Setup Drawing	33
Figure G.6-1 - Setup Drawing	43
Figure H.6-1 - Setup Drawing	46
Figure I.6-1 - Setup Drawing	51
Figure J.6-1 - Field Strength Setup Drawing	55
Figure J.6-2 - Substitution Setup Drawing	55
Figure K.6-1 - Field Strength Setup Drawing	61
Figure K.6-2 - Signal Substitution Setup Drawing	61

PHOTOGRAPHS

Photograph A.1-1 - Tablet PC in the worst-case Cellular Portable Configuration	13
Photograph A.1-2 - Tablet PC in the worst-case PCS Portable Configuration	13
Photograph A.1-3 - Tablet PC in the Mobile Configuration	13
Photograph A.1-4 - AirCard 580 PCMCIA Modem Card	13
Photograph E.7-1 - Portable DUT Configuration	28
Photograph E.7-2 - Mobile DUT Configuration	28
Photograph E.7-3 - Portable - 3 m Bilog setup	28
Photograph E.7-4 - Mobile - 3 m Bilog Setup	28
Photograph F.7-1 - Portable DUT Configuration	34
Photograph F.7-2 - Mobile DUT Configuration	34
Photograph F.7-3 - Portable - 1 m Horn setup	34
Photograph F.7-4 - Mobile - 3 m Bilog Setup	34
Photograph J.7-1 - Portable DUT Configuration	56
Photograph J.7-2 - Mobile DUT Configuration	56
Photograph J.7-3 - Portable 3 m Horn setup	56
Photograph J.7-4 - Mobile - 3 m Horn Setup	56
Photograph K.7-1 - Portable DUT Configuration	62
Photograph K.7-2 - Mobile DUT Configuration	62
Photograph K.7-3 - Portable - 3 m Horn setup	62
Photograph K.7-4 - Mobile - 1 m Horn Setup	62

 Celltech <small>Testing and Engineering Services Lab</small>	Test Report Serial No.:	100305KBC-T672-E24C	Report Issue No.:	E672C-020106-R0
	Test Date(s):	07Oct05 - 10Dec05	Report Issue Date:	February 1, 2006
	Test Standard(s):	FCC 47 CFR §2, §22H, §24E	Industry Canada RSS-132/133	
	Lab Registration(s):	FCC Registration #714830	Industry Canada Lab File #3874	

TEST SUMMARY

Referenced Standard: FCC CFR Title 47 Part 2, 22H

Appendix	Test Description	Procedure Reference	Limit Reference	Test Start Date	Test End Date	Result
B	Conducted RF Output Power	§2.1046	§2.1046	10Dec05	10Dec05	Pass
C	Conducted TX Spurious Emissions	§22.917(b)	§22.917(a)	10Dec05	10Dec05	Pass
E	Effective Radiated Power	ANSI/TIA/EIA-603-C	§22.913	31Oct05	09Dec05	Pass
F	Radiated TX Spurious Emissions	ANSI/TIA/EIA-603-C	§22.917 (e)	7Oct05	31Oct05	Pass

Referenced Standard: FCC CFR Title 47 Part 2, 24E

G	Conducted RF Output Power	§2.1046	§2.1046	10Dec05	10Dec05	Pass
H	Conducted TX Spurious Emissions	§24.238(b)	§24.238(a)	10Dec05	10Dec05	Pass
J	Effective Isotropic Radiated Power	ANSI/TIA/EIA-603-C	§24.232(b)	25Oct05	08Dec05	Pass
K	Radiated TX Spurious Emissions	ANSI/TIA/EIA-603-C	§24.238 (a)	25Oct05	31Oct05	Pass

Referenced Standard: IC RSS-132 Issue 2

B	Conducted RF Output Power	RSS-Gen §4.6	SRSP-503 §5.1	10Dec05	10Dec05	Pass
C	Conducted TX Spurious Emissions	RSS-Gen §4.7	RSS-132 §4.5	10Dec05	10Dec05	Pass
D	Conducted RX Spurious Emissions	RSS-Gen §4.8	RSS-Gen §6 (b)	10Dec05	10Dec05	Pass
E	Effective Radiated Power	ANSI/TIA/EIA-603-C	SRSP-503 §5.1	31Oct05	09Dec05	Pass
F	Radiated TX Spurious Emissions	RSS-Gen §4.7	RSS-132 §4.5	7Oct05	31Oct05	Pass



Referenced Standard: IC RSS-133 Issue 3

G	Conducted RF Output Power	ANSI/TIA/EIA-603-C	SRSP-510 §5.1.2	10Dec05	10Dec05	Pass
H	Conducted TX Spurious Emissions	RSS-Gen §4.7	RSS-133 §6.5	10Dec05	10Dec05	Pass
I	Conducted RX Spurious Emissions	RSS-133 §4.5	RSS-133 §6.7 (b)	10Dec05	10Dec05	Pass
J	Effective Isotropic Radiated Power	ANSI/TIA/EIA-603-C	RSS-133 §6.4	25Oct05	08Dec05	Pass
K	Radiated TX Spurious Emissions	RSS-Gen §4.7	RSS-133 §6.5	25Oct05	31Oct05	Pass

REVISION LOG

Issue No.	Description	Implemented By	Implementation Date
E672C-020106-R0	Initial Release	Jonathan Hughes	01Feb06

SIGNATORIES

Prepared By:		December 16, 2005
Name/Title	Duane M. Friesen, C.E.T. / EMC Manager	Date
Approved By:		February 1, 2006
Name/Title	Jonathan Hughes / General Manager	Date

Applicant:	Itronix Corporation	FCC ID:	KBCIX325-AC580	IC ID:	1943A-IX325f	
Rugged Tablet PC with Sierra Wireless AirCard 580 Dual-Band CDMA Modem			Model:	IX325-AC580		
2006 Celltech Labs Inc.	This document is not to be reproduced in whole or in part without the prior written permission of Celltech Labs Inc.					Page 5 of 70

	Test Report Serial No.:	100305KBC-T672-E24C	Report Issue No.:	E672C-020106-R0
	Test Date(s):	07Oct05 - 10Dec05	Report Issue Date:	February 1, 2006
	Test Standard(s):	FCC 47 CFR §2, §22H, §24E	Industry Canada RSS-132/133	
	Lab Registration(s):	FCC Registration #714830	Industry Canada Lab File #3874	

1.0 SCOPE

This report outlines the measurements made and results collected during electromagnetic emissions testing of the Itronix Corporation Model: IX325-AC580 Rugged Tablet PC with the internal Sierra Wireless AirCard 580 Dual-Band CDMA PCMCIA Modem. The product was tested in two configurations. The first was the portable configuration with the AirCard 580 Modem connected to an external hinged dipole antenna mounted on the broadband hatch and connected through an RF switch and cable to the PCMCIA Card. The second was the mobile configuration with the Tablet PC mounted in its vehicular cradle with the AirCard 580 Modem connected through the RF switch to a vehicular mounted antenna. The measurement results were applied against the applicable EMC requirements and limits outlined in the technical rules and regulations set forth in the Federal Communication Commission Code of Federal Regulations Title 47 Parts 2, 22 Subpart H, and 24 Subpart E; and Industry Canada Radio Standards Specifications RSS-132 Issue 2, and RSS-133 Issue 3.

2.0 REFERENCES

2.1 Normative References

ANSI/ISO 17025:1999	General Requirements for competence of testing and calibration laboratories
IEEE/ANSI C63.4:2003	Methods of Measurement of Radio-Noise Emissions from Low-Voltage Electrical and Electronic Equipment in the Range of 9 kHz to 40 GHz
IEEE/ANSI Std C95.1:1999	American National Standard Safety Levels with Respect to Human Exposure to Radio Frequency Electromagnetic Fields
ANSI/TIA/EIA-603-C:2004	Land Mobile FM or PM Communication Equipment Measurement and Performance Standards
CFR Title 47: 2004	Code of Federal Regulations Title 47: Telecommunication Part 2: Frequency Allocations and Radio Treaty Matters; General Rules and Regulations Part 22: Public Mobile Services Part 24: Personal Communication Services
IC Spectrum Management & Telecommunications Policy	Radio Standards Specification RSS-132 Issue 2 - 800 MHz Cellular Telephones Employing New Technologies RSS-133 Issue 3 - 2 GHz Personal Communication Services RSS-102 Issue 2 - Evaluation Procedure for Mobile and Portable Radio Transmitters with respect to Health Canada's Safety Code 6 for Exposure of Humans to Radio Frequency Fields

Applicant:	Itronix Corporation	FCC ID:	KBCIX325-AC580	IC ID:	1943A-IX325f	
Rugged Tablet PC with Sierra Wireless AirCard 580 Dual-Band CDMA Modem			Model:	IX325-AC580		
2006 Celltech Labs Inc.	This document is not to be reproduced in whole or in part without the prior written permission of Celltech Labs Inc.					Page 6 of 70

	Test Report Serial No.:	100305KBC-T672-E24C	Report Issue No.:	E672C-020106-R0
	Test Date(s):	07Oct05 - 10Dec05	Report Issue Date:	February 1, 2006
	Test Standard(s):	FCC 47 CFR §2, §22H, §24E	Industry Canada RSS-132/133	
	Lab Registration(s):	FCC Registration #714830	Industry Canada Lab File #3874	

3.0 TERMS AND DEFINITIONS

AV	Average
CDMA	Code Division Multiple Access
CFR	Code of Federal Regulations
dB	decibel
dBm	dB referenced to 1 mW
dBuV	dB referenced to 1 uV
DUT	Device under Test
dBc	dB down from carrier
EBW	Emission Bandwidth
EIRP	Effective Isotropic Radiated Power
EDGE	Enhanced Data Rates for CDMA Evolution
EMC	Electromagnetic Compatibility
ERP	Effective Radiated Power
FCC	Federal Communication Commission
FHSS	Frequency Hopping Spread Spectrum
CDMA	Global Systems for a Mobility Communication
GPRS	General Packet Radio Service
HP	Hewlett Packard
HPF	High Pass Filter
Hpol	Horizontal Polarization
Hz	Hertz
IC	Industry Canada
kHz	kilohertz
LNA	Low Noise Amplifier
m	meter
MHz	Megahertz
Mbps	megabits per second
na	not applicable
n/a	not available
PK	Peak
PPSD	Peak Power Spectral Density
QP	Quasi-peak
RBW	Resolution Bandwidth
R&S	Rohde & Schwarz
RSS	Radio Standard Specification
SA	Spectrum Analyzer
VBW	Video Bandwidth
Vpol	Vertical Polarization
WLAN	Wireless Local Area Network

4.0 FACILITIES AND ACCREDITATIONS

The facilities used in collecting the test results outlined in this report are located at 1955 Moss Court, Kelowna, British Columbia, Canada, V1Y 9L3. The radiated and conducted emissions sites conform with the requirements set forth in ANSI C63.4 and are filed and listed with the FCC under Registration Number 714830 and Industry Canada under File Number IC 3874.

Applicant:	Itronix Corporation	FCC ID:	KBCIX325-AC580	IC ID:	1943A-IX325f	
Rugged Tablet PC with Sierra Wireless AirCard 580 Dual-Band CDMA Modem				Model:	IX325-AC580	
2006 Celltech Labs Inc.	This document is not to be reproduced in whole or in part without the prior written permission of Celltech Labs Inc.					Page 7 of 70

	Test Report Serial No.:	100305KBC-T672-E24C	Report Issue No.:	E672C-020106-R0
	Test Date(s):	07Oct05 - 10Dec05	Report Issue Date:	February 1, 2006
	Test Standard(s):	FCC 47 CFR §2, §22H, §24E	Industry Canada RSS-132/133	
	Lab Registration(s):	FCC Registration #714830	Industry Canada Lab File #3874	

5.0 GENERAL INFORMATION

5.1 Applicant Information

Company Name:	Itronix Corporation
Address:	12825 E. Mirabeau Parkway Spokane Valley, WA 99216 United States

5.2 DUT Description

The DUT consisted of the IX325-AC580 Rugged Tablet PC containing a Sierra Wireless AirCard 580 Dual-Band CDMA PCMCIA Modem connected to either an external hinged dipole antenna mounted on the broadband hatch (portable configuration) or through the mounting cradle and 17 feet of cable to a vehicular mounted antenna (mobile configuration). Photographs of the DUT placement and construction are shown in Appendix A.

Device:	Rugged Tablet PC with externally-mounted antenna, and vehicle cradle with vehicle antenna			
Model:	IX325-AC580			
Serial Number(s):	ZZGEG5073ZZ9782			
Identifier(s):	FCC ID:	KBCIX325-AC580	IC ID:	1943A-IX325f
Power Source(s) Tested:	Stationary: 75 Watt AC Power Adapter (Model: ADP-75FB B) Portable: 11.1V Lithium-ion Battery, 3.6Ah (Model: A2121-2)			

Device:	Dual-Band PCS/Cellular CDMA PCMCIA Modem			
Model:	Sierra Wireless AirCard 580			
Serial Number:	60209FB5			
Rule Part(s):	FCC:	§22.913; §22.917; §24.232; §24.238		
	IC:	RSS-132 Issue 2; RSS-133 Issue 3		
Classification(s):	FCC:	PCS Licensed Transmitter (PCB)		
	IC:	800 MHz Cellular Telephones employing New Technologies (RSS-132) 2 GHz Personal Communication Services (RSS-133)		
Power Source:	Powered from the internal PC power supply			

Device:	External Hinged Dipole Antenna	Model:	Sierra Wireless AirCard 580 Antenna
Device:	IX325 Vehicle Dock (cradle)	Model:	Itronix IX325 VEH DOC
Device:	Vehicle-Mount Antenna	Model:	MaxRad 3dBi Gain (P/N: WMLPVDB800/1900)

5.3 Co-Located Equipment

Device:	GPS Receiver Module (Receive only)		
Model:	Leadtek Model LR9805		
Device:	GPS Antenna (Receive only)		
Model:	Sarantel 101401040/2004UK		

Applicant:	Itronix Corporation	FCC ID:	KBCIX325-AC580	IC ID:	1943A-IX325f	
Rugged Tablet PC with Sierra Wireless AirCard 580 Dual-Band CDMA Modem				Model:	IX325-AC580	
2006 Celltech Labs Inc.	This document is not to be reproduced in whole or in part without the prior written permission of Celltech Labs Inc.					Page 8 of 70

	Test Report Serial No.:	100305KBC-T672-E24C	Report Issue No.:	E672C-020106-R0
	Test Date(s):	07Oct05 - 10Dec05	Report Issue Date:	February 1, 2006
	Test Standard(s):	FCC 47 CFR §2, §22H, §24E	Industry Canada RSS-132/133	
	Lab Registration(s):	FCC Registration #714830	Industry Canada Lab File #3874	

5.4 Cable Descriptions

ROUTING		Length m	Model	Terminations		Shield Type	Shield Termination		Suppression
From	To			End 1	End 2		End 1	End 2	
PC modem port	Unterminated	1.0	n/a	RJ-11	RJ-11	None	na	na	None
PC Ethernet Port	Ethernet Hub	1.0	n/a	RJ-45	RJ-45	None	na	na	None

5.5 Support Equipment

The following equipment was used in support of the DUT.

Co-located Support Equipment List		
Manufacturer	Model	Description
D-Link	DE-809TC/	Ethernet hub
YNG YUH	YP-040	Hub power supply
MLi	699	Speakers
Polk Audio	n/a	Speaker-microphone
	K8255	Keyboard
Sanwa Supply	MA-MBUSB	Mouse

5.6 Clock Frequencies

5.6.1 DUT Clock Frequencies

Device:	Rugged Tablet PC
Clocks:	n/a
Device:	Dual-Band PCS/Cellular CDMA PCMCIA Modem
Clocks:	n/a
Device:	Hinged Dipole Antenna
Clocks:	None

5.6.2 Co-Located Clock Frequencies

Device:	Peripherals
Clocks:	n/a

Applicant:	Itronix Corporation	FCC ID:	KBCIX325-AC580	IC ID:	1943A-IX325f	
Rugged Tablet PC with Sierra Wireless AirCard 580 Dual-Band CDMA Modem				Model:	IX325-AC580	
2006 Celltech Labs Inc.	This document is not to be reproduced in whole or in part without the prior written permission of Celltech Labs Inc.					Page 9 of 70

	Test Report Serial No.:	100305KBC-T672-E24C	Report Issue No.:	E672C-020106-R0
	Test Date(s):	07Oct05 - 10Dec05	Report Issue Date:	February 1, 2006
	Test Standard(s):	FCC 47 CFR §2, §22H, §24E	Industry Canada RSS-132/133	
	Lab Registration(s):	FCC Registration #714830	Industry Canada Lab File #3874	

5.7 Mode(s) of Operation Tested

5.7.1 Dual-Band CDMA Modem

Customer supplied software was used to set the Sierra Wireless AirCard 580 modem to the appropriate channel and power level for the specific measurement. Measurements were made with the modem set to the low, mid and high channel in each band or on a worst-case channel for the measurement, as determined by prescan evaluations. The following settings were used for each channel.

5.7.1.1 Cellular CDMA

Transmitter Frequency Range:	824.70 - 848.31 MHz Ch. 1013 (824.70 MHz) (low), Ch. 363 (835.89 MHz) (mid) & Ch. 777 (848.31 MHz) (high) measured unless otherwise noted
Software Power Gain Settings:	Set by manufacturer software or CDMA test set communications for "all ups"
Modulation Type(s):	QPSK

5.7.1.2 PCS CDMA

Transmitter Frequency Range:	1851.25 - 1908.75 MHz Ch. 25 (1851.25 MHz) (low), Ch 600 (1880.00 MHz) (mid) & Ch. 1175 (1908.75 MHz) (high) measured unless otherwise noted
Software Power Gain Settings:	Set by manufacturer software or CDMA test set communications for "all ups"
Modulation Type(s):	QPSK

5.7.2 DUT Exercising Software Description

The DUT was configured and exercised during the RF conducted output power measurements using customer supplied test software "Directed Test Version 2.8", that allowed an operator to place the Dual-Band CDMA modem in an "all ups" mode. The modem manufacturer described this mode as one in which the modem transmitted at its maximum power level. For all radiated testing, the "all ups" mode was initiated with a call being connected with a CDMA test set through an antenna placed near the DUT.

5.8 Configuration Description

The DUT was configured in each of two configurations, as described by the client as being representative of what would be delivered to a final customer. The first was a portable configuration, which utilized the attached hinged dipole antenna, the second a mobile configuration where the tablet PC was installed in a vehicular cradle and utilized a mobile antenna mounted on the vehicle. Because the hinged dipole antenna orientation could be user configured and the tablet PC could be oriented in a number of positions in its portable configuration, prescan evaluations were made to determine the configuration that resulted in the highest emissions. A "face up, vertical antenna" orientation was determined for the cellular band whereas a "face up, horizontal antenna" was worst-case for the PCS band. The mobile configuration was tested with the tablet PC installed in the vehicle cradle, attached to the vehicle antenna thru a typical 17' cable. Both configurations were investigated and the results reported herein. For the RF conducted measurements, a cable utilized internally to the unit to connect the card to the antenna port was used to connect the measurement equipment to the internal modem card. More specific details may be included in each appendix.

5.8.1 Configuration Justification

The DUT was tested in a configuration described by the client as being typical of normal use.

Applicant:	Itronix Corporation	FCC ID:	KBCIX325-AC580	IC ID:	1943A-IX325f	
Rugged Tablet PC with Sierra Wireless AirCard 580 Dual-Band CDMA Modem				Model:	IX325-AC580	
2006 Celltech Labs Inc.	This document is not to be reproduced in whole or in part without the prior written permission of Celltech Labs Inc.					Page 10 of 70

	Test Report Serial No.:	100305KBC-T672-E24C	Report Issue No.:	E672C-020106-R0
	Test Date(s):	07Oct05 - 10Dec05	Report Issue Date:	February 1, 2006
	Test Standard(s):	FCC 47 CFR §2, §22H, §24E	Industry Canada RSS-132/133	
	Lab Registration(s):	FCC Registration #714830	Industry Canada Lab File #3874	

6.0 PASS/FAIL CRITERIA

Unless otherwise noted in the Appendices, the pass/fail criterion is the limit set forth in the reference standards. A DUT is considered to have passed the requirements, if the data collected during the described measurement procedure is within the specified limits as defined. The pass/fail statements made in this report only apply to the unit tested.

Applicant:	Itronix Corporation	FCC ID:	KBCIX325-AC580	IC ID:	1943A-IX325f	
Rugged Tablet PC with Sierra Wireless AirCard 580 Dual-Band CDMA Modem				Model:	IX325-AC580	
2006 Celltech Labs Inc.	This document is not to be reproduced in whole or in part without the prior written permission of Celltech Labs Inc.					Page 11 of 70

	Test Report Serial No.:	100305KBC-T672-E24C	Report Issue No.:	E672C-020106-R0
	Test Date(s):	07Oct05 - 10Dec05	Report Issue Date:	February 1, 2006
	Test Standard(s):	FCC 47 CFR §2, §22H, §24E	Industry Canada RSS-132/133	
	Lab Registration(s):	FCC Registration #714830	Industry Canada Lab File #3874	

APPENDICES

Applicant:	Itronix Corporation	FCC ID:	KBCIX325-AC580	IC ID:	1943A-IX325f	
Rugged Tablet PC with Sierra Wireless AirCard 580 Dual-Band CDMA Modem				Model:	IX325-AC580	
2006 Celltech Labs Inc.	This document is not to be reproduced in whole or in part without the prior written permission of Celltech Labs Inc.					Page 12 of 70

	Test Report Serial No.:	100305KBC-T672-E24C	Report Issue No.:	E672C-020106-R0
	Test Date(s):	07Oct05 - 10Dec05	Report Issue Date:	February 1, 2006
	Test Standard(s):	FCC 47 CFR §2, §22H, §24E	Industry Canada RSS-132/133	
	Lab Registration(s):	FCC Registration #714830	Industry Canada Lab File #3874	

Appendix A - Photographs

A.1. DUT PHOTOGRAPHS

Photograph A.1-1 - Tablet PC in the worst-case Cellular Portable Configuration



Photograph A.1-2 - Tablet PC in the worst-case PCS Portable Configuration

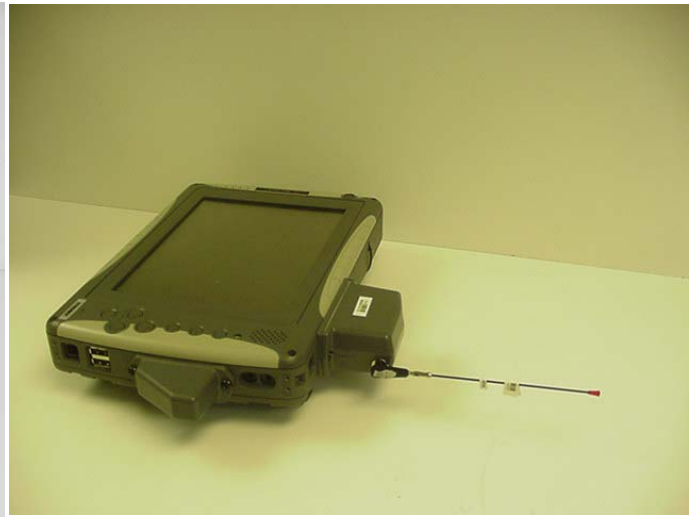

Photograph A.1-3 - Tablet PC in the Mobile Configuration



Photograph A.1-4 - AirCard 580 PCMCIA Modem Card



	Test Report Serial No.:	100305KBC-T672-E24C	Report Issue No.:	E672C-020106-R0
	Test Date(s):	07Oct05 - 10Dec05	Report Issue Date:	February 1, 2006
	Test Standard(s):	FCC 47 CFR §2, §22H, §24E	Industry Canada RSS-132/133	
	Lab Registration(s):	FCC Registration #714830	Industry Canada Lab File #3874	

Appendix B - Cellular Band Conducted TX RF Output Power Measurement

B.1. REFERENCES

Normative Reference Standard	FCC CFR 47 §2.1046
Procedure Reference	FCC CFR 47 §2.1046

B.2. LIMITS

FCC CFR 47 §2.1046 (a) For transmitters other than single sideband, independent sideband and controlled carrier radiotelephone, power output shall be measured at the RF output terminals when the transmitter is adjusted in accordance with the tune-up procedures to give the values of current and voltage on the circuit elements specified in §2.1033(c) (8).

*ERP limits are specified in Appendix E.

B.3. ENVIRONMENTAL CONDITIONS

Temperature	25 ± 5 °C
Humidity	35 ± 5 %RH
Barometric Pressure	uncontrolled

B.4. EQUIPMENT LIST

ASSET NUMBER	MANUFACTURER	MODEL	DESCRIPTION	LAST CAL	CAL DUE
00110	Gigatronics	8652A	Power Meter	16Apr05	16Apr06
00012	Gigatronics	80701A	Power Sensor	12Sep05	12Sep06
00102	Pasternack	PE7014-30	30dB attenuator	na	na*

*Attenuator offset in power meter

Applicant:	Itronix Corporation	FCC ID:	KBCIX325-AC580	IC ID:	1943A-IX325f	
Rugged Tablet PC with Sierra Wireless AirCard 580 Dual-Band CDMA Modem			Model:	IX325-AC580		
2006 Celltech Labs Inc.	This document is not to be reproduced in whole or in part without the prior written permission of Celltech Labs Inc.					Page 14 of 70

	Test Report Serial No.:	100305KBC-T672-E24C	Report Issue No.:	E672C-020106-R0
	Test Date(s):	07Oct05 - 10Dec05	Report Issue Date:	February 1, 2006
	Test Standard(s):	FCC 47 CFR §2, §22H, §24E	Industry Canada RSS-132/133	
	Lab Registration(s):	FCC Registration #714830	Industry Canada Lab File #3874	

B.5. MEASUREMENT EQUIPMENT SETUP

Measurement Equipment Connections	The equipment was connected as shown in the setup drawing in B.6.
Measurement Equipment Settings	Power Meter Settings: Mode - MAP Frequency compensation set for carrier frequency Offset set appropriately to compensate for attenuator
Measurement Procedure	The RF conducted power levels were measured at the DUT antenna connector port using a Gigatronics 8652A Universal Power Meter in mean average power mode. An offset was entered into the power meter to correct for the loss of the attenuator installed between the output port and the power sensor input. The DUT test software was used to set it to transmit in the CDMA "always up" power control mode.

B.6. SETUP DRAWING

Figure B.6-1 - Setup Drawing

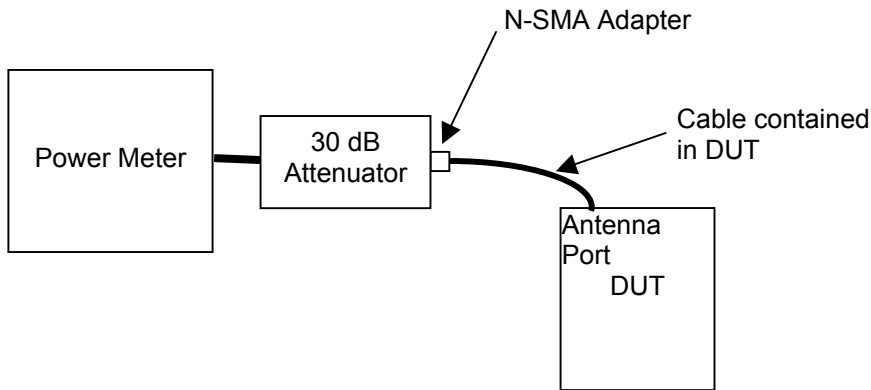

B.7. DUT OPERATING DESCRIPTION

Power measurements were made for each of the three Cellular test channels (Channel 1013, 363, & 777), with the AirCard 580 modem set appropriately as described in section 5.7.

	Test Report Serial No.:	100305KBC-T672-E24C	Report Issue No.:	E672C-020106-R0
	Test Date(s):	07Oct05 - 10Dec05	Report Issue Date:	February 1, 2006
	Test Standard(s):	FCC 47 CFR §2, §22H, §24E	Industry Canada RSS-132/133	
	Lab Registration(s):	FCC Registration #714830	Industry Canada Lab File #3874	

B.8. TEST RESULTS

Mode	Channel	Frequency	Conducted Power	
		MHz	dBm	watts
Cellular CDMA	1013	824.700 MHz	+23.24	0.211
	363	835.890 MHz	+22.96	0.198
	777	848.310 MHz	+23.19	0.208

B.9. PASS/FAIL

There is no pass/fail criterion for this measurement. The ERP values, applied to appropriate regulatory requirements are outlined in Appendix E.

B.10. SIGN-OFF

I attest to the accuracy of the data. All measurements reported herein were performed by me and are correct to the best of my knowledge and belief. I assume full responsibility for the completeness of these measurements.

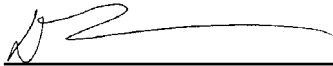

Duane M. Friesen
EMC Manager
Celltech Labs Inc.

10Dec05
Date

Applicant:	Itronix Corporation	FCC ID:	KBCIX325-AC580	IC ID:	1943A-IX325f	
Rugged Tablet PC with Sierra Wireless AirCard 580 Dual-Band CDMA Modem				Model:	IX325-AC580	
2006 Celltech Labs Inc.	This document is not to be reproduced in whole or in part without the prior written permission of Celltech Labs Inc.					Page 16 of 70

	Test Report Serial No.:	100305KBC-T672-E24C	Report Issue No.:	E672C-020106-R0
	Test Date(s):	07Oct05 - 10Dec05	Report Issue Date:	February 1, 2006
	Test Standard(s):	FCC 47 CFR §2, §22H, §24E	Industry Canada RSS-132/133	
	Lab Registration(s):	FCC Registration #714830	Industry Canada Lab File #3874	

Appendix C - Conducted Cellular TX Spurious Emissions Measurement

C.1. REFERENCES	
Normative Reference Standard	FCC CFR 47 §22.917(a)
Procedure Reference	FCC CFR 47 §22.917(b)

C.2. LIMITS	
FCC CFR 47 §22.917	(a) <i>Out of Band Emissions. The mean power of emissions must be attenuated below the mean power of the unmodulated carrier (P) on any frequency twice or more than twice the fundamental frequency by: at least 43 + 10 log P dB</i>

C.3. ENVIRONMENTAL CONDITIONS	
Temperature	25 ± 5 °C
Humidity	35 ± 5 %RH
Barometric Pressure	uncontrolled

C.4. EQUIPMENT LIST						
ID	ASSET NUMBER	MANUFACTURER	MODEL	DESCRIPTION	LAST CAL	CAL DUE
1	00015	Agilent	E4408B	Spectrum Analyzer	24Jan05	24Jan06
2	00102	Pasternack	PE7015-3030	30dB attenuator	na	na*
3	na	Itronix	na	Cable & SMA adapter	na	na*

*Verified with VNA

C.5. MEASUREMENT EQUIPMENT SETUP						
MEASUREMENT EQUIPMENT CONNECTIONS	The measurement equipment was connected as shown in C.6.					
MEASUREMENT EQUIPMENT SETTINGS	The spectrum analyzer was set to the following settings:					
	Frequency Range	RBW	VBW	Attenuator	Offset	Detector
	MHz	kHz	MHz	dB	dB	
	Within 1 MHz of the Block edges	10 *	1	10	-30.0	Sample*
Beyond 1MHz from Block edges	100	1	0	-30.0	Peak	

*10 kHz RBW & sample detector used for band-edge, 100 kHz & peak used for wider span scans. Band-edge measurements corrected for specified BW of 1% of EBW within Block and 1 MHz of each edge.

Applicant:	Itronix Corporation	FCC ID:	KBCIX325-AC580	IC ID:	1943A-IX325f	
Rugged Tablet PC with Sierra Wireless AirCard 580 Dual-Band CDMA Modem				Model:	IX325-AC580	
2006 Celltech Labs Inc.	This document is not to be reproduced in whole or in part without the prior written permission of Celltech Labs Inc.					Page 17 of 70

	Test Report Serial No.:	100305KBC-T672-E24C	Report Issue No.:	E672C-020106-R0
	Test Date(s):	07Oct05 - 10Dec05	Report Issue Date:	February 1, 2006
	Test Standard(s):	FCC 47 CFR §2, §22H, §24E	Industry Canada RSS-132/133	
	Lab Registration(s):	FCC Registration #714830	Industry Canada Lab File #3874	

C.6. SETUP DRAWING

Figure C.6-1 - Setup Drawing

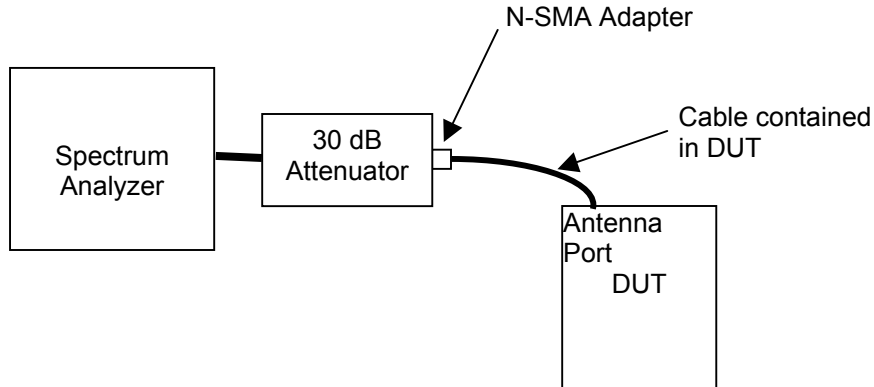

C.7. DUT OPERATING DESCRIPTION

Measurements were made with the DUT transmitting at maximum power in the cellular band, in a configuration as described in Section 5 of this report. The Block edge measurements were made with the DUT transmitting on the channel closest to the edge under investigation (CH1013 & CH777). The remaining spurious measurements were made on each of the three channels: Low (CH1013), Mid (CH363) and High (CH777).

Applicant:	Itronix Corporation	FCC ID:	KBCIX325-AC580	IC ID:	1943A-IX325f	
Rugged Tablet PC with Sierra Wireless AirCard 580 Dual-Band CDMA Modem			Model:	IX325-AC580		
2006 Celltech Labs Inc.	This document is not to be reproduced in whole or in part without the prior written permission of Celltech Labs Inc.					Page 18 of 70



Test Report Serial No.:	100305KBC-T672-E24C	Report Issue No.:	E672C-020106-R0
Test Date(s):	07Oct05 - 10Dec05	Report Issue Date:	February 1, 2006
Test Standard(s):	FCC 47 CFR §2, §22H, §24E	Industry Canada RSS-132/133	
Lab Registration(s):	FCC Registration #714830	Industry Canada Lab File #3874	

C.8. TEST RESULTS

C.8.1. Spurious Emissions within 1MHz of Block Edge

Lower Block Edge - 824 MHz (Channel 1013)

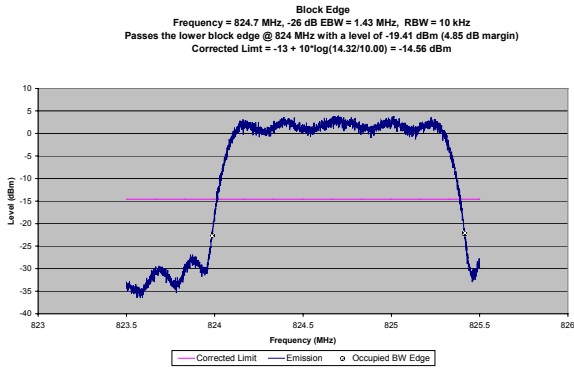

Upper Block Edge - 849 MHz (Channel 777)

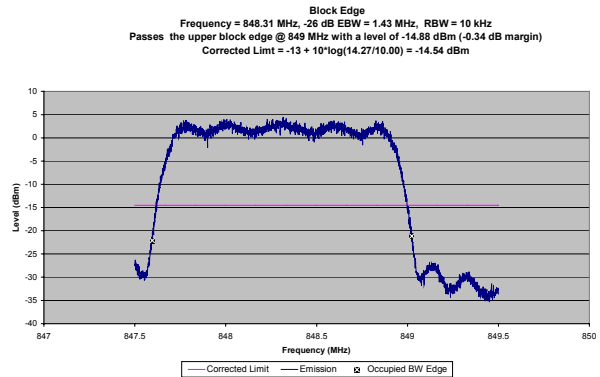

Corrected Limit (dBm) = Specified Limit (dBm) + $10 \cdot \log(BW_1/BW_2)$ where: BW_1 is the measurement RBW and BW_2 is 1% of the EBW.

Frequency	Level	EBW	1% EBW Correction	Limit	Corrected Limit	Margin	Frequency	Level	EBW	1% EBW Correction	Limit	Corrected Limit	Margin
MHz	dBm	MHz	dB	dBm	dBm	dB	MHz	dBm	MHz	dB	dBm	dBm	dB
824.018	-19.409	1.432	-1.559	-13.000	-14.559	4.850	848.997	-14.884	1.427	-1.544	-13.000	-14.544	0.340

Applicant: Itronix Corporation **FCC ID:** KBCIX325-AC580 **IC ID:** 1943A-IX325f

Rugged Tablet PC with Sierra Wireless AirCard 580 Dual-Band CDMA Modem **Model:** IX325-AC580





Test Report Serial No.:	100305KBC-T672-E24C	Report Issue No.:	E672C-020106-R0
Test Date(s):	07Oct05 - 10Dec05	Report Issue Date:	February 1, 2006
Test Standard(s):	FCC 47 CFR §2, §22H, §24E	Industry Canada RSS-132/133	
Lab Registration(s):	FCC Registration #714830	Industry Canada Lab File #3874	

C.8.2. Conducted Transmit Spurious Emissions removed by more than 1MHz from Block Edge

Channel 1013

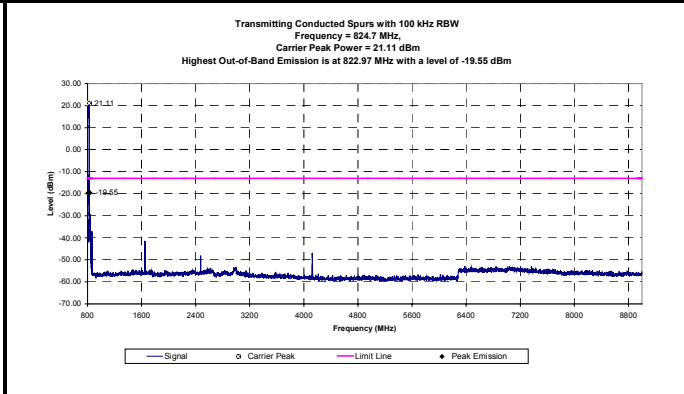
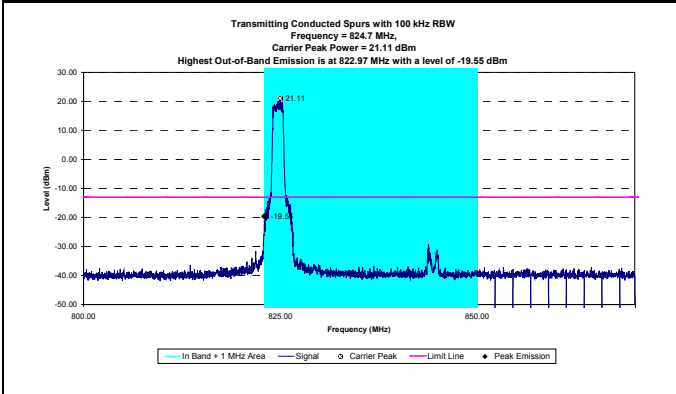

Channel 363

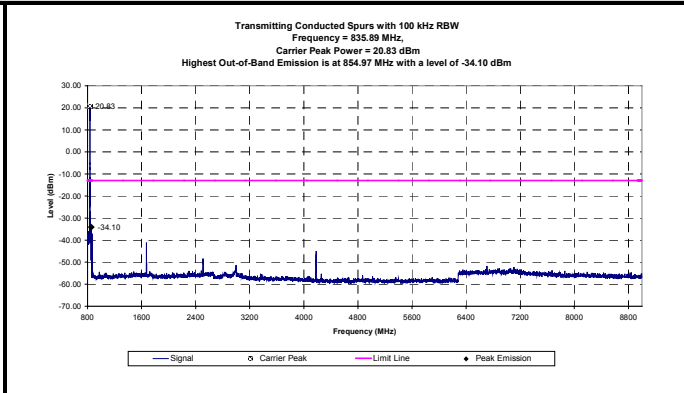
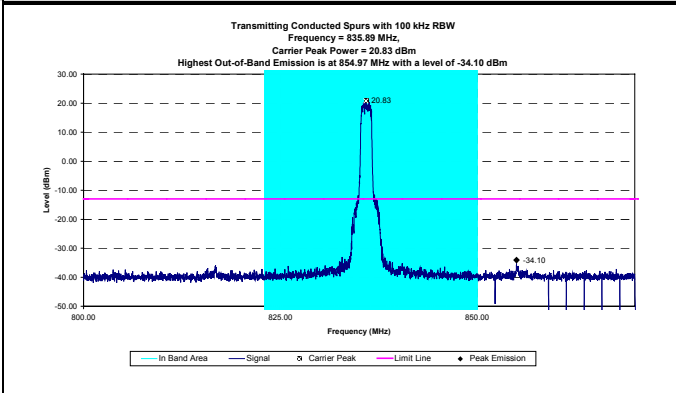

Channel 777

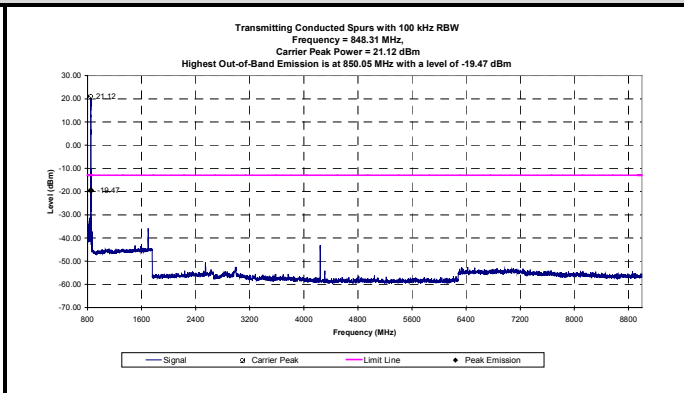
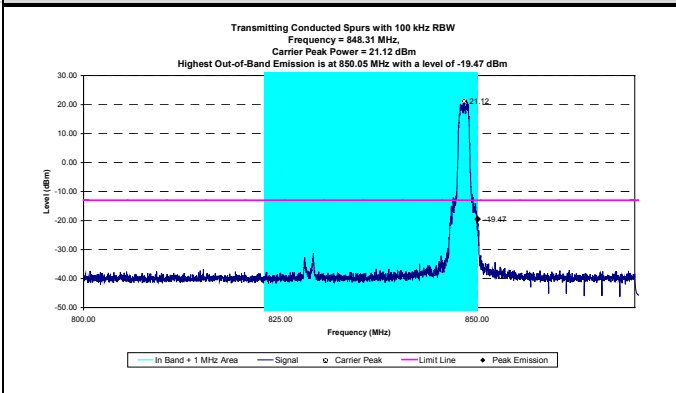

Channel	Peak Spurious Emission		Limit	Margin	Pass / Fail
	Frequency	Level			
	MHz	dBm			
1013	822.97	-19.55	-13.00	6.55	Pass
363	854.97	-34.10	-13.00	21.10	Pass
777	850.05	-19.47	-13.00	6.47	Pass

Applicant:	Itronix Corporation	FCC ID:	KBCIX325-AC580	IC ID:	1943A-IX325f	
Rugged Tablet PC with Sierra Wireless AirCard 580 Dual-Band CDMA Modem				Model:	IX325-AC580	
2006 Celltech Labs Inc.	This document is not to be reproduced in whole or in part without the prior written permission of Celltech Labs Inc.					Page 20 of 70

	Test Report Serial No.:	100305KBC-T672-E24C	Report Issue No.:	E672C-020106-R0
	Test Date(s):	07Oct05 - 10Dec05	Report Issue Date:	February 1, 2006
	Test Standard(s):	FCC 47 CFR §2, §22H, §24E	Industry Canada RSS-132/133	
	Lab Registration(s):	FCC Registration #714830	Industry Canada Lab File #3874	

C.9. PASS/FAIL

In reference to the results outlined in C.9, the DUT passes the requirements as stated in the reference standards.

FCC CFR 4 §22.217 (a) Out of band emissions. The power of any emission outside of the authorized operating frequency ranges must be attenuated below the transmitting power (P) by a factor of at least $43 + 10 \log(P)$ dB.

The results set forth in this section meet the requirement with a margin of at least 0.34 dB (-14.88 dBm @ 848.997 MHz versus a corrected limit of -14.54 dBm)

C.10. SIGN-OFF

I attest to the accuracy of the data. All measurements reported herein were performed by me and are correct to the best of my knowledge and belief. I assume full responsibility for the completeness of these measurements.



 Duane M. Friesen
 EMC Manager
 Celltech Labs Inc.

 10Dec05
 Date

Applicant:	Itronix Corporation	FCC ID:	KBCIX325-AC580	IC ID:	1943A-IX325f	
Rugged Tablet PC with Sierra Wireless AirCard 580 Dual-Band CDMA Modem			Model:	IX325-AC580		
2006 Celltech Labs Inc.		This document is not to be reproduced in whole or in part without the prior written permission of Celltech Labs Inc.				Page 21 of 70

	Test Report Serial No.:	100305KBC-T672-E24C	Report Issue No.:	E672C-020106-R0
	Test Date(s):	07Oct05 - 10Dec05	Report Issue Date:	February 1, 2006
	Test Standard(s):	FCC 47 CFR §2, §22H, §24E	Industry Canada RSS-132/133	
	Lab Registration(s):	FCC Registration #714830	Industry Canada Lab File #3874	

Appendix D - Conducted Cellular RX Spurious Emissions Measurement

D.1. REFERENCES	
Normative Reference Standard	IC RSS-132 §6.6 (b)
Procedure Reference	IC RSS-132 §4.6

D.2. LIMITS	
IC RSS-132 §6.6	<i>(b) If a conducted measurement is made, no spurious output signals appearing at the antenna terminals shall exceed 2 nanowatts per 4 kHz spurious frequency in the band 30 – 1000 MHz or 5 nanowatts above 1 GHz.</i>

D.3. ENVIRONMENTAL CONDITIONS	
Temperature	25 ± 5 °C
Humidity	35 ± 5 %RH
Barometric Pressure	uncontrolled

D.4. EQUIPMENT LIST						
ID	ASSET NUMBER	MANUFACTURER	MODEL	DESCRIPTION	LAST CAL	CAL DUE
1	00015	Agilent	E4408B	Spectrum Analyzer	24Jan05	24Jan06
2	00188	Narda	M3933/16-06	2 x 2dB attenuator	na	na*
3	na	Itronix	na	Cable & SMA adapter	na	na*

*Verified with VNA

D.5. MEASUREMENT EQUIPMENT SETUP				
MEASUREMENT EQUIPMENT CONNECTIONS	The measurement equipment was connected as shown in D.6.			
MEASUREMENT EQUIPMENT SETTINGS	Initial scan spectrum analyzer settings:			
	Frequency Range	RBW	VBW	Detector
	MHz	kHz	MHz	
	30 MHz - 3 x F _c	10	1	Peak
	Peak zoom scan (of peaks within 10 dB of limit) spectrum analyzer settings:			
	Frequency Range	RBW	VBW	Detector
	MHz	kHz	MHz	
Peak F _c +/- 1 MHz	4*	1	Peak	

Note: 4 kHz RBW & VBW are not attainable with equipment used and 3 kHz will be used. A bandwidth correction factor of 10 * log (4 kHz / 3 kHz), (1.25 dB) will be added to the final results.

Applicant:	Itronix Corporation	FCC ID:	KBCIX325-AC580	IC ID:	1943A-IX325f	
Rugged Tablet PC with Sierra Wireless AirCard 580 Dual-Band CDMA Modem				Model:	IX325-AC580	
2006 Celltech Labs Inc.	This document is not to be reproduced in whole or in part without the prior written permission of Celltech Labs Inc.					Page 22 of 70

	Test Report Serial No.:	100305KBC-T672-E24C	Report Issue No.:	E672C-020106-R0
	Test Date(s):	07Oct05 - 10Dec05	Report Issue Date:	February 1, 2006
	Test Standard(s):	FCC 47 CFR §2, §22H, §24E	Industry Canada RSS-132/133	
	Lab Registration(s):	FCC Registration #714830	Industry Canada Lab File #3874	

D.6. SETUP DRAWING

Figure D.6-1 - Setup Drawing

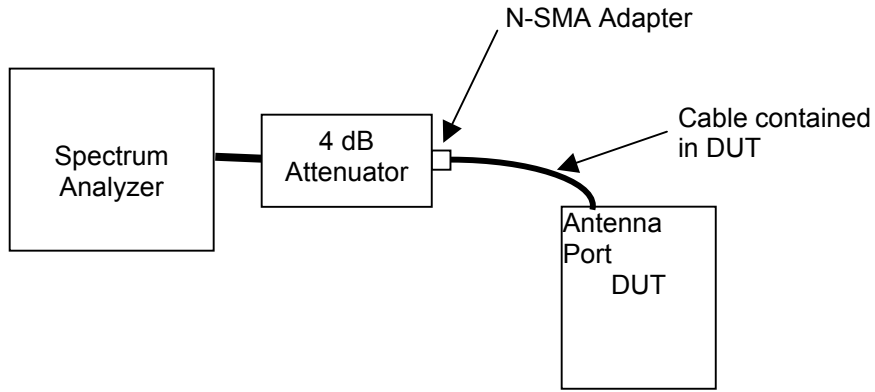

D.7. DUT OPERATING DESCRIPTION

Measurements were made with the DUT in receive mode for the cellular mid channel (CH363 835.890 MHz)

Applicant:	Itronix Corporation	FCC ID:	KBCIX325-AC580	IC ID:	1943A-IX325f	
Rugged Tablet PC with Sierra Wireless AirCard 580 Dual-Band CDMA Modem				Model:	IX325-AC580	
2006 Celltech Labs Inc.	This document is not to be reproduced in whole or in part without the prior written permission of Celltech Labs Inc.					Page 23 of 70



Test Report Serial No.:	100305KBC-T672-E24C	Report Issue No.:	E672C-020106-R0
Test Date(s):	07Oct05 - 10Dec05	Report Issue Date:	February 1, 2006
Test Standard(s):	FCC 47 CFR §2, §22H, §24E	Industry Canada RSS-132/133	
Lab Registration(s):	FCC Registration #714830	Industry Canada Lab File #3874	

D.8. TEST RESULTS

D.8.1. Receiver Spurious Emissions

Receiver Conducted Spurs with 10 kHz RBW
 Frequency = 835.89 MHz,
 The lowest margin is at 729.40 MHz at 17.4 dB

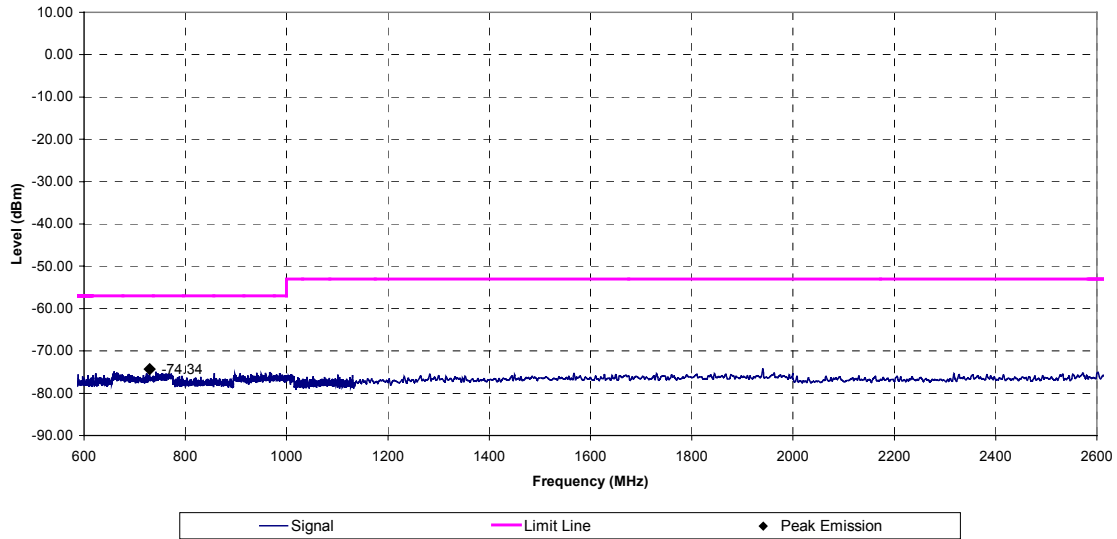

Calculations:

Limit (dBm) = 10 * log (Limit (mW))
 BW Correction* = 10 * log (4 kHz / 3 kHz)
 Margin (dB) = Limit (dBm) - Peak Emission (dBm)

*BW Correction used for zoom scan (made of emissions within 10 dB of the applicable limit) only.

Applicant:	Itronix Corporation	FCC ID:	KBCIX325-AC580	IC ID:	1943A-IX325f	
Rugged Tablet PC with Sierra Wireless AirCard 580 Dual-Band CDMA Modem				Model:	IX325-AC580	
2006 Celltech Labs Inc.	This document is not to be reproduced in whole or in part without the prior written permission of Celltech Labs Inc.					Page 24 of 70

	Test Report Serial No.:	100305KBC-T672-E24C	Report Issue No.:	E672C-020106-R0
	Test Date(s):	07Oct05 - 10Dec05	Report Issue Date:	February 1, 2006
	Test Standard(s):	FCC 47 CFR §2, §22H, §24E	Industry Canada RSS-132/133	
	Lab Registration(s):	FCC Registration #714830	Industry Canada Lab File #3874	

D.9. PASS/FAIL

In reference to the results outlined in D.9, the DUT passes the requirements as stated in the reference standards.

IC RSS-132 §6.6 (b) If a conducted measurement is made, no spurious output signals appearing at the antenna terminals shall exceed 2 nanowatts per 4kHz spurious frequency in the band 30 – 1000 MHz or 5 nanowatts above 1 GHz.

The results set forth in this section meet the requirement with a margin of at least 17.4 dB.

D.10. SIGN-OFF

I attest to the accuracy of the data. All measurements reported herein were performed by me and are correct to the best of my knowledge and belief. I assume full responsibility for the completeness of these measurements.



 Duane M. Friesen
 EMC Manager
 Celltech Labs Inc.

 10Dec05
 Date

Applicant:	Itronix Corporation	FCC ID:	KBCIX325-AC580	IC ID:	1943A-IX325f	
Rugged Tablet PC with Sierra Wireless AirCard 580 Dual-Band CDMA Modem				Model:	IX325-AC580	
2006 Celltech Labs Inc.		This document is not to be reproduced in whole or in part without the prior written permission of Celltech Labs Inc.				Page 25 of 70

 Celltech Testing and Engineering Services Lab	Test Report Serial No.:	100305KBC-T672-E24C	Report Issue No.:	E672C-020106-R0
	Test Date(s):	07Oct05 - 10Dec05	Report Issue Date:	February 1, 2006
	Test Standard(s):	FCC 47 CFR §2, §22H, §24E	Industry Canada RSS-132/133	
	Lab Registration(s):	FCC Registration #714830	Industry Canada Lab File #3874	

Appendix E - Cellular Band Effective Radiated Power Measurement

E.1. REFERENCES	
Normative Reference Standard	FCC CFR 47 §22.913 (a)
Procedure Reference	ANSI/TIA/EIA-603-C

E.2. LIMITS	
FCC CFR 47 §22.913 (a)	(a) Maximum ERP. The ERP of mobile transmitters and auxiliary transmitters must not exceed 7 Watts.

E.3. ENVIRONMENTAL CONDITIONS	
Temperature	uncontrolled
Humidity	uncontrolled
Barometric Pressure	uncontrolled

E.4. EQUIPMENT LIST						
RECEIVING EQUIPMENT						
ID	ASSET NUMBER	MANUFACTURER	MODEL	DESCRIPTION	LAST CAL	CAL DUE
1	00072	EMCO	2075	Mini-mast	na	na
2	00073	EMCO	2080	Turn Table	na	na
3	00071	EMCO	2090	Multi-Device Controller	na	na
4	00050	Chase	CBL-6111A	Bilog Antenna	08Feb05	08Feb06
5	00051	HP	8566B	Spectrum Analyzer	12Apr05	12Apr06
6	00047	HP	85685A	Preselector	13Apr05	13Apr06
7	00031	HP	E8285A	CDMA Test set	na	na
8	00120	Celltech	n/a	Microwave Cable (RX)	25Mar05	25Mar06
9	00121	Andrew	FSJ4-50B	Microwave Cable (RX)	25Mar05	25Mar06
10	00130	Andrew	FSJ1-50A	Microwave Cable (RX)	25Mar05	25Mar06
ADDITIONAL SUBSTITUTION EQUIPMENT						
ID	ASSET NUMBER	MANUFACTURER	MODEL	DESCRIPTION	LAST CAL	CAL DUE
11	00059	ETS	3121C	Roberts Dipole	04Dec03	04Dec06
12	00131	Andrew	FSJ1-50A	Microwave Cable (TX)	na	na
13	00127	Andrew	FSJ4-50B	Microwave Cable (TX)	na	na
14	00133	Andrew	FSJ1-50A	Microwave Cable (TX)	na	na
15	00006	R & S	SMR40	Signal Generator	12Apr05	12Apr06
16	00110	Gigatronics	8652A	Power Meter	16Apr05	16Apr06
17	00012	Gigatronics	80701A	Power Sensor	12Sep05	12Sep06
18	00014	Gigatronics	80701A	Power Sensor	7Sep05	7Sep06
19	00102	Pasternack	PE7015-3110	30 dB attenuator	na*	na*
20	00078	Pasternack	PE2214-20	Directional Coupler	na*	na*

*Attenuation offset in power meter setup

Applicant:	Itronix Corporation	FCC ID:	KBCIX325-AC580	IC ID:	1943A-IX325f	
Rugged Tablet PC with Sierra Wireless AirCard 580 Dual-Band CDMA Modem				Model:	IX325-AC580	
2006 Celltech Labs Inc.	This document is not to be reproduced in whole or in part without the prior written permission of Celltech Labs Inc.					Page 26 of 70

E.5. MEASUREMENT EQUIPMENT SETUP

MEASUREMENT EQUIPMENT CONNECTIONS	The measurement equipment was connected as shown in E.6.			
MEASUREMENT EQUIPMENT SETTINGS	The spectrum analyzer was set to the following settings:			
	Frequency Range	RBW	VBW	Detector
	MHz	kHz	kHz	
30 - 1000	100	100	Peak	

E.6. SETUP DRAWING

Figure E.6-1 - Field Strength Setup Drawing

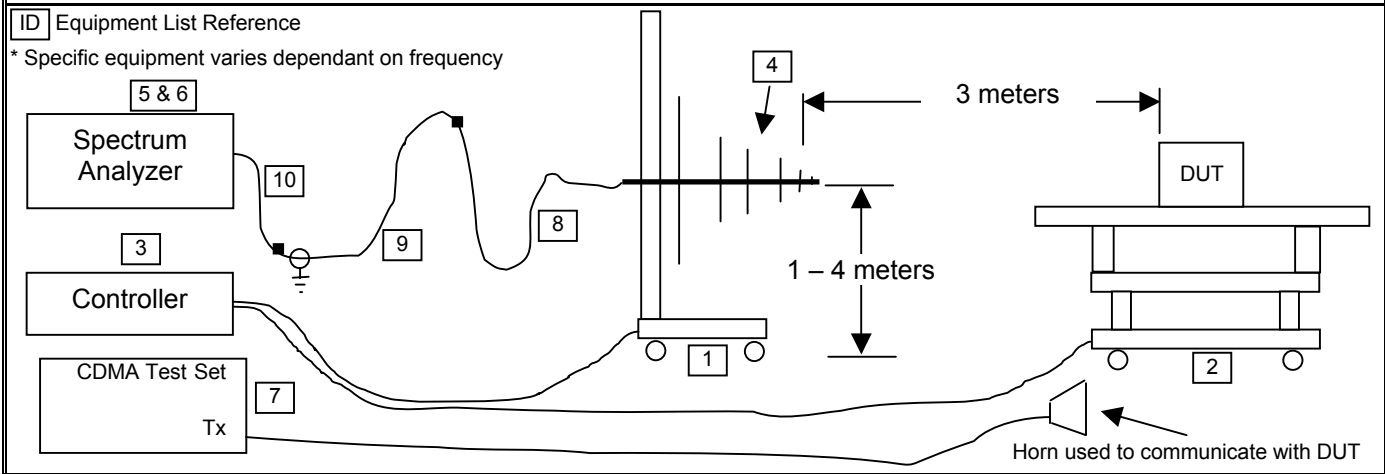
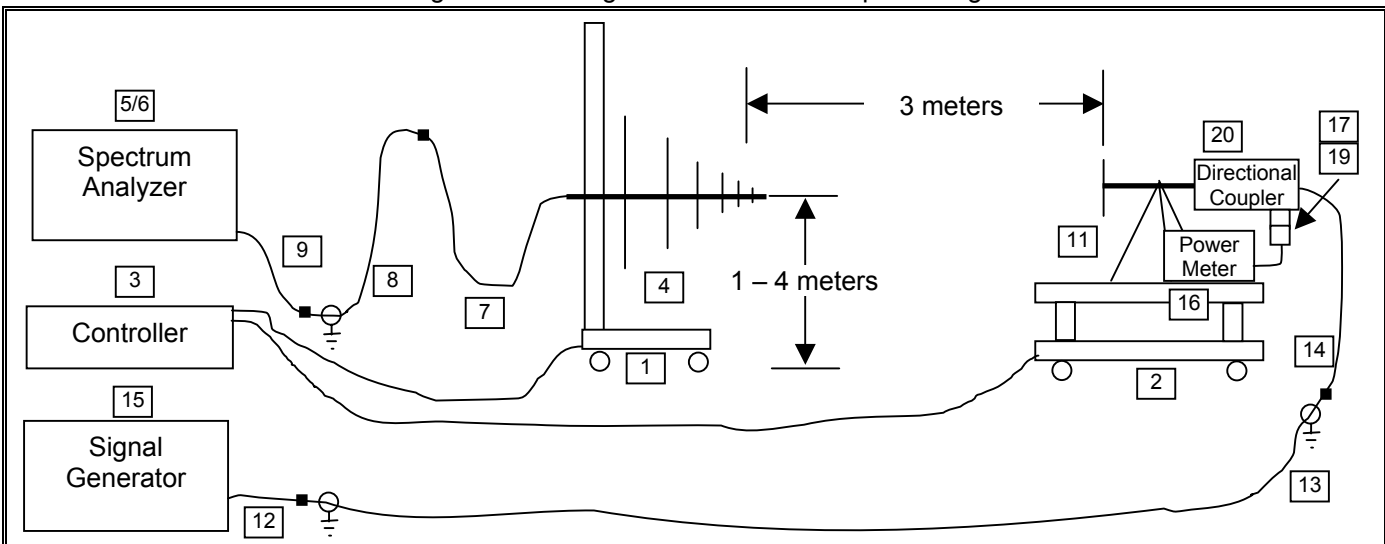

Figure E.6-2 - Signal Substitution Setup Drawing



Test Report Serial No.:	100305KBC-T672-E24C	Report Issue No.:	E672C-020106-R0
Test Date(s):	07Oct05 - 10Dec05	Report Issue Date:	February 1, 2006
Test Standard(s):	FCC 47 CFR §2, §22H, §24E	Industry Canada RSS-132/133	
Lab Registration(s):	FCC Registration #714830	Industry Canada Lab File #3874	

E.7. SETUP PHOTOGRAPHS

Photograph E.7-1 - Portable DUT Configuration

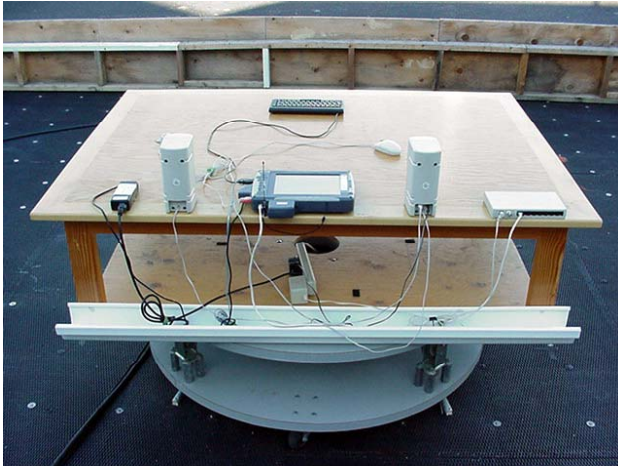

Photograph E.7-2 - Mobile DUT Configuration

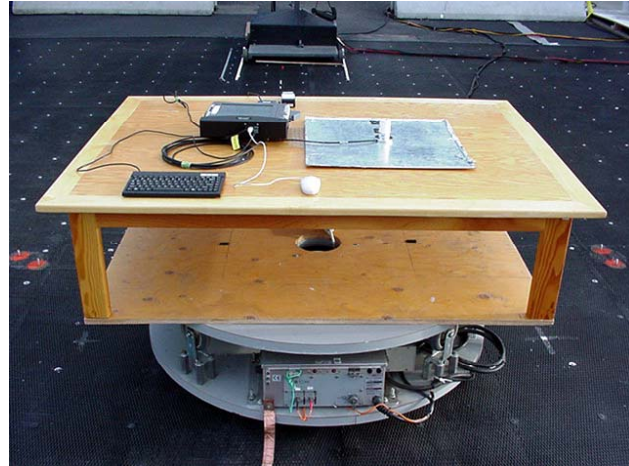

Photograph E.7-3 - Portable - 3 m Bilog setup

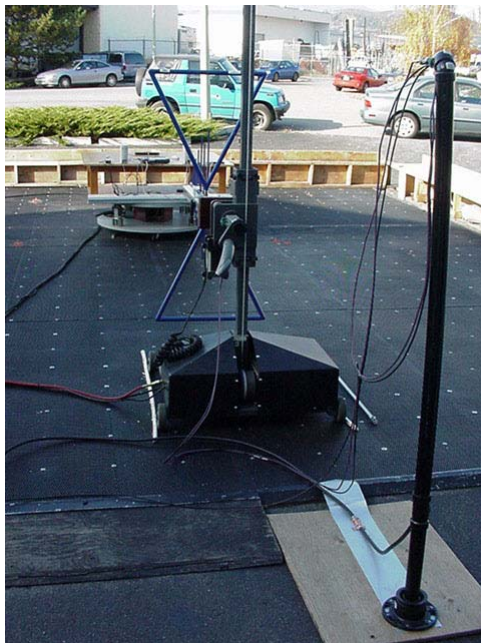

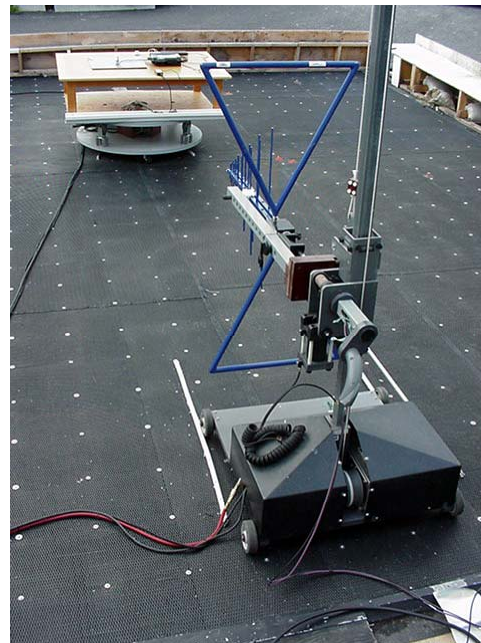

Photograph E.7-4 - Mobile - 3 m Bilog Setup



E.8. DUT OPERATING DESCRIPTION

Measurements were made for the low, mid and high CDMA channels transmitting in the cellular band at maximum power levels, and the DUT configured as described in Section 5 of this report.

Applicant:	Itronix Corporation	FCC ID:	KBCIX325-AC580	IC ID:	1943A-IX325f	
Rugged Tablet PC with Sierra Wireless AirCard 580 Dual-Band CDMA Modem			Model:	IX325-AC580		
2006 Celltech Labs Inc.	This document is not to be reproduced in whole or in part without the prior written permission of Celltech Labs Inc.					Page 28 of 70

	Test Report Serial No.:	100305KBC-T672-E24C	Report Issue No.:	E672C-020106-R0
	Test Date(s):	07Oct05 - 10Dec05	Report Issue Date:	February 1, 2006
	Test Standard(s):	FCC 47 CFR §2, §22H, §24E	Industry Canada RSS-132/133	
	Lab Registration(s):	FCC Registration #714830	Industry Canada Lab File #3874	

E.9. TEST RESULTS

E.9.1. Portable



Project Number: 672
Company: Itronix
Product: IX325 portable w/ AC580

Standard: FCC22.913
Test Start Date: 7-Nov-05
Test End Date: 9-Dec-05

IX325 portable w/ AC580 - face up Carrier Power Levels

Polarity	Distance m	Substitution Antenna Type	Carrier Channel	Frequency MHz	Corrected Field Strength dBuV/m	Detector	Substituted SA Signal Level (uncorrected) dBuV	Power Applied to Antenna dBm	Antenna Gain dBd	ERP Carrier Level		ERP Limit		Margin dB	Pass/Fail
										dBm	Watts	dBm	Watts		
H	3	B_3121C	1013	824.70	120.44	PK	94.15	20.61	-0.84	19.77	0.095	38.45	7.00	18.68	PASS
V	3	B_3121C	1013	824.70	119.34	PK	93.05	21.80	-0.84	20.96	0.125	38.45	7.00	17.49	PASS
H	3	B_3121C	363	835.89	119.40	PK	92.75	20.13	-0.71	19.42	0.088	38.45	7.00	19.03	PASS
V	3	B_3121C	363	835.89	120.40	PK	93.75	22.94	-0.71	22.23	0.167	38.45	7.00	16.22	PASS
H	3	B_3121C	777	848.31	121.26	PK	94.00	21.50	-0.56	20.94	0.124	38.45	7.00	17.51	PASS
V	3	B_3121C	777	848.31	121.61	PK	94.35	23.66	-0.56	23.10	0.204	38.45	7.00	15.35	PASS

Note:
 Dipole Antenna used for substitution

Formulae:
 ERP Level (dBm) = Power Applied to Antenna (dBm) + Antenna Gain (dBd)
 Margin (dB) = Limit (dBm) – Level (dBm)

E.9.2. Mobile



Project Number: 672
Company: Itronix
Product: IX325 mobile w/ AC580

Standard: FCC22.913
Test Start Date: 31-Oct-05
Test End Date: 9-Dec-05

IX325 mobile w/ AC580 Carrier Power Levels

Polarity	Distance m	Substitution Antenna Type	Carrier Channel	Frequency MHz	Corrected Field Strength dBuV/m	Detector	Substituted SA Signal Level (uncorrected) dBuV	Power Applied to Antenna dBm	Antenna Gain dBd	ERP Carrier Level		ERP Limit		Margin dB	Pass/Fail
										dBm	Watts	dBm	Watts		
H	3	B_3121C	1013	824.70	116.59	PK	90.30	16.78	-0.84	15.94	0.039	38.45	7.00	22.51	PASS
V	3	B_3121C	1013	824.70	119.09	PK	92.80	21.54	-0.84	20.70	0.117	38.45	7.00	17.75	PASS
H	3	B_3121C	363	835.89	119.45	PK	92.80	20.19	-0.71	19.48	0.089	38.45	7.00	18.97	PASS
V	3	B_3121C	363	835.89	114.95	PK	88.30	17.59	-0.71	16.88	0.049	38.45	7.00	21.57	PASS
H	3	B_3121C	777	848.31	120.06	PK	92.80	20.33	-0.56	19.77	0.095	38.45	7.00	18.68	PASS
V	3	B_3121C	777	848.31	113.06	PK	85.80	15.33	-0.56	14.77	0.030	38.45	7.00	23.68	PASS

Note:
 Dipole Antenna used for substitution

Formulae:
 ERP Level (dBm) = Power Applied to Antenna (dBm) + Antenna Gain (dBd)
 Margin (dB) = Limit (dBm) – Level (dBm)

Applicant:	Itronix Corporation	FCC ID:	KBCIX325-AC580	IC ID:	1943A-IX325f	
Rugged Tablet PC with Sierra Wireless AirCard 580 Dual-Band CDMA Modem				Model:	IX325-AC580	
2006 Celltech Labs Inc.	This document is not to be reproduced in whole or in part without the prior written permission of Celltech Labs Inc.					Page 29 of 70

	Test Report Serial No.:	100305KBC-T672-E24C	Report Issue No.:	E672C-020106-R0
	Test Date(s):	07Oct05 - 10Dec05	Report Issue Date:	February 1, 2006
	Test Standard(s):	FCC 47 CFR §2, §22H, §24E	Industry Canada RSS-132/133	
	Lab Registration(s):	FCC Registration #714830	Industry Canada Lab File #3874	

E.10. PASS/FAIL

In reference to the results outlined in E.9, the DUT passes the requirements as stated in the reference standards as follows:

FCC 22.913 (a) Maximum ERP. The ERP of mobile transmitters and auxiliary transmitters must not exceed 7 Watts.

A maximum ERP of +23.10 dBm (0.204 Watts) was measured when Channel 777 was transmitting in the portable configuration.

E.11. SIGN-OFF

I attest to the accuracy of the data. All measurements reported herein were performed by me and are correct to the best of my knowledge and belief. I assume full responsibility for the completeness of these measurements.



 Spencer Watson
 Senior Compliance Technologist
 Celltech Labs Inc.

 9Dec05

Date

Applicant:	Itronix Corporation	FCC ID:	KBCIX325-AC580	IC ID:	1943A-IX325f	
Rugged Tablet PC with Sierra Wireless AirCard 580 Dual-Band CDMA Modem			Model:	IX325-AC580		
2006 Celltech Labs Inc.	This document is not to be reproduced in whole or in part without the prior written permission of Celltech Labs Inc.					Page 30 of 70

 Celltech <small>Testing and Engineering Services Lab</small>	Test Report Serial No.:	100305KBC-T672-E24C	Report Issue No.:	E672C-020106-R0
	Test Date(s):	07Oct05 - 10Dec05	Report Issue Date:	February 1, 2006
	Test Standard(s):	FCC 47 CFR §2, §22H, §24E	Industry Canada RSS-132/133	
	Lab Registration(s):	FCC Registration #714830	Industry Canada Lab File #3874	

Appendix F - Radiated Cellular TX Spurious Emissions Measurement

F.1. REFERENCES	
Normative Reference Standard	FCC CFR 47 §22.917(e)
Procedure Reference	ANSI/TIA/EIA-603-C

F.2. LIMITS	
FCC CFR 47 §22.917	<i>(e) Out of Band Emissions. The mean power of emissions must be attenuated below the mean power of the unmodulated carrier (P) on any frequency twice or more than twice the fundamental frequency by: at least 43 + 10 log P dB</i>

F.3. ENVIRONMENTAL CONDITIONS	
Temperature	uncontrolled
Humidity	uncontrolled
Barometric Pressure	uncontrolled

F.4. EQUIPMENT LIST						
RECEIVING EQUIPMENT						
ID	ASSET NUMBER	MANUFACTURER	MODEL	DESCRIPTION	LAST CAL	CAL DUE
1	00072	EMCO	2075	Mini-mast	na	na
2	00073	EMCO	2080	Turn Table	na	na
3	00071	EMCO	2090	Multi-Device Controller	na	na
4	00050	Chase	CBL-6111A	Bilog Antenna	08Feb05	08Feb06
5	00034	ETS	3115	Double Ridged Guide Antenna (Rx)	11Aug05	11Aug06
6	00015	Agilent	E4408B	Spectrum Analyzer	24Jan05	24Jan06
7	00051	HP	8566B	Spectrum Analyzer	12Apr05	12Apr06
8	00047	HP	85685A	Preselector	13Apr05	13Apr06
9	00120	Celltech	n/a	Microwave Cable (RX)	25Mar05	25Mar06
10	00121	Andrew	FSJ4-50B	Microwave Cable (RX)	25Mar05	25Mar06
11	00130	Andrew	FSJ1-50A	Microwave Cable (RX)	25Mar05	25Mar06
12	00115	Miteq	JS4-00102600-35-5A	Low Noise Amplifier	08Jun05	08Jun06
13	00093	Microtronics	HPM50111	High Pass Filter	08Jun05	08Jun06
14	00119	INMAT	18AH-10	10dB attenuator	08Jun05	08Jun06
15	00031	HP	E8285A	CDMA Test set	na	na

Applicant:	Itronix Corporation	FCC ID:	KBCIX325-AC580	IC ID:	1943A-IX325f	
Rugged Tablet PC with Sierra Wireless AirCard 580 Dual-Band CDMA Modem				Model:	IX325-AC580	
2006 Celltech Labs Inc.	This document is not to be reproduced in whole or in part without the prior written permission of Celltech Labs Inc.					Page 31 of 70

	Test Report Serial No.:	100305KBC-T672-E24C	Report Issue No.:	E672C-020106-R0
	Test Date(s):	07Oct05 - 10Dec05	Report Issue Date:	February 1, 2006
	Test Standard(s):	FCC 47 CFR §2, §22H, §24E	Industry Canada RSS-132/133	
	Lab Registration(s):	FCC Registration #714830	Industry Canada Lab File #3874	

ADDITIONAL SUBSTITUTION EQUIPMENT						
ID	ASSET NUMBER	MANUFACTURER	MODEL	DESCRIPTION	LAST CAL	CAL DUE
16	00059	ETS	3121C	Roberts Dipole	04Dec03	04Dec06
17	00035	ETS	3115	Double Ridged Guide Antenna (Tx)	24Mar04	24Mar06
18	00131	Andrew	FSJ1-50A	Microwave Cable (TX)	na	na
19	00127	Andrew	FSJ4-50B	Microwave Cable (TX)	na	na
20	00133	Andrew	FSJ1-50A	Microwave Cable (TX)	na	na
21	00006	R & S	SMR-20	Signal Generator	12Apr05	12Apr06
22	00110	Gigatronics	8652A	Power Meter	16Apr05	16Apr06
23	00012	Gigatronics	80701A	Power Sensor	12Sep05	12Sep06
24	00014	Gigatronics	80701A	Power Sensor	07Sep05	07Sep06
25	00102	Pasternack	PE7015-3110	30 dB attenuator	na*	na*
26	00078	Pasternack	PE2214-20	Directional Coupler	na*	na*
27	00142	HP	8491A	20 dB attenuator	na*	na*

* Attenuation offset in power meter setup

F.5. MEASUREMENT EQUIPMENT SETUP						
MEASUREMENT EQUIPMENT CONNECTIONS	The measurement equipment was connected as shown in F.6. A number of measurement equipment configurations were used to cover the applicable frequency ranges. The configurations for each range are as follows:					
	Frequency Range	LNA Asset #	Filter/Attenuator Asset #	Rx Antenna Asset #	Tx Antenna Asset #	
	30 MHz – 1 GHz	none	none	00050	00059	
	1 GHz – 2 GHz	none	none	00034	00035	
	2 GHz – 3 GHz	00115	00119	00034	00035	
3 GHz – 10 GHz	00115	00093	00034	00035		
MEASUREMENT EQUIPMENT SETTINGS	The spectrum analyzer was set to the following settings:					
	Frequency Range	RBW		VBW		Detector
	MHz	kHz		kHz		
	800 MHz – 10 GHz	100*		100*		Peak

*Field strength measurements were made with a worse case RBW and VBW of 1 MHz for frequency bands above 1 GHz when adequate margins were attained.

Applicant:	Itronix Corporation	FCC ID:	KBCIX325-AC580	IC ID:	1943A-IX325f	
Rugged Tablet PC with Sierra Wireless AirCard 580 Dual-Band CDMA Modem				Model:	IX325-AC580	
2006 Celltech Labs Inc.	This document is not to be reproduced in whole or in part without the prior written permission of Celltech Labs Inc.					Page 32 of 70

F.6. SETUP DRAWING

Figure F.6-1 - Field Strength Setup Drawing

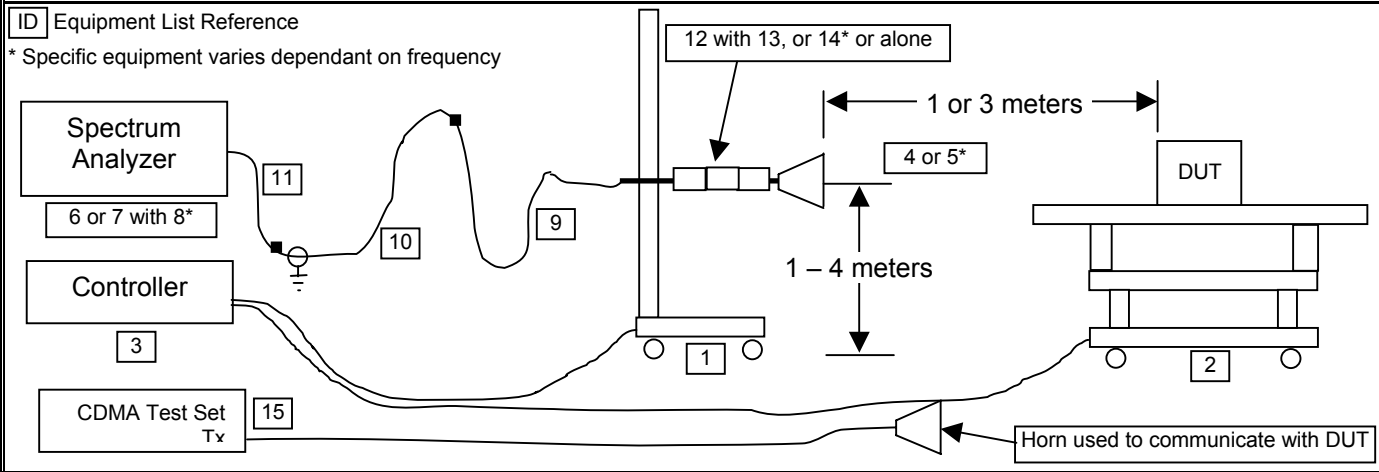
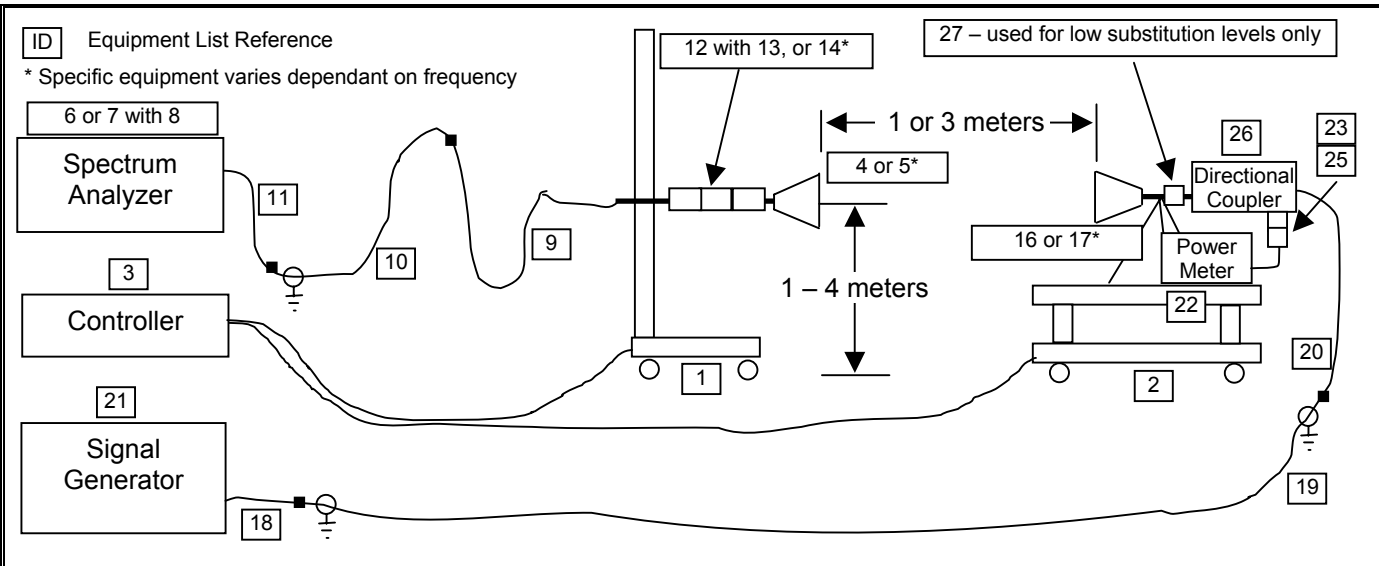

Figure F.6-2 - Signal Substitution Setup Drawing



Test Report Serial No.:	100305KBC-T672-E24C	Report Issue No.:	E672C-020106-R0
Test Date(s):	07Oct05 - 10Dec05	Report Issue Date:	February 1, 2006
Test Standard(s):	FCC 47 CFR §2, §22H, §24E	Industry Canada RSS-132/133	
Lab Registration(s):	FCC Registration #714830	Industry Canada Lab File #3874	

F.7. SETUP PHOTOGRAPHS

Photograph F.7-1 - Portable DUT Configuration

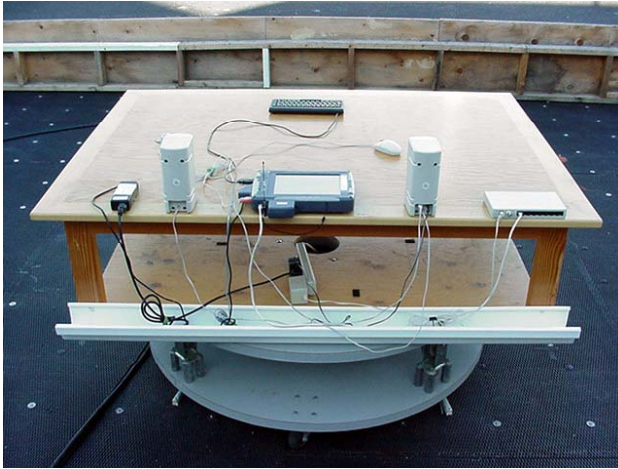

Photograph F.7-2 - Mobile DUT Configuration

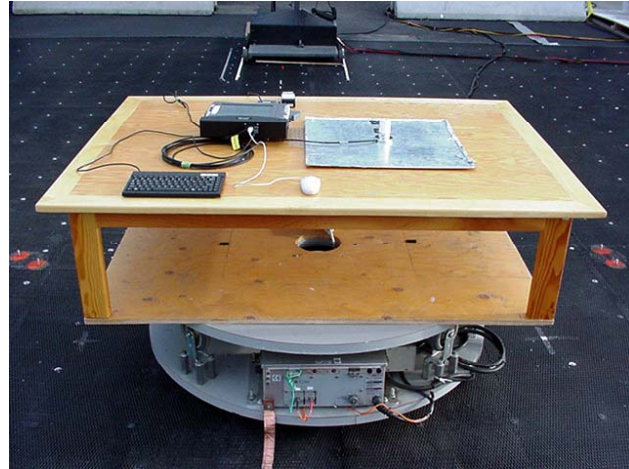

Photograph F.7-3 - Portable - 1 m Horn setup



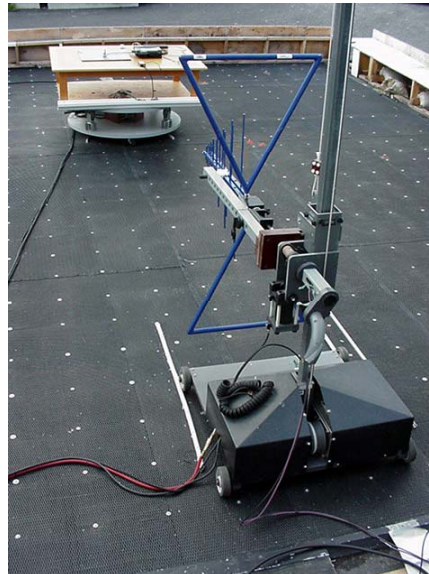

Photograph F.7-4 - Mobile - 3 m Bilog Setup



F.8. DUT OPERATING DESCRIPTION

Measurements were made for the low, mid, and high CDMA channels transmitting in the cellular band at maximum power levels as described in Section 5 of this report. The conducted transmit spurious emissions supplementary measurements are described in Appendix C.

Applicant:	Itronix Corporation	FCC ID:	KBCIX325-AC580	IC ID:	1943A-IX325f	
Rugged Tablet PC with Sierra Wireless AirCard 580 Dual-Band CDMA Modem			Model:	IX325-AC580		
2006 Celltech Labs Inc.		This document is not to be reproduced in whole or in part without the prior written permission of Celltech Labs Inc.				Page 34 of 70

	Test Report Serial No.:	100305KBC-T672-E24C	Report Issue No.:	E672C-020106-R0
	Test Date(s):	07Oct05 - 10Dec05	Report Issue Date:	February 1, 2006
	Test Standard(s):	FCC 47 CFR §2, §22H, §24E	Industry Canada RSS-132/133	
	Lab Registration(s):	FCC Registration #714830	Industry Canada Lab File #3874	

F.9. TEST RESULTS

F.9.1. Spurious Emissions - Portable

Channel 1013



Project Number: 672
Company: Itronix
Product: IX325 portable w/ AC580

Standard: FCC22.917
Test Start Date: 7-Oct-05
Test End Date: 7-Oct-05

IX325 portable w/ AC580 Face up - Vpol Antenna

Polarity	Distance m	Substitution Antenna Type	Carrier Channel	Frequency	Corrected Field Strength	Detector	Substituted SA Signal Level (uncorrected)	Power Applied to Antenna	Antenna Gain	ERP Emission Level	Limit	Margin	Pass/Fail
				MHz	dBuV/m		dBuV	dBm	dB	dBm	dBm or dBuV/m*	dB	
H	3	Horn SN6276	CH1013	1649.00	66.42	PK*	34.80	-44.36	6.44	-37.92	-13.00	24.92	PASS
H	3	none	CH1013	1649.00	55.12	AV					84.4*	29.3*	PASS*
H	3	Horn SN6276	CH1013	2474.00	68.08	PK*	56.00	-39.65	7.71	-31.94	-13.00	18.94	PASS
H	3	none	CH1013	2474.00	53.98	AV					84.4*	30.4*	PASS*
H	3	none	CH1013	3298.14	43.51	PK*					84.4*	40.9*	PASS*
H	3	none	CH1013	4124.67	58.36	PK*					84.4*	26.0*	PASS*
H	3	none	CH1013	4949.52	47.41	PK*					84.4*	37.0*	PASS*
H	3	none	CH1013	5772.00	44.22	PK*					84.4*	40.1*	PASS*
H	3	none	CH1013	6596.00	50.47	PK*					84.4*	33.9*	PASS*
H	3	none	CH1013	7422.30	44.80	PK*					84.4*	39.6*	PASS*
H	3	none	CH1013	8247.00	45.22	PK*					84.4*	39.2*	PASS*
V	3	none	CH1013	1073.00	64.75	PK*					84.4*	19.6*	PASS*
V	3	Horn SN6276	CH1013	1649.00	67.72	PK*	36.10	-43.95	6.44	-37.51	-13.00	24.51	PASS
V	3	none	CH1013	1649.00	56.32	AV					84.4*	28.1*	PASS*
V	3	Horn SN6276	CH1013	2474.91	64.68	PK*	52.60	-41.27	7.71	-33.56	-13.00	20.56	PASS
V	3	none	CH1013	2474.07	50.88	AV					84.4*	33.5*	PASS*
V	3	none	CH1013	3298.82	45.31	PK*					84.4*	39.1*	PASS*
V	3	none	CH1013	4125.05	54.66	PK*					84.4*	29.7*	PASS*
V	3	none	CH1013	4949.89	52.31	PK*					84.4*	32.1*	PASS*
V	3	none	CH1013	5285.32	70.29	PK					84.4*	14.1*	PASS*
V	3	none	CH1013	5284.95	53.49	AV					84.4*	30.9*	PASS*
V	3	none	CH1013	5772.12	48.22	PK*					84.4*	36.1*	PASS*
V	3	none	CH1013	6596.00	51.37	PK*					84.4*	33.0*	PASS*
V	3	Horn SN6276	CH1013	7422.30	44.10	PK*	33.50	-68.67	9.34	-59.33	-13.00	46.33	PASS
V	3	none	CH1013	8247.00	46.02	PK*					84.4*	38.4*	PASS*

PK* - measurement made with a peak detector and applied to an average limit.

Pass* - Margin and Pass/Fail based on measured field strengths applied against a theoretical field strength limit.

BOLD - carrier harmonic frequencies

Note:

The emissions reported above represent the highest emissions or noise floor measured within the frequency band of 30MHz and the 10th harmonic of the carrier with peak field strengths within 20 dB of the theoretical limit. All other emissions attributed to the EUT had field strengths greater than 20 dB below the theoretical limit and substitutions were not made.

Formulae:

ERP Emission Level (dBm) = Power applied to antenna (dBm) + Antenna Gain (dBd)

Margin (dB) = Limit (dBm) – ERP Emission Level (dBm) or Theoretical Limit (dBuV/m) – Corrected Field Strength (dBuV/m)

Theoretical Limit (V/m) = SQRT(30 * P / r²) where P is the total transmitted power limit (W), r is measurement distance (m)

Applicant:	Itronix Corporation	FCC ID:	KBCIX325-AC580	IC ID:	1943A-IX325f	
Rugged Tablet PC with Sierra Wireless AirCard 580 Dual-Band CDMA Modem			Model:	IX325-AC580		
2006 Celltech Labs Inc.	This document is not to be reproduced in whole or in part without the prior written permission of Celltech Labs Inc.					Page 35 of 70

 Celltech Testing and Engineering Services Lab	Test Report Serial No.:	100305KBC-T672-E24C	Report Issue No.:	E672C-020106-R0
	Test Date(s):	07Oct05 - 10Dec05	Report Issue Date:	February 1, 2006
	Test Standard(s):	FCC 47 CFR §2, §22H, §24E	Industry Canada RSS-132/133	
	Lab Registration(s):	FCC Registration #714830	Industry Canada Lab File #3874	

Channel 363

	Project Number:	672	Standard:	FCC22.917
	Company:	Itronix	Test Start Date:	7-Oct-05
	Product:	IX325 portable w/ AC580	Test End Date:	7-Oct-05

IX325 portable w/ AC580 Face up - Vpol Antenna

Polarity	Distance m	Substitution Antenna Type	Carrier Channel	Frequency	Corrected Field Strength	Detector	Substituted SA Signal Level (uncorrected)	Power Applied to Antenna	Antenna Gain	ERP Emission Level	Limit	Margin	Pass/Fail
				MHz	dBuV/m		dBuV	dBm	dBi	dBm	dBm or dBuV/m*	dB	
H	3	none	CH363	1671.00	47.23	PK*					84.4*	37.1*	PASS*
H	3	Horn SN6276	CH363	2506.86	79.89	PK	67.70	-28.12	7.76	-20.36	-13.00	7.36	PASS
H	3	none	CH363	2507.62	66.30	AV					84.4*	18.1*	PASS*
H	3	none	CH363	3343.18	45.06	PK*					84.4*	39.3*	PASS*
H	3	none	CH363	4178.14	59.88	PK*					84.4*	24.5*	PASS*
H	3	none	CH363	5014.23	46.87	PK*					84.4*	37.5*	PASS*
H	3	none	CH363	5850.36	50.99	PK*					84.4*	33.4*	PASS*
H	3	none	CH363	6686.00	50.72	PK*					84.4*	33.6*	PASS*
H	3	none	CH363	7520.00	46.60	PK*					84.4*	37.8*	PASS*
H	3	none	CH363	8350.00	46.51	PK*					84.4*	37.9*	PASS*
V	3	none	CH363	1671.00	48.63	PK*					84.4*	35.7*	PASS*
V	3	Horn SN6276	CH363	2508.42	73.30	PK	61.10	-33.95	7.76	-26.19	-13.00	13.19	PASS
V	3	none	CH363	2507.66	60.00	AV					84.4*	24.4*	PASS*
V	3	none	CH363	3342.00	38.06	PK*					84.4*	46.3*	PASS*
V	3	none	CH363	4178.00	41.78	PK*					84.4*	42.6*	PASS*
V	3	none	CH363	5014.00	42.47	PK*					84.4*	41.9*	PASS*
V	3	none	CH363	5850.00	49.89	PK*					84.4*	34.5*	PASS*
V	3	none	CH363	6686.00	50.52	PK*					84.4*	33.8*	PASS*
V	3	none	CH363	7520.00	46.10	PK*					84.4*	38.3*	PASS*
V	3	none	CH363	8350.00	46.11	PK*					84.4*	38.3*	PASS*

PK* - measurement made with a peak detector and applied to an average limit.
 Pass* - Margin and Pass/Fail based on measured field strengths applied against a theoretical field strength limit.
BOLD - carrier harmonic frequencies

Note:
 The emissions reported above represent the highest emissions or noise floor measured within the frequency band of 30MHz and the 10th harmonic of the carrier with peak field strengths within 20 dB of the theoretical limit. All other emissions attributed to the EUT had field strengths greater than 20 dB below the theoretical limit and substitutions were not made.

Formulae:
 ERP Emission Level (dBm) = Power applied to antenna (dBm) + Antenna Gain (dBd)
 Margin (dB) = Limit (dBm) – ERP Emission Level (dBm) or Theoretical Limit (dBuV/m) – Corrected Field Strength (dBuV/m)
 Theoretical Limit (V/m) = SQRT(30 * P / r²) where P is the total transmitted power limit (W), r is measurement distance (m)

Applicant:	Itronix Corporation	FCC ID:	KBCIX325-AC580	IC ID:	1943A-IX325f	
Rugged Tablet PC with Sierra Wireless AirCard 580 Dual-Band CDMA Modem				Model:	IX325-AC580	
2006 Celltech Labs Inc.	This document is not to be reproduced in whole or in part without the prior written permission of Celltech Labs Inc.					Page 36 of 70

 Celltech Testing and Engineering Services Lab	Test Report Serial No.:	100305KBC-T672-E24C	Report Issue No.:	E672C-020106-R0
	Test Date(s):	07Oct05 - 10Dec05	Report Issue Date:	February 1, 2006
	Test Standard(s):	FCC 47 CFR §2, §22H, §24E	Industry Canada RSS-132/133	
	Lab Registration(s):	FCC Registration #714830	Industry Canada Lab File #3874	

Channel 777

 Celltech Testing and Engineering Services Lab	Project Number:	672	Standard:	FCC22.917
	Company:	Itronix	Test Start Date:	7-Oct-05
	Product:	IX325 portable w/ AC580	Test End Date:	7-Oct-05

IX325 portable w/ AC580 Face up - Vpol Antenna

Polarity	Distance m	Substitution Antenna Type	Carrier Channel	Frequency	Corrected Field Strength	Detector	Substituted SA Signal Level (uncorrected)	Power Applied to Antenna	Antenna Gain	ERP Emission Level	Limit	Margin	Pass/Fail
				MHz	dBuV/m		dBuV	dBm	dBi	dBm	dBm or dBuV/m*	dB	
H	3	none	CH777	1696.66	49.72	PK*					84.4*	34.7*	PASS*
H	3	Horn SN6276	CH777	2545.66	77.60	PK*	65.20	-30.49	7.74	-22.75	-13.00	9.75	PASS
H	3	none	CH777	2544.88	62.90	AV					84.4*	21.5*	PASS*
H	3	none	CH777	3393.71	49.02	PK*					84.4*	35.4*	PASS*
H	3	none	CH777	4240.44	57.19	PK*					84.4*	27.2*	PASS*
H	3	none	CH777	5091.40	48.09	PK*					84.4*	36.3*	PASS*
H	3	none	CH777	5935.63	50.17	PK*					84.4*	34.2*	PASS*
H	3	none	CH777	6784.38	51.96	PK*					84.4*	32.4*	PASS*
H	3	none	CH777	7633.13	46.30	PK*					84.4*	38.1*	PASS*
H	3	none	CH777	8481.88	46.54	PK*					84.4*	37.8*	PASS*
V	3	none	CH777	1696.00	47.81	PK*					84.4*	36.6*	PASS*
V	3	Horn SN6276	CH777	2549.50	69.52	PK*	57.10	-37.81	7.74	-30.07	-13.00	17.07	PASS
V	3	none	CH777	2550.36	53.82	AV					84.4*	30.5*	PASS*
V	3	none	CH777	3392.27	53.02	PK*					84.4*	31.4*	PASS*
V	3	none	CH777	4240.19	60.89	PK*					84.4*	23.5*	PASS*
V	3	none	CH777	5091.18	57.69	PK*					84.4*	26.7*	PASS*
V	3	none	CH777	5935.63	50.07	PK*					84.4*	34.3*	PASS*
V	3	none	CH777	6784.38	51.16	PK*					84.4*	33.2*	PASS*
V	3	none	CH777	7633.13	45.70	PK*					84.4*	38.7*	PASS*
V	3	none	CH777	8481.88	46.64	PK*					84.4*	37.7*	PASS*

PK* - measurement made with a peak detector and applied to an average limit.
 Pass* - Margin and Pass/Fail based on measured field strengths applied against a theoretical field strength limit.
BOLD - carrier harmonic frequencies

Note:
 The emissions reported above represent the highest emissions or noise floor measured within the frequency band of 30MHz and the 10th harmonic of the carrier with peak field strengths within 20 dB of the theoretical limit. All other emissions attributed to the EUT had field strengths greater than 20 dB below the theoretical limit and substitutions were not made.

Formulae:
 ERP Emission Level (dBm) = Power applied to antenna (dBm) + Antenna Gain (dBd)
 Margin (dB) = Limit (dBm) – ERP Emission Level (dBm) or Theoretical Limit (dBuV/m) – Corrected Field Strength (dBuV/m)
 Theoretical Limit (V/m) = SQRT(30 * P / r²) where P is the total transmitted power limit (W), r is measurement distance (m)

Applicant:	Itronix Corporation	FCC ID:	KBCIX325-AC580	IC ID:	1943A-IX325f	
Rugged Tablet PC with Sierra Wireless AirCard 580 Dual-Band CDMA Modem				Model:	IX325-AC580	
2006 Celltech Labs Inc.	This document is not to be reproduced in whole or in part without the prior written permission of Celltech Labs Inc.					Page 37 of 70

 Celltech Testing and Engineering Services Lab	Test Report Serial No.:	100305KBC-T672-E24C	Report Issue No.:	E672C-020106-R0
	Test Date(s):	07Oct05 - 10Dec05	Report Issue Date:	February 1, 2006
	Test Standard(s):	FCC 47 CFR §2, §22H, §24E	Industry Canada RSS-132/133	
	Lab Registration(s):	FCC Registration #714830	Industry Canada Lab File #3874	

F.9.2. Spurious Emissions - Mobile

Channel 1013



Project Number: 672
Company: Itronix
Product: IX325 mobile w/ AC580

Standard: FCC22.917
Test Start Date: 31-Oct-05
Test End Date: 31-Oct-05

IX325 mobile w/ AC580

Polarity	Distance m	Substitution Antenna Type	Carrier Channel	Frequency	Corrected Field Strength	Detector	Substituted SA Signal Level (uncorrected)	Power Applied to Antenna	Antenna Gain	ERP Emission Level	Limit	Margin	Pass/Fail
				MHz	dBuV/m		dBuV	dBm	dBi	dBm	dBm or dBuV/m*	dB	
H	3	none	CH1013	162.51	75.00	PK*					84.4*	09.4*	PASS*
H	3	none	CH1013	162.56	58.30	QP					84.4*	26.1*	PASS*
H	3	none	CH1013	1649.83	70.12	PK					84.4*	14.2*	PASS*
H	3	none	CH1013	1649.83	54.92	AV					84.4*	29.4*	PASS*
H	3	none	CH1013	2474.00	36.72	PK*					84.4*	47.6*	PASS*
H	3	none	CH1013	3298.67	38.81	PK*					84.4*	45.6*	PASS*
H	3	none	CH1013	4124.48	53.46	PK*					84.4*	30.9*	PASS*
H	3	none	CH1013	4949.29	47.91	PK*					84.4*	36.5*	PASS*
H	3	none	CH1013	6595.67	50.86	PK*					84.4*	33.5*	PASS*
H	3	none	CH1013	7421.67	52.81	PK*					84.4*	31.6*	PASS*
H	3	none	CH1013	8245.33	54.67	PK*					84.4*	29.7*	PASS*
V	3	none	CH1013	1649.00	66.62	PK					84.4*	17.8*	PASS*
V	3	none	CH1013	1649.00	55.02	AV					84.4*	29.4*	PASS*
V	3	none	CH1013	2474.00	44.52	PK*					84.4*	39.8*	PASS*
V	3	none	CH1013	3298.29	43.71	PK*					84.4*	40.7*	PASS*
V	3	none	CH1013	3298.73	31.61	AV					84.4*	52.8*	PASS*
V	3	none	CH1013	4124.65	56.16	PK*					84.4*	28.2*	PASS*
V	3	none	CH1013	4947.18	49.10	PK*					84.4*	35.3*	PASS*
V	3	none	CH1013	6595.67	50.86	PK*					84.4*	33.5*	PASS*
V	3	none	CH1013	7421.67	52.51	PK*					84.4*	31.9*	PASS*
V	3	none	CH1013	8245.33	55.87	PK*					84.4*	28.5*	PASS*

PK* - measurement made with a peak detector and applied to an average limit.
 Pass* - Margin and Pass/Fail based on measured field strengths applied against a theoretical field strength limit.
BOLD - carrier harmonic frequencies

Note:
 The emissions reported above represent the highest emissions or noise floor measured within the frequency band of 30MHz and the 10th harmonic of the carrier with peak field strengths within 20 dB of the theoretical limit. All other emissions attributed to the EUT had field strengths greater than 20 dB below the theoretical limit and substitutions were not made.

Formulae:
 ERP Emission Level (dBm) = Power applied to antenna (dBm) + Antenna Gain (dBd)
 Margin (dB) = Limit (dBm) – ERP Emission Level (dBm) or Theoretical Limit (dBuV/m) – Corrected Field Strength (dBuV/m)
 Theoretical Limit (V/m) = SQRT(30 * P / r²) where P is the total transmitted power limit (W), r is measurement distance (m)

Applicant:	Itronix Corporation	FCC ID:	KBCIX325-AC580	IC ID:	1943A-IX325f	
Rugged Tablet PC with Sierra Wireless AirCard 580 Dual-Band CDMA Modem				Model:	IX325-AC580	
2006 Celltech Labs Inc.	This document is not to be reproduced in whole or in part without the prior written permission of Celltech Labs Inc.					Page 38 of 70



Test Report Serial No.:	100305KBC-T672-E24C	Report Issue No.:	E672C-020106-R0
Test Date(s):	07Oct05 - 10Dec05	Report Issue Date:	February 1, 2006
Test Standard(s):	FCC 47 CFR §2, §22H, §24E	Industry Canada RSS-132/133	
Lab Registration(s):	FCC Registration #714830	Industry Canada Lab File #3874	

Channel 363



Project Number: 672
Company: Itronix
Product: IX325 mobile w/ AC580

Standard: FCC22.917
Test Start Date: 31-Oct-05
Test End Date: 31-Oct-05

IX325 mobile w/ AC580

Polarity	Distance m	Substitution Antenna Type	Carrier Channel	Frequency	Corrected Field Strength	Detector	Substituted SA Signal Level (uncorrected)	Power Applied to Antenna	Antenna Gain	ERP Emission Level	Limit	Margin	Pass/Fail
				MHz	dBuV/m		dBuV	dBm	dBi	dBm	dBm or dBuV/m*	dB	
H	3	none	CH363	1671.00	67.03	PK					84.4*	17.3*	PASS*
H	3	none	CH363	1671.00	55.33	AV					84.4*	29.0*	PASS*
H	3	none	CH363	2507.00	40.73	PK*					84.4*	43.6*	PASS*
H	3	none	CH363	3343.00	38.86	PK*					84.4*	45.5*	PASS*
H	3	none	CH363	4180.66	50.49	PK*					84.4*	33.9*	PASS*
H	3	none	CH363	5016.61	46.88	PK*					84.4*	37.5*	PASS*
H	3	none	CH363	5849.32	50.09	PK*					84.4*	34.3*	PASS*
H	3	none	CH363	6686.67	50.82	PK*					84.4*	33.6*	PASS*
H	3	none	CH363	7522.00	52.67	PK*					84.4*	31.7*	PASS*
H	3	none	CH363	8357.33	54.33	PK*					84.4*	30.0*	PASS*
V	3	none	CH363	1671.00	66.73	PK*					84.4*	17.6*	PASS*
V	3	none	CH363	2508.51	46.54	PK*					84.4*	37.8*	PASS*
V	3	none	CH363	3343.00	47.96	PK*					84.4*	36.4*	PASS*
V	3	none	CH363	4180.61	55.99	PK*					84.4*	28.4*	PASS*
V	3	none	CH363	5013.75	53.07	PK*					84.4*	31.3*	PASS*
V	3	none	CH363	5849.00	50.09	PK*					84.4*	34.3*	PASS*
V	3	none	CH363	6686.87	51.31	PK*					84.4*	33.1*	PASS*
V	3	none	CH363	7522.00	53.27	PK*					84.4*	31.1*	PASS*
V	3	none	CH363	8357.33	54.63	PK*					84.4*	29.7*	PASS*

PK* - measurement made with a peak detector and applied to an average limit.
 Pass* - Margin and Pass/Fail based on measured field strengths applied against a theoretical field strength limit.
BOLD - carrier harmonic frequencies

Note:
 The emissions reported above represent the highest emissions or noise floor measured within the frequency band of 30MHz and the 10th harmonic of the carrier with peak field strengths within 20 dB of the theoretical limit. All other emissions attributed to the EUT had field strengths greater than 20 dB below the theoretical limit and substitutions were not made.

Formulae:
 ERP Emission Level (dBm) = Power applied to antenna (dBm) + Antenna Gain (dBd)
 Margin (dB) = Limit (dBm) – ERP Emission Level (dBm) or Theoretical Limit (dBuV/m) – Corrected Field Strength (dBuV/m)
 Theoretical Limit (V/m) = SQRT(30 * P / r²) where P is the total transmitted power limit (W), r is measurement distance (m)

Applicant:	Itronix Corporation	FCC ID:	KBCIX325-AC580	IC ID:	1943A-IX325f	
Rugged Tablet PC with Sierra Wireless AirCard 580 Dual-Band CDMA Modem				Model:	IX325-AC580	
2006 Celltech Labs Inc.	This document is not to be reproduced in whole or in part without the prior written permission of Celltech Labs Inc.					Page 39 of 70



Test Report Serial No.:	100305KBC-T672-E24C	Report Issue No.:	E672C-020106-R0
Test Date(s):	07Oct05 - 10Dec05	Report Issue Date:	February 1, 2006
Test Standard(s):	FCC 47 CFR §2, §22H, §24E	Industry Canada RSS-132/133	
Lab Registration(s):	FCC Registration #714830	Industry Canada Lab File #3874	

Channel 777



Project Number: 672
Company: Itronix
Product: IX325 mobile w/ AC580

Standard: FCC22.917
Test Start Date: 31-Oct-05
Test End Date: 31-Oct-05

IX325 mobile w/ AC580

Polarity	Distance m	Substitution Antenna Type	Carrier Channel	Frequency	Corrected Field Strength	Detector	Substituted SA Signal Level (uncorrected)	Power Applied to Antenna	Antenna Gain	ERP Emission Level	Limit	Margin	Pass/Fail
				MHz	dBuV/m		dBuV	dBm	dBi	dBm	dBm or dBuV/m*	dB	
H	3	none	CH777	1696.00	67.21	PK					84.4*	17.2*	PASS*
H	3	none	CH777	1696.00	55.61	AV					84.4*	28.8*	PASS*
H	3	none	CH777	2544.00	41.23	PK*					84.4*	43.1*	PASS*
H	3	none	CH777	3182.00	37.93	PK*					84.4*	46.4*	PASS*
H	3	none	CH777	3394.19	45.02	PK*					84.4*	39.3*	PASS*
H	3	none	CH777	4240.37	52.79	PK*					84.4*	31.6*	PASS*
H	3	none	CH777	5091.52	49.70	PK*					84.4*	34.7*	PASS*
H	3	none	CH777	5937.67	50.38	PK*					84.4*	34.0*	PASS*
H	3	none	CH777	6784.67	51.96	PK*					84.4*	32.4*	PASS*
H	3	none	CH777	7634.00	53.37	PK*					84.4*	31.0*	PASS*
H	3	none	CH777	8481.00	54.56	PK*					84.4*	29.8*	PASS*
V	3	none	CH777	1696.00	67.61	PK					84.4*	16.8*	PASS*
V	3	none	CH777	1696.00	55.61	AV					84.4*	28.8*	PASS*
V	3	none	CH777	2544.07	49.83	PK*					84.4*	34.5*	PASS*
V	3	none	CH777	3392.00	50.52	PK*					84.4*	33.9*	PASS*
V	3	none	CH777	4241.33	59.69	PK*					84.4*	24.7*	PASS*
V	3	none	CH777	5088.33	57.16	PK*					84.4*	27.2*	PASS*
V	3	none	CH777	5937.67	50.08	PK*					84.4*	34.3*	PASS*
V	3	none	CH777	6784.67	51.36	PK*					84.4*	33.0*	PASS*
V	3	none	CH777	7634.00	54.57	PK*					84.4*	29.8*	PASS*
V	3	none	CH777	8481.00	54.86	PK*					84.4*	29.5*	PASS*

PK* - measurement made with a peak detector and applied to an average limit.
 Pass* - Margin and Pass/Fail based on measured field strengths applied against a theoretical field strength limit.
BOLD - carrier harmonic frequencies

Note:
 The emissions reported above represent the highest emissions or noise floor measured within the frequency band of 30MHz and the 10th harmonic of the carrier with peak field strengths within 20 dB of the theoretical limit. All other emissions attributed to the EUT had field strengths greater than 20 dB below the theoretical limit and substitutions were not made.

Formulae:
 ERP Emission Level (dBm) = Power applied to antenna (dBm) + Antenna Gain (dBd)
 Margin (dB) = Limit (dBm) – ERP Emission Level (dBm) or Theoretical Limit (dBuV/m) – Corrected Field Strength (dBuV/m)
 Theoretical Limit (V/m) = SQRT(30 * P / r²) where P is the total transmitted power limit (W), r is measurement distance (m)

Applicant:	Itronix Corporation	FCC ID:	KBCIX325-AC580	IC ID:	1943A-IX325f	
Rugged Tablet PC with Sierra Wireless AirCard 580 Dual-Band CDMA Modem				Model:	IX325-AC580	
2006 Celltech Labs Inc.	This document is not to be reproduced in whole or in part without the prior written permission of Celltech Labs Inc.					Page 40 of 70

	Test Report Serial No.:	100305KBC-T672-E24C	Report Issue No.:	E672C-020106-R0
	Test Date(s):	07Oct05 - 10Dec05	Report Issue Date:	February 1, 2006
	Test Standard(s):	FCC 47 CFR §2, §22H, §24E	Industry Canada RSS-132/133	
	Lab Registration(s):	FCC Registration #714830	Industry Canada Lab File #3874	

F.10. PASS/FAIL

In reference to the results outlined in F.9, the DUT passes the requirements as stated in the reference standards.

(e) Out of Band Emissions. The mean power of emissions must be attenuated below the mean power of the unmodulated carrier (P) on any frequency twice or more than twice the fundamental frequency by: at least 43 + 10 log P dB

The results set forth in this section meet the requirement with a margin of at least 7.36 dB

F.11. SIGN-OFF

I attest to the accuracy of the data. All measurements reported herein were performed by me and are correct to the best of my knowledge and belief. I assume full responsibility for the completeness of these measurements.



for Russell Pipe
Senior Compliance Technologist
Celltech Labs Inc.

31Oct05

Date

Applicant:	Itronix Corporation	FCC ID:	KBCIX325-AC580	IC ID:	1943A-IX325f	
Rugged Tablet PC with Sierra Wireless AirCard 580 Dual-Band CDMA Modem				Model:	IX325-AC580	
2006 Celltech Labs Inc.		This document is not to be reproduced in whole or in part without the prior written permission of Celltech Labs Inc.				Page 41 of 70

	Test Report Serial No.:	100305KBC-T672-E24C	Report Issue No.:	E672C-020106-R0
	Test Date(s):	07Oct05 - 10Dec05	Report Issue Date:	February 1, 2006
	Test Standard(s):	FCC 47 CFR §2, §22H, §24E	Industry Canada RSS-132/133	
	Lab Registration(s):	FCC Registration #714830	Industry Canada Lab File #3874	

Appendix G - PCS Band Conducted TX RF Output Power Measurement

G.1. REFERENCES	
Normative Reference Standard	FCC CFR 47 §2.1046
Procedure Reference	FCC CFR 47 §2.1046

G.2. LIMITS	
FCC CFR 47 §2.1046 (a)	For transmitters other than single sideband, independent sideband and controlled carrier radiotelephone, power output shall be measured at the RF output terminals when the transmitter is adjusted in accordance with the tune-up procedures to give the values of current and voltage on the circuit elements specified in §2.1033(c) (8).
*EIRP limits are specified in Appendix J.	

G.3. ENVIRONMENTAL CONDITIONS	
Temperature	25 ± 5 °C
Humidity	35 ± 5 %RH
Barometric Pressure	uncontrolled

G.4. EQUIPMENT LIST					
ASSET NUMBER	MANUFACTURER	MODEL	DESCRIPTION	LAST CAL	CAL DUE
00110	Gigatronics	8652A	Power Meter	16Apr05	16Apr06
00012	Gigatronics	80701A	Power Sensor	12Sep05	12Sep06
00102	Pasternack	PE7014-30	30dB attenuator	na	na*

*Attenuator offset in power meter

	Test Report Serial No.:	100305KBC-T672-E24C	Report Issue No.:	E672C-020106-R0
	Test Date(s):	07Oct05 - 10Dec05	Report Issue Date:	February 1, 2006
	Test Standard(s):	FCC 47 CFR §2, §22H, §24E	Industry Canada RSS-132/133	
	Lab Registration(s):	FCC Registration #714830	Industry Canada Lab File #3874	

G.5. MEASUREMENT EQUIPMENT SETUP

Measurement Equipment Connections	The equipment was connected as shown in the setup drawing in B.6.
Measurement Equipment Settings	Power Meter Settings: Mode - MAP Frequency compensation set for carrier frequency Offset set appropriately to compensate for attenuator
Measurement Procedure	The RF conducted power levels were measured at the DUT antenna connector port using a Gigatronics 8652A Universal Power Meter in mean average power mode. An offset was entered into the power meter to correct for the loss of the attenuator installed between the output port and the power sensor input. The DUT test software was used to set it to transmit in the CDMA "always up" power control mode.

G.6. SETUP DRAWING

Figure G.6-1 - Setup Drawing

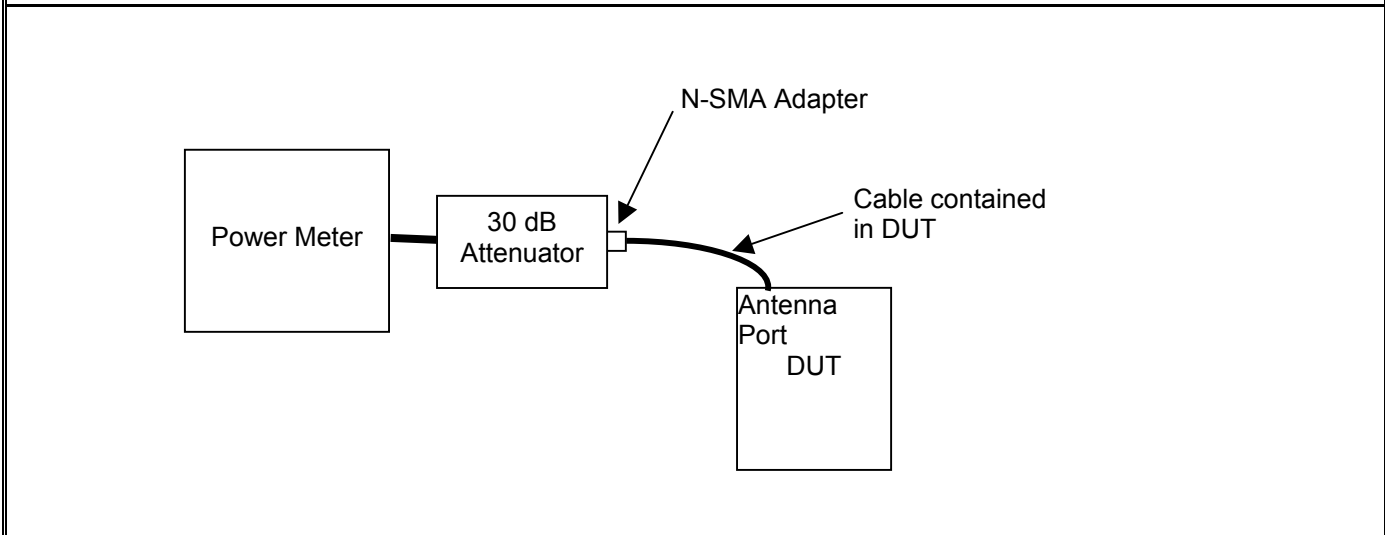

G.7. DUT OPERATING DESCRIPTION

Power measurements were made for each of the three PCS test channels (Channel 25, 600 & 1175), with the AirCard 580 modem set appropriately as described in section 5.7.

	Test Report Serial No.:	100305KBC-T672-E24C	Report Issue No.:	E672C-020106-R0
	Test Date(s):	07Oct05 - 10Dec05	Report Issue Date:	February 1, 2006
	Test Standard(s):	FCC 47 CFR §2, §22H, §24E	Industry Canada RSS-132/133	
	Lab Registration(s):	FCC Registration #714830	Industry Canada Lab File #3874	

G.8. TEST RESULTS

Mode	Channel	Frequency	Conducted Power	
		MHz	dBm	watts
PCS CDMA	25	1851.25	+22.97	0.198
	600	1880.00	+23.96	0.249
	1175	1909.75	+23.98	0.250

G.9. PASS/FAIL

There is no pass/fail criterion for this measurement. The EIRP values, applied to appropriate regulatory requirements are outlined in Appendix J.

G.10. SIGN-OFF

I attest to the accuracy of the data. All measurements reported herein were performed by me and are correct to the best of my knowledge and belief. I assume full responsibility for the completeness of these measurements.

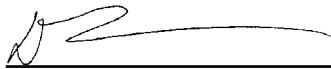

 Duane M. Friesen
 EMC Manager
 Celltech Labs Inc.

 10Dec05
 Date

Applicant:	Itronix Corporation	FCC ID:	KBCIX325-AC580	IC ID:	1943A-IX325f	
Rugged Tablet PC with Sierra Wireless AirCard 580 Dual-Band CDMA Modem				Model:	IX325-AC580	
2006 Celltech Labs Inc.		This document is not to be reproduced in whole or in part without the prior written permission of Celltech Labs Inc.				Page 44 of 70

 Celltech Testing and Engineering Services Lab	Test Report Serial No.:	100305KBC-T672-E24C	Report Issue No.:	E672C-020106-R0
	Test Date(s):	07Oct05 - 10Dec05	Report Issue Date:	February 1, 2006
	Test Standard(s):	FCC 47 CFR §2, §22H, §24E	Industry Canada RSS-132/133	
	Lab Registration(s):	FCC Registration #714830	Industry Canada Lab File #3874	

Appendix H - Conducted PCS TX Spurious Emissions Measurement

H.1. REFERENCES	
Normative Reference Standard	FCC CFR 47 §24.238(a)
Procedure Reference	FCC CFR 47 §24.238(b)

H.2. LIMITS	
FCC CFR 47 §24.238	(a) <i>Out of band emissions. The power of any emission outside of the authorized operating frequency ranges must be attenuated below the transmitting power (P) by a factor of at least $43 + 10 \log(P)$ dB.</i>

H.3. ENVIRONMENTAL CONDITIONS	
Temperature	25 ± 5 °C
Humidity	35 ± 5 %RH
Barometric Pressure	uncontrolled

H.4. EQUIPMENT LIST						
ID	ASSET NUMBER	MANUFACTURER	MODEL	DESCRIPTION	LAST CAL	CAL DUE
1	00015	Agilent	E4408B	Spectrum Analyzer	24Jan05	24Jan06
2	00102	Pasternack	PE7015-3030	30dB attenuator	na	na*
3	na	Itronix	na	Cable & SMA adapter	na	na*

*Verified with VNA

H.5. MEASUREMENT EQUIPMENT SETUP						
MEASUREMENT EQUIPMENT CONNECTIONS	The measurement equipment was connected as shown in H.6.					
MEASUREMENT EQUIPMENT SETTINGS	The spectrum analyzer was set to the following settings:					
	Frequency Range	RBW	VBW	Attenuator	Offset	Detector
	MHz	kHz	MHz	dB	dB	
	Between Block edge and 1 MHz from Block edges	10*	1	10	-30.0	Sample*
Beyond 1MHz from Block edges	1000	1	0	-30.0	Peak	

*10 kHz RBW & sample detector used for band-edge, 30 kHz & peak detector used for wider span scans. Band-edge measurements corrected for specified BW of 1% of EBW within Block and 1 MHz of each edge.

Applicant:	Itronix Corporation	FCC ID:	KBCIX325-AC580	IC ID:	1943A-IX325f	
Rugged Tablet PC with Sierra Wireless AirCard 580 Dual-Band CDMA Modem				Model:	IX325-AC580	
2006 Celltech Labs Inc.	This document is not to be reproduced in whole or in part without the prior written permission of Celltech Labs Inc.					Page 45 of 70

	Test Report Serial No.:	100305KBC-T672-E24C	Report Issue No.:	E672C-020106-R0
	Test Date(s):	07Oct05 - 10Dec05	Report Issue Date:	February 1, 2006
	Test Standard(s):	FCC 47 CFR §2, §22H, §24E	Industry Canada RSS-132/133	
	Lab Registration(s):	FCC Registration #714830	Industry Canada Lab File #3874	

H.6. SETUP DRAWING

Figure H.6-1 - Setup Drawing

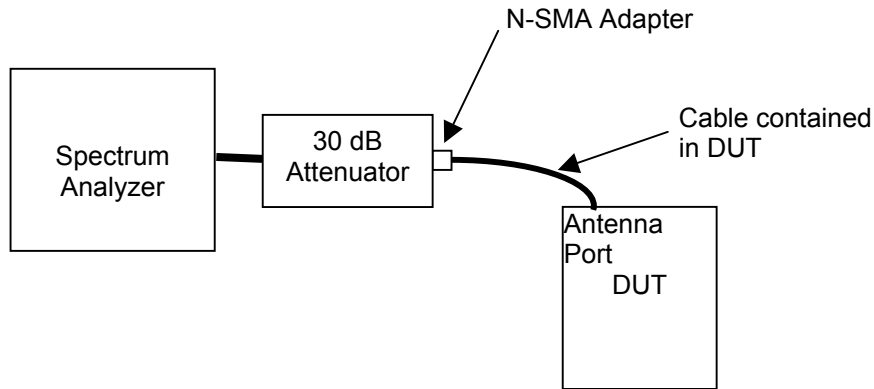

H.7. DUT OPERATING DESCRIPTION

Measurements were made with the DUT transmitting at maximum power in the PCS band, in a configuration as described in Section 5 of this report. The Block edge measurements were made with the DUT transmitting on the channel closest to the edge under investigation (CH25 & CH1175). The remaining spurious measurements were made on each of the three channels, Low (CH25), Mid (CH600) and High (CH1175).

Applicant:	Itronix Corporation	FCC ID:	KBCIX325-AC580	IC ID:	1943A-IX325f	
Rugged Tablet PC with Sierra Wireless AirCard 580 Dual-Band CDMA Modem			Model:	IX325-AC580		
2006 Celltech Labs Inc.	This document is not to be reproduced in whole or in part without the prior written permission of Celltech Labs Inc.					Page 46 of 70



Test Report Serial No.:	100305KBC-T672-E24C	Report Issue No.:	E672C-020106-R0
Test Date(s):	07Oct05 - 10Dec05	Report Issue Date:	February 1, 2006
Test Standard(s):	FCC 47 CFR §2, §22H, §24E	Industry Canada RSS-132/133	
Lab Registration(s):	FCC Registration #714830	Industry Canada Lab File #3874	

H.8. TEST RESULTS

H.8.1. Spurious Emissions within 1MHz of Block Edge

Emission Bandwidth - CH25

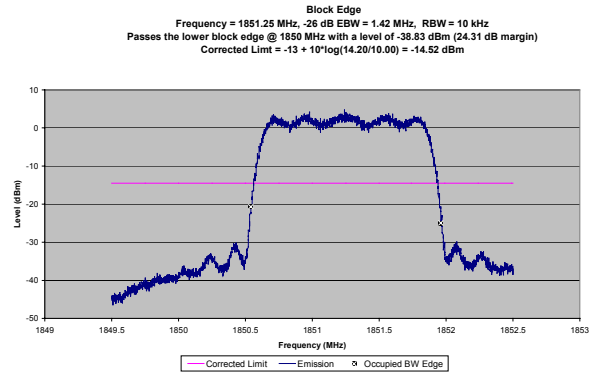

Emission Bandwidth - CH1175

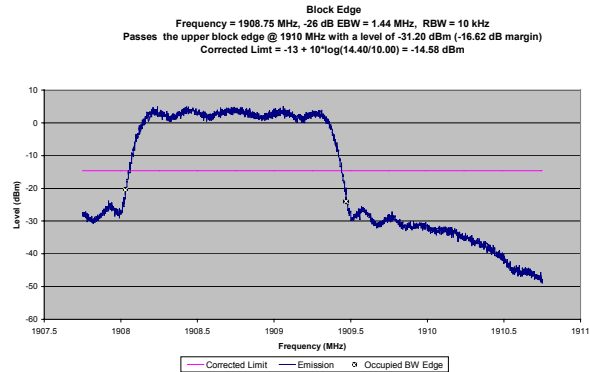

Lower Block Edge - 1850 MHz

Upper Block Edge - 1910

Corrected Limit (dBm) = Specified Limit (dBm) + $10 \cdot \log(BW_1/BW_2)$ where: BW_1 is the measurement RBW and BW_2 is 1% of the EBW

Frequency	Level	EBW	1% EBW Correction	Limit	Corrected Limit	Margin	Frequency	Level	EBW	1% EBW Correction	Limit	Corrected Limit	Margin
MHz	dBm	MHz	dB	dBm	dBm	dB	MHz	dBm	MHz	dB	dBm	dBm	dB
1850.56	-38.832	1.420	-1.523	-13.000	-14.523	24.309	1909.44	-31.201	1.440	-1.584	-13.000	-14.584	16.617

Applicant: Itronix Corporation **FCC ID:** KBCIX325-AC580 **IC ID:** 1943A-IX325f

Rugged Tablet PC with Sierra Wireless AirCard 580 Dual-Band CDMA Modem **Model:** IX325-AC580





Test Report Serial No.:	100305KBC-T672-E24C	Report Issue No.:	E672C-020106-R0
Test Date(s):	07Oct05 - 10Dec05	Report Issue Date:	February 1, 2006
Test Standard(s):	FCC 47 CFR §2, §22H, §24E	Industry Canada RSS-132/133	
Lab Registration(s):	FCC Registration #714830	Industry Canada Lab File #3874	

H.8.2. Spurious Emissions removed by more than 1MHz from Block Edge

Channel 25

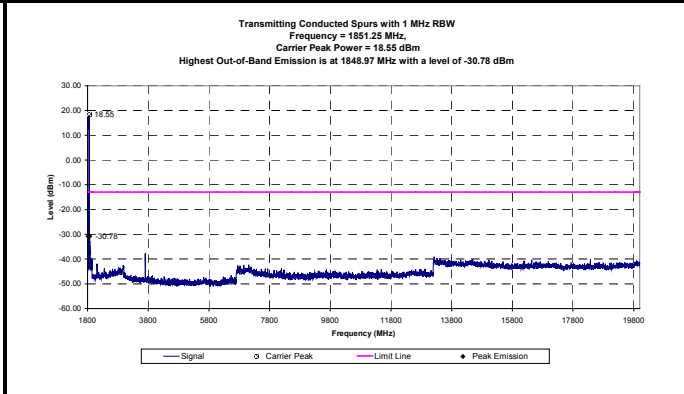
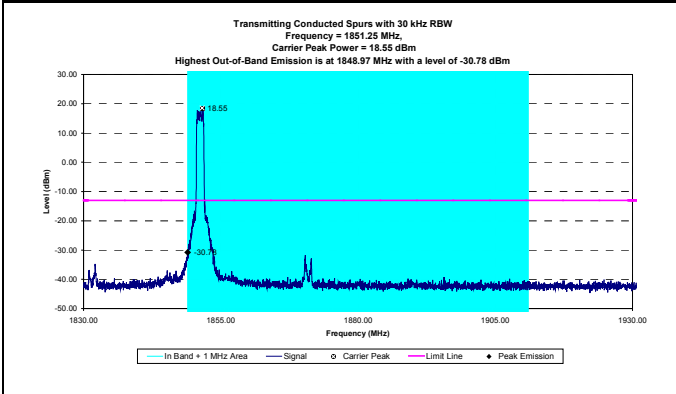

Channel 600

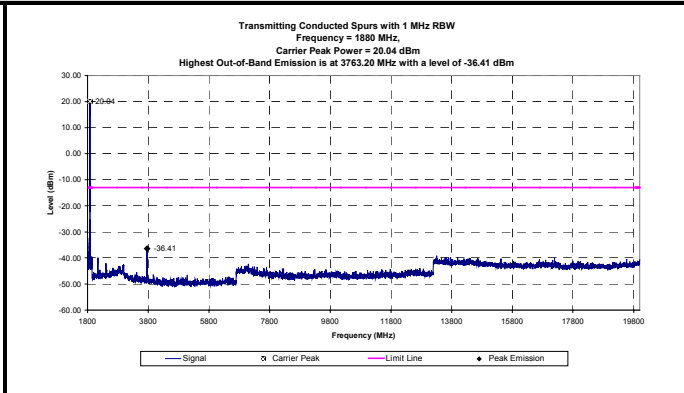
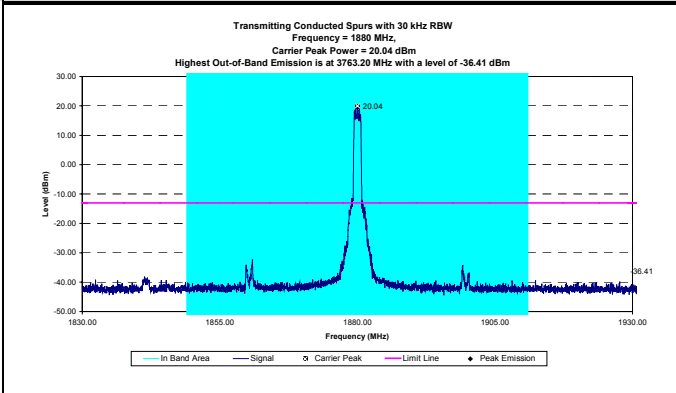

Channel 1175

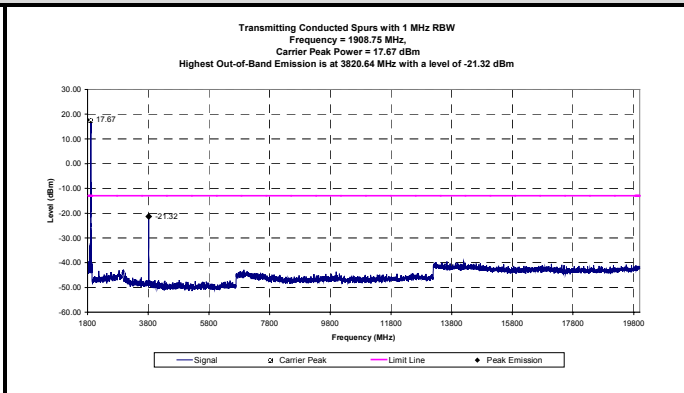
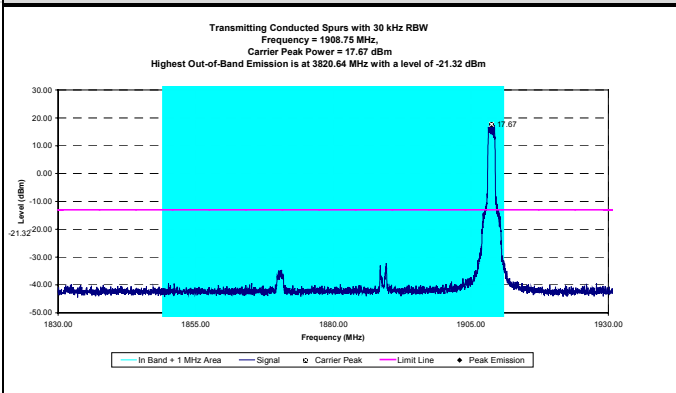

Channel	Peak Spurious Emission		Limit dBm	Margin dB	Pass / Fail
	Frequency MHz	Level dBm			
25	1848.97	-30.78	-13.00	17.78	Pass
600	3763.20	-36.41	-13.00	23.41	Pass
1175	3820.64	-21.32	-13.00	8.32	Pass

Applicant: Itronix Corporation **FCC ID:** KBCIX325-AC580 **IC ID:** 1943A-IX325f

Rugged Tablet PC with Sierra Wireless AirCard 580 Dual-Band CDMA Modem **Model:** IX325-AC580



	Test Report Serial No.:	100305KBC-T672-E24C	Report Issue No.:	E672C-020106-R0
	Test Date(s):	07Oct05 - 10Dec05	Report Issue Date:	February 1, 2006
	Test Standard(s):	FCC 47 CFR §2, §22H, §24E	Industry Canada RSS-132/133	
	Lab Registration(s):	FCC Registration #714830	Industry Canada Lab File #3874	

H.9. PASS/FAIL

In reference to the results outlined in H.9, the DUT passes the requirements as stated in the reference standards.

FCC CFR 4 §24.238 (a) Out of band emissions. The power of any emission outside of the authorized operating frequency ranges must be attenuated below the transmitting power (P) by a factor of at least $43 + 10 \log(P)$ dB.

The results set forth in this section meet the requirement with a margin of at least 8.32 dB (-21.32 dBm @ 3820.64 MHz versus a limit of -13 dBm with Channel 1175 transmitting)

H.10. SIGN-OFF

I attest to the accuracy of the data. All measurements reported herein were performed by me and are correct to the best of my knowledge and belief. I assume full responsibility for the completeness of these measurements.

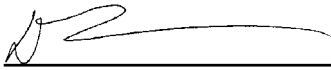

 Duane M. Friesen
 EMC Manager
 Celltech Labs Inc.

 10Dec05
 Date

Applicant:	Itronix Corporation	FCC ID:	KBCIX325-AC580	IC ID:	1943A-IX325f	
Rugged Tablet PC with Sierra Wireless AirCard 580 Dual-Band CDMA Modem				Model:	IX325-AC580	
2006 Celltech Labs Inc.	This document is not to be reproduced in whole or in part without the prior written permission of Celltech Labs Inc.					Page 49 of 70

	Test Report Serial No.:	100305KBC-T672-E24C	Report Issue No.:	E672C-020106-R0
	Test Date(s):	07Oct05 - 10Dec05	Report Issue Date:	February 1, 2006
	Test Standard(s):	FCC 47 CFR §2, §22H, §24E	Industry Canada RSS-132/133	
	Lab Registration(s):	FCC Registration #714830	Industry Canada Lab File #3874	

Appendix I - Conducted PCS RX Spurious Emissions Measurement

I.1. REFERENCES	
Normative Reference Standard	IC RSS-133 §6.7 (b)
Procedure Reference	IC RSS-133 §4.5

I.2. LIMITS	
IC RSS-133 §6.7	<i>(b) If a conducted measurement is made, no spurious output signals appearing at the antenna terminals shall exceed 2 nanowatts per 4 kHz spurious frequency in the band 30 – 1000 MHz or 5 nanowatts above 1 GHz.</i>

I.3. ENVIRONMENTAL CONDITIONS	
Temperature	25 ± 5 °C
Humidity	35 ± 5 %RH
Barometric Pressure	uncontrolled

I.4. EQUIPMENT LIST						
ID	ASSET NUMBER	MANUFACTURER	MODEL	DESCRIPTION	LAST CAL	CAL DUE
1	00015	Agilent	E4408B	Spectrum Analyzer	24Jan05	24Jan06
2	00188	Narda	M3933/16-06	2 x 2dB attenuator	na	na*
3	na	Itronix	na	Cable & SMA adapter	na	na*

*Verified with VNA

I.5. MEASUREMENT EQUIPMENT SETUP				
MEASUREMENT EQUIPMENT CONNECTIONS	The measurement equipment was connected as shown in I.6.			
MEASUREMENT EQUIPMENT SETTINGS	The spectrum analyzer was set to the following settings:			
	Frequency Range	RBW	VBW	Detector
	MHz	kHz	MHz	
	30 MHz - 3 x F _c	4*	1	Peak

Note: 4 kHz RBW & VBW are not attainable with equipment used and 3 kHz will be used. A bandwidth correction factor of 10 * log (4 kHz / 3 kHz), (1.25 dB) will be added to the final results.

Applicant:	Itronix Corporation	FCC ID:	KBCIX325-AC580	IC ID:	1943A-IX325f	
Rugged Tablet PC with Sierra Wireless AirCard 580 Dual-Band CDMA Modem				Model:	IX325-AC580	
2006 Celltech Labs Inc.	This document is not to be reproduced in whole or in part without the prior written permission of Celltech Labs Inc.					Page 50 of 70

	Test Report Serial No.:	100305KBC-T672-E24C	Report Issue No.:	E672C-020106-R0
	Test Date(s):	07Oct05 - 10Dec05	Report Issue Date:	February 1, 2006
	Test Standard(s):	FCC 47 CFR §2, §22H, §24E	Industry Canada RSS-132/133	
	Lab Registration(s):	FCC Registration #714830	Industry Canada Lab File #3874	

I.6. SETUP DRAWING

Figure I.6-1 - Setup Drawing

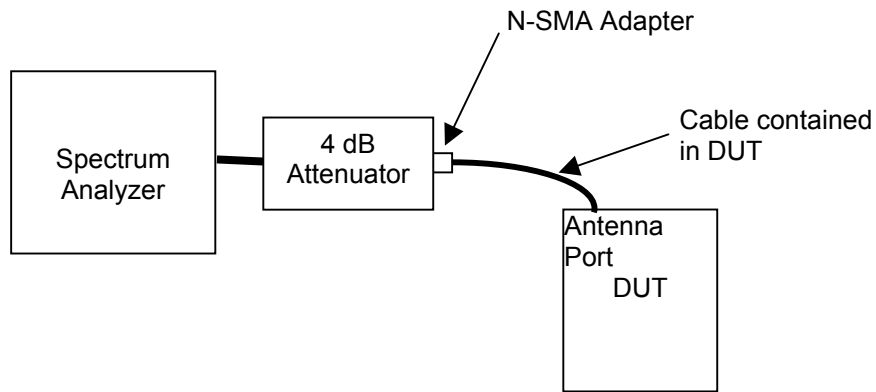

I.7. DUT OPERATING DESCRIPTION

Measurements were made with the DUT in the receive mode for the PCS band mid channel (CH600 1880 MHz)

Applicant:	Itronix Corporation	FCC ID:	KBCIX325-AC580	IC ID:	1943A-IX325f	
Rugged Tablet PC with Sierra Wireless AirCard 580 Dual-Band CDMA Modem			Model:	IX325-AC580		
2006 Celltech Labs Inc.	This document is not to be reproduced in whole or in part without the prior written permission of Celltech Labs Inc.					Page 51 of 70



Test Report Serial No.:	100305KBC-T672-E24C	Report Issue No.:	E672C-020106-R0
Test Date(s):	07Oct05 - 10Dec05	Report Issue Date:	February 1, 2006
Test Standard(s):	FCC 47 CFR §2, §22H, §24E	Industry Canada RSS-132/133	
Lab Registration(s):	FCC Registration #714830	Industry Canada Lab File #3874	

I.8. TEST RESULTS

I.8.1. Receiver Spurious Emissions

Receiver Conducted Spurs with 10 kHz RBW
 Frequency = 1880 MHz,
 The lowest margin is at 4287.50 MHz at 7.4 dB

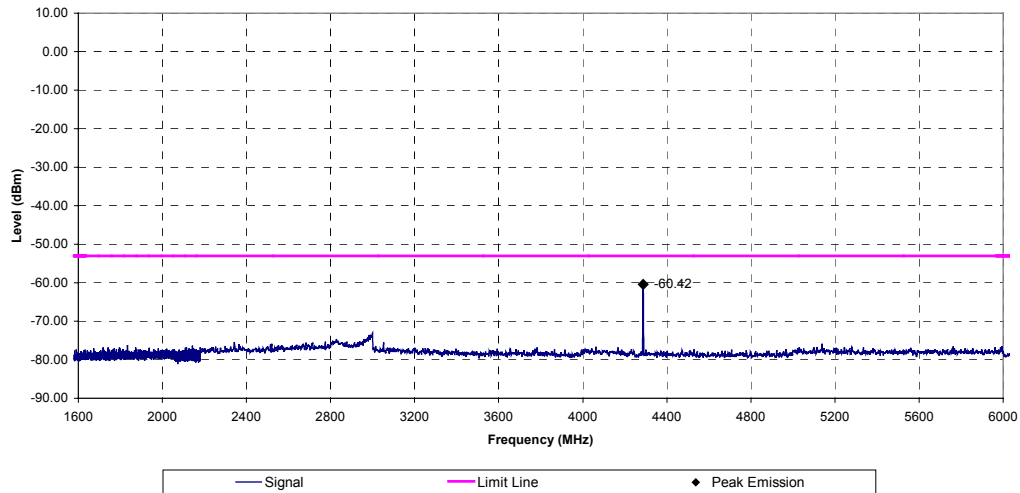

Receiver Conducted Spurs with 10 kHz RBW
 Frequency = 1880 MHz,
 The lowest margin is at 4287.20 MHz at 8.5 dB
 Signal Corrected for BW, BW Correction = 1.25 dB

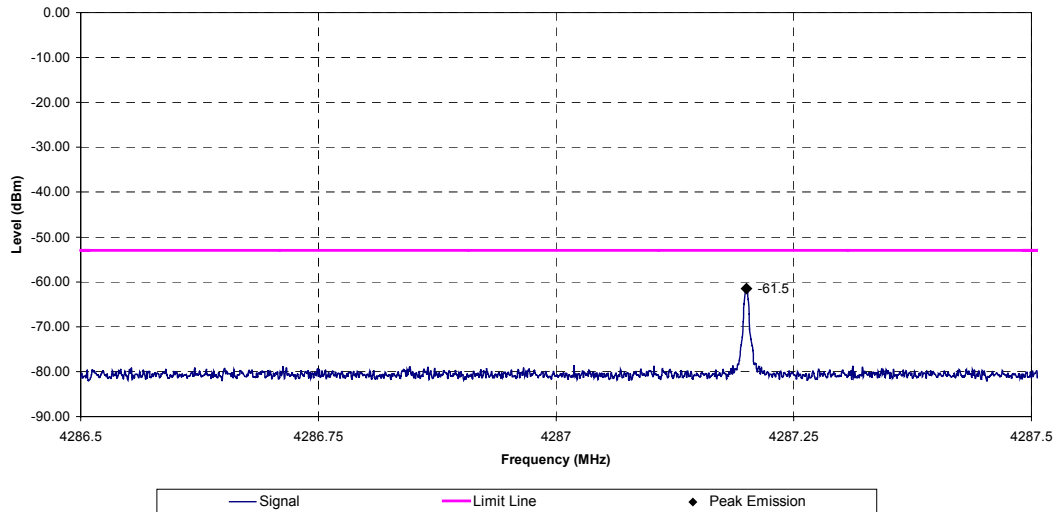

Calculations:

Limit (dBm) = 10 * log (Limit (mW))
 BW Correction* = 10 * log (4 kHz / 3 kHz)
 Margin (dB) = Limit (dBm) - Peak Emission (dBm)

*BW Correction used for zoom scan only

Applicant:	Itronix Corporation	FCC ID:	KBCIX325-AC580	IC ID:	1943A-IX325f	
Rugged Tablet PC with Sierra Wireless AirCard 580 Dual-Band CDMA Modem				Model:	IX325-AC580	
2006 Celltech Labs Inc.	This document is not to be reproduced in whole or in part without the prior written permission of Celltech Labs Inc.					Page 52 of 70

	Test Report Serial No.:	100305KBC-T672-E24C	Report Issue No.:	E672C-020106-R0
	Test Date(s):	07Oct05 - 10Dec05	Report Issue Date:	February 1, 2006
	Test Standard(s):	FCC 47 CFR §2, §22H, §24E	Industry Canada RSS-132/133	
	Lab Registration(s):	FCC Registration #714830	Industry Canada Lab File #3874	

I.9. PASS/FAIL

In reference to the results outlined in I.9, the DUT passes the requirements as stated in the reference standards.

IC RSS-133 §6.7 (b) If a conducted measurement is made, no spurious output signals appearing at the antenna terminals shall exceed 2 nanowatts per 4kHz spurious frequency in the band 30 – 1000 MHz or 5 nanowatts above 1 GHz.

The results set forth in this section meet the requirement with a margin of at least 8.5 dB.

I.10. SIGN-OFF

I attest to the accuracy of the data. All measurements reported herein were performed by me and are correct to the best of my knowledge and belief. I assume full responsibility for the completeness of these measurements.



 Duane M. Friesen
 EMC Manager
 Celltech Labs Inc.

 10Dec05
 Date

Applicant:	Itronix Corporation	FCC ID:	KBCIX325-AC580	IC ID:	1943A-IX325f	
Rugged Tablet PC with Sierra Wireless AirCard 580 Dual-Band CDMA Modem			Model:	IX325-AC580		
2006 Celltech Labs Inc.		This document is not to be reproduced in whole or in part without the prior written permission of Celltech Labs Inc.				Page 53 of 70

 Celltech <small>Testing and Engineering Services Lab</small>	Test Report Serial No.:	100305KBC-T672-E24C	Report Issue No.:	E672C-020106-R0
	Test Date(s):	07Oct05 - 10Dec05	Report Issue Date:	February 1, 2006
	Test Standard(s):	FCC 47 CFR §2, §22H, §24E	Industry Canada RSS-132/133	
	Lab Registration(s):	FCC Registration #714830	Industry Canada Lab File #3874	

Appendix J - PCS Band Effective Isotropic Radiated Power Measurement

J.1. REFERENCES	
Normative Reference Standard	FCC CFR 47 §24.232(b)
Procedure Reference	ANSI/TIA/EIA-603-C

J.2. LIMITS	
FCC CFR 47 §24.232 (b)	<i>(b) Mobile/portable stations are limited to 2 watts e.i.r.p. peak power and the equipment must employ means to limit the power to the minimum necessary for successful communications.</i>

J.3. ENVIRONMENTAL CONDITIONS	
Temperature	uncontrolled
Humidity	uncontrolled
Barometric Pressure	uncontrolled

J.4. EQUIPMENT LIST						
RECEIVING EQUIPMENT						
ID	ASSET NUMBER	MANUFACTURER	MODEL	DESCRIPTION	LAST CAL	CAL DUE
1	00072	EMCO	2075	Mini-mast	na	na
2	00073	EMCO	2080	Turn Table	na	na
3	00071	EMCO	2090	Multi-Device Controller	na	na
4	00034	ETS	3115	Double Ridged Guide Antenna (Rx)	11Aug05	11Aug06
5	00051	HP	8566B	Spectrum Analyzer	12Apr05	12Apr06
6	00047	HP	85685A	Preselector	13Apr05	13Apr06
7	00120	Celltech	n/a	Microwave Cable (RX)	25Mar05	25Mar06
8	00121	Andrew	FSJ4-50B	Microwave Cable (RX)	25Mar05	25Mar06
9	00130	Andrew	FSJ1-50A	Microwave Cable (RX)	25Mar05	25Mar06
ADDITIONAL SUBSTITUTION EQUIPMENT						
ID	ASSET NUMBER	MANUFACTURER	MODEL	DESCRIPTION	LAST CAL	CAL DUE
10	00035	ETS	3115	Horn Antenna (Tx)	24Mar04	24Mar06
11	00131	Andrew	FSJ1-50A	Microwave Cable (TX)	na	na
12	00127	Andrew	FSJ4-50B	Microwave Cable (TX)	na	na
13	00131	Andrew	FSJ1-50A	Microwave Cable (TX)	na	na
14	00006	R & S	SMR-20	Signal Generator	12Apr05	12Apr06
15	00110	Gigatronics	8652A	Power Meter	16Apr05	16Apr06
16	00012	Gigatronics	80701A	Power Sensor	12Sep05	12Sep06
17	00014	Gigatronics	80701A	Power Sensor	7Sep05	7Sep06
18	00102	Pasternack	PE7015-3110	30 dB attenuator	na*	na*
19	00078	Pasternack	PE2214-20	Directional Coupler	na*	na*
20	00142	HP	8491A	20 dB attenuator	na*	na*

*Attenuation offset in power meter setup

Applicant:	Itronix Corporation	FCC ID:	KBCIX325-AC580	IC ID:	1943A-IX325f	
Rugged Tablet PC with Sierra Wireless AirCard 580 Dual-Band CDMA Modem				Model:	IX325-AC580	
2006 Celltech Labs Inc.	This document is not to be reproduced in whole or in part without the prior written permission of Celltech Labs Inc.					Page 54 of 70

J.5. MEASUREMENT EQUIPMENT SETUP

MEASUREMENT EQUIPMENT CONNECTIONS

The measurement equipment was connected as shown in J.6.

MEASUREMENT EQUIPMENT SETTINGS

The spectrum analyzer was set to the following settings:

Frequency Range	RBW	VBW	Detector
MHz	MHz	MHz	
1000 - 2000	1	1	Peak

J.6. SETUP DRAWING

Figure J.6-1 - Field Strength Setup Drawing

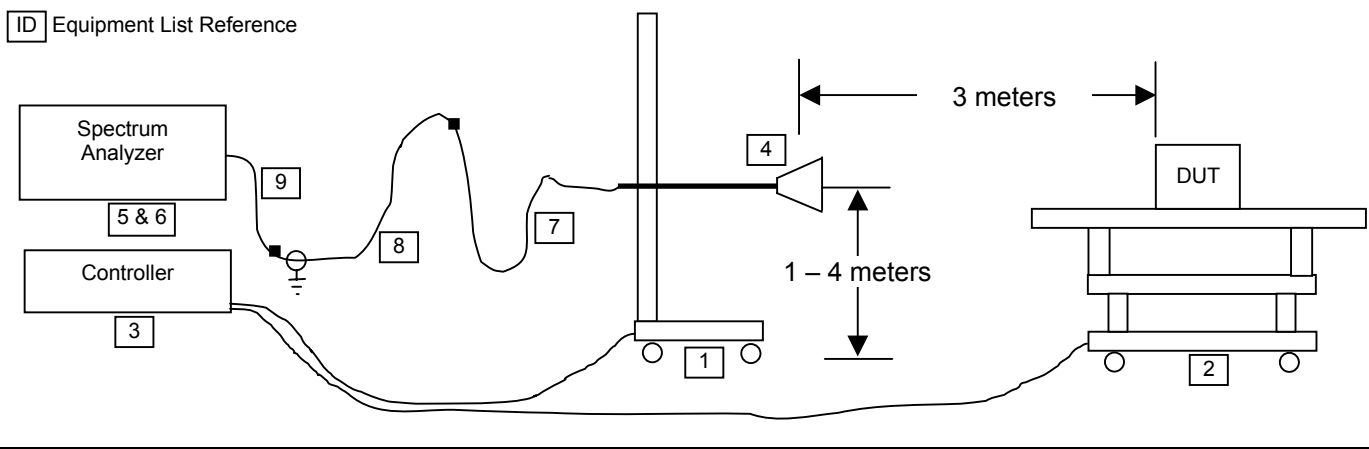
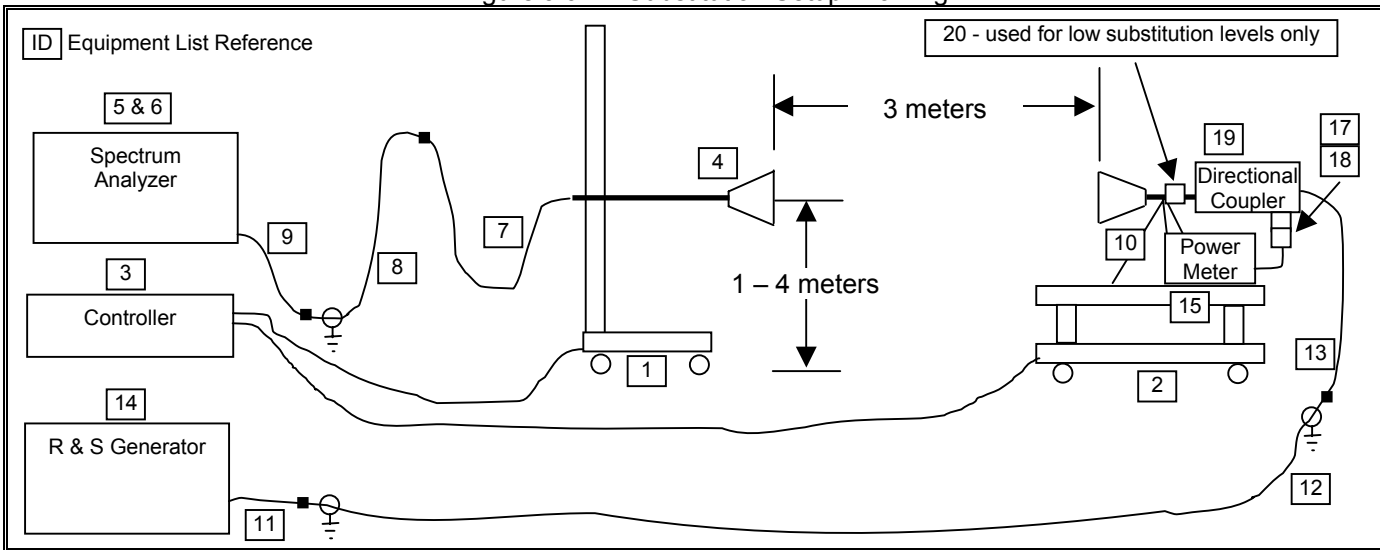

Figure J.6-2 - Substitution Setup Drawing



Test Report Serial No.:	100305KBC-T672-E24C	Report Issue No.:	E672C-020106-R0
Test Date(s):	07Oct05 - 10Dec05	Report Issue Date:	February 1, 2006
Test Standard(s):	FCC 47 CFR §2, §22H, §24E	Industry Canada RSS-132/133	
Lab Registration(s):	FCC Registration #714830	Industry Canada Lab File #3874	

J.7. SETUP PHOTOGRAPHS

Photograph J.7-1 - Portable DUT Configuration

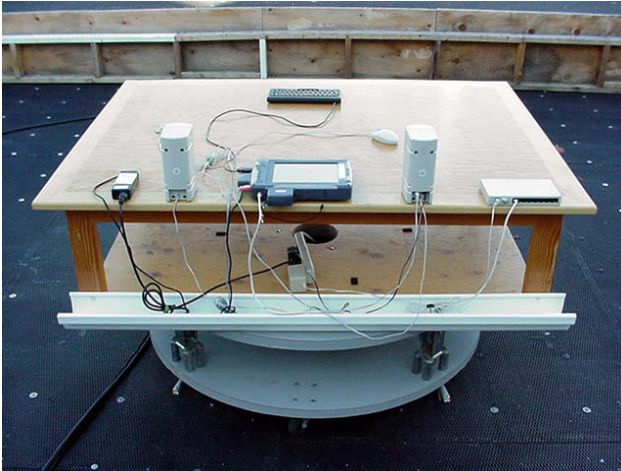

Photograph J.7-2 - Mobile DUT Configuration

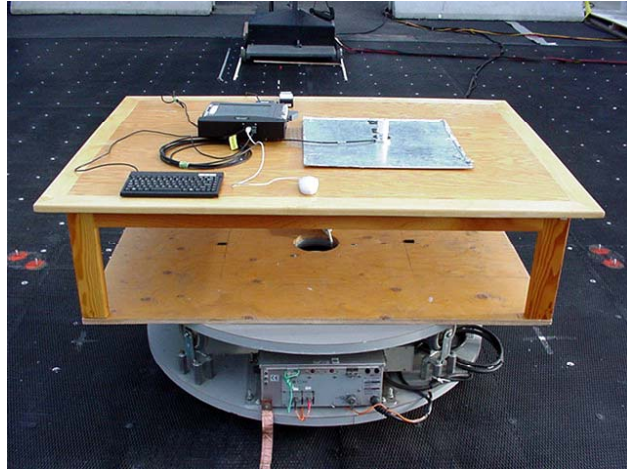

Photograph J.7-3 - Portable 3 m Horn setup



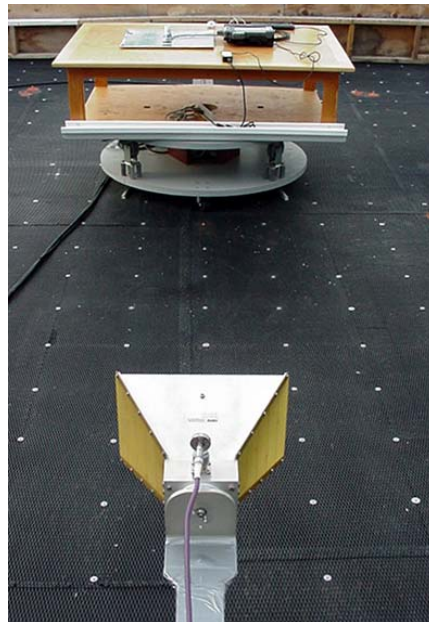

Photograph J.7-4 - Mobile - 3 m Horn Setup



J.8. DUT OPERATING DESCRIPTION

Measurements were made for the low, mid and high CDMA channels transmitting in the PCS band at maximum power levels, and the DUT configured as described in Section 5 of this report.

Applicant:	Itronix Corporation	FCC ID:	KBCIX325-AC580	IC ID:	1943A-IX325f	
Rugged Tablet PC with Sierra Wireless AirCard 580 Dual-Band CDMA Modem			Model:	IX325-AC580		
2006 Celltech Labs Inc.		This document is not to be reproduced in whole or in part without the prior written permission of Celltech Labs Inc.				Page 56 of 70

	Test Report Serial No.:	100305KBC-T672-E24C	Report Issue No.:	E672C-020106-R0
	Test Date(s):	07Oct05 - 10Dec05	Report Issue Date:	February 1, 2006
	Test Standard(s):	FCC 47 CFR §2, §22H, §24E	Industry Canada RSS-132/133	
	Lab Registration(s):	FCC Registration #714830	Industry Canada Lab File #3874	

J.9. TEST RESULTS

J.9.1. Portable



Project Number: 672
Company: Itronix
Product: IX325 Portable w/ AC580

Standard: FCC24.232b
Test Start Date: 25-Oct-05
Test End Date: 8-Dec-05

IX325 portable w/ AC580 Face up - Hpol Antenna Carrier Power Levels

Polarity	Distance m	Substitution Antenna Type	Carrier Channel	Frequency	Corrected Field Strength	Detector	Substituted SA Signal Level (uncorrected)	Power Applied to Antenna	Antenna Gain	EIRP Carrier Level		EIRP Limit		Margin dB	Pass/Fail
				MHz	dBuV/m		dBuV	dBm	dBi	dBm	Watts	dBm	Watts		
H	3	Horn SN6276	25	1851.25	123.71	PK	90.90	19.36	8.82	28.18	0.658	33.01	2.00	4.83	PASS
V	3	Horn SN6276	25	1851.25	118.11	PK	85.30	13.83	8.82	22.65	0.184	33.01	2.00	10.36	PASS
H	3	Horn SN6276	600	1880.00	123.87	PK	90.90	19.81	8.86	28.67	0.736	33.01	2.00	4.34	PASS
V	3	Horn SN6276	600	1880.00	118.97	PK	86.00	15.33	8.86	24.19	0.262	33.01	2.00	8.82	PASS
H	3	Horn SN6276	1175	1908.75	123.58	PK	90.45	20.10	8.89	28.99	0.793	33.01	2.00	4.02	PASS
V	3	Horn SN6276	1175	1908.75	117.23	PK	84.10	14.36	8.89	23.25	0.211	33.01	2.00	9.76	PASS

Note:
Double Ridged Guide Antenna used for substitution

Formulae:
 EIRP Level (dBm) = Power Applied to Antenna (dBm) + Antenna Gain (dBi)
 Margin (dB) = Limit (dBm) – Level (dBm)

J.9.2. Mobile



Project Number: 672
Company: Itronix
Product: IX325 Portable w/ AC580 Mobile

Standard: FCC24.232b
Test Start Date: 31-Oct-05
Test End Date: 8-Dec-05

IX325 with AC580 - mobile Carrier Power Levels

Polarity	Distance m	Substitution Antenna Type	Carrier Channel	Frequency	Corrected Field Strength	Detector	Substituted SA Signal Level (uncorrected)	Power Applied to Antenna	Antenna Gain	EIRP Carrier Level		EIRP Limit		Margin dB	Pass/Fail
				MHz	dBuV/m		dBuV	dBm	dBi	dBm	Watts	dBm	Watts		
H	3	Horn SN6276	25	1851.25	110.21	PK	77.40	6.00	8.82	14.82	0.030	33.01	2.00	18.19	PASS
V	3	Horn SN6276	25	1851.25	119.01	PK	86.20	14.67	8.82	23.49	0.223	33.01	2.00	9.52	PASS
H	3	Horn SN6276	600	1880.00	110.37	PK	77.40	6.71	8.86	15.57	0.036	33.01	2.00	17.44	PASS
V	3	Horn SN6276	600	1880.00	118.07	PK	85.10	14.44	8.86	23.30	0.214	33.01	2.00	9.71	PASS
H	3	Horn SN6276	1175	1908.75	108.93	PK	75.80	6.23	8.89	15.12	0.033	33.01	2.00	17.89	PASS
V	3	Horn SN6276	1175	1908.75	116.83	PK	83.70	13.95	8.89	22.84	0.192	33.01	2.00	10.17	PASS

Note:
Double Ridged Guide Antenna used for substitution

Formulae:
 EIRP Level (dBm) = Power Applied to Antenna (dBm) + Antenna Gain (dBi)
 Margin (dB) = Limit (dBm) – Level (dBm)

Applicant:	Itronix Corporation	FCC ID:	KBCIX325-AC580	IC ID:	1943A-IX325f	
Rugged Tablet PC with Sierra Wireless AirCard 580 Dual-Band CDMA Modem				Model:	IX325-AC580	
2006 Celltech Labs Inc.	This document is not to be reproduced in whole or in part without the prior written permission of Celltech Labs Inc.					Page 57 of 70

	Test Report Serial No.:	100305KBC-T672-E24C	Report Issue No.:	E672C-020106-R0
	Test Date(s):	07Oct05 - 10Dec05	Report Issue Date:	February 1, 2006
	Test Standard(s):	FCC 47 CFR §2, §22H, §24E	Industry Canada RSS-132/133	
	Lab Registration(s):	FCC Registration #714830	Industry Canada Lab File #3874	

J.10. PASS/FAIL

In reference to the results outlined in J.9, the DUT passes the requirements as stated in the reference standards as follows:

FCC 24.232 (b) Mobile/portable stations are limited to 2 watts e.i.r.p. peak power and the equipment must employ means to limit the power to the minimum necessary for successful communications.....

A maximum EIRP of +28.99 dBm (0.793 Watts) was measured when Channel 1175 was transmitting through the attached hinged dipole antenna.

J.11. SIGN-OFF

I attest to the accuracy of the data. All measurements reported herein were performed by me and are correct to the best of my knowledge and belief. I assume full responsibility for the completeness of these measurements.



Spencer Watson
Senior Compliance Technologist
Celltech Labs Inc.

8Dec05

Date

Applicant:	Itronix Corporation	FCC ID:	KBCIX325-AC580	IC ID:	1943A-IX325f	
Rugged Tablet PC with Sierra Wireless AirCard 580 Dual-Band CDMA Modem				Model:	IX325-AC580	
2006 Celltech Labs Inc.		This document is not to be reproduced in whole or in part without the prior written permission of Celltech Labs Inc.				Page 58 of 70

	Test Report Serial No.:	100305KBC-T672-E24C	Report Issue No.:	E672C-020106-R0
	Test Date(s):	07Oct05 - 10Dec05	Report Issue Date:	February 1, 2006
	Test Standard(s):	FCC 47 CFR §2, §22H, §24E	Industry Canada RSS-132/133	
	Lab Registration(s):	FCC Registration #714830	Industry Canada Lab File #3874	

Appendix K - Radiated PCS TX Spurious Emissions Measurement

K.1. REFERENCES	
Normative Reference Standard	FCC CFR 47 §24.238(a)
Procedure Reference	ANSI/TIA/EIA-603-C

K.2. LIMITS	
FCC CFR 47 §24.238	(a) <i>Out of band emissions. The power of any emission outside of the authorized operating frequency ranges must be attenuated below the transmitting power (P) by a factor of at least $43 + 10 \log(P)$ dB.</i>

K.3. ENVIRONMENTAL CONDITIONS	
Temperature	uncontrolled
Humidity	uncontrolled
Barometric Pressure	uncontrolled

K.4. EQUIPMENT LIST						
RECEIVING EQUIPMENT						
ID	ASSET NUMBER	MANUFACTURER	MODEL	DESCRIPTION	LAST CAL	CAL DUE
1	00072	EMCO	2075	Mini-mast	na	na
2	00073	EMCO	2080	Turn Table	na	na
3	00071	EMCO	2090	Multi-Device Controller	na	na
4	00035	ETS	3115	Double Ridged Guide Antenna (Rx)	24Mar04	24Mar06
5	00161/00166	Waveline	899/801-KF	Standard Gain Horn Antenna (Rx)	n/a	n/a
6	00015	HP	E4408B	Spectrum Analyzer	24Jan05	24Jan06
7	00051	HP	8566B	Spectrum Analyzer	12Apr05	12Apr06
8	00047	HP	85685A	Preselector	13Apr05	13Apr06
9	00120	Celltech	n/a	Microwave Cable (RX)	25Mar05	25Mar06
10	00121	Andrew	FSJ4-50B	Microwave Cable (RX)	25Mar05	25Mar06
11	00130	Andrew	FSJ1-50A	Microwave Cable (RX)	25Mar05	25Mar06
12	00115	Miteq	JS4-00102600-35-5A	Low Noise Amplifier	08Jun05	08Jun06
13	00093	Microtronics	HPM50111	High Pass Filter	08Jun05	08Jun06
14	00119	INMAT	18AH-10	10dB attenuator	08Jun05	08Jun06

Applicant:	Itronix Corporation	FCC ID:	KBCIX325-AC580	IC ID:	1943A-IX325f	
Rugged Tablet PC with Sierra Wireless AirCard 580 Dual-Band CDMA Modem				Model:	IX325-AC580	
2006 Celltech Labs Inc.	This document is not to be reproduced in whole or in part without the prior written permission of Celltech Labs Inc.					Page 59 of 70

 Celltech Testing and Engineering Services Lab	Test Report Serial No.:	100305KBC-T672-E24C	Report Issue No.:	E672C-020106-R0
	Test Date(s):	07Oct05 - 10Dec05	Report Issue Date:	February 1, 2006
	Test Standard(s):	FCC 47 CFR §2, §22H, §24E	Industry Canada RSS-132/133	
	Lab Registration(s):	FCC Registration #714830	Industry Canada Lab File #3874	

ADDITIONAL SUBSTITUTION EQUIPMENT						
ID	ASSET NUMBER	MANUFACTURER	MODEL	DESCRIPTION	LAST CAL	CAL DUE
15	00034	ETS	3115	Horn Antenna (Tx)	24Mar04	24Mar06
16	00162/00165	Waveline	899/801-KF	Standard Gain Horn Antenna (Tx)	na	na
17	00131	Andrew	FSJ1-50A	Microwave Cable (TX)	na	na
18	00127	Andrew	FSJ4-50B	Microwave Cable (TX)	na	na
19	00133	Andrew	FSJ1-50A	Microwave Cable (TX)	na	na
20	00006	R & S	SMR-20	Signal Generator	12Apr05	12Apr06
21	00110	Gigatronics	8652A	Power Meter	16Apr05	16Apr06
22	00012	Gigatronics	80701A	Power Sensor	12Sep05	12Sep06
23	00014	Gigatronics	80701A	Power Sensor	07Sep05	07Sep06
24	00102	Pasternack	PE7015-3110	30 dB attenuator	na*	na*
25	00078	Pasternack	PE2214-20	Directional Coupler	na*	na*
26	00142	HP	8491A	20 dB attenuator	na*	na*

* Attenuation offset in power meter setup

K.5. MEASUREMENT EQUIPMENT SETUP						
MEASUREMENT EQUIPMENT CONNECTIONS	The measurement equipment was connected as shown in K.6. A number of measurement equipment configurations were used to cover the applicable frequency ranges. The configurations for each range are as follows:					
	Frequency Range	LNA Asset #	Filter/Attenuator Asset #	Rx Antenna Asset #	Tx Antenna Asset #	
	1 GHz – 2 GHz	none	none	00034	00035	
	2 GHz – 3 GHz	00115	00119	00034	00035	
	3 GHz – 18 GHz	00115	00093	00034	00035	
18 GHz – 25 GHz	00115	none	000161/00166	000162/00165		
MEASUREMENT EQUIPMENT SETTINGS	The spectrum analyzer was set to the following settings:					
	Frequency Range	RBW		VBW		Detector
	MHz	kHz		kHz		
	1 GHz – 25 GHz	1000		1000		Peak

Applicant:	Itronix Corporation	FCC ID:	KBCIX325-AC580	IC ID:	1943A-IX325f	
Rugged Tablet PC with Sierra Wireless AirCard 580 Dual-Band CDMA Modem				Model:	IX325-AC580	
2006 Celltech Labs Inc.	This document is not to be reproduced in whole or in part without the prior written permission of Celltech Labs Inc.					Page 60 of 70

K.6. SETUP DRAWING

Figure K.6-1 - Field Strength Setup Drawing

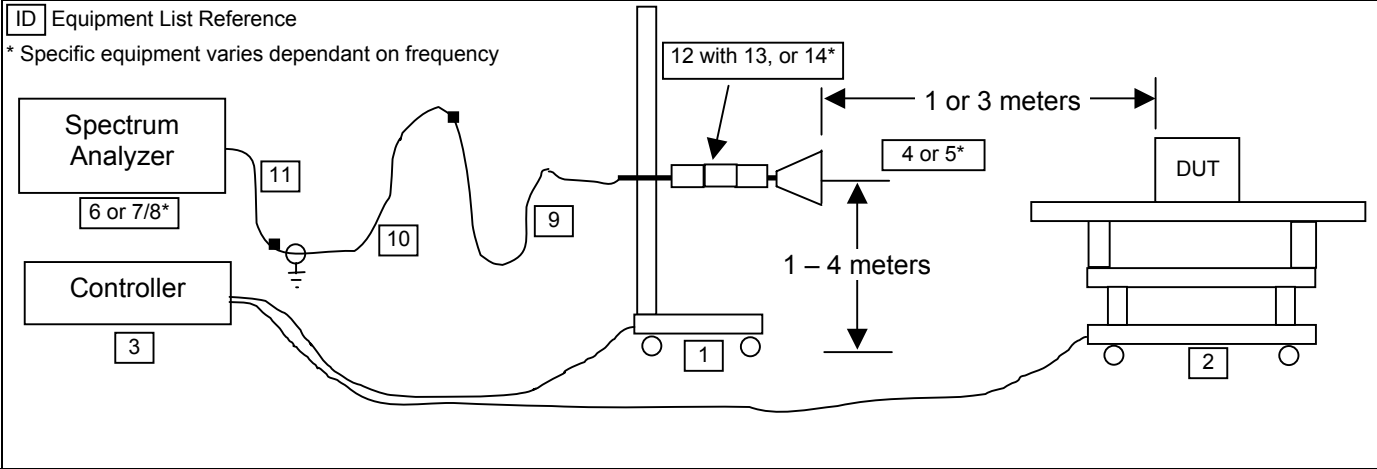
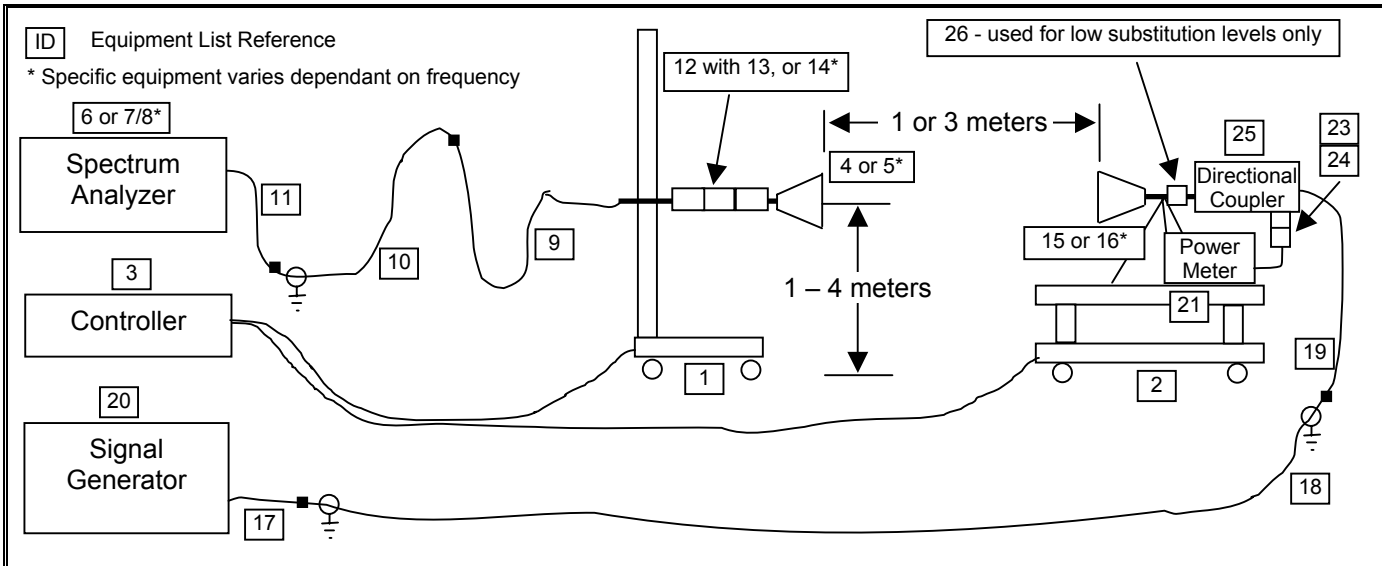

Figure K.6-2 - Signal Substitution Setup Drawing



Test Report Serial No.:	100305KBC-T672-E24C	Report Issue No.:	E672C-020106-R0
Test Date(s):	07Oct05 - 10Dec05	Report Issue Date:	February 1, 2006
Test Standard(s):	FCC 47 CFR §2, §22H, §24E	Industry Canada RSS-132/133	
Lab Registration(s):	FCC Registration #714830	Industry Canada Lab File #3874	

K.7. SETUP PHOTOGRAPHS

Photograph K.7-1 - Portable DUT Configuration

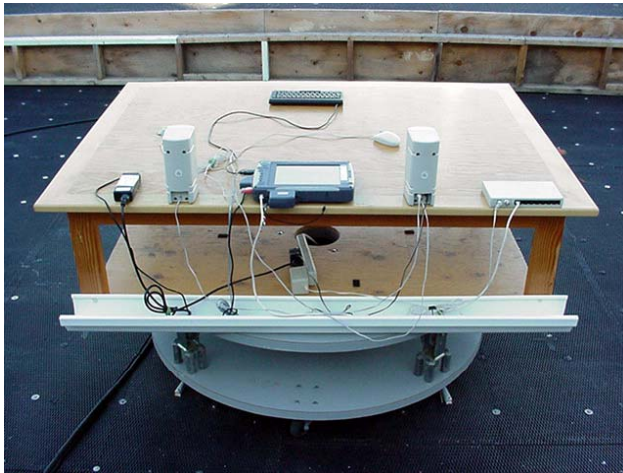

Photograph K.7-2 - Mobile DUT Configuration

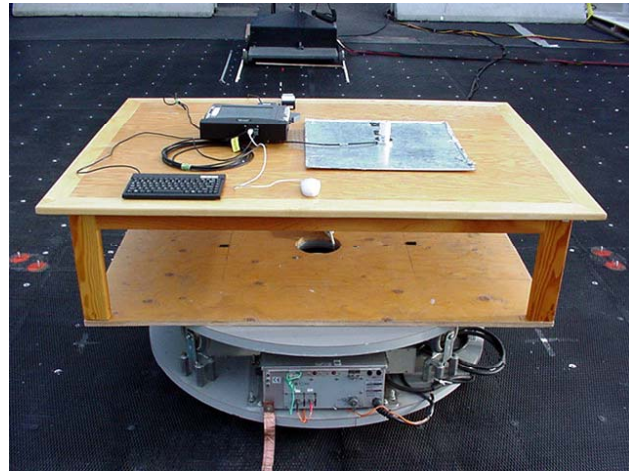

Photograph K.7-3 - Portable - 3 m Horn setup



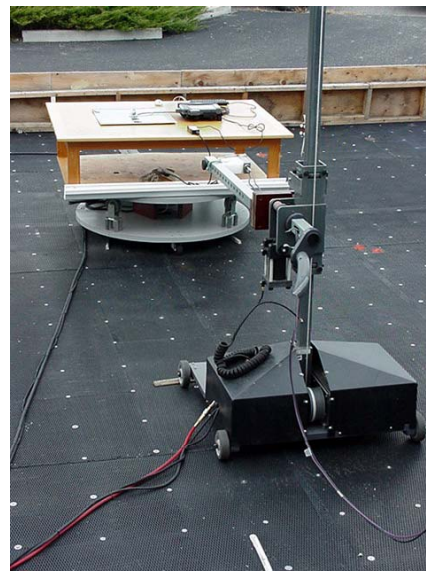

Photograph K.7-4 - Mobile - 1 m Horn Setup



K.8. DUT OPERATING DESCRIPTION

Measurements were made for the low, mid and high CDMA channels transmitting in the PCS band at maximum power levels as described in Section 5 of this report. The conducted transmit spurious emissions supplementary measurements are described in Appendix H.

Applicant:	Itronix Corporation	FCC ID:	KBCIX325-AC580	IC ID:	1943A-IX325f	
Rugged Tablet PC with Sierra Wireless AirCard 580 Dual-Band CDMA Modem				Model:	IX325-AC580	
2006 Celltech Labs Inc.	This document is not to be reproduced in whole or in part without the prior written permission of Celltech Labs Inc.					Page 62 of 70

	Test Report Serial No.:	100305KBC-T672-E24C	Report Issue No.:	E672C-020106-R0
	Test Date(s):	07Oct05 - 10Dec05	Report Issue Date:	February 1, 2006
	Test Standard(s):	FCC 47 CFR §2, §22H, §24E	Industry Canada RSS-132/133	
	Lab Registration(s):	FCC Registration #714830	Industry Canada Lab File #3874	

K.9. TEST RESULTS

K.9.1. Spurious Emissions - Portable

Channel 25



Project Number:
Company: Itronix
Product: IX325 Portable w/ AC580

Standard: FCC24.238
Test Start Date: 25-Oct-05
Test End Date: 25-Oct-05

IX325 portable w/ AC580 Face up - Hpol Antenna

Polarity	Distance m	Substitution Antenna Type	Carrier Channel	Frequency MHz	Corrected Field Strength dBuV/m	Detector	Substituted SA Signal Level (uncorrected) dBuV	Power Applied to Antenna dBm	Antenna Gain dBi	EIRP Emission Level dBm	Limit dBm or dBuV/m*	Margin dB	Pass/Fail
H	3	none	CH25	1897.00	61.76	PK*					82.2*	20.5*	PASS*
H	3	none	CH25	3702.90	60.20	PK*					82.2*	22.0*	PASS*
H	3	none	CH25	5554.70	52.78	PK*					82.2*	29.4*	PASS*
H	1	none	CH25	7405.58	58.11	PK*					91.8*	33.7*	PASS*
H	1	none	CH25	9255.00	51.20	PK*					91.8*	40.6*	PASS*
H	1	none	CH25	11105.00	51.99	PK*					91.8*	39.8*	PASS*
H	1	none	CH25	12955.00	54.16	PK*					91.8*	37.6*	PASS*
H	1	none	CH25	14810.00	56.15	PK*					91.8*	35.6*	PASS*
H	1	none	CH25	16657.50	55.27	PK*					91.8*	36.5*	PASS*
H	1	none	CH25	18512.50	54.37	PK*					91.8*	37.4*	PASS*
V	3	none	CH25	2827.72	60.76	PK*					82.2*	21.5*	PASS*
V	3	Horn SN6276	CH25	3701.88	64.60	PK	56.10	-42.54	9.86	-32.68	-13.00	19.68	PASS
V	3	none	CH25	3701.88	54.30	AV					82.2*	27.9*	PASS*
V	3	none	CH25	5290.00	61.65	PK*					82.2*	20.6*	PASS*
V	3	none	CH25	5554.54	57.88	PK*					82.2*	24.4*	PASS*
V	1	none	CH25	7406.05	69.23	PK*					91.8*	22.5*	PASS*
V	1	none	CH25	9255.20	58.05	PK*					91.8*	33.7*	PASS*
V	1	none	CH25	11108.00	55.66	PK*					91.8*	36.1*	PASS*
V	1	none	CH25	12957.40	61.48	PK*					91.8*	30.3*	PASS*
V	1	none	CH25	14810.00	56.44	PK*					91.8*	35.3*	PASS*
V	1	none	CH25	16657.50	55.81	PK*					91.8*	36.0*	PASS*
V	1	none	CH25	18512.50	55.24	PK*					91.8*	36.5*	PASS*

PK* - measurement made with a peak detector and applied to an average limit.
 Pass* - Margin and Pass/Fail based on measured field strengths applied against a theoretical field strength limit.
BOLD - carrier harmonic frequencies

Note:

The emissions reported above represent the highest emissions or noise floor measured within the frequency band of 30MHz and the 10th harmonic of the carrier with peak field strengths within 20 dB of the theoretical limit. All other emissions attributed to the EUT had field strengths greater than 20 dB below the theoretical limit and substitutions were not made.

Formulae:

EIRP Emission Level (dBm) = Power applied to antenna (dBm) + Antenna Gain (dBi)

Margin (dB) = Limit (dBm) – EIRP Emission Level (dBm) or Theoretical Limit (dBuV/m) – Corrected Field Strength (dBuV/m)

Theoretical Limit (V/m) = SQRT(30 * P / r²) where P is the total transmitted power limit (W), r is measurement distance (m)

Applicant:	Itronix Corporation	FCC ID:	KBCIX325-AC580	IC ID:	1943A-IX325f	
Rugged Tablet PC with Sierra Wireless AirCard 580 Dual-Band CDMA Modem			Model:	IX325-AC580		
2006 Celltech Labs Inc.	This document is not to be reproduced in whole or in part without the prior written permission of Celltech Labs Inc.					Page 63 of 70

 Testing and Engineering Services Lab	Test Report Serial No.:	100305KBC-T672-E24C	Report Issue No.:	E672C-020106-R0
	Test Date(s):	07Oct05 - 10Dec05	Report Issue Date:	February 1, 2006
	Test Standard(s):	FCC 47 CFR §2, §22H, §24E	Industry Canada RSS-132/133	
	Lab Registration(s):	FCC Registration #714830	Industry Canada Lab File #3874	

Channel 600

 Testing and Engineering Services Lab	Project Number:		Standard:	FCC24.238
	Company:	Itronix	Test Start Date:	25-Oct-05
	Product:	IX325 Portable w/ AC580	Test End Date:	25-Oct-05

IX325 portable w/ AC580 Face up - Hpol Antenna

Polarity	Distance m	Substitution Antenna Type	Carrier Channel	Frequency	Corrected Field Strength	Detector	Substituted SA Signal Level (uncorrected)	Power Applied to Antenna	Antenna Gain	EIRP Emission Level	Limit	Margin	Pass/Fail
				MHz	dBuV/m		dBuV	dBm	dBi	dBm	dBm or dBuV/m*	dB	
H	3	Horn SN6276	CH600	3760.74	66.90	PK	58.30	-40.43	9.85	-30.58	-13.00	17.58	PASS
H	3	none	CH600	3760.74	56.40	AV					82.2*	25.8*	PASS*
H	3	none	CH600	5640.84	54.14	PK*					82.2*	28.1*	PASS*
H	1	none	CH600	7519.05	63.19	PK*					91.8*	28.6*	PASS*
H	1	none	CH600	9400.00	54.06	PK*					91.8*	37.7*	PASS*
H	1	none	CH600	11280.00	51.04	PK*					91.8*	40.7*	PASS*
H	1	none	CH600	13158.30	63.10	PK*					91.8*	28.7*	PASS*
H	1	none	CH600	15037.50	56.12	PK*					91.8*	35.7*	PASS*
H	1	none	CH600	16920.00	57.34	PK*					91.8*	34.4*	PASS*
H	1	none	CH600	18796.90	54.60	PK*					91.8*	37.2*	PASS*
V	3	none	CH600	2828.82	66.77	PK					82.2*	15.5*	PASS*
V	3	none	CH600	2828.82	54.57	AV					82.2*	27.7*	PASS*
V	3	none	CH600	2868.90	61.08	PK*					82.2*	21.1*	PASS*
V	3	none	CH600	2888.48	64.52	PK					82.2*	17.7*	PASS*
V	3	none	CH600	2888.48	50.82	AV					82.2*	31.4*	PASS*
V	3	Horn SN6276	CH600	3760.30	68.59	PK	60.00	-37.98	9.85	-28.13	-13.00	15.13	PASS
V	3	none	CH600	3760.30	60.19	AV					82.2*	22.0*	PASS*
V	3	none	CH600	5285.32	62.79	PK*					82.2*	19.4*	PASS*
V	3	Horn SN6276	CH600	5640.70	59.04	PK*	44.90	-45.06	11.07	-33.99	-13.00	20.99	PASS
V	3	none	CH600	5640.70	45.84	AV					82.2*	36.4*	PASS*
V	1	none	CH600	7520.80	66.77	PK*					91.8*	25.0*	PASS*
V	1	none	CH600	9399.40	55.72	PK*					91.8*	36.1*	PASS*
V	1	none	CH600	11280.00	55.10	PK*					91.8*	36.7*	PASS*
V	1	none	CH600	13161.90	63.98	PK*					91.8*	27.8*	PASS*
V	1	none	CH600	15037.50	56.24	PK*					91.8*	35.5*	PASS*
V	1	none	CH600	16920.00	56.86	PK*					91.8*	34.9*	PASS*
V	1	none	CH600	18796.90	54.26	PK*					91.8*	37.5*	PASS*

PK* - measurement made with a peak detector and applied to an average limit.
 Pass* - Margin and Pass/Fail based on measured field strengths applied against a theoretical field strength limit.
BOLD - carrier harmonic frequencies

Note:
 The emissions reported above represent the highest emissions or noise floor measured within the frequency band of 30MHz and the 10th harmonic of the carrier with peak field strengths within 20 dB of the theoretical limit. All other emissions attributed to the EUT had field strengths greater than 20 dB below the theoretical limit and substitutions were not made.

Formulae:
 EIRP Emission Level (dBm) = Power applied to antenna (dBm) + Antenna Gain (dBi)
 Margin (dB) = Limit (dBm) – EIRP Emission Level (dBm) or Theoretical Limit (dBuV/m) – Corrected Field Strength (dBuV/m)
 Theoretical Limit (V/m) = SQRT(30 * P / r²) where P is the total transmitted power limit (W), r is measurement distance (m)

Applicant:	Itronix Corporation	FCC ID:	KBCIX325-AC580	IC ID:	1943A-IX325f	
Rugged Tablet PC with Sierra Wireless AirCard 580 Dual-Band CDMA Modem				Model:	IX325-AC580	
2006 Celltech Labs Inc.	This document is not to be reproduced in whole or in part without the prior written permission of Celltech Labs Inc.					Page 64 of 70

	Test Report Serial No.:	100305KBC-T672-E24C	Report Issue No.:	E672C-020106-R0
	Test Date(s):	07Oct05 - 10Dec05	Report Issue Date:	February 1, 2006
	Test Standard(s):	FCC 47 CFR §2, §22H, §24E	Industry Canada RSS-132/133	
	Lab Registration(s):	FCC Registration #714830	Industry Canada Lab File #3874	

Channel 1175

	Project Number:		Standard:	FCC24.238
	Company:	Itronix	Test Start Date:	25-Oct-05
	Product:	IX325 Portable w/ AC580	Test End Date:	25-Oct-05

IX325 portable w/ AC580 Face up - Hpol Antenna

Polarity	Distance m	Substitution Antenna Type	Carrier Channel	Frequency	Corrected Field Strength	Detector	Substituted SA Signal Level (uncorrected)	Power Applied to Antenna	Antenna Gain	EIRP Emission Level	Limit	Margin	Pass/Fail
				MHz	dBuV/m		dBuV	dBm	dBi	dBm	dBm or dBuV/m*	dB	
H	3	Horn SN6276	CH1175	3818.32	80.82	PK	71.90	-26.80	9.84	-16.96	-13.00	3.96	PASS
H	3	none	CH1175	3818.32	70.62	AV					82.2*	11.6*	PASS*
H	3	none	CH1175	5285.14	62.09	PK*					82.2*	20.1*	PASS*
H	3	Horn SN6276	CH1175	5726.72	54.20	PK*	40.20	-53.58	11.17	-42.41	-13.00	29.41	PASS
H	3	none	CH1175	5726.72	42.60	AV					82.2*	39.6*	PASS*
H	3	none	CH1175	5820.30	61.61	PK*					82.2*	20.6*	PASS*
H	1	none	CH1175	7633.90	69.77	PK*					91.8*	22.0*	PASS*
H	1	none	CH1175	9544.05	64.46	PK*					91.8*	27.3*	PASS*
H	1	none	CH1175	11452.15	57.49	PK*					91.8*	34.3*	PASS*
H	1	Horn SN6276	CH1175	13359.50	75.50	PK*	57.52	-44.15	12.35	-31.80	-13.00	18.80	PASS
H	1	none	CH1175	15271.90	61.71	PK*					91.8*	30.1*	PASS*
H	1	none	CH1175	17172.55	59.45	PK*					91.8*	32.3*	PASS*
H	1	none	CH1175	19083.80	55.52	PK*					91.8*	36.2*	PASS*
V	3	none	CH1175	2943.06	65.93	PK					82.2*	16.3*	PASS*
V	3	none	CH1175	2943.06	52.13	AV					82.2*	30.1*	PASS*
V	3	Horn SN6276	CH1175	3818.46	74.72	PK*	65.80	-32.15	9.84	-22.31	-13.00	9.31	PASS
V	3	none	CH1175	3818.46	65.72	AV					82.2*	16.5*	PASS*
V	3	Horn SN6276	CH1175	5725.36	63.70	PK*	49.70	-38.39	11.17	-27.22	-13.00	14.22	PASS
V	3	none	CH1175	5725.36	53.30	AV					82.2*	28.9*	PASS*
V	1	Horn SN6276	CH1175	7634.10	72.72	PK*	61.72	-44.88	11.45	-33.43	-13.00	20.43	PASS
V	1	none	CH1175	7635.00	60.48	AV					91.8*	31.3*	PASS*
V	1	none	CH1175	9543.30	66.12	PK*					91.8*	25.7*	PASS*
V	1	none	CH1175	11454.15	64.06	PK*					91.8*	27.7*	PASS*
V	1	none	CH1175	13363.05	79.83	PK*					91.8*	11.9*	PASS*
V	1	none	CH1175	13361.20	65.73	AV					91.8*	26.0*	PASS*
V	1	none	CH1175	15271.55	64.16	PK*					91.8*	27.6*	PASS*
V	1	none	CH1175	17187.30	60.41	PK*					91.8*	31.4*	PASS*
V	1	none	CH1175	19083.80	54.92	PK*					91.8*	36.8*	PASS*

PK* - measurement made with a peak detector and applied to an average limit.
 Pass* - Margin and Pass/Fail based on measured field strengths applied against a theoretical field strength limit.
BOLD - carrier harmonic frequencies

Note:
 The emissions reported above represent the highest emissions or noise floor measured within the frequency band of 30MHz and the 10th harmonic of the carrier with peak field strengths within 20 dB of the theoretical limit. All other emissions attributed to the EUT had field strengths greater than 20 dB below the theoretical limit and substitutions were not made.

Formulae:
 EIRP Emission Level (dBm) = Power applied to antenna (dBm) + Antenna Gain (dBi)
 Margin (dB) = Limit (dBm) - EIRP Emission Level (dBm) or Theoretical Limit (dBuV/m) - Corrected Field Strength (dBuV/m)
 Theoretical Limit (V/m) = SQRT(30 * P / r²) where P is the total transmitted power limit (W), r is measurement distance (m)

Applicant:	Itronix Corporation	FCC ID:	KBCIX325-AC580	IC ID:	1943A-IX325f	
Rugged Tablet PC with Sierra Wireless AirCard 580 Dual-Band CDMA Modem				Model:	IX325-AC580	
2006 Celltech Labs Inc.	This document is not to be reproduced in whole or in part without the prior written permission of Celltech Labs Inc.					Page 65 of 70

 Testing and Engineering Services Lab	Test Report Serial No.:	100305KBC-T672-E24C	Report Issue No.:	E672C-020106-R0
	Test Date(s):	07Oct05 - 10Dec05	Report Issue Date:	February 1, 2006
	Test Standard(s):	FCC 47 CFR §2, §22H, §24E	Industry Canada RSS-132/133	
	Lab Registration(s):	FCC Registration #714830	Industry Canada Lab File #3874	

K.9.2. Spurious Emissions - Mobile

Channel 25



Project Number: 672
Company: Itronix
Product: IX325 Portable w/ AC580 Mobile

Standard: FCC24.238
Test Start Date: 31-Oct-05
Test End Date: 31-Oct-05

IX325 mobile w/ AC580

Polarity	Distance m	Substitution Antenna Type	Carrier Channel	Frequency	Corrected Field Strength	Detector	Substituted SA Signal Level (uncorrected)	Power Applied to Antenna	Antenna Gain	EIRP Emission Level	Limit	Margin	Pass/Fail
				MHz	dBuV/m		dBuV						
H	3	none	CH25	3701.34	49.90	PK*					82.2*	32.3*	PASS*
H	3	none	CH25	5553.44	49.25	PK*					82.2*	33.0*	PASS*
H	3	none	CH25	7404.57	63.54	PK					82.2*	18.7*	PASS*
H	3	none	CH25	7404.92	53.84	AV					82.2*	28.4*	PASS*
H	3	none	CH25	9256.98	55.98	PK*					82.2*	26.2*	PASS*
H	1	none	CH25	11108.90	54.08	PK*					91.8*	37.7*	PASS*
H	1	none	CH25	12960.30	70.05	PK*					91.8*	21.7*	PASS*
H	1	none	CH25	14810.00	56.09	PK*					91.8*	35.7*	PASS*
H	1	none	CH25	16657.50	53.64	PK*					91.8*	38.1*	PASS*
H	1	none	CH25	18510.00	53.96	PK*					91.8*	37.8*	PASS*
V	3	none	CH25	3701.98	56.50	PK*					82.2*	25.7*	PASS*
V	3	none	CH25	5554.33	56.47	PK*					82.2*	25.8*	PASS*
V	1	Horn SN6276	CH25	7405.00	75.78	PK*	65.24	-40.20	11.50	-28.71	-13.00	15.71	PASS
V	1	none	CH25	7405.10	67.53	AV					91.8*	24.2*	PASS*
V	3	none	CH25	9256.98	58.56	PK*					82.2*	23.7*	PASS*
V	1	none	CH25	11107.15	56.67	PK*					91.8*	35.1*	PASS*
V	1	Horn SN6276	CH25	12960.45	75.96	PK*	59.29	-37.50	13.06	-24.44	-13.00	11.44	PASS
V	1	none	CH25	12958.75	64.18	AV					91.8*	27.6*	PASS*
V	1	none	CH25	14810.00	56.13	PK*					91.8*	35.6*	PASS*
V	1	none	CH25	16657.50	54.84	PK*					91.8*	36.9*	PASS*
V	1	none	CH25	18510.00	54.05	PK*					91.8*	37.7*	PASS*

PK* - measurement made with a peak detector and applied to an average limit.
 Pass* - Margin and Pass/Fail based on measured field strengths applied against a theoretical field strength limit.
BOLD - carrier harmonic frequencies

Note:

The emissions reported above represent the highest emissions or noise floor measured within the frequency band of 30MHz and the 10th harmonic of the carrier with peak field strengths within 20 dB of the theoretical limit. All other emissions attributed to the EUT had field strengths greater than 20 dB below the theoretical limit and substitutions were not made.

Formulae:

EIRP Emission Level (dBm) = Power applied to antenna (dBm) + Antenna Gain (dBi)
 Margin (dB) = Limit (dBm) – EIRP Emission Level (dBm) or Theoretical Limit (dBuV/m) – Corrected Field Strength (dBuV/m)
 Theoretical Limit (V/m) = SQRT(30 * P / r²) where P is the total transmitted power limit (W), r is measurement distance (m)

Applicant:	Itronix Corporation	FCC ID:	KBCIX325-AC580	IC ID:	1943A-IX325f	
Rugged Tablet PC with Sierra Wireless AirCard 580 Dual-Band CDMA Modem			Model:	IX325-AC580		
2006 Celltech Labs Inc.	This document is not to be reproduced in whole or in part without the prior written permission of Celltech Labs Inc.					Page 66 of 70

	Test Report Serial No.:	100305KBC-T672-E24C	Report Issue No.:	E672C-020106-R0
	Test Date(s):	07Oct05 - 10Dec05	Report Issue Date:	February 1, 2006
	Test Standard(s):	FCC 47 CFR §2, §22H, §24E	Industry Canada RSS-132/133	
	Lab Registration(s):	FCC Registration #714830	Industry Canada Lab File #3874	

Channel 600

	Project Number:	672	Standard:	FCC24.238
	Company:	Itronix	Test Start Date:	31-Oct-05
	Product:	IX325 Portable w/ AC580 Mobile	Test End Date:	31-Oct-05

IX325 mobile w/ AC580

Polarity	Distance m	Substitution Antenna Type	Carrier Channel	Frequency	Corrected Field Strength	Detector	Substituted SA Signal Level (uncorrected)	Power Applied to Antenna	Antenna Gain	EIRP Emission Level	Limit	Margin	Pass/Fail
				MHz	dBuV/m		dBuV	dBm	dB	dBm	dBm or dBuV/m*	dB	
H	3	none	CH600	3759.25	54.19	PK*					82.2*	28.0*	PASS*
H	3	none	CH600	5639.90	49.25	PK*					82.2*	33.0*	PASS*
H	3	none	CH600	7518.95	61.17	PK*					82.2*	21.1*	PASS*
H	3	none	CH600	9397.63	57.36	PK*					82.2*	24.9*	PASS*
H	1	none	CH600	11279.85	54.90	PK*					91.8*	36.9*	PASS*
H	1	none	CH600	13158.10	73.61	PK					91.8*	18.2*	PASS*
H	1	none	CH600	13159.95	58.59	AV					91.8*	33.2*	PASS*
H	1	none	CH600	15037.50	56.19	PK*					91.8*	35.6*	PASS*
H	1	none	CH600	16920.00	56.24	PK*					91.8*	35.5*	PASS*
H	1	none	CH600	18796.90	54.14	PK*					91.8*	37.6*	PASS*
V	3	none	CH600	3759.17	55.89	PK*					82.2*	26.3*	PASS*
V	3	none	CH600	5640.86	61.34	PK					82.2*	20.9*	PASS*
V	3	none	CH600	5639.91	49.15	AV					82.2*	33.1*	PASS*
V	1	Horn SN6276	CH600	7520.90	71.31	PK*	60.41	-41.80	11.41	-30.39	-13.00	17.39	PASS
V	3	none	CH600	9398.00	55.36	PK*					82.2*	26.9*	PASS*
V	1	none	CH600	11278.80	57.75	PK*					91.8*	34.0*	PASS*
V	1	none	CH600	13158.20	77.15	PK					91.8*	14.6*	PASS*
V	1	none	CH600	13160.10	59.96	AV					91.8*	31.8*	PASS*
V	1	none	CH600	15037.50	56.95	PK*					91.8*	34.8*	PASS*
V	1	none	CH600	16920.00	55.42	PK*					91.8*	36.3*	PASS*
V	1	none	CH600	18796.90	54.34	PK*					91.8*	37.4*	PASS*

PK* - measurement made with a peak detector and applied to an average limit.
 Pass* - Margin and Pass/Fail based on measured field strengths applied against a theoretical field strength limit.
BOLD - carrier harmonic frequencies

Note:
 The emissions reported above represent the highest emissions or noise floor measured within the frequency band of 30MHz and the 10th harmonic of the carrier with peak field strengths within 20 dB of the theoretical limit. All other emissions attributed to the EUT had field strengths greater than 20 dB below the theoretical limit and substitutions were not made.

Formulae:
 EIRP Emission Level (dBm) = Power applied to antenna (dBm) + Antenna Gain (dBi)
 Margin (dB) = Limit (dBm) – EIRP Emission Level (dBm) or Theoretical Limit (dBuV/m) – Corrected Field Strength (dBuV/m)
 Theoretical Limit (V/m) = SQRT(30 * P / r²) where P is the total transmitted power limit (W), r is measurement distance (m)

Applicant:	Itronix Corporation	FCC ID:	KBCIX325-AC580	IC ID:	1943A-IX325f	
Rugged Tablet PC with Sierra Wireless AirCard 580 Dual-Band CDMA Modem			Model:	IX325-AC580		
2006 Celltech Labs Inc.	This document is not to be reproduced in whole or in part without the prior written permission of Celltech Labs Inc.					Page 67 of 70

 Testing and Engineering Services Lab	Test Report Serial No.:	100305KBC-T672-E24C	Report Issue No.:	E672C-020106-R0
	Test Date(s):	07Oct05 - 10Dec05	Report Issue Date:	February 1, 2006
	Test Standard(s):	FCC 47 CFR §2, §22H, §24E	Industry Canada RSS-132/133	
	Lab Registration(s):	FCC Registration #714830	Industry Canada Lab File #3874	

Channel 1175

	Project Number:	672	Standard:	FCC24.238
	Company:	Itronix	Test Start Date:	31-Oct-05
	Product:	IX325 Portable w/ AC580 Mobile	Test End Date:	31-Oct-05

IX325 mobile w/ AC580

Polarity	Distance m	Substitution Antenna Type	Carrier Channel	Frequency	Corrected Field Strength	Detector	Substituted SA Signal Level (uncorrected)	Power Applied to Antenna	Antenna Gain	EIRP Emission Level	Limit	Margin	Pass/Fail
				MHz	dBuV/m		dBuV	dBm	dB	dBm	dBm or dBuV/m*	dB	
H	3	none	CH1175	3816.13	54.40	PK*					82.2*	27.8*	PASS*
H	3	none	CH1175	5725.42	56.50	PK*					82.2*	25.7*	PASS*
H	3	none	CH1175	7636.03	62.98	PK					82.2*	19.3*	PASS*
H	3	none	CH1175	7635.02	48.98	AV					82.2*	33.3*	PASS*
H	3	none	CH1175	9543.00	56.38	PK*					82.2*	25.8*	PASS*
H	1	none	CH1175	7634.00	66.32	PK*					91.8*	25.4*	PASS*
H	1	none	CH1175	9543.85	62.93	PK*					91.8*	28.8*	PASS*
H	1	none	CH1175	11451.20	57.33	PK*					91.8*	34.4*	PASS*
H	1	Horn SN6276	CH1175	13363.05	76.57	PK*	58.56	-40.70	12.35	-28.35	-13.00	15.35	PASS
H	1	none	CH1175	15271.85	56.83	PK*					91.8*	34.9*	PASS*
H	1	none	CH1175	17178.70	56.73	PK*					91.8*	35.0*	PASS*
H	1	none	CH1175	19083.80	54.98	PK*					91.8*	36.8*	PASS*
V	3	none	CH1175	3816.73	65.70	PK					82.2*	16.5*	PASS*
V	3	none	CH1175	3817.10	56.60	AV					82.2*	25.6*	PASS*
V	3	none	CH1175	5727.06	66.60	PK					82.2*	15.6*	PASS*
V	3	none	CH1175	5726.19	56.00	AV					82.2*	26.2*	PASS*
V	1	Horn SN6276	CH1175	7634.15	76.70	PK*	65.70	-39.60	11.45	-28.15	-13.00	15.15	PASS
V	1	none	CH1175	7635.10	65.95	AV					91.8*	25.8*	PASS*
V	1	none	CH1175	9543.75	67.59	PK*					91.8*	24.2*	PASS*
V	1	none	CH1175	11451.05	58.96	PK*					91.8*	32.8*	PASS*
V	1	Horn SN6276	CH1175	13363.20	78.16	PK*	60.15	-39.40	12.35	-27.05	-13.00	14.05	PASS
V	1	none	CH1175	15268.45	59.03	PK*					91.8*	32.7*	PASS*
V	1	none	CH1175	17178.70	57.24	PK*					91.8*	34.5*	PASS*
V	1	none	CH1175	19083.80	54.32	PK*					91.8*	37.4*	PASS*

PK* - measurement made with a peak detector and applied to an average limit.
 Pass* - Margin and Pass/Fail based on measured field strengths applied against a theoretical field strength limit.
BOLD - carrier harmonic frequencies

Note:
 The emissions reported above represent the highest emissions or noise floor measured within the frequency band of 30MHz and the 10th harmonic of the carrier with peak field strengths within 20 dB of the theoretical limit. All other emissions attributed to the EUT had field strengths greater than 20 dB below the theoretical limit and substitutions were not made.

Formulae:
 EIRP Emission Level (dBm) = Power applied to antenna (dBm) + Antenna Gain (dBi)
 Margin (dB) = Limit (dBm) – EIRP Emission Level (dBm) or Theoretical Limit (dBuV/m) – Corrected Field Strength (dBuV/m)
 Theoretical Limit (V/m) = SQRT(30 * P / r²) where P is the total transmitted power limit (W), r is measurement distance (m)

Applicant:	Itronix Corporation	FCC ID:	KBCIX325-AC580	IC ID:	1943A-IX325f	
Rugged Tablet PC with Sierra Wireless AirCard 580 Dual-Band CDMA Modem			Model:	IX325-AC580		
2006 Celltech Labs Inc.	This document is not to be reproduced in whole or in part without the prior written permission of Celltech Labs Inc.					Page 68 of 70

	Test Report Serial No.:	100305KBC-T672-E24C	Report Issue No.:	E672C-020106-R0
	Test Date(s):	07Oct05 - 10Dec05	Report Issue Date:	February 1, 2006
	Test Standard(s):	FCC 47 CFR §2, §22H, §24E	Industry Canada RSS-132/133	
	Lab Registration(s):	FCC Registration #714830	Industry Canada Lab File #3874	

K.10. PASS/FAIL

In reference to the results outlined in K.9, the DUT passes the requirements as stated in the reference standards.

FCC CFR 4 §24.238 (a) Out of band emissions. The power of any emission outside of the authorized operating frequency ranges must be attenuated below the transmitting power (P) by a factor of at least $43 + 10 \log(P)$ dB.

The results set forth in this section meet the requirement with a margin of at least 3.96 dB.

K.11. SIGN-OFF

I attest to the accuracy of the data. All measurements reported herein were performed by me and are correct to the best of my knowledge and belief. I assume full responsibility for the completeness of these measurements.



for Russell Pipe
Senior Compliance Technologist
Celltech Labs Inc.

31Oct05

Date

Applicant:	Itronix Corporation	FCC ID:	KBCIX325-AC580	IC ID:	1943A-IX325f	
Rugged Tablet PC with Sierra Wireless AirCard 580 Dual-Band CDMA Modem			Model:	IX325-AC580		
2006 Celltech Labs Inc.	This document is not to be reproduced in whole or in part without the prior written permission of Celltech Labs Inc.					Page 69 of 70

	Test Report Serial No.:	100305KBC-T672-E24C	Report Issue No.:	E672C-020106-R0
	Test Date(s):	07Oct05 - 10Dec05	Report Issue Date:	February 1, 2006
	Test Standard(s):	FCC 47 CFR §2, §22H, §24E	Industry Canada RSS-132/133	
	Lab Registration(s):	FCC Registration #714830	Industry Canada Lab File #3874	

END OF DOCUMENT

Applicant:	Itronix Corporation	FCC ID:	KBCIX325-AC580	IC ID:	1943A-IX325f	
Rugged Tablet PC with Sierra Wireless AirCard 580 Dual-Band CDMA Modem				Model:	IX325-AC580	
2006 Celltech Labs Inc.	This document is not to be reproduced in whole or in part without the prior written permission of Celltech Labs Inc.					Page 70 of 70