



FCC 47 CFR PART 15 SUBPART C

TEST REPORT

For

Twinhead International Corp

Tablet PC

Model: T8(Twinhead) / CT30(Intermec) / IX300(Itronix)

Trade Name: Twinhead / Intermec / Itronix

Prepared for

**Twinhead International Corp
10F, 550 Rueiguang Rd, Neihu,
Taipei, Taiwan 114, R.O.C.**

Prepared by

**Compliance Certification Services Inc.
No. 81-1, Lane 210, Bade Rd. 2, Luchu Hsiang,
Taoyuan Hsien, (338) Taiwan, R.O.C.**

TEL: 886-3-324-0332

FAX: 886-3-324-5235



Note: This report shall not be reproduced except in full, without the written approval of Compliance Certification Services Inc. This document may be altered or revised by Compliance Certification Services Inc. personnel only, and shall be noted in the revision section of the document.



TABLE OF CONTENTS

1. TEST RESULT CERTIFICATION..... 3

2. EUT DESCRIPTION..... 4

3. TEST METHODOLOGY 5

 3.1 EUT CONFIGURATION 5

 3.2 EUT EXERCISE 5

 3.3 GENERAL TEST PROCEDURES 5

 3.4 FCC PART 15.205 RESTRICTED BANDS OF OPERATIONS 6

 3.5 DESCRIPTION OF TEST MODES 6

4. INSTRUMENT CALIBRATION..... 7

5. FACILITIES AND ACCREDITATIONS 8

 5.1 FACILITIES..... 8

 5.2 EQUIPMENT 8

 5.3 LABORATORY ACCREDITATIONS AND LISTING 8

 5.4 TABLE OF ACCREDITATIONS AND LISTINGS 9

6. SETUP OF EQUIPMENT UNDER TEST 10

 6.1 SUPPORT EQUIPMENT 10

7. FCC PART 15.247 REQUIREMENTS..... 11

CONDITION A: WLAN OPERATION 11

 7.1 6DB BANDWIDTH..... 11

 7.2 PEAK POWER 14

 7.3 BAND EDGES MEASUREMENT..... 17

 7.4 PEAK POWER SPECTRAL DENSITY 22

 7.5 RADIO FREQUENCY EXPOSURE..... 25

CONDITION B: BLUETOOTH OPERATION 26

 7.6 PEAK POWER 26

 7.7 BAND EDGES MEASUREMENT..... 29

 7.8 PEAK POWER SPECTRAL DENSITY 34

 7.9 FREQUENCY SEPARATION 37

 7.10 NUMBER OF HOPPING FREQUENCY 39

 7.11 TIME OF OCCUPANCY (DWELL TIME) 41

 7.12 RADIO FREQUENCY EXPOSURE..... 45

CONDITION C: CO-LACATED OPERATION (WLAN & BLUETOOTH OPERATED SIMULTANEOUSLY) 46

 7.13 RADIATED EMISSIONS 46

 7.14 POWERLINE CONDUCTED EMISSIONS 76



1. TEST RESULT CERTIFICATION

Applicant:	Twinhead International Corp 10F, 550 Rueiguang Rd, Neihu, Taipei, Taiwan 114, R.O.C.
Equipment Under Test:	Tablet PC
Trade Name:	Twinhead / Intermec / Itronix
Model:	T8(Twinhead) / CT30(Intermec) / IX300(Itronix)
Model Difference	All the above models are identical except the model designation
Report Number:	B30813209-RP
Date of Test:	August 19 ~ September 5, 2003

APPLICABLE STANDARDS	
STANDARD	TEST RESULT
FCC Part 15 Subpart C	No non-compliance noted

We hereby certify that:

The above equipment was tested by Compliance Certification Services Inc. The test data, data evaluation, test procedures, and equipment configurations shown in this report were made in accordance with the procedures given in ANSI C63.4 (1992) and the energy emitted by the sample EUT tested as described in this report is in compliance with conducted and radiated emission limits of FCC Rules Part 15.247.

The test results of this report relate only to the tested sample identified in this report.

Approved by:

Jonson Lee
Director of Linkou Laboratory
Compliance Certification Services Inc.

Reviewed by:

Eric Wong
Section Manager
Compliance Certification Services Inc.



2. EUT DESCRIPTION

Product	Tablet PC
Trade Name	Twinhead / Intermec / Itronix
Model Number	T8(Twinhead) / CT30(Intermec) / IX300(Itronix)
Model Discrepancy	All the above models are identical except the model designation
Power Supply	Input: Vac 100~240V, 50/60 Hz; 1.5A Output: Vdc 20V, 3.0A 60W Max
Frequency Range	2412 ~ 2462 MHz for WLAN 2402 MHz – 2480 MHz for Bluetooth
Transmit Power	15.52 dBm for WLAN -0.03 dBm for Bluetooth
Modulation Technique	DSSS (CCK; DQPSK; DBPSK) Frequency Hopping Spread Spectrum (FHSS)
Number of Channels	11 for WLAN 79 for Bluetooth
Antenna Gain	0.11dBi for WLAN -3.04dBi for Bluetooth
Antenna Designation	PIFA Antenna

Note: This submittal(s) (test report) is intended for FCC ID: FKGTABLETPC filing to comply with Section 15.247 of the FCC Part 15, Subpart C Rules. The composite system (digital device) is compliance with Subpart B is authorized under a DoC procedure.



3. TEST METHODOLOGY

The tests documented in this report were performed in accordance with ANSI C63.4 and FCC CFR 47 2.1046, 2.1047, 2.1049, 2.1051, 2.1053, 2.1055, 2.1057, and 15.247.

3.1 EUT CONFIGURATION

The EUT configuration for testing is installed on RF field strength measurement to meet the Commissions requirement and operating in a manner that intends to maximize its emission characteristics in a continuous normal application.

3.2 EUT EXERCISE

The EUT (Tablet PC) was operated in the engineering mode to fix the TX frequency that was for the purpose of the measurements.

According to its specifications, the EUT must comply with the requirements of the Section 15.247 under the FCC Rules Part 15 Subpart C. The composite system (Digital device) is compliance with the Subpart B is authorized under the DoC procedure.

3.3 GENERAL TEST PROCEDURES

Conducted Emissions

The EUT is placed on the turntable, which is 0.8 m above ground plane. According to the requirements in Section 13.1.4.1 of ANSI C63.4-1992. Conducted emissions from the EUT measured in the frequency range between 0.15 MHz and 30MHz using CISPR Quasi-peak and average detector modes.

Radiated Emissions

The EUT is placed on a turn table, which is 0.8 m above ground plane. The turntable shall rotate 360 degrees to determine the position of maximum emission level. EUT is set 3m away from the receiving antenna, which varied from 1m to 4m to find out the highest emission. And also, each emission was to be maximized by changing the polarization of receiving antenna both horizontal and vertical. In order to find out the max. emission, the relative positions of this hand-held transmitter (EUT) was rotated through three orthogonal axes according to the requirements in Section 13.1.4.1 of ANSI C63.4-1992.

3.4 FCC PART 15.205 RESTRICTED BANDS OF OPERATIONS

(a) Except as shown in paragraph (d) of this section, only spurious emissions are permitted in any of the frequency bands listed below:

MHz	MHz	MHz	GHz
0.090 - 0.110	16.42 - 16.423	399.9 - 410	4.5 - 5.15
¹ 0.495 - 0.505	16.69475 - 16.69525	608 - 614	5.35 - 5.46
2.1735 - 2.1905	16.80425 - 16.80475	960 - 1240	7.25 - 7.75
4.125 - 4.128	25.5 - 25.67	1300 - 1427	8.025 - 8.5
4.17725 - 4.17775	37.5 - 38.25	1435 - 1626.5	9.0 - 9.2
4.20725 - 4.20775	73 - 74.6	1645.5 - 1646.5	9.3 - 9.5
6.215 - 6.218	74.8 - 75.2	1660 - 1710	10.6 - 12.7
6.26775 - 6.26825	108 - 121.94	1718.8 - 1722.2	13.25 - 13.4
6.31175 - 6.31225	123 - 138	2200 - 2300	14.47 - 14.5
8.291 - 8.294	149.9 - 150.05	2310 - 2390	15.35 - 16.2
8.362 - 8.366	156.52475 -	2483.5 - 2500	17.7 - 21.4
8.37625 - 8.38675	156.52525	2655 - 2900	22.01 - 23.12
8.41425 - 8.41475	156.7 - 156.9	3260 - 3267	23.6 - 24.0
12.29 - 12.293	162.0125 - 167.17	3332 - 3339	31.2 - 31.8
12.51975 - 12.52025	167.72 - 173.2	3345.8 - 3358	36.43 - 36.5
12.57675 - 12.57725	240 - 285	3600 - 4400	(²)
13.36 - 13.41	322 - 335.4		

¹ Until February 1, 1999, this restricted band shall be 0.490-0.510 MHz.

² Above 38.6

(b) Except as provided in paragraphs (d) and (e), the field strength of emissions appearing within these frequency bands shall not exceed the limits shown in Section 15.209. At frequencies equal to or less than 1000 MHz, compliance with the limits in Section 15.209 shall be demonstrated using measurement instrumentation employing a CISPR quasi-peak detector. Above 1000 MHz, compliance with the emission limits in Section 15.209 shall be demonstrated based on the average value of the measured emissions. The provisions in Section 15.35 apply to these measurements.

3.5 DESCRIPTION OF TEST MODES

The EUT has been tested under operating condition.

Software used to control the EUT for staying in continuous transmitting and receiving mode is programmed.

Condition A (WLAN operation): Channel low (2412MHz) 、 mid (2437MHz) and high (2462MHz) with 11Mbps highest data rate (worst case) are chosen for the final testing.

Condition B (Bluetooth operation): Channel low (2402MHz) 、 mid (2441MHz) and high (2480MHz) with highest data rate (worst case) are chosen for final testing.

Condition C (Co-located operation): Radiated among the combination of the WLAN (maximum power) with every Bluetooth channel.



4. INSTRUMENT CALIBRATION

The measuring equipment, which was utilized in performing the tests documented herein, has been calibrated in accordance with the manufacturer's recommendations for utilizing calibration equipment, which is traceable to recognized national standards.



5. FACILITIES AND ACCREDITATIONS

5.1 FACILITIES

All measurement facilities used to collect the measurement data are located at

No. 81-1, Lane 210, Bade Rd. 2, Luchu Hsiang, Taoyuan Hsien, Taiwan, R.O.C.

No. 199, Chunghsen Road, Hsintien City, Taipei Hsien, Taiwan, R.O.C.

The sites are constructed in conformance with the requirements of ANSI C63.7, ANSI C63.4 and CISPR Publication 22.

5.2 EQUIPMENT

Radiated emissions are measured with one or more of the following types of linearly polarized antennas: tuned dipole, biconical, log periodic, bi-log, and/or ridged waveguide, horn. Spectrum analyzers with pre-selectors and quasi-peak detectors are used to perform radiated measurements.

Conducted emissions are measured with Line Impedance Stabilization Networks and EMI Test Receivers.







Calibrated wideband preamplifiers, coaxial cables, and coaxial attenuators are also used for making measurements.

All receiving equipment conforms to CISPR Publication 16-1, "Radio Interference Measuring Apparatus and Measurement Methods."

5.3 LABORATORY ACCREDITATIONS AND LISTING

The test facilities used to perform radiated and conducted emissions tests are accredited by National Voluntary Laboratory Accreditation Program for the specific scope of accreditation under Lab Code: 200600-0 to perform Electromagnetic Interference tests according to FCC PART 15 AND CISPR 22 requirements. No part of this report may be used to claim or imply product endorsement by NVLAP or any agency of the US Government. In addition, the test facilities are listed with Federal Communications Commission (Registration no: 93105 and 90471).

5.4 TABLE OF ACCREDITATIONS AND LISTINGS

Country	Agency	Scope of Accreditation	Logo
USA	NVLAP*	EN 55011, EN 55014-1, AS/NZS 1044, CNS 13783-1, EN 55022, CNS 13438, EN 61000-3-2, EN 61000-3-3, ANSI C63.4, FCC OST/MP-5, AS/NZS 3548 IEC 61000-4-2, IEC 61000-4-3, IEC 61000-4-4, IEC 61000-4-5, IEC 61000-4-6, IEC 61000-4-8, IEC 61000-4-11	 200600-0
USA	FCC	3/10 meter Open Area Test Sites to perform FCC Part 15/18 measurements	 93105, 90471
Japan	VCCI	4 3/10 meter Open Area Test Sites to perform conducted/radiated measurements	 R-393/1066/725/879 C-402/747/912
Norway	NEMKO	EN 50081-1/2, EN 50082-1/2, IEC 61000-6-1/2, EN 50091-2, EN 50130-4, EN 55011, EN 55013, EN 55014-1/2, EN 55015, EN 55022, EN 55024, EN 61000-3-2/3, EN 61326-1, IEC 61000-4-2/3/4/5/6/8/11, EN 60601-1-2, EN 300 328-2, EN 300 422-2, EN 301 419-1, EN 301 489-01/03/07/08/09/17, EN 301 419-2/3, EN 300 454-2, EN 301 357-2	 ELA 124a ELA 124b ELA 124c
Taiwan	CNLA	EN 300 328-1, EN 300 328-2, EN 300 220-1, EN 300 220-2, EN 300 220-3, 47 CFR FCC Part 15 Subpart C, EN 61000-3-2, EN 61000-3-3, CNS 13439, CNS 13783-1, CNS 14115, CNS 13438, AS/NZS 3548, CNS 13022-1, IEC 1000-4-3/4/5/6/8/11, CNS 13022-2/3	 0 3 6 3 ILAC MRA
Taiwan	BSMI	CNS 13438, CNS 13783-1, CNS 13439, CNS 14115	 SL2-IS-E-0014 SL2-IN-E-0014 SL2-A1-E-0014 SL2-R1-E-0014 SL2-R2-E-0014 SL2-L1-E-0014
Canada	Industry Canada	RSS212, Issue 1	 IC 3991-3 IC 3991-4

* No part of this report may be used to claim or imply product endorsement by NVLAP or any agency of the US Government.

6. SETUP OF EQUIPMENT UNDER TEST

6.1 SUPPORT EQUIPMENT

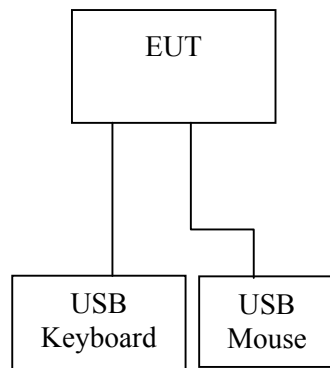

Device Type	Brand	Model	FCC ID	Series No.	Data Cable	Power Cord
USB Keyboard	IBM	KU-9958	3982A185	0004195	Shielded, 1.8m	N/A
USB Mouse	Logitech	M-BB48	4872A221	LZE92250102	Shielded, 1.8m	N/A

Notes:

1. All the equipment/cables were placed in the worst-case configuration to maximize the emission during the test.
2. Grounding was established in accordance with the manufacturer's requirements and conditions for the intended use.



7. FCC PART 15.247 REQUIREMENTS

CONDITION A: WLAN OPERATION

7.1 6DB BANDWIDTH

LIMIT

For the direct sequence systems, the minimum 6dB bandwidth shall be at least 500kHz.

MEASUREMENT EQUIPMENT USED

Name of Equipment	Manufacturer	Model	Serial Number	Calibration Due
Spectrum Analyzer	Agilent	E4446A	US42510252	04/28/2004
Low Loss RF Cable	Huber + Suhner	Sucoflex 104	N/A	N/A

Remark: Each piece of equipment is scheduled for calibration once a year.

Test Configuration

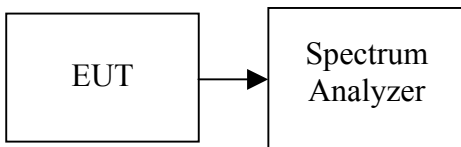

TEST PROCEDURE

1. Place the EUT on the table and set it in the transmitting mode.
2. Remove the antenna from the EUT and then connect a low loss RF cable from the antenna port to the spectrum analyzer.
3. Set the spectrum analyzer as RBW = 100kHz, VBW = RBW, Span = 20MHz, Sweep = auto.
4. Mark the peak frequency and -6dB (upper and lower) frequency.
5. Repeat until all the rest channels are investigated.

TEST RESULTS

No non-compliance noted

Test Data

Channel	Frequency (MHz)	Bandwidth (kHz)	Limit (kHz)	Margin (kHz)
Low	2412	11730	>500	PASS
Mid	2437	12170		PASS
High	2462	11170		PASS



Test Plot

6dB Bandwidth (Ch Low)

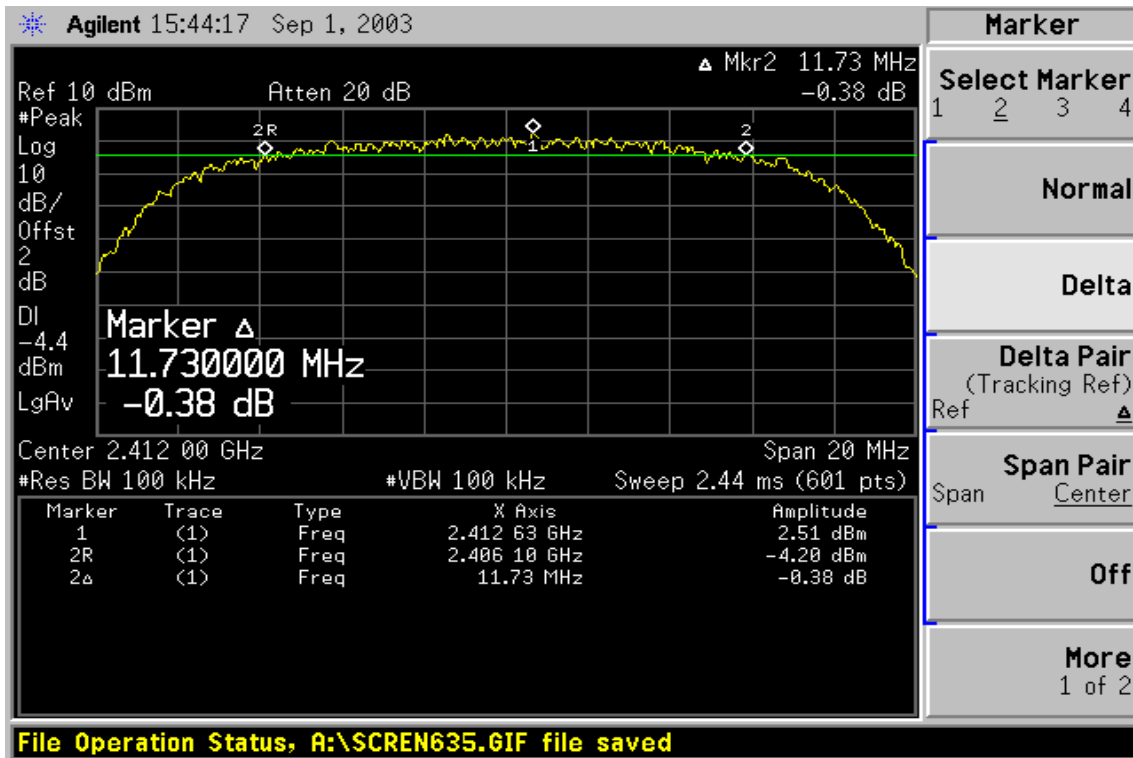

6dB Bandwidth (Ch Mid)

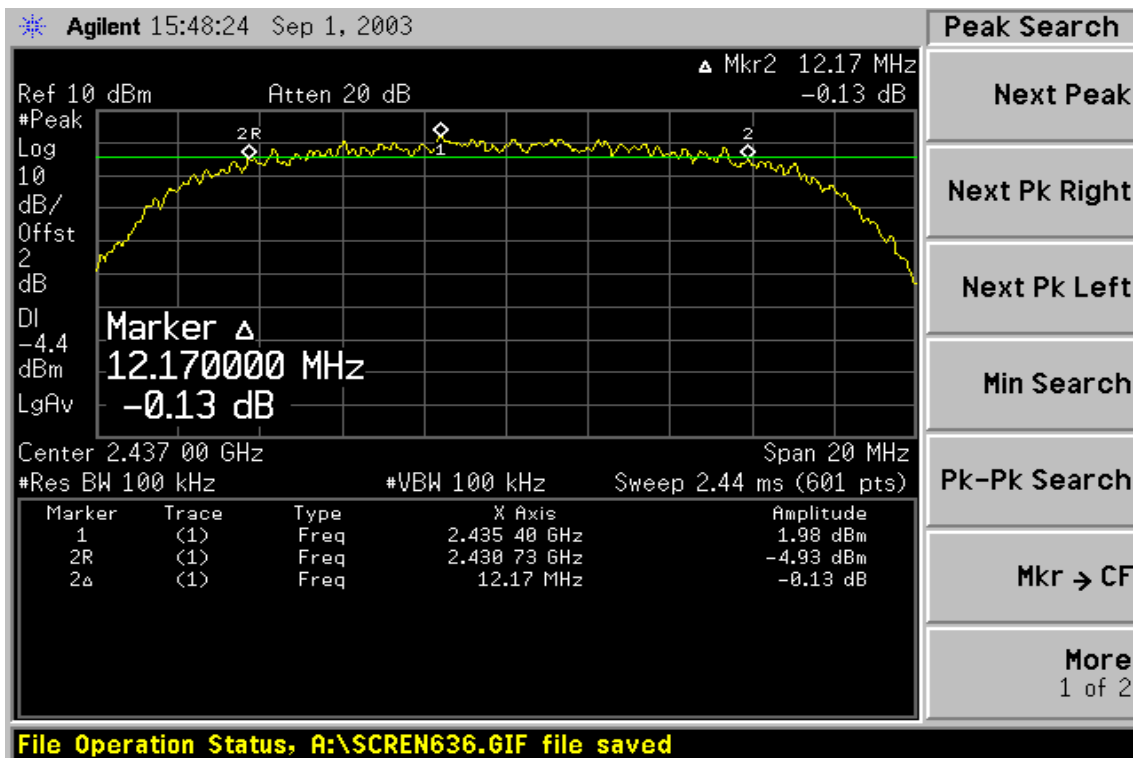



6dB Bandwidth (Ch High)

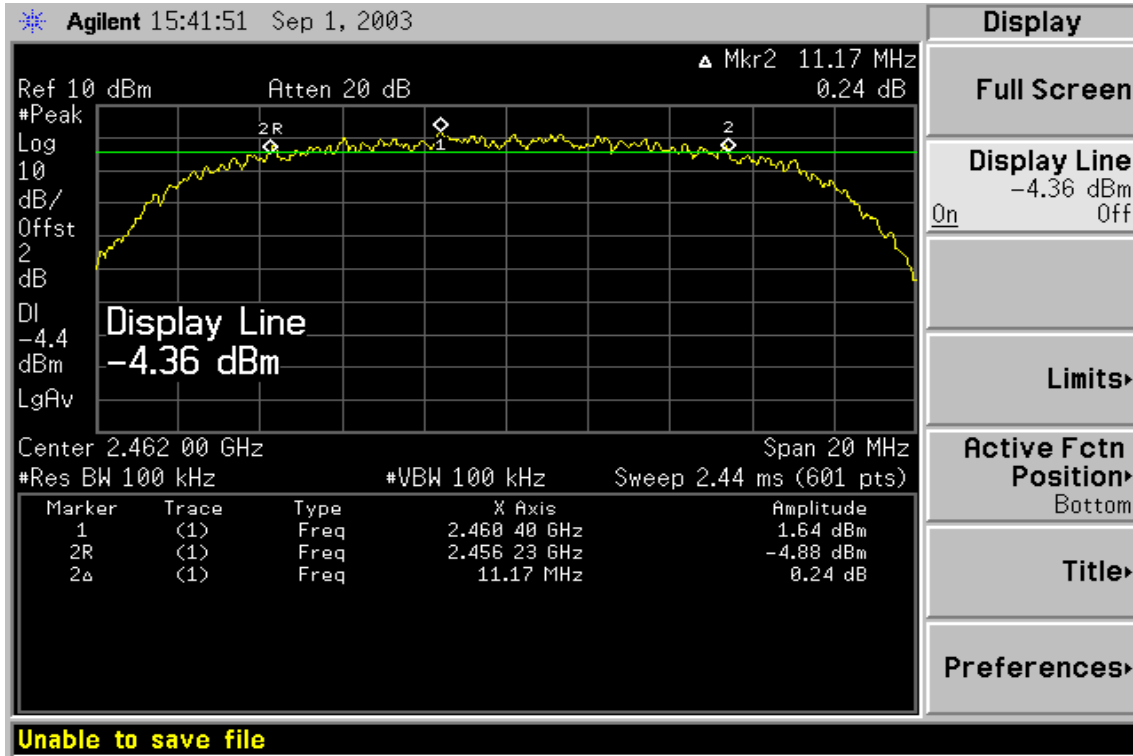



7.2 PEAK POWER

LIMIT

The maximum peak output power of the intentional radiator shall not exceed the following:

1. For systems using digital modulation in the bands of 902-928 MHz, 2400-2483.5 MHz, and 5725-5850 MHz: 1 watt.
2. Except as shown in paragraphs (b)(3) (i), (ii) and (iii) of this section, if transmitting antennas of directional gain greater than 6 dBi are used the peak output power from the intentional radiator shall be reduced below the stated values in paragraphs (b)(1) or (b)(2) of this section, as appropriate, by the amount in dB that the directional gain of the antenna exceeds 6 dBi.

MEASUREMENT EQUIPMENT USED

Name of Equipment	Manufacturer	Model	Serial Number	Calibration Due
Spectrum Analyzer	Agilent	E4446A	US42510252	04/28/2004
Low Loss Cable	Huber + Suhner	Sucoflex 104	N/A	N/A

Remark: Each piece of equipment is scheduled for calibration once a year.

Test Configuration

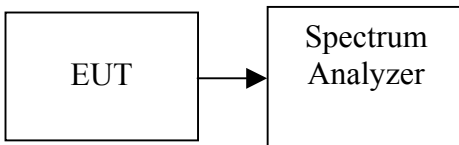

TEST PROCEDURE

The transmitter output is connected to the Spectrum analyzer. The Spectrum analyzer is set to the peak power detection.

TEST RESULTS

No non-compliance noted

Test Data

Channel	Reading Power (dBm)	Factor (dB)	Output Power (dBm)	Output Power (W)	Limit (W)	Result
Low	13.52	2.00	15.52	0.03565	1	PASS
Mid	13.34	2.00	15.34	0.03420	1	PASS
High	13.01	2.00	15.01	0.03170	1	PASS



Test Plot

Peak power (Ch Low)

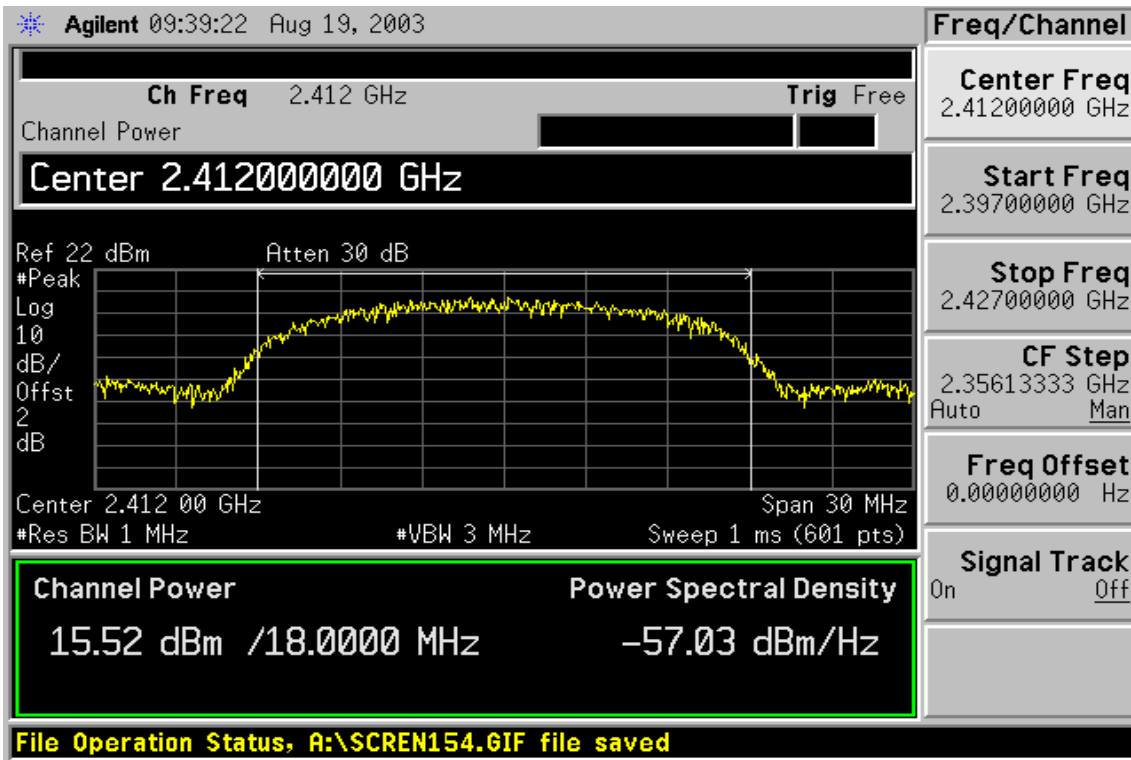

Peak power (Ch Mid)

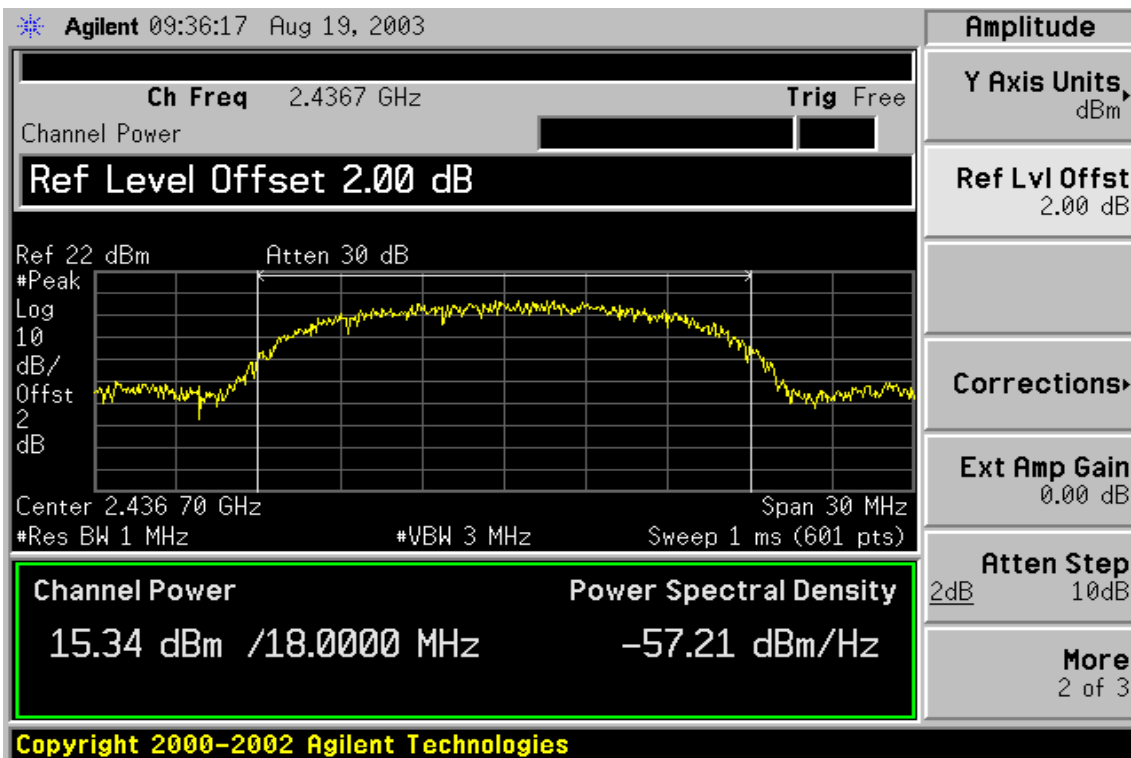



Peak power (Ch High)

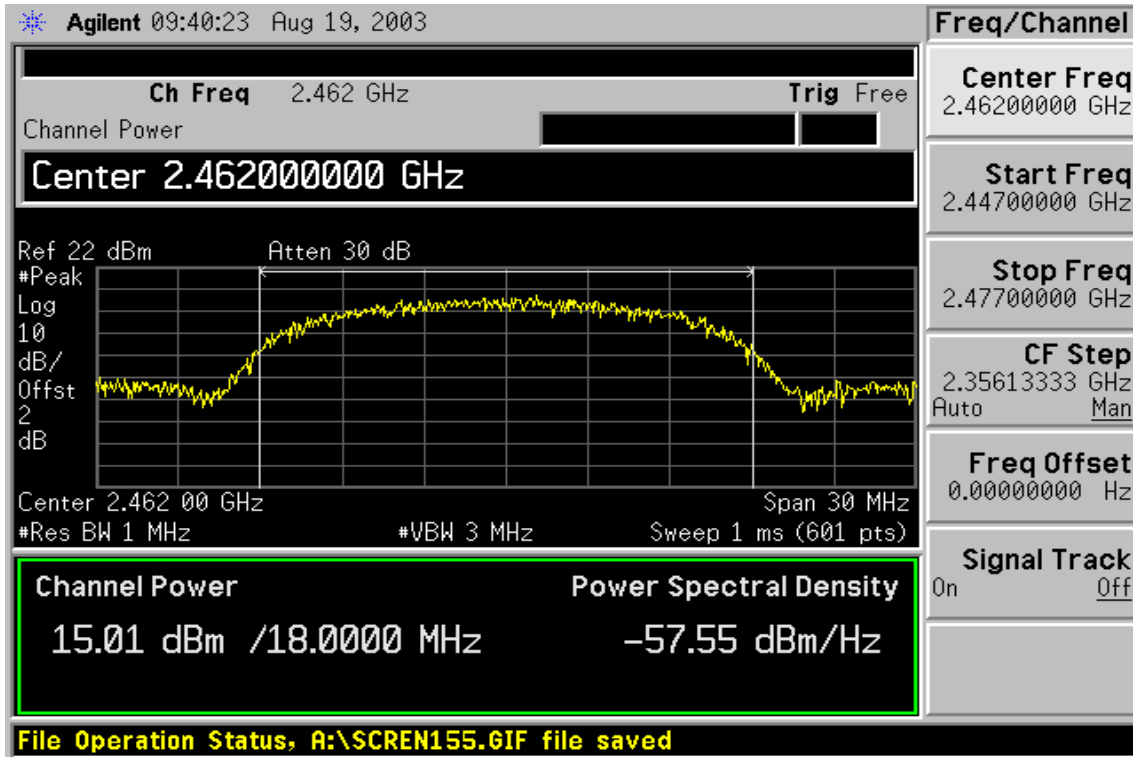

7.3 BAND EDGES MEASUREMENT

LIMIT

According to §15.247(c), in any 100 kHz bandwidth outside the frequency bands in which the spread spectrum intentional radiator is operating, the radio frequency power that is produced by the intentional radiator shall be at least 20dB below that in the 100kHz bandwidth within the band that contains the highest level of the desired power, In addition, radiated emissions which fall in the restricted bands, as defined in §15.205(a), must also comply with the radiated emission limits specified in 15.209(a).

MEASUREMENT EQUIPMENT USED

EQUIPMENT TYPE	MFR	Model No.	Serial Number	Calibration Due
Spectrum Analyzer	Agilent	E4446A	US42510252	04/27/2004
Spectrum Analyzer	R&S	FSP30	1093.4495.30	07/22/2004
Low loss cable	Huber + Suhner	Sucoflex 104	N/A	N/A

TEST CONFIGURATION

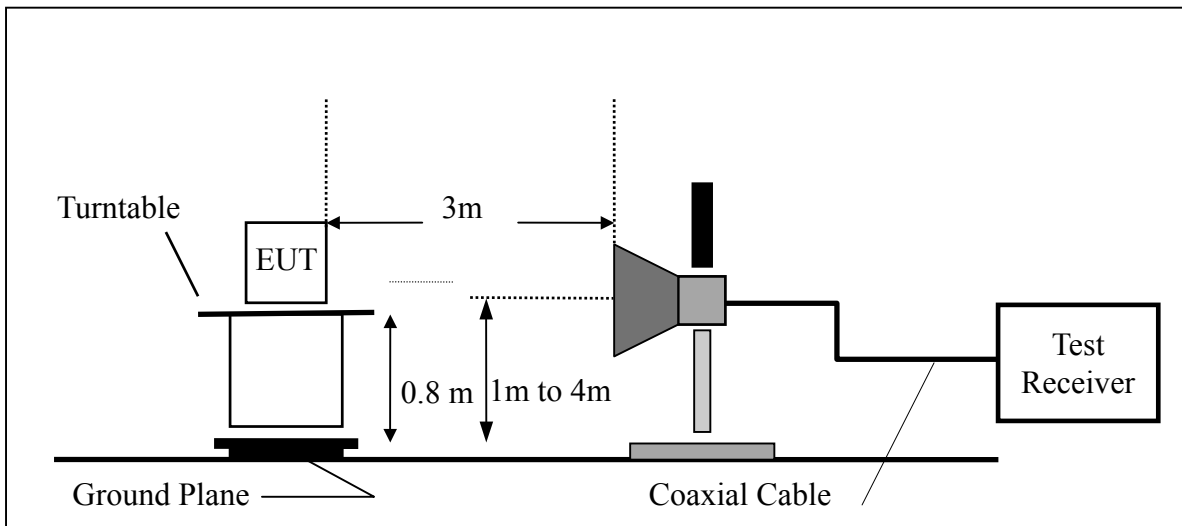

TEST PROCEDURE

1. The EUT is placed on a turntable, which is 0.8m above the ground plane.
2. The turntable shall be rotated for 360 degrees to determine the position of maximum emission level.
3. EUT is set 3m away from the receiving antenna, which is varied from 1m to 4m to find out the highest emission.
4. Set the spectrum analyzer in the following setting in order to capture the lower and upper band-edges of the emission:
 - (a) PEAK: RBW=VBW=1MHz / Sweep=AUTO
 - (b) AVERAGE: RBW=1MHz / VBW=10Hz / Sweep=AUTO
5. Repeat the procedures until all the PEAK and AVERAGE versus POLARIZATION are measured.

TEST RESULTS

Refer to attach spectrum analyzer data chart.



Band Edges (CH-Low)

Detector mode: Peak

Polarity: Vertical

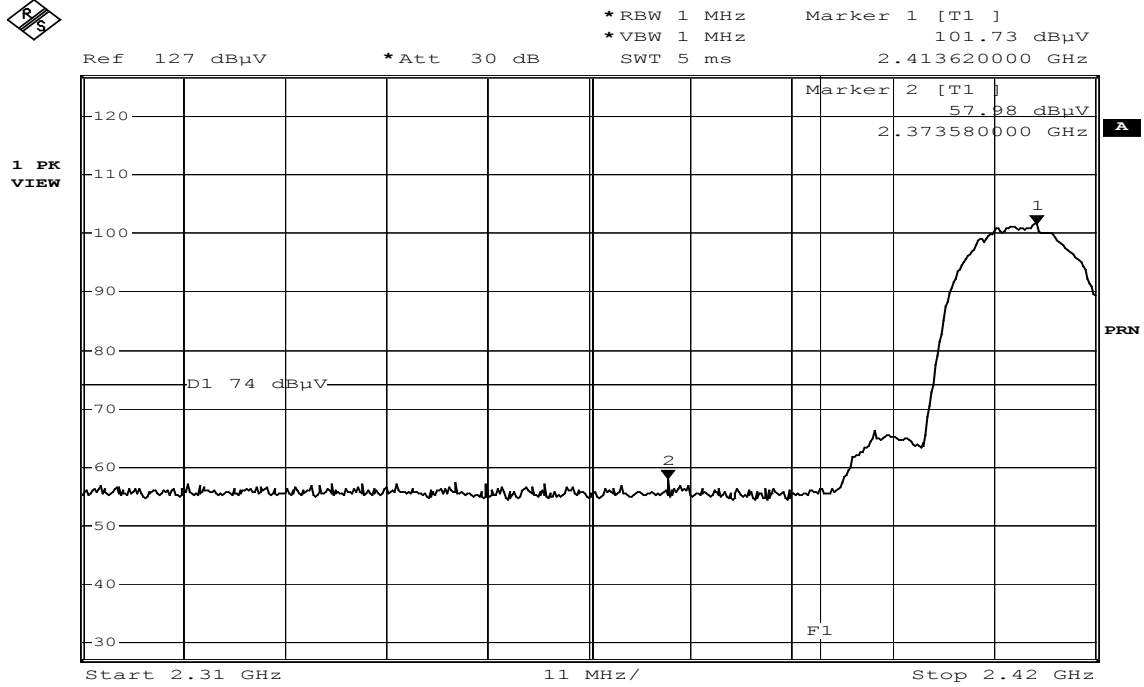

Date: 16.SEP.2003 13:21:22

Detector mode: Average

Polarity: Vertical

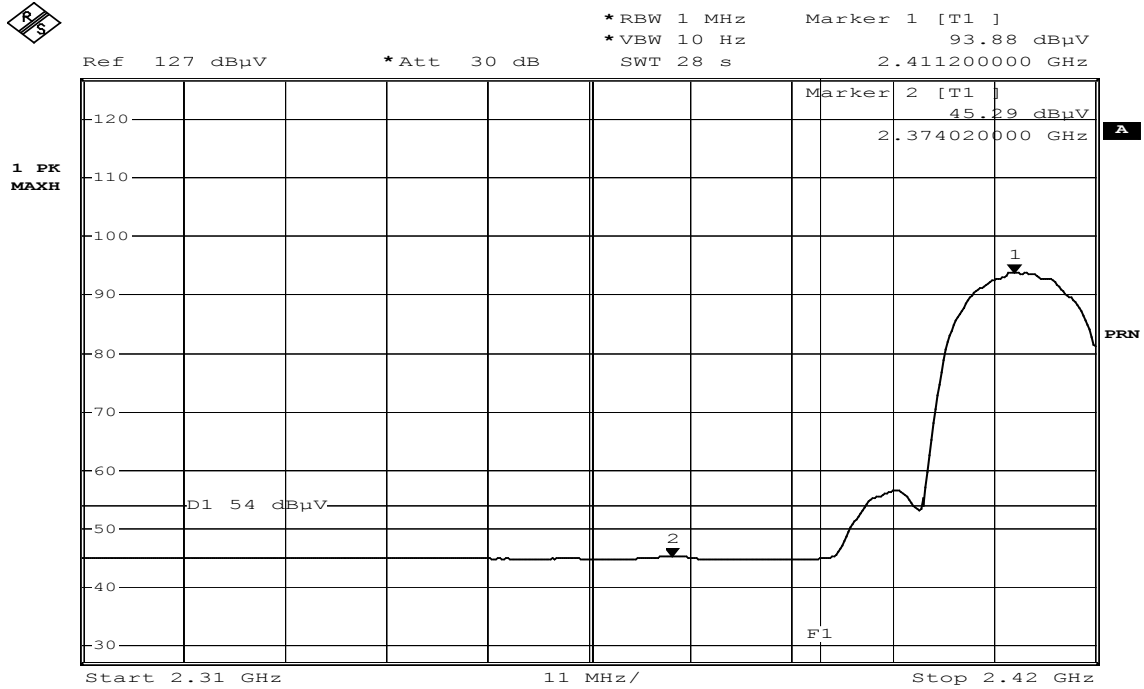

Date: 16.SEP.2003 13:19:34



Detector mode: Peak

Polarity: Horizontal

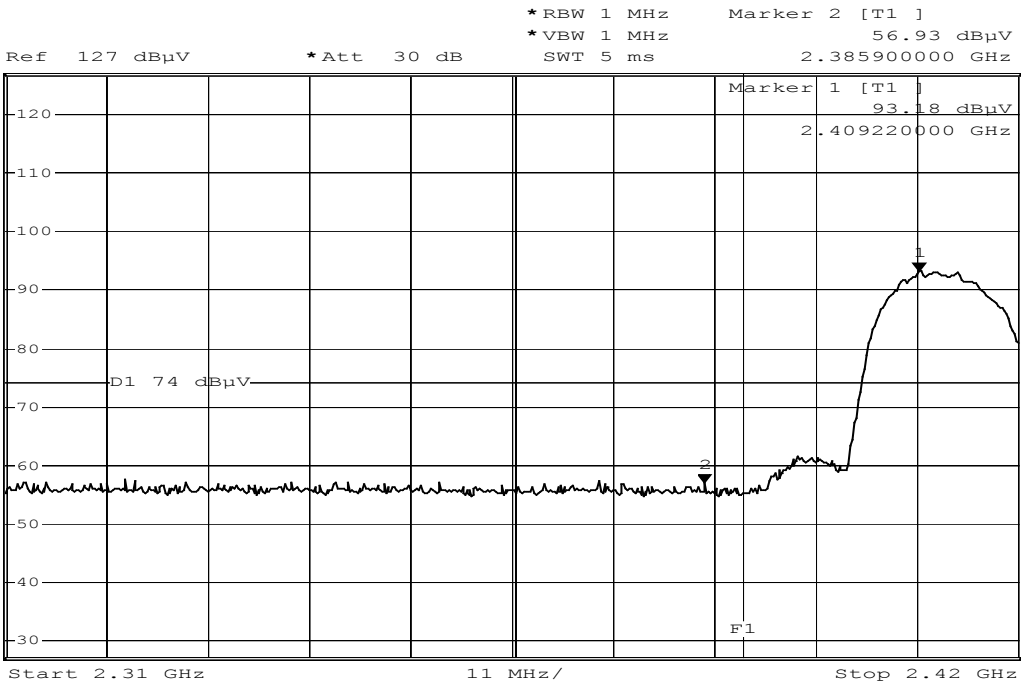

Date: 16.SEP.2003 13:27:41

Detector mode: Average

Polarity: Horizontal

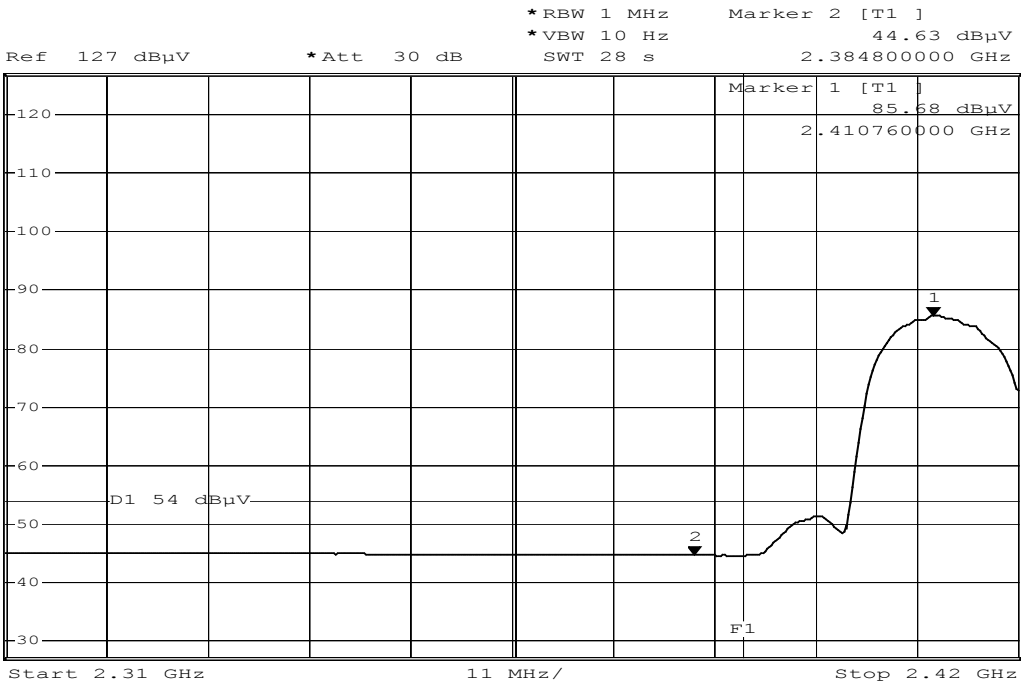

Date: 16.SEP.2003 13:26:12



Band Edges (CH-High)

Detector mode: Peak

Polarity: Vertical

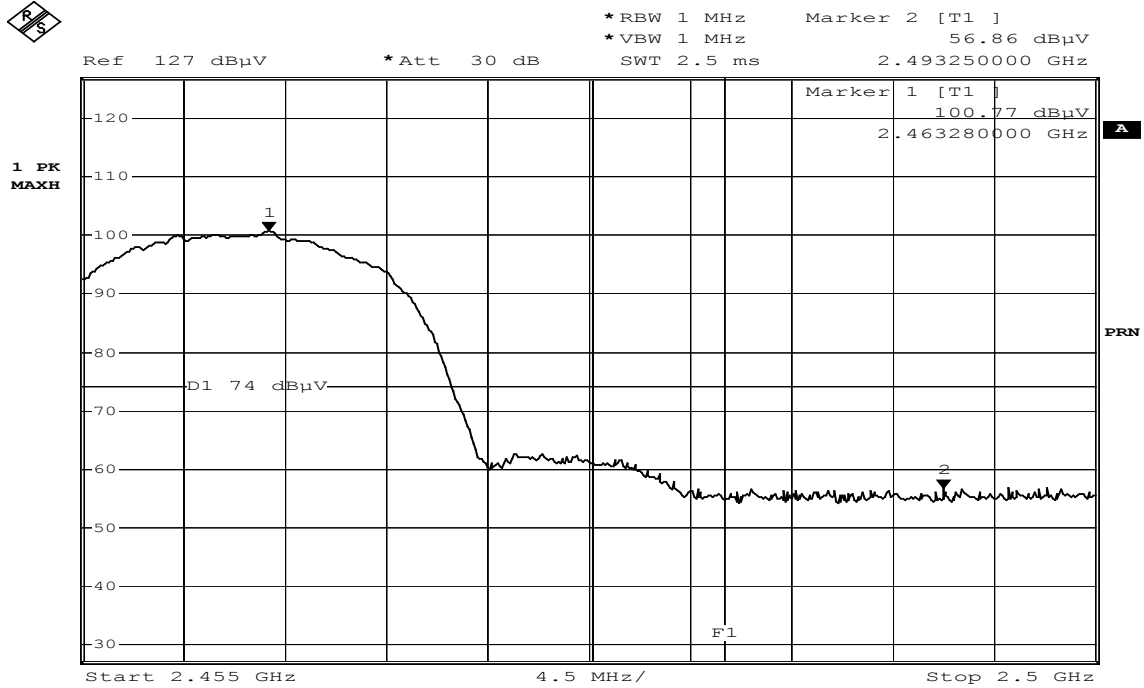

Date: 16.SEP.2003 13:12:36

Detector mode: Average

Polarity: Vertical

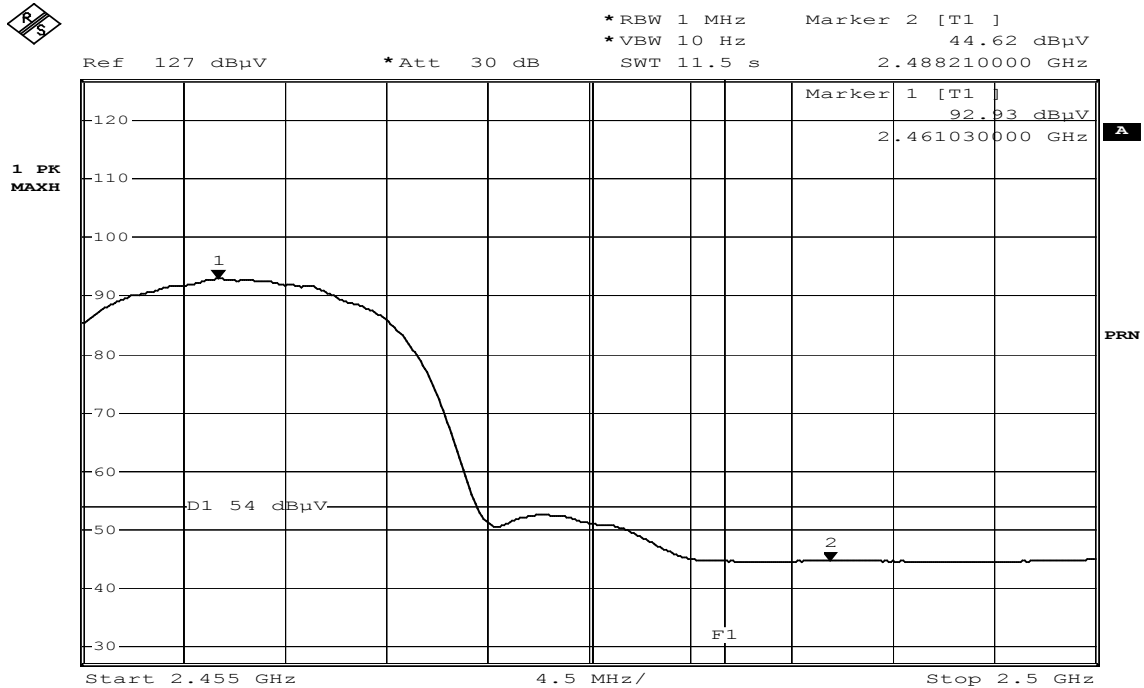

Date: 16.SEP.2003 13:11:25



Detector mode: Peak

Polarity: Horizontal

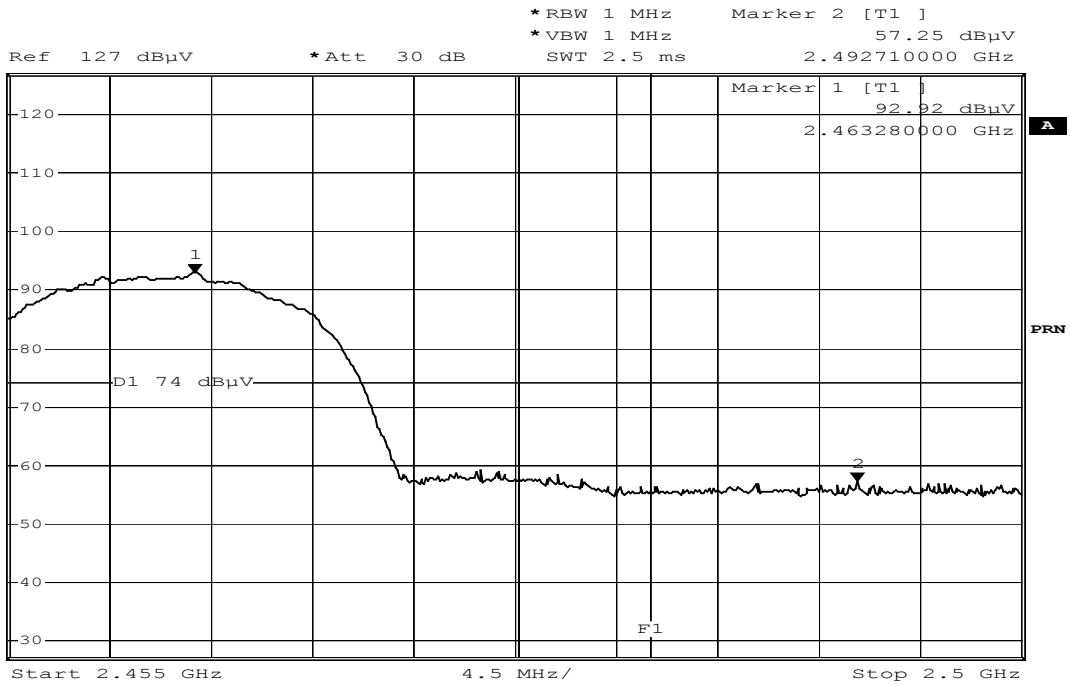

Date: 16.SEP.2003 13:05:29

Detector mode: Average

Polarity: Horizontal

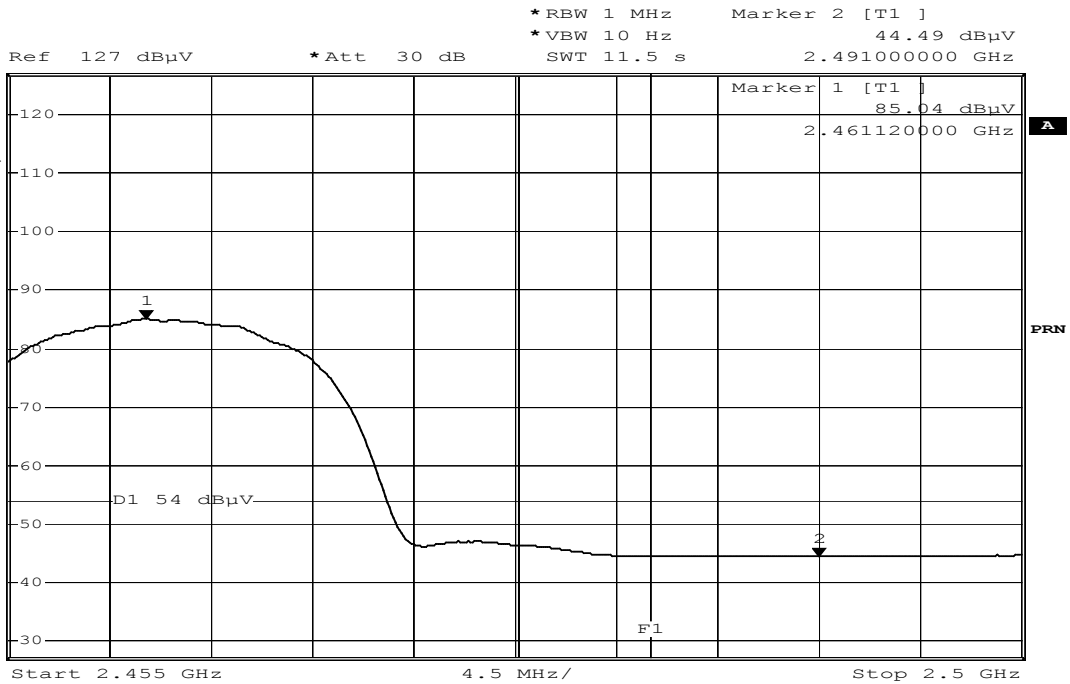

Date: 16.SEP.2003 13:06:54



7.4 PEAK POWER SPECTRAL DENSITY

LIMIT

1. For direct sequence systems, the peak power spectral density conducted from the intentional radiator to the antenna shall not be greater than 8dBm in any 3kHz band during any time interval of continuous transmission.
2. The direct sequence operating of the hybrid system, with the frequency hopping operation turned off, shall comply with the power density requirements of paragraph (d) of this section.

MEASUREMENT EQUIPMENT USED

Name of Equipment	Manufacturer	Model	Serial Number	Calibration Due
Spectrum Analyzer	Agilent	E4446A	US42510252	04/28/2004
Low loss Cable	Huber + Suhner	Sucoflex 104	N/A	N/A

Remark: Each piece of equipment is scheduled for calibration once a year.

Test Configuration

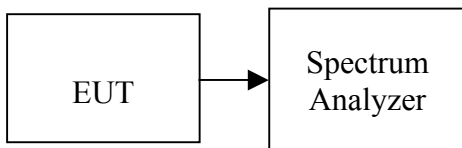

TEST PROCEDURE

1. Place the EUT on the table and set it in transmitting mode.
Remove the antenna from the EUT and then connect a low loss RF cable from the antenna port to the spectrum analyzer.
2. Set the spectrum analyzer as RBW = 3kHz, VBW = 10kHz, Span = 300kHz, Sweep=100s
3. Record the max. reading.
4. Repeat the above procedure until the measurements for all frequencies are completed.

TEST RESULTS

No non-compliance noted

Test Data

Channel	Reading (dBm)	Factor (dB)	PPSD (dBm)	Limit (dBm)	Result
Low	-13.79	2.00	-11.79	8.00	PASS
Mid	-16.75	2.00	-14.75		PASS
High	-17.06	2.00	-15.06		PASS



Test Plot

PPSD (Ch Low)

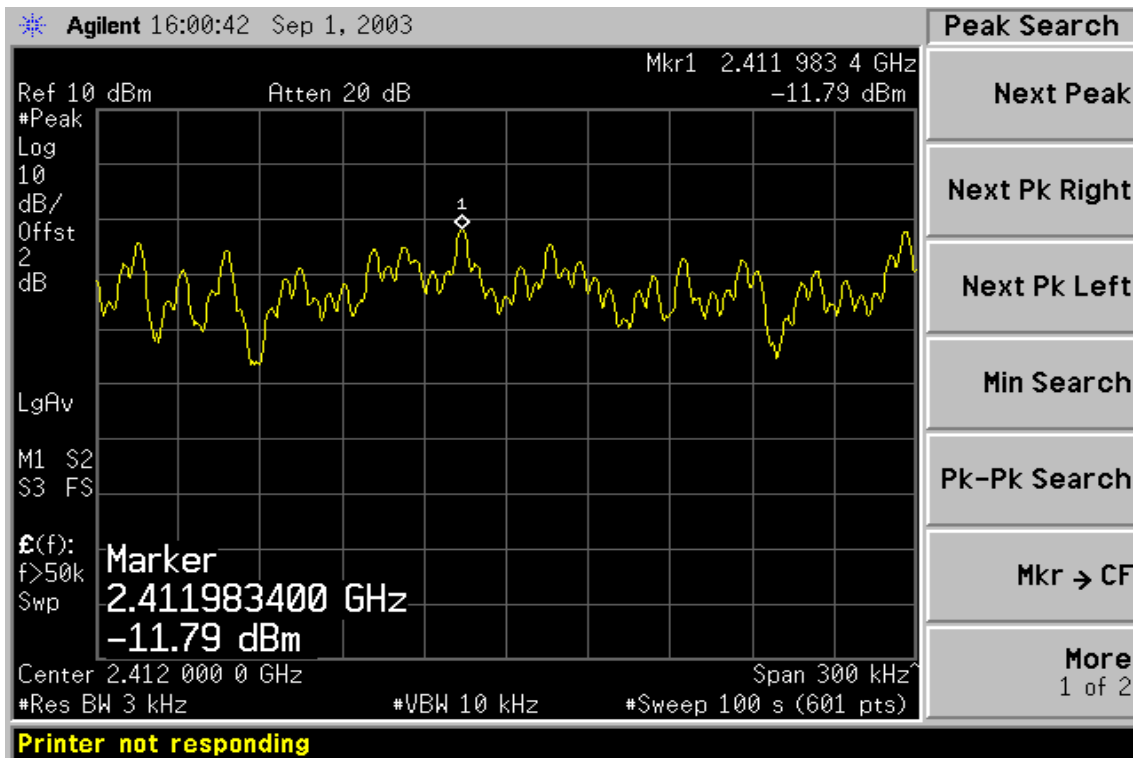

PPSD (Ch Mid)

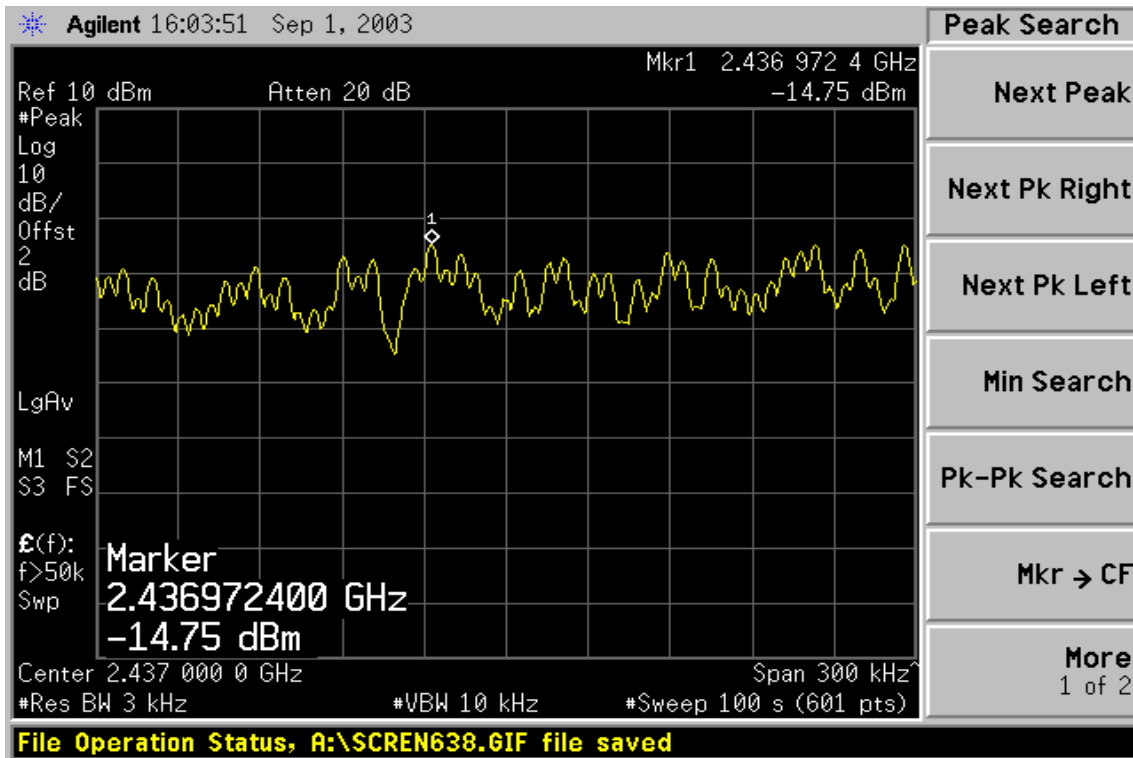



PPSD (Ch High)

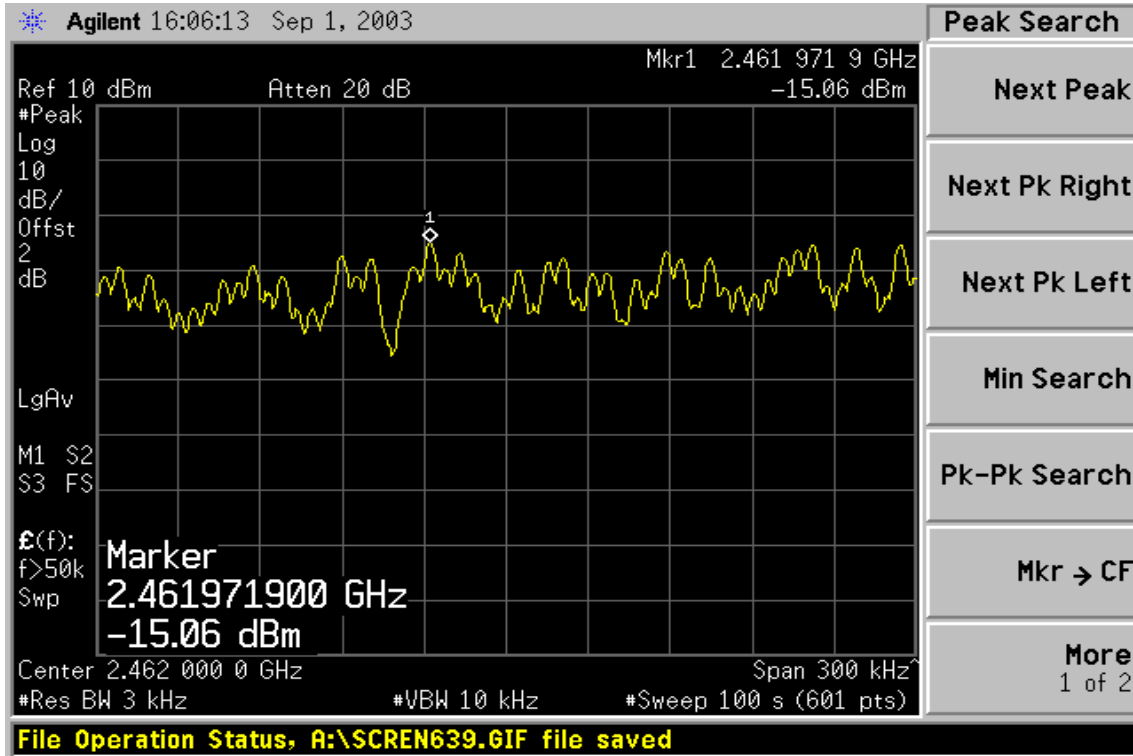



7.5 RADIO FREQUENCY EXPOSURE

LIMIT

Systems operating under the provisions of this section shall be operated in a manner that ensures that the public is not exposed to radio frequency energy levels in excess of the Commission's guidelines. See §15.247(b)(4) and §1.1307(b)(1) of this chapter.

EUT Specification

EUT	Tablet PC
Frequency band (Operating)	<input checked="" type="checkbox"/> WLAN: 2.412GHz ~ 2.462GHz <input type="checkbox"/> WLAN: 5.18GHz ~ 5.32GHz / 5.50GHz ~ 5.70GHz <input type="checkbox"/> WLAN: 5.745GHz ~ 5825GHz <input type="checkbox"/> Others _____
Device category	<input checked="" type="checkbox"/> Portable (<20cm separation) <input type="checkbox"/> Mobile (>20cm separation) <input type="checkbox"/> Others _____
Exposure classification	<input type="checkbox"/> Occupational/Controlled exposure ($S = 5mW/cm^2$) <input checked="" type="checkbox"/> General Population/Uncontrolled exposure ($S=1mW/cm^2$)
Antenna diversity	<input type="checkbox"/> Single antenna <input checked="" type="checkbox"/> Multiple antennas <input type="checkbox"/> TX diversity <input type="checkbox"/> RX diversity <input checked="" type="checkbox"/> TX/RX diversity
Max. output power	15.52 dBm (35.645mW)
Antenna gain (Max)	0.11 dBi (Numeric gain: 1.025)
Evaluation applied	<input type="checkbox"/> MPE Evaluation* <input checked="" type="checkbox"/> SAR Evaluation

Note:

- *The maximum output power is 15.52Bm(35.645mW) at 2412MHz, which is higher than general population high threshold $60/F$ ($60/2437=24.62mW$). SAR is required.
- For mobile or fixed location transmitters, the minimum separation distance is 20 cm, even if calculations indicate that the MPE distance would be less.

TEST RESULTS

Note: Please refer to the separate SAR report.



CONDITION B: BLUETOOTH OPERATION

7.6 PEAK POWER

LIMIT

The maximum peak output power of the intentional radiator shall not exceed the following:

1. For systems using digital modulation in the bands of 902-928 MHz, 2400-2483.5 MHz, and 5725-5850 MHz: 1 watt.
2. Except as shown in paragraphs (b)(3) (i), (ii) and (iii) of this section, if transmitting antennas of directional gain greater than 6 dBi are used the peak output power from the intentional radiator shall be reduced below the stated values in paragraphs (b)(1) or (b)(2) of this section, as appropriate, by the amount in dB that the directional gain of the antenna exceeds 6 dBi.

MEASUREMENT EQUIPMENT USED

Name of Equipment	Manufacturer	Model	Serial Number	Calibration Due
Spectrum Analyzer	Agilent	E4446A	US42510252	04/28/2004
Low Loss Cable	Huber + Suhner	Sucoflex 104	N/A	N/A

Remark: Each piece of equipment is scheduled for calibration once a year.

Test Configuration

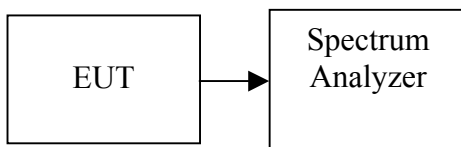

TEST PROCEDURE

The transmitter output is connected to the Spectrum analyzer. The Spectrum analyzer is set to the peak power detection.

TEST RESULTS

No non-compliance noted

Test Data

Channel	Reading Power (dBm)	Cable Loss (dB)	Output Power (dBm)	Output Power (W)	Limit (W)	Result
Low	-2.29	1.75	-0.54	0.00088	1	PASS
Mid	-1.78	1.75	-0.03	0.00099	1	PASS
High	-2.01	1.75	-0.26	0.00094	1	PASS



Test Plot

Peak power (Ch Low)

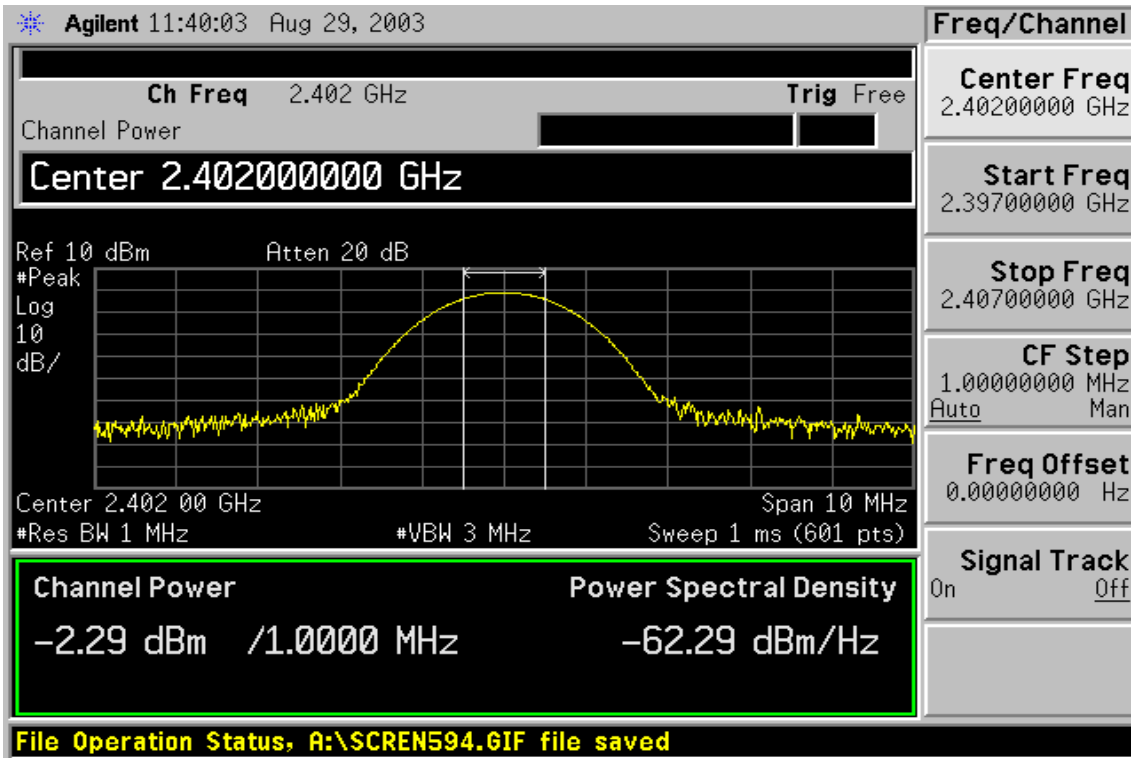

Peak power (Ch Mid)

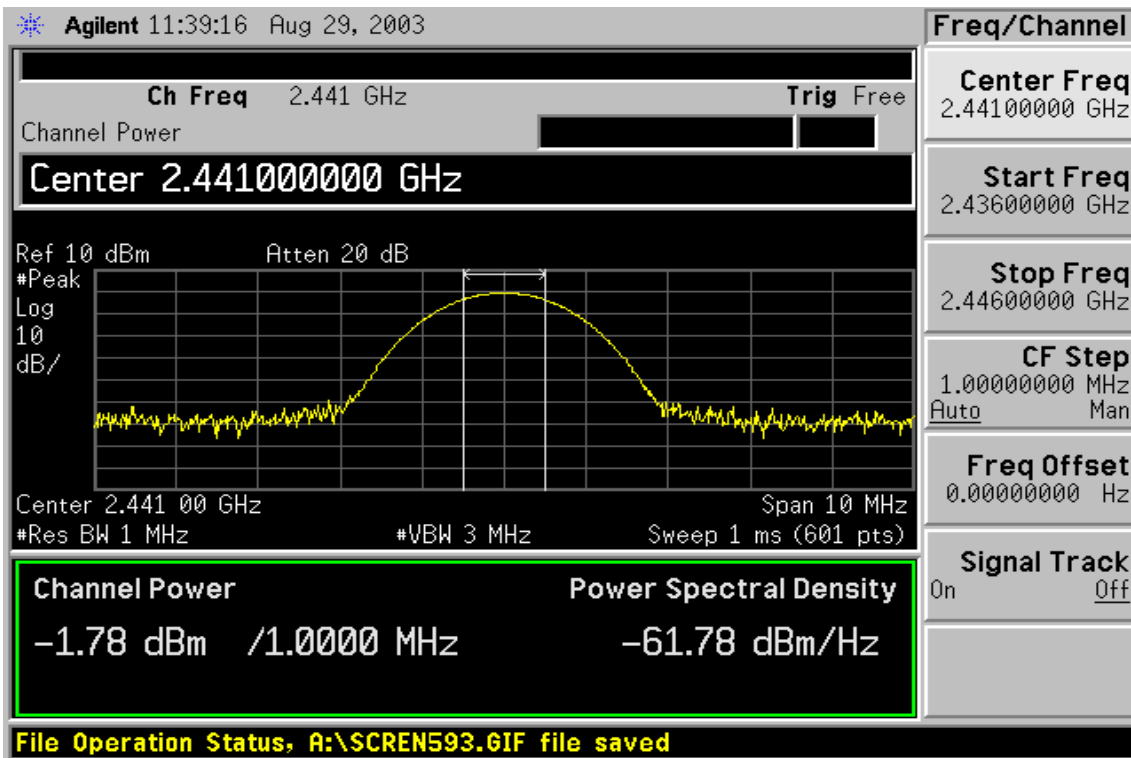



Peak power (Ch High)

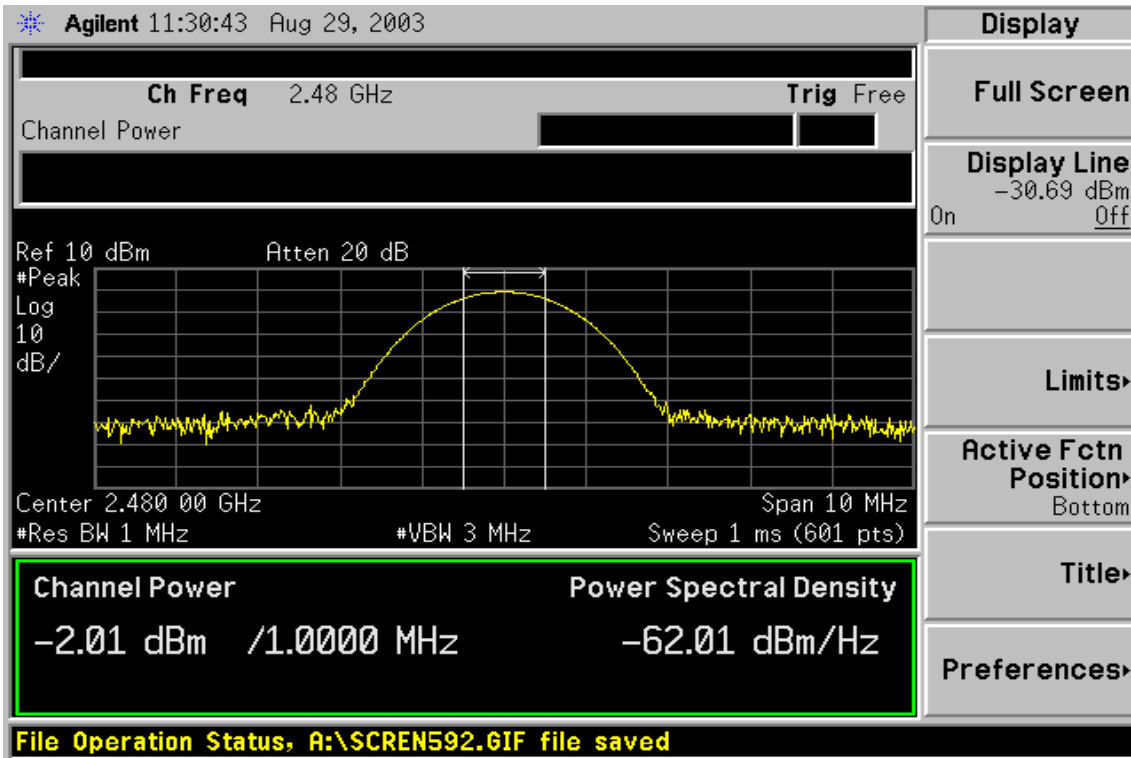

7.7 BAND EDGES MEASUREMENT

LIMIT

According to §15.247(c), in any 100 kHz bandwidth outside the frequency bands in which the spread spectrum intentional radiator is operating, the radio frequency power that is produced by the intentional radiator shall be at least 20dB below that in the 100kHz bandwidth within the band that contains the highest level of the desired power. In addition, radiated emissions which fall in the restricted bands, as defined in §15.205(a), must also comply with the radiated emission limits specified in 15.209(a).

MEASUREMENT EQUIPMENT USED

Name of Equipment	Manufacturer	Model	Serial Number	Calibration Due
Spectrum Analyzer	Agilent	E4446A	US42510252	04/27/2004
Spectrum Analyzer	R&S	FSP30	1093.4495.30	07/22/2004
Low Loss Cable	Huber + Suhner	Sucoflex 104	N/A	N/A

TEST CONFIGURATION

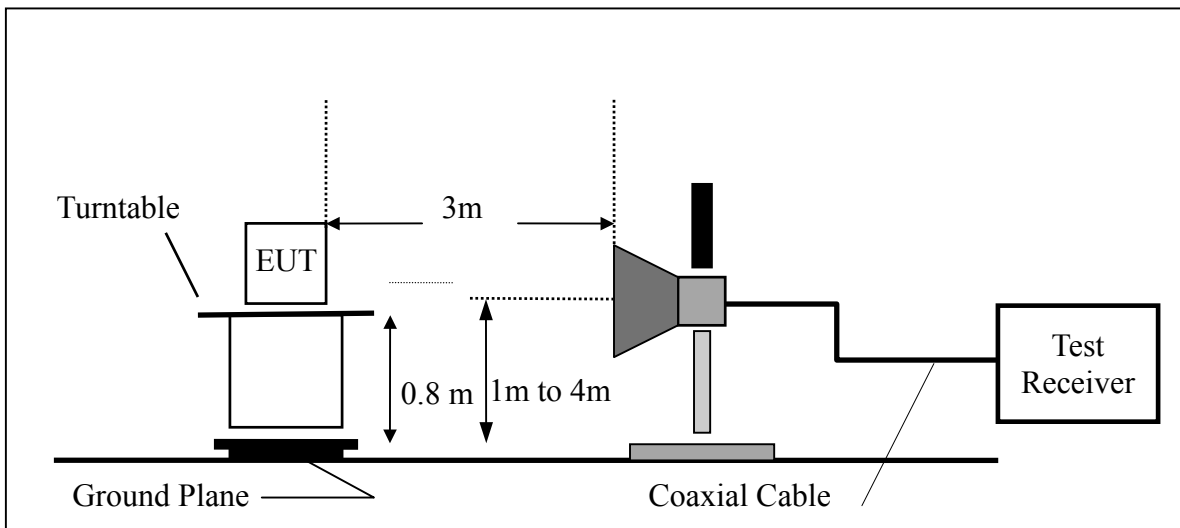

TEST PROCEDURE

1. The EUT is placed on a turntable, which is 0.8m above the ground plane.
2. The turntable shall be rotated for 360 degrees to determine the position of maximum emission level.
3. EUT is set 3m away from the receiving antenna, which is varied from 1m to 4m to find out the highest emission.
4. Set the spectrum analyzer in the following setting in order to capture the lower and upper band-edges of the emission:
 - (a) PEAK: RBW=VBW=1MHz / Sweep=AUTO
 - (b) AVERAGE: RBW=1MHz / VBW=10Hz / Sweep=AUTO
5. Repeat the procedures until all the PEAK and AVERAGE versus POLARIZATION are measured.

TEST RESULTS

Refer to attach spectrum analyzer data chart.



Band Edges Test Data (CH-Low)

Detector mode: Peak

Polarity: Vertical

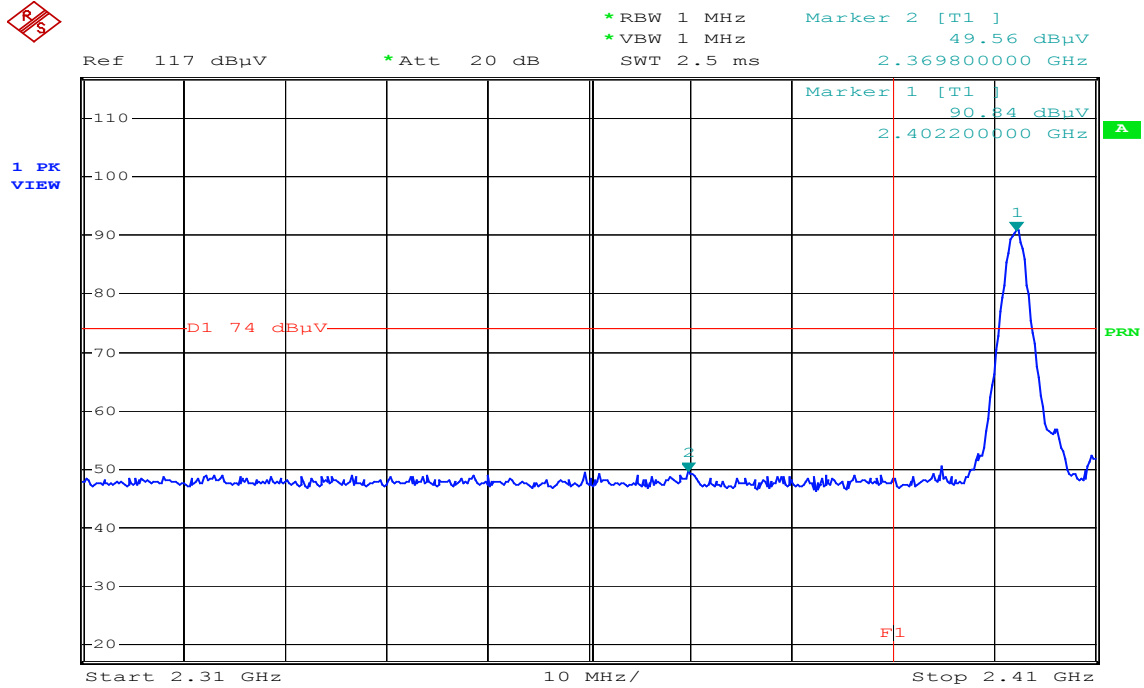

Date: 5.SEP.2003 05:35:34

Detector mode: Average

Polarity: Vertical

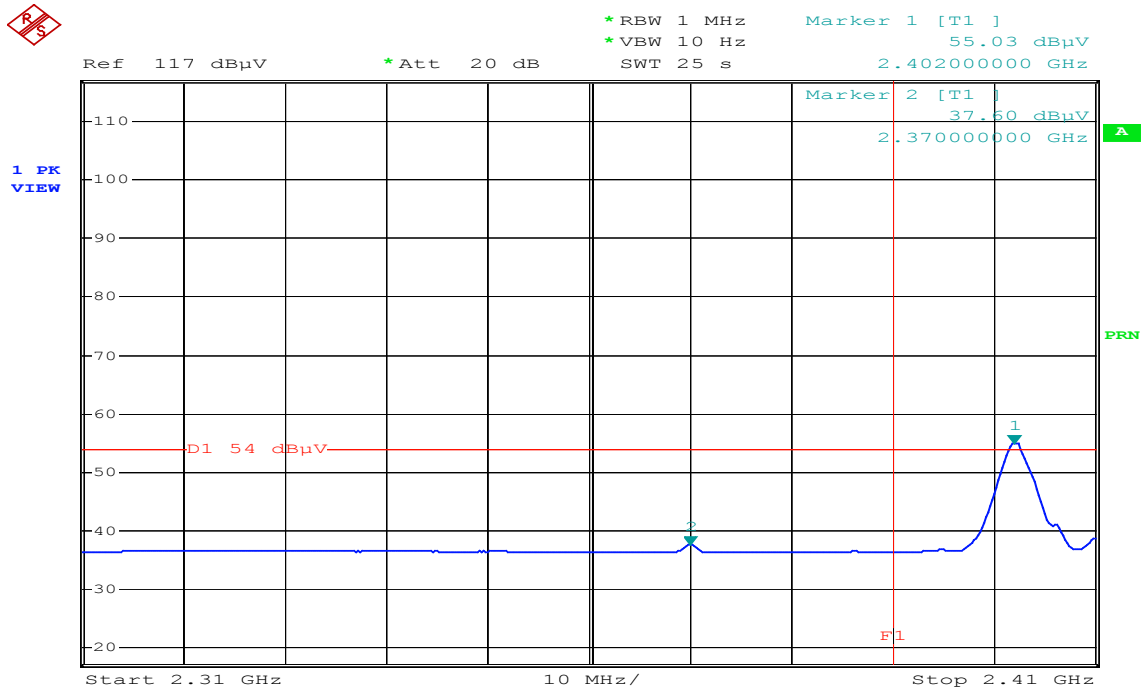

Date: 5.SEP.2003 05:37:06



Detector mode: Peak

Polarity: Horizontal

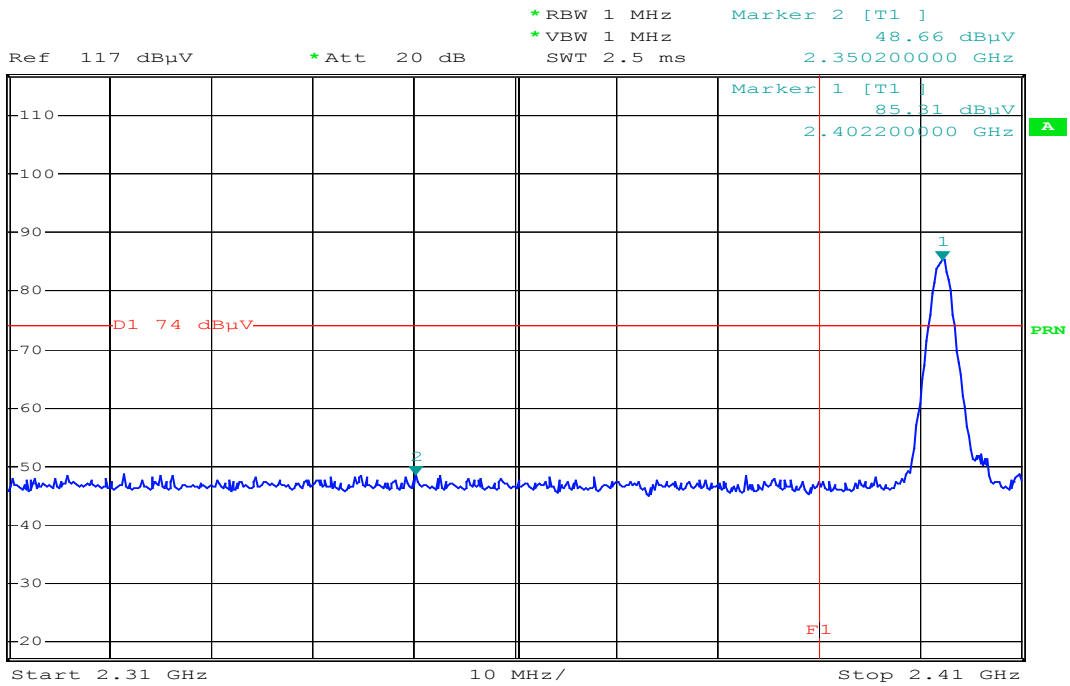

Date: 5.SEP.2003 05:41:38

Detector mode: Average

Polarity: Horizontal

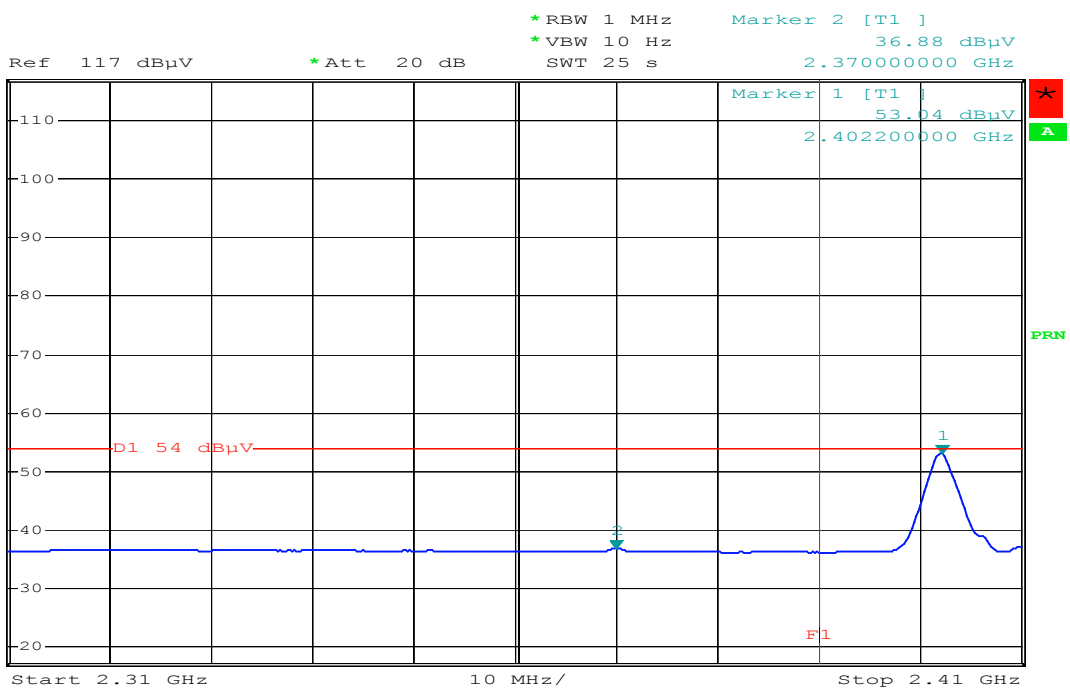

Date: 5.SEP.2003 05:43:02



Band Edges Test Data (CH-High)

Detector mode: Peak

Polarity: Vertical

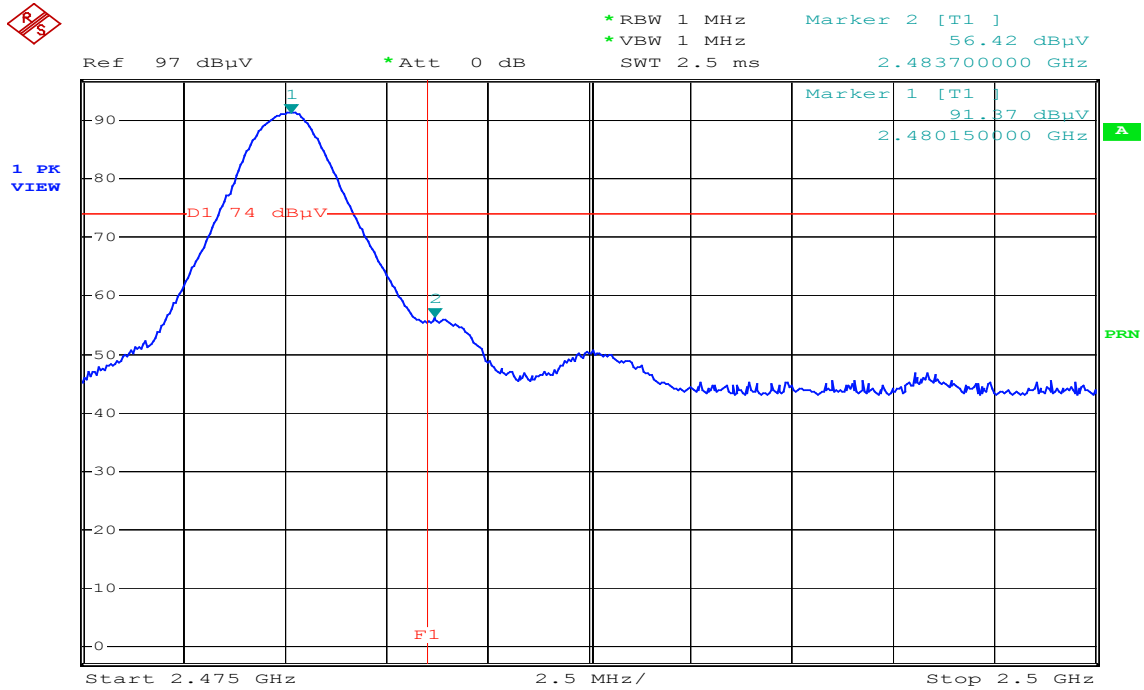

Date: 5.SEP.2003 05:22:09

Detector mode: Average

Polarity: Vertical

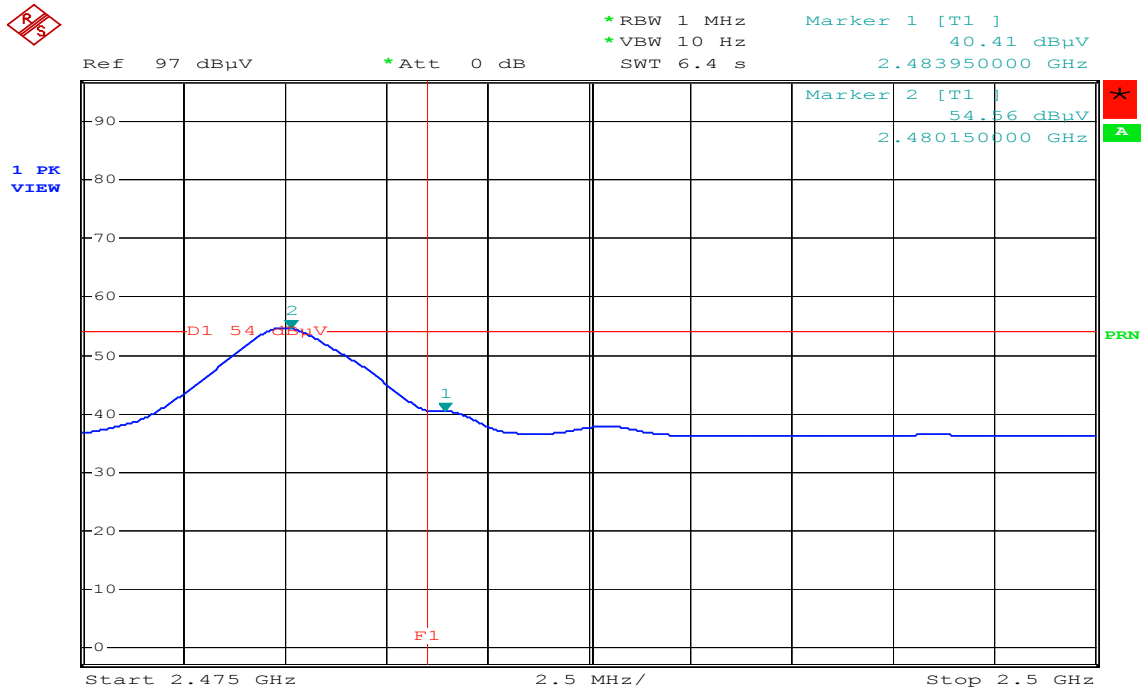

Date: 5.SEP.2003 05:50:45



Detector mode: Peak

Polarity: Horizontal

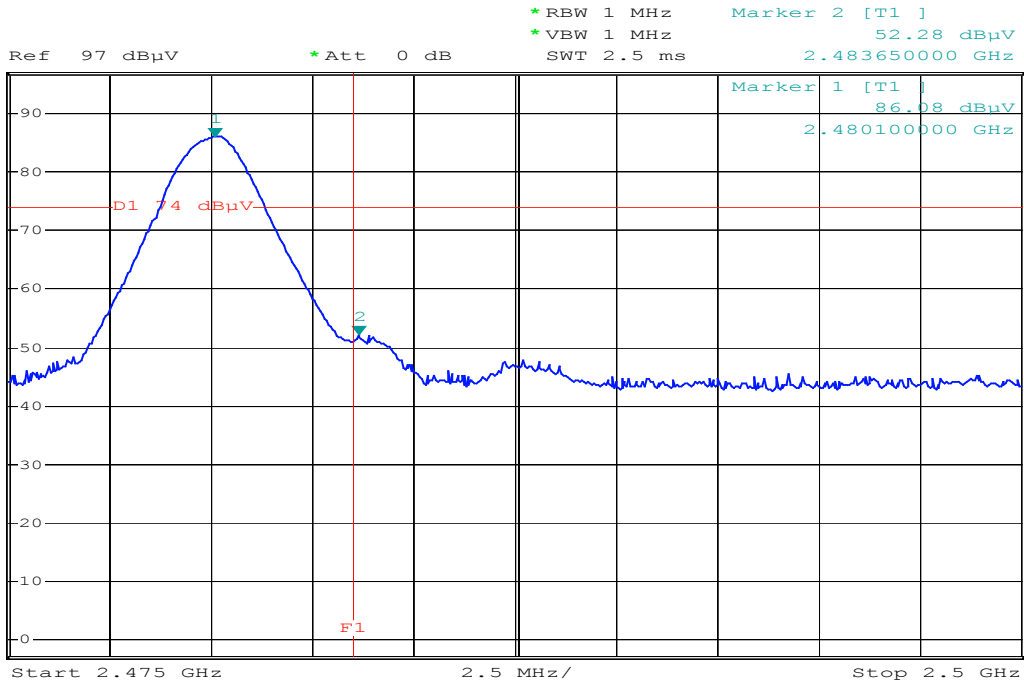

Date: 5.SEP.2003 05:16:41

Detector mode: Average

Polarity: Horizontal

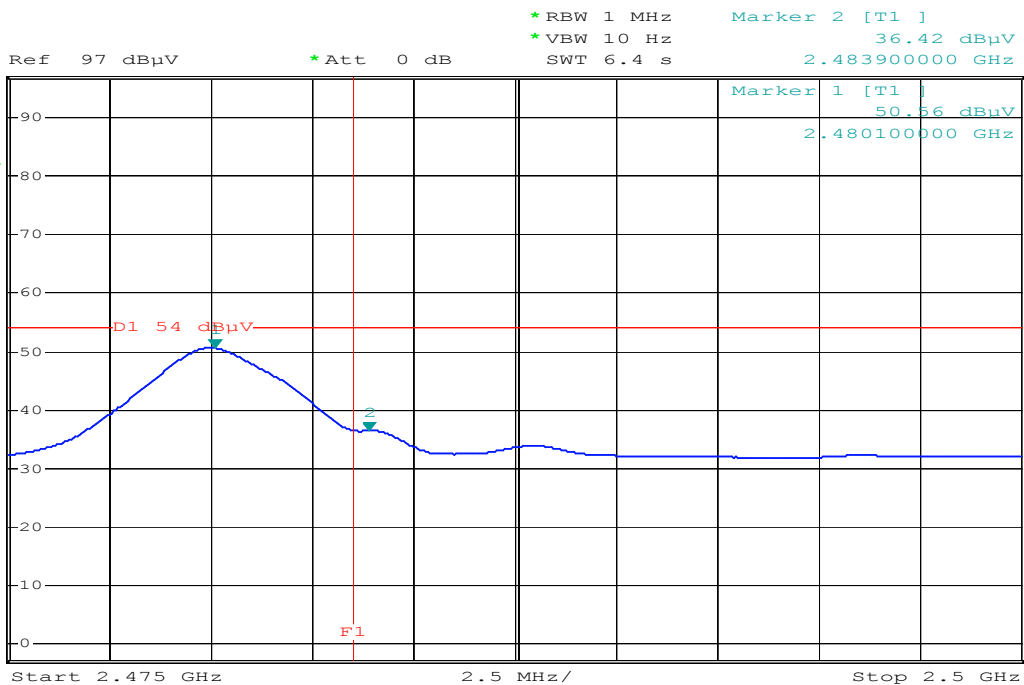

Date: 5.SEP.2003 05:18:06



7.8 PEAK POWER SPECTRAL DENSITY

LIMIT

1. For direct sequence systems, the peak power spectral density conducted from the intentional radiator to the antenna shall not be greater than 8dBm in any 3kHz band during any time interval of continuous transmission.
2. The direct sequence operating of the hybrid system, with the frequency hopping operation turned off, shall comply with the power density requirements of paragraph (d) of this section.

MEASUREMENT EQUIPMENT USED

Name of Equipment	Manufacturer	Model	Serial Number	Calibration Due
Spectrum Analyzer	Agilent	E4446A	US42510252	04/28/2004
Spectrum Analyzer	R&S	FSP30	1093.4495.30	07/22/2004
Low-loss Cable	Huber + Suhner	Sucoflex 104	N/A	N/A

Remark: Each piece of equipment is scheduled for calibration once a year.

Test Configuration

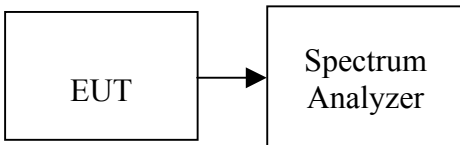

TEST PROCEDURE

1. Place the EUT on the table and set it in transmitting mode.
2. Remove the antenna from the EUT and then connect a low loss RF cable from the antenna port to the spectrum analyzer.
3. Set the spectrum analyzer as RBW = 3kHz, VBW = 10kHz, Span = 300kHz, Sweep=100s
4. Record the max. reading.
5. Repeat the above procedure until the measurements for all frequencies are completed.

TEST RESULTS

No non-compliance noted

Test Data

Channel	Reading (dBm)	Cable Loss (dB)	PPSD (dBm)	Limit (dBm)	Result
Low	-12.08	1.75	-10.33	8.00	PASS
Mid	-11.72	1.75	-9.97		PASS
High	-11.76	1.75	-10.01		PASS



Test Plot

PPSD (Ch Low)

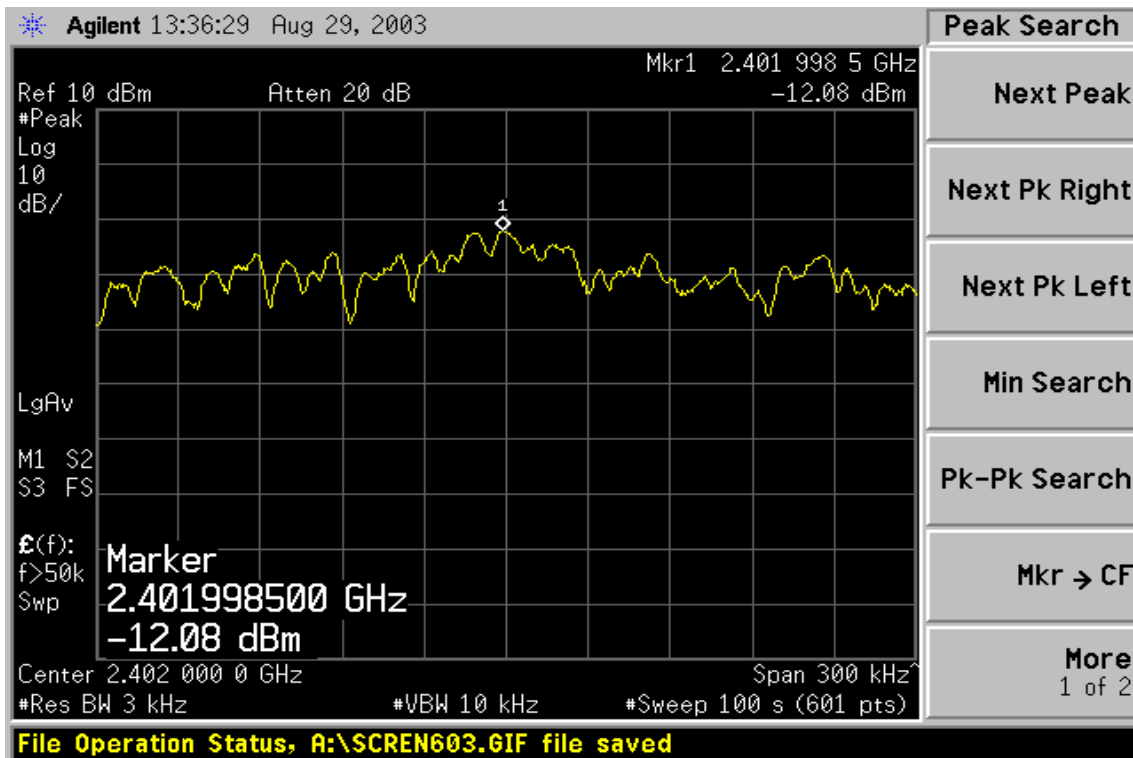

PPSD (Ch Mid)

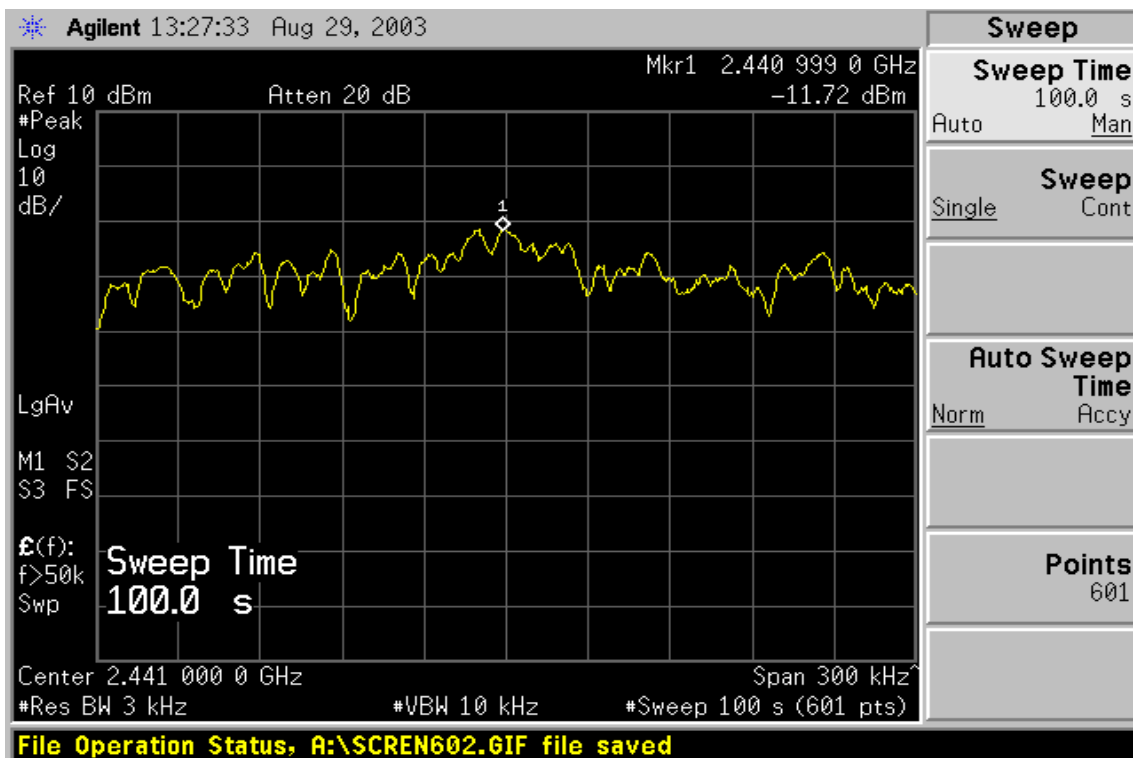



PPSD (Ch High)

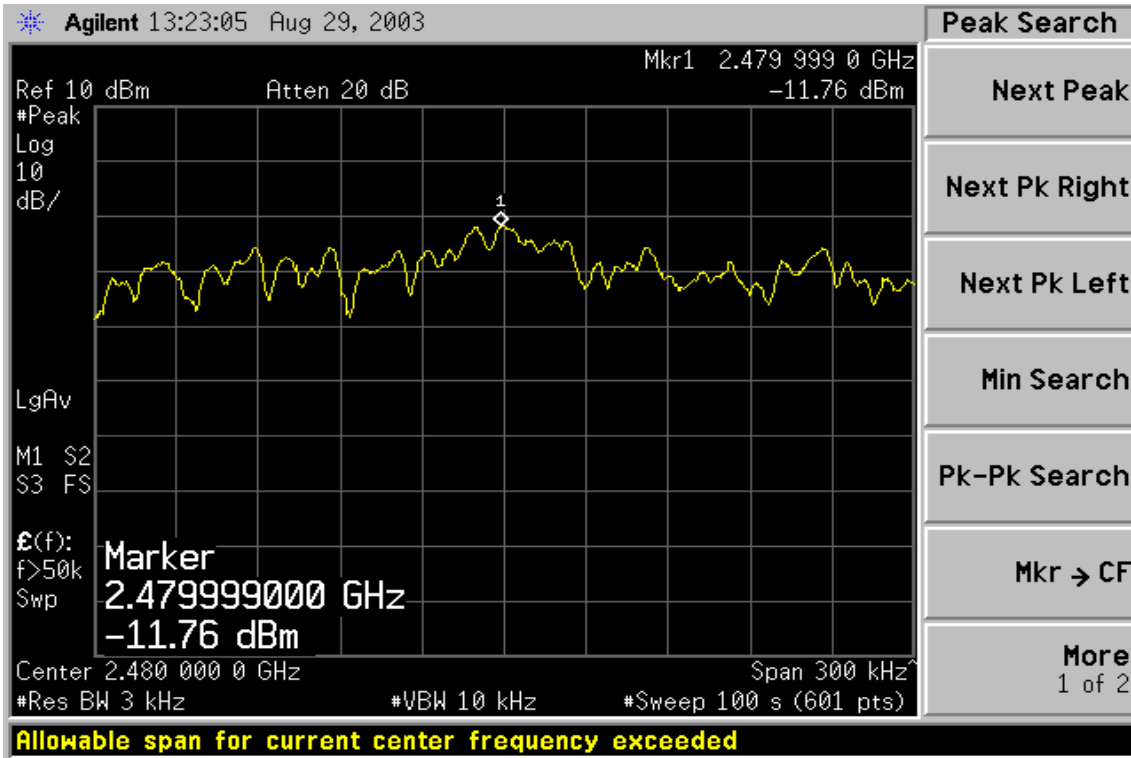



7.9 FREQUENCY SEPARATION

LIMIT

According to §15.247(a)(1), Frequency hopping systems shall have hopping channel carrier frequencies separated by minimum of 25kHz or the 20dB bandwidth of the hopping channel, whichever is greater.

MEASUREMENT EQUIPMENT USED

Name of Equipment	Manufacturer	Model	Serial Number	Calibration Due
Spectrum Analyzer	Agilent	E4446A	US42510252	04/28/2004
Spectrum Analyzer	R&S	FSP30	1093.4495.30	07/22/2004
Low-loss Cable	Huber + Suhner	Sucoflex 104	N/A	N/A

Remark: Each piece of equipment is scheduled for calibration once a year.

Test Configuration

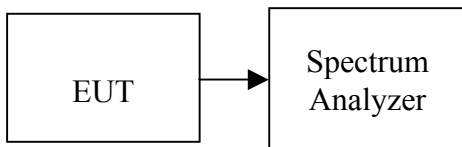

TEST PROCEDURE

1. Place the EUT on the table and set it in transmitting mode.
2. Remove the antenna from the EUT and then connect a low loss RF cable from the antenna port to the spectrum analyzer.
3. Set center frequency of spectrum analyzer = middle of hopping channel.
4. Set the spectrum analyzer as RBW, VBW=100kHz, Adjust Span to 4.0 MHz, Sweep = auto.
5. Max hold. Mark 3 Peaks of hopping channel and record the 3 peaks frequency.

TEST RESULTS

No non-compliance noted

Test Data

Channel Separation (MHz)	20dB BW * (kHz)	Limit (kHz)	Result
1.00	837.00	>25	Pass



Test Plot (Frequency Separation)

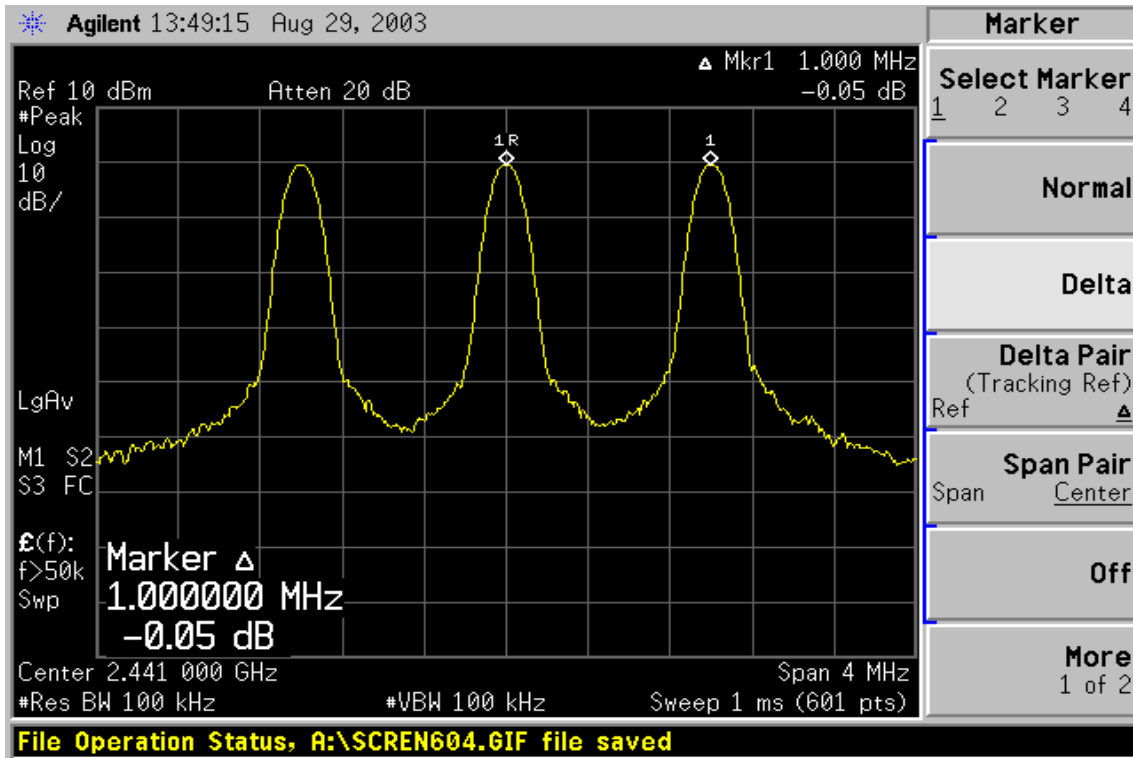

Test Plot (20dB Bandwidth)

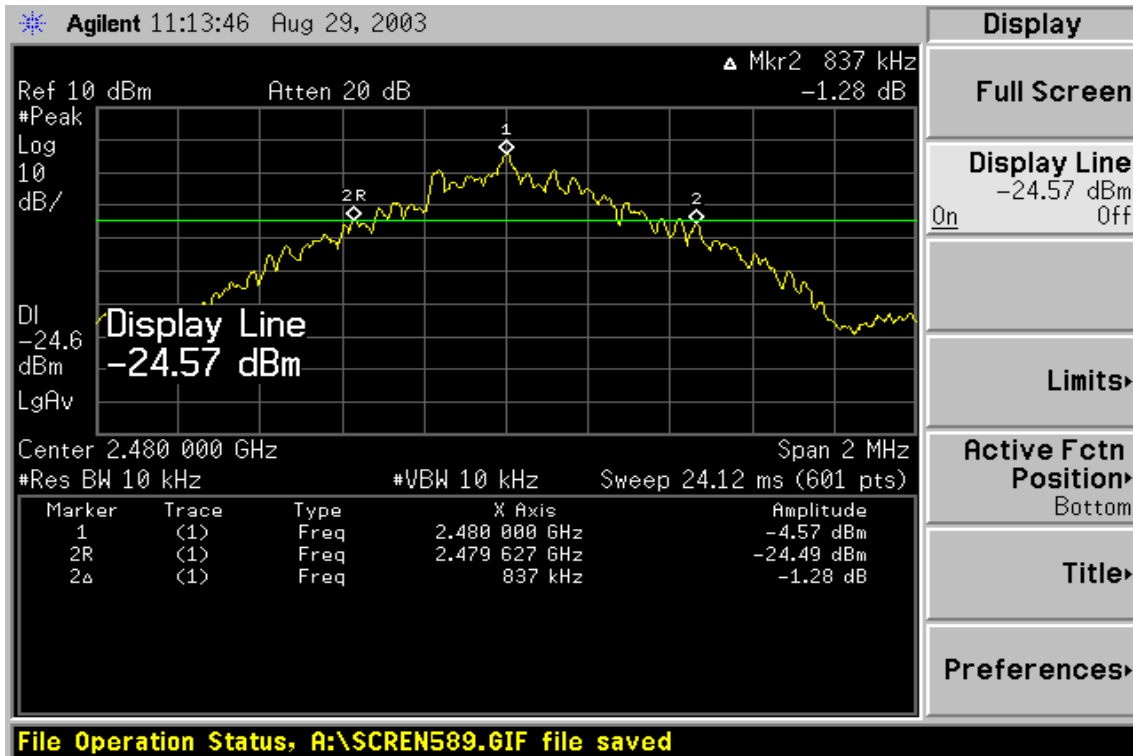



7.10 NUMBER OF HOPPING FREQUENCY

LIMIT

According to §15.247(a)(1)(ii), Frequency hopping systems operating in the 2400MHz-2483.5 MHz bands shall use at least 75 hopping frequencies.

MEASUREMENT EQUIPMENT USED

Name of Equipment	Manufacturer	Model	Serial Number	Calibration Due
Spectrum Analyzer	Agilent	E4446A	US42510252	04/28/2004
Spectrum Analyzer	R&S	FSP30	1093.4495.30	07/22/2004
Low-loss Cable	Huber + Suhner	Sucoflex 104	N/A	N/A

Remark: Each piece of equipment is scheduled for calibration once a year.

Test Configuration

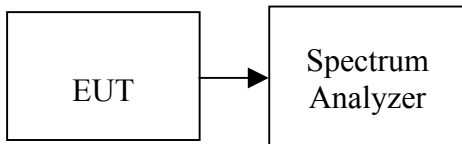

TEST PROCEDURE

1. Place the EUT on the table and set it in transmitting mode.
2. Remove the antenna from the EUT and then connect a low loss RF cable from the antenna port to the spectrum analyzer.
3. Set spectrum analyzer Start=2400MHz, Stop = 2483.5MHz, Sweep = auto.
4. Set the spectrum analyzer as RBW, VBW=100kHz,
5. Max hold, view and count how many channel in the band.

TEST RESULTS

No non-compliance noted

Test Data

Result (No. of CH)	Limit (No. of CH)	Result
79	75	PASS



Test Plot

Channel Number

2.420 GHz – 2.441 GHz

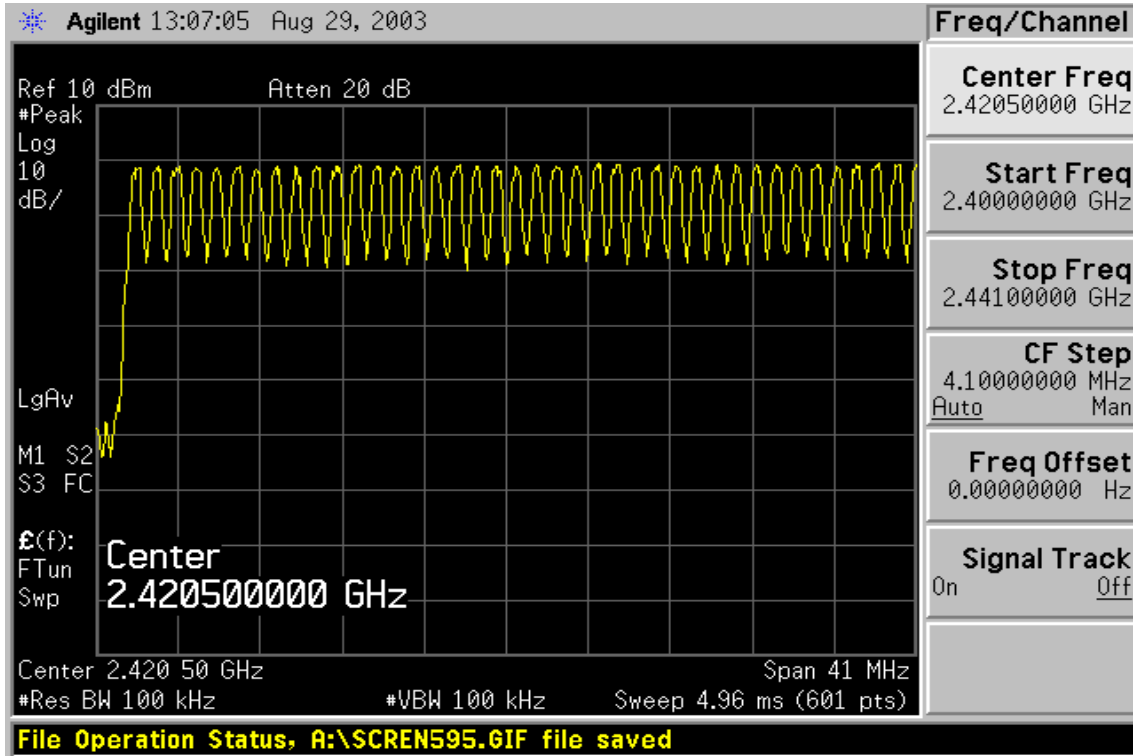

2.441 GHz – 2.4835 GHz

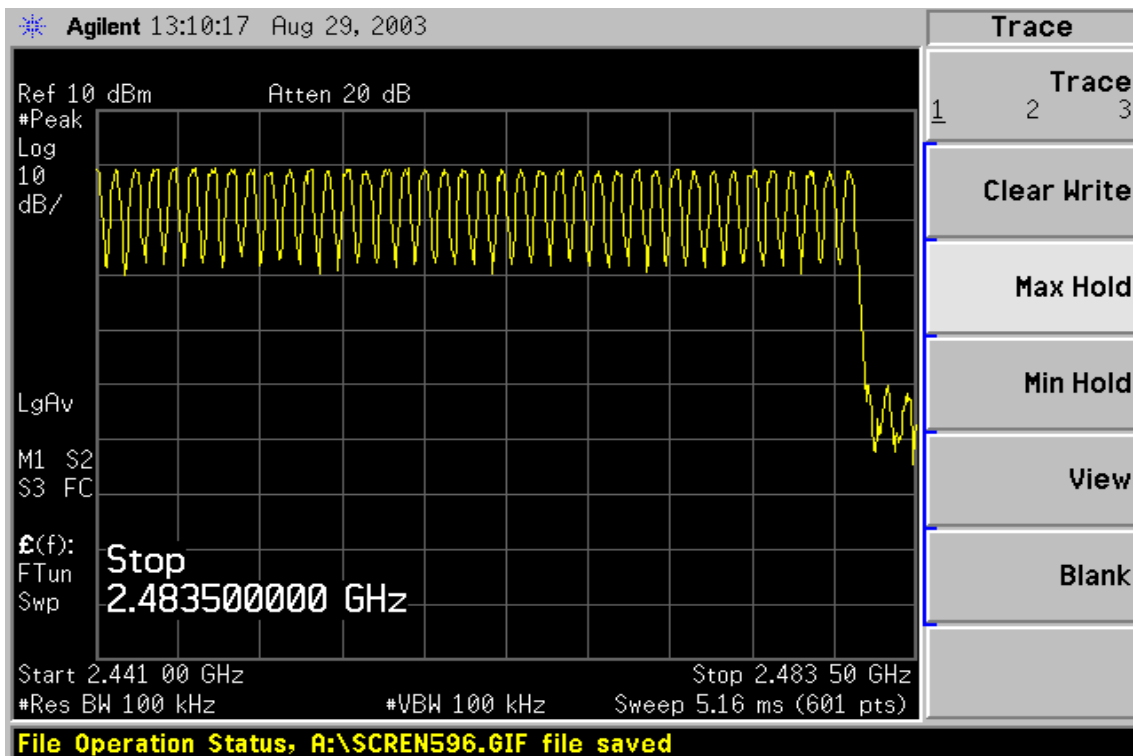



7.11 TIME OF OCCUPANCY (DWELL TIME)

LIMIT

According to §15.247(a)(1)(iii), Frequency hopping systems operating in the 2400MHz-2483.5 MHz bands. The average time of occupancy on any channels shall not greater than 0.4 s within a period 0.4 s multiplied by the number of hopping channels employed.

MEASUREMENT EQUIPMENT USED

Name of Equipment	Manufacturer	Model	Serial Number	Calibration Due
Spectrum Analyzer	Agilent	E4446A	US42510252	04/28/2004
Spectrum Analyzer	R&S	FSP30	1093.4495.30	07/22/2004
Low-loss Cable	Huber + Suhner	Sucoflex 104	N/A	N/A

Remark: Each piece of equipment is scheduled for calibration once a year.

Test Configuration

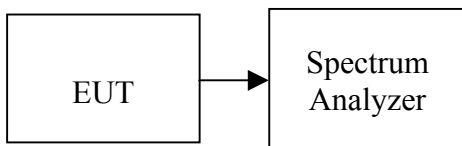

TEST PROCEDURE

1. Place the EUT on the table and set it in transmitting mode.
2. Remove the antenna from the EUT and then connect a low loss RF cable from the antenna port to the spectrum analyzer.
3. Set center frequency of spectrum analyzer = operating frequency.
4. Set the spectrum analyzer as RBW, VBW=10kHz, Span = 0Hz, Adjust Sweep = 100ms / RBW= 1MHz, VBW=3MHz, Span = 0Hz, Adjust Sweep = 2ms.
5. Repeat above procedures until all frequency measured were complete.

TEST RESULTS

No non-compliance noted

Test Data

CH Low: $0.425 * 1600/79 * 30=258.23$ (ms)

CH Mid: $0.420 * 1600/79 * 30=255.19$ (ms)

CH High: $0.420 * 1600/79 * 30=255.19$ (ms)

CH	Pulse Time (ms)	Total of Dwell (ms)	Period Time (s)	Limit (ms)
Low	0.425	258.23	30.00	400.00
Mid	0.420	255.19	30.00	400.00
High	0.420	255.19	30.00	400.00



Test Plot

Dwell Time Test Data (CH-Low)

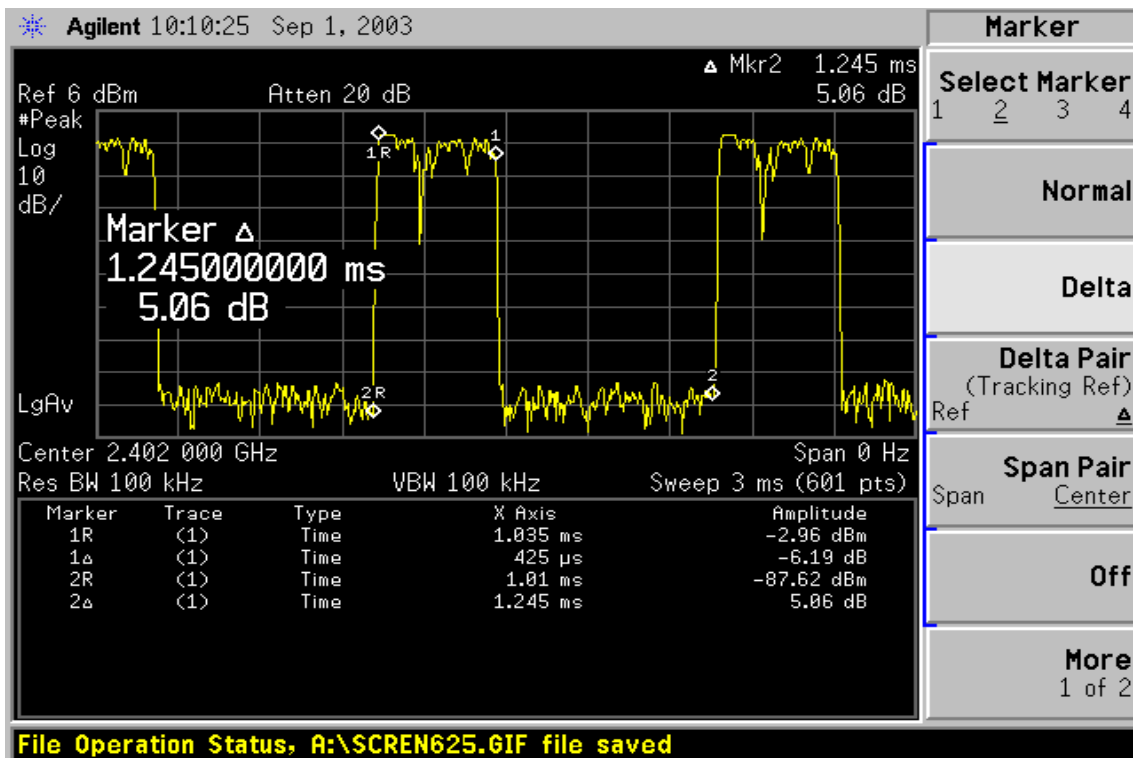
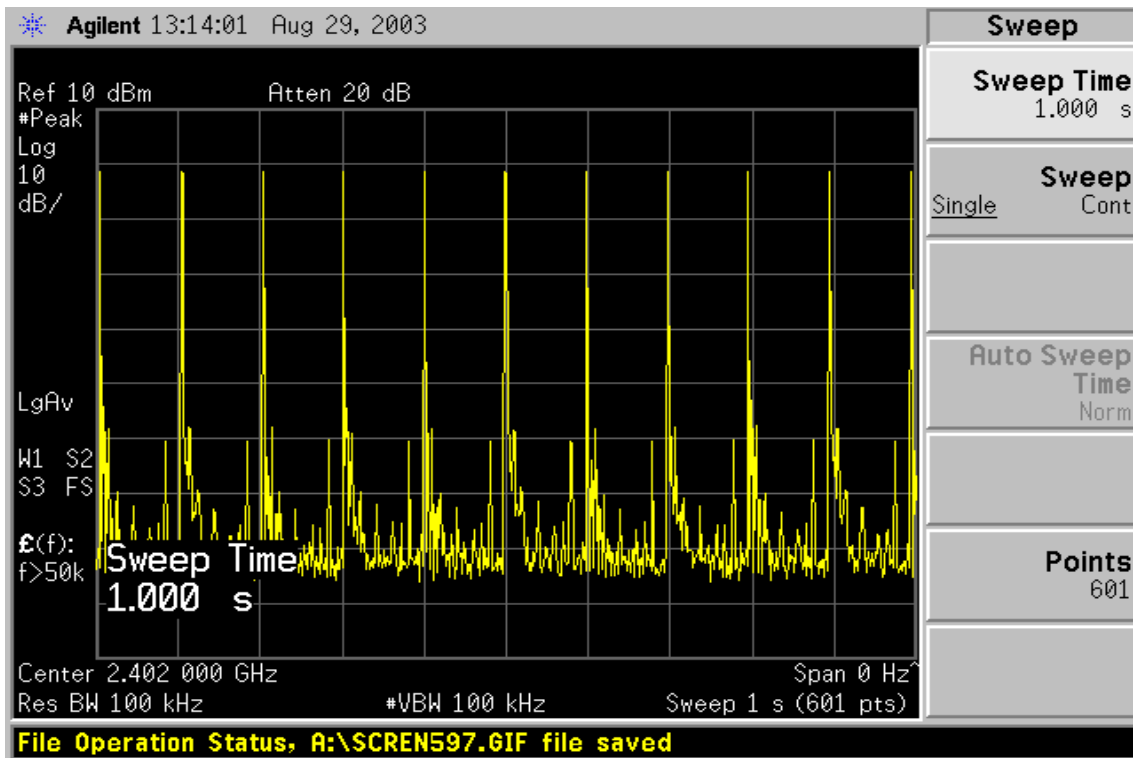



Dwell Time Test Data (CH-Mid)

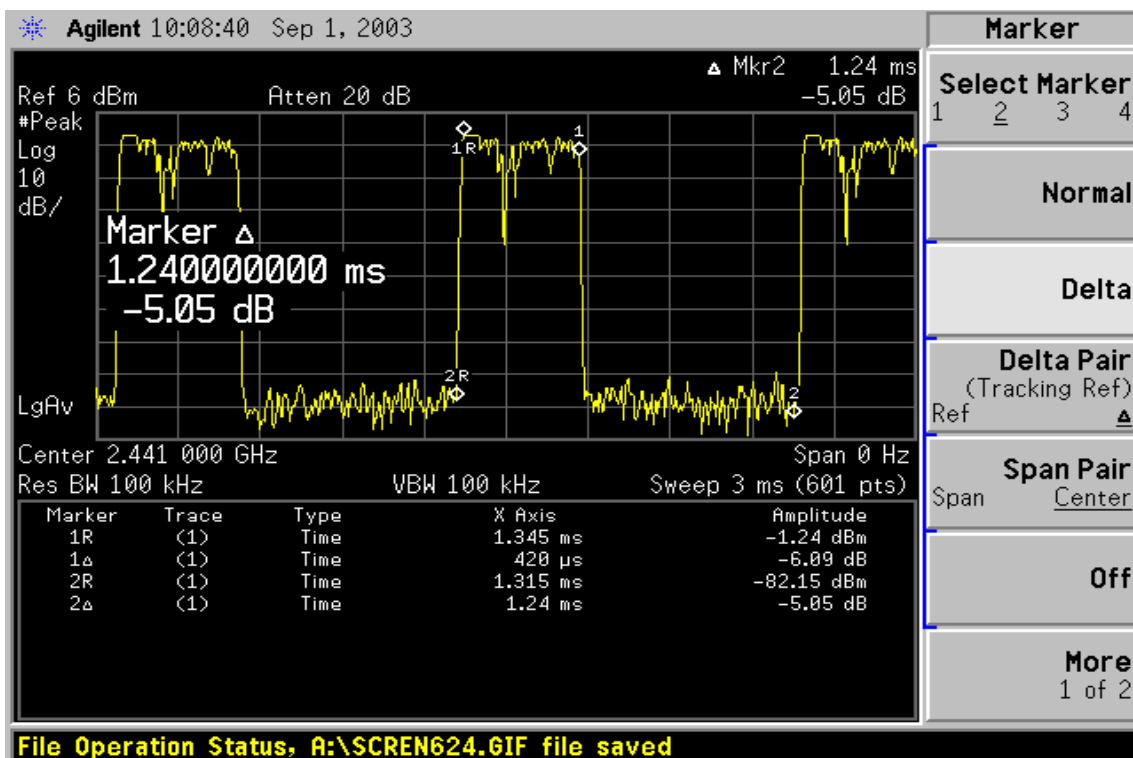
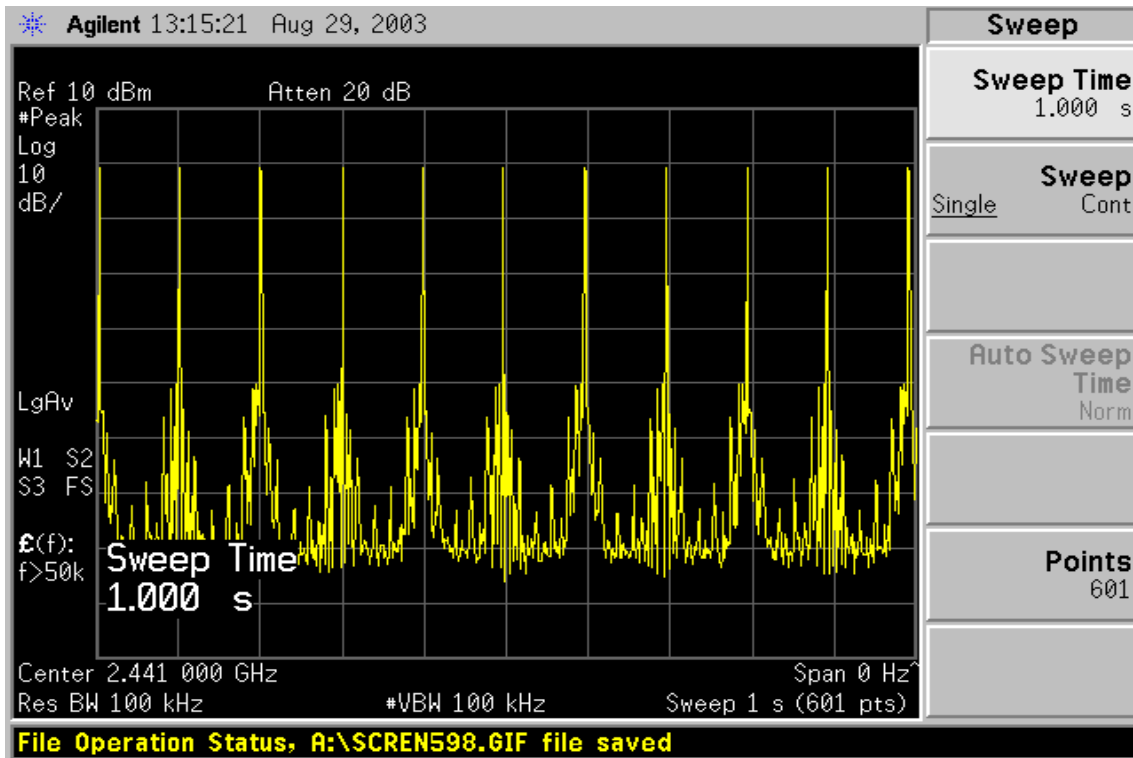



Dwell Time Test Data (CH-High)

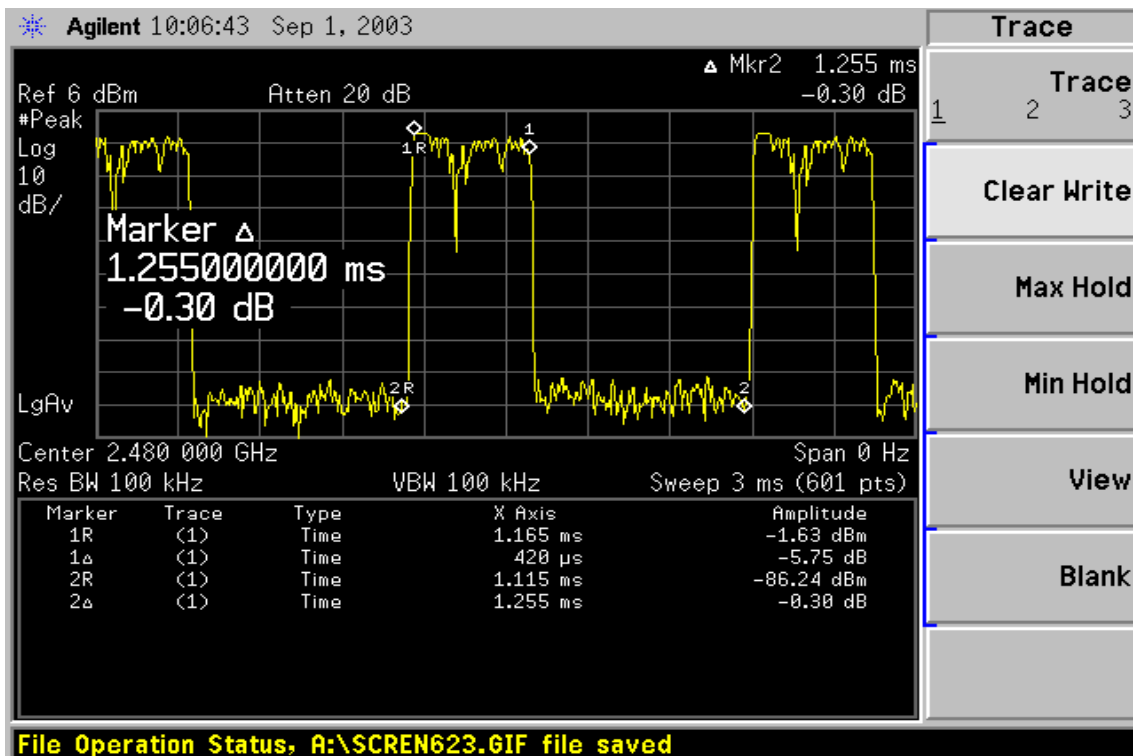
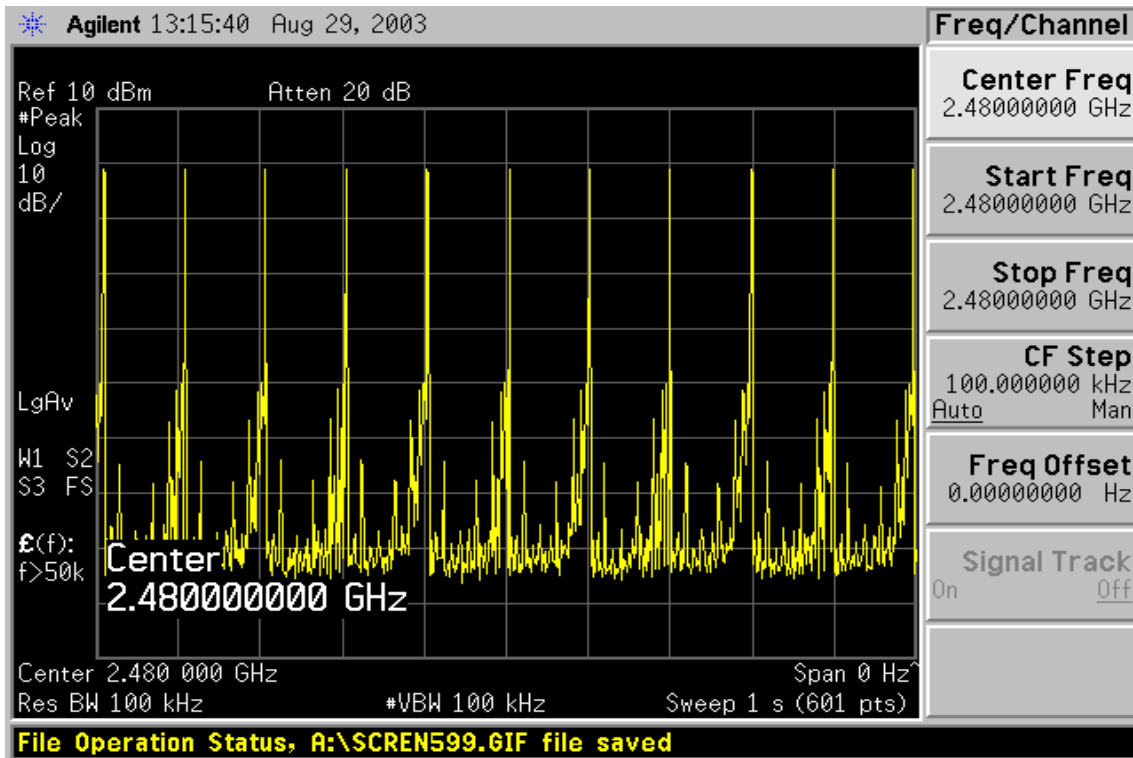



7.12 RADIO FREQUENCY EXPOSURE

LIMIT

Systems operating under the provisions of this section shall be operated in a manner that ensures that the public is not exposed to radio frequency energy levels in excess of the Commission's guidelines. See §15.247(b)(4) and §1.1307(b)(1) of this chapter.

EUT Specification

EUT	Tablet PC
Frequency band (Operating)	<input type="checkbox"/> WLAN: 2.412GHz ~ 2.462GHz <input type="checkbox"/> WLAN: 5.18GHz ~ 5.32GHz / 5.50GHz ~ 5.70GHz <input type="checkbox"/> WLAN: 5.745GHz ~ 5825GHz <input checked="" type="checkbox"/> Others <u>Bluetooth: 2402GHz ~ 2480GHz</u>
Device category	<input checked="" type="checkbox"/> Portable (<20cm separation) <input type="checkbox"/> Mobile (>20cm separation) <input type="checkbox"/> Others _____
Exposure classification	<input type="checkbox"/> Occupational/Controlled exposure ($S = 5mW/cm^2$) <input checked="" type="checkbox"/> General Population/Uncontrolled exposure ($S=1mW/cm^2$)
Antenna diversity	<input type="checkbox"/> Single antenna <input checked="" type="checkbox"/> Multiple antennas <input type="checkbox"/> TX diversity <input type="checkbox"/> RX diversity <input checked="" type="checkbox"/> TX/RX diversity
Max. output power	-0.03 dBm (0.993mW)
Antenna gain (Max)	-3.04 dBi (Numeric gain: 0.4965)
Evaluation applied	<input type="checkbox"/> MPE Evaluation* <input checked="" type="checkbox"/> SAR Evaluation

Note:

- *The maximum output power is -0.03 dBm (0.993mW) at 2441MHz, which is higher than general population high threshold $60/F$ ($60/2441=0.02458mW$). SAR is required.
- For mobile or fixed location transmitters, the minimum separation distance is 20 cm, even if calculations indicate that the MPE distance would be less.

TEST RESULTS

Note: Please refer to the separate SAR report.



CONDITION C: CO-LACATED OPERATION (WLAN & BLUETOOTH OPERATED SIMULTANEOUSLY)

7.13 RADIATED EMISSIONS

LIMIT

1. Except as provided elsewhere in this Subpart, the emissions from an intentional radiator shall not exceed the field strength levels specified in the following table:

Frequency (MHz)	Field Strength (mV/m)	Measurement Distance (m)
30-88	100*	3
88-216	150*	3
216-960	200*	3
Above 960	500	3

Note: Except as provided in paragraph (g), fundamental emissions from intentional radiators operating under this Section shall not be located in the frequency bands 54-72 MHz, 76-88 MHz, 174-216 MHz or 470-806 MHz. However, operation within these frequency bands is permitted under other sections of this Part, e.g., Sections 15.231 and 15.241.

2. In the above emission table, the tighter limit applies at the band edges.

Frequency (Hz)	Field Strength (μ V/m at 3-meter)	Field Strength (dB μ V/m at 3-meter)
30-88	100	40
88-216	150	43.5
216-960	200	46
Above 960	500	54

MEASUREMENT EQUIPMENT USED

Open Area Test Site # 3				
Name of Equipment	Manufacturer	Model	Serial Number	Calibration Due
Spectrum Analyzer	ADVANTEST	R3261A	N/A	03/18/2004
EMI Test Receiver	R&S	ESVS20	838804/004	01/04/2004
Pre-Amplifier	HP	8447D	2944A09173	03/03/2004
Bilog Antenna	SCHWAZBECK	VULB9163	145	07/05/2004
Turn Table	EMCO	2081-1.21	9709-1885	N.C.R
Antenna Tower	EMCO	2075-2	9707-2060	N.C.R
Controller	EMCO	2090	9709-1256	N.C.R
RF Switch	ANRITSU	MP59B	M53867	N.C.R
Site NSA	C&C	N/A	N/A	09/06/2004
Horn antenna	Schwarzbeck	BBHA 9120	D210	02/23/2004
Loop Antenna	EMCO	6502	2356	07/10/2004
Pre-Amplifier	HP	8449B	3008B00965	10/02/2003

Remark: Each piece of equipment is scheduled for calibration once a year.

Test Configuration

Below 1 GHz

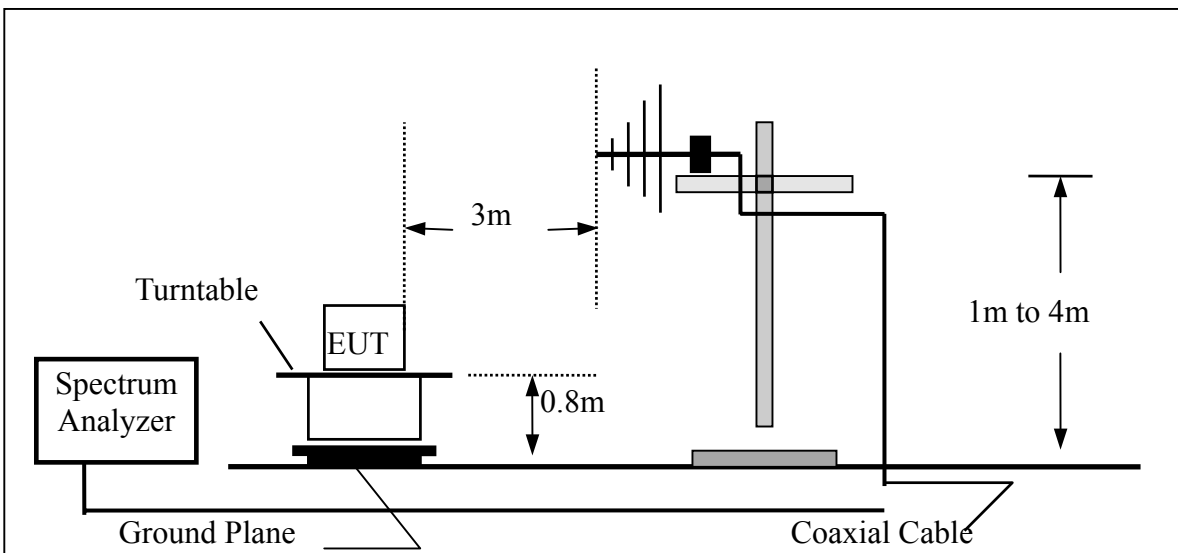

Above 1 GHz

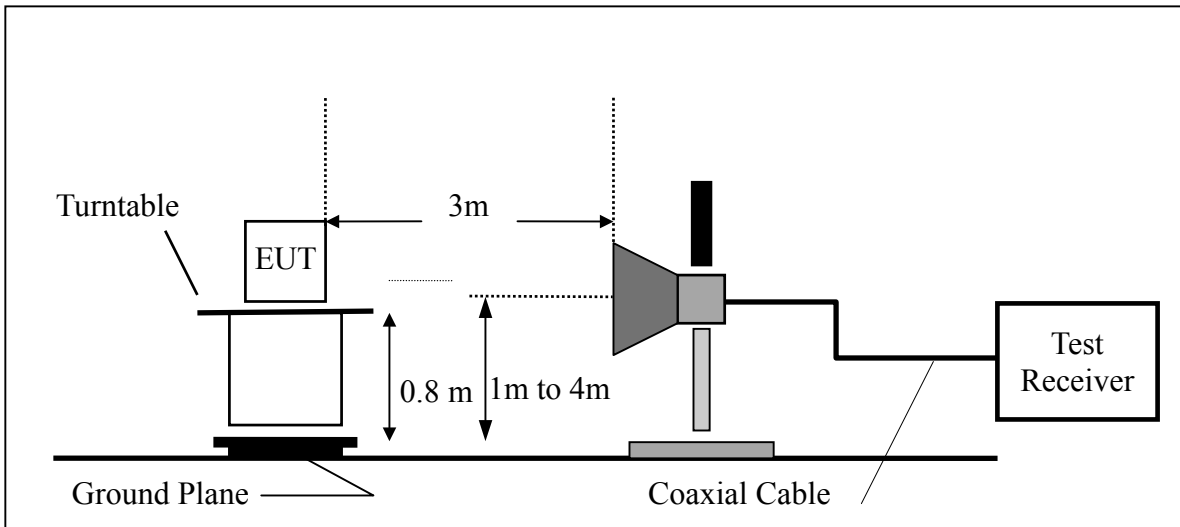

TEST PROCEDURE

1. The EUT is placed on a turntable, which is 0.8m above ground plane.
2. The turntable shall be rotated for 360 degrees to determine the position of maximum emission level.
3. EUT is set 3m away from the receiving antenna, which is varied from 1m to 4m to find out the highest emissions.
4. Maximum procedure was performed on the six highest emissions to ensure EUT compliance.
5. And also, each emission was to be maximized by changing the polarization of receiving antenna both horizontal and vertical.
6. Repeat above procedures until the measurements for all frequencies are complete.

**TEST RESULTS****Below 1 GHz****WLAN Module mode**

Operation Mode:	TX CH Low Mode	Test Date:	August 19, 2003
Temperature:	20°C	Tested by:	Roy
Humidity:	70 % RH	Polarity:	Ver. / Hor.

Freq. (MHz)	Ant.Pol. H/V	Detector Mode (PK/QP)	Reading (dBuV)	Factor (dB)	Actual FS (dBuV/m)	Limit 3m (dBuV/m)	Safe Margin (dB)
137.46	V	Peak	20.99	10.96	31.95	43.50	-11.55
360.20	V	Peak	10.83	18.58	29.41	46.00	-16.59
400.80	V	Peak	15.49	20.71	36.20	46.00	-9.80
433.00	V	Peak	10.32	20.36	30.68	46.00	-15.32
440.00	V	Peak	11.82	20.28	32.10	46.00	-13.90
500.20	V	Peak	7.56	22.52	30.08	46.00	-15.92
188.76	H	Peak	8.92	13.80	22.72	43.50	-20.78
398.00	H	Peak	9.92	20.61	30.53	46.00	-15.47
500.20	H	Peak	5.85	22.52	28.37	46.00	-17.63
528.20	H	Peak	1.56	23.51	25.07	46.00	-20.93
560.40	H	Peak	3.94	24.51	28.45	46.00	-17.55
795.60	H	Peak	8.40	26.12	34.52	46.00	-11.48

Notes:

1. Measuring frequencies from 30 MHz to the 1GHz.
2. Radiated emissions measured in frequency range from 30 MHz to 1000MHz were made with an instrument using Peak detector mode.
3. Data of measurement within this frequency range shown “ - ” in the table above means the reading of emissions are attenuated more than 20dB below the permissible limits or the field strength is too small to be measured.
4. The IF bandwidth of SPA between 30MHz to 1GHz was 100kHz.



Operation Mode: TX CH Mid Mode **Test Date:** August 19, 2003
Temperature: 20°C **Tested by:** Roy
Humidity: 70 % RH **Polarity:** Ver. / Hor.

Freq. (MHz)	Ant.Pol. H/V	Detector Mode (PK/QP)	Reading (dBuV)	Factor (dB)	Actual FS (dBuV/m)	Limit 3m (dBuV/m)	Safe Margin (dB)
137.46	V	Peak	20.77	10.96	31.73	43.50	-11.77
365.80	V	Peak	10.66	18.88	29.54	46.00	-16.46
400.80	V	Peak	15.97	20.71	36.68	46.00	-9.32
433.00	V	Peak	10.22	20.36	30.58	46.00	-15.42
440.00	V	Peak	11.70	20.28	31.98	46.00	-14.02
468.80	V	Peak	6.84	22.45	29.29	46.00	-16.71
400.80	H	Peak	10.22	20.71	30.93	46.00	-15.07
500.20	H	Peak	6.79	22.52	29.31	46.00	-16.69
560.40	H	Peak	4.33	24.51	28.84	46.00	-17.16
795.60	H	Peak	8.29	26.12	34.41	46.00	-11.59

Notes:

1. Measuring frequencies from 30 MHz to the 1GHz.
2. Radiated emissions measured in frequency range from 30 MHz to 1000MHz were made with an instrument using Peak detector mode.
3. Data of measurement within this frequency range shown “ - ” in the table above means the reading of emissions are attenuated more than 20dB below the permissible limits or the field strength is too small to be measured.
4. The IF bandwidth of SPA between 30MHz to 1GHz was 100kHz.



Operation Mode: TX CH High Mode **Test Date:** August 19, 2003
Temperature: 20°C **Tested by:** Roy
Humidity: 70 % RH **Polarity:** Ver. / Hor.

Freq. (MHz)	Ant.Pol. H/V	Detector Mode (PK/QP)	Reading (dBuV)	Factor (dB)	Actual FS (dBuV/m)	Limit 3m (dBuV/m)	Safe Margin (dB)
137.46	V	Peak	20.82	10.96	31.78	43.50	-11.72
251.40	V	Peak	16.44	16.28	32.72	46.00	-13.28
360.20	V	Peak	11.40	18.58	29.98	46.00	-16.02
399.40	V	Peak	15.71	20.69	36.40	46.00	-9.60
433.00	V	Peak	10.00	20.36	30.36	46.00	-15.64
440.00	V	Peak	12.81	20.28	33.09	46.00	-12.91
400.80	H	Peak	9.96	20.71	30.67	46.00	-15.33
500.20	H	Peak	6.36	22.52	28.88	46.00	-17.12
560.40	H	Peak	4.52	24.51	29.03	46.00	-16.97
795.60	H	Peak	7.72	26.12	33.84	46.00	-12.16

Notes:

1. Measuring frequencies from 30 MHz to the 1GHz.
2. Radiated emissions measured in frequency range from 30 MHz to 1000MHz were made with an instrument using Peak detector mode.
3. Data of measurement within this frequency range shown “ - ” in the table above means the reading of emissions are attenuated more than 20dB below the permissible limits or the field strength is too small to be measured.
4. The IF bandwidth of SPA between 30MHz to 1GHz was 100kHz.



Above 1 GHz

Operation Mode: TX CH Low Mode **Test Date:** August 19, 2003
Temperature: 20°C **Tested by:** Roy
Humidity: 70% RH **Polarity:** Ver.

Freq. (MHz)	Peak	AV	Ant./CL CF(dB)	Actual FS		Peak	AV	Margin (dB)	Remark
	Reading (dBuV)	Reading (dBuV)		Peak (dBuV/m)	AV (dBuV/m)	Limit (dBuV/m)	Limit (dBuV/m)		
1596.00	46.68	---	-6.82	39.86	---	74.00	54.00	-14.14	Peak
4824.00	---	---	---	---	---	74.00	54.00	---	---
7236.00	---	---	---	---	---	74.00	54.00	---	---
9648.00	---	---	---	---	---	74.00	54.00	---	---
12060.00	---	---	---	---	---	74.00	54.00	---	---
14472.00	---	---	---	---	---	74.00	54.00	---	---
16884.00	---	---	---	---	---	74.00	54.00	---	---
19296.00	---	---	---	---	---	74.00	54.00	---	---
21708.00	---	---	---	---	---	74.00	54.00	---	---
24120.00	---	---	---	---	---	74.00	54.00	---	---

Notes:

1. Measuring frequencies from 1 GHz to the 10th harmonic of highest fundamental frequency.
2. Data of measurement within this frequency range shown " --- " in the table above means the reading of emissions are attenuated more than 20dB below the permissible limits or the field strength is too small to be measured.
3. Radiated emissions measured in frequency above 1000MHz were made with an instrument using Peak detector mode and average detector mode of the emission shown in Actual FS column.
4. Spectrum Peak Setting 1GHz - 26GHz, RBW = 1MHz, VBW = 1MHz, Sweep time = 200 ms.
5. Spectrum AV Setting 1GHz - 26GHz, RBW = 1MHz, VBW = 10Hz, Sweep time = 200 ms



Operation Mode: TX CH Low Mode **Test Date:** August 19, 2003
Temperature: 20°C **Tested by:** Roy
Humidity: 70 % RH **Polarity:** Hor.

Freq. (MHz)	Peak	AV	Ant./CL CF(dB)	Actual FS		Peak	AV	Margin (dB)	Remark
	Reading (dBuV)	Reading (dBuV)		Peak (dBuV/m)	AV (dBuV/m)	Limit (dBuV/m)	Limit (dBuV/m)		
4824.00	---	---	---	---	---	74.00	54.00	---	---
7236.00	---	---	---	---	---	74.00	54.00	---	---
9648.00	---	---	---	---	---	74.00	54.00	---	---
12060.00	---	---	---	---	---	74.00	54.00	---	---
14472.00	---	---	---	---	---	74.00	54.00	---	---
16884.00	---	---	---	---	---	74.00	54.00	---	---
19296.00	---	---	---	---	---	74.00	54.00	---	---
21708.00	---	---	---	---	---	74.00	54.00	---	---
24120.00	---	---	---	---	---	74.00	54.00	---	---

Notes:

1. Measuring frequencies from 1 GHz to the 10th harmonic of highest fundamental frequency.
2. Data of measurement within this frequency range shown " --- " in the table above means the reading of emissions are attenuated more than 20dB below the permissible limits or the field strength is too small to be measured.
3. Radiated emissions measured in frequency above 1000MHz were made with an instrument using Peak detector mode and average detector mode of the emission shown in Actual FS column.
4. Spectrum Peak Setting 1GHz - 26GHz, RBW = 1MHz, VBW = 1MHz, Sweep time = 200 ms.
5. Spectrum AV Setting 1GHz - 26GHz, RBW = 1MHz, VBW = 10Hz, Sweep time = 200 ms



Operation Mode: TX CH Mid Mode **Test Date:** August 19, 2003
Temperature: 20°C **Tested by:** Roy
Humidity: 70 % RH **Polarity:** Ver.

Freq. (MHz)	Peak	AV	Ant./CL CF(dB)	Actual FS		Peak	AV	Margin (dB)	Remark
	Reading (dBuV)	Reading (dBuV)		Peak (dBuV/m)	AV (dBuV/m)	Limit (dBuV/m)	Limit (dBuV/m)		
1600.00	46.28	---	-6.79	39.49	---	74.00	54.00	-14.51	Peak
4874.00	---	---	---	---	---	74.00	54.00	---	---
7311.00	---	---	---	---	---	74.00	54.00	---	---
9748.00	---	---	---	---	---	74.00	54.00	---	---
12185.00	---	---	---	---	---	74.00	54.00	---	---
14622.00	---	---	---	---	---	74.00	54.00	---	---
17059.00	---	---	---	---	---	74.00	54.00	---	---
19496.00	---	---	---	---	---	74.00	54.00	---	---
21933.00	---	---	---	---	---	74.00	54.00	---	---
24370.00	---	---	---	---	---	74.00	54.00	---	---

Notes:

1. Measuring frequencies from 1 GHz to the 10th harmonic of highest fundamental frequency.
2. Data of measurement within this frequency range shown " --- " in the table above means the reading of emissions are attenuated more than 20dB below the permissible limits or the field strength is too small to be measured.
3. Radiated emissions measured in frequency above 1000MHz were made with an instrument using Peak detector mode and average detector mode of the emission shown in Actual FS column.
4. Spectrum Peak Setting 1GHz - 26GHz, RBW = 1MHz, VBW = 1MHz, Sweep time = 200 ms.
5. Spectrum AV Setting 1GHz - 26GHz, RBW = 1MHz, VBW = 10Hz, Sweep time = 200 ms



Operation Mode: TX CH Mid Mode **Test Date:** August 19, 2003
Temperature: 20°C **Tested by:** Roy
Humidity: 70 % RH **Polarity:** Hor.

Freq. (MHz)	Peak	AV	Ant./CL CF(dB)	Actual FS		Peak	AV	Margin (dB)	Remark
	Reading (dBuV)	Reading (dBuV)		Peak (dBuV/m)	AV (dBuV/m)	Limit (dBuV/m)	Limit (dBuV/m)		
1600.00	42.25	---	-6.79	35.46	---	74.00	54.00	-18.54	Peak
4874.00	---	---	---	---	---	74.00	54.00	---	---
7311.00	---	---	---	---	---	74.00	54.00	---	---
9748.00	---	---	---	---	---	74.00	54.00	---	---
12185.00	---	---	---	---	---	74.00	54.00	---	---
14622.00	---	---	---	---	---	74.00	54.00	---	---
17059.00	---	---	---	---	---	74.00	54.00	---	---
19496.00	---	---	---	---	---	74.00	54.00	---	---
21933.00	---	---	---	---	---	74.00	54.00	---	---
24370.00	---	---	---	---	---	74.00	54.00	---	---

Notes:

1. Measuring frequencies from 1 GHz to the 10th harmonic of highest fundamental frequency.
2. Data of measurement within this frequency range shown " --- " in the table above means the reading of emissions are attenuated more than 20dB below the permissible limits or the field strength is too small to be measured.
3. Radiated emissions measured in frequency above 1000MHz were made with an instrument using Peak detector mode and average detector mode of the emission shown in Actual FS column.
4. Spectrum Peak Setting 1GHz - 26GHz, RBW = 1MHz, VBW = 1MHz, Sweep time = 200 ms.
5. Spectrum AV Setting 1GHz - 26GHz, RBW = 1MHz, VBW = 10Hz, Sweep time = 200 ms



Operation Mode: TX CH High Mode **Test Date:** August 19, 2003
Temperature: 20°C **Tested by:** Roy
Humidity: 70 % RH **Polarity:** Ver.

Freq. (MHz)	Peak	AV	Ant./CL CF(dB)	Actual FS		Peak	AV	Margin (dB)	Remark
	Reading (dBuV)	Reading (dBuV)		Peak (dBuV/m)	AV (dBuV/m)	Limit (dBuV/m)	Limit (dBuV/m)		
1600.00	46.57	---	-6.79	39.78	---	74.00	54.00	-14.22	Peak
4924.00	---	---	---	---	---	74.00	54.00	---	---
7386.00	---	---	---	---	---	74.00	54.00	---	---
9848.00	---	---	---	---	---	74.00	54.00	---	---
12310.00	---	---	---	---	---	74.00	54.00	---	---
14772.00	---	---	---	---	---	74.00	54.00	---	---
17234.00	---	---	---	---	---	74.00	54.00	---	---
19696.00	---	---	---	---	---	74.00	54.00	---	---
22158.00	---	---	---	---	---	74.00	54.00	---	---
24620.00	---	---	---	---	---	74.00	54.00	---	---

Notes:

1. Measuring frequencies from 1 GHz to the 10th harmonic of highest fundamental frequency.
2. Data of measurement within this frequency range shown " --- " in the table above means the reading of emissions are attenuated more than 20dB below the permissible limits or the field strength is too small to be measured.
3. Radiated emissions measured in frequency above 1000MHz were made with an instrument using Peak detector mode and average detector mode of the emission shown in Actual FS column.
4. Spectrum Peak Setting 1GHz - 26GHz, RBW = 1MHz, VBW = 1MHz, Sweep time = 200 ms.
5. Spectrum AV Setting 1GHz - 26GHz, RBW = 1MHz, VBW = 10Hz, Sweep time = 200 ms



Operation Mode: TX CH High Mode **Test Date:** August 19, 2003
Temperature: 20°C **Tested by:** Roy
Humidity: 70 % RH **Polarity:** Hor.

Freq. (MHz)	Peak	AV	Ant./CL CF(dB)	Actual FS		Peak	AV	Margin (dB)	Remark
	Reading (dBuV)	Reading (dBuV)		Peak (dBuV/m)	AV (dBuV/m)	Limit (dBuV/m)	Limit (dBuV/m)		
2600.00	44.84	---	-2.52	42.32	---	74.00	54.00	-11.68	Peak
4924.00	---	---	---	---	---	74.00	54.00	---	---
7386.00	---	---	---	---	---	74.00	54.00	---	---
9848.00	---	---	---	---	---	74.00	54.00	---	---
12310.00	---	---	---	---	---	74.00	54.00	---	---
14772.00	---	---	---	---	---	74.00	54.00	---	---
17234.00	---	---	---	---	---	74.00	54.00	---	---
19696.00	---	---	---	---	---	74.00	54.00	---	---
22158.00	---	---	---	---	---	74.00	54.00	---	---
24620.00	---	---	---	---	---	74.00	54.00	---	---

Notes:

1. Measuring frequencies from 1 GHz to the 10th harmonic of highest fundamental frequency.
2. Data of measurement within this frequency range shown " --- " in the table above means the reading of emissions are attenuated more than 20dB below the permissible limits or the field strength is too small to be measured.
3. Radiated emissions measured in frequency above 1000MHz were made with an instrument using Peak detector mode and average detector mode of the emission shown in Actual FS column.
4. Spectrum Peak Setting 1GHz - 26GHz, RBW = 1MHz, VBW = 1MHz, Sweep time = 200 ms.
5. Spectrum AV Setting 1GHz - 26GHz, RBW = 1MHz, VBW = 10Hz, Sweep time = 200 ms



Bluetooth Module mode

Operation Mode: TX CH Low Mode **Test Date:** August 19, 2003
Temperature: 20°C **Tested by:** Roy
Humidity: 70 % RH **Polarity:** Ver. / Hor.

Freq. (MHz)	Ant.Pol. H/V	Detector Mode (PK/QP)	Reading (dBuV)	Factor (dB)	Actual FS (dBuV/m)	Limit 3m (dBuV/m)	Safe Margin (dB)
137.46	V	Peak	18.56	10.96	29.52	43.50	-13.98
365.80	V	Peak	9.70	18.88	28.58	46.00	-17.42
399.40	V	Peak	15.96	20.69	36.65	46.00	-9.35
433.00	V	Peak	10.31	20.36	30.67	46.00	-15.33
440.00	V	Peak	10.18	20.28	30.46	46.00	-15.54
497.40	V	Peak	6.91	22.39	29.30	46.00	-16.70
400.80	H	Peak	10.02	20.71	30.73	46.00	-15.27
497.40	H	Peak	5.54	22.39	27.93	46.00	-18.07
560.40	H	Peak	2.28	24.54	26.82	46.00	-19.18
799.80	H	Peak	3.64	26.14	29.78	46.00	-16.22

Notes:

1. Measuring frequencies from 30 MHz to the 1GHz.
2. Radiated emissions measured in frequency range from 30 MHz to 1000MHz were made with an instrument using Peak detector mode.
3. Data of measurement within this frequency range shown “ - ” in the table above means the reading of emissions are attenuated more than 20dB below the permissible limits or the field strength is too small to be measured.
4. The IF bandwidth of SPA between 30MHz to 1GHz was 100kHz.



Operation Mode: TX CH Mid Mode **Test Date:** August 19, 2003
Temperature: 20°C **Tested by:** Roy
Humidity: 70 % RH **Polarity:** Ver. / Hor.

Freq. (MHz)	Ant.Pol. H/V	Detector Mode (PK/QP)	Reading (dBuV)	Factor (dB)	Actual FS (dBuV/m)	Limit 3m (dBuV/m)	Safe Margin (dB)
137.46	V	Peak	19.10	10.96	30.06	43.50	-13.44
365.80	V	Peak	10.44	18.88	29.32	46.00	-16.68
400.80	V	Peak	16.50	20.71	37.21	46.00	-8.79
430.20	V	Peak	10.26	20.39	30.65	46.00	-15.35
440.00	V	Peak	11.64	20.28	31.92	46.00	-14.08
497.40	V	Peak	6.62	22.39	29.01	46.00	-16.99
398.00	H	Peak	11.65	20.61	32.26	46.00	-13.74
500.20	H	Peak	5.20	22.52	27.72	46.00	-18.28
795.60	H	Peak	3.36	26.12	29.48	46.00	-16.52

Notes:

1. Measuring frequencies from 30 MHz to the 1GHz.
2. Radiated emissions measured in frequency range from 30 MHz to 1000MHz were made with an instrument using Peak detector mode.
3. Data of measurement within this frequency range shown “ - ” in the table above means the reading of emissions are attenuated more than 20dB below the permissible limits or the field strength is too small to be measured.
4. The IF bandwidth of SPA between 30MHz to 1GHz was 100kHz.



Operation Mode: TX CH High Mode **Test Date:** August 19, 2003
Temperature: 20°C **Tested by:** Roy
Humidity: 70 % RH **Polarity:** Ver. / Hor.

Freq. (MHz)	Ant.Pol. H/V	Detector Mode (PK/QP)	Reading (dBuV)	Factor (dB)	Actual FS (dBuV/m)	Limit 3m (dBuV/m)	Safe Margin (dB)
138.00	V	Peak	18.45	10.94	29.39	43.50	-14.11
365.80	V	Peak	10.90	18.88	29.78	46.00	-16.22
399.40	V	Peak	16.13	20.69	36.82	46.00	-9.18
433.00	V	Peak	10.63	20.36	30.99	46.00	-15.01
440.00	V	Peak	9.99	20.28	30.27	46.00	-15.73
497.40	V	Peak	6.62	22.39	29.01	46.00	-16.99
399.40	H	Peak	10.14	20.69	30.83	46.00	-15.17
497.40	H	Peak	5.80	22.39	28.19	46.00	-17.81
560.40	H	Peak	2.18	24.51	26.69	46.00	-19.31
795.60	H	Peak	3.93	26.12	30.05	46.00	-15.95

Notes:

1. Measuring frequencies from 30 MHz to the 1GHz.
2. Radiated emissions measured in frequency range from 30 MHz to 1000MHz were made with an instrument using Peak detector mode.
3. Data of measurement within this frequency range shown “ - ” in the table above means the reading of emissions are attenuated more than 20dB below the permissible limits or the field strength is too small to be measured.
4. The IF bandwidth of SPA between 30MHz to 1GHz was 100kHz.



Above 1 GHz

Operation Mode: TX CH Low Mode **Test Date:** September 1, 2003
Temperature: 20°C **Tested by:** Roy
Humidity: 70% RH **Polarity:** Ver.

Freq. (MHz)	Peak	AV	Ant./CL CF(dB)	Actual FS		Peak	AV	Margin (dB)	Remark
	Reading (dBuV)	Reading (dBuV)		Peak (dBuV/m)	AV (dBuV/m)	Limit (dBuV/m)	Limit (dBuV/m)		
2372.00	43.53	---	-3.16	40.37	---	74.00	54.00	-13.63	Peak
4804.00	---	---	---	---	---	74.00	54.00	---	---
7206.00	---	---	---	---	---	74.00	54.00	---	---
9608.00	---	---	---	---	---	74.00	54.00	---	---
12010.00	---	---	---	---	---	74.00	54.00	---	---
14412.00	---	---	---	---	---	74.00	54.00	---	---
16814.00	---	---	---	---	---	74.00	54.00	---	---
19216.00	---	---	---	---	---	74.00	54.00	---	---
21618.00	---	---	---	---	---	74.00	54.00	---	---
24020.00	---	---	---	---	---	74.00	54.00	---	---

Notes:

1. Measuring frequencies from 1 GHz to the 10th harmonic of highest fundamental frequency.
2. Data of measurement within this frequency range shown " --- " in the table above means the reading of emissions are attenuated more than 20dB below the permissible limits or the field strength is too small to be measured.
3. Radiated emissions measured in frequency above 1000MHz were made with an instrument using Peak detector mode and average detector mode of the emission shown in Actual FS column.
4. Spectrum Peak Setting 1GHz - 26GHz, RBW = 1MHz, VBW = 1MHz, Sweep time = 200 ms.
5. Spectrum AV Setting 1GHz - 26GHz, RBW = 1MHz, VBW = 10Hz, Sweep time = 200 ms



Operation Mode: TX CH Low Mode **Test Date:** September 1, 2003
Temperature: 20°C **Tested by:** Roy
Humidity: 70 % RH **Polarity:** Hor.

Freq. (MHz)	Peak	AV	Ant./CL CF(dB)	Actual FS		Peak	AV	Margin (dB)	Remark
	Reading (dBuV)	Reading (dBuV)		Peak (dBuV/m)	AV (dBuV/m)	Limit (dBuV/m)	Limit (dBuV/m)		
4804.00	---	---	---	---	---	74.00	54.00	---	---
7206.00	---	---	---	---	---	74.00	54.00	---	---
9608.00	---	---	---	---	---	74.00	54.00	---	---
12010.00	---	---	---	---	---	74.00	54.00	---	---
14412.00	---	---	---	---	---	74.00	54.00	---	---
16814.00	---	---	---	---	---	74.00	54.00	---	---
19216.00	---	---	---	---	---	74.00	54.00	---	---
21618.00	---	---	---	---	---	74.00	54.00	---	---
24020.00	---	---	---	---	---	74.00	54.00	---	---

Notes:

1. Measuring frequencies from 1 GHz to the 10th harmonic of highest fundamental frequency.
2. Data of measurement within this frequency range shown " --- " in the table above means the reading of emissions are attenuated more than 20dB below the permissible limits or the field strength is too small to be measured.
3. Radiated emissions measured in frequency above 1000MHz were made with an instrument using Peak detector mode and average detector mode of the emission shown in Actual FS column.
4. Spectrum Peak Setting 1GHz - 26GHz, RBW = 1MHz, VBW = 1MHz, Sweep time = 200 ms.
5. Spectrum AV Setting 1GHz - 26GHz, RBW = 1MHz, VBW = 10Hz, Sweep time = 200 ms



Operation Mode: TX CH Mid Mode **Test Date:** September 1, 2003
Temperature: 20°C **Tested by:** Roy
Humidity: 70 % RH **Polarity:** Ver.

Freq. (MHz)	Peak	AV	Ant./CL CF(dB)	Actual FS		Peak	AV	Margin (dB)	Remark
	Reading (dBuV)	Reading (dBuV)		Peak (dBuV/m)	AV (dBuV/m)	Limit (dBuV/m)	Limit (dBuV/m)		
2412.00	44.07	---	-3.04	41.03	---	74.00	54.00	-12.97	Peak
4882.00	---	---	---	---	---	74.00	54.00	---	---
7323.00	---	---	---	---	---	74.00	54.00	---	---
9764.00	---	---	---	---	---	74.00	54.00	---	---
12205.00	---	---	---	---	---	74.00	54.00	---	---
14646.00	---	---	---	---	---	74.00	54.00	---	---
17087.00	---	---	---	---	---	74.00	54.00	---	---
19528.00	---	---	---	---	---	74.00	54.00	---	---
21969.00	---	---	---	---	---	74.00	54.00	---	---
24410.00	---	---	---	---	---	74.00	54.00	---	---

Notes:

1. Measuring frequencies from 1 GHz to the 10th harmonic of highest fundamental frequency.
2. Data of measurement within this frequency range shown " --- " in the table above means the reading of emissions are attenuated more than 20dB below the permissible limits or the field strength is too small to be measured.
3. Radiated emissions measured in frequency above 1000MHz were made with an instrument using Peak detector mode and average detector mode of the emission shown in Actual FS column.
4. Spectrum Peak Setting 1GHz - 26GHz, RBW = 1MHz, VBW = 1MHz, Sweep time = 200 ms.
5. Spectrum AV Setting 1GHz - 26GHz, RBW = 1MHz, VBW = 10Hz, Sweep time = 200 ms



Operation Mode: TX CH Mid Mode **Test Date:** September 1, 2003
Temperature: 20°C **Tested by:** Roy
Humidity: 70 % RH **Polarity:** Hor.

Freq. (MHz)	Peak	AV	Ant./CL CF(dB)	Actual FS		Peak	AV	Margin (dB)	Remark
	Reading (dBuV)	Reading (dBuV)		Peak (dBuV/m)	AV (dBuV/m)	Limit (dBuV/m)	Limit (dBuV/m)		
4882.00	---	---	---	---	---	74.00	54.00	---	---
7323.00	---	---	---	---	---	74.00	54.00	---	---
9764.00	---	---	---	---	---	74.00	54.00	---	---
12205.00	---	---	---	---	---	74.00	54.00	---	---
14646.00	---	---	---	---	---	74.00	54.00	---	---
17087.00	---	---	---	---	---	74.00	54.00	---	---
19528.00	---	---	---	---	---	74.00	54.00	---	---
21969.00	---	---	---	---	---	74.00	54.00	---	---
24410.00	---	---	---	---	---	74.00	54.00	---	---

Notes:

1. Measuring frequencies from 1 GHz to the 10th harmonic of highest fundamental frequency.
2. Data of measurement within this frequency range shown " --- " in the table above means the reading of emissions are attenuated more than 20dB below the permissible limits or the field strength is too small to be measured.
3. Radiated emissions measured in frequency above 1000MHz were made with an instrument using Peak detector mode and average detector mode of the emission shown in Actual FS column.
4. Spectrum Peak Setting 1GHz - 26GHz, RBW = 1MHz, VBW = 1MHz, Sweep time = 200 ms.
5. Spectrum AV Setting 1GHz - 26GHz, RBW = 1MHz, VBW = 10Hz, Sweep time = 200 ms



Operation Mode: TX CH High Mode **Test Date:** September 1, 2003
Temperature: 20°C **Tested by:** Roy
Humidity: 70 % RH **Polarity:** Ver.

Freq. (MHz)	Peak	AV	Ant./CL CF(dB)	Actual FS		Peak	AV	Margin (dB)	Remark
	Reading (dBuV)	Reading (dBuV)		Peak (dBuV/m)	AV (dBuV/m)	Limit (dBuV/m)	Limit (dBuV/m)		
2452.00	43.81	---	-2.91	40.90	---	74.00	54.00	-13.10	Peak
4960.00	---	---	---	---	---	74.00	54.00	---	---
7440.00	---	---	---	---	---	74.00	54.00	---	---
9920.00	---	---	---	---	---	74.00	54.00	---	---
12400.00	---	---	---	---	---	74.00	54.00	---	---
14880.00	---	---	---	---	---	74.00	54.00	---	---
17360.00	---	---	---	---	---	74.00	54.00	---	---
19840.00	---	---	---	---	---	74.00	54.00	---	---
22320.00	---	---	---	---	---	74.00	54.00	---	---
24800.00	---	---	---	---	---	74.00	54.00	---	---

Notes:

1. Measuring frequencies from 1 GHz to the 10th harmonic of highest fundamental frequency.
2. Data of measurement within this frequency range shown " --- " in the table above means the reading of emissions are attenuated more than 20dB below the permissible limits or the field strength is too small to be measured.
3. Radiated emissions measured in frequency above 1000MHz were made with an instrument using Peak detector mode and average detector mode of the emission shown in Actual FS column.
4. Spectrum Peak Setting 1GHz - 26GHz, RBW = 1MHz, VBW = 1MHz, Sweep time = 200 ms.
5. Spectrum AV Setting 1GHz - 26GHz, RBW = 1MHz, VBW = 10Hz, Sweep time = 200 ms



Operation Mode: TX CH High Mode **Test Date:** September 1, 2003
Temperature: 20°C **Tested by:** Roy
Humidity: 70 % RH **Polarity:** Hor.

Freq. (MHz)	Peak	AV	Ant./CL CF(dB)	Actual FS		Peak	AV	Margin (dB)	Remark
	Reading (dBuV)	Reading (dBuV)		Peak (dBuV/m)	AV (dBuV/m)	Limit (dBuV/m)	Limit (dBuV/m)		
4960.00	---	---	---	---	---	74.00	54.00	---	---
7440.00	---	---	---	---	---	74.00	54.00	---	---
9920.00	---	---	---	---	---	74.00	54.00	---	---
12400.00	---	---	---	---	---	74.00	54.00	---	---
14880.00	---	---	---	---	---	74.00	54.00	---	---
17360.00	---	---	---	---	---	74.00	54.00	---	---
19840.00	---	---	---	---	---	74.00	54.00	---	---
22320.00	---	---	---	---	---	74.00	54.00	---	---
24800.00	---	---	---	---	---	74.00	54.00	---	---

Notes:

1. Measuring frequencies from 1 GHz to the 10th harmonic of highest fundamental frequency.
2. Data of measurement within this frequency range shown " --- " in the table above means the reading of emissions are attenuated more than 20dB below the permissible limits or the field strength is too small to be measured.
3. Radiated emissions measured in frequency above 1000MHz were made with an instrument using Peak detector mode and average detector mode of the emission shown in Actual FS column.
4. Spectrum Peak Setting 1GHz - 26GHz, RBW = 1MHz, VBW = 1MHz, Sweep time = 200 ms.
5. Spectrum AV Setting 1GHz - 26GHz, RBW = 1MHz, VBW = 10Hz, Sweep time = 200 ms



WLAN Module Max power + Bluetooth Module mode

Operation Mode: TX CH Low Mode **Test Date:** September 5, 2003
Temperature: 20°C **Tested by:** Roy
Humidity: 70 % RH **Polarity:** Ver. / Hor.

Freq. (MHz)	Ant.Pol. H/V	Detector Mode (PK/QP)	Reading (dBuV)	Factor (dB)	Actual FS (dBuV/m)	Limit 3m (dBuV/m)	Safe Margin (dB)
137.46	V	Peak	20.51	10.96	31.47	43.50	-12.03
365.80	V	Peak	10.80	18.88	29.68	46.00	-16.32
400.80	V	Peak	14.75	20.71	35.46	46.00	-10.54
430.20	V	Peak	10.57	20.39	30.96	46.00	-15.04
500.20	V	Peak	6.11	22.52	28.63	46.00	-17.37
795.60	V	Peak	2.90	26.12	29.02	46.00	-16.98
276.24	H	Peak	10.25	15.76	26.01	46.00	-19.99
399.40	H	Peak	10.69	20.69	31.38	46.00	-14.62
500.20	H	Peak	4.11	22.52	26.63	46.00	-19.37
560.40	H	Peak	1.87	24.51	26.38	46.00	-19.62
795.60	H	Peak	5.02	26.12	31.14	46.00	-14.86

Notes:

1. Measuring frequencies from 30 MHz to the 1GHz.
2. Radiated emissions measured in frequency range from 30 MHz to 1000MHz were made with an instrument using Peak detector mode.
3. Data of measurement within this frequency range shown “ - ” in the table above means the reading of emissions are attenuated more than 20dB below the permissible limits or the field strength is too small to be measured.
4. The IF bandwidth of SPA between 30MHz to 1GHz was 100kHz.



Operation Mode: TX CH Mid Mode **Test Date:** September 5, 2003
Temperature: 20°C **Tested by:** Roy
Humidity: 70 % RH **Polarity:** Ver. / Hor.

Freq. (MHz)	Ant.Pol. H/V	Detector Mode (PK/QP)	Reading (dBuV)	Factor (dB)	Actual FS (dBuV/m)	Limit 3m (dBuV/m)	Safe Margin (dB)
137.46	V	Peak	20.39	10.96	31.35	43.50	-12.15
360.20	V	Peak	10.41	18.58	28.99	46.00	-17.01
365.80	V	Peak	11.37	18.88	30.25	46.00	-15.75
399.40	V	Peak	15.43	20.69	36.12	46.00	-9.88
433.00	V	Peak	10.66	20.36	31.02	46.00	-14.98
440.00	V	Peak	9.50	20.28	29.78	46.00	-16.22
399.40	H	Peak	10.40	20.69	31.09	46.00	-14.91
500.20	H	Peak	4.32	22.52	26.84	46.00	-19.16
560.40	H	Peak	2.09	24.51	26.60	46.00	-19.40
799.80	H	Peak	5.03	26.14	31.17	46.00	-14.83

Notes:

1. Measuring frequencies from 30 MHz to the 1GHz.
2. Radiated emissions measured in frequency range from 30 MHz to 1000MHz were made with an instrument using Peak detector mode.
3. Data of measurement within this frequency range shown “ - ” in the table above means the reading of emissions are attenuated more than 20dB below the permissible limits or the field strength is too small to be measured.
4. The IF bandwidth of SPA between 30MHz to 1GHz was 100kHz.



Operation Mode: TX CH High Mode **Test Date:** September 5, 2003
Temperature: 20°C **Tested by:** Roy
Humidity: 70 % RH **Polarity:** Ver. / Hor.

Freq. (MHz)	Ant.Pol. H/V	Detector Mode (PK/QP)	Reading (dBuV)	Factor (dB)	Actual FS (dBuV/m)	Limit 3m (dBuV/m)	Safe Margin (dB)
137.46	V	Peak	20.55	10.96	31.51	43.50	-11.99
365.80	V	Peak	11.69	18.88	30.57	46.00	-15.43
400.80	V	Peak	14.70	20.71	35.41	46.00	-10.59
430.20	V	Peak	10.45	20.39	30.84	46.00	-15.16
440.00	V	Peak	10.15	20.28	30.43	46.00	-15.57
798.40	V	Peak	2.84	26.13	28.97	46.00	-17.03
398.00	H	Peak	10.05	20.61	30.66	46.00	-15.34
500.20	H	Peak	4.39	22.52	26.91	46.00	-19.09
560.40	H	Peak	1.73	24.51	26.24	46.00	-19.76
799.80	H	Peak	5.82	26.14	31.96	46.00	-14.04

Notes:

1. Measuring frequencies from 30 MHz to the 1GHz.
2. Radiated emissions measured in frequency range from 30 MHz to 1000MHz were made with an instrument using Peak detector mode.
3. Data of measurement within this frequency range shown “ - ” in the table above means the reading of emissions are attenuated more than 20dB below the permissible limits or the field strength is too small to be measured.
4. The IF bandwidth of SPA between 30MHz to 1GHz was 100kHz.



Above 1 GHz

Operation Mode: TX CH Low Mode **Test Date:** September 5, 2003
Temperature: 20°C **Tested by:** Roy
Humidity: 70% RH **Polarity:** Ver.

Freq. (MHz)	Peak	AV	Ant./CL CF(dB)	Actual FS		Peak	AV	Margin (dB)	Remark
	Reading (dBuV)	Reading (dBuV)		Peak (dBuV/m)	AV (dBuV/m)	Limit (dBuV/m)	Limit (dBuV/m)		
1600.00	45.48	---	-6.79	38.69	---	74.00	54.00	-15.31	Peak
4804.00	---	---	---	---	---	74.00	54.00	---	---
7206.00	---	---	---	---	---	74.00	54.00	---	---
9608.00	---	---	---	---	---	74.00	54.00	---	---
12010.00	---	---	---	---	---	74.00	54.00	---	---
14412.00	---	---	---	---	---	74.00	54.00	---	---
16814.00	---	---	---	---	---	74.00	54.00	---	---
19216.00	---	---	---	---	---	74.00	54.00	---	---
21618.00	---	---	---	---	---	74.00	54.00	---	---
24020.00	---	---	---	---	---	74.00	54.00	---	---

Notes:

1. Measuring frequencies from 1 GHz to the 10th harmonic of highest fundamental frequency.
2. Data of measurement within this frequency range shown “ --- ” in the table above means the reading of emissions are attenuated more than 20dB below the permissible limits or the field strength is too small to be measured.
3. Radiated emissions measured in frequency above 1000MHz were made with an instrument using Peak detector mode and average detector mode of the emission shown in Actual FS column.
4. Spectrum Peak Setting 1GHz - 26GHz, RBW = 1MHz, VBW = 1MHz, Sweep time = 200 ms.
5. Spectrum AV Setting 1GHz - 26GHz, RBW = 1MHz, VBW = 10Hz, Sweep time = 200 ms



Operation Mode: TX CH Low Mode **Test Date:** September 5, 2003
Temperature: 20°C **Tested by:** Roy
Humidity: 70 % RH **Polarity:** Hor.

Freq. (MHz)	Peak	AV	Ant./CL CF(dB)	Actual FS		Peak	AV	Margin (dB)	Remark
	Reading (dBuV)	Reading (dBuV)		Peak (dBuV/m)	AV (dBuV/m)	Limit (dBuV/m)	Limit (dBuV/m)		
4804.00	---	---	---	---	---	74.00	54.00	---	---
7206.00	---	---	---	---	---	74.00	54.00	---	---
9608.00	---	---	---	---	---	74.00	54.00	---	---
12010.00	---	---	---	---	---	74.00	54.00	---	---
14412.00	---	---	---	---	---	74.00	54.00	---	---
16814.00	---	---	---	---	---	74.00	54.00	---	---
19216.00	---	---	---	---	---	74.00	54.00	---	---
21618.00	---	---	---	---	---	74.00	54.00	---	---
24020.00	---	---	---	---	---	74.00	54.00	---	---

Notes:

1. Measuring frequencies from 1 GHz to the 10th harmonic of highest fundamental frequency.
2. Data of measurement within this frequency range shown “ --- ” in the table above means the reading of emissions are attenuated more than 20dB below the permissible limits or the field strength is too small to be measured.
3. Radiated emissions measured in frequency above 1000MHz were made with an instrument using Peak detector mode and average detector mode of the emission shown in Actual FS column.
4. Spectrum Peak Setting 1GHz - 26GHz, RBW = 1MHz, VBW = 1MHz, Sweep time = 200 ms.
5. Spectrum AV Setting 1GHz - 26GHz, RBW = 1MHz, VBW = 10Hz, Sweep time = 200 ms



Operation Mode: TX CH Mid Mode **Test Date:** September 5, 2003
Temperature: 20°C **Tested by:** Roy
Humidity: 70 % RH **Polarity:** Ver.

Freq. (MHz)	Peak	AV	Ant./CL CF(dB)	Actual FS		Peak	AV	Margin (dB)	Remark
	Reading (dBuV)	Reading (dBuV)		Peak (dBuV/m)	AV (dBuV/m)	Limit (dBuV/m)	Limit (dBuV/m)		
4882.00	---	---	---	---	---	74.00	54.00	---	---
7323.00	---	---	---	---	---	74.00	54.00	---	---
9764.00	---	---	---	---	---	74.00	54.00	---	---
12205.00	---	---	---	---	---	74.00	54.00	---	---
14646.00	---	---	---	---	---	74.00	54.00	---	---
17087.00	---	---	---	---	---	74.00	54.00	---	---
19528.00	---	---	---	---	---	74.00	54.00	---	---
21969.00	---	---	---	---	---	74.00	54.00	---	---
24410.00	---	---	---	---	---	74.00	54.00	---	---

Notes:

1. Measuring frequencies from 1 GHz to the 10th harmonic of highest fundamental frequency.
2. Data of measurement within this frequency range shown " --- " in the table above means the reading of emissions are attenuated more than 20dB below the permissible limits or the field strength is too small to be measured.
3. Radiated emissions measured in frequency above 1000MHz were made with an instrument using Peak detector mode and average detector mode of the emission shown in Actual FS column.
4. Spectrum Peak Setting 1GHz - 26GHz, RBW = 1MHz, VBW = 1MHz, Sweep time = 200 ms.
5. Spectrum AV Setting 1GHz - 26GHz, RBW = 1MHz, VBW = 10Hz, Sweep time = 200 ms



Operation Mode: TX CH Mid Mode **Test Date:** September 5, 2003
Temperature: 20°C **Tested by:** Roy
Humidity: 70 % RH **Polarity:** Hor.

Freq. (MHz)	Peak	AV	Ant./CL CF(dB)	Actual FS		Peak	AV	Margin (dB)	Remark
	Reading (dBuV)	Reading (dBuV)		Peak (dBuV/m)	AV (dBuV/m)	Limit (dBuV/m)	Limit (dBuV/m)		
4882.00	---	---	---	---	---	74.00	54.00	---	---
7323.00	---	---	---	---	---	74.00	54.00	---	---
9764.00	---	---	---	---	---	74.00	54.00	---	---
12205.00	---	---	---	---	---	74.00	54.00	---	---
14646.00	---	---	---	---	---	74.00	54.00	---	---
17087.00	---	---	---	---	---	74.00	54.00	---	---
19528.00	---	---	---	---	---	74.00	54.00	---	---
21969.00	---	---	---	---	---	74.00	54.00	---	---
24410.00	---	---	---	---	---	74.00	54.00	---	---

Notes:

1. Measuring frequencies from 1 GHz to the 10th harmonic of highest fundamental frequency.
2. Data of measurement within this frequency range shown " --- " in the table above means the reading of emissions are attenuated more than 20dB below the permissible limits or the field strength is too small to be measured.
3. Radiated emissions measured in frequency above 1000MHz were made with an instrument using Peak detector mode and average detector mode of the emission shown in Actual FS column.
4. Spectrum Peak Setting 1GHz - 26GHz, RBW = 1MHz, VBW = 1MHz, Sweep time = 200 ms.
5. Spectrum AV Setting 1GHz - 26GHz, RBW = 1MHz, VBW = 10Hz, Sweep time = 200 ms



Operation Mode: TX CH High Mode **Test Date:** September 5, 2003
Temperature: 20°C **Tested by:** Roy
Humidity: 70 % RH **Polarity:** Ver.

Freq. (MHz)	Peak	AV	Ant./CL CF(dB)	Actual FS		Peak	AV	Margin (dB)	Remark
	Reading (dBuV)	Reading (dBuV)		Peak (dBuV/m)	AV (dBuV/m)	Limit (dBuV/m)	Limit (dBuV/m)		
4960.00	---	---	---	---	---	74.00	54.00	---	---
7440.00	---	---	---	---	---	74.00	54.00	---	---
9920.00	---	---	---	---	---	74.00	54.00	---	---
12400.00	---	---	---	---	---	74.00	54.00	---	---
14880.00	---	---	---	---	---	74.00	54.00	---	---
17360.00	---	---	---	---	---	74.00	54.00	---	---
19840.00	---	---	---	---	---	74.00	54.00	---	---
22320.00	---	---	---	---	---	74.00	54.00	---	---
24800.00	---	---	---	---	---	74.00	54.00	---	---

Notes:

1. Measuring frequencies from 1 GHz to the 10th harmonic of highest fundamental frequency.
2. Data of measurement within this frequency range shown " --- " in the table above means the reading of emissions are attenuated more than 20dB below the permissible limits or the field strength is too small to be measured.
3. Radiated emissions measured in frequency above 1000MHz were made with an instrument using Peak detector mode and average detector mode of the emission shown in Actual FS column.
4. Spectrum Peak Setting 1GHz - 26GHz, RBW = 1MHz, VBW = 1MHz, Sweep time = 200 ms.
5. Spectrum AV Setting 1GHz - 26GHz, RBW = 1MHz, VBW = 10Hz, Sweep time = 200 ms



Operation Mode: TX CH High Mode **Test Date:** September 5, 2003
Temperature: 20°C **Tested by:** Roy
Humidity: 70 % RH **Polarity:** Hor.

Freq. (MHz)	Peak	AV	Ant./CL CF(dB)	Actual FS		Peak	AV	Margin (dB)	Remark
	Reading (dBuV)	Reading (dBuV)		Peak (dBuV/m)	AV (dBuV/m)	Limit (dBuV/m)	Limit (dBuV/m)		
1600.00	46.12	---	-6.79	39.33	---	74.00	54.00	-14.67	Peak
4960.00	---	---	---	---	---	74.00	54.00	---	---
7440.00	---	---	---	---	---	74.00	54.00	---	---
9920.00	---	---	---	---	---	74.00	54.00	---	---
12400.00	---	---	---	---	---	74.00	54.00	---	---
14880.00	---	---	---	---	---	74.00	54.00	---	---
17360.00	---	---	---	---	---	74.00	54.00	---	---
19840.00	---	---	---	---	---	74.00	54.00	---	---
22320.00	---	---	---	---	---	74.00	54.00	---	---
24800.00	---	---	---	---	---	74.00	54.00	---	---

Notes:

1. Measuring frequencies from 1 GHz to the 10th harmonic of highest fundamental frequency.
2. Data of measurement within this frequency range shown " --- " in the table above means the reading of emissions are attenuated more than 20dB below the permissible limits or the field strength is too small to be measured.
3. Radiated emissions measured in frequency above 1000MHz were made with an instrument using Peak detector mode and average detector mode of the emission shown in Actual FS column.
4. Spectrum Peak Setting 1GHz - 26GHz, RBW = 1MHz, VBW = 1MHz, Sweep time = 200 ms.
5. Spectrum AV Setting 1GHz - 26GHz, RBW = 1MHz, VBW = 10Hz, Sweep time = 200 ms



7.14 POWERLINE CONDUCTED EMISSIONS

LIMIT

For an intentional radiator which is designed to be connected to the public utility (AC) power line, the radio frequency voltage that is conducted back onto the AC power line on any frequency or frequencies within the band 150 kHz to 30 MHz shall not exceed 250 microvolts (The limit decreases linearly with the logarithm of the frequency in the range 0.15 MHz to 0.50 MHz). The limits at specific frequency range is listed as follows:

Frequency Range (MHz)	Limits (dBµV)	
	Quasi-peak	Average
0.15 to 0.50	66 to 56	56 to 46
0.50 to 5	56	46
5 to 30	60	50

Compliance with this provision shall be based on the measurement of the radio frequency voltage between each power line (LINE and NEUTRAL) and ground at the power terminals.

MEASUREMENT EQUIPMENT USED

Name of Equipment	Manufacturer	Model	Serial Number	Calibration Due
EMI Test Receiver	R&S	ESCS30	847793/012	12/20/2003
LISN	R&S	ESH2-Z5	843285/010	12/15/2003
LISN	EMCO	3825/2	9003-1628	07/25/2004

Remark: Each piece of equipment is scheduled for calibration once a year.



Test Configuration

1. The conducted emission tests were performed in the test site, using the setup in accordance with the ANSI C63.4-1992.
2. The EUT was plug-in the host PC via USB port. The host PC system was placed on the center of the back edge on the test table. The peripherals like modem, monitor printer, K/B, and mouse were placed on the side of the host PC system. The rear of the EUT and peripherals were placed flushed with the rear of the tabletop.
3. The keyboard was placed directly in the front of the monitor, flushed with the front tabletop. The mouse was placed next to the Keyboard, flushed with the back of keyboard.
4. The spacing between the peripherals was 10 centimeters.
5. External I/O cables were draped along the edge of the test table and bundle when necessary.
6. The host PC system was connected with 110Vac/60Hz power source.

The EUT is set to transmit in a continuous mode.

Test Procedure

1. The EUT was placed on a table, which is 0.8m above ground plane.
2. Maximum procedure was performed on the six highest emissions to ensure EUT compliance.
3. Repeat above procedures until all frequency measured were complete.



TEST RESULTS

The initial step in collecting conducted data is a spectrum analyzer peak scan of the measurement range. Significant peaks are then marked as shown on the following data page, and these signals are then quasi-peaked.

Operation Mode: TX + RX mode **Test Date:** August 21, 2003
Temperature: 25°C **Tested by:** Roy
Humidity: 70% RH

FREQ MHz	Q.P. Raw dBuV	AVG Raw dBuV	Q.P. Limit dBuV	AVG Limit dBuV	Q.P. Margin dB	AVG Margin dB	NOTE
0.152	50.60	---	65.89	55.89	-15.29	---	L1
0.420	41.40	---	57.45	47.45	-16.05	---	L1
0.564	39.60	---	56.00	46.00	-16.40	---	L1
0.734	39.80	---	56.00	46.00	-16.20	---	L1
0.842	38.80	---	56.00	46.00	-17.20	---	L1
2.003	38.80	---	56.00	46.00	-17.20	---	L1
0.151	51.80	---	65.94	55.94	-14.14	---	L2
0.248	43.60	---	61.82	51.82	-18.22	---	L2
0.306	41.40	---	60.08	50.08	-18.68	---	L2
0.421	39.80	---	57.43	47.43	-17.63	---	L2
0.567	38.60	---	56.00	46.00	-17.40	---	L2
3.109	38.80	---	56.00	46.00	-17.20	---	L2

Note:

1. Measuring frequencies from 0.15 MHz to 30MHz.
2. The emissions measured in frequency range from 0.15 MHz to 30MHz were made with an instrument using Quasi-peak detector and average detector.
3. “---” denotes the emission level was or more than 2dB below the Average limit
4. The IF bandwidth of SPA between 0.15MHz to 30MHz was 10kHz; the IF bandwidth of Test Receiver between 0.15MHz to 30MHz was 9kHz;
5. L1 = Line One (Live Line) / L2 = Line Two (Neutral Line)



Test Data Plots

Conducted emissions (Line 1)

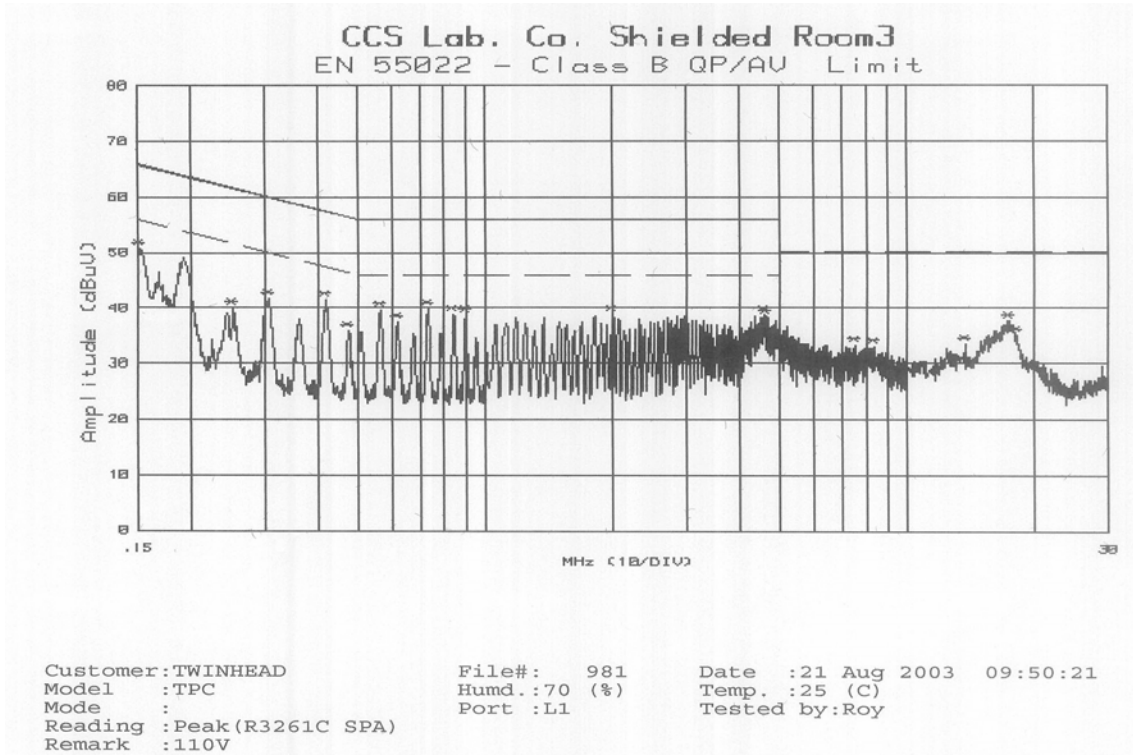

Conducted emissions (Line 2)

