



AEGIS LABS INC.



Modular Approval
Test Report
And Application for Grant of Equipment Authorization

Pertaining To:

EUT	FCC ID:
Intel PRO/Wireless 3945ABG Network Connection, MN: WM3945ABG	PD9WM3945ABG

Configuration
802.11a / 802.11b / 802.11g with a set of Ethertronics Antennas

MEASUREMENTS PERFORMED IN ACCORDANCE WITH

Regulatory Standard(s)
47 CFR Part 15, Subpart C Section 15.247
<p>Test Method: ANSI C63.4: 2003 American National Standard for Methods of Measurement of Radio-Noise Emissions from Low-Voltage Electrical and Electronic Equipment in the Range of 9 kHz to 40 GHz</p>



Certificate Number: 1111.01

APPLICANT:

Intel Corporation
2111 NE 25th Avenue
Hillsboro, Oregon 97124

Contact(s): Mr. Robert Paxman

PREPARED BY:

Aegis Labs, Inc.
22431 Antonio Parkway B160-417
Rancho S. Margarita, CA 92688

Agent(s): Mr. Steve Kuiper
Mr. Rick Candelas
Mr. Johnny Candelas

Test Report #: INTEL-050901F
Test Report Revision: None

	REPORT BODY	APPENDICES <i>A</i>	TOTAL PAGES
PAGES	18	75	93

The contents of this report shall not be reproduced except in full, without the written approval of Aegis Labs, Inc.

Page 1 of 18
Report Number: INTEL-050901F
FCC ID: PD9WM3945ABG



TABLE OF CONTENTS

SECTION	TITLE	PAGE
	COVER SHEET.....	01
	TABLE OF CONTENTS.....	02
1.0	CERTIFICATION OF TEST DATA.....	03
2.0	SUMMARY OF TEST RESULTS.....	06
3.0	ADMINISTRATIVE DATA AND TEST DESCRIPTION.....	07
4.0	DESCRIPTION OF EUT.....	08
4.1	EUT Description.....	08
4.1.1	Channel Number and Frequencies.....	09
4.2	EUT Configuration.....	10
4.3	List of EUT Sub-Assemblies and Host Equipment.....	11
4.4	I/O Cabling Diagram and Description.....	12
5.0	TEST EQUIPMENT AND TEST SETUPS.....	13
5.1	AC Power Line Conducted Emissions.....	13
5.2	Spurious Radiated Emissions.....	14
5.3	Conducted Emissions At The Antenna Port.....	14
5.4	Test and Measurement Equipment Used.....	15
6.0	SAMPLE CALCULATIONS.....	16
7.0	MODIFICATIONS AND RECOMMENDATIONS.....	18

APPENDICES

A	Test Data
----------	-----------



AEGIS LABS INC.

1.0 CERTIFICATION OF TEST DATA

Aegis Labs, Inc. operates as both a Nevada and California Corporation with no organizational or financial relationship with any company, institution, or private individual.

Testing and engineering functions provided by Aegis Labs are furnished through the use of part-time, full-time or consulting engineers with the appropriate qualifications to carry out their duties. The intended purpose of this test report is to describe the measurement procedure and to determine whether the equipment under test "EUT" complies with both the conducted and radiated limits. Limits for emissions testing are described under Subpart C of Part 15 of the FCC rules.

The data, data evaluation and equipment configuration represented herein are a true and accurate representation of the Equipment Under Test (EUT) under the requirements specified in the emissions standard as described below. The test results contained in this report are only representative of the test sample tested as described in Section 3.0 of this report. Certification of the EUT is required as a prerequisite to marketing as defined in Part 2 of the FCC Rules.

Prepared By:

Johnny Candelas
Test Technician
Aegis Labs, Inc.

09/06/05

Date:

Reviewed By:

Rick Candelas
Lab Manager
Aegis Labs, Inc.

09/06/05

Date:

Report Approved By:

Steve J. Kuiper
Quality Assurance Manager
Aegis Labs, Inc.

09/06/05

Date:

Page 3 of 18

Report Number: INTEL-050901F

FCC ID: PD9WM3945ABG



AEGIS LABS INC.

2.0 SUMMARY OF TEST RESULTS

The test results provided within this report, indicate that the EUT has been found to be in **COMPLIANCE** with the test specifications based upon the following RF compliance standards:

Pass/Fail determination is based upon the nominal values of the test data.

802.11a Mode (5745-5825 MHz)

EMISSIONS STANDARD			
FCC Part 15 Section	Description	Results	Comments
15.247(a)(2)	The minimum 6dB bandwidth shall be at least 500 kHz.	PASSED	5745 MHz = 16.58 MHz 5785 MHz = 16.67 MHz 5825 MHz = 16.67 MHz
15.247(b)(1)	The maximum peak output power of the intentional radiator shall not exceed 1 watt.	PASSED	5745 MHz = 19.30 dBm = 85.11 mW 5785 MHz = 20.00 dBm = 100.00 mW 5825 MHz = 19.60 dBm = 91.20 mW
15.247(b)(4)	The intentional radiator shall be operated in a manner that ensures that the public is not exposed to radio frequency energy levels in excess of the FCC guidelines per Section 1.1307(b)(1).	PASSED	Refer to MPE Calculations Exhibit
15.247(c)	In any 100 kHz bandwidth outside the frequency band in which the spread spectrum intentional radiator is operating, the radio frequency power that is produced by the intentional radiator shall be at least 20 dB below that in the 100 kHz bandwidth within the band that contains the highest level of the desired power.	PASSED	See Data Sheets
15.247(c)	Radiated emissions, which fall in the restricted bands, as defined in Sec. 15.205(a), must also comply with the radiated emission limits specified in Sec. 15.209(a). All others must be < -20dBc.	PASSED	See Data Sheets
15.247(d)	The peak power spectral density conducted from the intentional radiator to the antenna shall not be greater than 8 dBm in any 3 kHz band during any time interval of continuous transmission.	PASSED	5745 MHz = -8.50 dB 5785 MHz = -9.50 dB 5825 MHz = -9.83 dB
15.207	AC Conducted Emissions	PASSED	See Data Sheets
15.209	Radiated Emissions (30-1000 MHz)	PASSED	See Data Sheets

Page 4 of 18

Report Number: INTEL-050901F

FCC ID: PD9WM3945ABG



AEGIS LABS INC.

2.0 Summary of Test Results (Continued)

The test results provided within this report, indicate that the EUT has been found to be in **COMPLIANCE** with the test specifications based upon the following RF compliance standards:

Pass/Fail determination is based upon the nominal values of the test data.

802.11b Mode (2412-2462 MHz)

EMISSIONS STANDARD			
FCC Part 15 Section	Description	Results	Comments
15.247(a)(2)	The minimum 6dB bandwidth shall be at least 500 kHz.	PASSED	2412 MHz = 8.33 MHz 2437 MHz = 8.83 MHz 2462 MHz = 9.17 MHz
15.247(b)(1)	The maximum peak output power of the intentional radiator shall not exceed 1 watt.	PASSED	2412 MHz = 19.72 dBm = 93.76 mW 2437 MHz = 20.54 dBm = 113.24 mW 2462 MHz = 20.43 dBm = 110.41 mW
15.247(b)(4)	The intentional radiator shall be operated in a manner that ensures that the public is not exposed to radio frequency energy levels in excess of the FCC guidelines per Section 1.1307(b)(1).	PASSED	Refer to MPE Calculations Exhibit
15.247(c)	In any 100 kHz bandwidth outside the frequency band in which the spread spectrum intentional radiator is operating, the radio frequency power that is produced by the intentional radiator shall be at least 20 dB below that in the 100 kHz bandwidth within the band that contains the highest level of the desired power.	PASSED	See Data Sheets
15.247(c)	Radiated emissions, which fall in the restricted bands, as defined in Sec. 15.205(a), must also comply with the radiated emission limits specified in Sec. 15.209(a). All others must be < -20dBc.	PASSED	See Data Sheets
15.247(d)	The peak power spectral density conducted from the intentional radiator to the antenna shall not be greater than 8 dBm in any 3 kHz band during any time interval of continuous transmission.	PASSED	2412 MHz = -10.33 dB 2437 MHz = -7.83 dB 2462 MHz = -8.83 dB
15.207	AC Conducted Emissions	PASSED	See Data Sheets
15.209	Radiated Emissions (30-1000 MHz)	PASSED	See Data Sheets

Page 5 of 18

Report Number: INTEL-050901F

FCC ID: PD9WM3945ABG



AEGIS LABS INC.

2.0 Summary of Test Results (Continued)

The test results provided within this report, indicate that the EUT has been found to be in **COMPLIANCE** with the test specifications based upon the following RF compliance standards:

Pass/Fail determination is based upon the nominal values of the test data.

802.11g Mode (2412-2462 MHz)

EMISSIONS STANDARD			
FCC Part 15 Section	Description	Results	Comments
15.247(a)(2)	The minimum 6dB bandwidth shall be at least 500 kHz.	PASSED	2412 MHz = 16.58 MHz 2437 MHz = 16.67 MHz 2462 MHz = 16.67 MHz
15.247(b)(1)	The maximum peak output power of the intentional radiator shall not exceed 1 watt.	PASSED	2412 MHz = 24.38 dBm = 274.16 mW 2437 MHz = 25.02 dBm = 317.69 mW 2462 MHz = 24.21 dBm = 263.63 mW
15.247(b)(4)	The intentional radiator shall be operated in a manner that ensures that the public is not exposed to radio frequency energy levels in excess of the FCC guidelines per Section 1.1307(b)(1).	PASSED	Refer to MPE Calculations Exhibit
15.247(c)	In any 100 kHz bandwidth outside the frequency band in which the spread spectrum intentional radiator is operating, the radio frequency power that is produced by the intentional radiator shall be at least 20 dB below that in the 100 kHz bandwidth within the band that contains the highest level of the desired power.	PASSED	See Data Sheets
15.247(c)	Radiated emissions, which fall in the restricted bands, as defined in Sec. 15.205(a), must also comply with the radiated emission limits specified in Sec. 15.209(a). All others must be < -20dBc.	PASSED	See Data Sheets
15.247(d)	The peak power spectral density conducted from the intentional radiator to the antenna shall not be greater than 8 dBm in any 3 kHz band during any time interval of continuous transmission.	PASSED	2412 MHz = -9.17 dB 2437 MHz = -8.17 dB 2462 MHz = -9.17 dB
15.207	AC Conducted Emissions	PASSED	See Data Sheets
15.209	Radiated Emissions (30-1000 MHz)	PASSED	See Data Sheets

Page 6 of 18

Report Number: INTEL-050901F

FCC ID: PD9WM3945ABG



AEGIS LABS INC.

3.0 ADMINISTRATIVE DATA AND TEST DESCRIPTION

DEVICE TESTED:	ITE Type: Intel PRO/Wireless 3945ABG Network Connection Model Number(s): WM3945ABG Serial Number: 00B11A295CVD26965002 FCC ID: PD9WM3945ABG
TEST DATE (S):	July 26- September 7, 2005
DATE EUT RECEIVED:	July 21, 2005
ORIGIN OF TEST SAMPLE(S):	Production Unit
RESPONSIBLE PARTY:	Intel Corporation 2111 NE 25 th Avenue Hillsboro, Oregon 97124
CLIENT CONTACT:	Mr. Robert Paxman
MANUFACTURER:	Intel Corporation
TEST LOCATION:	Aegis Labs, Inc. 32231 Trabuco Creek Road Trabuco Canyon, CA 92678 Conducted Site #2 Radiated Site #2
A2LA CERTIFICATE:	1111.01, Valid through February 28, 2006
PURPOSE OF TEST:	To demonstrate compliance with the relevant standards described in Section 2.0 of this report.
TEST(S) PERFORMED:	Refer to Table in Section 2.0 of this report.

All calibration vendors were responsible for certifying Aegis Labs, Inc. test equipment as per the manufacturer's specifications and that the equipment is calibrated using instruments and standards where the accuracy is traceable to the National Institute of Standards and Technology (NIST). Calibration of all test equipment conforms to ANSI/NCSL Z540-1 and ISO 10012-1 and/or ISO/IEC Guide 17025 compliance (Additionally, other pertinent test equipment will carry MIL-STD-45662A). All calibration documents are on file with Aegis Labs, Inc., with copies provided upon request.

Page 7 of 18
Report Number: INTEL-050901F
FCC ID: PD9WM3945ABG



AEGIS LABS INC.

4.0 DESCRIPTION OF EUT

4.1 EUT Description

Equipment Under Test (EUT)	
Trade Name:	Intel PRO/Wireless 3945ABG Network Connection
Model Number:	WM3945ABG
Frequency Range:	802.11a = 5745 – 5825 MHz 802.11b/g = 2412 – 2462MHz
Type of Transmission:	Direct Sequence Spread Spectrum
Transfer Rate:	1/5.5/11 Mbps for 802.11b mode 6/36/54 Mbps for 802.11g and 802.11a modes
Number of Channels:	802.11a mode (5725-5850 MHz) = 5 802.11b mode (2400-2483.5 MHz) = 11 802.11g mode (2400-2483.5 MHz)= 11
Modulation Type:	DBPSK, DQPSK, CCK, OFDM
Antenna Type:	Hirose U.FL-R-SMT mates with cable connector U.FL-LP-066
Antenna Gain (See Note 2):	Ethertronics Antenna @ 5 GHz = 5.00 dBi Ethertronics Antenna @ 2.4 GHz = 3.00 dBi
Transmit Output Power:	18-20 dBm (Typical) for 802.11a mode 20 dBm (Typical) for 802.11b mode 24-25 dBm (Typical) for 802.11g mode Please see Appendix A (Data Sheets) for actual output power.
Power Supply:	3.3VDC from computer MPCPI slot.
Number of External Test Ports Exercised:	2 Antenna Ports (1 Main & 1 Auxiliary)

The Intel PRO/Wireless 3945ABG Network Connection is an embedded 802.11 a/b/g network adapter operating in the 2.4 GHz and 5 GHz spectrum. The EUT is based on the Mini Card form factor designed to meet the space and size requirements for thin and light notebook PCs. It is capable of a data rate of up to 52 Mbps.

NOTE 1: For a more detailed description, please refer to the manufacture's specifications or User's Manual.

NOTE 2: The EUT was tested with a set of antennas. (Refer to the antenna specifications exhibits).

Page 8 of 18

Report Number: INTEL-050901F

FCC ID: PD9WM3945ABG



4.1.1 Channel Number and Frequencies

802.11a Mode		802.11b Mode		802.11g Mode	
Channel	Frequency (MHz)	Channel	Frequency (MHz)	Channel	Frequency (MHz)
149	5745	1	2412	1	2412
153	5765	2	2417	2	2417
157	5785	3	2422	3	2422
161	5805	4	2427	4	2427
165	5825	5	2432	5	2432
		6	2437	6	2437
		7	2442	7	2442
		8	2447	8	2447
		9	2452	9	2452
		10	2457	10	2457
		11	2462	11	2462



AEGIS LABS INC.

4.2 EUT Configuration

The EUT was tested installed in the Mini PCI-E slot of the host computer as a modular device using a PCI extender board to extend the EUT outside the computer chassis. The EUT was then connected to a set of antennas via its Main and AUX antenna ports. Data for a set of Ethertronics antennas can be found in Appendix A (Data Sheets)

The low, middle, and high channels were tested in 802.11a, b, & g modes. Also, the EUT was tested once transmitting from the MAIN antenna port and once transmitting from the AUX antenna port. The EUT was placed in either continuous transmit or continuous receive mode by a program provided by the manufacturer (GRTT *Version 1.1.1*).



4.3 List of EUT, Sub-Assemblies, and Host Equipment

LIST OF EUT AND SUB-ASSEMBLIES			
Equipment Name	Manufacturer	Model Number	Serial Number
Intel PRO/Wireless 3945ABG Network Connection	Intel Corporation	WM3945ABG	00B11A295CV D26965002
EUT Sub-Assemblies			
Main Multi Band Antenna	Ethertronics	MPCI01001	N/A
Auxiliary Multi Band Antenna	Ethertronics	MPCI01001	N/A

HOST EQUIPMENT LIST			
Equipment Name	Manufacturer	Model Number	Serial Number
Computer	Intel	Generic	IZTGVV4312035
Monitor	Compaq	610	712BC060B526
Keyboard	Logitech	Y-BF37	MCTZ5200581
Mouse	Logitech	M-BJ58	PMA32715049

NOTE: All the power cords of the above support equipment are standard non-shielded, 1.8 meters long.



4.4 I/O Cabling Diagram and Description

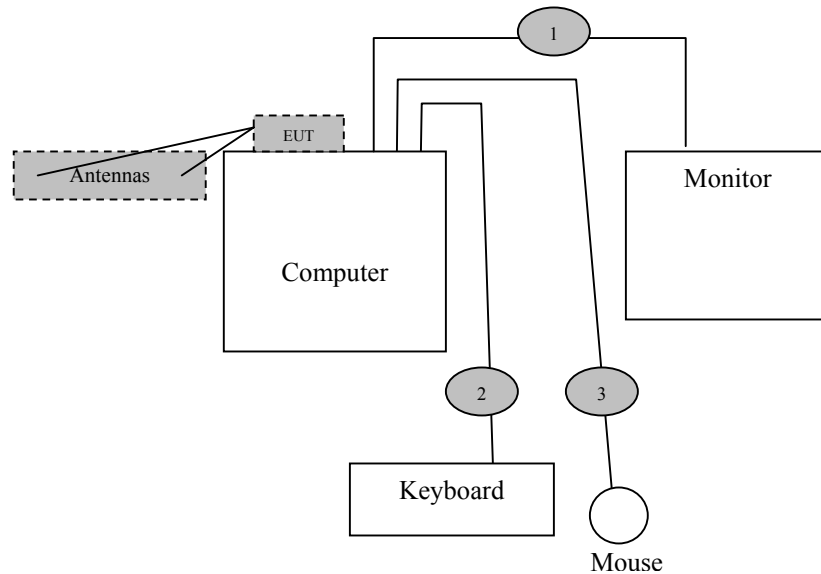

- Cable 1: This is a 6-foot braid and foil shielded round cable connecting the host computer with the monitor. It has metallic DB-15 type connector at the computer end and is hardwired to the monitor. The cable is bundled to a length of one meter and the shield of the cable is grounded to the chassis of both devices via the connector shells.
- Cable 2: This is a 6-foot braid and foil shielded round cable connecting the host computer to the keyboard. It has a metallic 6-pin mini din type connector at the computer end and is hardwired to the keyboard. The shield of the cable is grounded to the chassis of the computer via the connector shell.
- Cable 3: This is a 6-foot braid and foil shielded round cable connecting the host computer to the mouse. It has a metallic 6-pin mini din type connector at the computer end and is hardwired to the mouse. The shield of the cable is grounded to the chassis of the computer via the connector shell.



AEGIS LABS INC.

5.0 TEST EQUIPMENT AND TEST SETUPS

The test equipment settings and functions are selected using the guidance of ANSI C63.4-2003. All test equipment setups and operations during conducted and radiated emissions testing are in accordance with this reference document.

5.1 AC Power Line Conducted Emissions

During conducted emissions measurements, a spectrum analyzer was used as the measuring instrument along with a preselector and quasi-peak detector. A 10 dB attenuation pad was used for the protection of the spectrum analyzer input stage. The conducted emissions from the EUT in the frequency range from 150 kHz to 30 MHz were captured for graphical display through the use of automated LABVIEW EMI measurement software. All graphical readings were measured in the “Peak” mode only to reduce testing time. Upon completion of the graphical scan, the test lab personnel performed the conducted measurement scan manually using the spectrum analyzer front panel keys. All peak measurements coming within 3 dB of the limit line were “Averaged” and/or “Quasi-Peaked” and denoted appropriately in the EXCEL spreadsheet.

The Equipment Under Test (EUT) was configured as a system with peripherals connected, so that at least one interface port of each type is connected to one external peripheral when tested for conducted emissions according to ANSI C63.4: 2003. Excess power cord length was wrapped in a bundle 30 to 40 centimeters in length near the center of the cord. The EUT was tested in a tabletop configuration.

The emission readings for Line 1 and Line 2 are highlighted on the data sheets in Appendix A. The graphical scans only reflect peak readings while the tabulated data sheets reflect peak, average, and/or quasi-peak readings which ever applies.



AEGIS LABS INC.

5.2 Spurious Radiated Emissions

A spectrum analyzer was used as the measuring instrumentation along with a preselector and quasi-peak-detector. The pre-amplifiers were used to increase the sensitivity of the instrument. The spectrum analyzer was used in the peak detector mode with the “max-hold” feature activated and in Positive Peak mode. In this mode, the spectrum analyzer records the highest measured reading over all the sweeps. The quasi-peak detector was used only for those readings, which are marked accordingly in the data sheet. The effective measurement bandwidth used for the radiated emissions test was 120 kHz for (30 MHz- 1000 MHz). The spectrum analyzer operated such that the modulation of the signal was filtered out to set the analyzer in linear mode. For testing beyond 1000 MHz a spectrum analyzer capable of taking reading above 1000 MHz was connected to the high frequency amplifier, where these measurement readings were taken with the transducer placed at a 3-meter test distance from the EUT.

The Open Area Test Sites (OATS) was used for radiated emission testing. These test sites are designed according to ANSI C63.4: 2003 and ANSI C63.7: 1992 guidelines. The Measurements were conducted in accordance with ANSI C63.4: 2003 and ANSI C63.7: 1992 requirements.

Broadband biconical, log periodic, and horn antennas were used as transducers during the measurement reading phase. The frequency spans were wide (30 MHz-88 MHz, 88 MHz- 216 MHz, 216 MHz- 300 MHz, and 300 MHz- 1000 MHz). After 1000 MHz the horn antenna was used to measure emissions. The emission readings in both horizontal and vertical polarities are highlighted on the data sheets in Appendix A.

5.3 Conducted Emissions at the Antenna Port

A spectrum analyzer or power meter was used as the measuring instrumentation along with an attenuator and/or filter connected to the EUT antenna port. The attenuator and filters are used to ensure that the front end of the measurement instrument is not overloaded by the fundamental transmission. . The instruments recorded the measured readings with the bandwidths (video and resolution) set in accordance with the FCC Rules and regulations.

For the power out measurements in 802.11b and 802.11g modes a peak power meter was used along with a peak power sensor with a wide enough bandwidth to capture the entire fundamental transmission. For 802.11a mode a spectrum analyzer with “Channel Power Measurement” function was used to measure the peak output power.

The measured readings are on the data sheets in Appendix A.

Page 14 of 18

Report Number: INTEL-050901F

FCC ID: PD9WM3945ABG



AEGIS LABS INC.

5.4 Test and Measurement Equipment Used

TEST EQUIPMENT USED					
Equipment Name	Manufacturer	Model Number	Serial Number	Calibration Due Date	Calibration Cycle
Spectrum Analyzer	Agilent	8565EC	3946A00245	07/29/06	1 Year
Preamp	Aegis Preamplifier	Aegis-Oats1-1-18	001	07/27/06	1 Year
2.4 GHz Notch Filter	Micro-Tronics	BRM50702-02	003	04/21/06	1 Year
5.15-5.35 GHz Notch Filter	Microwave Circuits	N0452502	3173-01	06/27/06	1 Year
5.725-5.850 GHz Notch Filter	Microwave Circuits	N0257881	3173-01	06/27/06	1 Year
Horn Antenna	ETS	DRG 3117	29614	07/23/06	1 Year
Antenna - 18-26.5 GHz Pre-amplified Horn	Aegis Labs, Inc.	H042	SLK-35-3W	11/04/05	1 Year
Antenna - 26.5-40 GHz Pre-amplified Horn	Aegis Labs, Inc.	H028	GM1260-10	11/04/05	1 Year
Cable	Semflex	60637	S1L29BFS134 8	04/11/06	1 Year
Temperature/Humidity Monitor	Dickson	TH550	7255185	N/A	N/A
Power Meter	Anritsu	ML2487A	6K00001785	04/12/06	1 Year
Wide Bandwidth Sensor	Anritsu	MA2491A	31193	04/12/06	1 Year
12dB Attenuator	Narda	4779-12	203	08/06/06	1 Year
Antenna - Biconical	EMCO	3110	9108-1421	05/17/06	1 Year
Antenna - Log Periodic	EMCO	3148	4947	05/11/06	1 Year
LISN (EUT)	FCC	FCC-LISN-50-25-2	9931	02/06/06	1 Year
LISN (Access)	Com-Power	LI-200	12019	07/05/07	1 Year
LISN (Access)	Com-Power	LI-200	12018	07/05/07	1 Year

Page 15 of 18
Report Number: INTEL-050901F
FCC ID: PD9WM3945ABG



6.0 SAMPLE CALCULATIONS

If a preamplifier is used during the Radiated Emissions Testing, it is required that the amplifier gain be subtracted from the Spectrum Analyzer (Meter) Reading. In addition, a correction factor for the antenna, cable and a distance factor, if any, must be applied to the Meter Reading before a true field strength reading can be obtained. In the Automatic Mode of A.R.M.S. measurements, these considerations are automatically presented as a part of the printout. In the case of manual measurements and for greater efficiency and convenience, usage of the calibration correction factors in the Appendices is necessary to calculate the Corrected Meter Reading. These correlation factors for each meter reading, shall be modified to reflect these correlation factors at each frequency value so that the meter readings can be compared directly to the modified specification limit. This modified specification limit is referred to as the “Corrected Meter Reading Limit” (CML).

The equation shall be derived in the following manner:

$$\text{Corrected Meter Reading} = \text{Meter Reading} + F + C - G - D$$

Where, F = Antenna Factor

C = Cable Factor

G = Amplifier Gain

D = Distance Factor

Therefore, the equation for determining the Corrected Meter Reading Limit (CML) is:

$$\text{CML} = \text{Specification Limit} - F - C + G + D$$

For the manual mode of measurement, a table of corrected meter reading limits shall be used to permit immediate comparison of the meter reading to determine if the measured emission amplitude exceeded the specification limit at that specific frequency. There shall be two calculation sheets done, one for three meter and one for ten-meter measurement distances, where applicable. The correction factors for the antenna and the amplifier gain are attached in the Appendices.



AEGIS LABS INC.

6.0 Sample Calculations (Continued)

Peak Transmit Power Output:

A correction factor for the cable must be applied to the Conducted Power before a true power reading can be obtained. This is referred to as the “Corrected Power” (CP).

The equation shall be derived in the following manner:

Corrected Power Reading = Conducted Power Reading + C

Where, C = Cable Factor

The conducted power is taken in units of dBm. To obtain units of mW the following equation is used:

$$\text{mW} = 10^{(\text{dBm}/10)}$$



AEGIS LABS INC.

7.0 MODIFICATIONS AND RECOMMENDATIONS

No modifications were made to the EUT.



AEGIS LABS INC.

APPENDIX A

TEST DATA

Page 1 of 75 (Appendix A)
Report Number: INTEL-050901F
FCC ID: PD9WM3945ABG



AEGIS LABS INC.

AC POWER LINE CONDUCTED EMISSIONS TEST RESULTS

CLIENT:	Intel Corporation	DATE:	09/06/05
EUT:	Intel PRO/Wireless 3945ABG Network Connection	PROJECT NUMBER:	INTEL-050901
MODEL NUMBER:	WM3945ABG	TEST ENGINEER:	JC/RJ
SERIAL NUMBER:	00B11A295CVD26965002	SITE #:	2
CONFIGURATION:	Tested installed in the host computer's mini PCI slot.	TEMPERATURE:	34 C
		HUMIDITY:	14% RH
		TIME:	1:45 PM

Standard:	FCC CFR 47, Part 15.207
Description:	AC Power Line Conducted Emissions
Results:	Passes the conducted limits by -9.86@ 0.5900 MHz

Conducted Limits		
Frequency (MHz)	Quasi-Peak Limit (dBuV)	Average Limit (dBuV)
0.15-0.5	66 to 56*	56 to 46*
0.5-5	56	46
5-30	60	50

*Decreases with the logarithm of the frequency.

NOTE: During preliminary scans, there wasn't any difference which mode, channel, or data rate was used with the EUT; therefore only 802.11b mode at Channel 1 with a data rate of 1 Mbps was used for final testing. Also, the scan was only done with the Ethertronics set of antennas.

Page 2 of 75 (Appendix A)
Report Number: INTEL-050901F
FCC ID: PD9WM3945ABG



AC Power Line Conducted Emissions Test Results (Continued)

CONDUCTED EMISSIONS – LINE 1						
Freq. (MHz)	Meter Reading (dBuV)	Detector (PK/QP/AV)	Average Limit (dBuV)	Average Delta(dB)	Quasi-Peak Limit (dBuV)	Quasi-Peak Delta(dB)
0.1800	38.82	PK	55.14	-16.32	65.14	-26.32
0.5900	36.14	PK	46.00	-9.86	56.00	-19.86
0.6600	36.12	PK	46.00	-9.88	56.00	-19.88
7.9300	39.76	PK	50.00	-10.24	60.00	-20.24
9.4700	39.32	PK	50.00	-10.68	60.00	-20.68
10.4000	39.67	PK	50.00	-10.33	60.00	-20.33

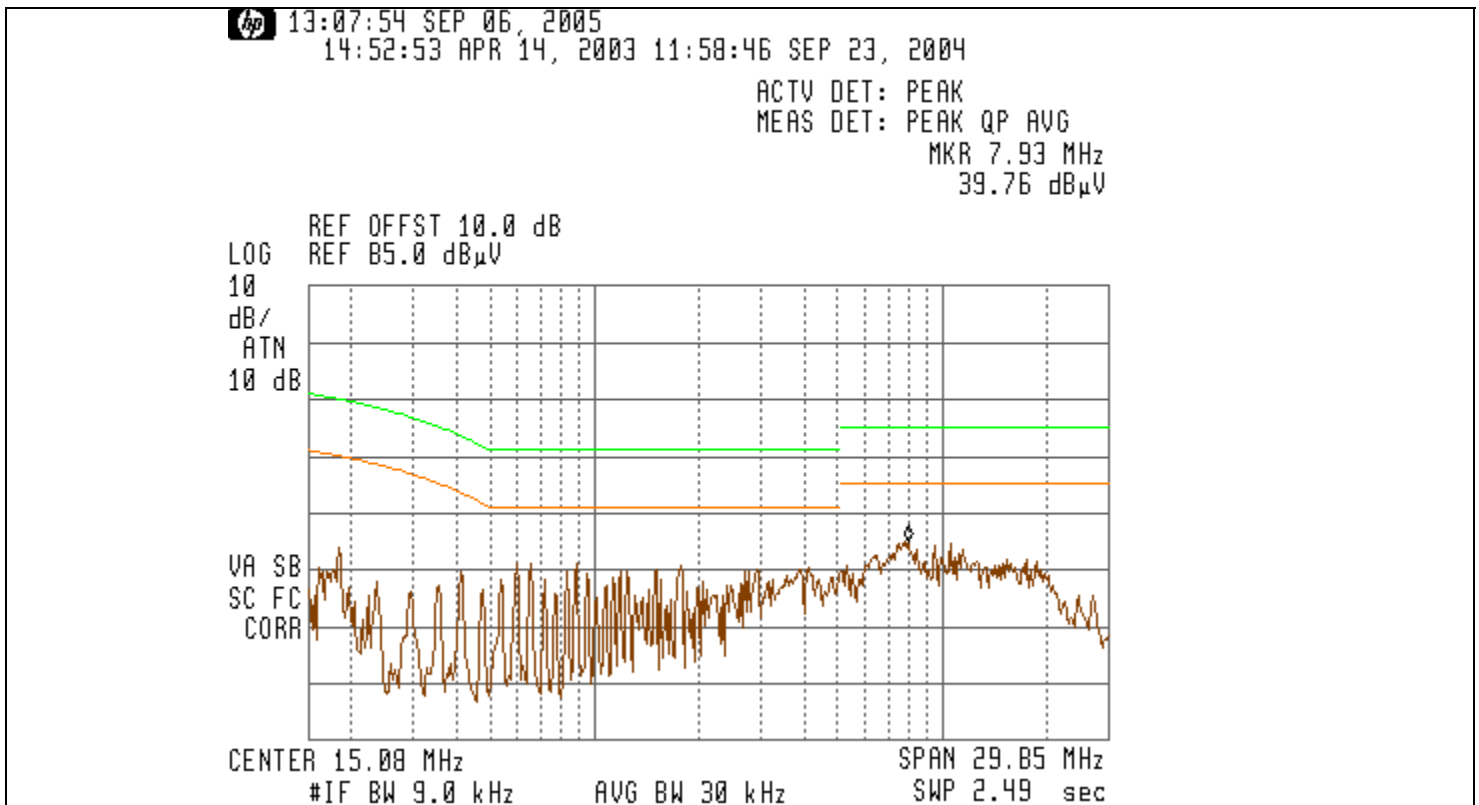



AEGIS LABS INC.

AC Power Line Conducted Emissions Test Results (Continued)

CONDUCTED EMISSIONS - LINE 2						
Freq. (MHz)	Meter Reading (dBuV)	Detector (PK/QP/AV)	Average Limit (dBuV)	Average Delta(dB)	Quasi-Peak Limit (dBuV)	Quasi-Peak Delta(dB)
0.1600	34.48	PK	55.71	-21.23	65.71	-31.23
0.1800	34.57	PK	55.14	-20.57	65.14	-30.57
1.7700	33.88	PK	46.00	-12.12	56.00	-22.12
7.9300	39.99	PK	50.00	-10.01	60.00	-20.01
11.4200	38.87	PK	50.00	-11.13	60.00	-21.13
17.3500	37.55	PK	50.00	-12.45	60.00	-22.45

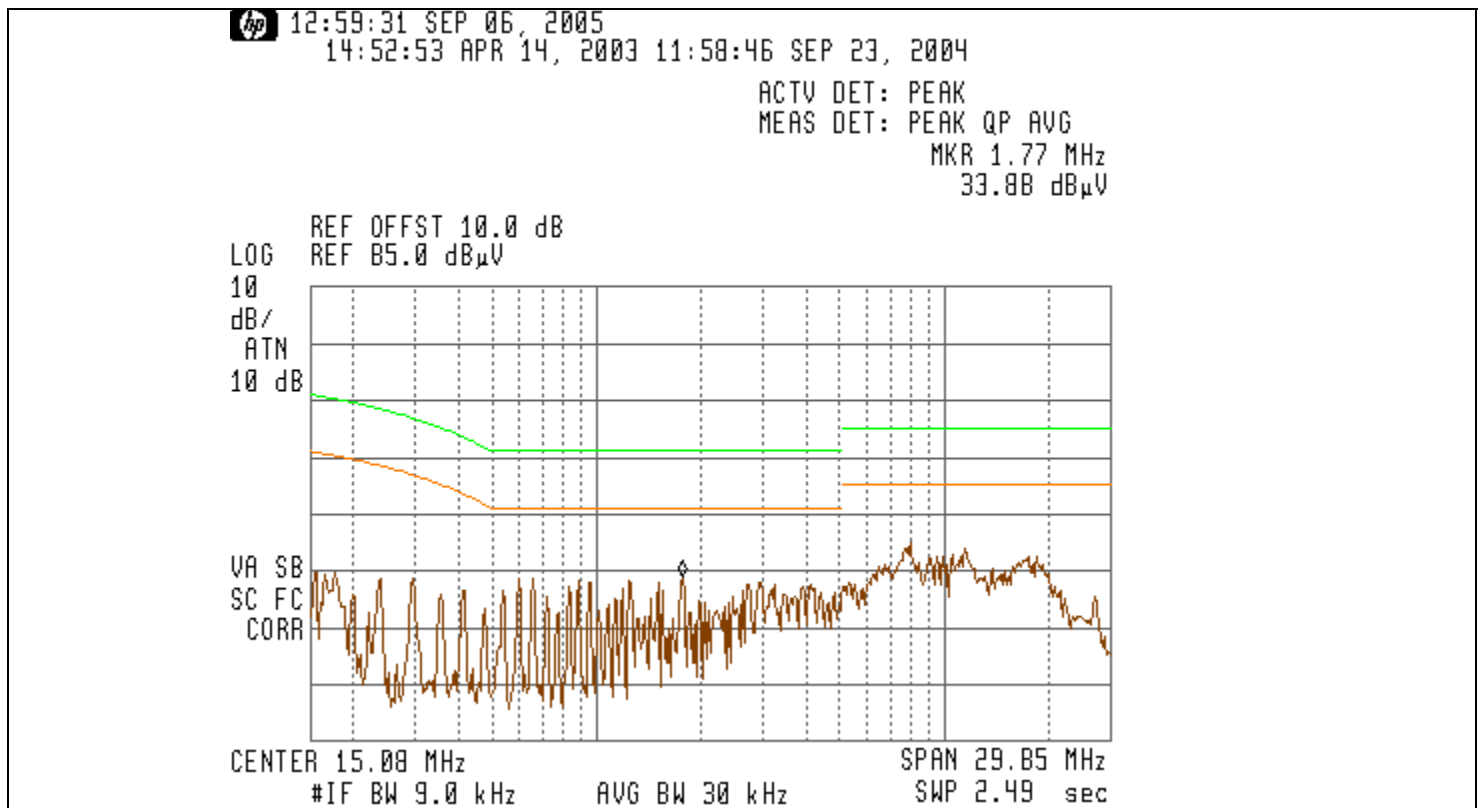

Page 4 of 75 (Appendix A)
Report Number: INTEL-050901F
FCC ID: PD9WM3945ABG



AEGIS LABS INC.

SPURIOUS RADIATED EMISSIONS TEST RESULTS

CLIENT:	Intel Corporation	DATE:	09/06/05
EUT:	Intel PRO/Wireless 3945ABG Network Connection	PROJECT NUMBER:	INTEL-050901
MODEL NUMBER:	WM3945ABG	TEST ENGINEER:	JC
SERIAL NUMBER:	00B11A295CVD26965002	SITE #:	2
CONFIGURATION:	Tested installed in the host computer's mini PCI slot.	TEMPERATURE:	21 C
		HUMIDITY:	45% RH
		TIME:	8:30 AM

Standard:	FCC Pt. 15.209
Description:	Unwanted emissions below 1 GHz must comply with the general field strength limits set forth in Sec. 15.209.
Results:	Passes the radiated limits by -6.43@ 120.04 MHz (Vertical antenna polarization)

Radiated Limits	
Frequency (MHz)	Quasi-Peak Limit (dBuV)
30-88	40
88-216	43.52
216-960	46.02
960-1000	54

NOTE: During preliminary scans, there wasn't any difference which mode, channel, or data rate was used with the EUT; therefore only 802.11b mode at Channel 1 with a data rate of 1 Mbps was used for final testing. Also, the scan was only done with the Ethertronics set of antennas.

Page 5 of 75 (Appendix A)
Report Number: INTEL-050901F
FCC ID: PD9WM3945ABG



SPURIOUS RADIATED EMISSIONS TEST RESULTS

RADIATED EMISSIONS - Horizontal Antenna Polarization

Freq. (MHz)	Meter Reading (dBuV)	Antenna Height (cm)	Azimuth (degrees)	Quasi pk or AVG (dBuV)		Cable Factor (dB)	Ant. Factor (dB)	10 Meter Distance Factor (dB)	Corrected Reading (dBuV)	Limits (dBuV)	Diff (dB) += FAIL
64.02	10.22	400	315			1.24	7.76	10.46	29.68	40.00	-10.32
136.03	6.40	400	180			1.90	14.38	10.46	33.14	43.50	-10.36
166.52	8.54	400	225			2.04	15.76	10.46	36.80	43.50	-6.70
199.27	6.83	400	180			2.29	16.89	10.46	29.64	43.50	-13.86
240.01	9.22	400	180			2.68	17.42	10.46	30.56	46.00	-15.44
336.03	9.60	350	225			3.12	15.17	10.46	38.34	46.00	-7.66
375.02	9.71	300	225			3.35	14.80	10.46	38.32	46.00	-7.68

RADIATED EMISSIONS - Vertical Antenna Polarization

Freq. (MHz)	Meter Reading (dBuV)	Antenna Height (cm)	Azimuth (degrees)	Quasi pk or AVG (dBuV)		Cable Factor (dB)	Ant. Factor (dB)	10 Meter Distance Factor (dB)	Corrected Reading (dBuV)	Limits (dBuV)	Diff (dB) += FAIL
61.26	16.51	100	90			1.21	7.52	10.46	35.71	40.00	-4.29
120.04	12.70	100	135			1.80	12.11	10.46	37.07	43.50	-6.43
147.63	10.12	100	180			1.90	14.56	10.46	37.04	43.50	-6.46
216.01	8.31	100	135	6.06	Q	2.43	17.50	10.46	36.45	46.00	-9.55
280.02	5.84	100	180			2.82	19.78	10.46	33.06	46.00	-12.94
336.02	6.09	100	315			3.12	15.60	10.46	35.27	46.00	-10.73
384.01	7.81	100	270			3.40	15.85	10.46	37.52	46.00	-8.48

NOTE: The measurements were taken at 10 meters and extrapolated to 3 meters.



AEGIS LABS INC.

SPURIOUS RADIATED EMISSIONS TEST RESULTS

CLIENT:	Intel Corporation	DATE:	07/26/05
EUT:	Intel PRO/Wireless 3945ABG Network Connection	PROJECT NUMBER:	INTEL-050901
MODEL NUMBER:	WM3945ABG	TEST ENGINEER:	JC/BM
SERIAL NUMBER:	00B11A295CVD26965002	SITE #:	2
CONFIGURATION:	Tested installed in the host computer's mini PCI slot in 802.11a (5745-5825 MHz) mode with the Ethertronics antennas.	TEMPERATURE:	31 C
		HUMIDITY:	46% RH
		TIME:	3:20 PM

Standard:	FCC CFR 47, Part 15.247(c)
Description:	Radiated emissions, which fall in the restricted bands, as defined in Sec. 15.205(a), must also comply with the radiated emission limits specified in Sec. 15.209(a). All others must be < -20dBc.
Results:	Passes (See Data Sheets)

Unwanted Spurious Emissions Limits

Frequency (MHz)	Field Strength (uV/m)	Field Strength (dBuV/m) (Emissions in the restricted bands)	Field Strength (dBm/MHz) (Emissions outside the restricted bands)
Above 960	500	54.00 (Average) 74.00 (Peak)	< -20 dBc

Page 7 of 75 (Appendix A)
Report Number: INTEL-050901F
FCC ID: PD9WM3945ABG



Spurious Radiated Emissions Test Results (Continued)

Fundamental Measurements in 802.11a mode (5745-5825 MHz)
Channels 149, 157, & 169
Continuous TX at MAIN Antenna port with Ethertronics Antennas
Aegis Labs, Inc. File #: INTEL-050721-23

RADIATED EMISSIONS - Horizontal Antenna Polarization											
<i>Freq. (MHz)</i>	<i>Meter Reading (dBuV)</i>	<i>Antenna Height (cm)</i>	<i>Azimuth (degrees)</i>	<i>Quasi pk or AVG (dBuV)</i>		<i>Preamp Factor (dB)</i>	<i>Cable Factor (dB)</i>	<i>Ant. Factor (dB)</i>	<i>Corrected Reading (dBuV)</i>	<i>Limits (dBuV)</i>	<i>Diff (dB) +=FAIL</i>
5745.00	65.83	100	135				4.75	35.05	105.62		
5745.00				55.17	A		4.75	35.05	94.96		
5785.00	65.67	100	135				4.77	35.07	105.51		
5785.00				54.42	A		4.77	35.07	94.26		
5825.00	63.50	100	225				4.78	35.10	103.38		
5825.00				53.50	A		4.78	35.10	93.38		

RADIATED EMISSIONS – Vertical Antenna Polarization											
<i>Freq. (MHz)</i>	<i>Meter Reading (dBuV)</i>	<i>Antenna Height (cm)</i>	<i>Azimuth (degrees)</i>	<i>Quasi pk or AVG (dBuV)</i>		<i>Preamp Factor (dB)</i>	<i>Cable Factor (dB)</i>	<i>Ant. Factor (dB)</i>	<i>Corrected Reading (dBuV)</i>	<i>Limits (dBuV)</i>	<i>Diff (dB) +=FAIL</i>
5745.00	71.17	100	225				4.75	34.85	110.76		
5745.00				60.86	A		4.75	34.85	100.45		
5785.00	71.00	100	180				4.77	34.87	110.64		
5785.00				60.53	A		4.77	34.87	100.17		
5825.00	70.83	100	135				4.78	34.90	110.51		
5825.00				60.10	A		4.78	34.90	99.78		



AEGIS LABS INC.

Spurious Radiated Emissions Test Results (Continued)

*Band Edge Field Strength Measurements in 802.11a mode (5745-5825 MHz)
Channels 149, 157, & 169
Continuous TX at MAIN Antenna port with Ethertronics Antennas
Aegis Labs, Inc. File #: INTEL-050721-23*

RADIATED EMISSIONS - Horizontal Antenna Polarization											
<i>Freq. (MHz)</i>	<i>Meter Reading (dBuV)</i>	<i>Antenna Height (cm)</i>	<i>Azimuth (degrees)</i>	<i>Quasi pk or AVG (dBuV)</i>		<i>Preamp Factor (dB)</i>	<i>Cable Factor (dB)</i>	<i>Ant. Factor (dB)</i>	<i>Corrected Reading (dBuV)</i>	<i>Limits (dBuV)</i>	<i>Diff (dB) +=FAIL</i>
5725.00	32.33	100	135				4.74	35.04	72.10	85.62	-13.52
5850.00	28.50	100	225				4.79	35.11	68.40	83.38	-14.97

RADIATED EMISSIONS – Vertical Antenna Polarization											
<i>Freq. (MHz)</i>	<i>Meter Reading (dBuV)</i>	<i>Antenna Height (cm)</i>	<i>Azimuth (degrees)</i>	<i>Quasi pk or AVG (dBuV)</i>		<i>Preamp Factor (dB)</i>	<i>Cable Factor (dB)</i>	<i>Ant. Factor (dB)</i>	<i>Corrected Reading (dBuV)</i>	<i>Limits (dBuV)</i>	<i>Diff (dB) +=FAIL</i>
5725.00	36.00	100	225				4.74	34.84	75.57	90.76	-15.19
5850.00	30.50	100	135				4.79	34.91	70.20	90.51	-20.30

Page 9 of 75 (Appendix A)
Report Number: INTEL-050901F
FCC ID: PD9WM3945ABG



Spurious Radiated Emissions Test Results (Continued)

*Spurious Emissions Measurements in 802.11a mode (5745-5825 MHz)
Channels 149, 157, & 169
Continuous TX at MAIN Antenna port with Ethertronics Antennas
Aegis Labs, Inc. File #: INTEL-050721-24*

RADIATED EMISSIONS - Horizontal Antenna Polarization											
<i>Freq. (MHz)</i>	<i>Meter Reading (dBuV)</i>	<i>Antenna Height (cm)</i>	<i>Azimuth (degrees)</i>	<i>Quasi pk or AVG (dBuV)</i>		<i>Preamp Factor (dB)</i>	<i>Cable Factor (dB)</i>	<i>Ant. Factor (dB)</i>	<i>Corrected Reading (dBuV)</i>	<i>Limits (dBuV)</i>	<i>Diff (dB) +=FAIL</i>
EUT in Continuous Transmit Mode on Channel 149 (5.745 GHz)											
3830.00	54.67	100	180			50.62	3.84	32.46	40.35	74.00	-33.65
3830.00				43.97	A	50.62	3.84	32.46	29.65	54.00	-24.35
11490.00	59.67	100	225			50.44	6.87	39.49	55.58	74.00	-18.42
11490.00				48.42	A	50.44	6.87	39.49	44.33	54.00	-9.67
17235.00	66.33	100	225			52.84	8.47	42.97	64.93	85.62	-20.69
EUT in Continuous Transmit Mode on Channel 157 (5.785 GHz)											
3856.66	55.00	100	180			50.62	3.86	32.53	40.77	74.00	-33.23
3856.66				43.98	A	50.62	3.86	32.53	29.75	54.00	-24.25
11570.00	57.83	100	225			50.48	6.89	39.53	53.78	74.00	-20.22
11570.00				45.60	A	50.48	6.89	39.53	41.55	54.00	-12.45
17355.00	63.17	100	225			52.91	8.51	43.62	62.39	85.51	-23.12
EUT in Continuous Transmit Mode on Channel 165 (5.825 GHz)											
3883.33	55.17	100	225			50.61	3.87	32.60	41.03	74.00	-32.97
3883.33				44.74	A	50.61	3.87	32.60	30.60	54.00	-23.40
11650.00	59.83	100	180			50.50	6.92	39.56	55.80	74.00	-18.20
11650.00				48.15	A	50.50	6.92	39.56	44.12	54.00	-9.88
17475.00	60.50	100	225			52.99	8.56	44.27	60.33	83.38	-23.05



Spurious Radiated Emissions Test Results (Continued)

RADIATED EMISSIONS - Vertical Antenna Polarization											
<i>Freq. (MHz)</i>	<i>Meter Reading (dBuV)</i>	<i>Antenna Height (cm)</i>	<i>Azimuth (degrees)</i>	<i>Quasi pk or AVG (dBuV)</i>		<i>Preamp Factor (dB)</i>	<i>Cable Factor (dB)</i>	<i>Ant. Factor (dB)</i>	<i>Corrected Reading (dBuV)</i>	<i>Limits (dBuV)</i>	<i>Diff (dB) +=FAIL</i>
EUT in Continuous Transmit Mode on Channel 149 (5.745 GHz)											
3830.00	55.83	125	180			50.62	3.84	32.46	41.51	74.00	-32.49
3830.00				44.87	A	50.62	3.84	32.46	30.55	54.00	-23.45
11490.00	58.00	100	225			50.44	6.87	39.49	53.92	74.00	-20.08
11490.00				45.06	A	50.44	6.87	39.49	40.98	54.00	-13.02
17235.00	63.17	100	225			52.84	8.47	43.02	61.83	90.76	-28.93
EUT in Continuous Transmit Mode on Channel 157 (5.785 GHz)											
3856.66	54.17	100	225			50.62	3.86	32.53	39.94	74.00	-34.06
3856.66				43.55	A	50.62	3.86	32.53	29.32	54.00	-24.68
11570.01	61.83	100	225			50.48	6.89	39.54	57.79	74.00	-16.21
11570.01				47.54	A	50.48	6.89	39.54	43.50	54.00	-10.50
17355.00	63.67	100	225			52.91	8.51	43.65	62.92	90.64	-27.72
EUT in Continuous Transmit Mode on Channel 165 (5.825 GHz)											
3883.33	54.17	100	225			50.61	3.87	32.60	40.03	74.00	-33.97
3883.33				43.26	A	50.61	3.87	32.60	29.12	54.00	-24.88
11650.00	59.67	100	135			50.50	6.92	39.59	55.67	74.00	-18.33
11650.00				47.88	A	50.50	6.92	39.59	43.88	54.00	-10.12
17475.00	59.83	100	225			52.99	8.56	44.27	59.67	90.51	-30.84



Spurious Radiated Emissions Test Results (Continued)

*Spurious Emissions Measurements in 802.11a mode (5745-5825 MHz)
 Channels 149, 157, & 169
 Continuous TX at MAIN Antenna port with Ethertronics
 Aegis Labs, Inc. File #: INTEL-050721-24a*

RADIATED EMISSIONS - Horizontal Antenna Polarization										
Freq. (MHz)	Meter Reading (dBuV)	Antenna Height (cm)	Azimuth (degrees)	Quasi pk or AVG (dBuV)		Cable Factor (dB)	Antenna/Preamp Factor (dB)	Corrected Reading (dBuV/m)	Limits (dBuV/m)	Diff (dB)+=FAIL
EUT in Continuous Transmit Mode on Channel 149 (5745 MHz)										
22980.00	53.33	100	225			10.01	4.99	58.35	74.00	-15.65
22980.00				40.77	A	10.01	4.99	45.79	54.00	-8.21
EUT in Continuous Transmit Mode on Channel 157 (5785 MHz)										
23140.00	50.33	100	225			9.99	5.18	55.15	68.00	-12.85
EUT in Continuous Transmit Mode on Channel 165 (5825 MHz)										
23300.00	47.83	100	225			10.01	5.33	52.51	68.00	-15.49
RADIATED EMISSIONS - Vertical Antenna Polarization										
Freq. (MHz)	Meter Reading (dBuV)	Antenna Height (cm)	Azimuth (degrees)	Quasi pk or AVG (dBuV)		Cable Factor (dB)	Antenna/Preamp Factor (dB)	Corrected Reading (dBuV/m)	Limits (dBuV/m)	Diff (dB)+=FAIL
EUT in Continuous Transmit Mode on Channel 149 (5745 MHz)										
22980.00	52.00	100	225			10.01	5.08	56.93	74.00	-17.07
22980.00				39.83	A	10.01	5.08	44.76	54.00	-9.24
EUT in Continuous Transmit Mode on Channel 157 (5785 MHz)										
23140.00	48.17	100	225			9.99	5.21	52.96	68.00	-15.04
EUT in Continuous Transmit Mode on Channel 165 (5825 MHz)										
23300.00	48.33	100	225			10.01	5.30	53.04	68.00	-14.96



Spurious Radiated Emissions Test Results (Continued)

*Spurious Emissions Measurements in 802.11a mode (5745-5825 MHz)
Channels 149, 157, & 169
Continuous RX at MAIN Antenna port with Ethertronics Antennas
Aegis Labs, Inc. File #: INTEL-050721-24*

RADIATED EMISSIONS - Horizontal Antenna Polarization											
<i>Freq. (MHz)</i>	<i>Meter Reading (dBuV)</i>	<i>Antenna Height (cm)</i>	<i>Azimuth (degrees)</i>	<i>Quasi pk or AVG (dBuV)</i>		<i>Preamp Factor (dB)</i>	<i>Cable Factor (dB)</i>	<i>Ant. Factor (dB)</i>	<i>Corrected Reading (dBuV)</i>	<i>Limits (dBuV)</i>	<i>Diff (dB) +/-FAIL</i>
EUT in Continuous Receive Mode on Channel 149 (5.745 GHz)											
3830.00	55.33	100	180			50.62	3.84	32.46	41.01	80.00	-38.99
3830.00				44.99	A	50.62	3.84	32.46	30.67	60.00	-29.33
7660.00	55.67	100	180			49.92	5.51	37.34	48.59	80.00	-31.41
7660.00				46.91	A	49.92	5.51	37.34	39.83	60.00	-20.17
11489.92	54.67	100	135			50.44	6.87	39.49	50.58	80.00	-29.42
11489.92				42.70	A	50.44	6.87	39.49	38.61	60.00	-21.39
EUT in Continuous Receive Mode on Channel 157 (5.785 GHz)											
3856.62	56.50	100	180			50.62	3.86	32.53	42.27	80.00	-37.73
3856.62				46.38	A	50.62	3.86	32.53	32.15	60.00	-27.85
7713.32	57.17	100	180			49.92	5.53	37.58	50.36	80.00	-29.64
7713.32				50.26	A	49.92	5.53	37.58	43.45	60.00	-16.55
11569.92	55.17	100	135			50.48	6.89	39.53	51.12	80.00	-28.88
11569.92				43.39	A	50.48	6.89	39.53	39.34	60.00	-20.66
EUT in Continuous Receive Mode on Channel 165 (5.825 GHz)											
3883.34	56.83	100	225			50.61	3.87	32.60	42.69	80.00	-37.31
3883.34				46.74	A	50.61	3.87	32.60	32.60	60.00	-27.40
7766.62	57.67	100	180			49.91	5.55	37.83	51.13	80.00	-28.87
7766.62				50.73	A	49.91	5.55	37.83	44.19	60.00	-15.81
11649.94	54.00	100	135			50.50	6.92	39.56	49.97	80.00	-30.03
11649.94				42.59	A	50.50	6.92	39.56	38.56	60.00	-21.44



Spurious Radiated Emissions Test Results (Continued)

RADIATED EMISSIONS - Vertical Antenna Polarization											
<i>Freq. (MHz)</i>	<i>Meter Reading (dBuV)</i>	<i>Antenna Height (cm)</i>	<i>Azimuth (degrees)</i>	<i>Quasi pk or AVG (dBuV)</i>		<i>Preamp Factor (dB)</i>	<i>Cable Factor (dB)</i>	<i>Ant. Factor (dB)</i>	<i>Corrected Reading (dBuV)</i>	<i>Limits (dBuV)</i>	<i>Diff (dB) +=FAIL</i>
EUT in Continuous Receive Mode on Channel 149 (5.745 GHz)											
3830.00	54.00	100	135			50.62	3.84	32.46	39.68	80.00	-40.32
3830.00				43.27	A	50.62	3.84	32.46	28.95	60.00	-31.05
7660.00	54.17	100	135			49.92	5.51	37.34	47.09	80.00	-32.91
7660.00				43.80	A	49.92	5.51	37.34	36.72	60.00	-23.28
11489.92	54.00	100	135			50.44	6.87	39.49	49.91	80.00	-30.09
11489.92				42.55	A	50.44	6.87	39.49	38.46	60.00	-21.54
EUT in Continuous Receive Mode on Channel 157 (5.785 GHz)											
3856.65	54.67	100	135			50.62	3.86	32.53	40.44	80.00	-39.56
3856.65				43.19	A	50.62	3.86	32.53	28.96	60.00	-31.04
7713.29	55.00	100	135			49.92	5.53	37.62	48.23	80.00	-31.77
7713.29				44.77	A	49.92	5.53	37.62	38.00	60.00	-22.00
11569.91	54.00	100	135			50.48	6.89	39.54	49.96	80.00	-30.04
11569.91				42.53	A	50.48	6.89	39.54	38.49	60.00	-21.51
EUT in Continuous Receive Mode on Channel 165 (5.825 GHz)											
3883.35	56.00	100	135			50.61	3.87	32.60	41.86	80.00	-38.14
3883.35				45.48	A	50.61	3.87	32.60	31.34	60.00	-28.66
7766.63	56.17	100	180			49.91	5.55	37.88	49.68	80.00	-30.32
7766.63				46.13	A	49.91	5.55	37.88	39.64	60.00	-20.36
11649.97	54.33	100	135			50.50	6.92	39.59	50.33	80.00	-29.67
11649.97				42.22	A	50.50	6.92	39.59	38.22	60.00	-21.78



AEGIS LABS INC.

SPURIOUS RADIATED EMISSIONS TEST RESULTS

CLIENT:	Intel Corporation	DATE:	07/26/05
EUT:	Intel PRO/Wireless 3945ABG Network Connection	PROJECT NUMBER:	INTEL-050901
MODEL NUMBER:	WM3945ABG	TEST ENGINEER:	JC/BM
SERIAL NUMBER:	00B11A295CVD26965002	SITE #:	2
CONFIGURATION:	Tested installed in the host computer's mini PCI slot in 802.11b (2412-2462 MHz) mode with the Ethertronics antennas.	TEMPERATURE:	31 C
		HUMIDITY:	46% RH
		TIME:	3:20 PM

Standard:	FCC CFR 47, Part 15.247(c)
Description:	Radiated emissions, which fall in the restricted bands, as defined in Sec. 15.205(a), must also comply with the radiated emission limits specified in Sec. 15.209(a). All others must be < -20dBc.
Results:	Passes (See Data Sheets)

Unwanted Spurious Emissions Limits

Frequency (MHz)	Field Strength (uV/m)	Field Strength (dBuV/m) (Emissions in the restricted bands)	Field Strength (dBm/MHz) (Emissions outside the restricted bands)
Above 960	500	54.00 (Average) 74.00 (Peak)	< -20 dBc

Page 17 of 75 (Appendix A)
Report Number: INTEL-050901F
FCC ID: PD9WM3945ABG



Spurious Radiated Emissions Test Results (Continued)

*Fundamental Measurements in 802.11b mode (2412-2462 MHz)
 Channels 1, 6, & 11
 Continuous TX at MAIN Antenna port with Ethertronics Antennas
 Aegis Labs, Inc. File #: INTEL-050721-23*

RADIATED EMISSIONS - Horizontal Antenna Polarization											
<i>Freq. (MHz)</i>	<i>Meter Reading (dBuV)</i>	<i>Antenna Height (cm)</i>	<i>Azimuth (degrees)</i>	<i>Quasi pk or AVG (dBuV)</i>		<i>Preamp Factor (dB)</i>	<i>Cable Factor (dB)</i>	<i>Ant. Factor (dB)</i>	<i>Corrected Reading (dBuV)</i>	<i>Limits (dBuV)</i>	<i>Diff (dB) +=FAIL</i>
2412.00	77.17	125	225				3.02	29.22	109.42		
2412.00				73.54	A		3.02	29.22	105.79		
2437.00	77.83	100	225				3.04	29.27	110.14		
2437.00				69.97	A		3.04	29.27	102.28		
2462.00	76.00	125	135				3.06	29.32	108.38		
2462.00				73.28	A		3.06	29.32	105.66		

RADIATED EMISSIONS – Vertical Antenna Polarization											
<i>Freq. (MHz)</i>	<i>Meter Reading (dBuV)</i>	<i>Antenna Height (cm)</i>	<i>Azimuth (degrees)</i>	<i>Quasi pk or AVG (dBuV)</i>		<i>Preamp Factor (dB)</i>	<i>Cable Factor (dB)</i>	<i>Ant. Factor (dB)</i>	<i>Corrected Reading (dBuV)</i>	<i>Limits (dBuV)</i>	<i>Diff (dB) +=FAIL</i>
2412.00	76.17	100	270				3.02	29.42	108.62		
2412.00				72.71	A		3.02	29.42	105.16		
2437.00	77.33	125	270				3.04	29.47	109.84		
2437.00				69.57	A		3.04	29.47	102.08		
2462.00	77.50	100	270				3.06	29.52	110.08		
2462.00				74.36	A		3.06	29.52	106.94		

NOTE: Fundamental signals measured to calculate the band edge field strengths using the “Marker Delta Method”.



Spurious Radiated Emissions Test Results (Continued)

Band Edge Field Strength Measurements in 802.11b mode (2412-2462 MHz)
Channels 1, 6, & 11
Continuous TX at MAIN Antenna port with Ethertronics Antennas
Aegis Labs, Inc. File #: INTEL-050721-23

RADIATED EMISSIONS - Horizontal Antenna Polarization										
<i>Freq. (MHz)</i>	<i>Meter Reading (dBuV)</i>	<i>Antenna Height (cm)</i>	<i>Azimuth (degrees)</i>	<i>Quasi pk or AVG (dBuV)</i>	<i>Preamp Factor (dB)</i>	<i>Cable Factor (dB)</i>	<i>Ant. Factor (dB)</i>	<i>Corrected Reading (dBuV)</i>	<i>Limits (dBuV)</i>	<i>Diff (dB) +=FAIL</i>
2390.00								55.09	74.00	-18.91
2390.00					A			43.62	54.00	-10.38
2400.00	34.17	125	225			3.02	29.20	66.39	89.42	-23.03
2483.50								54.05	74.00	-19.95
2483.50					A			44.16	54.00	-9.84
2487.00								54.88	74.00	-19.12

RADIATED EMISSIONS – Vertical Antenna Polarization										
<i>Freq. (MHz)</i>	<i>Meter Reading (dBuV)</i>	<i>Antenna Height (cm)</i>	<i>Azimuth (degrees)</i>	<i>Quasi pk or AVG (dBuV)</i>	<i>Preamp Factor (dB)</i>	<i>Cable Factor (dB)</i>	<i>Ant. Factor (dB)</i>	<i>Corrected Reading (dBuV)</i>	<i>Limits (dBuV)</i>	<i>Diff (dB) +=FAIL</i>
2390.00								54.29	74.00	-19.71
2390.00					A			42.99	54.00	-11.01
2400.00	32.50	100	270			3.02	29.40	64.92	88.62	-23.70
2483.50								55.75	74.00	-18.25
2483.50					A			45.44	54.00	-8.56
2487.00								56.58	74.00	-17.42

NOTE: The “Band Edge Field Strength” was calculated using the “Fundamental” and “Conducted Band Edge” measurements per the “Marker-Delta Method” with the following formula:

BE = Fm – Δm

Where

BE = Band Edge Field Strength

Fm = Measured Fundamental (Peak or Average)

Δm = Measured Conducted Band Edge Delta (Peak or Average)



AEGIS LABS INC.

Spurious Radiated Emissions Test Results (Continued)

Plots Showing Out-Of-Band Emissions (Peak RBW=VBW=1MHz; Average RBW = 1MHz, VBW = 10Hz)

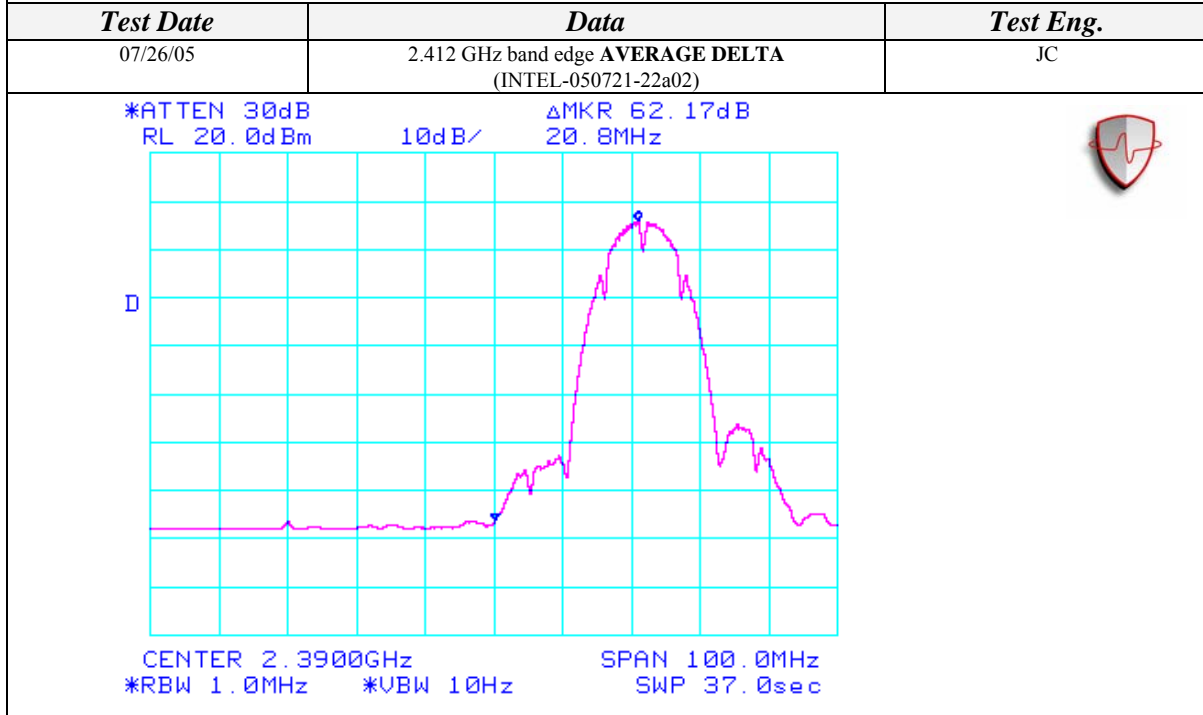
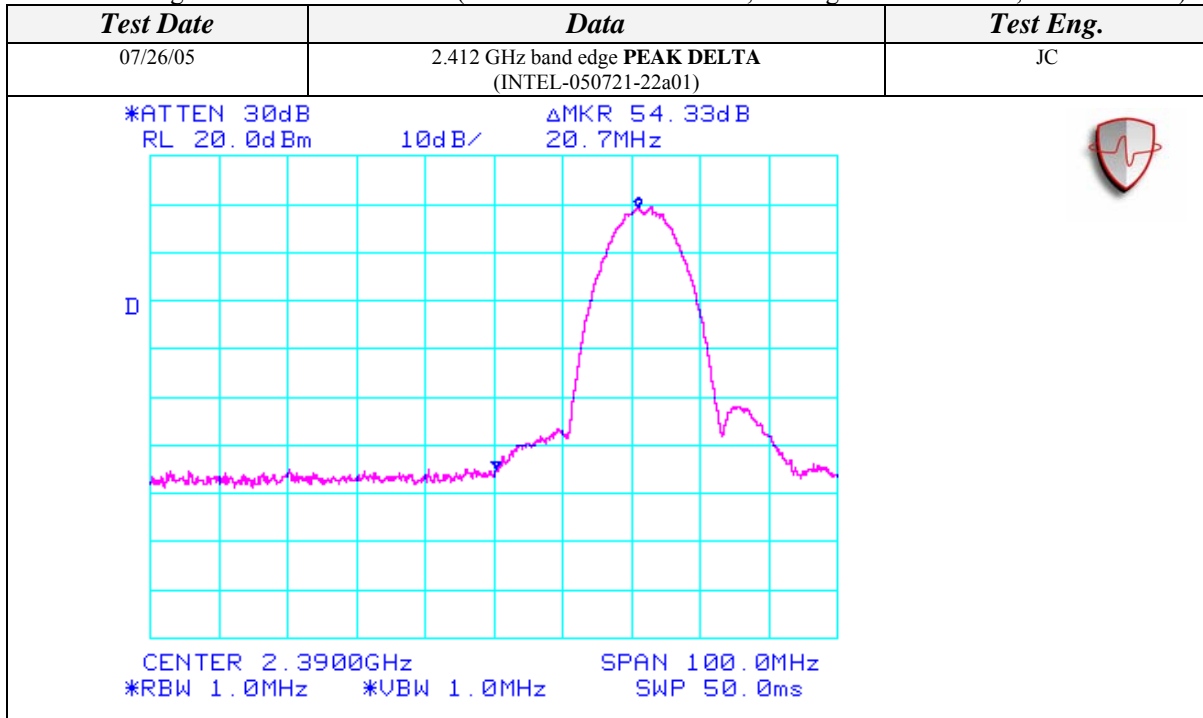

Page 20 of 75 (Appendix A)
Report Number: INTEL-050901F
FCC ID: PD9WM3945ABG



AEGIS LABS INC.

Spurious Radiated Emissions Test Results (Continued)

Plots Showing Out-Of-Band Emissions (Peak RBW=VBW=1MHz; Average RBW = 1MHz, VBW = 10Hz)

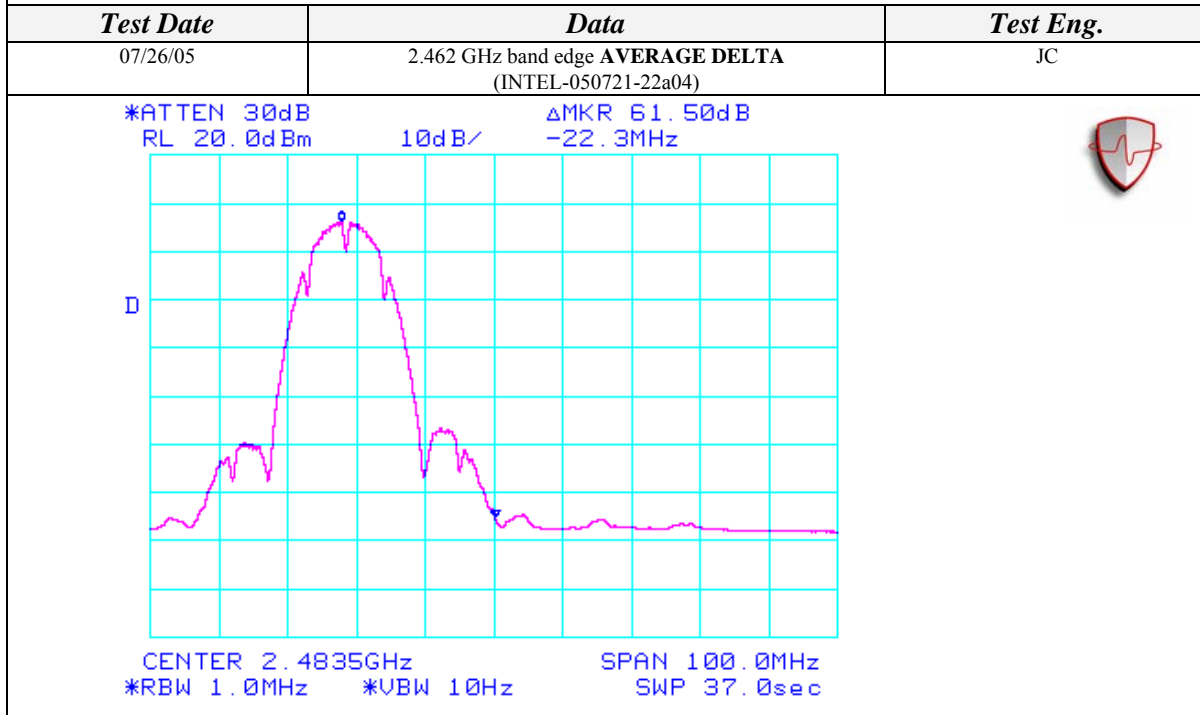
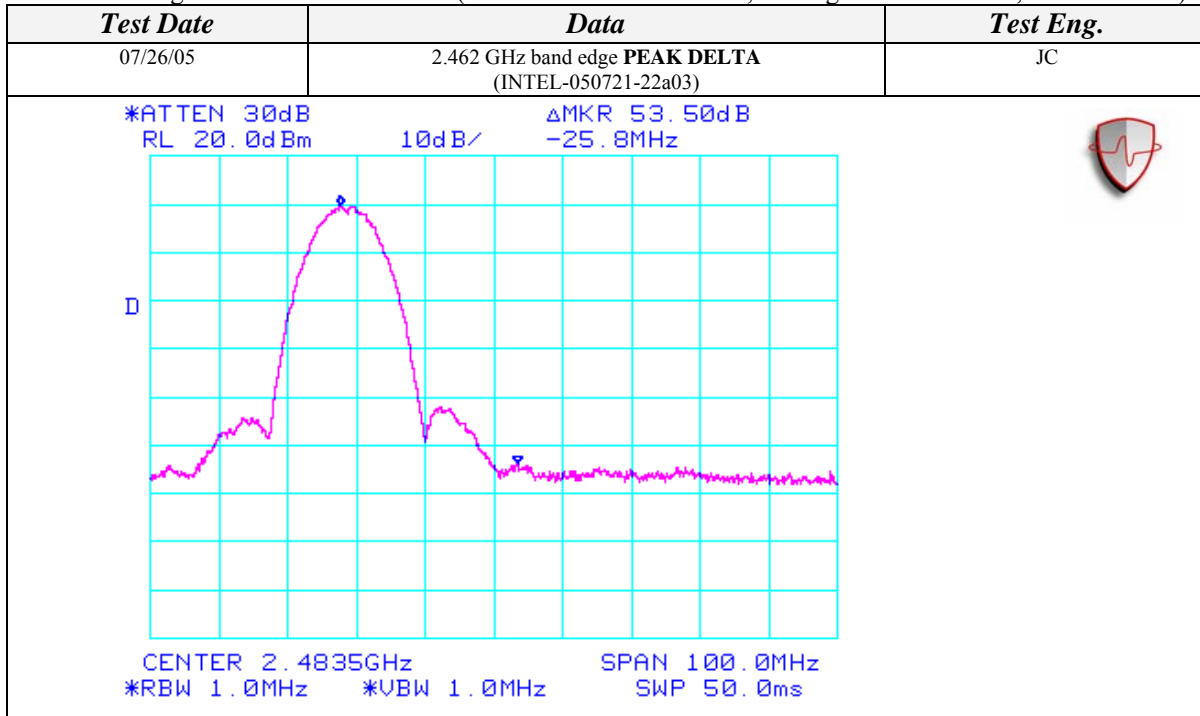

Page 21 of 75 (Appendix A)
Report Number: INTEL-050901F
FCC ID: PD9WM3945ABG



Spurious Radiated Emissions Test Results (Continued)

*Spurious Emissions Measurements in 802.11b mode (2412-2462 MHz)
Channels 1, 6, & 11
Continuous TX at MAIN Antenna port with Ethertronics Antennas
Aegis Labs, Inc. File #: INTEL-050721-25*

RADIATED EMISSIONS - Horizontal Antenna Polarization											
<i>Freq. (MHz)</i>	<i>Meter Reading (dBuV)</i>	<i>Antenna Height (cm)</i>	<i>Azimuth (degrees)</i>	<i>Quasi pk or AVG (dBuV)</i>		<i>1 Meter Distance Factor (dB)</i>	<i>Cable Factor (dB)</i>	<i>Ant. Factor (dB)</i>	<i>Corrected Reading (dBuV)</i>	<i>Limits (dBuV)</i>	<i>Diff (dB) +=FAIL</i>
EUT in Continuous Transmit Mode on Channel 1 (2.412 GHz)											
2312.00	32.00	100	225			9.54	1.97	29.02	53.45	74.00	-20.55
2312.00				15.66	A	9.54	1.97	29.02	37.11	54.00	-16.89
2320.00	31.50	100	225			9.54	1.97	29.04	52.97	74.00	-21.03
2320.00				14.97	A	9.54	1.97	29.04	36.44	54.00	-17.56
2360.00	32.00	100	225			9.54	1.99	29.12	53.57	74.00	-20.43
2360.00				16.16	A	9.54	1.99	29.12	37.73	54.00	-16.27
EUT in Continuous Transmit Mode on Channel 6 (2.437 GHz)											
2320.00	31.67	100	225			9.54	1.97	29.04	53.14	74.00	-20.86
2320.00				15.03	A	9.54	1.97	29.04	36.50	54.00	-17.50
2336.00	32.67	100	225			9.54	1.98	29.07	54.18	74.00	-19.82
2336.00				18.08	A	9.54	1.98	29.07	39.59	54.00	-14.41
2360.00	31.33	100	225			9.54	1.99	29.12	52.90	74.00	-21.10
2360.00				17.01	A	9.54	1.99	29.12	38.58	54.00	-15.42
EUT in Continuous Transmit Mode on Channel 11 (2.462 GHz)											
2280.00	31.33	100	225			9.54	1.95	28.96	52.70	74.00	-21.30
2280.00				15.22	A	9.54	1.95	28.96	36.59	54.00	-17.41
2320.00	31.50	100	225			9.54	1.97	29.04	52.97	74.00	-21.03
2320.00				15.08	A	9.54	1.97	29.04	36.55	54.00	-17.45
2358.66	33.00	100	225			9.54	1.99	29.12	54.57	74.00	-19.43
2358.66				17.67	A	9.54	1.99	29.12	39.24	54.00	-14.76
2360.00	31.50	100	225			9.54	1.99	29.12	53.07	74.00	-20.93
2360.00				15.66	A	9.54	1.99	29.12	37.23	54.00	-16.77



Spurious Radiated Emissions Test Results (Continued)

RADIATED EMISSIONS - Vertical Antenna Polarization											
<i>Freq. (MHz)</i>	<i>Meter Reading (dBuV)</i>	<i>Antenna Height (cm)</i>	<i>Azimuth (degrees)</i>	<i>Quasi pk or AVG (dBuV)</i>		<i>1 Meter Distance Factor (dB)</i>	<i>Cable Factor (dB)</i>	<i>Ant. Factor (dB)</i>	<i>Corrected Reading (dBuV)</i>	<i>Limits (dBuV)</i>	<i>Diff (dB) +=FAIL</i>
EUT in Continuous Transmit Mode on Channel 1 (2.412 GHz)											
2320.00	31.83	100	225			9.54	1.97	29.24	53.50	74.00	-20.50
2320.00				15.26	A	9.54	1.97	29.24	36.93	54.00	-17.07
2360.00	31.33	100	225			9.54	1.99	29.32	53.10	74.00	-20.90
2360.00				15.54	A	9.54	1.99	29.32	37.31	54.00	-16.69
EUT in Continuous Transmit Mode on Channel 6 (2.437 GHz)											
2320.00	31.50	100	225			9.54	1.97	29.24	53.17	74.00	-20.83
2320.00				14.91	A	9.54	1.97	29.24	36.58	54.00	-17.42
2336.00	31.83	100	225			9.54	1.98	29.27	53.54	74.00	-20.46
2336.00				16.49	A	9.54	1.98	29.27	38.20	54.00	-15.80
2360.00	31.67	100	225			9.54	1.99	29.32	53.44	74.00	-20.56
2360.00				15.64	A	9.54	1.99	29.32	37.41	54.00	-16.59
EUT in Continuous Transmit Mode on Channel 11 (2.462 GHz)											
2280.00	33.00	100	225			9.54	1.95	29.16	54.57	74.00	-19.43
2280.00				14.90	A	9.54	1.95	29.16	36.47	54.00	-17.53
2320.00	32.33	100	225			9.54	1.97	29.24	54.00	74.00	-20.00
2320.00				14.99	A	9.54	1.97	29.24	36.66	54.00	-17.34
2358.66	32.17	100	225			9.54	1.99	29.32	53.94	74.00	-20.06
2358.66				15.91	A	9.54	1.99	29.32	37.68	54.00	-16.32
2360.00	31.33	100	225			9.54	1.99	29.32	53.10	74.00	-20.90
2360.00				14.45	A	9.54	1.99	29.32	36.22	54.00	-17.78

NOTE: These spurious emissions measurements were taken without a preamp at a distance on 1 meter to avoid saturating the preamp and analyzer because the signals were close to the fundamental frequency. The readings were extrapolated to 3 meter.



Spurious Radiated Emissions Test Results (Continued)

*Spurious Emissions Measurements in 802.11b mode (2412-2462 MHz)
 Channels 1, 6, & 11
 Continuous TX at MAIN Antenna port with Ethertronics Antennas
 Aegis Labs, Inc. File #: INTEL-050721-24*

RADIATED EMISSIONS - Horizontal Antenna Polarization											
<i>Freq. (MHz)</i>	<i>Meter Reading (dBuV)</i>	<i>Antenna Height (cm)</i>	<i>Azimuth (degrees)</i>	<i>Quasi pk or AVG (dBuV)</i>		<i>Preamp Factor (dB)</i>	<i>Cable Factor (dB)</i>	<i>Ant. Factor (dB)</i>	<i>Corrected Reading (dBuV)</i>	<i>Limits (dBuV)</i>	<i>Diff (dB) +=FAIL</i>
EUT in Continuous Transmit Mode on Channel 1 (2.412 GHz)											
3216.00	55.50	100	180			50.79	3.51	30.98	39.20	89.42	-50.22
4824.00	64.33	100	180			50.81	4.35	34.10	51.98	74.00	-22.02
4824.00				58.20	A	50.81	4.35	34.10	45.85	54.00	-8.15
6431.98	54.67	100	135			50.73	5.03	35.37	44.35	89.42	-45.07
9648.01	63.67	100	180			50.00	6.19	38.11	57.96	89.42	-31.46
12060.00	57.33	100	225			50.68	7.04	39.66	53.35	74.00	-20.65
12060.00				44.91	A	50.68	7.04	39.66	40.93	54.00	-13.07
12864.00	54.67	100	135			51.20	7.21	40.27	50.95	89.42	-38.47
EUT in Continuous Transmit Mode on Channel 6 (2.437 GHz)											
3249.32	58.17	100	180			50.78	3.53	31.05	41.97	90.14	-48.17
4873.99	60.67	100	180			50.81	4.37	34.27	48.51	74.00	-25.49
4873.99				54.23	A	50.81	4.37	34.27	42.07	54.00	-11.93
6498.69	55.00	100	135			50.69	5.06	35.40	44.77	90.14	-45.37
9747.96	68.17	125	225			50.02	6.23	38.25	62.63	90.14	-27.51
12185.00	62.00	100	225			50.79	7.06	39.59	57.85	74.00	-16.15
12185.00				51.29	A	50.79	7.06	39.59	47.14	54.00	-6.86
12997.28	54.83	100	135			51.25	7.25	40.59	51.42	90.14	-38.72
EUT in Continuous Transmit Mode on Channel 11 (2.462 GHz)											
3282.66	58.67	100	180			50.77	3.55	31.12	42.57	88.38	-45.81
4924.00	59.00	100	225			50.81	4.40	34.44	47.02	74.00	-26.98
4924.00				53.52	A	50.81	4.40	34.44	41.54	54.00	-12.46
6565.34	54.83	100	135			50.65	5.08	35.62	44.89	88.38	-43.49
9848.01	69.83	100	225			50.04	6.27	38.39	64.45	88.38	-23.93
12310.00	62.00	100	225			50.90	7.07	39.51	57.68	74.00	-16.32
12310.00				52.01	A	50.90	7.07	39.51	47.69	54.00	-6.31
13130.64	55.67	100	135			51.32	7.32	40.65	52.32	88.38	-36.06



Spurious Radiated Emissions Test Results (Continued)

RADIATED EMISSIONS - Vertical Antenna Polarization											
<i>Freq. (MHz)</i>	<i>Meter Reading (dBuV)</i>	<i>Antenna Height (cm)</i>	<i>Azimuth (degrees)</i>	<i>Quasi pk or AVG (dBuV)</i>		<i>Preamp Factor (dB)</i>	<i>Cable Factor (dB)</i>	<i>Ant. Factor (dB)</i>	<i>Corrected Reading (dBuV)</i>	<i>Limits (dBuV)</i>	<i>Diff (dB) +=FAIL</i>
EUT in Continuous Transmit Mode on Channel 1 (2.412 GHz)											
3216.00	55.67	125	180			50.79	3.51	31.09	39.48	88.62	-49.14
4824.01	64.50	100	135			50.81	4.35	34.07	52.12	74.00	-21.88
4824.01				58.86	A	50.81	4.35	34.07	46.48	54.00	-7.52
6431.98	55.00	100	135			50.73	5.03	35.35	44.65	88.62	-43.97
9648.01	64.83	100	135			50.00	6.19	38.17	59.18	88.62	-29.44
12060.00	55.93	100	135			50.68	7.04	39.75	52.04	74.00	-21.96
12060.00				42.94	A	50.68	7.04	39.75	39.05	54.00	-14.95
12864.00	54.67	100	135			51.20	7.21	40.27	50.95	88.62	-37.67
EUT in Continuous Transmit Mode on Channel 6 (2.437 GHz)											
3249.32	59.33	100	180			50.78	3.53	31.15	43.23	89.84	-46.61
4873.99	60.33	100	135			50.81	4.37	34.22	48.12	74.00	-25.88
4873.99				53.71	A	50.81	4.37	34.22	41.50	54.00	-12.50
6498.69	60.00	100	135			50.69	5.06	35.40	49.77	89.84	-40.07
9747.96	70.17	100	135			50.02	6.23	38.35	64.73	89.84	-25.11
12185.00	56.83	100	225			50.79	7.06	39.65	52.75	74.00	-21.25
12185.00				43.26	A	50.79	7.06	39.65	39.18	54.00	-14.82
12997.28	55.00	100	135			51.25	7.25	40.59	51.59	89.84	-38.25
EUT in Continuous Transmit Mode on Channel 11 (2.462 GHz)											
3282.66	57.50	125	180			50.77	3.55	31.21	41.48	90.08	-48.60
4924.00	58.87	100	135			50.81	4.40	34.37	46.82	74.00	-27.18
4924.00				52.09	A	50.81	4.40	34.37	40.04	54.00	-13.96
6565.34	53.50	100	135			50.65	5.08	35.60	43.54	90.08	-46.54
9848.01	64.50	100	135			50.04	6.27	38.53	59.26	90.08	-30.82
12310.00	56.50	100	225			50.90	7.07	39.55	52.22	74.00	-21.78
12310.00				44.19	A	50.90	7.07	39.55	39.91	54.00	-14.09
13130.64	55.00	100	135			51.32	7.32	40.68	51.67	90.08	-38.41



Spurious Radiated Emissions Test Results (Continued)

*Spurious Emissions Measurements in in802.11b mode (2412-2462 MHz)
 Channels 1, 6, & 11
 Continuous RX at MAIN Antenna port with Ethertronics Antennas
 Aegis Labs, Inc. File #: INTEL-050721-24*

RADIATED EMISSIONS - Horizontal Antenna Polarization											
<i>Freq. (MHz)</i>	<i>Meter Reading (dBuV)</i>	<i>Antenna Height (cm)</i>	<i>Azimuth (degrees)</i>	<i>Quasi pk or AVG (dBuV)</i>		<i>Preamp Factor (dB)</i>	<i>Cable Factor (dB)</i>	<i>Ant. Factor (dB)</i>	<i>Corrected Reading (dBuV)</i>	<i>Limits (dBuV)</i>	<i>Diff (dB) +/-FAIL</i>
EUT in Continuous Receive Mode on Channel 1 (2.412 GHz)											
3216.02	55.67	100	180			50.79	3.51	30.98	39.37	80.00	-40.63
3216.02				47.66	A	50.79	3.51	30.98	31.36	60.00	-28.64
6432.00	54.00	100	135			50.73	5.03	35.37	43.68	80.00	-36.32
6432.00				42.05	A	50.73	5.03	35.37	31.73	60.00	-28.27
9648.01	54.00	100	135			50.00	6.19	38.11	48.29	80.00	-31.71
9648.01				41.92	A	50.00	6.19	38.11	36.21	60.00	-23.79
EUT in Continuous Receive Mode on Channel 6 (2.437 GHz)											
3249.32	56.33	100	180			50.78	3.53	31.05	40.13	80.00	-39.87
3249.32				48.22	A	50.78	3.53	31.05	32.02	60.00	-27.98
6498.70	53.83	100	135			50.69	5.06	35.40	43.60	80.00	-36.40
6498.70				42.19	A	50.69	5.06	35.40	31.96	60.00	-28.04
9747.99	53.00	100	135			50.02	6.23	38.25	47.46	80.00	-32.54
9747.99				41.17	A	50.02	6.23	38.25	35.63	60.00	-24.37
EUT in Continuous Receive Mode on Channel 11 (2.462 GHz)											
3282.66	55.50	100	180			50.77	3.55	31.12	39.40	80.00	-40.60
3282.66				46.45	A	50.77	3.55	31.12	30.35	60.00	-29.65
6565.32	54.00	100	135			50.65	5.08	35.62	44.06	80.00	-35.94
6565.32				42.20	A	50.65	5.08	35.62	32.26	60.00	-27.74
9848.01	52.67	100	135			50.04	6.27	38.39	47.29	80.00	-32.71
9848.01				41.07	A	50.04	6.27	38.39	35.69	60.00	-24.31



Spurious Radiated Emissions Test Results (Continued)

RADIATED EMISSIONS - Vertical Antenna Polarization											
<i>Freq. (MHz)</i>	<i>Meter Reading (dBuV)</i>	<i>Antenna Height (cm)</i>	<i>Azimuth (degrees)</i>	<i>Quasi pk or AVG (dBuV)</i>		<i>Preamp Factor (dB)</i>	<i>Cable Factor (dB)</i>	<i>Ant. Factor (dB)</i>	<i>Corrected Reading (dBuV)</i>	<i>Limits (dBuV)</i>	<i>Diff (dB) +=FAIL</i>
EUT in Continuous Receive Mode on Channel 1 (2.412 GHz)											
3216.00	55.17	100	135			50.79	3.51	31.09	38.98	80.00	-41.02
3216.00				47.80	A	50.79	3.51	31.09	31.61	60.00	-28.39
6432.02	53.67	100	135			50.73	5.03	35.35	43.32	80.00	-36.68
6432.02				41.62	A	50.73	5.03	35.35	31.27	60.00	-28.73
9648.02	53.50	100	135			50.00	6.19	38.17	47.85	80.00	-32.15
9648.02				41.48	A	50.00	6.19	38.17	35.83	60.00	-24.17
EUT in Continuous Receive Mode on Channel 6 (2.437 GHz)											
3249.32	55.00	100	135			50.78	3.53	31.15	38.90	80.00	-41.10
3249.32				48.00	A	50.78	3.53	31.15	31.90	60.00	-28.10
6498.67	53.17	100	135			50.69	5.06	35.40	42.94	80.00	-37.06
6498.67				41.96	A	50.69	5.06	35.40	31.73	60.00	-28.27
9748.00	53.00	100	135			50.02	6.23	38.35	47.56	80.00	-32.44
9748.00				41.28	A	50.02	6.23	38.35	35.84	60.00	-24.16
EUT in Continuous Receive Mode on Channel 11 (2.462 GHz)											
3282.67	56.83	100	180			50.77	3.55	31.21	40.81	80.00	-39.19
3282.67				51.21	A	50.77	3.55	31.21	35.19	60.00	-24.81
6565.32	54.17	100	135			50.65	5.08	35.60	44.21	80.00	-35.79
6565.32				42.09	A	50.65	5.08	35.60	32.13	60.00	-27.87
9847.98	52.50	100	135			50.04	6.27	38.53	47.26	80.00	-32.74
9847.98				40.88	A	50.04	6.27	38.53	35.64	60.00	-24.36



AEGIS LABS INC.

SPURIOUS RADIATED EMISSIONS TEST RESULTS

CLIENT:	Intel Corporation	DATE:	07/26/05
EUT:	Intel PRO/Wireless 3945ABG Network Connection	PROJECT NUMBER:	INTEL-050901
MODEL NUMBER:	WM3945ABG	TEST ENGINEER:	JC/RJ
SERIAL NUMBER:	00B11A295CVD26965002	SITE #:	2
CONFIGURATION:	Tested installed in the host computer's mini PCI slot in 802.11g (2412-2462 MHz) mode with the Ethertronics antennas	TEMPERATURE:	31 C
		HUMIDITY:	46% RH
		TIME:	3:20 PM

Standard:	FCC CFR 47, Part 15.247(c)
Description:	Radiated emissions, which fall in the restricted bands, as defined in Sec. 15.205(a), must also comply with the radiated emission limits specified in Sec. 15.209(a). All others must be < -20dBc.
Results:	Passes (See Data Sheets)

Unwanted Spurious Emissions Limits

Frequency (MHz)	Field Strength (uV/m)	Field Strength (dBuV/m) (Emissions in the restricted bands)	Field Strength (dBm/MHz) (Emissions outside the restricted bands)
Above 960	500	54.00 (Average) 74.00 (Peak)	< -20 dBc

Page 28 of 75 (Appendix A)
Report Number: INTEL-050901F
FCC ID: PD9WM3945ABG



Spurious Radiated Emissions Test Results (Continued)

*Fundamental Measurements in 802.11g mode (2412-2462 MHz)
Channels 1, 6, & 11
Continuous TX at MAIN Antenna port with Ethertronics Antennas
Aegis Labs, Inc. File #: INTEL-050721-23*

RADIATED EMISSIONS - Horizontal Antenna Polarization											
<i>Freq. (MHz)</i>	<i>Meter Reading (dBuV)</i>	<i>Antenna Height (cm)</i>	<i>Azimuth (degrees)</i>	<i>Quasi pk or AVG (dBuV)</i>		<i>Preamp Factor (dB)</i>	<i>Cable Factor (dB)</i>	<i>Ant. Factor (dB)</i>	<i>Corrected Reading (dBuV)</i>	<i>Limits (dBuV)</i>	<i>Diff (dB) +=FAIL</i>
2412.00	74.67	100	225				3.02	29.22	106.92		
2412.00				67.24	A		3.02	29.22	99.49		
2437.00	78.67	100	135				3.04	29.27	110.98		
2437.00				66.90	A		3.04	29.27	99.21		
2462.00	74.50	100	135				3.06	29.32	106.88		
2462.00				67.06	A		3.06	29.32	99.44		

RADIATED EMISSIONS – Vertical Antenna Polarization											
<i>Freq. (MHz)</i>	<i>Meter Reading (dBuV)</i>	<i>Antenna Height (cm)</i>	<i>Azimuth (degrees)</i>	<i>Quasi pk or AVG (dBuV)</i>		<i>Preamp Factor (dB)</i>	<i>Cable Factor (dB)</i>	<i>Ant. Factor (dB)</i>	<i>Corrected Reading (dBuV)</i>	<i>Limits (dBuV)</i>	<i>Diff (dB) +=FAIL</i>
2412.00	75.17	100	270				3.02	29.42	107.62		
2412.00				67.43	A		3.02	29.42	99.88		
2437.00	77.00	125	270				3.04	29.47	109.51		
2437.00				66.35	A		3.04	29.47	98.86		
2462.00	75.00	100	270				3.06	29.52	107.58		
2462.00				67.34	A		3.06	29.52	99.92		

NOTE: Fundamental signals measured to calculate the band edge field strengths using the “Marker Delta Method”.



Spurious Radiated Emissions Test Results (Continued)

*Band Edge Field Strength Measurements in 802.11g mode (2412-2462 MHz)
 Channels 1, 6, & 11
 Continuous TX at MAIN Antenna port with Ethertronics Antennas
 Aegis Labs, Inc. File #: INTEL-050721-23*

RADIATED EMISSIONS - Horizontal Antenna Polarization										
<i>Freq. (MHz)</i>	<i>Meter Reading (dBuV)</i>	<i>Antenna Height (cm)</i>	<i>Azimuth (degrees)</i>	<i>Quasi pk or AVG (dBuV)</i>	<i>Preamp Factor (dB)</i>	<i>Cable Factor (dB)</i>	<i>Ant. Factor (dB)</i>	<i>Corrected Reading (dBuV)</i>	<i>Limits (dBuV)</i>	<i>Diff (dB) +=FAIL</i>
2390.00								70.09	74.00	-3.91
2390.00					A			52.66	54.00	-1.34
2400.00	50.00	100	225			3.02	29.20	82.22	86.92	-4.70
2483.50								66.71	74.00	-7.29
2483.50					A			49.94	54.00	-4.06

RADIATED EMISSIONS – Vertical Antenna Polarization										
<i>Freq. (MHz)</i>	<i>Meter Reading (dBuV)</i>	<i>Antenna Height (cm)</i>	<i>Azimuth (degrees)</i>	<i>Quasi pk or AVG (dBuV)</i>	<i>Preamp Factor (dB)</i>	<i>Cable Factor (dB)</i>	<i>Ant. Factor (dB)</i>	<i>Corrected Reading (dBuV)</i>	<i>Limits (dBuV)</i>	<i>Diff (dB) +=FAIL</i>
2390.00								70.79	74.00	-3.21
2390.00					A			53.05	54.00	-0.95
2400.00	50.33	100	270			3.02	29.40	82.75	87.62	-4.87
2483.50								67.41	74.00	-6.59
2483.50					A			50.42	54.00	-3.58

NOTE: The “Band Edge Field Strength” was calculated using the “Fundamental” and “Conducted Band Edge” measurements per the “Marker-Delta Method” with the following formula:

BE = Fm – Δm

Where

BE = Band Edge Field Strength

Fm = Measured Fundamental (Peak or Average)

Δm = Measured Conducted Band Edge Delta (Peak or Average)



AEGIS LABS INC.

Spurious Radiated Emissions Test Results (Continued)

Plots Showing Out-Of-Band Emissions (Peak RBW=VBW=1MHz; Average RBW = 1MHz, VBW = 10Hz)

<i>Test Date</i>	<i>Data</i>	<i>Test Eng.</i>
07/26/05	2.412 GHz band edge PEAK DELTA (INTEL-050721-22b01)	JC
<p>*ATTEN 30dB ΔMKR 36.83dB RL 20.0dBm 10dB/ 24.8MHz</p> <p>CENTER 2.3900GHz SPAN 100.0MHz *RBW 1.0MHz *VBW 1.0MHz SWP 50.0ms</p>		
<i>Test Date</i>	<i>Data</i>	<i>Test Eng.</i>
07/26/05	2.412 GHz band edge AVERAGE DELTA (INTEL-050721-22b02)	JC
<p>*ATTEN 30dB ΔMKR 46.83dB RL 20.0dBm 10dB/ 14.3MHz</p> <p>CENTER 2.3900GHz SPAN 100.0MHz *RBW 1.0MHz *VBW 10Hz SWP 37.0sec</p>		



Spurious Radiated Emissions Test Results (Continued)

*Spurious Emissions Measurements in 802.11g mode (2412-2462 MHz)
Channels 1, 6, & 11
Continuous TX at MAIN Antenna port with Ethertronics Antennas
Aegis Labs, Inc. File #: INTEL-050721-25*

RADIATED EMISSIONS - Horizontal Antenna Polarization											
<i>Freq. (MHz)</i>	<i>Meter Reading (dBuV)</i>	<i>Antenna Height (cm)</i>	<i>Azimuth (degrees)</i>	<i>Quasi pk or AVG (dBuV)</i>		<i>1 Meter Distance Factor (dB)</i>	<i>Cable Factor (dB)</i>	<i>Ant. Factor (dB)</i>	<i>Corrected Reading (dBuV)</i>	<i>Limits (dBuV)</i>	<i>Diff (dB) +=FAIL</i>
EUT in Continuous Transmit Mode on Channel 1 (2.412 GHz)											
2312.00	32.00	100	225			9.54	1.97	29.02	53.45	74.00	-20.55
2312.00				15.66	A	9.54	1.97	29.02	37.11	54.00	-16.89
2320.00	31.50	100	225			9.54	1.97	29.04	52.97	74.00	-21.03
2320.00				14.97	A	9.54	1.97	29.04	36.44	54.00	-17.56
2360.00	32.00	100	225			9.54	1.99	29.12	53.57	74.00	-20.43
2360.00				16.16	A	9.54	1.99	29.12	37.73	54.00	-16.27
EUT in Continuous Transmit Mode on Channel 6 (2.437 GHz)											
2320.00	31.67	100	225			9.54	1.97	29.04	53.14	74.00	-20.86
2320.00				15.03	A	9.54	1.97	29.04	36.50	54.00	-17.50
2336.00	32.67	100	225			9.54	1.98	29.07	54.18	74.00	-19.82
2336.00				18.08	A	9.54	1.98	29.07	39.59	54.00	-14.41
2360.00	31.33	100	225			9.54	1.99	29.12	52.90	74.00	-21.10
2360.00				17.01	A	9.54	1.99	29.12	38.58	54.00	-15.42
EUT in Continuous Transmit Mode on Channel 11 (2.462 GHz)											
2280.00	31.33	100	225			9.54	1.95	28.96	52.70	74.00	-21.30
2280.00				15.22	A	9.54	1.95	28.96	36.59	54.00	-17.41
2320.00	31.50	100	225			9.54	1.97	29.04	52.97	74.00	-21.03
2320.00				15.08	A	9.54	1.97	29.04	36.55	54.00	-17.45
2358.66	33.00	100	225			9.54	1.99	29.12	54.57	74.00	-19.43
2358.66				17.67	A	9.54	1.99	29.12	39.24	54.00	-14.76
2360.00	31.50	100	225			9.54	1.99	29.12	53.07	74.00	-20.93
2360.00				15.66	A	9.54	1.99	29.12	37.23	54.00	-16.77



Spurious Radiated Emissions Test Results (Continued)

RADIATED EMISSIONS - Vertical Antenna Polarization											
<i>Freq. (MHz)</i>	<i>Meter Reading (dBuV)</i>	<i>Antenna Height (cm)</i>	<i>Azimuth (degrees)</i>	<i>Quasi pk or AVG (dBuV)</i>		<i>1 Meter Distance Factor (dB)</i>	<i>Cable Factor (dB)</i>	<i>Ant. Factor (dB)</i>	<i>Corrected Reading (dBuV)</i>	<i>Limits (dBuV)</i>	<i>Diff (dB) +=FAIL</i>
EUT in Continuous Transmit Mode on Channel 1 (2.412 GHz)											
2320.00	31.83	100	225			9.54	1.97	29.24	53.50	74.00	-20.50
2320.00				15.26	A	9.54	1.97	29.24	36.93	54.00	-17.07
2360.00	31.33	100	225			9.54	1.99	29.32	53.10	74.00	-20.90
2360.00				15.54	A	9.54	1.99	29.32	37.31	54.00	-16.69
EUT in Continuous Transmit Mode on Channel 6 (2.437 GHz)											
2320.00	31.50	100	225			9.54	1.97	29.24	53.17	74.00	-20.83
2320.00				14.91	A	9.54	1.97	29.24	36.58	54.00	-17.42
2336.00	31.83	100	225			9.54	1.98	29.27	53.54	74.00	-20.46
2336.00				16.49	A	9.54	1.98	29.27	38.20	54.00	-15.80
2360.00	31.67	100	225			9.54	1.99	29.32	53.44	74.00	-20.56
2360.00				15.64	A	9.54	1.99	29.32	37.41	54.00	-16.59
EUT in Continuous Transmit Mode on Channel 11 (2.462 GHz)											
2280.00	33.00	100	225			9.54	1.95	29.16	54.57	74.00	-19.43
2280.00				14.90	A	9.54	1.95	29.16	36.47	54.00	-17.53
2320.00	32.33	100	225			9.54	1.97	29.24	54.00	74.00	-20.00
2320.00				14.99	A	9.54	1.97	29.24	36.66	54.00	-17.34
2358.66	32.17	100	225			9.54	1.99	29.32	53.94	74.00	-20.06
2358.66				15.91	A	9.54	1.99	29.32	37.68	54.00	-16.32
2360.00	31.33	100	225			9.54	1.99	29.32	53.10	74.00	-20.90
2360.00				14.45	A	9.54	1.99	29.32	36.22	54.00	-17.78

NOTE: These spurious emissions measurements were taken without a preamp at a distance on 1 meter to avoid saturating the preamp and analyzer because the signals were close to the fundamental frequency. The readings were extrapolated to 1 meter.



Spurious Radiated Emissions Test Results (Continued)

*Spurious Emissions Measurements in 802.11g mode (2412-2462 MHz)
Channels 1, 6, & 11
Continuous TX at MAIN Antenna port with Ethertronics Antennas
Aegis Labs, Inc. File #: INTEL-050721-24*

RADIATED EMISSIONS - Horizontal Antenna Polarization											
<i>Freq. (MHz)</i>	<i>Meter Reading (dBuV)</i>	<i>Antenna Height (cm)</i>	<i>Azimuth (degrees)</i>	<i>Quasi pk or AVG (dBuV)</i>		<i>Preamp Factor (dB)</i>	<i>Cable Factor (dB)</i>	<i>Ant. Factor (dB)</i>	<i>Corrected Reading (dBuV)</i>	<i>Limits (dBuV)</i>	<i>Diff (dB) +=FAIL</i>
EUT in Continuous Transmit Mode on Channel 1 (2.412 GHz)											
3216.00	55.50	100	180			50.79	3.51	30.98	39.20	86.92	-47.72
4824.00	58.67	100	180			50.81	4.35	34.10	46.32	74.00	-27.68
4824.00				45.52	A	50.81	4.35	34.10	33.17	54.00	-20.83
6431.98	54.83	100	135			50.73	5.03	35.37	44.51	86.92	-42.41
9648.01	60.00	100	135			50.00	6.19	38.11	54.29	86.92	-32.63
12864.00	55.33	100	135			51.20	7.21	40.27	51.61	86.92	-35.31
EUT in Continuous Transmit Mode on Channel 6 (2.437 GHz)											
3249.32	55.67	100	180			50.78	3.53	31.05	39.47	90.98	-51.51
4873.99	57.67	100	135			50.81	4.37	34.27	45.51	74.00	-28.49
4873.99				45.13	A	50.81	4.37	34.27	32.97	54.00	-21.03
6498.69	54.50	100	135			50.69	5.06	35.40	44.27	90.98	-46.71
9747.96	62.50	100	225			50.02	6.23	38.25	56.96	90.98	-34.02
12997.28	55.83	100	135			51.25	7.25	40.59	52.42	90.98	-38.56
EUT in Continuous Transmit Mode on Channel 11 (2.462 GHz)											
3282.66	56.50	100	180			50.77	3.55	31.12	40.40	86.88	-46.48
4924.00	54.67	100	135			50.81	4.40	34.44	42.69	74.00	-31.31
4924.00				42.54	A	50.81	4.40	34.44	30.56	54.00	-23.44
6565.34	54.33	100	135			50.65	5.08	35.62	44.39	86.88	-42.49
9848.01	62.33	100	225			50.04	6.27	38.39	56.95	86.88	-29.93
13130.64	55.00	100	135			51.32	7.32	40.65	51.65	86.88	-35.23



Spurious Radiated Emissions Test Results (Continued)

RADIATED EMISSIONS - Vertical Antenna Polarization												
<i>Freq. (MHz)</i>	<i>Meter Reading (dBuV)</i>	<i>Antenna Height (cm)</i>	<i>Azimuth (degrees)</i>	<i>Quasi pk or AVG (dBuV)</i>		<i>Preamp Factor (dB)</i>	<i>Cable Factor (dB)</i>	<i>Ant. Factor (dB)</i>	<i>Corrected Reading (dBuV)</i>	<i>Limits (dBuV)</i>	<i>Diff (dB) +=FAIL</i>	
EUT in Continuous Transmit Mode on Channel 1 (2.412 GHz)												
3216.00	54.83	100	135			50.79	3.51	31.09	38.64	87.62	-48.98	
4824.01	60.17	100	135			50.81	4.35	34.07	47.79	74.00	-26.21	
4824.01				45.94	A	50.81	4.35	34.07	33.56	54.00	-20.44	
6431.98	54.50	100	135			50.73	5.03	35.35	44.15	87.62	-43.47	
9648.01	62.83	100	135			50.00	6.19	38.17	57.18	87.62	-30.44	
12864.00	54.33	100	135			51.20	7.21	40.27	50.61	87.62	-37.01	
EUT in Continuous Transmit Mode on Channel 6 (2.437 GHz)												
3249.32	56.83	100	135			50.78	3.53	31.15	40.73	89.51	-48.78	
4873.99	58.17	100	135			50.81	4.37	34.22	45.96	74.00	-28.04	
4873.99				44.77	A	50.81	4.37	34.22	32.56	54.00	-21.44	
6498.69	53.83	100	135			50.69	5.06	35.40	43.60	89.51	-45.91	
9747.96	63.67	100	135			50.02	6.23	38.35	58.23	89.51	-31.28	
12997.28	54.83	100	135			51.25	7.25	40.59	51.42	89.51	-38.09	
EUT in Continuous Transmit Mode on Channel 11 (2.462 GHz)												
3282.66	64.17	100	135			50.77	3.55	31.21	48.15	87.58	-39.43	
4924.00	54.00	100	135			50.81	4.40	34.37	41.95	74.00	-32.05	
4924.00				42.37	A	50.81	4.40	34.37	30.32	54.00	-23.68	
6565.34	53.67	100	135			50.65	5.08	35.60	43.71	87.58	-43.87	
9848.01	56.33	100	135			50.04	6.27	38.53	51.09	87.58	-36.49	
13130.64	55.00	100	135			51.32	7.32	40.68	51.67	87.58	-35.91	



Spurious Radiated Emissions Test Results (Continued)

*Spurious Emissions Measurements in 802.11g mode (2412-2462 MHz)
Channels 1, 6, & 11
Continuous RX at MAIN Antenna port with Ethertronics Antennas
Aegis Labs, Inc. File #: INTEL-050721-24*

RADIATED EMISSIONS - Horizontal Antenna Polarization											
<i>Freq. (MHz)</i>	<i>Meter Reading (dBuV)</i>	<i>Antenna Height (cm)</i>	<i>Azimuth (degrees)</i>	<i>Quasi pk or AVG (dBuV)</i>		<i>Preamp Factor (dB)</i>	<i>Cable Factor (dB)</i>	<i>Ant. Factor (dB)</i>	<i>Corrected Reading (dBuV)</i>	<i>Limits (dBuV)</i>	<i>Diff (dB) +/-FAIL</i>
EUT in Continuous Receive Mode on Channel 1 (2.412 GHz)											
3216.00	56.17	100	180			50.79	3.51	30.98	39.87	80.00	-40.13
3216.00				48.02	A	50.79	3.51	30.98	31.72	60.00	-28.28
6431.98	53.67	100	135			50.73	5.03	35.37	43.35	80.00	-36.65
6431.98				41.97	A	50.73	5.03	35.37	31.65	60.00	-28.35
9648.00	53.50	100	135			50.00	6.19	38.11	47.79	80.00	-32.21
9648.00				41.63	A	50.00	6.19	38.11	35.92	60.00	-24.08
EUT in Continuous Receive Mode on Channel 6 (2.437 GHz)											
3249.32	56.17	100	180			50.78	3.53	31.05	39.97	80.00	-40.03
3249.32				47.87	A	50.78	3.53	31.05	31.67	60.00	-28.33
6498.67	53.50	100	180			50.69	5.06	35.40	43.27	80.00	-36.73
6498.67				41.99	A	50.69	5.06	35.40	31.76	60.00	-28.24
9748.03	53.33	100	135			50.02	6.23	38.25	47.79	80.00	-32.21
9748.03				41.45	A	50.02	6.23	38.25	35.91	60.00	-24.09
EUT in Continuous Receive Mode on Channel 11 (2.462 GHz)											
3282.66	55.33	100	135			50.77	3.55	31.12	39.23	80.00	-40.77
3282.66				46.19	A	50.77	3.55	31.12	30.09	60.00	-29.91
6565.32	54.33	100	135			50.65	5.08	35.62	44.39	80.00	-35.61
6565.32				42.52	A	50.65	5.08	35.62	32.58	60.00	-27.42
9848.00	52.83	100	135			50.04	6.27	38.39	47.45	80.00	-32.55
9848.00				41.16	A	50.04	6.27	38.39	35.78	60.00	-24.22



Spurious Radiated Emissions Test Results (Continued)

RADIATED EMISSIONS - Vertical Antenna Polarization											
<i>Freq. (MHz)</i>	<i>Meter Reading (dBuV)</i>	<i>Antenna Height (cm)</i>	<i>Azimuth (degrees)</i>	<i>Quasi pk or AVG (dBuV)</i>		<i>Preamp Factor (dB)</i>	<i>Cable Factor (dB)</i>	<i>Ant. Factor (dB)</i>	<i>Corrected Reading (dBuV)</i>	<i>Limits (dBuV)</i>	<i>Diff (dB) +/-FAIL</i>
EUT in Continuous Receive Mode on Channel 1 (2.412 GHz)											
3216.00	55.67	100	135			50.79	3.51	31.09	39.48	80.00	-40.52
3216.00				48.11	A	50.79	3.51	31.09	31.92	60.00	-28.08
6432.01	53.50	100	135			50.73	5.03	35.35	43.15	80.00	-36.85
6432.01				41.95	A	50.73	5.03	35.35	31.60	60.00	-28.40
9648.00	53.17	100	135			50.00	6.19	38.17	47.52	80.00	-32.48
9648.00				41.54	A	50.00	6.19	38.17	35.89	60.00	-24.11
EUT in Continuous Receive Mode on Channel 6 (2.437 GHz)											
3249.33	57.50	100	180			50.78	3.53	31.15	41.40	80.00	-38.60
3249.33				51.95	A	50.78	3.53	31.15	35.85	60.00	-24.15
6498.69	54.17	100	135			50.69	5.06	35.40	43.94	80.00	-36.06
6498.69				42.06	A	50.69	5.06	35.40	31.83	60.00	-28.17
9748.03	53.00	100	135			50.02	6.23	38.35	47.56	80.00	-32.44
9748.03				41.40	A	50.02	6.23	38.35	35.96	60.00	-24.04
EUT in Continuous Receive Mode on Channel 11 (2.462 GHz)											
3282.67	57.17	100	180			50.77	3.55	31.21	41.15	80.00	-38.85
3282.67				51.08	A	50.77	3.55	31.21	35.06	60.00	-24.94
6565.34	53.83	100	135			50.65	5.08	35.60	43.87	80.00	-36.13
6565.34				41.75	A	50.65	5.08	35.60	31.79	60.00	-28.21
9848.04	52.83	100	135			50.04	6.27	38.53	47.59	80.00	-32.41
9848.04				41.03	A	50.04	6.27	38.53	35.79	60.00	-24.21



AEGIS LABS INC.

PEAK TRANSMIT POWER

CLIENT:	Intel Corporation	DATE:	09/01/05
EUT:	Intel PRO/Wireless 3945ABG Network Connection	PROJECT NUMBER:	INTEL-050901-01
MODEL NUMBER:	WM3945ABG	TEST ENGINEER:	BM
SERIAL NUMBER:	00B11A295CVD26965002	SITE #:	2
CONFIGURATION:	Tested installed in the host computer's mini PCI slot.	TEMPERATURE:	35 C
		HUMIDITY:	17% RH
		TIME:	5:00 PM

Standard:	FCC CFR 47, Part 15.247(b)(1)
Description:	The maximum peak output power of the intentional radiator shall not exceed 1 watt.
Results:	See Data Sheet

Peak Transmit Power Limits	
Frequency (MHz)	Output Power (W)
5725-5850	1
2412-2462	1

Page 39 of 75 (Appendix A)
Report Number: INTEL-050901F
FCC ID: PD9WM3945ABG



Peak Transmit Power (Continued)

Mode	Channel	Frequency (MHz)	Rate (Mbps)	Average Power (dBm)	Average Power (mW)	Peak Power (dBm)	Peak Power (mW)
802.11a	149	5745	6	16.84	48.31	19.30	85.11
802.11a	157	5785	6	16.99	50.00	20.00	100.00
802.11a	165	5825	6	17.16	52.00	19.60	91.20
802.11b	1	2412	1	17.15	51.88	19.72	93.76
802.11b	6	2437	1	18.02	63.39	20.54	113.24
802.11b	11	2462	1	17.91	61.80	20.43	110.41
802.11g	1	2412	6	16.23	41.98	24.38	274.16
802.11g	6	2437	6	17.33	54.08	25.02	317.69
802.11g	11	2462	6	15.08	32.21	24.21	263.63

NOTE: The output power measurement is conducted.



AEGIS LABS INC.

6 dB EMISSIONS BANDWIDTH

CLIENT:	Intel Corporation	DATE:	09/02/05
EUT:	Intel PRO/Wireless 3945ABG Network Connection	PROJECT NUMBER:	INTEL-050901
MODEL NUMBER:	WM3945ABG	TEST ENGINEER:	JC
SERIAL NUMBER:	00B11A295CVD26965002	SITE #:	2
CONFIGURATION:	Tested installed in the host computer's mini PCI slot.	TEMPERATURE:	17 C
		HUMIDITY:	52% RH
		TIME:	9:00 AM

Standard:	FCC CFR 47, Part 15.247(a)(2)
Description:	The minimum 6 dB bandwidth shall be at least 500 kHz.
Results:	See Data Sheets

Page 41 of 75 (Appendix A)
Report Number: INTEL-050901F
FCC ID: PD9WM3945ABG



6 dB Emissions Bandwidth (Continued)

802.11a Mode

Test Date	Data	Test Eng.
09/02/05	5.745 GHz (INTEL-050901-07a1)	JC

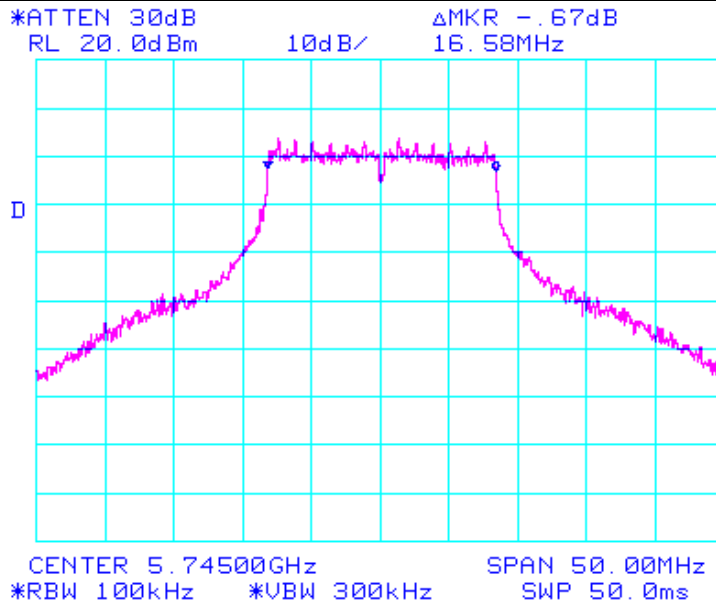

Test Date	Data	Test Eng.
09/02/05	5.785 GHz (INTEL-050901-07a2)	JC

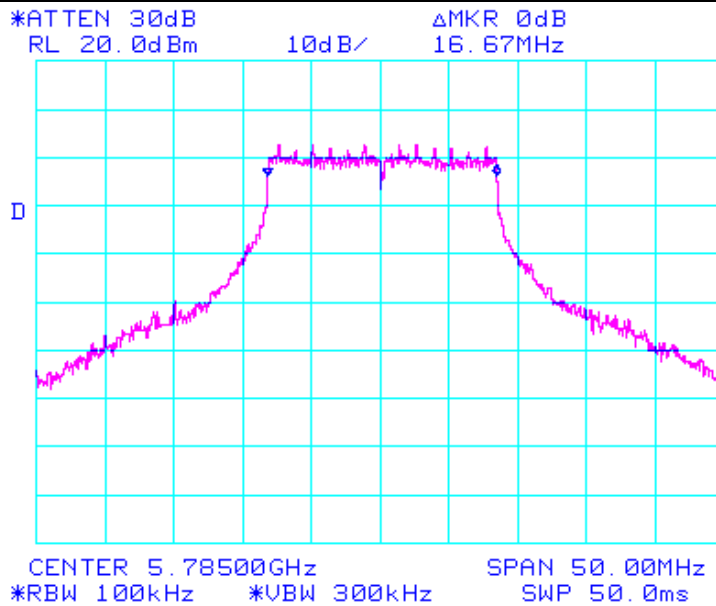



AEGIS LABS INC.

6 dB Emissions Bandwidth (Continued)

802.11a Mode

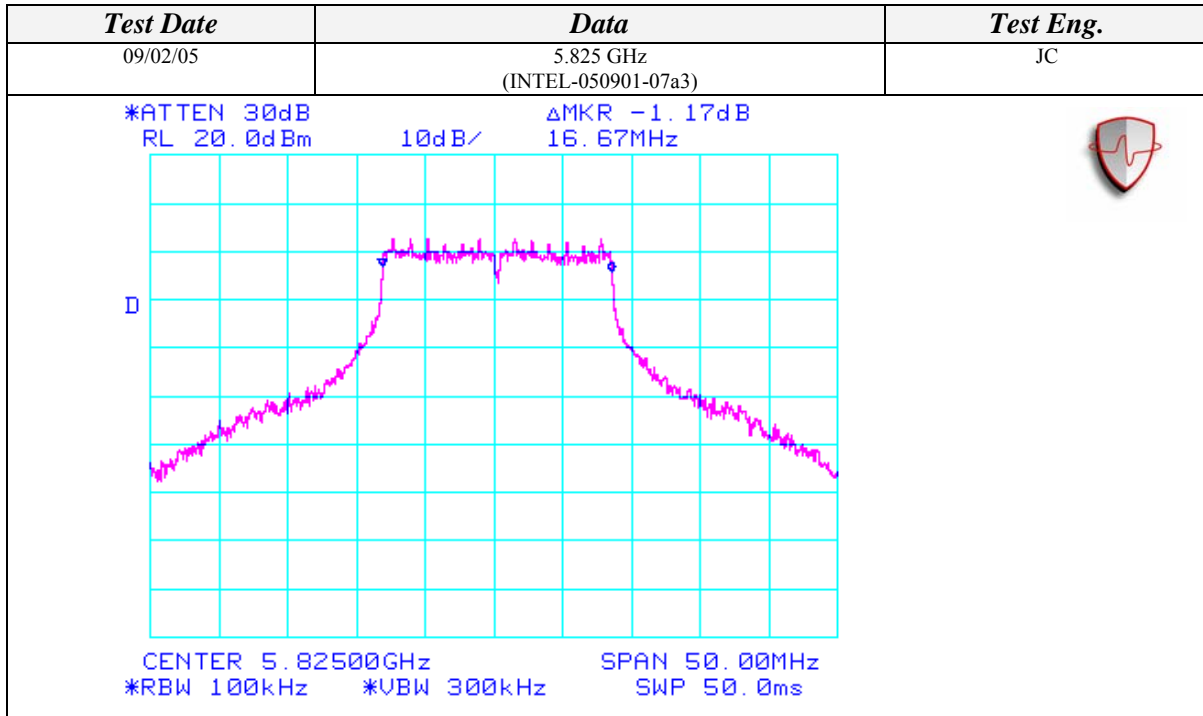

Page 43 of 75 (Appendix A)
Report Number: INTEL-050901F
FCC ID: PD9WM3945ABG



AEGIS LABS INC.

6 dB Emissions Bandwidth (Continued)

802.11b Mode

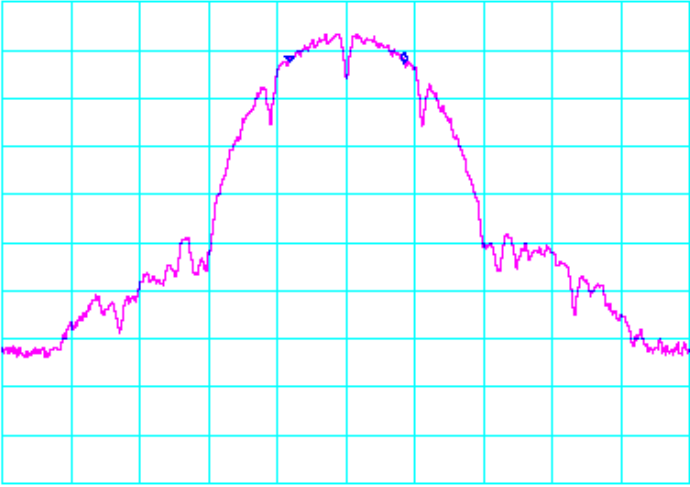
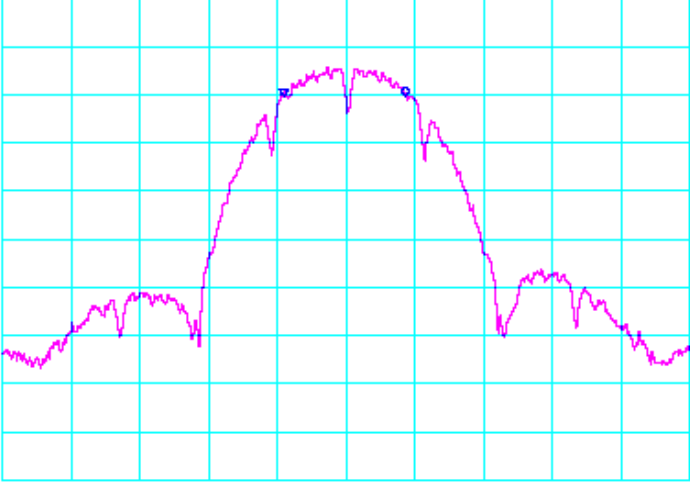
Test Date	Data	Test Eng.
09/02/05	2.412 GHz (INTEL-050901-04a1)	JC
<div style="display: flex; justify-content: space-between;"> <div data-bbox="326 447 935 499"> <p>*ATTEN 20dB ΔMKR -.17dB RL 10.0dBm 10dB/ 8.33MHz</p> </div> <div data-bbox="1284 464 1365 541"></div> </div> <div style="text-align: center; margin: 10px 0;">  </div> <div style="display: flex; justify-content: space-between; margin-top: 10px;"> <div data-bbox="326 989 751 1041"> <p>CENTER 2.41200GHz *RBW 100kHz *VBW 300kHz</p> </div> <div data-bbox="800 989 1024 1041"> <p>SPAN 50.00MHz SWP 50.0ms</p> </div> </div>		
Test Date	Data	Test Eng.
09/02/05	2.437 GHz (INTEL-050901-04a2)	JC
<div style="display: flex; justify-content: space-between;"> <div data-bbox="326 1161 883 1213"> <p>*ATTEN 30dB ΔMKR 0dB RL 20.0dBm 10dB/ 8.83MHz</p> </div> <div data-bbox="1284 1178 1365 1255"></div> </div> <div style="text-align: center; margin: 10px 0;">  </div> <div style="display: flex; justify-content: space-between; margin-top: 10px;"> <div data-bbox="326 1703 751 1755"> <p>CENTER 2.43700GHz *RBW 100kHz *VBW 300kHz</p> </div> <div data-bbox="800 1703 1024 1755"> <p>SPAN 50.00MHz SWP 50.0ms</p> </div> </div>		

Page 44 of 75 (Appendix A)
 Report Number: INTEL-050901F
 FCC ID: PD9WM3945ABG



AEGIS LABS INC.

6 dB Emissions Bandwidth (Continued)

802.11b Mode

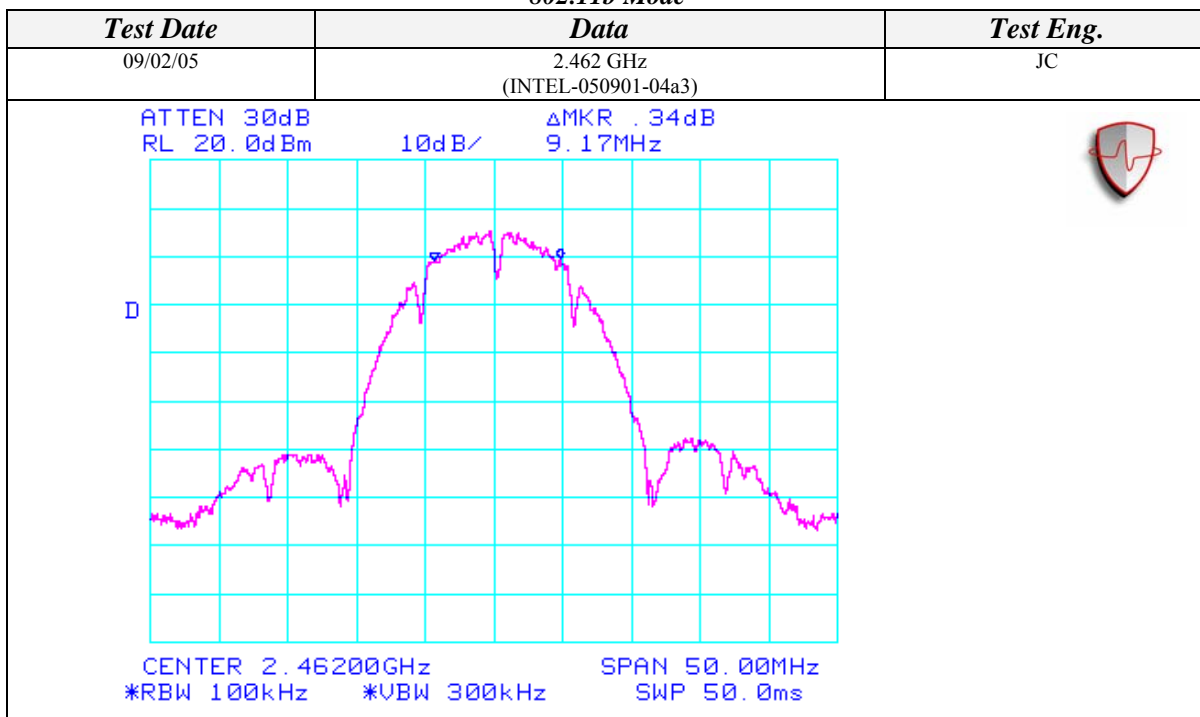



6 dB Emissions Bandwidth (Continued)

802.11g Mode

Test Date	Data	Test Eng.
09/02/05	2.412 GHz (INTEL-050901-05a1)	JC

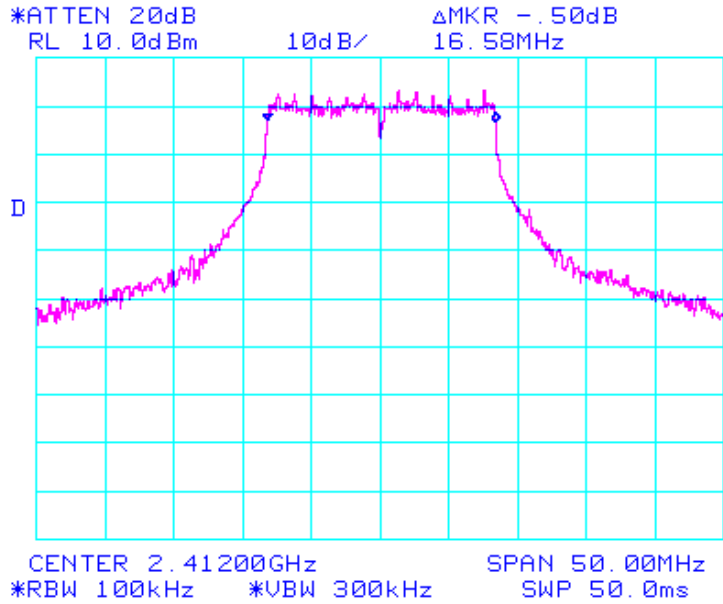

Test Date	Data	Test Eng.
09/02/05	2.437 GHz (INTEL-050901-05a2)	JC

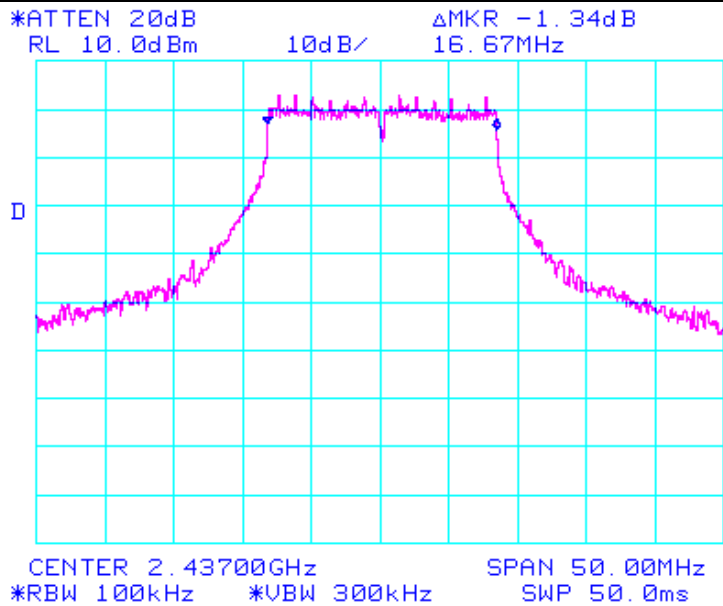



6 dB Emissions Bandwidth (Continued)

802.11g Mode

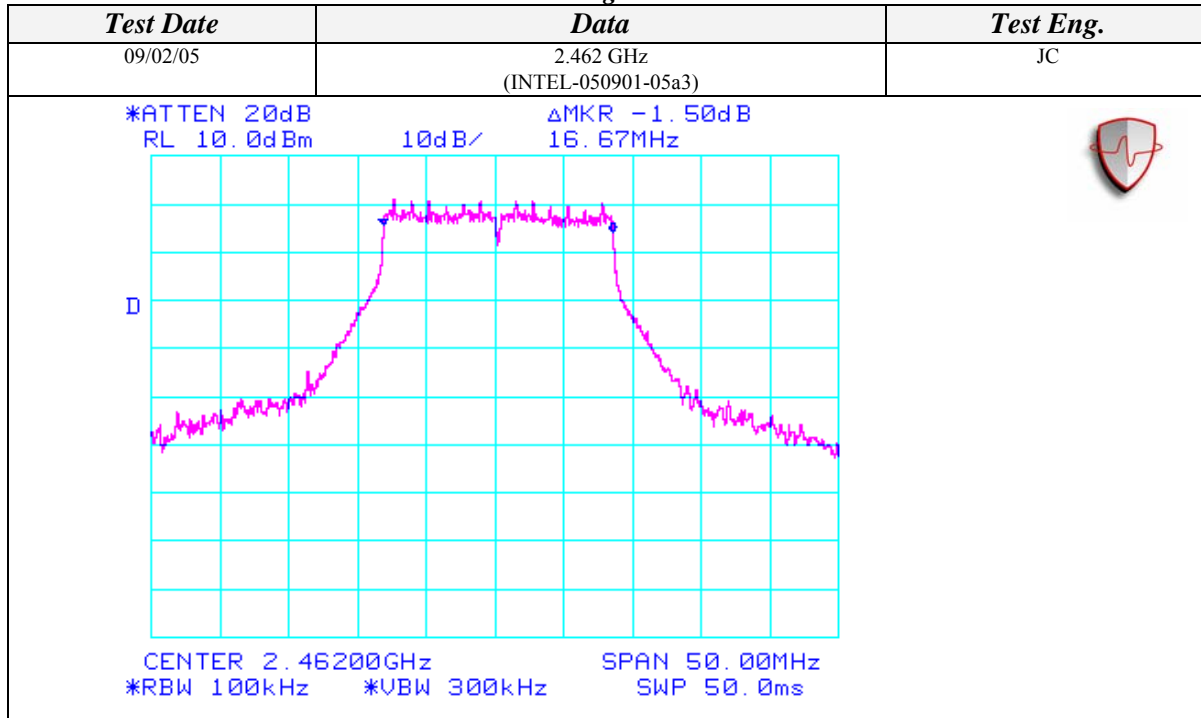



AEGIS LABS INC.

PEAK POWER SPECTRAL DENSITY

CLIENT:	Intel Corporation	DATE:	09/02/05
EUT:	Intel PRO/Wireless 3945ABG Network Connection	PROJECT NUMBER:	INTEL-050901
MODEL NUMBER:	WM3945ABG	TEST ENGINEER:	JC
SERIAL NUMBER:	00B11A295CVD26965002	SITE #:	2
CONFIGURATION:	Tested installed in the host computer's mini PCI slot.	TEMPERATURE:	17 C
		HUMIDITY:	52% RH
		TIME:	9:00 AM

Standard:	FCC CFR 47, Part 15.247(d)
Description:	The peak power spectral density conducted from the intentional radiator to the antenna shall not be greater than 8 dBm in any 3 kHz band during any time interval of continuous transmission.
Results:	See Data Sheets

Peak Power Spectral Density Limits	
Frequency (MHz)	Limit (dBm)
5725-5850	8
2412-2462	8

Page 48 of 75 (Appendix A)
Report Number: INTEL-050901F
FCC ID: PD9WM3945ABG



AEGIS LABS INC.

Peak Power Spectral Density (Continued)

802.11a Mode

Test Date	Data	Test Eng.
09/02/05	5.745 GHz (INTEL-050901-07c1)	JC

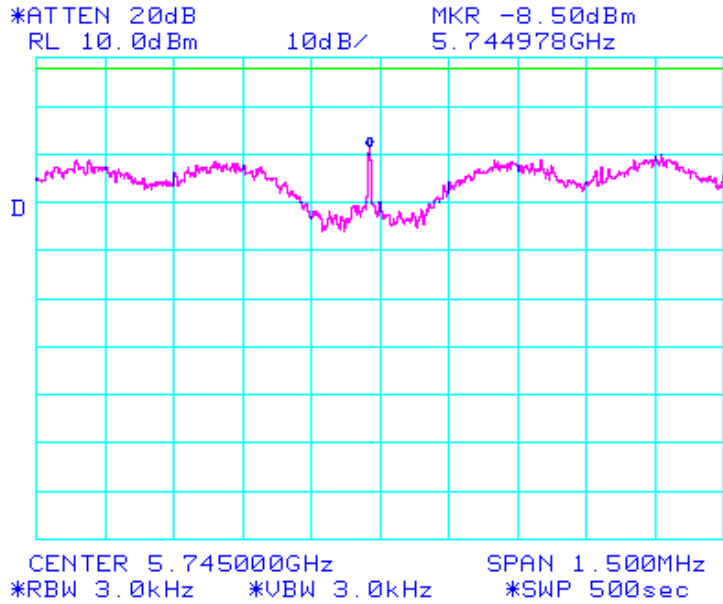

Test Date	Data	Test Eng.
07/28/05	5.785 GHz (INTEL-050721-26d1)	JC

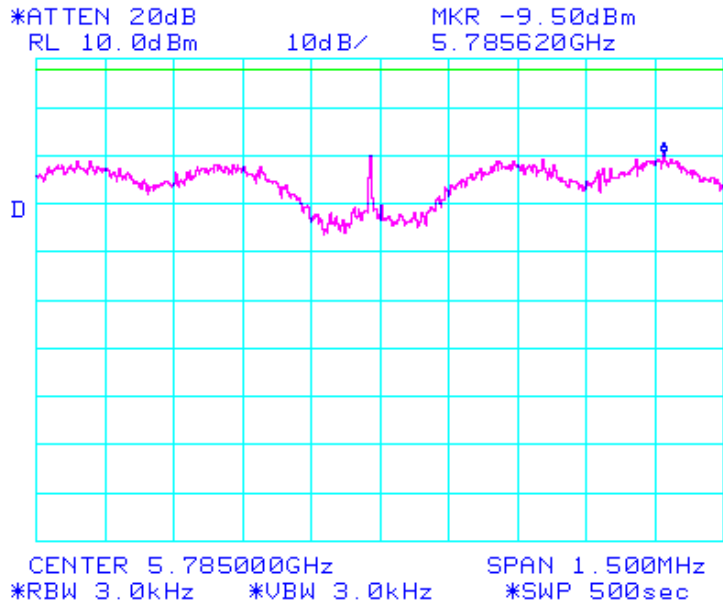

Page 49 of 75 (Appendix A)
 Report Number: INTEL-050901F
 FCC ID: PD9WM3945ABG



AEGIS LABS INC.

Peak Power Spectral Density (Continued)

802.11a Mode

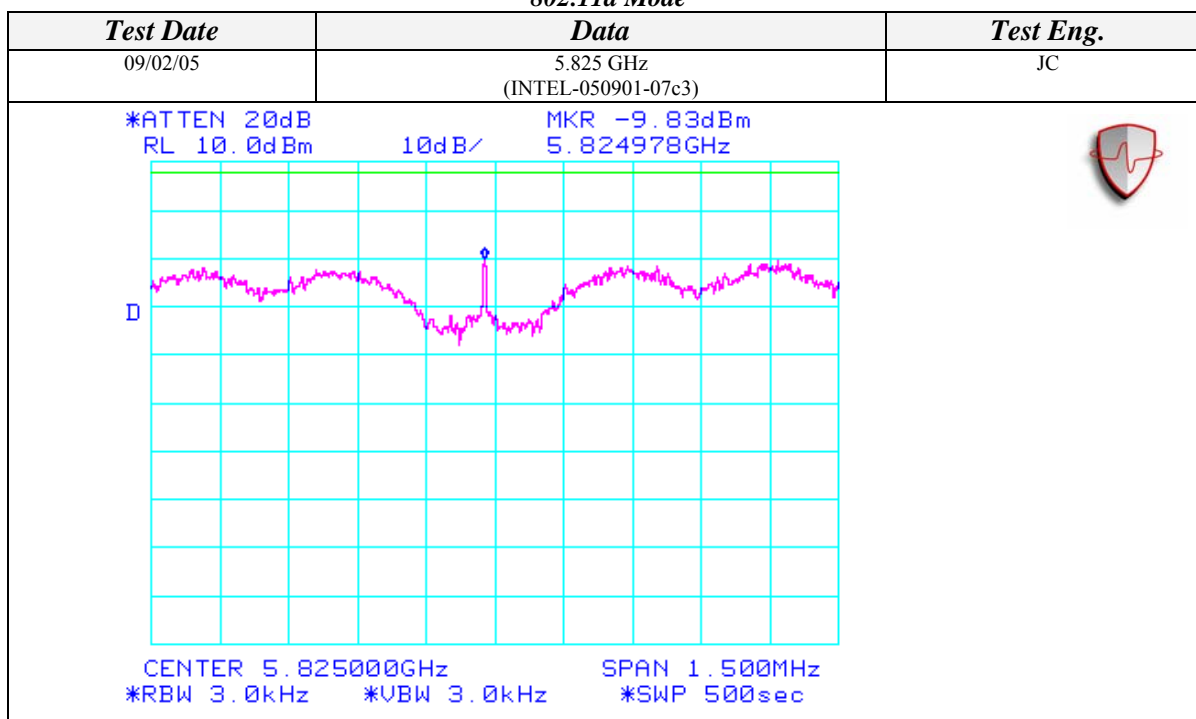





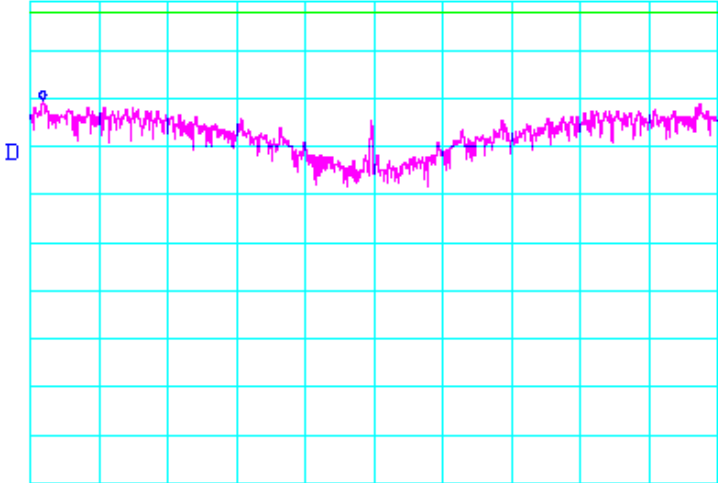

AEGIS LABS INC.

Peak Power Spectral Density (Continued)

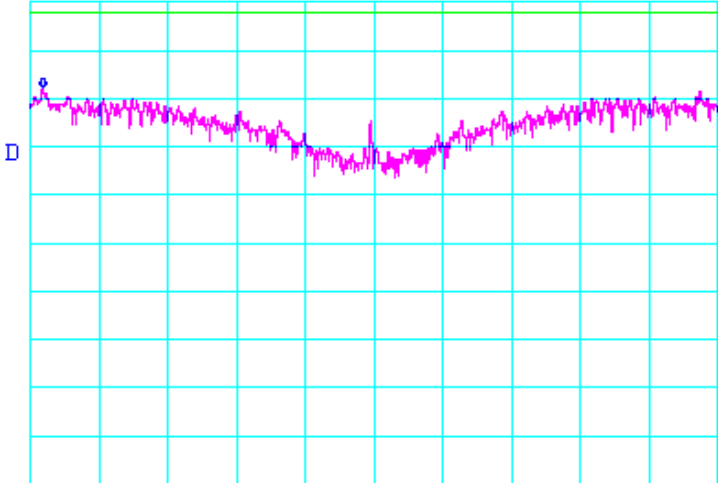
802.11b Mode

Test Date	Data	Test Eng.
09/02/05	2.412 GHz (INTEL-050901-04c1)	JC
<p>*ATTEN 20dB MKR -10.33dBm RL 10.0dBm 10dB/ 2.411278GHz</p>  <p>CENTER 2.412000GHz SPAN 1.500MHz *RBW 3.0kHz *VBW 3.0kHz *SWP 500sec</p> 		
Test Date	Data	Test Eng.
07/28/05	2.437 GHz (INTEL-050721-26a1)	JC
<p>*ATTEN 20dB MKR -7.83dBm RL 10.0dBm 10dB/ 2.436278GHz</p>  <p>CENTER 2.437000GHz SPAN 1.500MHz *RBW 3.0kHz *VBW 3.0kHz *SWP 500sec</p> 		

Page 51 of 75 (Appendix A)
Report Number: INTEL-050901F
FCC ID: PD9WM3945ABG



AEGIS LABS INC.

Peak Power Spectral Density (Continued)

802.11b Mode

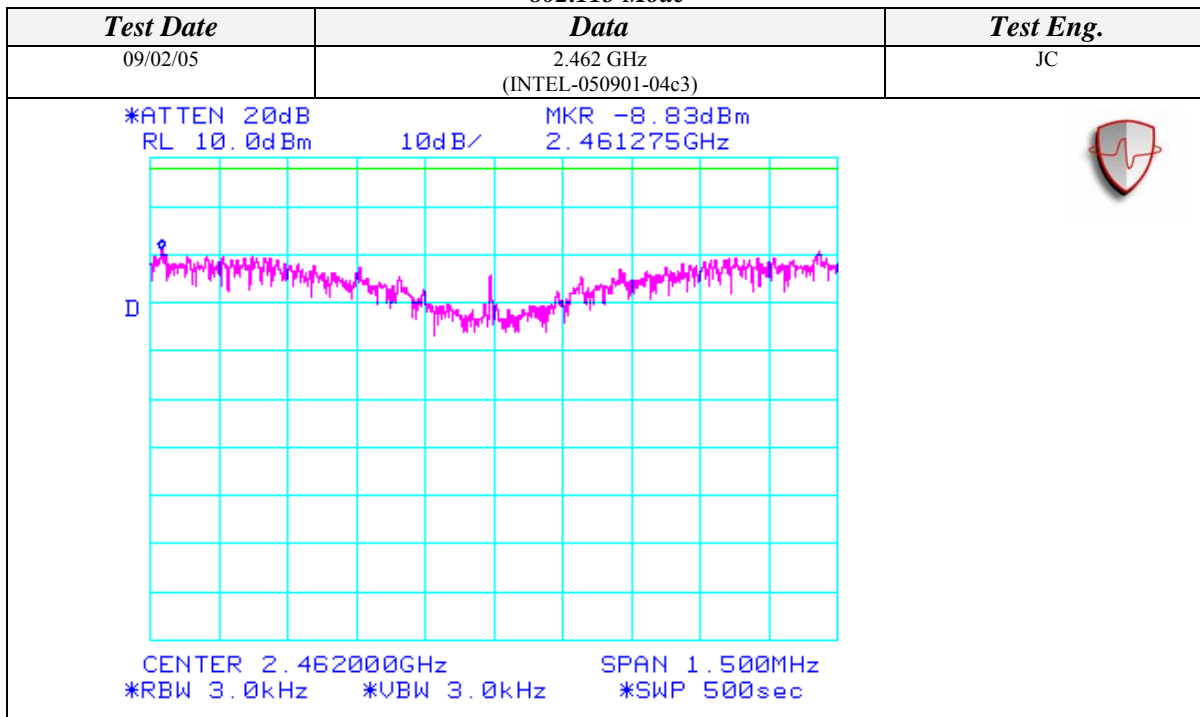



Peak Power Spectral Density (Continued)

802.11g Mode

Test Date	Data	Test Eng.
09/02/05	2.412 GHz (INTEL-050901-05c1)	JC
<div style="display: flex; justify-content: space-between;"> <div style="width: 60%;"> <p>*ATTEN 20dB MKR -9.17dBm RL 10.0dBm 10dB/ 2.411993GHz</p> <p style="text-align: center;">CENTER 2.412000GHz SPAN 1.500MHz *RBW 3.0kHz *VBW 3.0kHz *SWP 500sec</p> </div> <div style="width: 35%; text-align: right;"> </div> </div>		
Test Date	Data	Test Eng.
07/28/05	2.437 GHz (INTEL-050721-26b1)	JC
<div style="display: flex; justify-content: space-between;"> <div style="width: 60%;"> <p>*ATTEN 20dB MKR -8.17dBm RL 10.0dBm 10dB/ 2.436995GHz</p> <p style="text-align: center;">CENTER 2.437000GHz SPAN 1.500MHz *RBW 3.0kHz *VBW 3.0kHz *SWP 500sec</p> </div> <div style="width: 35%; text-align: right;"> </div> </div>		



AEGIS LABS INC.

Peak Power Spectral Density (Continued)

802.11g Mode

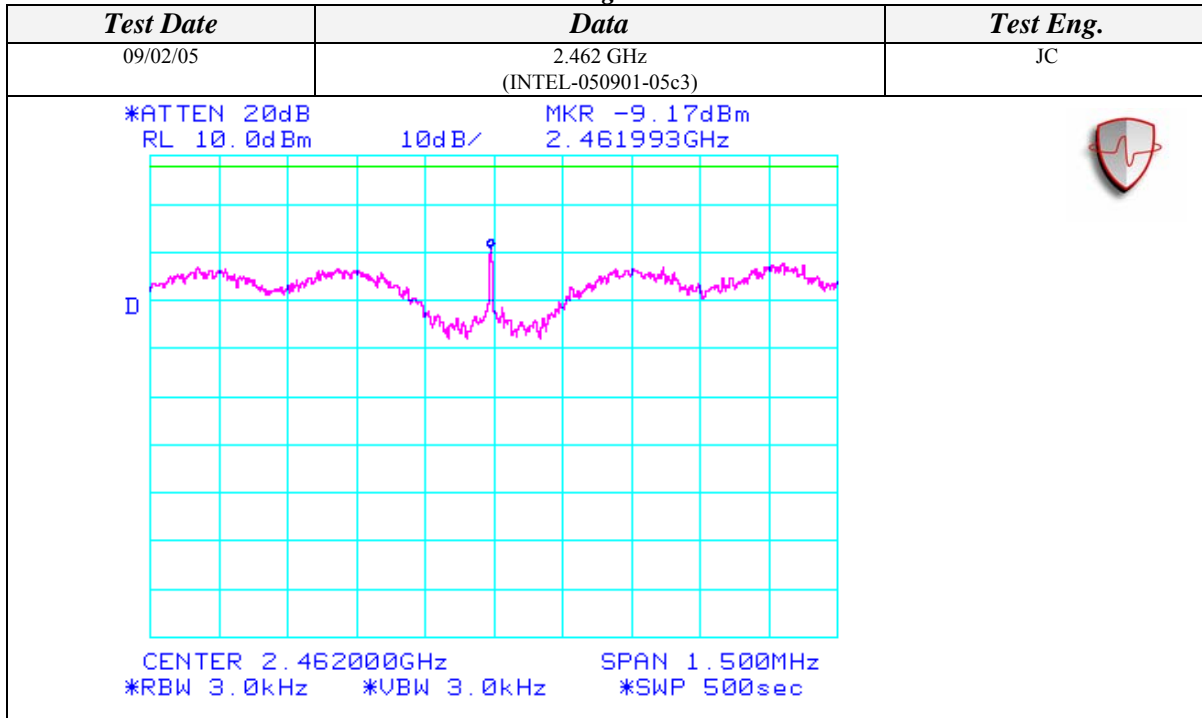



AEGIS LABS INC.

CONDUCTED OUT OF BAND EMISSIONS

CLIENT:	Intel Corporation	DATE:	09/02/05
EUT:	Intel PRO/Wireless 3945ABG Network Connection	PROJECT NUMBER:	INTEL-050901
MODEL NUMBER:	WM3945ABG	TEST ENGINEER:	JC
SERIAL NUMBER:	00B11A295CVD26965002	SITE #:	2
CONFIGURATION:	Tested installed in the host computer's mini PCI slot.	TEMPERATURE:	17 C
		HUMIDITY:	52% RH
		TIME:	9:00 AM

Standard:	FCC CFR 47, Part 15.247(c)
Description:	In any 100 kHz bandwidth outside the frequency band in which the spread spectrum intentional radiator is operating, the radio frequency power that is produced by the intentional radiator shall be at least 20 dB below that in the 100 kHz bandwidth within the band that contains the highest level of the desired power.

Page 55 of 75 (Appendix A)
Report Number: INTEL-050901F
FCC ID: PD9WM3945ABG



Conducted Out Of Band Emissions (Continued)

802.11a Mode

<i>Test Date</i>	<i>Data</i>	<i>Test Eng.</i>
09/02/05	5.745 GHz (INTEL-050901-07d01)	JC

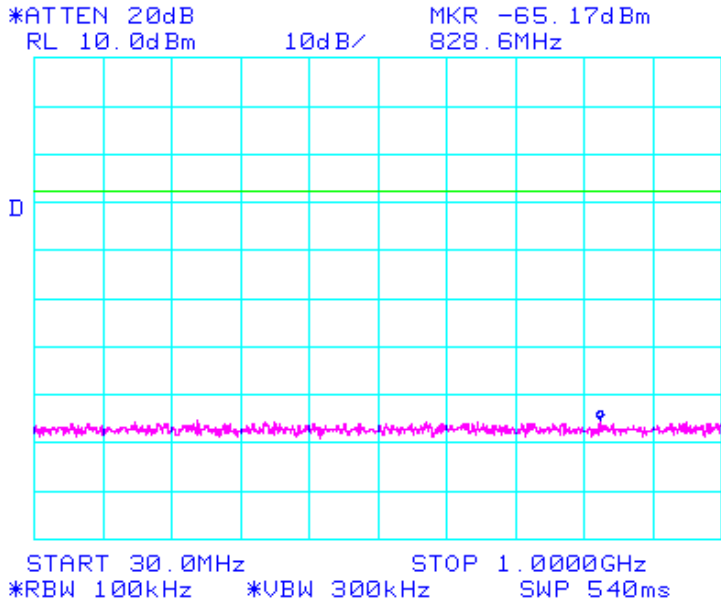



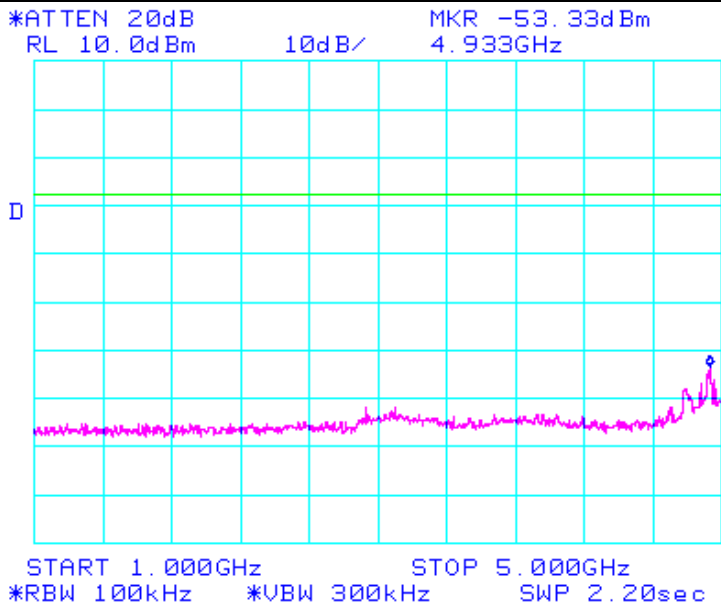

<i>Test Date</i>	<i>Data</i>	<i>Test Eng.</i>
09/02/05	5.745 GHz (INTEL-050901-07d02)	JC



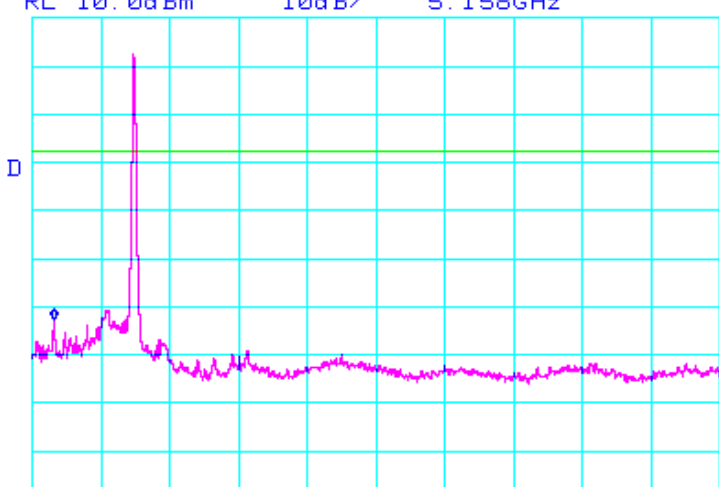

Conducted Out Of Band Emissions (Continued)

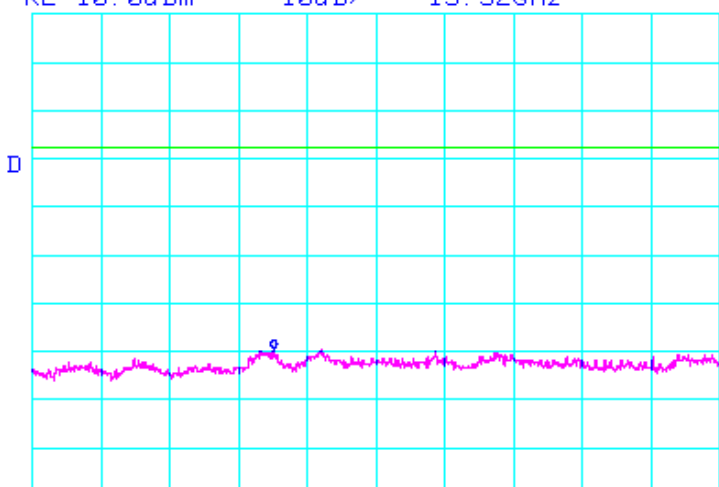
802.11a Mode

Test Date	Data	Test Eng.
09/02/05	5.745 GHz (INTEL-050901-07d03)	JC
<p>*ATTEN 20dB MKR -52.50dBm RL 10.0dBm 10dB/ 5.158GHz</p>  <p>START 5.000GHz STOP 10.000GHz *RBW 100kHz *VBW 300kHz SWP 2.80sec</p> 		
Test Date	Data	Test Eng.
09/02/05	5.745 GHz (INTEL-050901-07d04)	JC
<p>*ATTEN 20dB MKR -59.50dBm RL 10.0dBm 10dB/ 13.52GHz</p>  <p>START 10.00GHz STOP 20.00GHz *RBW 100kHz *VBW 300kHz SWP 5.50sec</p> 		



AEGIS LABS INC.

Conducted Out Of Band Emissions (Continued)

802.11a Mode

Test Date	Data	Test Eng.
09/02/05	5.745 GHz (INTEL-050901-07d05)	JC

*ATTEN 20dB MKR -51.17dBm
 RL 10.0dBm 10dB/ 36.13GHz

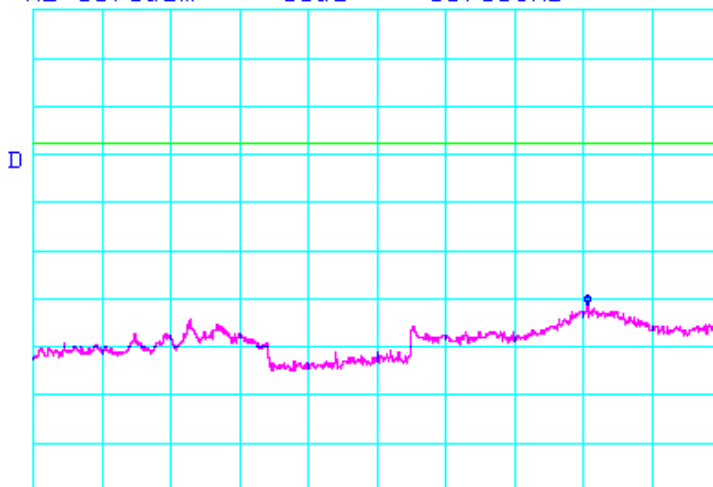

START 20.00GHz STOP 40.00GHz
 *RBW 100kHz *VBW 300kHz SWP 11.0sec

Test Date	Data	Test Eng.
07/28/05	5.785 GHz (INTEL-050721-26d02)	JC

*ATTEN 20dB MKR -64.83dBm
 RL 10.0dBm 10dB/ 852.9MHz

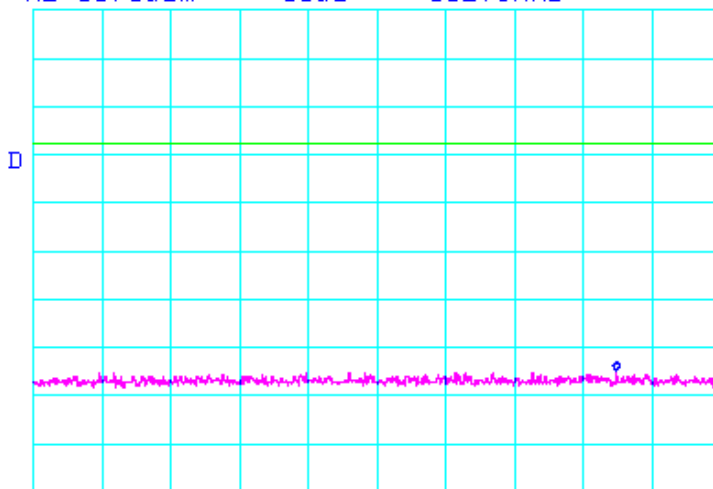

START 30.0MHz STOP 1.000GHz
 *RBW 100kHz *VBW 300kHz SWP 540ms

Page 58 of 75 (Appendix A)
 Report Number: INTEL-050901F
 FCC ID: PD9WM3945ABG



Conducted Out Of Band Emissions (Continued)

802.11a Mode

Test Date	Data	Test Eng.
07/28/05	5.785 GHz (INTEL-050721-26d03)	JC
<p>*ATTEN 20dB MKR -53.17dBm RL 10.0dBm 10dB/ 4.813GHz</p> <p>START 1.000GHz STOP 5.000GHz *RBW 100kHz *VBW 300kHz SWP 2.20sec</p>		
Test Date	Data	Test Eng.
07/28/05	5.785 GHz (INTEL-050721-26d04)	JC
<p>*ATTEN 20dB MKR -47.33dBm RL 10.0dBm 10dB/ 5.558GHz</p> <p>START 5.000GHz STOP 10.000GHz *RBW 100kHz *VBW 300kHz SWP 2.80sec</p>		



Conducted Out Of Band Emissions (Continued)

802.11a Mode

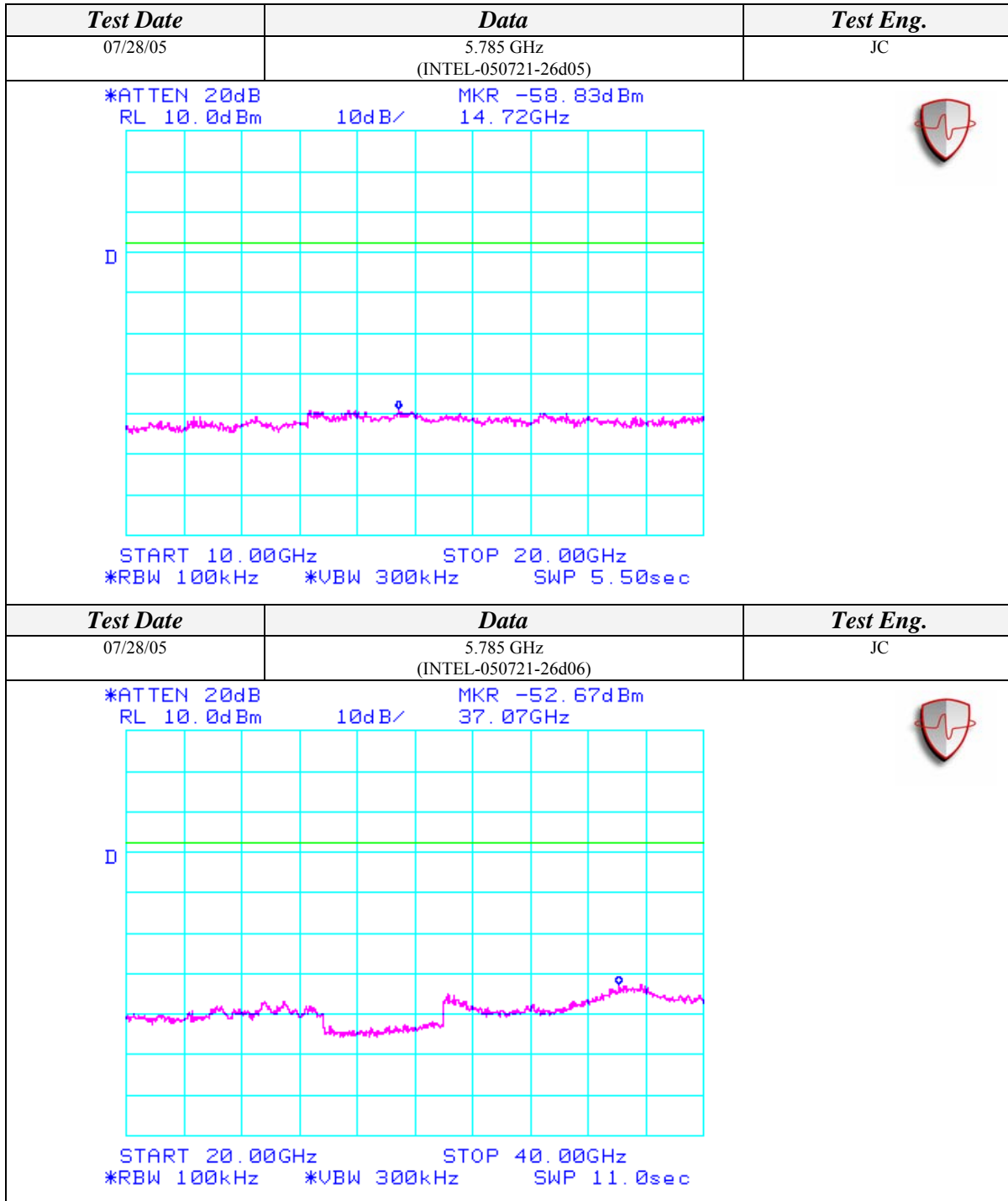



AEGIS LABS INC.

Conducted Out Of Band Emissions (Continued)

802.11a Mode

Test Date	Data	Test Eng.
09/02/05	5.825 GHz (INTEL-050901-07d11)	JC

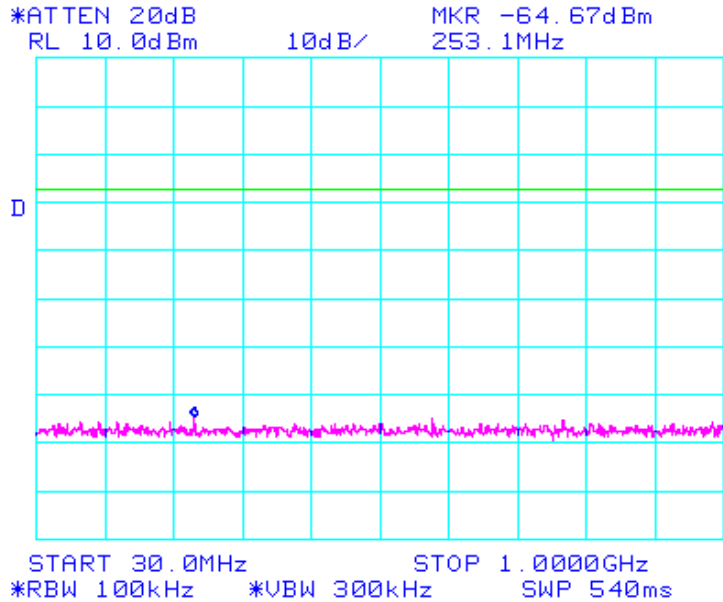

Test Date	Data	Test Eng.
09/02/05	5.825 GHz (INTEL-050901-07d12)	JC

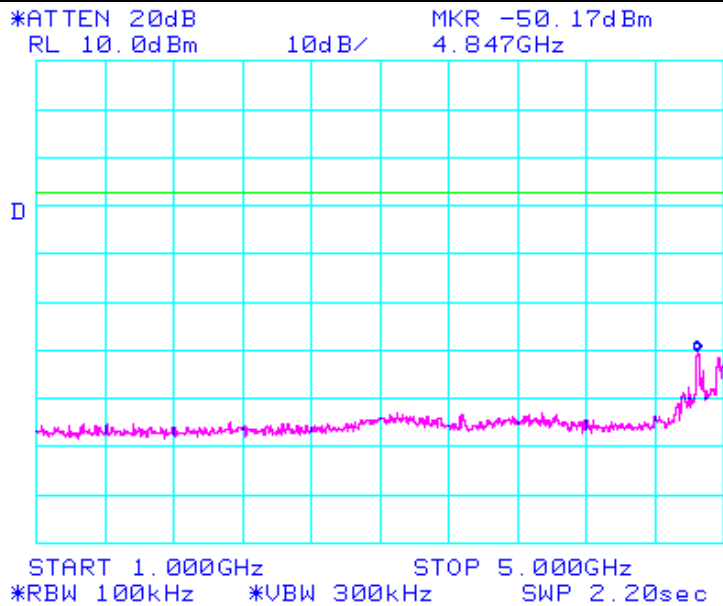

Page 61 of 75 (Appendix A)
Report Number: INTEL-050901F
FCC ID: PD9WM3945ABG



Conducted Out Of Band Emissions (Continued)

802.11a Mode

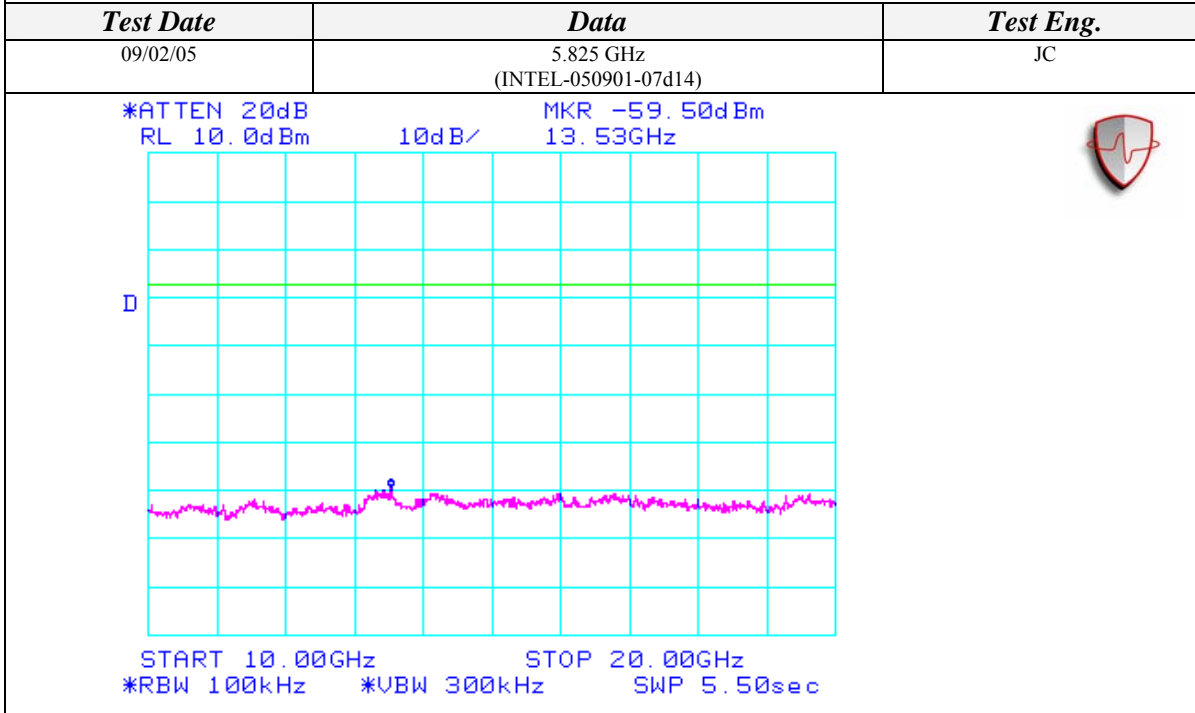
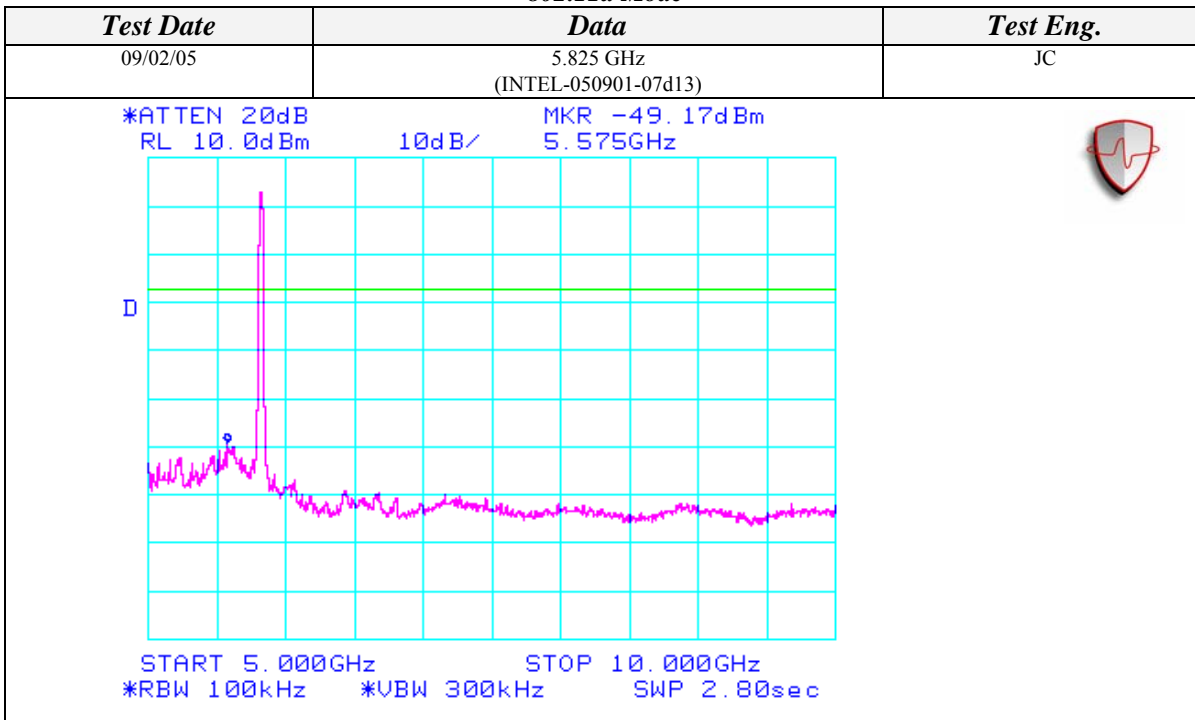



AEGIS LABS INC.

Conducted Out Of Band Emissions (Continued)

802.11b Mode

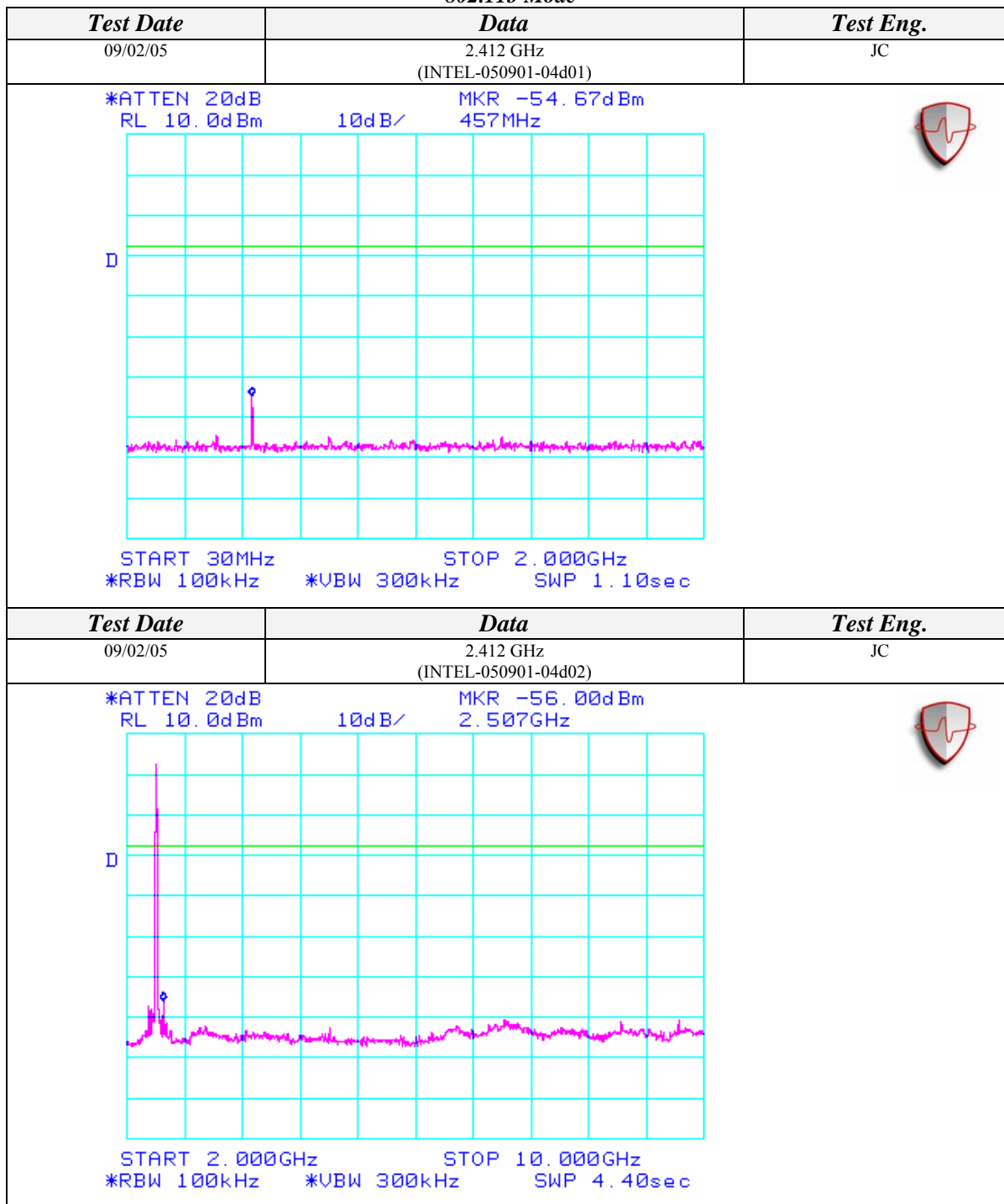



AEGIS LABS INC.

Conducted Out Of Band Emissions (Continued)

802.11b Mode

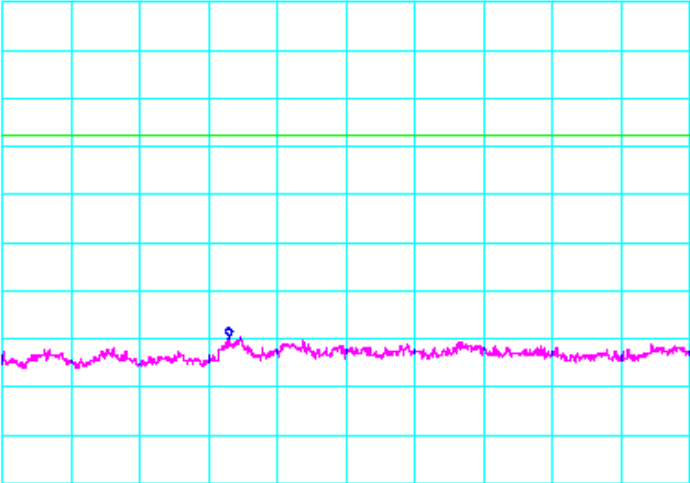
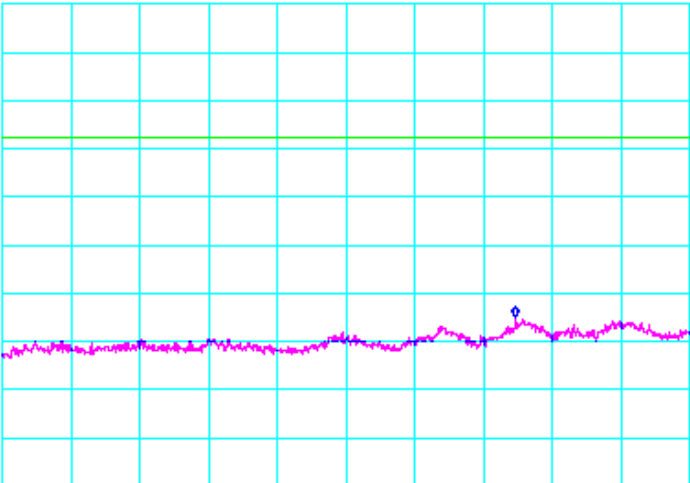
Test Date	Data	Test Eng.
09/02/05	2.412 GHz (INTEL-050901-04d03)	JC
<p>*ATTEN 20dB MKR -59.50dBm RL 10.0dBm 10dB/ 13.30GHz</p>  <p>START 10.00GHz STOP 20.00GHz *RBW 100kHz *VBW 300kHz SWP 5.50sec</p>		
Test Date	Data	Test Eng.
09/02/05	2.412 GHz (INTEL-050901-04d04)	JC
<p>*ATTEN 20dB MKR -54.83dBm RL 10.0dBm 10dB/ 24.480GHz</p>  <p>START 20.000GHz STOP 26.000GHz *RBW 100kHz *VBW 300kHz SWP 3.30sec</p>		

Page 65 of 75 (Appendix A)
Report Number: INTEL-050901F
FCC ID: PD9WM3945ABG



Conducted Out Of Band Emissions (Continued)

802.11b Mode

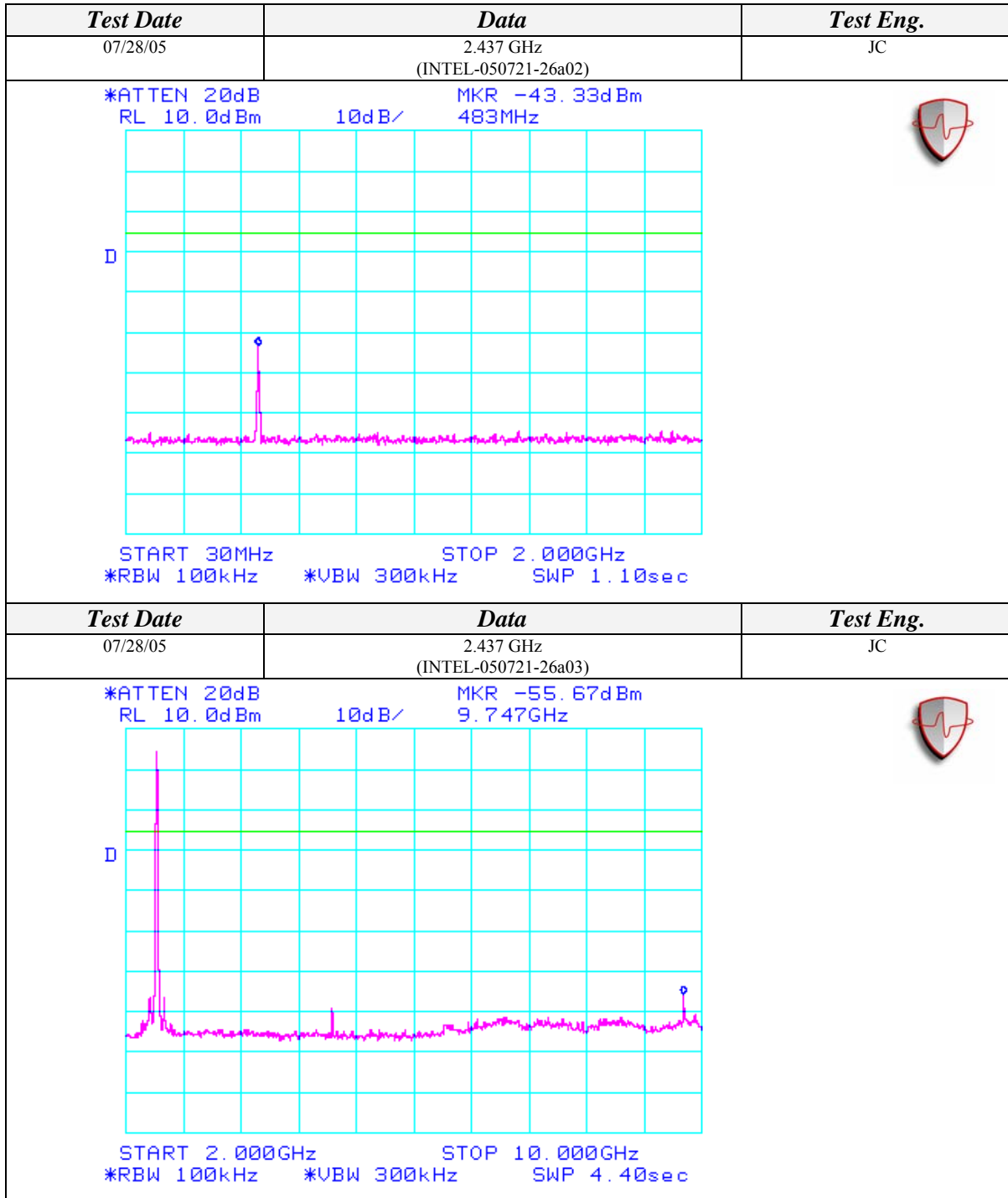



Conducted Out Of Band Emissions (Continued)

802.11b Mode

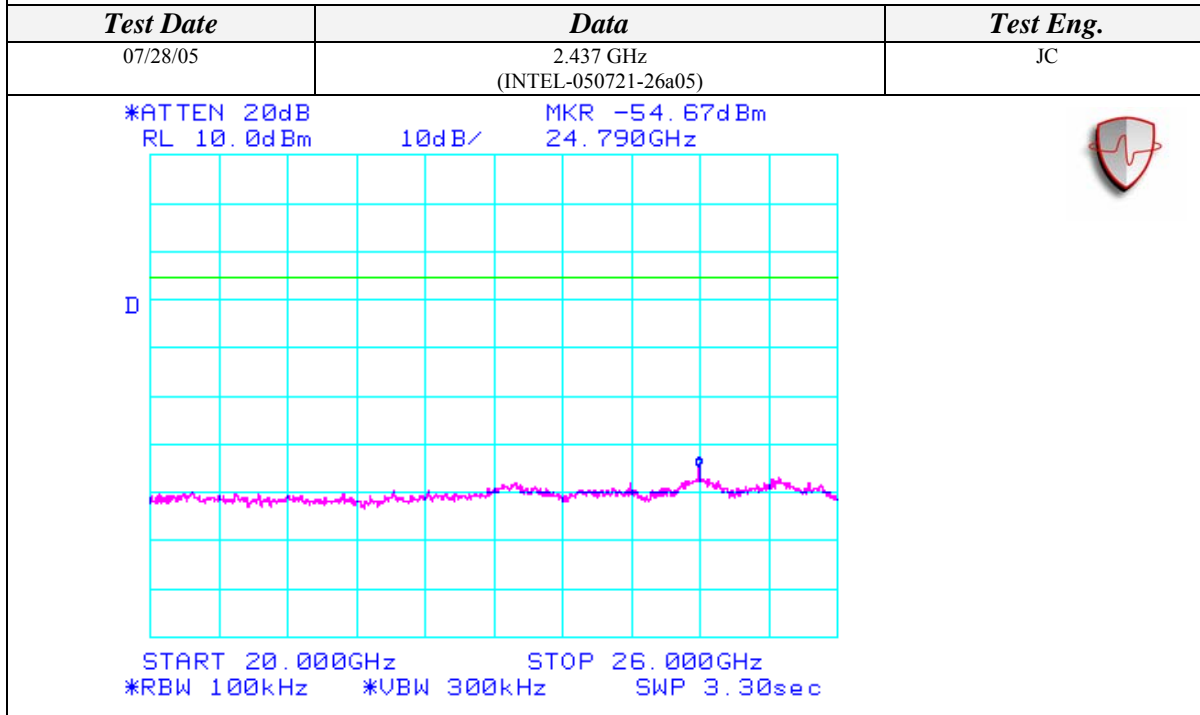
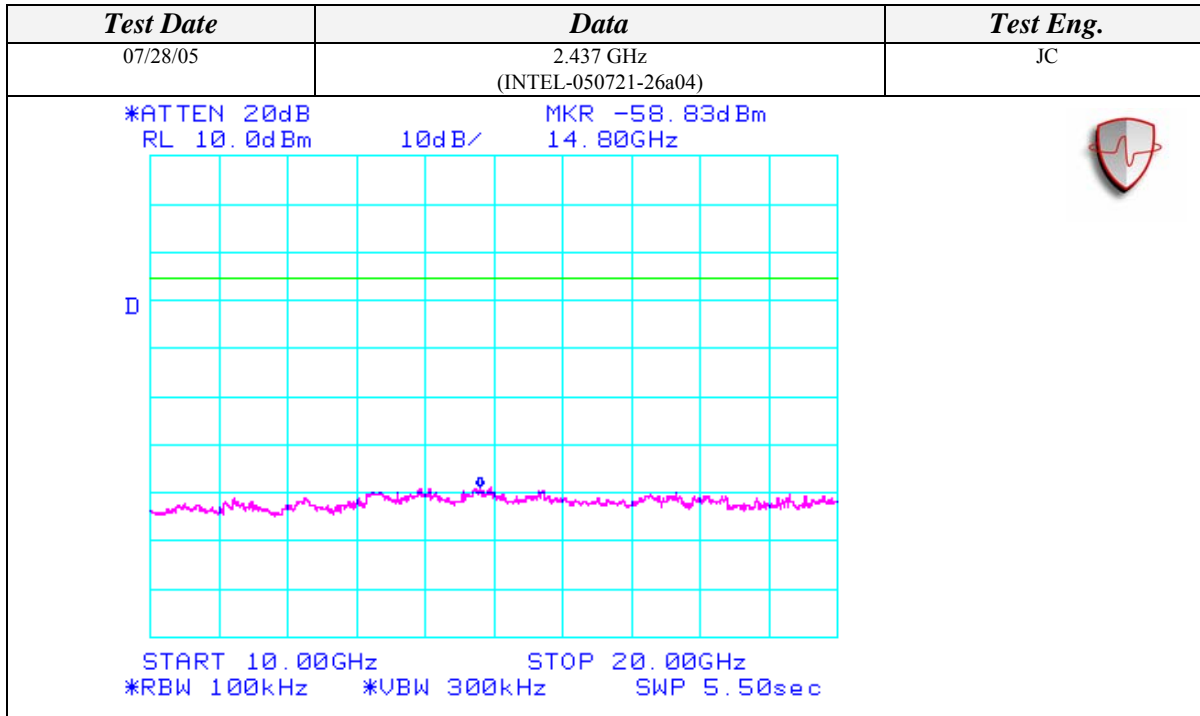



AEGIS LABS INC.

Conducted Out Of Band Emissions (Continued)

802.11b Mode

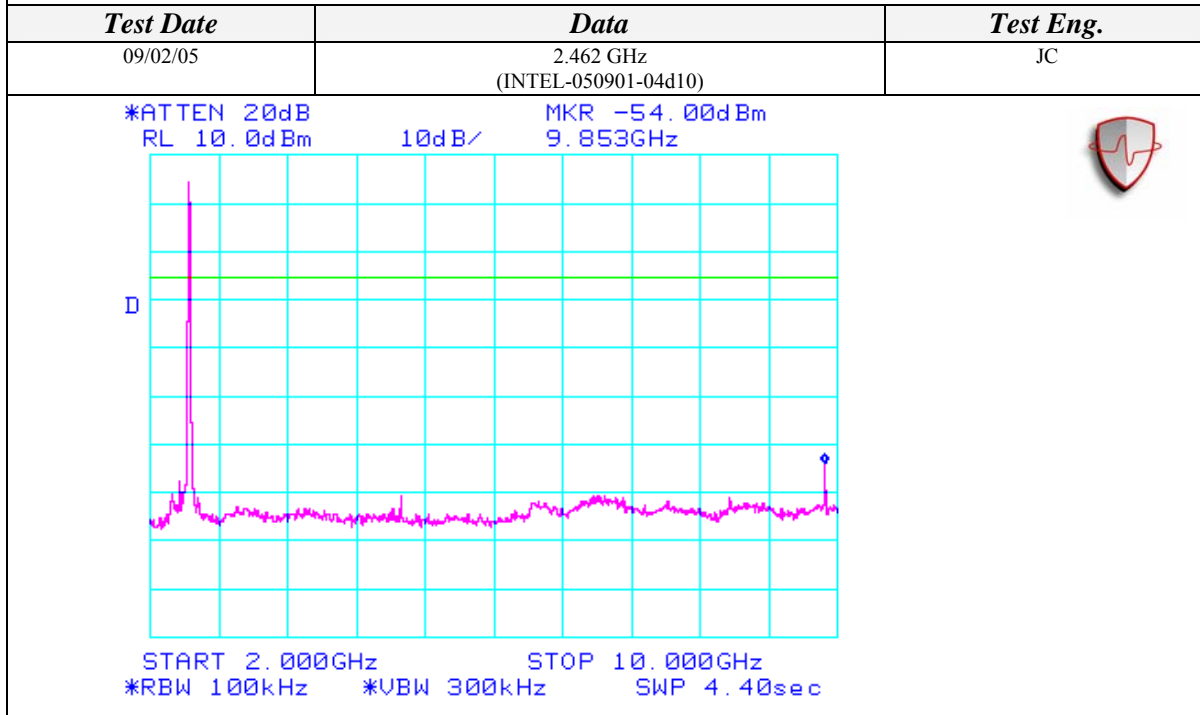
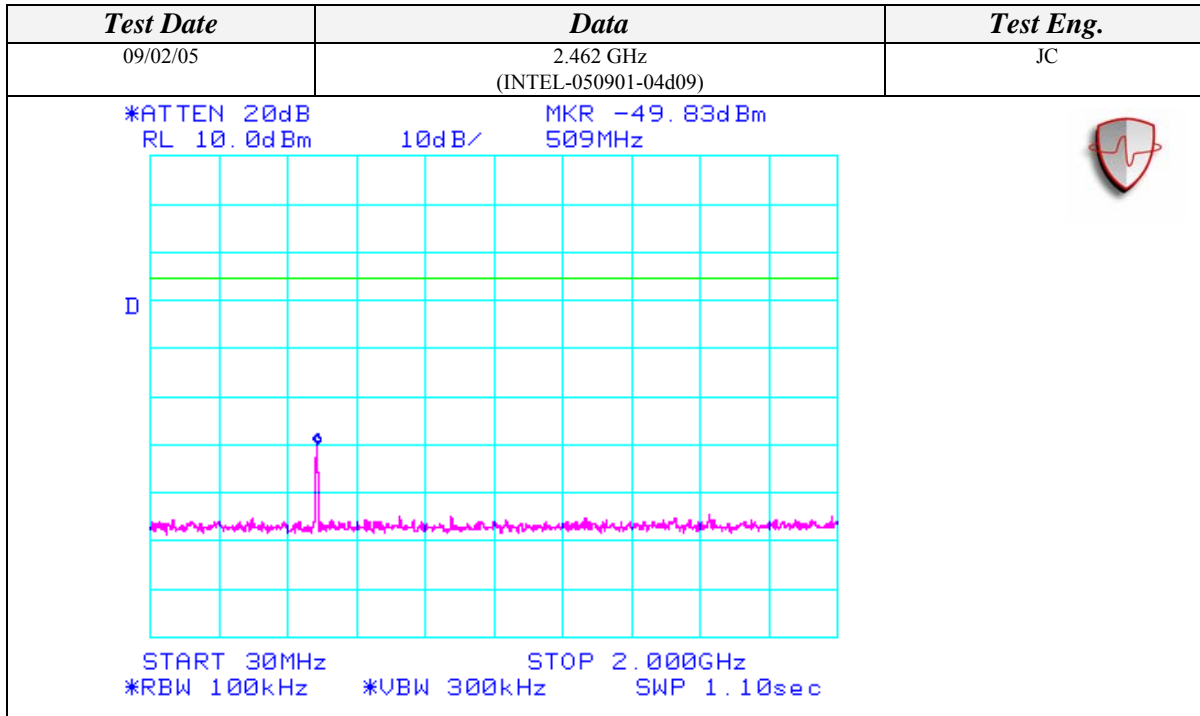

Page 68 of 75 (Appendix A)
Report Number: INTEL-050901F
FCC ID: PD9WM3945ABG



AEGIS LABS INC.

Conducted Out Of Band Emissions (Continued)

802.11b Mode

Test Date	Data	Test Eng.
09/02/05	2.462 GHz (INTEL-050901-04d11)	JC
<p>*ATTEN 20dB MKR -59.00dBm RL 10.0dBm 10dB/ 13.38GHz</p> <p>START 10.00GHz STOP 20.00GHz *RBW 100kHz *VBW 300kHz SWP 5.50sec</p>		
Test Date	Data	Test Eng.
09/02/05	2.462 GHz (INTEL-050901-04d12)	JC
<p>*ATTEN 20dB MKR -54.67dBm RL 10.0dBm 10dB/ 24.580GHz</p> <p>START 20.000GHz STOP 26.000GHz *RBW 100kHz *VBW 300kHz SWP 3.30sec</p>		

Page 69 of 75 (Appendix A)
 Report Number: INTEL-050901F
 FCC ID: PD9WM3945ABG



Conducted Out Of Band Emissions (Continued)

802.11g Mode

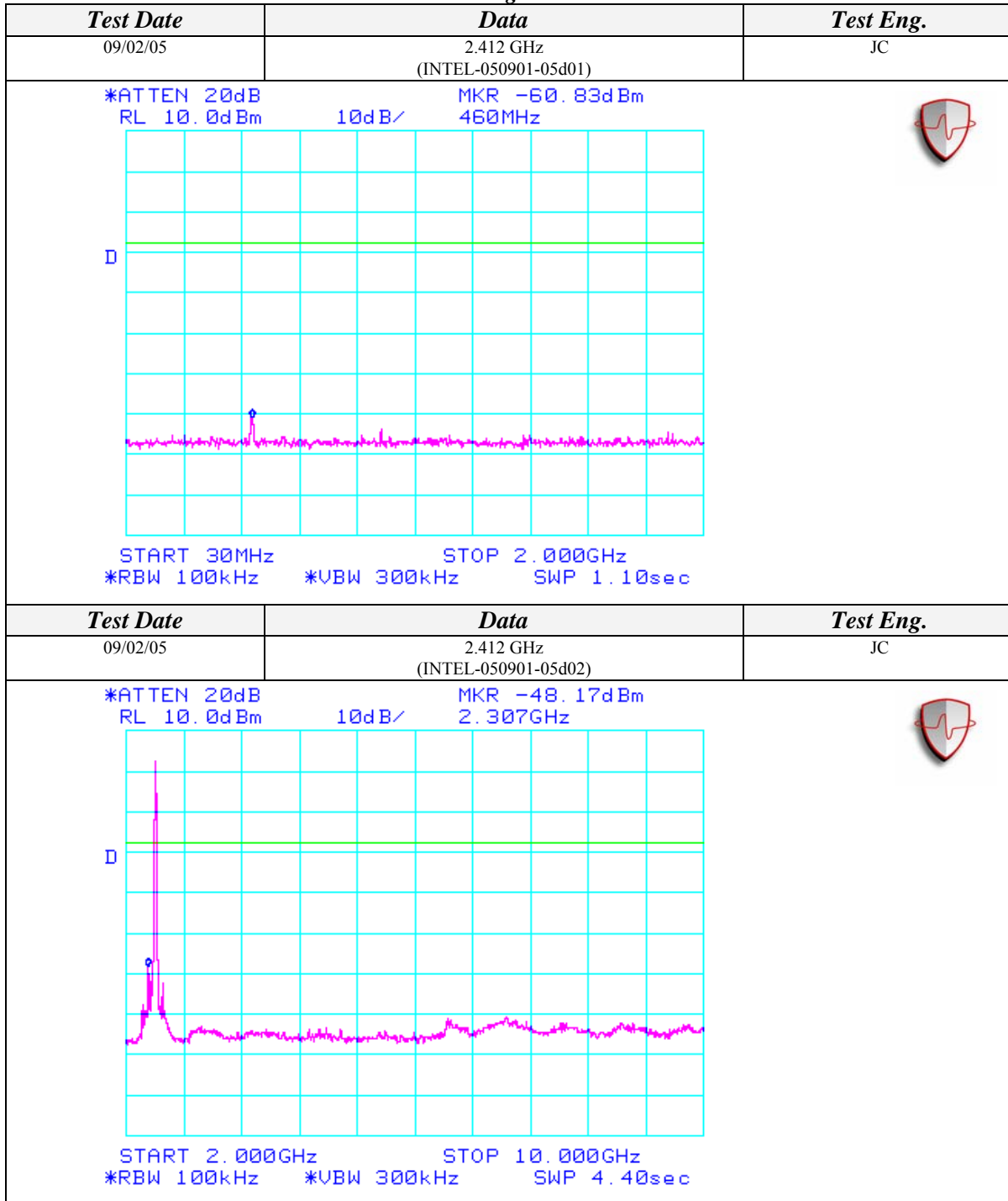



Conducted Out Of Band Emissions (Continued)

802.11g Mode

Test Date	Data	Test Eng.
07/28/05	2.437 GHz (INTEL-050721-26b02)	JC

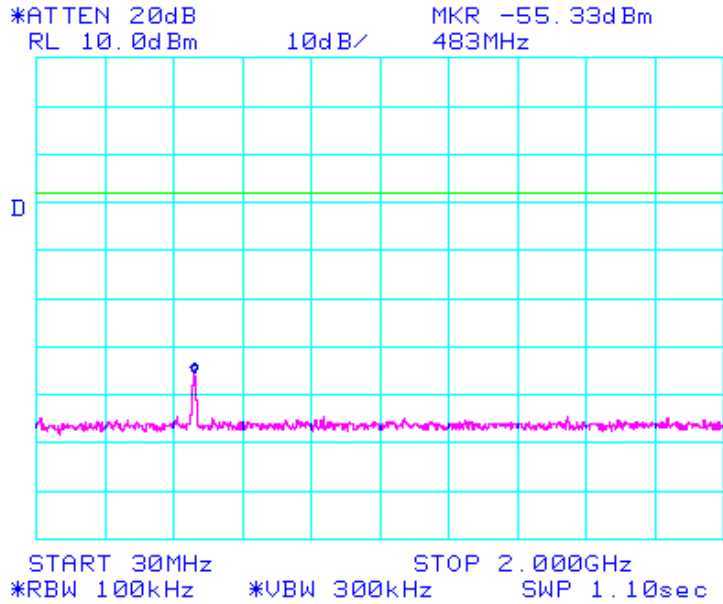

Test Date	Data	Test Eng.
07/28/05	2.437 GHz (INTEL-050721-26b03)	JC

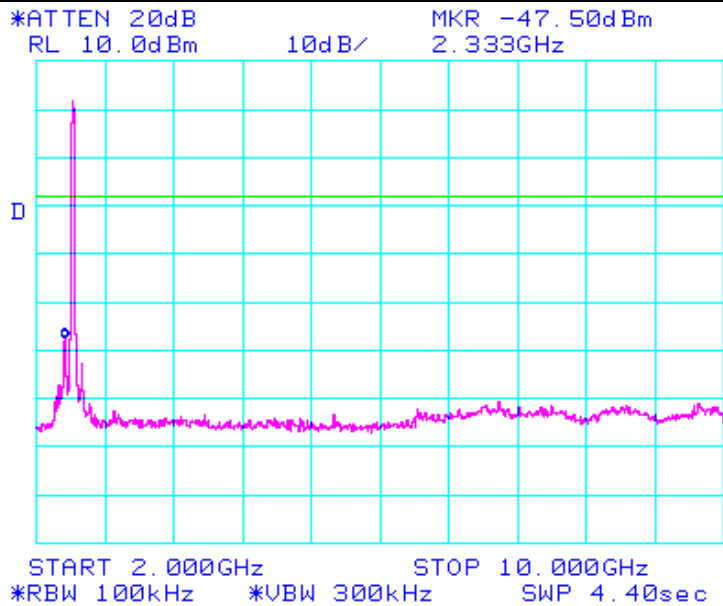



Conducted Out Of Band Emissions (Continued)

802.11g Mode

Test Date	Data	Test Eng.
07/28/05	2.437 GHz (INTEL-050721-26b04)	JC

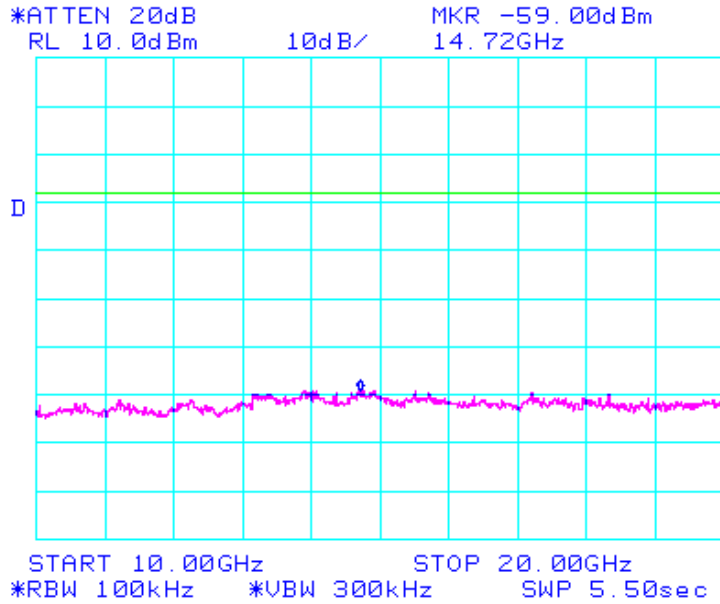

Test Date	Data	Test Eng.
07/28/05	2.437 GHz (INTEL-050721-26b05)	JC

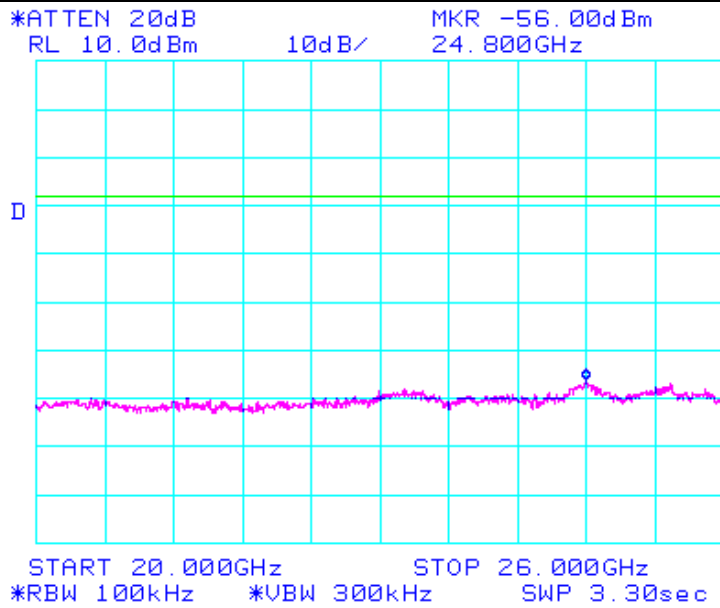



Conducted Out Of Band Emissions (Continued)

802.11g Mode

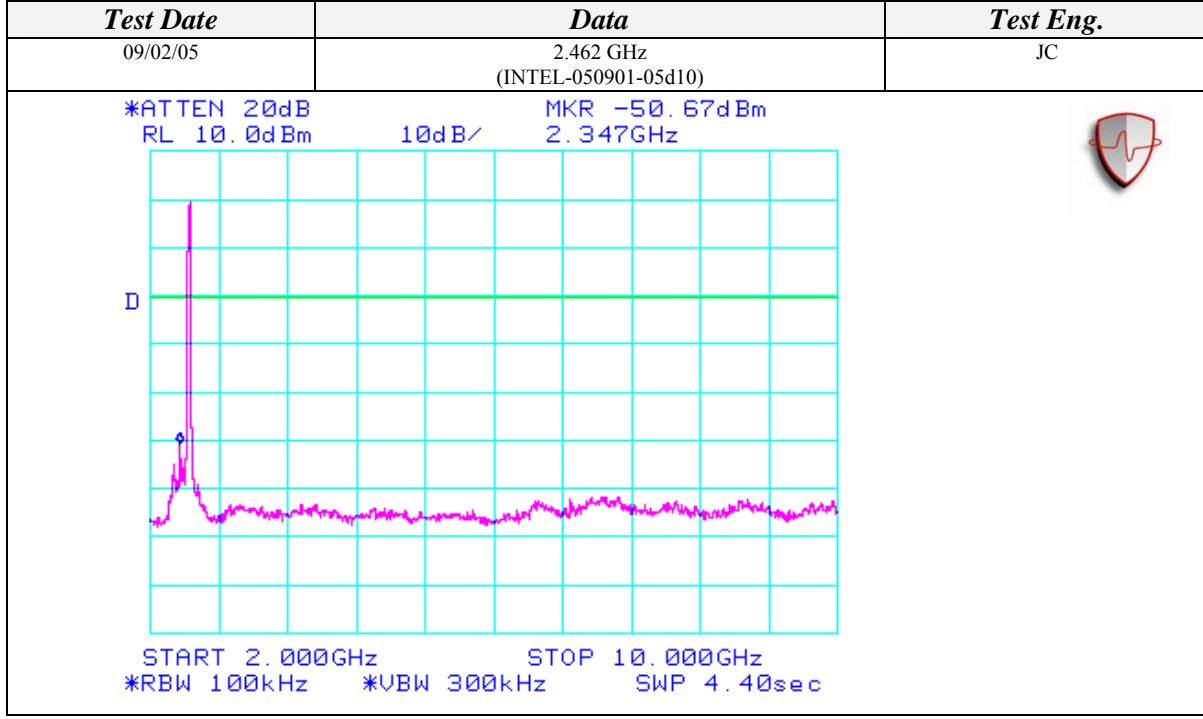
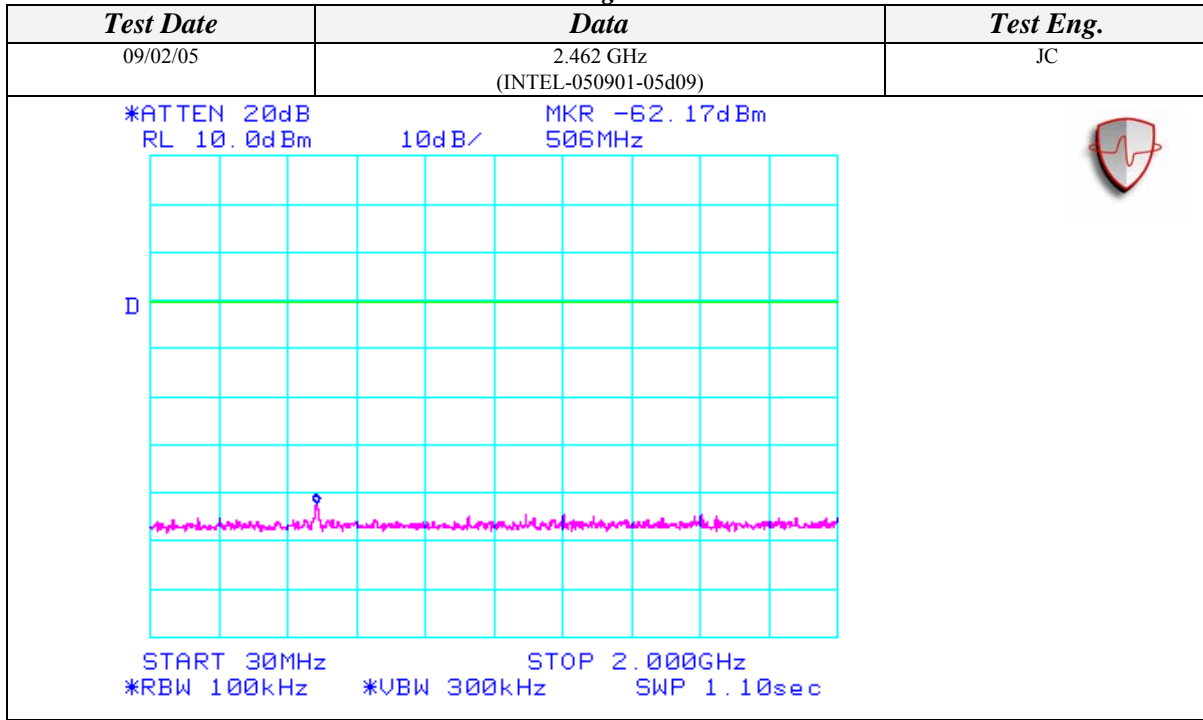



AEGIS LABS INC.

Conducted Out Of Band Emissions (Continued)

802.11g Mode

<i>Test Date</i>	<i>Data</i>	<i>Test Eng.</i>
09/02/05	2.462 GHz (INTEL-050901-05d11)	JC
<p>*ATTEN 20dB MKR -59.67dBm RL 10.0dBm 10dB/ 14.32GHz</p> <p>START 10.00GHz STOP 20.00GHz *RBW 100kHz *VBW 300kHz SWP 5.50sec</p>		
<i>Test Date</i>	<i>Data</i>	<i>Test Eng.</i>
09/02/05	2.462 GHz (INTEL-050901-05d12)	JC
<p>*ATTEN 20dB MKR -54.67dBm RL 10.0dBm 10dB/ 24.490GHz</p> <p>START 20.000GHz STOP 26.000GHz *RBW 100kHz *VBW 300kHz SWP 3.30sec</p>		