

**DECLARATION OF COMPLIANCE  
SAR EVALUATION**

**Test Lab**

**CELLTECH LABS INC.**  
Testing and Engineering Lab  
1955 Moss Court  
Kelowna, B.C.  
Canada V1Y 9L3  
Phone: 250-448-7047  
Fax: 250-448-7046  
e-mail: info@celltechlabs.com  
web site: www.celltechlabs.com

**Applicant Information**

**ITRONIX CORPORATION**  
801 South Stevens Street  
Spokane, WA 99210

<b>Rule Part(s):</b>	<b>FCC 47 CFR §2.1093; IC RSS-102 Issue 1 (Provisional)</b>
<b>Test Procedure(s):</b>	<b>FCC OET Bulletin 65, Supplement C (Edition 01-01)</b>
<b>FCC Device Classification:</b>	<b>Licensed Non-Broadcast Station Transmitter (TNB)</b>
<b>IC Device Classification:</b>	<b>Land Mobile Radio Transmitter</b>
<b>FCC ID:</b>	<b>KBCIX260RIM902</b>
<b>Model(s):</b>	<b>IX260</b>
<b>Device Type:</b>	<b>Rugged Laptop PC with RIM 902 Mobitex Radio Modem</b>
<b>Modulation:</b>	<b>GMSK</b>
<b>Tx Frequency Range:</b>	<b>896.0 - 901.0 MHz</b>
<b>RF Output Power Tested:</b>	<b>33.1 dBm (Conducted)</b>
<b>Antenna Type:</b>	<b>External Swivel Dipole</b>
<b>Battery Type:</b>	<b>11.1V Lithium-Ion, 6.0Ah (Model: A2121-2)</b>
<b>Max. SAR Measured:</b>	<b>1.35 W/kg (1g average)</b>

Celltech Labs Inc. declares under its sole responsibility that this device was found to be in compliance with the Specific Absorption Rate (SAR) RF exposure requirements specified in FCC 47 CFR §2.1093 and Health Canada's Safety Code 6. The device was tested in accordance with the measurement standards and procedures specified in FCC OET Bulletin 65, Supplement C (Edition 01-01), and Industry Canada RSS-102 Issue 1 (Provisional) for the General Population / Uncontrolled Exposure environment.

I attest to the accuracy of data. All measurements were performed by me or were made under my supervision and are correct to the best of my knowledge and belief. I assume full responsibility for the completeness of these measurements and vouch for the qualifications of all persons taking them.

This test report shall not be reproduced partially, or in full, without the prior written approval of Celltech Labs Inc. The results and statements contained in this report pertain only to the device(s) evaluated.



**Russell Pipe**  
**Senior Compliance Technologist**  
**Celltech Labs Inc.**



<b>TABLE OF CONTENTS</b>		
<b>1.0</b>	<b>INTRODUCTION.....</b>	<b>3</b>
<b>2.0</b>	<b>DESCRIPTION OF EUT.....</b>	<b>3</b>
<b>3.0</b>	<b>SAR MEASUREMENT SYSTEM .....</b>	<b>4</b>
<b>4.0</b>	<b>MEASUREMENT SUMMARY.....</b>	<b>5</b>
<b>5.0</b>	<b>DETAILS OF SAR EVALUATION.....</b>	<b>6</b>
<b>6.0</b>	<b>EVALUATION PROCEDURES.....</b>	<b>6-7</b>
<b>7.0</b>	<b>SYSTEM PERFORMANCE CHECK.....</b>	<b>8</b>
<b>8.0</b>	<b>EQUIVALENT TISSUES.....</b>	<b>9</b>
<b>9.0</b>	<b>SAR LIMITS.....</b>	<b>9</b>
<b>10.0</b>	<b>SYSTEM SPECIFICATIONS.....</b>	<b>10</b>
<b>11.0</b>	<b>PROBE SPECIFICATION.....</b>	<b>11</b>
<b>12.0</b>	<b>SAM PHANTOM.....</b>	<b>11</b>
<b>13.0</b>	<b>DEVICE HOLDER.....</b>	<b>11</b>
<b>14.0</b>	<b>TEST EQUIPMENT LIST.....</b>	<b>12</b>
<b>15.0</b>	<b>MEASUREMENT UNCERTAINTIES.....</b>	<b>13-14</b>
<b>16.0</b>	<b>REFERENCES.....</b>	<b>15</b>
	<b>APPENDIX A - SAR MEASUREMENT DATA.....</b>	<b>16</b>
	<b>APPENDIX B - SYSTEM PERFORMANCE CHECK DATA.....</b>	<b>17</b>
	<b>APPENDIX C - SYSTEM VALIDATION.....</b>	<b>18</b>
	<b>APPENDIX D - PROBE CALIBRATION.....</b>	<b>19</b>
	<b>APPENDIX E - MEASURED FLUID DIELECTRIC PARAMETERS.....</b>	<b>20</b>
	<b>APPENDIX F - SAM PHANTOM CERTIFICATE OF CONFORMITY.....</b>	<b>21</b>
	<b>APPENDIX G - SAR TEST SETUP PHOTOGRAPHS.....</b>	<b>22</b>

## 1.0 INTRODUCTION

This measurement report demonstrates that the ITRONIX CORPORATION Model: IX260 Rugged Laptop PC with RIM 902 Mobitex Radio Modem FCC ID: KBCIX260RIM902 complies with the RF exposure requirements specified in FCC 47 CFR §2.1093 (see reference [1]) and Health Canada's Safety Code 6 (see reference [2]) for the General Population environment. The test procedures described in FCC OET Bulletin 65, Supplement C (Edition 01-01) (see reference [3]) and IC RSS-102 Issue 1 (Provisional) (see reference [4]) were employed. A description of the product, operating configuration, detailed summary of the test results, methodology and procedures used in the evaluation, equipment used, and the various provisions of the rules are included within this test report.

## 2.0 DESCRIPTION of Equipment Under Test (EUT)

<b>FCC Rule Part(s)</b>	47 CFR §2.1093
<b>IC Rule Part(s)</b>	IC RSS-102 Issue 1 (Provisional)
<b>Test Procedure(s)</b>	FCC OET Bulletin 65, Supplement C (Edition 01-01)
<b>FCC Device Classification</b>	Licensed Non-Broadcast Station Transmitter (TNB)
<b>IC Device Classification</b>	Land Mobile Radio Transmitter
<b>Device Type</b>	Rugged Laptop PC with RIM 902 Mobitex Radio Modem
<b>FCC ID</b>	KBCIX260RIM902
<b>Model(s)</b>	IX260
<b>Serial No.</b>	Pre-production unit
<b>Modulation</b>	GMSK
<b>Duty Cycle</b>	25%
<b>Tx Frequency Range</b>	896.0 - 901.0 MHz
<b>RF Output Power Tested</b>	33.1 dBm (Conducted)
<b>Antenna Type</b>	External Dipole (Length: 4.7 inches)
<b>Battery Type</b>	11.1V Lithium-Ion, 6.0Ah (Model: A2121-2)

### 3.0 SAR MEASUREMENT SYSTEM

Celltech Labs SAR measurement facility utilizes the Dosimetric Assessment System (DASY™) manufactured by Schmid & Partner Engineering AG (SPEAG™) of Zurich, Switzerland. The DASY system is comprised of the robot controller, computer, near-field probe, probe alignment sensor, specific anthropomorphic mannequin (SAM) phantom, and various planar phantoms for brain and/or body SAR evaluations. The robot is a six-axis industrial robot performing precise movements to position the probe to the location (points) of maximum electromagnetic field (EMF). A cell controller system contains the power supply, robot controller, teach pendant (Joystick), and remote control, is used to drive the robot motors. The Staubli robot is connected to the cell controller to allow software manipulation of the robot. A data acquisition electronic (DAE) circuit performs the signal amplification, signal multiplexing, AD-conversion, offset measurements, mechanical surface detection, collision detection, etc. is connected to the Electro-optical coupler (EOC). The EOC performs the conversion from the optical into digital electric signal of the DAE and transfers data to the PC plug-in card. The DAE3 utilizes a highly sensitive electrometer-grade preamplifier with auto-zeroing, a channel and gain-switching multiplexer, a fast 16-bit AD-converter and a command decoder and control logic unit. Transmission to the PC-card is accomplished through an optical downlink for data and status information and an optical uplink for commands and clock lines. The mechanical probe-mounting device includes two different sensor systems for frontal and sidewise probe contacts. They are also used for mechanical surface detection and probe collision detection. The robot uses its own controller with a built in VME-bus computer.



DASY3 SAR Measurement System with SAM phantom

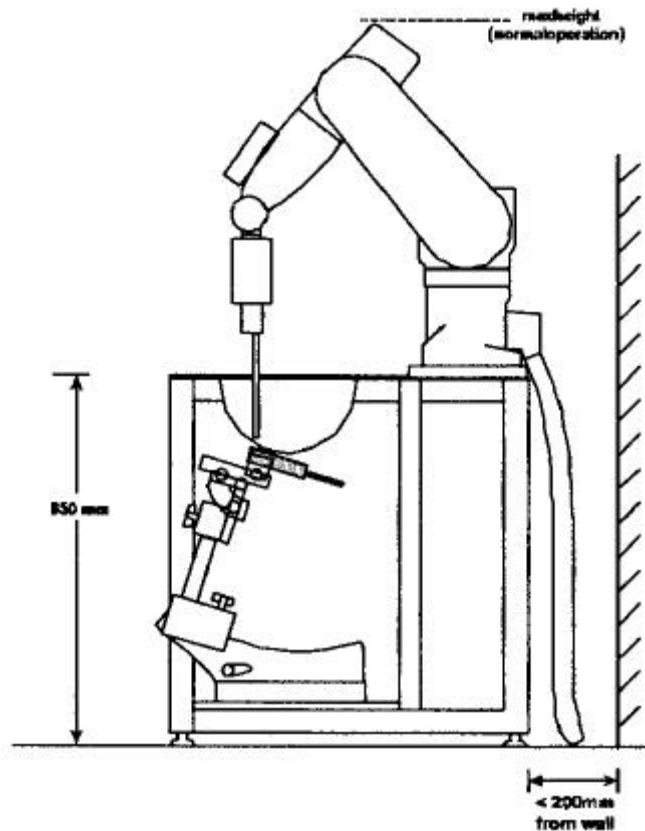

Figure 1. DASY3 Compact Version - Side View

## 4.0 MEASUREMENT SUMMARY

The measurement results were obtained with the EUT tested in the conditions described in this report. Detailed measurement data and plots showing the maximum SAR location of the EUT are reported in Appendix A.

BODY SAR MEASUREMENT RESULTS									
Freq. (MHz)	Channel	Test Mode	Conducted Power (dBm)		Phantom Section	Antenna Position to Planar Phantom	Laptop PC Position to Planar Phantom	Separation Distance (cm)	Measured SAR 1g (W/kg)
			Before	After					
899.0	721	Modulated	33.1	33.0	Planar	Parallel (Stowed)	Back of LCD (LCD Closed)	0.0	1.35
899.0	721	Modulated	33.1	33.0	Planar	Perpendicular (180°)	Back of LCD (LCD Closed)	0.0	0.0417
899.0	721	Modulated	33.1	33.0	Planar	Parallel (Stowed)	Bottom Side (LCD Closed)	0.0	0.0341
899.0	721	Modulated	33.1	32.9	Planar	Perpendicular (180°)	Bottom Side (LCD Closed)	0.0	0.0425
899.0	721	Modulated	33.1	32.9	Planar	Parallel (Stowed)	Right Side (LCD Closed)	1.5	0.377
899.0	721	Modulated	33.1	32.9	Planar	Parallel (Extended)	Right side (LCD Closed)	1.5	0.918
<b>ANSI / IEEE C95.1 1992 - SAFETY LIMIT</b> <b>BODY: 1.6 W/kg (averaged over 1 gram)</b> <b>Spatial Peak - Uncontrolled Exposure / General Population</b>									
<b>Test Date(s)</b>		06/11/03			<b>Relative Humidity</b>		50 %		
<b>Measured Mixture Type</b>		900MHz Body			<b>Atmospheric Pressure</b>		100.8 kPa		
<b>Dielectric Constant <math>\epsilon_r</math></b>		<b>IEEE Target</b>		<b>Measured</b>		<b>Ambient Temperature</b>		24.4 °C	
		55.0 ±5%		55.6		<b>Fluid Temperature</b>		23.6 °C	
<b>Conductivity <math>\sigma</math> (mho/m)</b>		<b>IEEE Target</b>		<b>Measured</b>		<b>Fluid Depth</b>		≥ 15 cm	
		1.05 ±5%		1.07		<b><math>\rho</math> (Kg/m<sup>3</sup>)</b>		1000	

Note(s):

1. The transmission band of the EUT is less than 10 MHz, therefore mid channel data only is reported (per FCC OET Bulletin 65, Supplement C, Edition 01-01 - see reference [3]).
2. The ambient and fluid temperatures were measured prior to, and during, the fluid dielectric parameter check and the SAR evaluation. The temperatures listed in the table shown above were consistent for all measurement periods.
3. The dielectric properties of the simulated body fluid were measured prior to the evaluation using an 85070C Dielectric Probe Kit and an 8753E Network Analyzer (see Appendix E for printout of measured fluid dielectric parameters).
4. The EUT was evaluated with the LCD display lid in the closed position, which was determined to be the worst-case configuration based on the internal transmitter transmitting when the LCD display lid is closed.

## 5.0 DETAILS OF SAR EVALUATION

The ITRONIX CORPORATION Model: IX260 Rugged Laptop PC with RIM 902 Mobitex Radio Modem FCC ID: KBCIX260RIM902 was found to be compliant for localized Specific Absorption Rate based on the following test provisions and conditions described below. The detailed test setup photographs are shown in Appendix G.

1. The EUT was tested for body SAR with the LCD display closed and the back of the LCD display facing parallel to the outer surface of the SAM phantom (planar section), and a 0.0 cm separation distance between the back of the LCD display and the SAM phantom (planar section). The EUT was tested with the antenna in both the parallel (stowed) and perpendicular ( $180^\circ$ ) positions to the outer surface of the SAM phantom (planar section).
2. The EUT was tested for body SAR with the LCD display closed and the bottom of the Laptop PC facing parallel to, and touching, the outer surface of the SAM phantom (planar section). The EUT was tested with the antenna in both the parallel (stowed) and perpendicular ( $180^\circ$ ) positions to the outer surface of the SAM phantom (planar section).
3. The EUT was tested for body SAR with the LCD display closed and the right side of the LCD display (antenna side) facing parallel to the outer surface of the SAM phantom (planar section), and a 1.5 cm separation distance between the antenna and the SAM phantom (planar section). The EUT was tested with the antenna parallel to the outer surface of the SAM phantom (planar section) in both the stowed and extended positions.
4. All secondary peak SAR locations within 3dB of the primary peak value were evaluated (see SAR Plots - Appendix A).
5. Due to the dimensions of the EUT the initial coarse scans did not cover the entire area of the Laptop PC. Subsequently, a second coarse scan was performed for the highest SAR configurations to show there were no secondary peak SAR locations within 3dB of the primary peak values.
6. Due to the dimensions of the EUT, a stack of low-density, low-loss dielectric foamed polystyrene was used in place of the device holder.
7. The conducted power levels were measured before and after each test using a Gigatronics 8652A Universal Power Meter according to the procedures described in FCC 47 CFR §2.1046. If the conducted power levels measured after each evaluation varied more than 5% from the initial power level, then the EUT was retested. Any unusual anomalies over the course of the test also warranted a re-evaluation.
8. The internal transmitter was controlled in test mode via the Laptop PC using the RIM 902 Mobitex test software, which requires a RIM type test tool to be installed in the parallel port of the Laptop PC. SAR measurements were performed with the transmitter operating at a full rated power in modulated carrier mode at a maximum duty cycle of 25% (Crest Factor: 4).
9. The EUT was tested with a fully charged battery.

## 6.0 EVALUATION PROCEDURES

- a. (i) The evaluation was performed in the applicable area of the phantom depending on the type of device being tested. For devices held to the ear during normal operation, both the left and right ear positions were evaluated in accordance with FCC OET Bulletin 65, Supplement C (Edition 01-01) using the SAM phantom.  
(ii) For body-worn and face-held devices a planar phantom was used.
- b. The SAR was determined by a pre-defined procedure within the DASY3 software. Upon completion of a reference and optical surface check, the exposed region of the phantom was scanned near the inner surface with a grid spacing of 20mm x 20mm.
- c. Based on the area scan data, the area of maximum absorption was determined by spline interpolation. Around this point, a volume of 40 x 40 x 35 mm (fine resolution volume scan, zoom scan) was assessed by measuring 5 x 5 x 7 points.
- d. The 1g and 10g spatial peak SAR was determined as follows:
  1. The first step was an extrapolation to find the points between the dipole center of the probe and the surface of the phantom. This data cannot be measured, since the center of the dipoles is 2.7 mm away from the tip of the probe and the distance between the surface and the lowest measuring point is 1.4 mm (see probe calibration document in Appendix D). The extrapolation was based on a least square algorithm [W. Gander, Computermathematik, p.168-180] (see reference [6]). Through the points in the first 3 cm in all z-axis, polynomials of the fourth order were calculated. This polynomial was then used to evaluate the points between the surface and the probe tip.
  2. The next step used 3D-spline interpolation to get all points within the measured volume in a 1mm grid (35000 points). The 3D-spline is composed of three one-dimensional splines with the "Not a knot" condition [W. Gander, Computermathematik, p.141-150] (x, y and z -direction) [Numerical Recipes in C, Second Edition, p.123ff] (see reference [6]).
  3. The maximal interpolated value was searched with a straightforward algorithm. Around this maximum the SAR values averaged over the spatial volumes (1g or 10g) were computed using the 3D-spline interpolation algorithm. 8000 points (20x20x20) were interpolated to calculate the average.

**EVALUATION PROCEDURES (Cont.)**

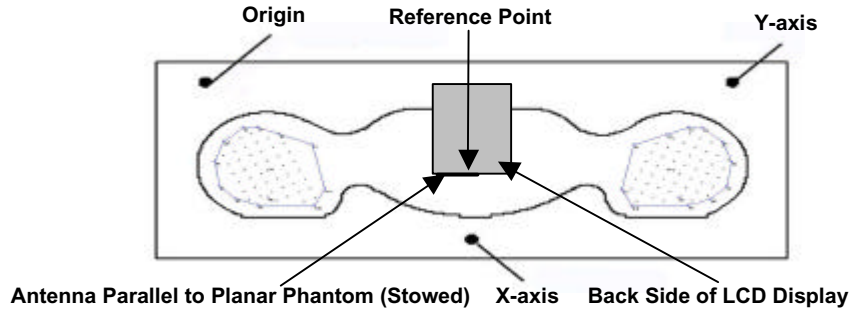

**Figure 2. Phantom Reference Point & EUT Positioning Back Side of LCD Display (Closed)**

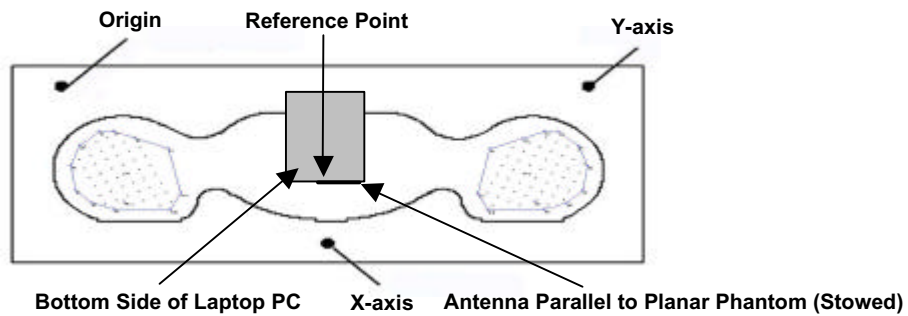

**Figure 3. Phantom Reference Point & EUT Positioning Bottom Side of Laptop PC (LCD Display Closed)**

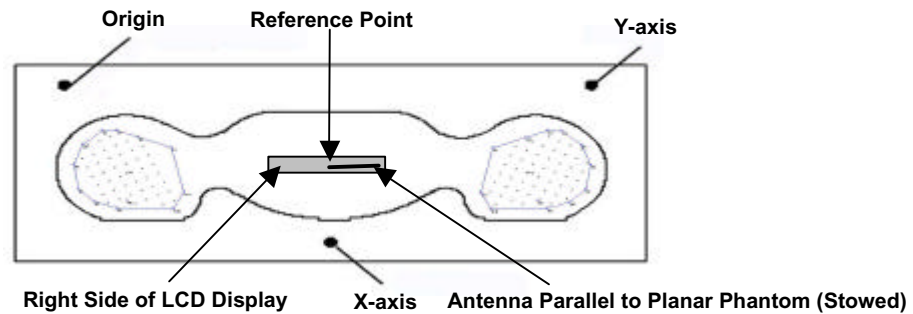

**Figure 4. Phantom Reference Point & EUT Positioning Right Side of LCD Display (Closed)**

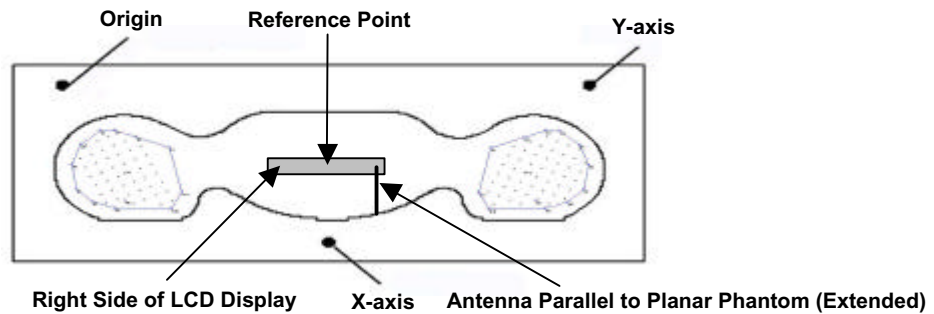

**Figure 5. Phantom Reference Point & EUT Positioning Right Side of LCD Display (Closed)**

## 7.0 SYSTEM PERFORMANCE CHECK

Prior to the SAR evaluation a system check was performed in the planar section of the SAM phantom with a 900MHz dipole (see Appendix C for system validation procedures). The dielectric parameters of the simulated brain tissue fluid were measured prior to the system check using an 85070C Dielectric Probe Kit and an 8753E Network Analyzer (see Appendix E for printout of measured fluid dielectric parameters). A forward power of 250mW was applied to the dipole and the system was verified to a tolerance of  $\pm 10\%$  (see Appendix B for system check test plot).

SYSTEM PERFORMANCE CHECK											
Test Date	900MHz Equiv. Tissue	SAR 1g (W/kg)		Dielectric Constant $\epsilon_r$		Conductivity $\sigma$ (mho/m)		$\rho$ (Kg/m <sup>3</sup> )	Ambient Temp.	Fluid Temp.	Fluid Depth
		IEEE Target	Measured	IEEE Target	Measured	IEEE Target	Measured				
06/11/03	Brain	2.70 $\pm 10\%$	2.61	41.5 $\pm 5\%$	42.0	0.97 $\pm 5\%$	0.99	1000	24.4 °C	23.5 °C	$\geq 15$ cm

Note(s):

1. The ambient and fluid temperatures were measured prior to, and during, the fluid dielectric parameter check and the system performance check. The temperatures listed in the table above were consistent for all measurement periods.

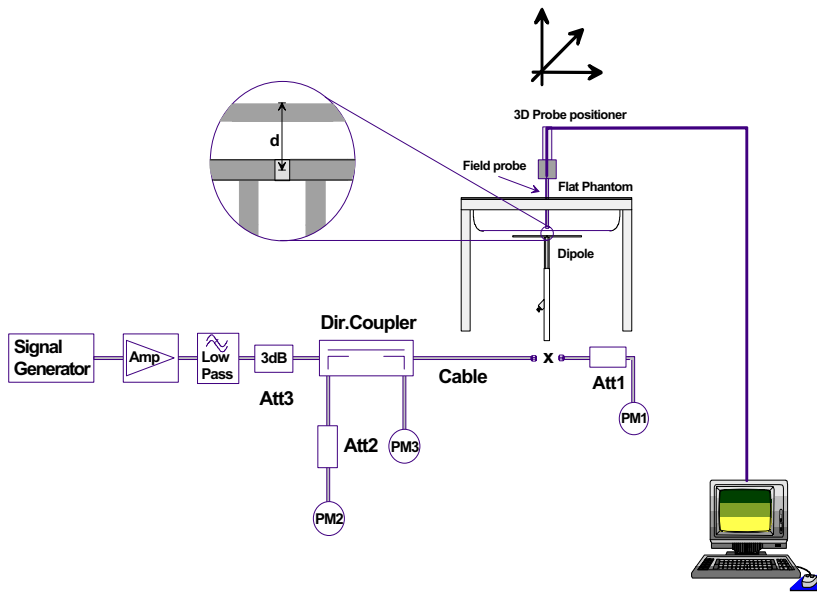

Figure 6. System Check Setup Diagram



900MHz System Check Setup



## 8.0 EQUIVALENT TISSUES

The 900MHz simulated tissue mixtures consist of a viscous gel using hydroxyethylcellulose (HEC) gelling agent and saline solution. Preservation with a bactericide was added and visual inspection was made to ensure air bubbles were not trapped during the mixing process. The fluids were prepared according to standardized procedures and measured for dielectric parameters (permittivity and conductivity).

Simulated Tissue Mixtures		
INGREDIENT	900MHz Brain (System Check)	900MHz Body (EUT Evaluation)
Water	40.71 %	53.70 %
Sugar	56.63 %	45.10 %
Salt	1.48 %	0.97 %
HEC	1.00 %	0.13%
Bactericide	0.18 %	0.10 %

## 9.0 SAR SAFETY LIMITS

EXPOSURE LIMITS	SAR (W/kg)	
	(General Population / Uncontrolled Exposure Environment)	(Occupational / Controlled Exposure Environment)
Spatial Average (averaged over the whole body)	0.08	0.4
Spatial Peak (averaged over any 1 g of tissue)	1.60	8.0
Spatial Peak (hands/wrists/feet/ankles averaged over 10 g)	4.0	20.0

Notes:

1. Uncontrolled environments are defined as locations where there is potential exposure of individuals who have no knowledge or control of their potential exposure.
2. Controlled environments are defined as locations where there is potential exposure of individuals who have knowledge of their potential exposure and can exercise control over their exposure.

---

## 10.0 ROBOT SYSTEM SPECIFICATIONS

### Specifications

**POSITIONER:** Stäubli Unimation Corp. Robot Model: RX60L  
**Repeatability:** 0.02 mm  
**No. of axis:** 6

### Data Acquisition Electronic (DAE) System

#### Cell Controller

**Processor:** Pentium III  
**Clock Speed:** 450 MHz  
**Operating System:** Windows NT  
**Data Card:** DASY3 PC-Board

#### Data Converter

**Features:** Signal Amplifier, multiplexer, A/D converter, and control logic  
**Software:** DASY3 software  
**Connecting Lines:** Optical downlink for data and status info.  
Optical uplink for commands and clock

### PC Interface Card

**Function:** 24 bit (64 MHz) DSP for real time processing  
Link to DAE3  
16-bit A/D converter for surface detection system  
serial link to robot  
direct emergency stop output for robot

### E-Field Probe

**Model:** ET3DV6  
**Serial No.(s):** 1387  
**Construction:** Triangular core fiber optic detection system  
**Frequency:** 10 MHz to 6 GHz  
**Linearity:**  $\pm 0.2$  dB (30 MHz to 3 GHz)

### Phantom

**Type:** SAM V4.0C  
**Shell Material:** Fiberglass  
**Thickness:** 2.0  $\pm$ 0.1 mm  
**Volume:** Approx. 20 liters

## 11.0 PROBE SPECIFICATION (ET3DV6)

Construction:	Symmetrical design with triangular core Built-in shielding against static charges PEEK enclosure material (resistant to organic solvents, e.g. glycol)
Calibration:	In air from 10 MHz to 2.5 GHz In brain simulating tissue at frequencies of 900 MHz and 1.8 GHz (accuracy $\pm 8\%$ )
Frequency:	10 MHz to >6 GHz; Linearity: $\pm 0.2$ dB (30 MHz to 3 GHz)
Directivity:	$\pm 0.2$ dB in brain tissue (rotation around probe axis) $\pm 0.4$ dB in brain tissue (rotation normal to probe axis)
Dynamic Range:	5 $\mu$ W/g to >100 mW/g; Linearity: $\pm 0.2$ dB
Surface Detect.	$\pm 0.2$ mm repeatability in air and clear liquids over diffuse reflecting surfaces
Dimensions:	Overall length: 330 mm Tip length: 16 mm Body diameter: 12 mm Tip diameter: 6.8 mm Distance from probe tip to dipole centers: 2.7 mm
Application:	General dosimetry up to 3 GHz Compliance tests of mobile phone



ET3DV6 E-Field Probe

## 12.0 SAM PHANTOM V4.0C

The SAM phantom V4.0C is a fiberglass shell phantom with a 2.0 mm shell thickness for left and right head and flat planar area integrated in a wooden table. The shape of the fiberglass shell corresponds to the phantom defined by SCC34-SC2. The device holder positions are adjusted to the standard measurement positions in the three sections.

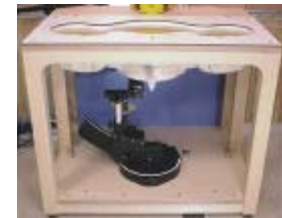

SAM Phantom

## 13.0 DEVICE HOLDER

The DAS3 device holder has two scales for device rotation (with respect to the body axis) and the device inclination (with respect to the line between the ear openings). The plane between the ear openings and the mouth tip has a rotation angle of 65°. The bottom plate contains three pair of bolts for locking the device holder. The device holder positions are adjusted to the standard measurement positions in the three sections.



Device Holder

## 14.0 TEST EQUIPMENT LIST

SAR MEASUREMENT SYSTEM		
TEST EQUIPMENT	SERIAL NO.	CALIBRATION DATE
Schmid & Partner DASY3 System	-	-
-Robot	599396-01	N/A
-ET3DV6 E-Field Probe	1387	Feb 2003
-300MHz Validation Dipole	135	Oct 2002
-450MHz Validation Dipole	136	Oct 2002
-900MHz Validation Dipole	054	June 2003
-1800MHz Validation Dipole	247	June 2003
-2450MHz Validation Dipole	150	Oct 2002
-SAM Phantom V4.0C	N/A	N/A
-Planar Phantom	N/A	N/A
HP 85070C Dielectric Probe Kit	N/A	N/A
Gigatronics 8651A Power Meter	8650137	April 2003
Gigatronics 8652A Power Meter	1835267	April 2003
Power Sensor 80701A	1833542	Feb 2003
Power Sensor 80701A	1833699	April 2003
HP E4408B Spectrum Analyzer	US39240170	Dec 2002
HP 8594E Spectrum Analyzer	3543A02721	Feb 2003
HP 8753E Network Analyzer	US38433013	Feb 2003
HP 8648D Signal Generator	3847A00611	Feb 2003
Amplifier Research 5S1G4 Power Amplifier	26235	N/A

## 15.0 MEASUREMENT UNCERTAINTIES

UNCERTAINTY BUDGET FOR DEVICE EVALUATION						
Error Description	Uncertainty Value ±%	Probability Distribution	Divisor	$c_i$ 1g	Standard Uncertainty ±% (1g)	$v_i$ or $v_{eff}$
<b>Measurement System</b>						
Probe calibration	± 4.8	Normal	1	1	± 4.8	∞
Axial isotropy of the probe	± 4.7	Rectangular	√3	(1- $c_p$ )	± 1.9	∞
Spherical isotropy of the probe	± 9.6	Rectangular	√3	( $c_p$ )	± 3.9	∞
Spatial resolution	± 0.0	Rectangular	√3	1	± 0.0	∞
Boundary effects	± 5.5	Rectangular	√3	1	± 3.2	∞
Probe linearity	± 4.7	Rectangular	√3	1	± 2.7	∞
Detection limit	± 1.0	Rectangular	√3	1	± 0.6	∞
Readout electronics	± 1.0	Normal	1	1	± 1.0	∞
Response time	± 0.8	Rectangular	√3	1	± 0.5	∞
Integration time	± 1.4	Rectangular	√3	1	± 0.8	∞
RF ambient conditions	± 3.0	Rectangular	√3	1	± 1.7	∞
Mech. constraints of robot	± 0.4	Rectangular	√3	1	± 0.2	∞
Probe positioning	± 2.9	Rectangular	√3	1	± 1.7	∞
Extrapolation & integration	± 3.9	Rectangular	√3	1	± 2.3	∞
<b>Test Sample Related</b>						
Device positioning	± 6.0	Normal	√3	1	± 6.7	12
Device holder uncertainty	± 5.0	Normal	√3	1	± 5.9	8
Power drift	± 5.0	Rectangular	√3		± 2.9	∞
<b>Phantom and Setup</b>						
Phantom uncertainty	± 4.0	Rectangular	√3	1	± 2.3	∞
Liquid conductivity (target)	± 5.0	Rectangular	√3	0.6	± 1.7	∞
Liquid conductivity (measured)	± 5.0	Rectangular	√3	0.6	± 1.7	∞
Liquid permittivity (target)	± 5.0	Rectangular	√3	0.6	± 1.7	∞
Liquid permittivity (measured)	± 5.0	Rectangular	√3	0.6	± 1.7	∞
<b>Combined Standard Uncertainty</b>					<b>± 13.3</b>	
<b>Expanded Uncertainty (k=2)</b>					<b>± 26.6</b>	

Measurement Uncertainty Table in accordance with IEEE Std 1528-200X (Draft - see reference [3])

## MEASUREMENT UNCERTAINTIES (Cont.)

UNCERTAINTY BUDGET FOR SYSTEM VALIDATION						
Error Description	Uncertainty Value ±%	Probability Distribution	Divisor	$c_i$ 1g	Standard Uncertainty ±% (1g)	$v_i$ or $v_{eff}$
<b>Measurement System</b>						
Probe calibration	± 4.8	Normal	1	1	± 4.8	∞
Axial isotropy of the probe	± 4.7	Rectangular	√3	(1- $c_p$ )	± 1.9	∞
Spherical isotropy of the probe	± 9.6	Rectangular	√3	( $c_p$ )	± 3.9	∞
Spatial resolution	± 0.0	Rectangular	√3	1	± 0.0	∞
Boundary effects	± 5.5	Rectangular	√3	1	± 3.2	∞
Probe linearity	± 4.7	Rectangular	√3	1	± 2.7	∞
Detection limit	± 1.0	Rectangular	√3	1	± 0.6	∞
Readout electronics	± 1.0	Normal	1	1	± 1.0	∞
Response time	± 0.8	Rectangular	√3	1	± 0.5	∞
Integration time	± 1.4	Rectangular	√3	1	± 0.8	∞
RF ambient conditions	± 3.0	Rectangular	√3	1	± 1.7	∞
Mech. constraints of robot	± 0.4	Rectangular	√3	1	± 0.2	∞
Probe positioning	± 2.9	Rectangular	√3	1	± 1.7	∞
Extrapolation & integration	± 3.9	Rectangular	√3	1	± 2.3	∞
<b>Dipole</b>						
Dipole Axis to Liquid Distance	± 2.0	Rectangular	√3	1	± 1.2	∞
Input Power	± 4.7	Rectangular	√3	1	± 2.7	∞
<b>Phantom and Setup</b>						
Phantom uncertainty	± 4.0	Rectangular	√3	1	± 2.3	∞
Liquid conductivity (target)	± 5.0	Rectangular	√3	0.6	± 1.7	∞
Liquid conductivity (measured)	± 5.0	Rectangular	√3	0.6	± 1.7	∞
Liquid permittivity (target)	± 5.0	Rectangular	√3	0.6	± 1.7	∞
Liquid permittivity (measured)	± 5.0	Rectangular	√3	0.6	± 1.7	∞
<b>Combined Standard Uncertainty</b>					<b>± 9.9</b>	
<b>Expanded Uncertainty (k=2)</b>					<b>± 19.8</b>	

Measurement Uncertainty Table in accordance with IEEE Std 1528-200X (Draft - see reference [3])

## 16.0 REFERENCES

- [1] Federal Communications Commission, "Radiofrequency radiation exposure evaluation: portable devices", Rule Part 47 CFR §2.1093: 1999.
- [2] Health Canada, "Limits of Human Exposure to Radiofrequency Electromagnetic Fields in the Frequency Range from 3 kHz to 300 GHz", Safety Code 6.
- [3] Federal Communications Commission, "Evaluating Compliance with FCC Guidelines for Human Exposure to Radio frequency Electromagnetic Fields", OET Bulletin 65, Supplement C (Edition 01-01), FCC, Washington, D.C.: June 2001.
- [4] Industry Canada, "Evaluation Procedure for Mobile and Portable Radio Transmitters with respect to Health Canada's Safety Code 6 for Exposure of Humans to Radio Frequency Fields", Radio Standards Specification RSS-102 Issue 1 (Provisional): September 1999.
- [5] IEEE Standards Coordinating Committee 34, Std 1528-200X, "DRAFT Recommended Practice for Determining the Spatial-Peak Specific Absorption Rate (SAR) in the Human Body Due to Wireless Communications Devices: Experimental Techniques".
- [6] W. Gander, *Computermathematick*, Birkhaeuser, Basel: 1992.

## APPENDIX A - SAR MEASUREMENT DATA



# Itronix Corporation FCC ID: KBCIX260RIM902

SAM Phantom; Flat Section; Position: (90°, 0°)  
Probe: ET3DV6 - SN1387; ConvF(6.40,6.40,6.40); Crest factor: 4.0  
900 MHz Muscle:  $\sigma = 1.07 \text{ mho/m}$ ,  $\epsilon_r = 55.6$ ,  $\rho = 1.00 \text{ g/cm}^3$

Coarse: Dx = 15.0, Dy = 15.0, Dz = 10.0  
Cube 5x5x7

SAR (1g): 1.35 mW/g, SAR (10g): 0.808 mW/g

Body SAR - Back of LCD Display (Closed)  
Antenna Parallel to Planar Phantom (Stowed Position)  
0.0 cm Separation Distance from Back of LCD Display to Planar Phantom  
Itronix IX260 Rugged Laptop PC with RIM 902 Mobitex Radio Modem  
Modulated Carrier

Channel 721 [899.0 MHz]

Conducted Power: 33.1 dBm

Ambient Temp: 24.4°C; Fluid Temp: 23.6°C

Date Tested: June 11, 2003

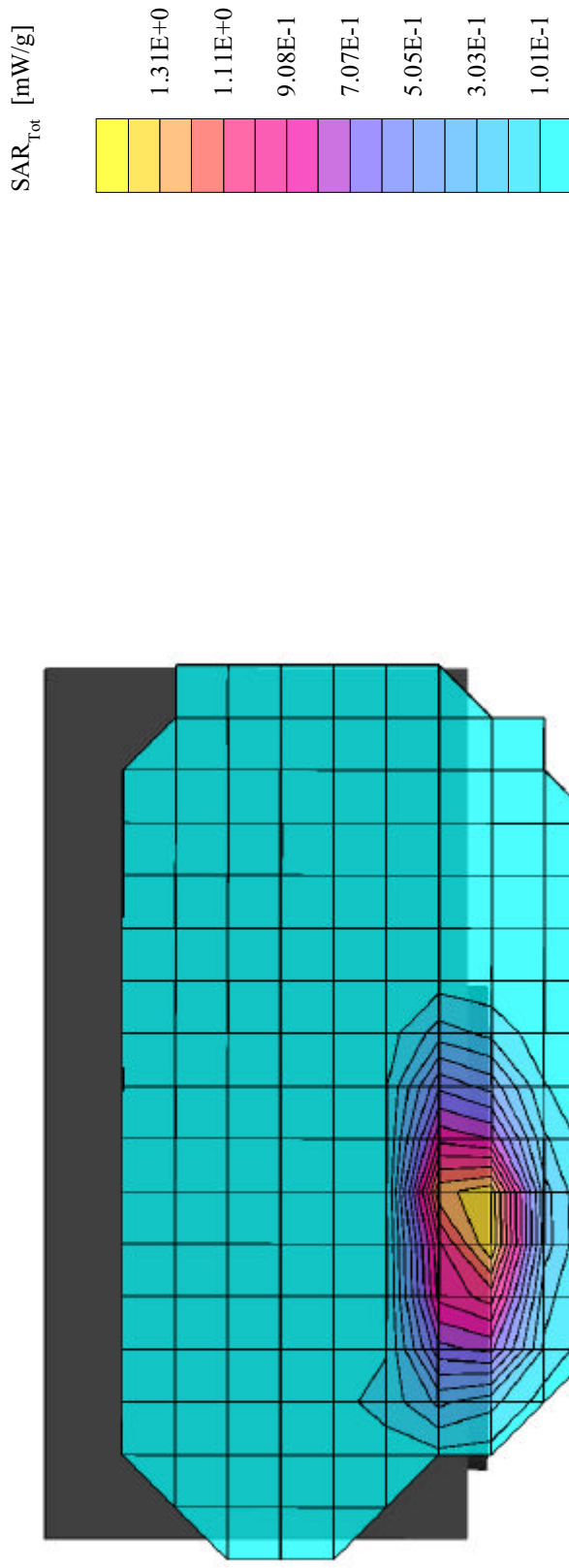

# Itronix Corporation FCC ID: KBCIX260RIM902

SAM Phantom; Flat Section

Probe: ET3DV6 - SN1387; ConvF(6.40,6.40,6.40); Crest factor: 4.0  
900 MHz Muscle:  $\sigma = 1.07$  mho/m  $\epsilon_r = 55.6$   $\rho = 1.00$  g/cm<sup>3</sup>

## Z-Axis Extrapolation at Peak SAR Location

Body SAR - Back of LCD Display (Closed)  
Antenna Parallel to Planar Phantom (Stowed Position)  
0.0 cm Separation Distance from Back of LCD Display to Planar Phantom  
Itronix IX260 Rugged Laptop PC with RIM 902 Mobitex Radio Modem  
Modulated Carrier

Channel 721 [899.0 MHz]

Conducted Power: 33.1 dBm

Ambient Temp: 24.4°C; Fluid Temp: 23.6°C

Date Tested: June 11, 2003

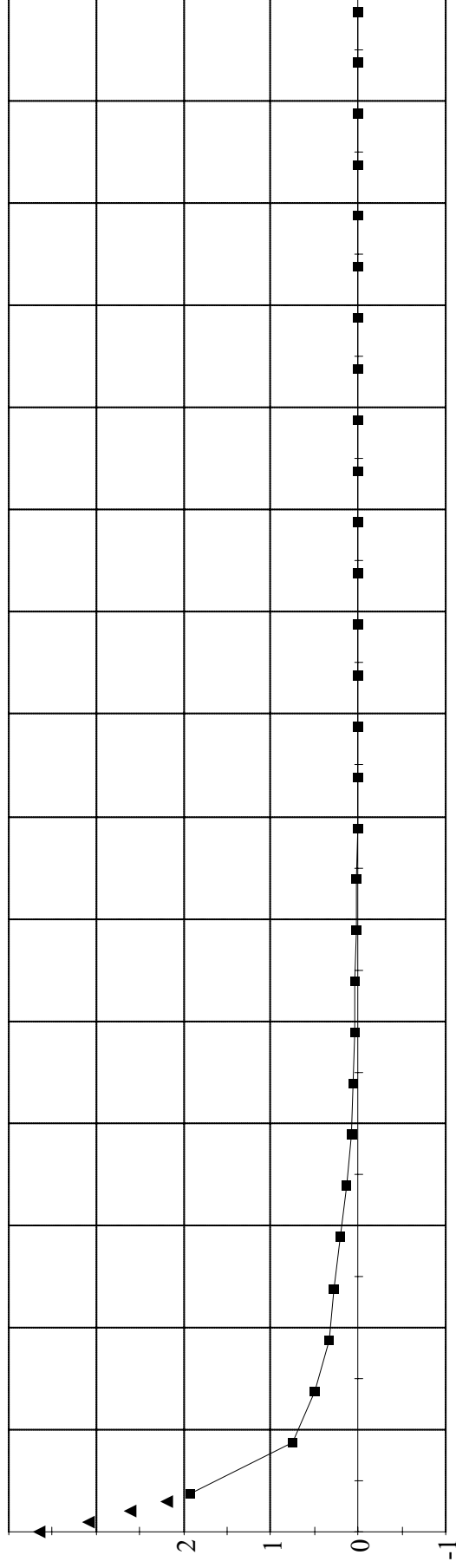

# Itronix Corporation FCC ID: KBCIX260RIM902

SAM Phantom; Flat Section; Position: (90°, 180°)  
Probe: ET3DV6 - SN1387; ConvF(6.40,6.40,6.40); Crest factor: 4.0  
900 MHz Muscle:  $\sigma = 1.07 \text{ mho/m}$ ,  $\epsilon_r = 55.6$ ,  $\rho = 1.00 \text{ g/cm}^3$   
Coarse: Dx = 15.0, Dy = 15.0, Dz = 10.0

Body SAR - Back of LCD Display (Closed)  
Antenna Parallel to Planar Phantom (Stowed Position)  
0.0 cm Separation Distance from Back of LCD Display to Planar Phantom  
Itronix IX260 Rugged Laptop PC with RIM 902 Mobitex Radio Modem  
Modulated Carrier  
Channel 721 [899.0 MHz]  
Conducted Power: 33.1 dBm  
Ambient Temp: 24.4°C; Fluid Temp: 23.6°C  
Date Tested: June 11, 2003

## Coarse scan to show Left Half of LCD Display (Back Side)

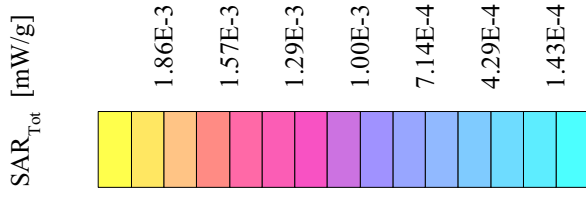
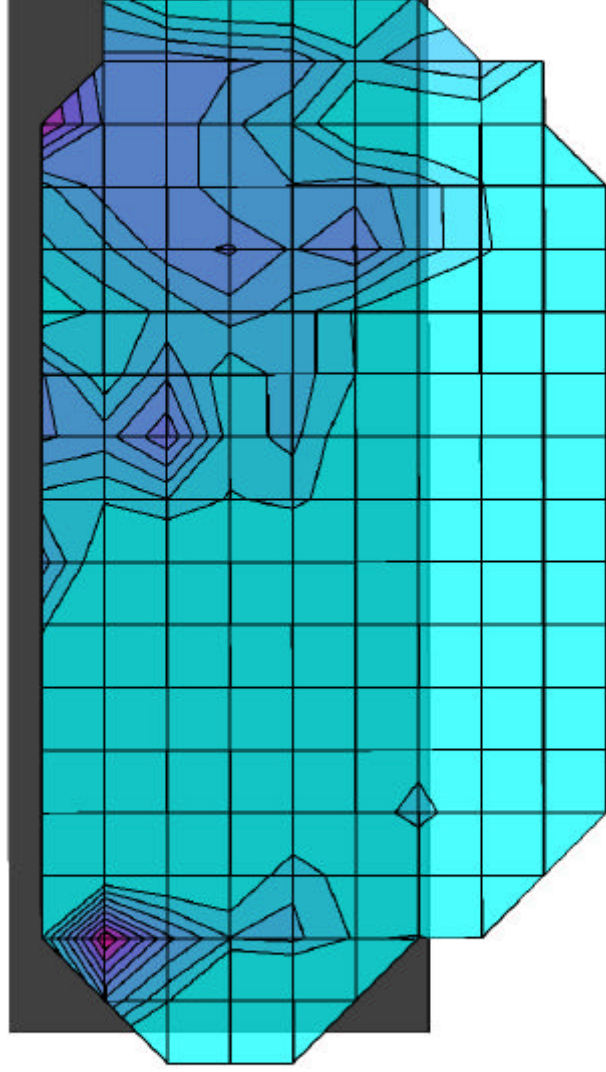

# Itronix Corporation FCC ID: KBCIX260RIM902

SAM Phantom; Flat Section; Position: (90°, 0°)  
Probe: ET3DV6 - SN1387; ConvF(6.40,6.40,6.40); Crest factor: 4.0  
900 MHz Muscle:  $\sigma = 1.07 \text{ mho/m}$ ,  $\epsilon_r = 55.6$ ,  $\rho = 1.00 \text{ g/cm}^3$

Coarse: Dx = 15.0, Dy = 15.0, Dz = 10.0  
Cube 5x5x7

SAR (1g): 0.0417 mW/g, SAR (10g): 0.0211 mW/g

Body SAR - Back of LCD Display (Closed)  
Antenna Perpendicular to Planar Phantom (180°)  
0.0 cm Separation Distance from Back of LCD Display to Planar Phantom  
Itronix IX260 Rugged Laptop PC with RIM 902 Mobitex Radio Modem  
Modulated Carrier

Channel 721 [899.0 MHz]

Conducted Power: 33.1 dBm

Ambient Temp: 24.4°C; Fluid Temp: 23.6°C

Date Tested: June 11, 2003

## Primary Hotspot Evaluation

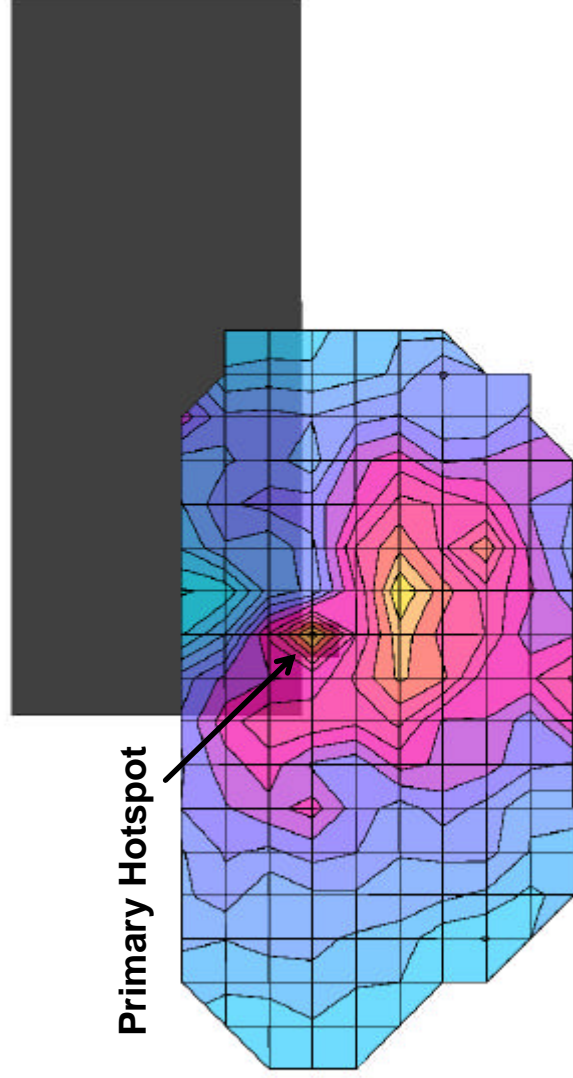

# Itronix Corporation FCC ID: KBCIX260RIM902

SAM Phantom; Flat Section; Position: (90°, 0°)  
Probe: ET3DV6 - SN1387; ConvF(6.40,6.40,6.40); Crest factor: 4.0  
900 MHz Muscle:  $\sigma = 1.07 \text{ mho/m}$ ,  $\epsilon_r = 55.6$ ,  $\rho = 1.00 \text{ g/cm}^3$

Coarse: Dx = 15.0, Dy = 15.0, Dz = 10.0  
Cube 5x5x7

SAR (1g): 0.0402 mW/g, SAR (10g): 0.0276 mW/g

Body SAR - Back of LCD Display (Closed)  
Antenna Perpendicular to Planar Phantom (180°)  
0.0 cm Separation Distance from Back of LCD Display to Planar Phantom  
Itronix IX260 Rugged Laptop PC with RIM 902 Mobitex Radio Modem  
Modulated Carrier

Channel 721 [899.0 MHz]

Conducted Power: 33.1 dBm

Ambient Temp: 24.4°C; Fluid Temp: 23.6°C

Date Tested: June 11, 2003

## Secondary Hotspot Evaluation

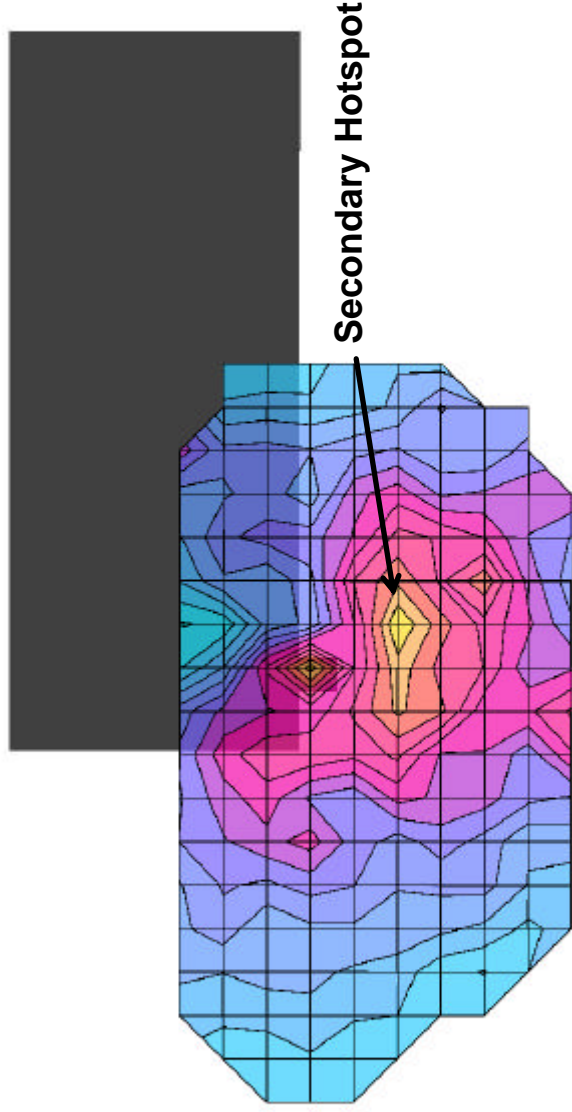

# Itronix Corporation FCC ID: KBCIX260RIM902

SAM Phantom; Flat Section; Position: (90°, 0°)  
Probe: ET3DV6 - SN1387; ConvF(6.40,6.40,6.40); Crest factor: 4.0  
900 MHz Muscle:  $\sigma = 1.07 \text{ mho/m}$ ,  $\epsilon_r = 55.6$ ,  $\rho = 1.00 \text{ g/cm}^3$   
Coarse: Dx = 15.0, Dy = 15.0, Dz = 10.0

Body SAR - Back of LCD Display (Closed)  
Antenna Perpendicular to Planar Phantom (180°)  
0.0 cm Separation Distance from Back of LCD Display to Planar Phantom  
Itronix IX260 Rugged Laptop PC with RIM 902 Mobitex Radio Modem  
Modulated Carrier  
Channel 721 [899.0 MHz]  
Conducted Power: 33.1 dBm  
Ambient Temp: 24.4°C; Fluid Temp: 23.6°C  
Date Tested: June 11, 2003

## Coarse scan to show Right Half of LCD Display (Front Side)

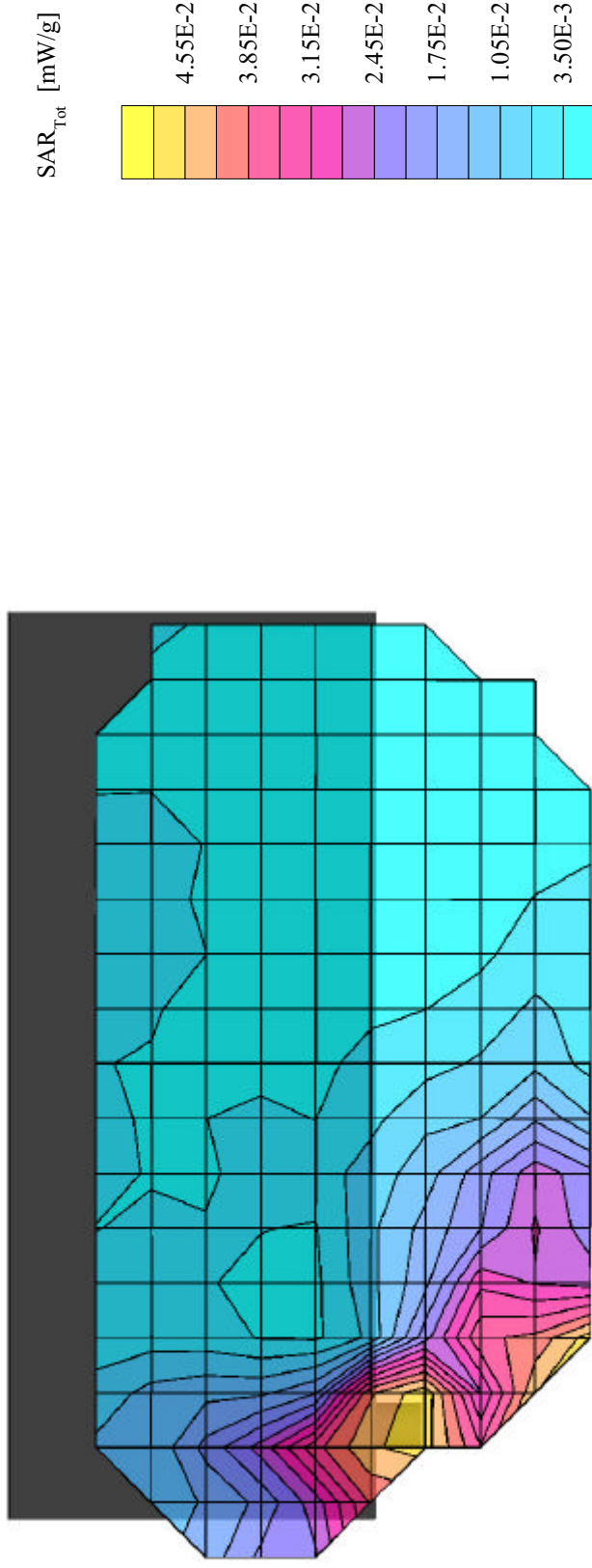

# Itronix Corporation FCC ID: KBCIX260RIM902

SAM Phantom; Flat Section; Position: (90°, 180°)  
Probe: ET3DV6 - SNI387; ConvF(6.40,6.40,6.40); Crest factor: 4.0  
900 MHz Muscle:  $\sigma = 1.07 \text{ mho/m}$ ,  $\epsilon_r = 55.9$ ,  $\rho = 1.00 \text{ g/cm}^3$   
Coarse: Dx = 15.0, Dy = 15.0, Dz = 10.0

Body SAR - Back of LCD Display (Closed)  
Antenna Perpendicular to Planar Phantom (180°)  
0.0 cm Separation Distance from Back of LCD Display to Planar Phantom  
Itronix IX260 Rugged Laptop PC with RIM 902 Mobitex Radio Modem  
Modulated Carrier

Channel 721 [899.0 MHz]  
Conducted Power: 33.1 dBm  
Ambient Temp: 24.4°C; Fluid Temp: 23.6°C  
Date Tested: June 11, 2003

## Coarse scan to show Left Half of LCD Display (Back Side)

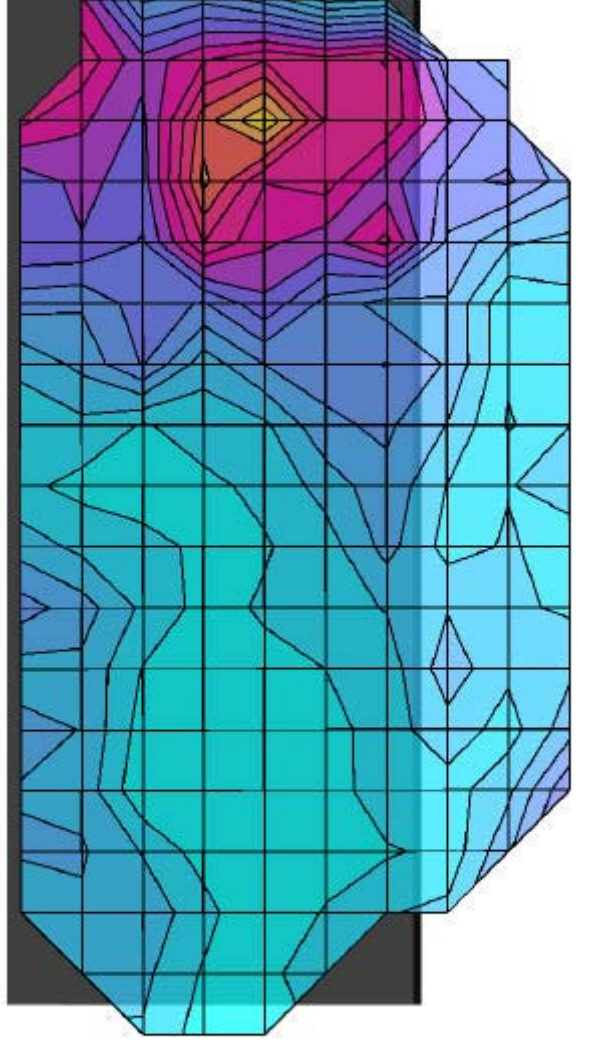

# Itronix Corporation FCC ID: KBCIX260RIM902

SAM Phantom; Flat Section; Position: (270°, 180°)  
Probe: ET3DV6 - SN1387; ConvF(6.40,6.40,6.40); Crest factor: 4.0  
900 MHz Muscle:  $\sigma = 1.07 \text{ mho/m}$ ,  $\epsilon_r = 55.6$ ,  $\rho = 1.00 \text{ g/cm}^3$

Coarse: Dx = 15.0, Dy = 15.0, Dz = 10.0  
Cube 5x5x7

SAR (1g): 0.0341 mW/g, SAR (10g): 0.0224 mW/g

Body SAR - Bottom of Laptop PC (LCD Display Closed)  
Antenna Parallel to Planar Phantom (Stowed Position)  
0.0 cm Separation Distance from Bottom of Laptop PC to Planar Phantom  
Itronix IX260 Rugged Laptop PC with RIM 902 Mobitex Radio Modem  
Modulated Carrier

Channel 721 [899.0 MHz]  
Conducted Power: 33.1 dBm  
Ambient Temp: 24.4°C; Fluid Temp: 23.6°C  
Date Tested: June 11, 2003

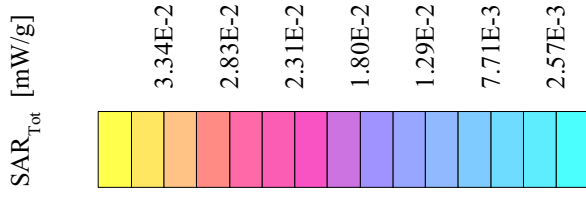
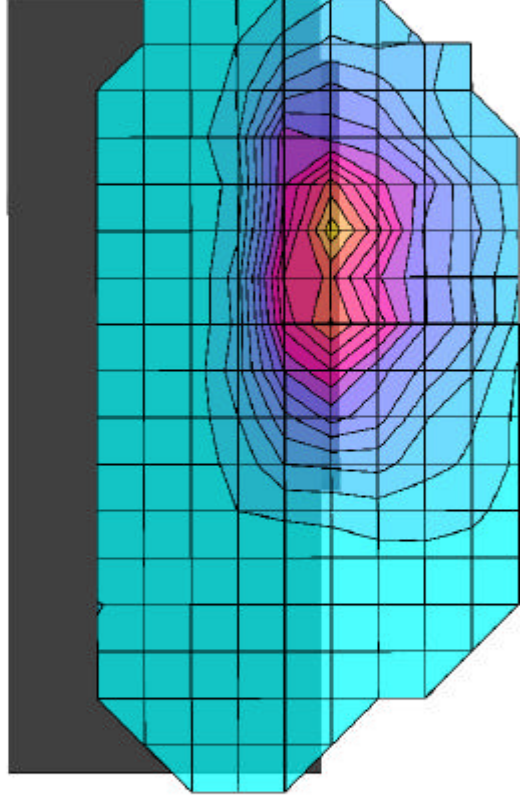



# Itronix Corporation FCC ID: KBCIX260RIM902

SAM Phantom; Flat Section; Position: (270°, 0°)  
Probe: ET3DV6 - SN1387; ConvF(6.40,6.40,6.40); Crest factor: 4.0  
900 MHz Muscle:  $\sigma = 1.07 \text{ mho/m}$ ,  $\epsilon_r = 55.6$ ,  $\rho = 1.00 \text{ g/cm}^3$   
Coarse: Dx = 15.0, Dy = 15.0, Dz = 10.0

Body SAR - Bottom of Laptop PC (LCD Display Closed)  
Antenna Parallel to Planar Phantom (Stowed Position)  
0.0 cm Separation Distance from Bottom of Laptop PC to Planar Phantom  
Itronix IX260 Rugged Laptop PC with RIM 902 Mobitex Radio Modem  
Modulated Carrier  
Channel 721 [899.0 MHz]  
Conducted Power: 33.1 dBm  
Ambient Temp: 24.4°C; Fluid Temp: 23.6°C  
Date Tested: June 11, 2003

## Coarse scan to show Left Half of Bottom Side

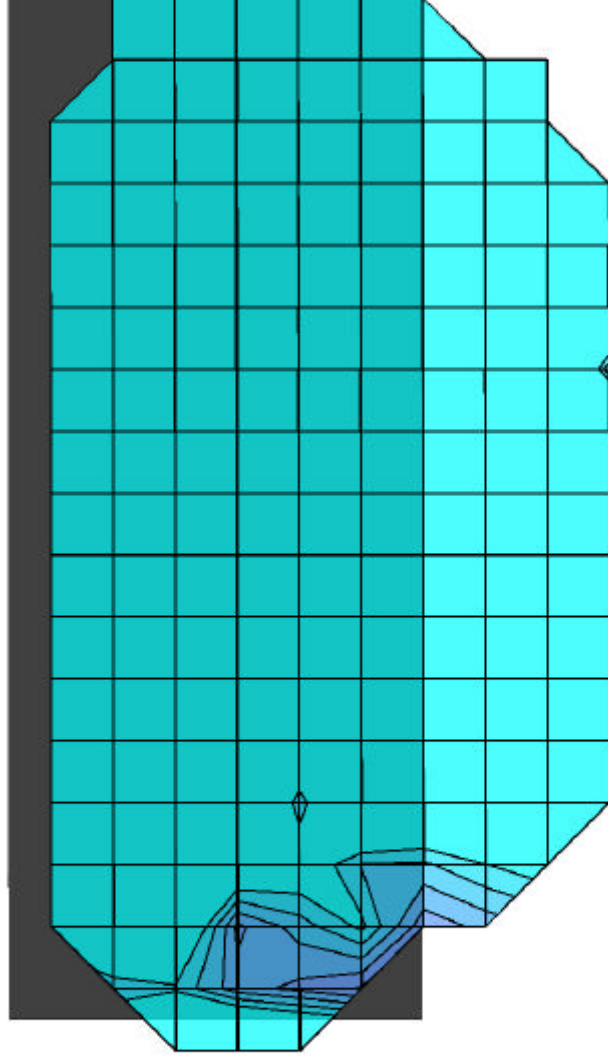

# Itronix Corporation FCC ID: KBCIX260RIM902

SAM Phantom; Flat Section; Position: (270°, 180°)  
Probe: ET3DV6 - SN1387; ConvF(6.40,6.40,6.40); Crest factor: 4.0  
900 MHz Muscle:  $\sigma = 1.07 \text{ mho/m}$ ,  $\epsilon_r = 55.6$ ,  $\rho = 1.00 \text{ g/cm}^3$

Coarse: Dx = 15.0, Dy = 15.0, Dz = 10.0  
Cube 5x5x7

SAR (1g): 0.0425 mW/g, SAR (10g): 0.0251 mW/g

Body SAR - Bottom of Laptop PC (LCD Display Closed)  
Antenna Perpendicular to Planar Phantom (180°)  
0.0 cm Separation Distance from Bottom of Laptop PC to Planar Phantom  
Itronix IX260 Rugged Laptop PC with RIM 902 Mobitex Radio Modem  
Modulated Carrier

Channel 721 [899.0 MHz]

Conducted Power: 33.1 dBm

Ambient Temp: 24.4°C; Fluid Temp: 23.6°C

Date Tested: June 11, 2003

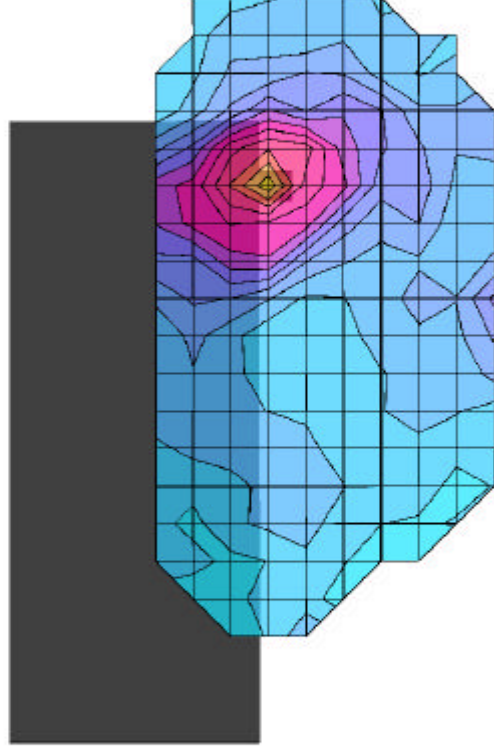

SAR<sub>Tot</sub> [mW/g]

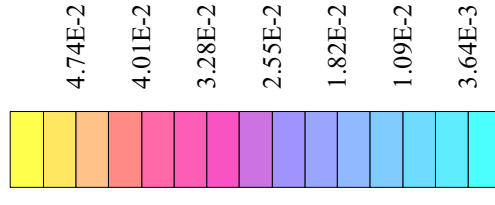

# Itronix Corporation FCC ID: KBCIX260RIM902

SAM Phantom; Flat Section; Position: (270°, 180°)  
Probe: ET3DV6 - SN1387; ConvF(6.40,6.40,6.40); Crest factor: 4.0  
900 MHz Muscle:  $\sigma = 1.07 \text{ mho/m}$ ,  $\epsilon_r = 55.6$ ,  $\rho = 1.00 \text{ g/cm}^3$   
Coarse: Dx = 15.0, Dy = 15.0, Dz = 10.0

Body SAR - Bottom of Laptop PC (LCD Display Closed)  
Antenna Perpendicular to Planar Phantom (180°)  
0.0 cm Separation Distance from Bottom of Laptop PC to Planar Phantom  
Itronix IX260 Rugged Laptop PC with RIM 902 Mobitex Radio Modem  
Modulated Carrier  
Channel 721 [899.0 MHz]  
Conducted Power: 33.1 dBm  
Ambient Temp: 24.4°C; Fluid Temp: 23.6°C  
Date Tested: June 11, 2003

## Coarse scan to show Right Half of Bottom Side

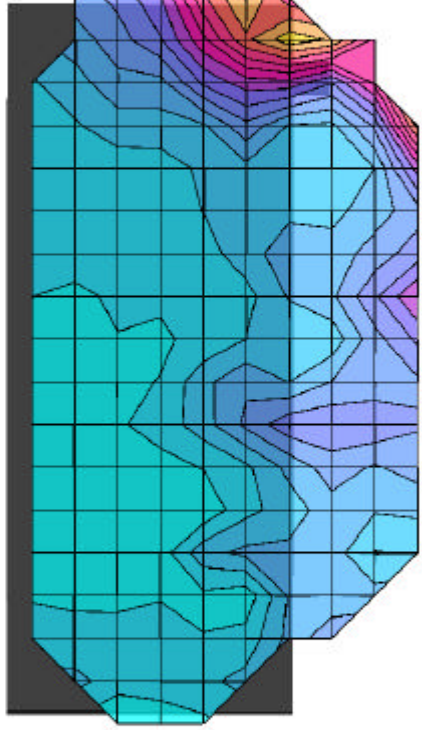
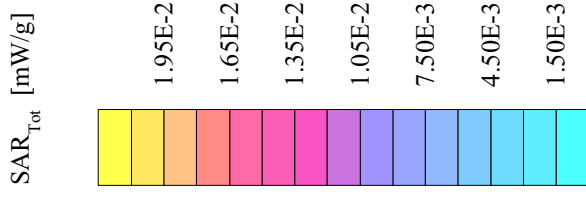

# Itronix Corporation FCC ID: KBCIX260RIM902

SAM Phantom; Flat Section; Position: (270°, 0°)  
Probe: ET3DV6 - SN1387; ConvF(6.40,6.40,6.40); Crest factor: 4.0  
900 MHz Muscle:  $\sigma = 1.07 \text{ mho/m}$ ,  $\epsilon_r = 55.6$ ,  $\rho = 1.00 \text{ g/cm}^3$   
Coarse: Dx = 15.0, Dy = 15.0, Dz = 10.0

Body SAR - Bottom of Laptop PC (LCD Display Closed)  
Antenna Perpendicular to Planar Phantom (180°)  
0.0 cm Separation Distance from Bottom of Laptop PC to Planar Phantom  
Itronix IX260 Rugged Laptop PC with RIM 902 Mobitex Radio Modem  
Modulated Carrier  
Channel 721 [899.0 MHz]  
Conducted Power: 33.1 dBm  
Ambient Temp: 24.4°C; Fluid Temp: 23.6°C  
Date Tested: June 11, 2003

## Coarse scan to show Left Half of Bottom Side

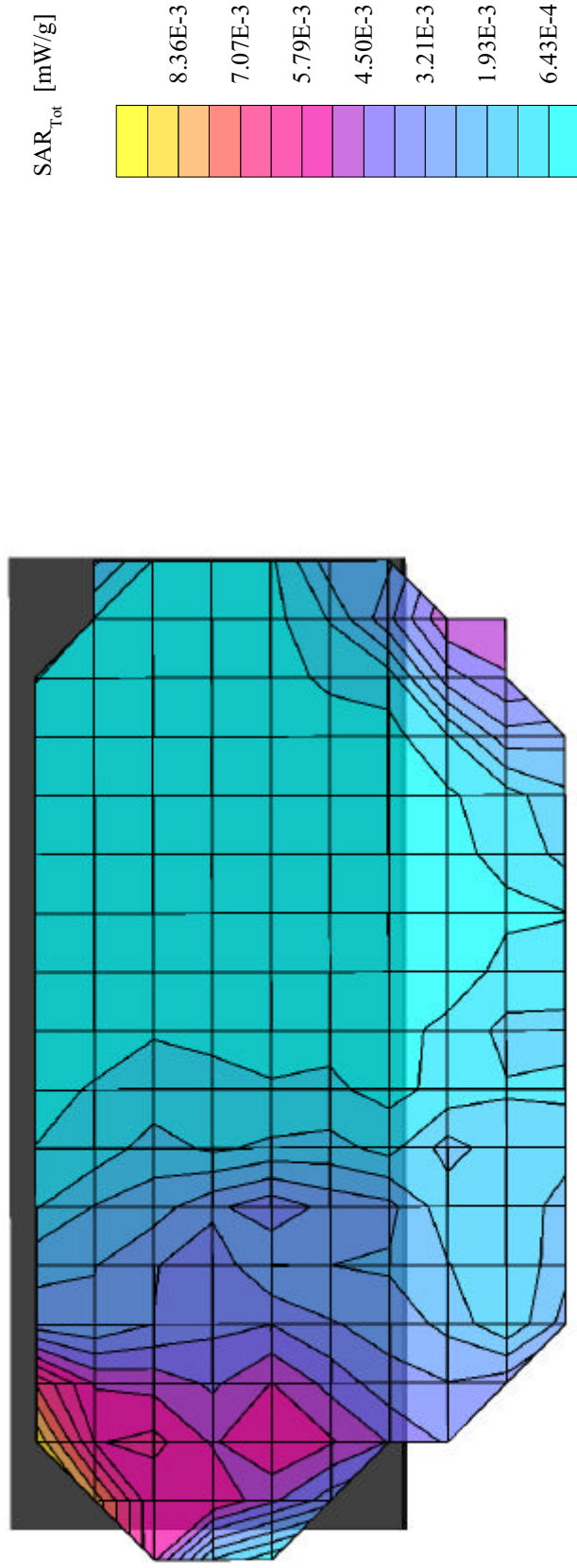

# Itronix Corporation FCC ID: KBCIX260RIM902

SAM Phantom; Flat Section; Position: (180°, 180°)  
Probe: ET3DV6 - SN1387; ConvF(6.40,6.40,6.40); Crest factor: 4.0  
900 MHz Muscle:  $\sigma = 1.07 \text{ mho/m}$ ,  $\epsilon_r = 55.9$ ,  $\rho = 1.00 \text{ g/cm}^3$   
Coarse: Dx = 15.0, Dy = 15.0, Dz = 10.0  
Cube 5x5x7

SAR (1g): 0.377 mW/g, SAR (10g): 0.247 mW/g

Body SAR - Right Side of Laptop PC (LCD Display Closed) - Antenna Stowed  
1.5 cm Separation Distance from Antenna to Planar Phantom  
Itronix IX260 Rugged Laptop PC with RIM 902 Mobitex Radio Modem  
Modulated Carrier

Channel 721 [899.0 MHz]

Conducted Power: 33.1 dBm

Ambient Temp: 24.4°C; Fluid Temp: 23.6°C

Date Tested: June 11, 2003

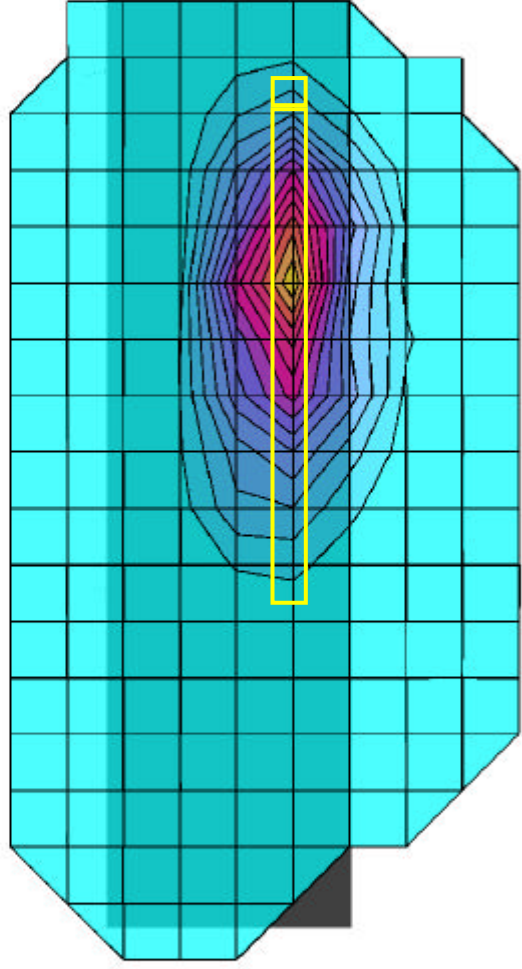

SAR<sub>Tot</sub> [mW/g]

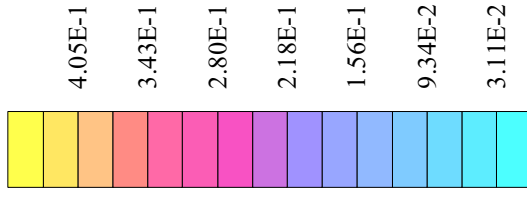

# Itronix Corporation FCC ID: KBCIX260RIM902

SAM Phantom; Flat Section; Position: (270°, 180°)  
Probe: ET3DV6 - SN1387; ConvF(6.40,6.40,6.40); Crest factor: 4.0  
900 MHz Muscle:  $\sigma = 1.07 \text{ mho/m}$ ,  $\epsilon_r = 55.9$ ,  $\rho = 1.00 \text{ g/cm}^3$

Coarse: Dx = 15.0, Dy = 15.0, Dz = 10.0  
Cube 5x5x7

SAR (1g): 0.918 mW/g, SAR (10g): 0.588 mW/g

Body SAR - Right Side of Laptop PC (LCD Display Closed) - Antenna Extended  
1.5 cm Separation Distance from Antenna to Planar Phantom  
Itronix IX260 Rugged Laptop PC with RIM 902 Mobitex Radio Modem  
Modulated Carrier

Channel 721 [899.0 MHz]

Conducted Power: 33.1 dBm

Ambient Temp: 24.4°C; Fluid Temp: 23.6°C

Date Tested: June 11, 2003

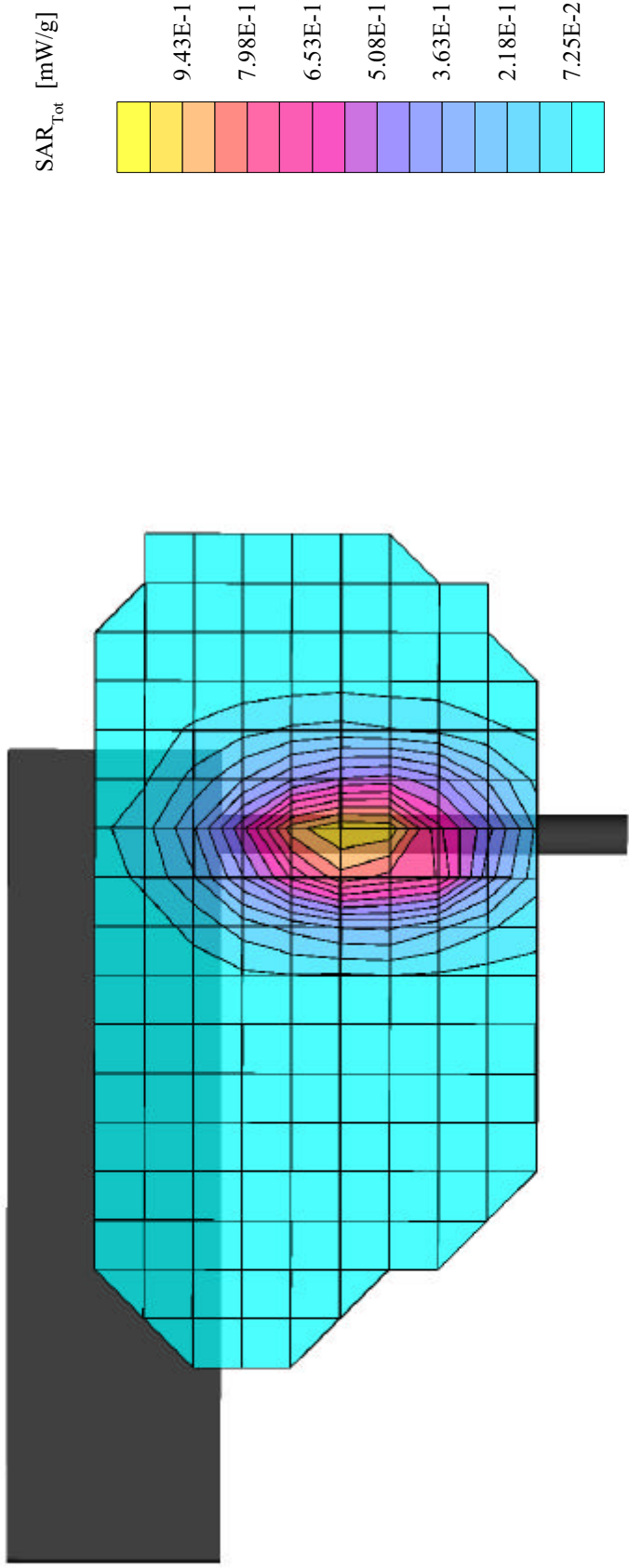

# Itronix Corporation FCC ID: KBCIX260RIM902

SAM Phantom; Flat Section; Position: (270°, 180°)  
Probe: ET3DV6 - SN1387; ConvF(6.40,6.40,6.40); Crest factor: 4.0  
900 MHz Muscle:  $\sigma = 1.07 \text{ mho/m}$ ,  $\epsilon_r = 55.9$ ,  $\rho = 1.00 \text{ g/cm}^3$   
Coarse: Dx = 15.0, Dy = 15.0, Dz = 10.0

Body SAR - Right Side of Laptop PC (LCD Display Closed) - Antenna Extended  
1.5 cm Separation Distance from Antenna to Planar Phantom  
Itronix IX260 Rugged Laptop PC with RIM 902 Mobitex Radio Modem  
Modulated Carrier

Channel 721 [899.0 MHz]  
Conducted Power: 33.1 dBm  
Ambient Temp: 24.4°C; Fluid Temp: 23.6°C  
Date Tested: June 11, 2003

## Coarse scan to show Right Side of Laptop PC

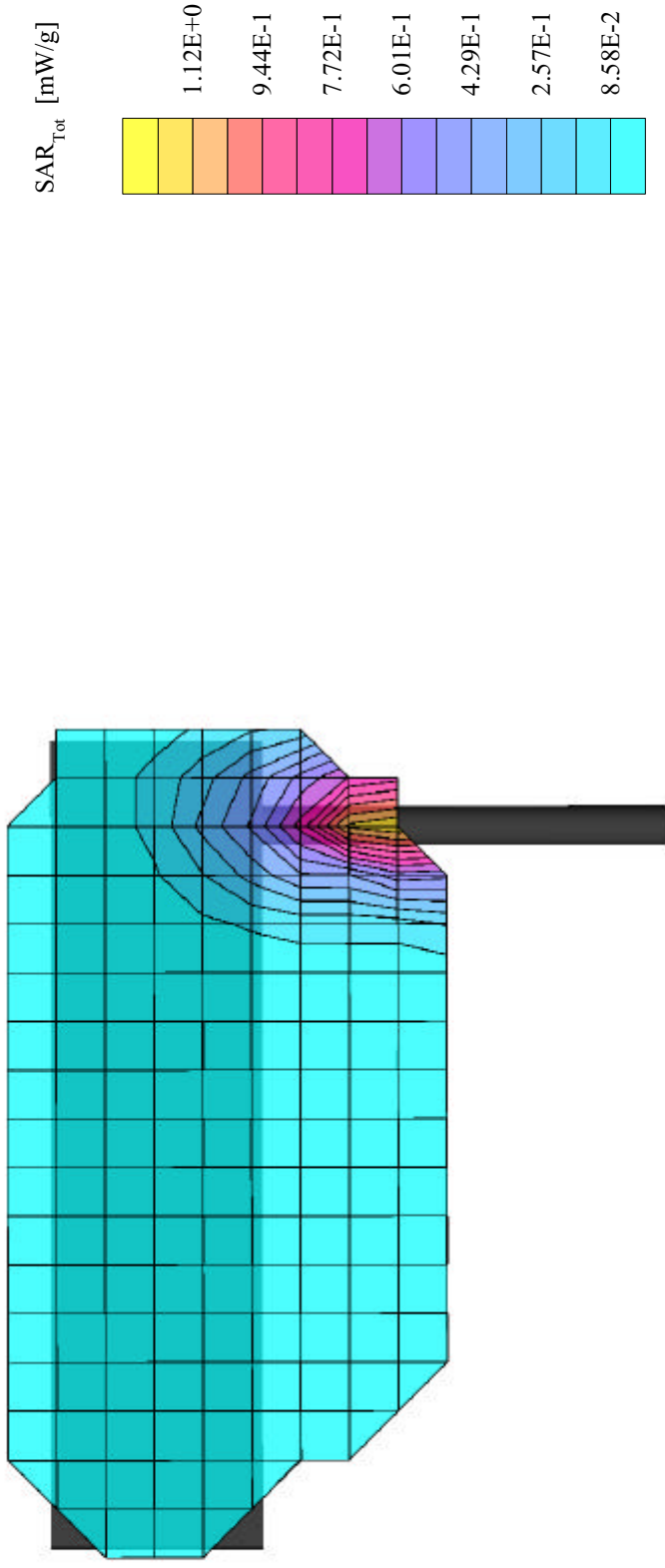

## APPENDIX B - SYSTEM PERFORMANCE CHECK DATA



# System Performance Check - 900MHz Dipole

SAM Phantom; Flat Section

Probe: ET3DV6 - SN1387; ConvF(6.60,6.60,6.60); Crest factor: 1.0; 900MHz Brain:  $\sigma = 0.99$  mho/m  $\epsilon_r = 42.0$   $\rho = 1.00$  g/cm<sup>3</sup>

Cube 5x5x7: Peak: 3.99 mW/g, SAR (1g): 2.61 mW/g, SAR (10g): 1.67 mW/g, (Worst-case extrapolation)

Penetration depth: 12.1 (11.7, 12.7) [mm]; Powerdrift: 0.01 dB

Ambient Temp: 24.4°C; Fluid Temp: 23.5°C

Conducted Power: 250mW

Date Tested: June 11, 2003

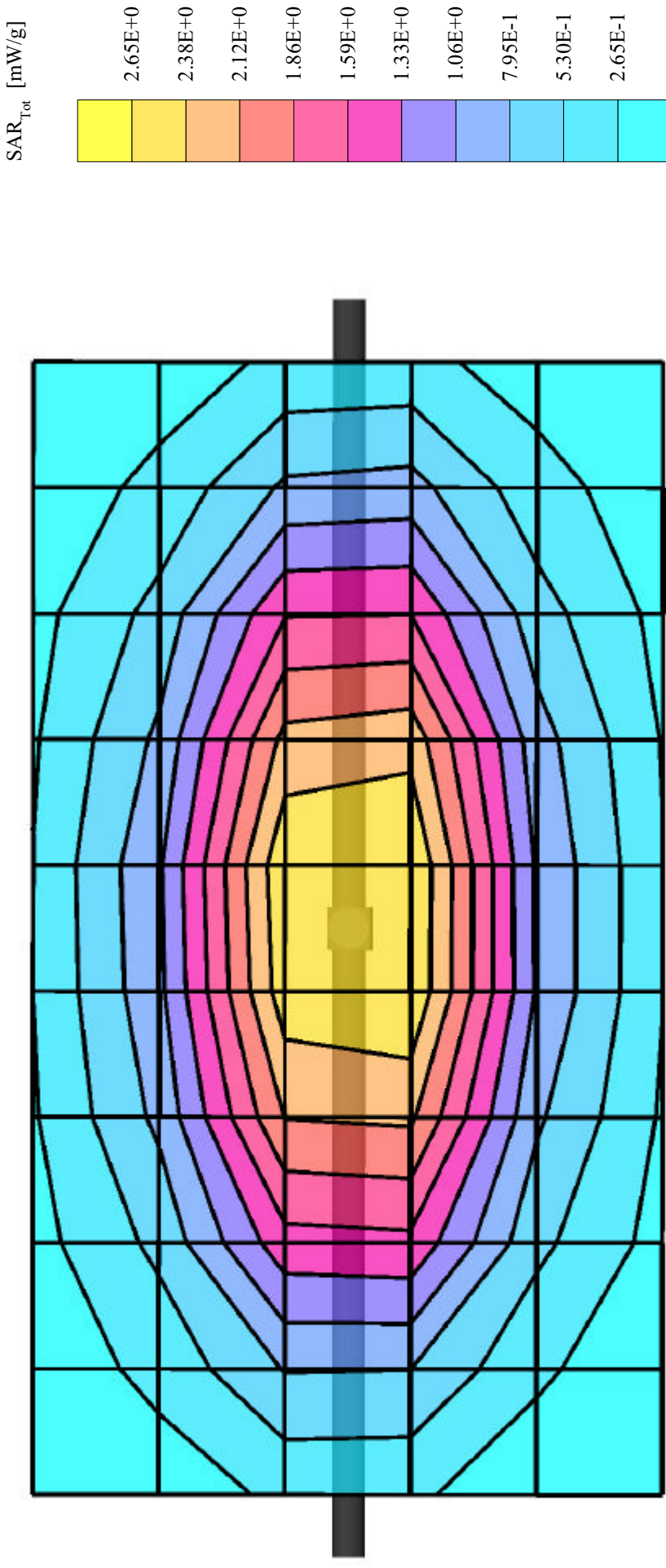

## APPENDIX C - SYSTEM VALIDATION

**Client**

**Celltech Labs**

**CALIBRATION CERTIFICATE**



**Object(s)** **D900V2 - SN:054**  
**Calibration procedure(s)** **QA CAL-05 v2**  
**Calibration procedure for dipole validation kits**  
**Calibration date:** **June 3, 2003**  
**Condition of the calibrated item** **In Tolerance (according to the specific calibration document)**

This calibration statement documents traceability of M&TE used in the calibration procedures and conformity of the procedures with the ISO/IEC 17025 international standard.

All calibrations have been conducted in the closed laboratory facility: environment temperature 22 +/- 2 degrees Celsius and humidity < 75%.

**Calibration Equipment used (M&TE critical for calibration)**

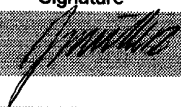
Model Type	ID #	Cal Date (Calibrated by, Certificate No.)	Scheduled Calibration
RF generator R&S SML-03	100698	27-Mar-2002 (R&S, No. 20-92389)	In house check: Mar-05
Power sensor HP 8481A	MY41092317	18-Oct-02 (Agilent, No. 20021018)	Oct-04
Power sensor HP 8481A	US37292783	30-Oct-02 (METAS, No. 252-0236)	Oct-03
Power meter EPM E442	GB37480704	30-Oct-02 (METAS, No. 252-0236)	Oct-03
Network Analyzer HP 8753E	US37390585	18-Oct-01 (Agilent, No. 24BR1033101)	In house check: Oct 03

	Name	Function	Signature
Calibrated by:	Judith Mueller	Technician	
Approved by:	Katja Pokovic	Laboratory Director	

Date issued: June 3, 2003

This calibration certificate is issued as an intermediate solution until the accreditation process (based on ISO/IEC 17025 International Standard) for Calibration Laboratory of Schmid & Partner Engineering AG is completed.

# DASY

## Dipole Validation Kit

Type: D900V2

Serial: 054

Manufactured: August 25, 1999

Calibrated: June 3, 2003

## 1. Measurement Conditions

The measurements were performed in the flat section of the SAM twin phantom filled with head simulating solution of the following electrical parameters at 900 MHz:

Relative Dielectricity	<b>42.1</b>	$\pm 5\%$
Conductivity	<b>0.95 mho/m</b>	$\pm 5\%$

The DASY4 System with a dosimetric E-field probe ET3DV6 (SN:1507, Conversion factor 6.6 at 900 MHz) was used for the measurements.

The dipole was mounted on the small tripod so that the dipole feedpoint was positioned below the center marking of the flat phantom section and the dipole was oriented parallel to the body axis (the long side of the phantom). The standard measuring distance was 15mm from dipole center to the solution surface. The included distance holder was used during measurements for accurate distance positioning.

The coarse grid with a grid spacing of 15mm was aligned with the dipole. The 7x7x7 fine cube was chosen for cube integration.

The dipole input power (forward power) was 250 mW  $\pm 3\%$ . The results are normalized to 1W input power.

## 2. SAR Measurement with DASY4 System

Standard SAR-measurements were performed according to the measurement conditions described in section 1. The results (see figure supplied) have been normalized to a dipole input power of 1W (forward power). The resulting averaged SAR-values measured with the dosimetric probe ET3DV6 SN:1507 and applying the advanced extrapolation are:

averaged over 1 cm <sup>3</sup> (1 g) of tissue:	<b>10.6 mW/g <math>\pm 16.8\%</math> (k=2)<sup>1</sup></b>
averaged over 10 cm <sup>3</sup> (10 g) of tissue:	<b>6.84 mW/g <math>\pm 16.2\%</math> (k=2)<sup>1</sup></b>

---

<sup>1</sup> validation uncertainty

### 3. Dipole Impedance and Return Loss

The impedance was measured at the SMA-connector with a network analyzer and numerically transformed to the dipole feedpoint. The transformation parameters from the SMA-connector to the dipole feedpoint are:

Electrical delay:	<b>1.397 ns</b>	(one direction)
Transmission factor:	<b>0.991</b>	(voltage transmission, one direction)

The dipole was positioned at the flat phantom sections according to section 1 and the distance holder was in place during impedance measurements.

Feedpoint impedance at 900 MHz:	$\text{Re}\{Z\} = 49.9 \Omega$
	$\text{Im}\{Z\} = -2.0 \Omega$
Return Loss at 900 MHz	<b>-33.9 dB</b>

### 4. Handling

Do not apply excessive force to the dipole arms, because they might bend. Bending of the dipole arms stresses the soldered connections near the feedpoint leading to a damage of the dipole.

### 5. Design

The dipole is made of standard semirigid coaxial cable. The center conductor of the feeding line is directly connected to the second arm of the dipole. The antenna is therefore short-circuited for DC-signals.

### 6. Power Test

After long term use with 100W radiated power, only a slight warming of the dipole near the feedpoint can be measured.

Date/Time: 06/03/03 12:00:32

Test Laboratory: SPEAG, Zurich, Switzerland  
 File Name: SN054\_SN1507\_HSL900\_030603.da4

**DUT: Dipole 900 MHz; Type: D900V2; Serial: D900V2 - SN054**  
**Program: Dipole Calibration**

Communication System: CW-900; Frequency: 900 MHz; Duty Cycle: 1:1  
 Medium: HSL 900 MHz ( $\sigma = 0.95$  mho/m,  $\epsilon_r = 42.07$ ,  $\rho = 1000$  kg/m<sup>3</sup>)

Phantom section: Flat Section

Measurement Standard: DASYS4 (High Precision Assessment)

DASY4 Configuration:

- Probe: ET3DV6 - SN1507; ConvF(6.6, 6.6, 6.6); Calibrated: 1/18/2003
- Sensor-Surface: 4mm (Mechanical Surface Detection)
- Electronics: DAE3 - SN411; Calibrated: 1/16/2003
- Phantom: SAM with CRP - TP1006; Type: SAM 4.0; Serial: TP:1006
- Measurement SW: DASYS4, V4.1 Build 47; Postprocessing SW: SEMCAD, V1.6 Build 115

**Pin = 250 mW; d = 15 mm/Area Scan (81x81x1):** Measurement grid: dx=15mm, dy=15mm

Reference Value = 56.9 V/m

Power Drift = 0.0004 dB

Maximum value of SAR = 2.84 mW/g

**Pin = 250 mW; d = 15 mm/Zoom Scan (7x7x7)/Cube 0:** Measurement grid: dx=5mm, dy=5mm, dz=5mm

Peak SAR (extrapolated) = 3.92 W/kg

SAR(1 g) = 2.66 mW/g; SAR(10 g) = 1.71 mW/g

Reference Value = 56.9 V/m

Power Drift = 0.0004 dB

Maximum value of SAR = 2.85 mW/g

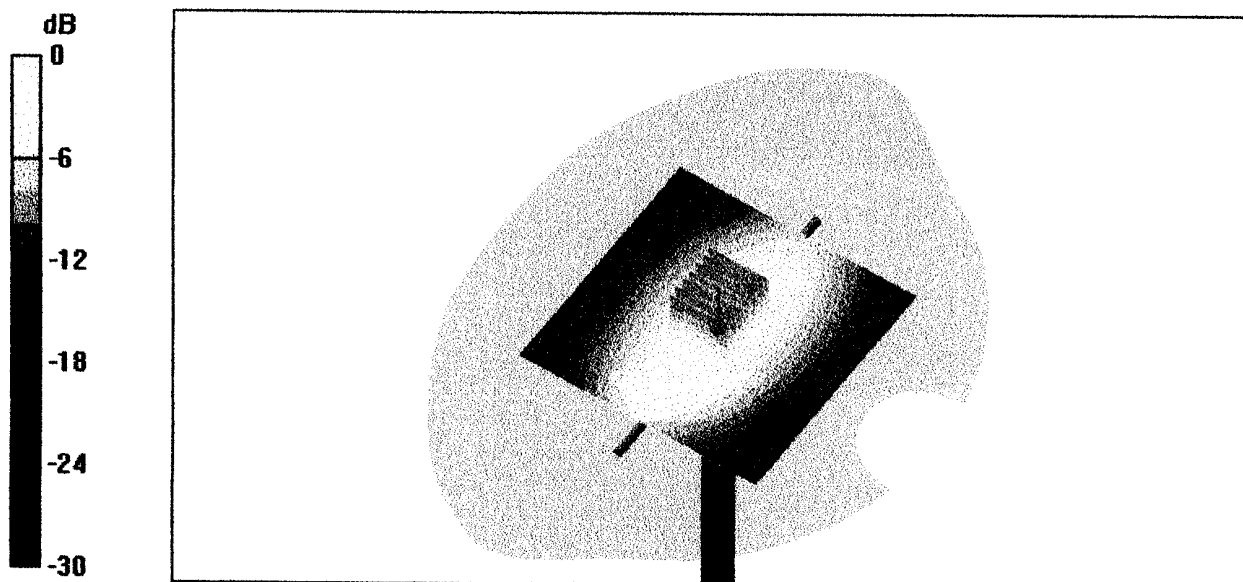

0 dB = 2.85mW/g

3 Jun 2003 09:29:44

CH1 S11 1 U FS 1: 49.906  $\Omega$  -2.0137  $\Omega$  87.819 pF 900.000 000 MHz

De1  
PRm  
Cor  
Avg  
16  
↑

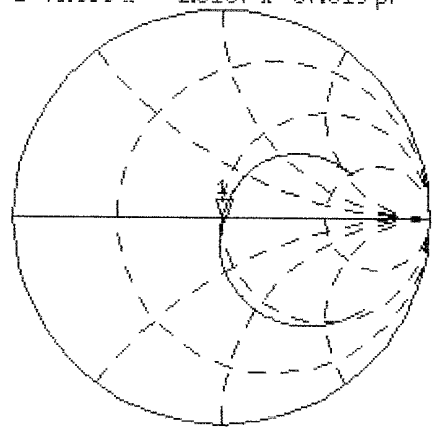

CH2 S11 LOG 5 dB/REF -20 dB 1: -33.939 dB 900.000 000 MHz

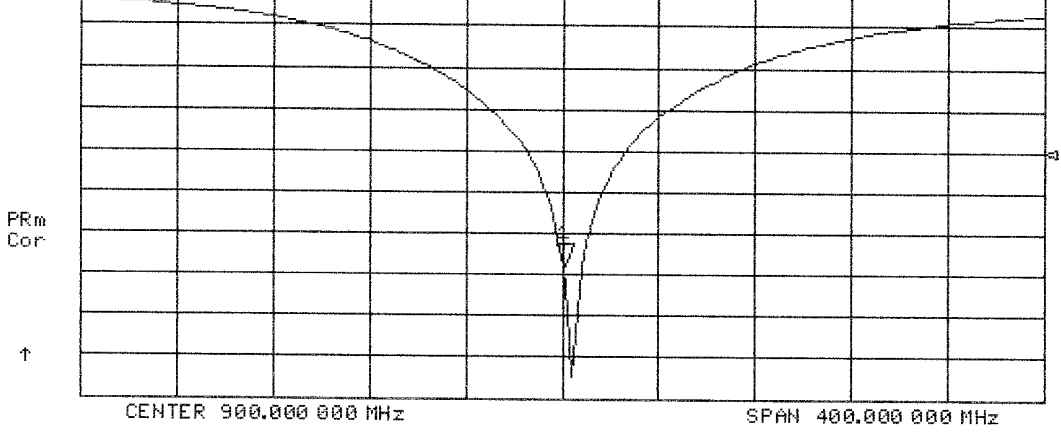

PRm  
Cor  
↑



## APPENDIX D - PROBE CALIBRATION

Client **Celltech Labs**

**CALIBRATION CERTIFICATE**

Object(s) **ET3DV6 - SN: 1387**

Calibration procedure(s) **QA CAL-01.v2  
 Calibration procedure for dosimetric E-field probes**

Calibration date: **February 26, 2003**



Condition of the calibrated item **In Tolerance (according to the specific calibration document)**

This calibration statement documents traceability of M&TE used in the calibration procedures and conformity of the procedures with the ISO/IEC 17025 international standard.

All calibrations have been conducted in the closed laboratory facility: environment temperature 22 +/- 2 degrees Celsius and humidity < 75%.

Calibration Equipment used (M&TE critical for calibration)

Model Type	ID #	Cal Date	Scheduled Calibration
RF generator HP 8684C	US3642U01700	4-Aug-99 (in house check Aug-02)	In house check: Aug-05
Power sensor E4412A	MY41495277	8-Mar-02	Mar-03
Power sensor HP 8481A	MY41092180	18-Sep-02	Sep-03
Power meter EPM E4419B	GB41293874	13-Sep-02	Sep-03
Network Analyzer HP 8753E	US38432426	3-May-00	In house check: May 03
Fluke Process Calibrator Type 702	SN: 6295803	3-Sep-01	Sep-03

	Name	Function	Signature
Calibrated by:	Nico Vetterli	Technician	
Approved by:	Katja Pokovic	Laboratory Director	

Date issued: February 26, 2003

This calibration certificate is issued as an intermediate solution until the accreditation process (based on ISO/IEC 17025 International Standard) for Calibration Laboratory of Schmid & Partner Engineering AG is completed.

# Probe ET3DV6

## SN:1387

Manufactured:	September 21, 1999
Last calibration:	February 22, 2002
Recalibrated:	February 26, 2003

**Calibrated for DASYS Systems**

(Note: non-compatible with DASYS2 system!)

## DASY - Parameters of Probe: ET3DV6 SN:1387

### Sensitivity in Free Space

NormX	<b>1.55</b> $\mu\text{V}/(\text{V}/\text{m})^2$
NormY	<b>1.65</b> $\mu\text{V}/(\text{V}/\text{m})^2$
NormZ	<b>1.64</b> $\mu\text{V}/(\text{V}/\text{m})^2$

### Diode Compression

DCP X	<b>92</b>	mV
DCP Y	<b>92</b>	mV
DCP Z	<b>92</b>	mV

### Sensitivity in Tissue Simulating Liquid

<b>Head</b>	<b>900 MHz</b>	$\epsilon_r = 41.5 \pm 5\%$	$\sigma = 0.97 \pm 5\%$ mho/m
<b>Head</b>	<b>835 MHz</b>	$\epsilon_r = 41.5 \pm 5\%$	$\sigma = 0.90 \pm 5\%$ mho/m
ConvF X	<b>6.6</b> $\pm 9.5\%$ (k=2)	Boundary effect:	
ConvF Y	<b>6.6</b> $\pm 9.5\%$ (k=2)	Alpha	<b>0.37</b>
ConvF Z	<b>6.6</b> $\pm 9.5\%$ (k=2)	Depth	<b>2.61</b>
<b>Head</b>	<b>1800 MHz</b>	$\epsilon_r = 40.0 \pm 5\%$	$\sigma = 1.40 \pm 5\%$ mho/m
<b>Head</b>	<b>1900 MHz</b>	$\epsilon_r = 40.0 \pm 5\%$	$\sigma = 1.40 \pm 5\%$ mho/m
ConvF X	<b>5.2</b> $\pm 9.5\%$ (k=2)	Boundary effect:	
ConvF Y	<b>5.2</b> $\pm 9.5\%$ (k=2)	Alpha	<b>0.50</b>
ConvF Z	<b>5.2</b> $\pm 9.5\%$ (k=2)	Depth	<b>2.73</b>

### Boundary Effect

<b>Head</b>	<b>900 MHz</b>	<b>Typical SAR gradient: 5 % per mm</b>	
Probe Tip to Boundary		<b>1 mm</b>	<b>2 mm</b>
SAR <sub>be</sub> [%]	Without Correction Algorithm	10.2	5.9
SAR <sub>be</sub> [%]	With Correction Algorithm	0.4	0.6
<b>Head</b>	<b>1800 MHz</b>	<b>Typical SAR gradient: 10 % per mm</b>	
Probe Tip to Boundary		<b>1 mm</b>	<b>2 mm</b>
SAR <sub>be</sub> [%]	Without Correction Algorithm	14.6	9.8
SAR <sub>be</sub> [%]	With Correction Algorithm	0.2	0.0

### Sensor Offset

Probe Tip to Sensor Center	<b>2.7</b>	mm
Optical Surface Detection	<b>1.4 <math>\pm</math> 0.2</b>	mm

### Receiving Pattern ( $\phi$ ), $\theta = 0^\circ$

**f = 30 MHz, TEM cell ifi110**

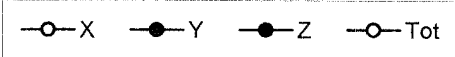
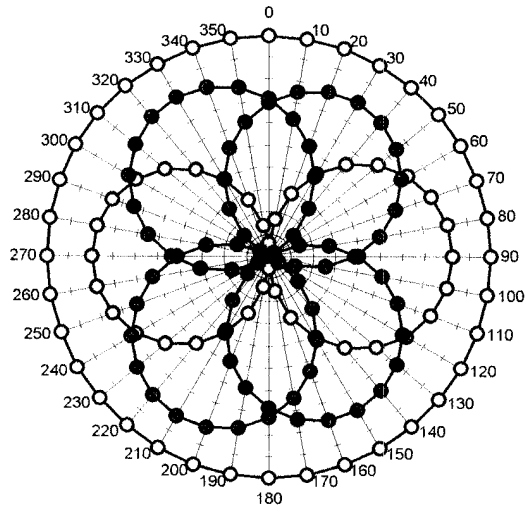

**f = 100 MHz, TEM cell ifi110**

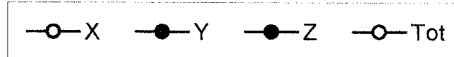
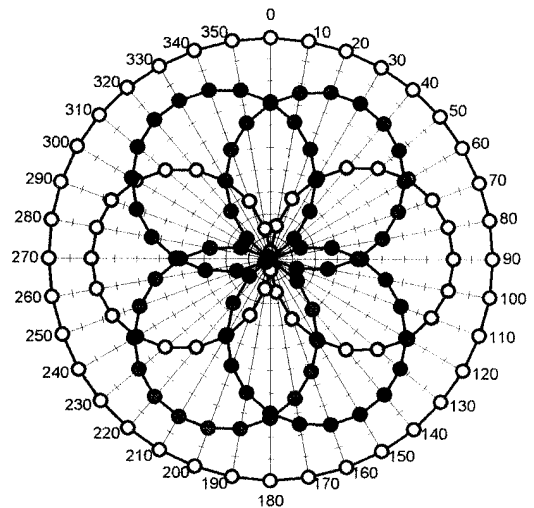

**f = 300 MHz, TEM cell ifi110**

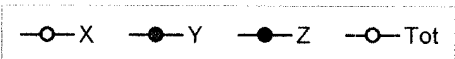
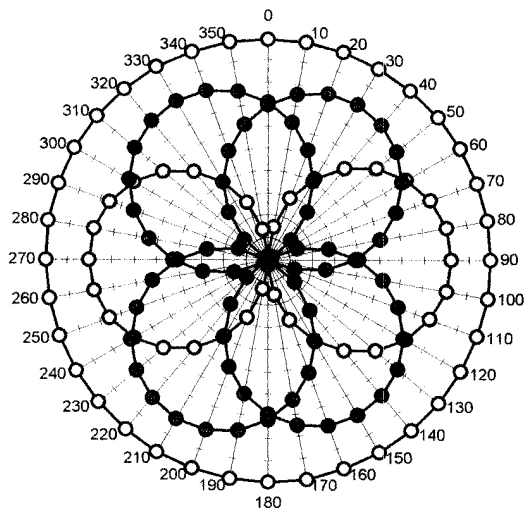

**f = 900 MHz, TEM cell ifi110**

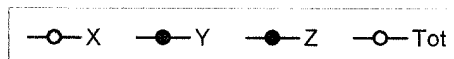
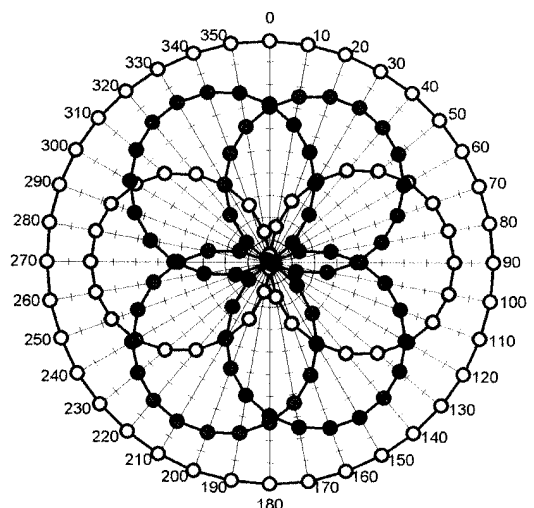

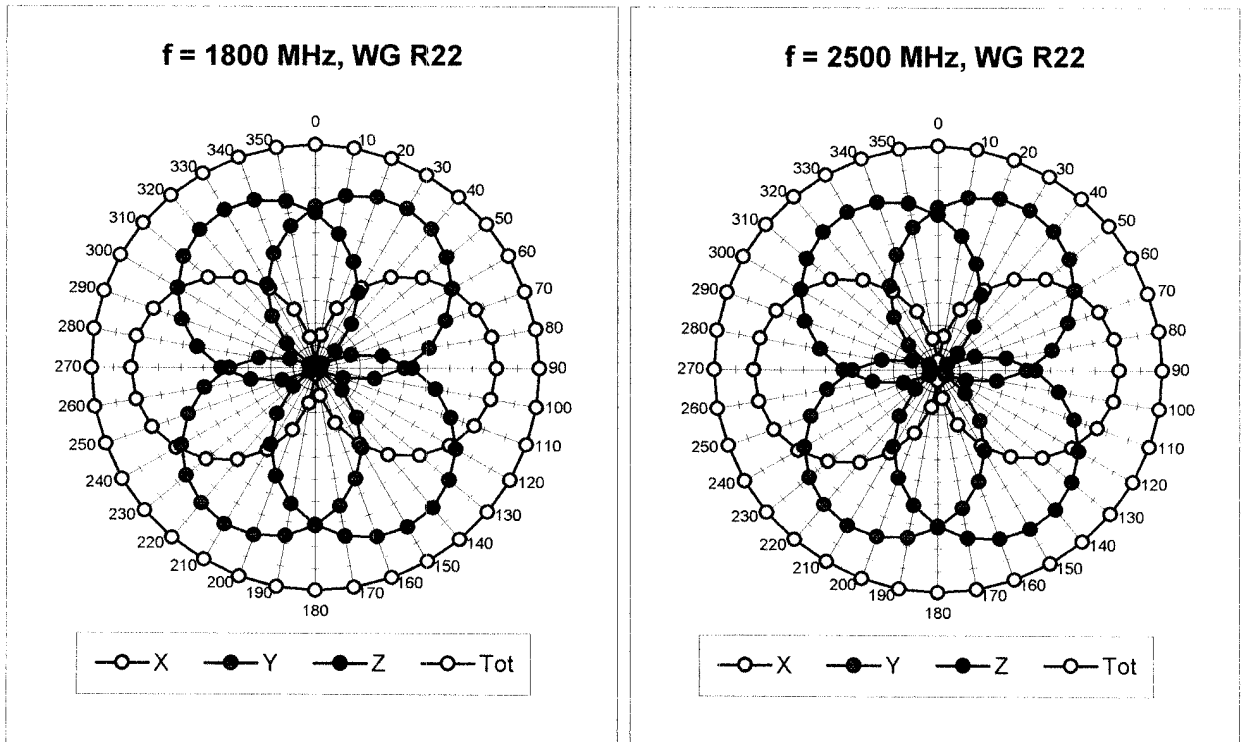

### Isotropy Error ( $\phi$ ), $\theta = 0^\circ$

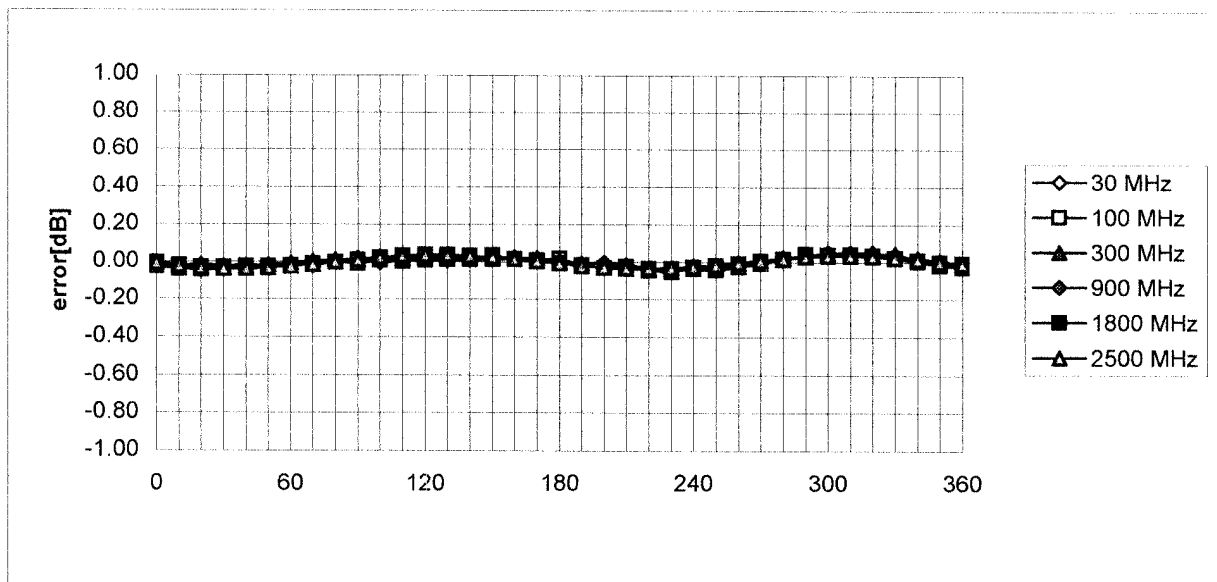

# Frequency Response of E-Field

( TEM-Cell:ifi110, Waveguide R22)

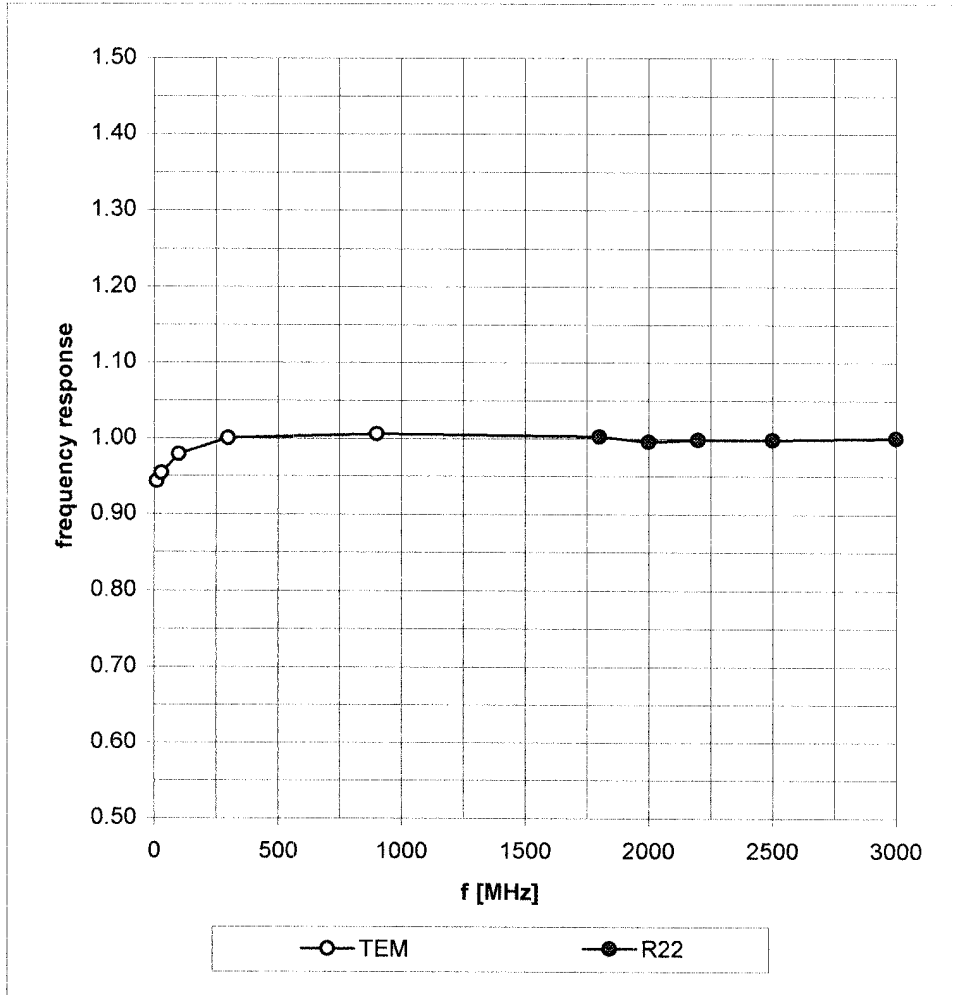

### Dynamic Range f(SAR<sub>brain</sub>) ( Waveguide R22 )

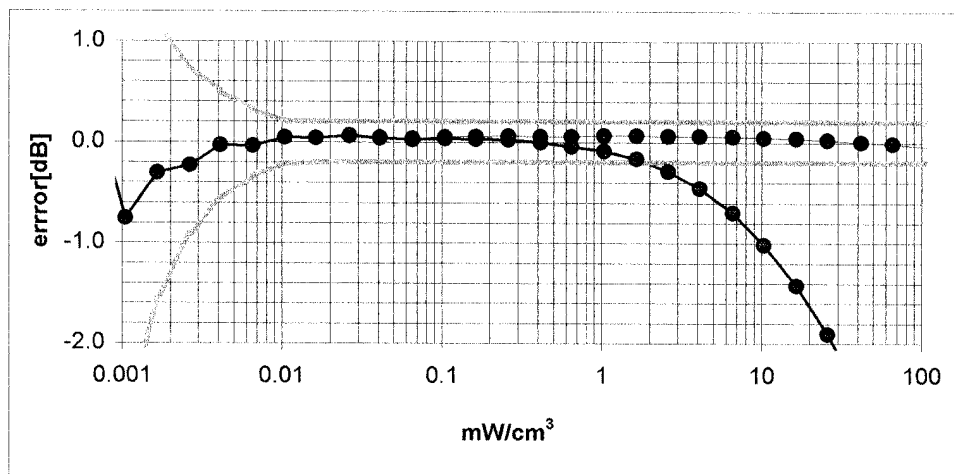
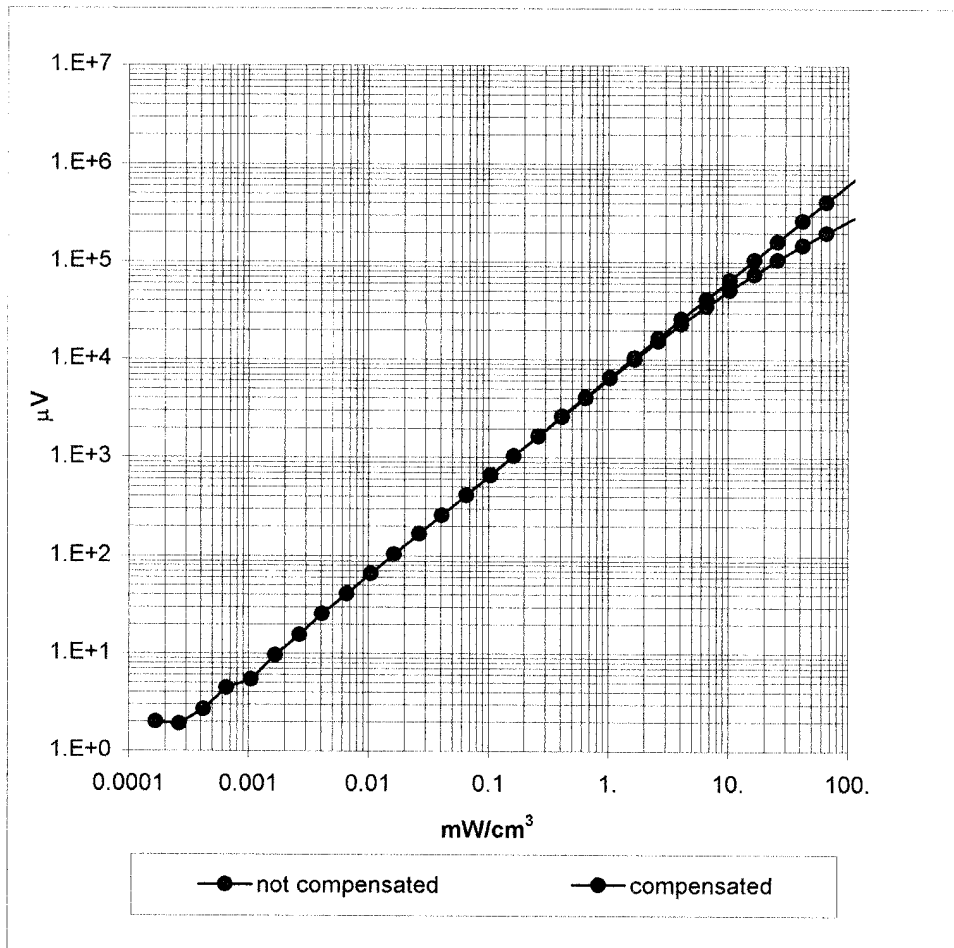



## Conversion Factor Assessment

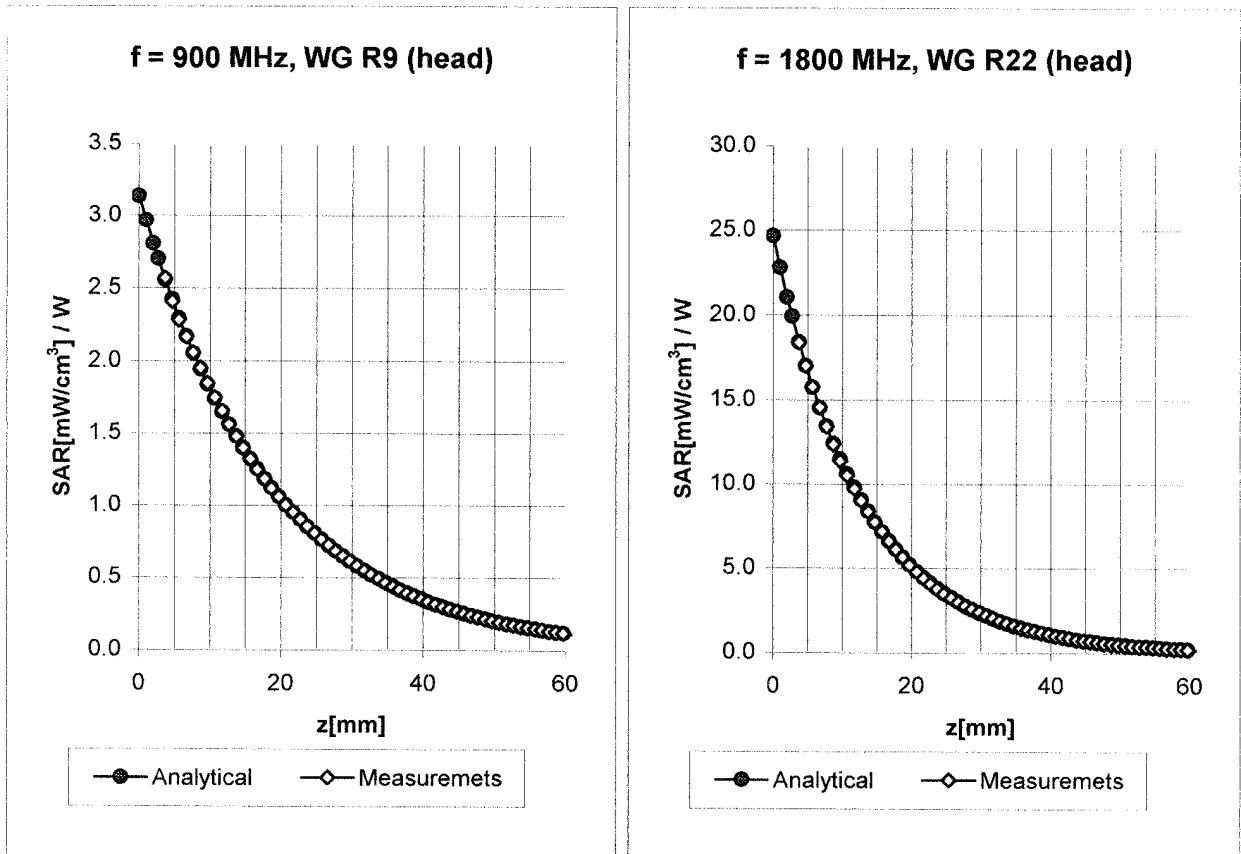

<b>Head</b>	<b>900 MHz</b>	$\epsilon_r = 41.5 \pm 5\%$	$\sigma = 0.97 \pm 5\% \text{ mho/m}$
<b>Head</b>	<b>835 MHz</b>	$\epsilon_r = 41.5 \pm 5\%$	$\sigma = 0.90 \pm 5\% \text{ mho/m}$
	ConvF X	<b>6.6</b> $\pm 9.5\%$ (k=2)	Boundary effect:
	ConvF Y	<b>6.6</b> $\pm 9.5\%$ (k=2)	Alpha <b>0.37</b>
	ConvF Z	<b>6.6</b> $\pm 9.5\%$ (k=2)	Depth <b>2.61</b>
<b>Head</b>	<b>1800 MHz</b>	$\epsilon_r = 40.0 \pm 5\%$	$\sigma = 1.40 \pm 5\% \text{ mho/m}$
<b>Head</b>	<b>1900 MHz</b>	$\epsilon_r = 40.0 \pm 5\%$	$\sigma = 1.40 \pm 5\% \text{ mho/m}$
	ConvF X	<b>5.2</b> $\pm 9.5\%$ (k=2)	Boundary effect:
	ConvF Y	<b>5.2</b> $\pm 9.5\%$ (k=2)	Alpha <b>0.50</b>
	ConvF Z	<b>5.2</b> $\pm 9.5\%$ (k=2)	Depth <b>2.73</b>

## Conversion Factor Assessment

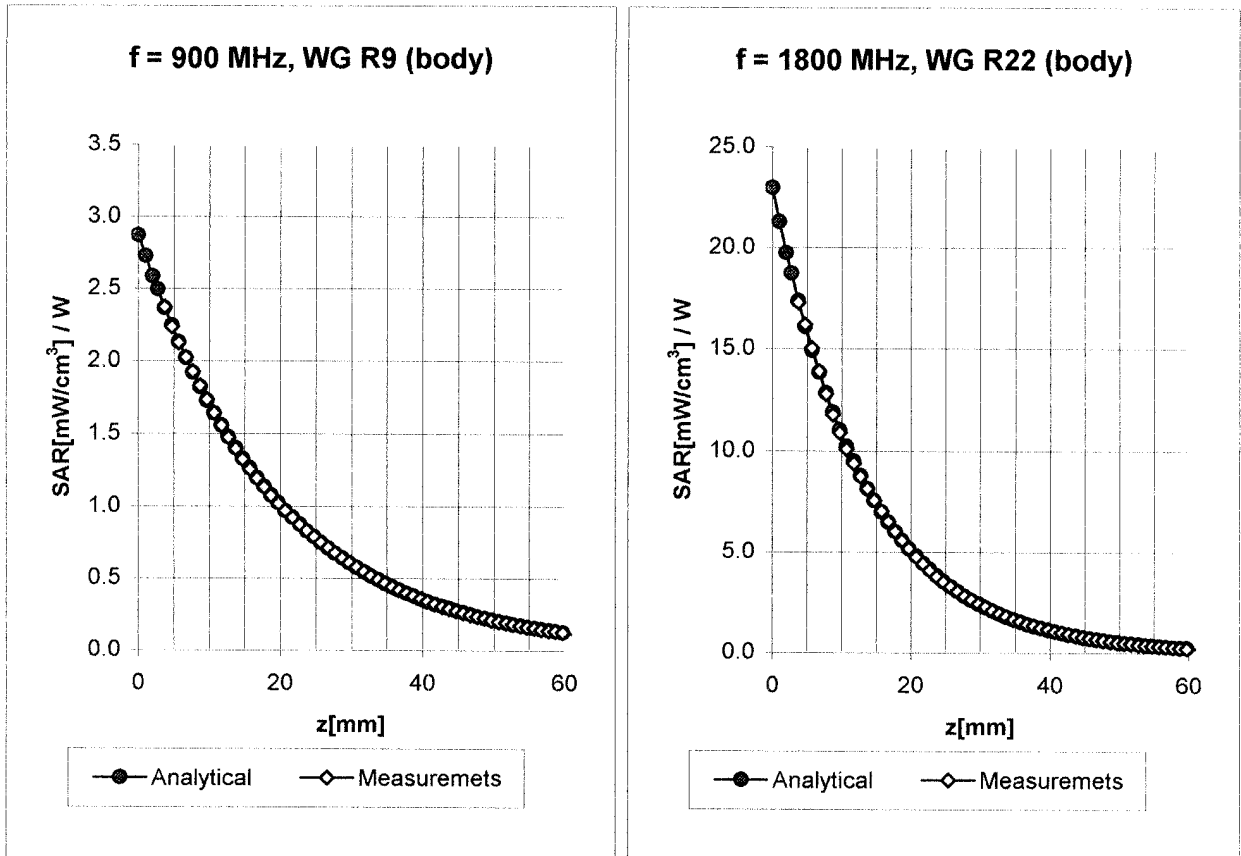

<b>Body</b>	<b>900 MHz</b>	$\epsilon_r = 55.0 \pm 5\%$	$\sigma = 1.05 \pm 5\% \text{ mho/m}$
<b>Body</b>	<b>835 MHz</b>	$\epsilon_r = 55.2 \pm 5\%$	$\sigma = 0.97 \pm 5\% \text{ mho/m}$
	ConvF X	<b>6.4</b> $\pm 9.5\%$ (k=2)	Boundary effect:
	ConvF Y	<b>6.4</b> $\pm 9.5\%$ (k=2)	Alpha <b>0.45</b>
	ConvF Z	<b>6.4</b> $\pm 9.5\%$ (k=2)	Depth <b>2.35</b>
<b>Body</b>	<b>1800 MHz</b>	$\epsilon_r = 53.3 \pm 5\%$	$\sigma = 1.52 \pm 5\% \text{ mho/m}$
<b>Body</b>	<b>1900 MHz</b>	$\epsilon_r = 53.3 \pm 5\%$	$\sigma = 1.52 \pm 5\% \text{ mho/m}$
	ConvF X	<b>4.9</b> $\pm 9.5\%$ (k=2)	Boundary effect:
	ConvF Y	<b>4.9</b> $\pm 9.5\%$ (k=2)	Alpha <b>0.60</b>
	ConvF Z	<b>4.9</b> $\pm 9.5\%$ (k=2)	Depth <b>2.59</b>

## Conversion Factor Assessment

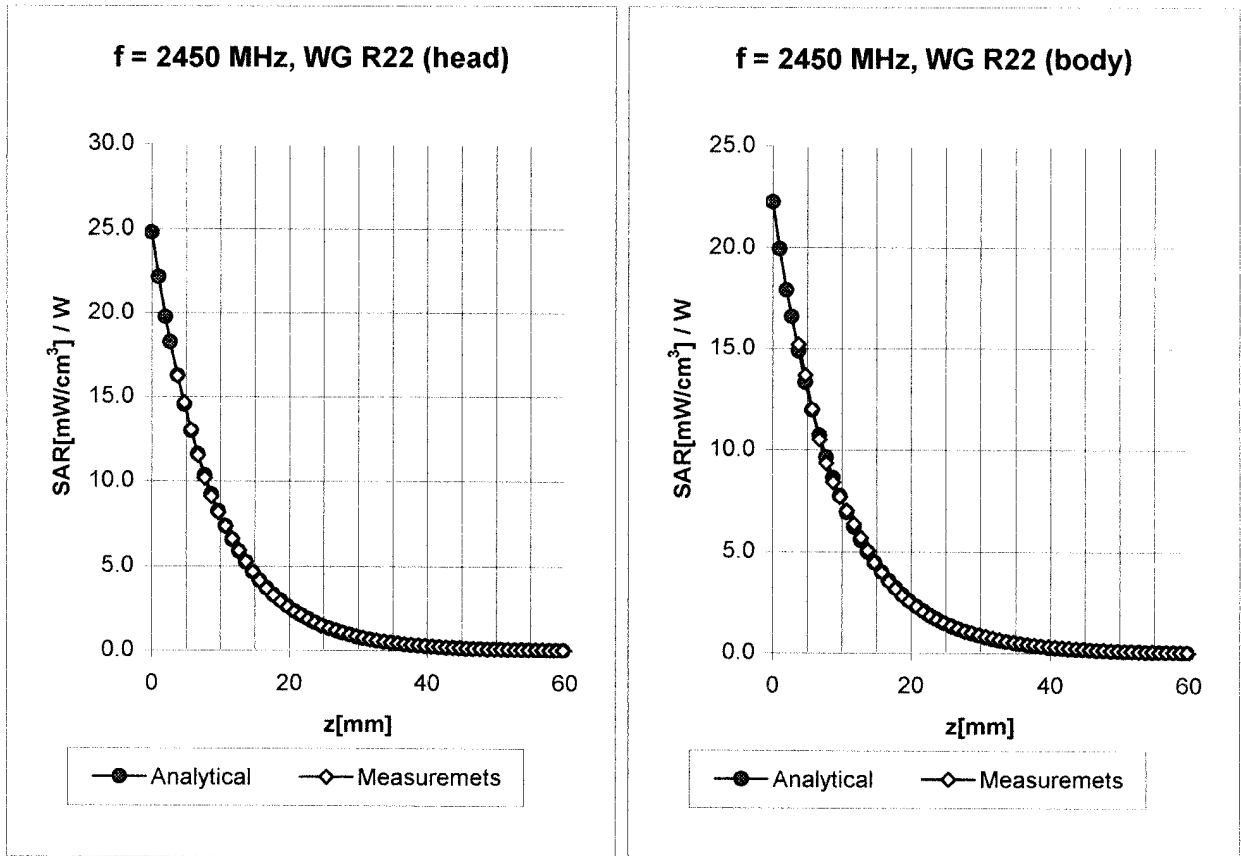

<b>Head</b>	<b>2450</b>	<b>MHz</b>	$\epsilon_r = 39.2 \pm 5\%$	$\sigma = 1.80 \pm 5\% \text{ mho/m}$
	ConvF X		<b>5.0</b> $\pm 8.9\%$ (k=2)	Boundary effect:
	ConvF Y		<b>5.0</b> $\pm 8.9\%$ (k=2)	Alpha <b>1.04</b>
	ConvF Z		<b>5.0</b> $\pm 8.9\%$ (k=2)	Depth <b>1.85</b>
<b>Body</b>	<b>2450</b>	<b>MHz</b>	$\epsilon_r = 52.7 \pm 5\%$	$\sigma = 1.95 \pm 5\% \text{ mho/m}$
	ConvF X		<b>4.6</b> $\pm 8.9\%$ (k=2)	Boundary effect:
	ConvF Y		<b>4.6</b> $\pm 8.9\%$ (k=2)	Alpha <b>1.20</b>
	ConvF Z		<b>4.6</b> $\pm 8.9\%$ (k=2)	Depth <b>1.60</b>

# Deviation from Isotropy in HSL

Error ( $\theta, \phi$ ),  $f = 900$  MHz

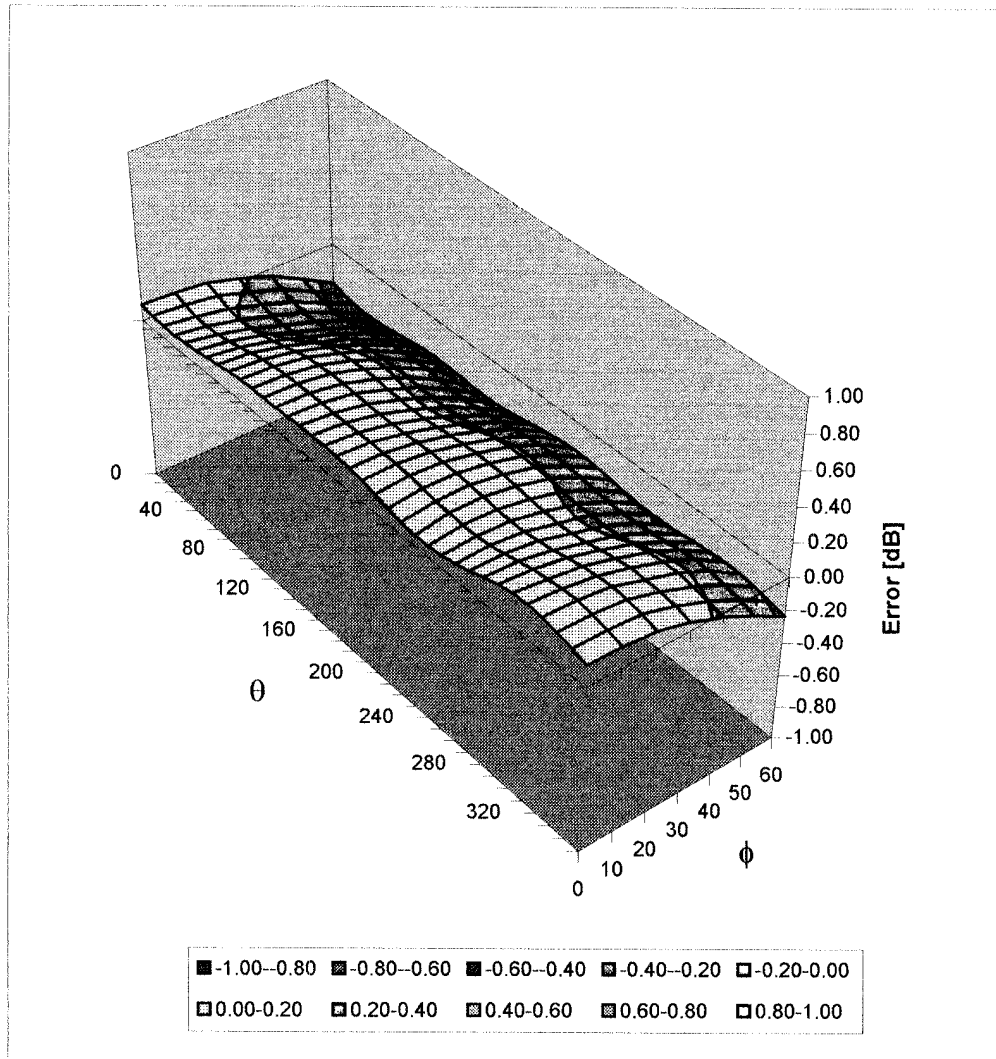

## Additional Conversion Factors for Dosimetric E-Field Probe

Type:	<b>ET3DV6</b>
Serial Number:	<b>1387</b>
Place of Assessment:	<b>Zurich</b>
Date of Assessment:	<b>February 28, 2003</b>
Probe Calibration Date:	<b>February 26, 2003</b>

Schmid & Partner Engineering AG hereby certifies that conversion factor(s) of this probe have been evaluated on the date indicated above. The assessment was performed using the FDTD numerical code SEMCAD of Schmid & Partner Engineering AG. Since the evaluation is coupled with measured conversion factors, it has to be recalculated yearly, i.e., following the re-calibration schedule of the probe. The uncertainty of the numerical assessment is based on the extrapolation from measured value at 900 MHz or at 1800 MHz.

Assessed by:

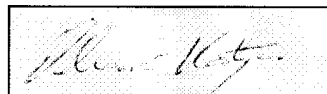

# Dosimetric E-Field Probe ET3DV6 SN:1387

Conversion factor ( $\pm$  standard deviation)

150 MHz	ConvF	$9.1 \pm 8\%$	$\epsilon_r = 52.3$ $\sigma = 0.76$ mho/m (head tissue)
300 MHz	ConvF	$7.9 \pm 8\%$	$\epsilon_r = 45.3$ $\sigma = 0.87$ mho/m (head tissue)
450 MHz	ConvF	$7.5 \pm 8\%$	$\epsilon_r = 43.5$ $\sigma = 0.87$ mho/m (head tissue)
150 MHz	ConvF	$8.8 \pm 8\%$	$\epsilon_r = 61.9$ $\sigma = 0.80$ mho/m (body tissue)
300 MHz	ConvF	$8.0 \pm 8\%$	$\epsilon_r = 58.2$ $\sigma = 0.92$ mho/m (body tissue)
450 MHz	ConvF	$7.7 \pm 8\%$	$\epsilon_r = 56.7$ $\sigma = 0.94$ mho/m (body tissue)

## APPENDIX E - MEASURED FLUID DIELECTRIC PARAMETERS

# 900MHz System Performance Check

## Measured Fluid Dielectric Parameters (Brain)

June 11, 2003

Frequency	$\epsilon'$	$\epsilon''$
800.000000 MHz	43.2176	20.2058
810.000000 MHz	43.1033	20.1957
820.000000 MHz	42.9725	20.1319
830.000000 MHz	42.8396	20.1026
840.000000 MHz	42.6921	20.0630
850.000000 MHz	42.5366	20.0171
860.000000 MHz	42.4322	19.9890
870.000000 MHz	42.3152	19.9760
880.000000 MHz	42.1843	19.9376
890.000000 MHz	42.0933	19.9189
900.000000 MHz	42.0408	19.8193
910.000000 MHz	41.9277	19.7747
920.000000 MHz	41.8207	19.7395
930.000000 MHz	41.7184	19.7089
940.000000 MHz	41.5845	19.6604
950.000000 MHz	41.4735	19.6732
960.000000 MHz	41.3596	19.6210
970.000000 MHz	41.2598	19.6035
980.000000 MHz	41.1445	19.6012
990.000000 MHz	41.0550	19.5681
1.000000000 GHz	40.9557	19.5393



# 900MHz EUT Evaluation (Body)

## Measured Fluid Dielectric Parameters (Muscle)

June 11, 2003

Frequency	$\epsilon'$	$\epsilon''$
800.000000 MHz	56.5083	21.8903
810.000000 MHz	56.4488	21.8090
820.000000 MHz	56.3751	21.7567
830.000000 MHz	56.2544	21.7175
840.000000 MHz	56.1467	21.6855
850.000000 MHz	56.0111	21.6544
860.000000 MHz	55.9506	21.5515
870.000000 MHz	55.8440	21.5441
880.000000 MHz	55.7770	21.4893
890.000000 MHz	55.6801	21.4579
900.000000 MHz	55.6229	21.3320
910.000000 MHz	55.5365	21.2828
920.000000 MHz	55.4627	21.2554
930.000000 MHz	55.3738	21.1832
940.000000 MHz	55.2717	21.1692
950.000000 MHz	55.2054	21.1101
960.000000 MHz	55.1201	21.0703
970.000000 MHz	55.0443	21.0673
980.000000 MHz	54.9717	21.0632
990.000000 MHz	54.9001	21.0193
1.000000000 GHz	54.8341	21.0032

## **APPENDIX F - SAM PHANTOM CERTIFICATE OF CONFORMITY**

# Schmid & Partner Engineering AG

Zeughausstrasse 43, 8004 Zurich, Switzerland, Phone +41 1 245 97 00, Fax +41 1 245 97 79

## Certificate of conformity / First Article Inspection

Item	SAM Twin Phantom V4.0
Type No	QD 000 P40 BA
Series No	TP-1002 and higher
Manufacturer / Origin	Untersee Composites Hauptstr. 69 CH-8559 Fruthwilen Switzerland

### Tests

The series production process used allows the limitation to test of first articles. Complete tests were made on the pre-series Type No. QD 000 P40 AA, Serial No. TP-1001 and on the series first article Type No. QD 000 P40 BA, Serial No. TP-1006. Certain parameters have been retested using further series units (called samples).

Test	Requirement	Details	Units tested
Shape	Compliance with the geometry according to the CAD model.	IT'IS CAD File (*)	First article, Samples
Material thickness	Compliant with the requirements according to the standards	2mm +/- 0.2mm in specific areas	First article, Samples
Material parameters	Dielectric parameters for required frequencies	200 MHz – 3 GHz Relative permittivity < 5 Loss tangent < 0.05.	Material sample TP 104-5
Material resistivity	The material has been tested to be compatible with the liquids defined in the standards	Liquid type HSL 1800 and others according to the standard.	Pre-series, First article

### Standards

- [1] CENELEC EN 50361
- [2] IEEE P1528-200x draft 6.5
- [3] IEC PT 62209 draft 0.9

(\*) The IT'IS CAD file is derived from [2] and is also within the tolerance requirements of the shapes of [1] and [3].

### Conformity

Based on the sample tests above, we certify that this item is in compliance with the uncertainty requirements of SAR measurements specified in standard [1] and draft standards [2] and [3].

Date 18.11.2001

Signature / Stamp

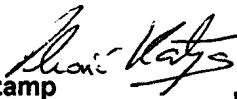

**Schmid & Partner  
Engineering AG**



Zeughausstrasse 43, CH-8004 Zurich  
Tel. +41 1 245 97 00, Fax +41 1 245 97 79

## APPENDIX G - SAR TEST SETUP PHOTOGRAPHS

### SAR TEST SETUP PHOTOGRAPHS

Back of LCD Display (Closed) - Antenna Parallel to Planar Phantom (Stowed Position)  
0.0cm Separation Distance from Back of LCD to Planar Section of SAM Phantom



### SAR TEST SETUP PHOTOGRAPHS

Back of LCD Display (Closed) - Antenna Perpendicular to Planar Phantom (180°)  
0.0cm Separation Distance from Back of LCD to Planar Section of SAM Phantom



### BODY SAR TEST SETUP PHOTOGRAPHS

Bottom of Laptop PC (LCD Display Closed) - Antenna Parallel to Planar Phantom (Stowed Position)  
0.0cm Separation Distance from Bottom of Laptop PC to Planar Section of SAM Phantom



### BODY SAR TEST SETUP PHOTOGRAPHS

Bottom of Laptop PC (LCD Display Closed) - Antenna Perpendicular to Planar Phantom (180°)  
0.0cm Separation Distance from Bottom of Laptop PC to Planar Section of SAM Phantom





### BODY SAR TEST SETUP PHOTOGRAPHS

Right Side of LCD Display (Closed) - Antenna Parallel to Planar Phantom (Stowed Position)  
1.5cm Separation Distance from Antenna to Planar Section of SAM Phantom



### BODY SAR TEST SETUP PHOTOGRAPHS

Right Side of LCD Display (Closed) - Antenna Parallel to Planar Phantom (Extended Position)  
1.5cm Separation Distance from Antenna to Planar Section of SAM Phantom

