

Test Report S/N:	052604-514KBC
Test Date(s):	28Jun04 - 29Jul04
Test Type:	FCC Part 15.247

EMC TEST REPORT
FOR THE
MODEL IX260+ RUGGED LAPTOP PC
INCLUDING THE
INTEL PRO 2200BG 802.11B/G MINI-PCI 2.4 GHz DSSS WLAN
WITH THE **RANGESTAR INTERNAL ANTENNA**
CO-LOCATED WITH
SONY ERICSSON GC82 DUAL-BAND GSM GPRS/EDGE PCMCIA MODEM
& **EXTERNAL SWIVEL DIPOLE ANTENNA**

TRSN 052604-514KBC
Issue 2.0

Celltech Compliance Testing & Engineering Lab
(Celltech Labs Inc.)
1955 Moss Court
Kelowna, BC
Canada
V1Y 9L3

August 4, 2004

(In accordance with FCC Part 15.247)



Test Report S/N:	052604-514KBC
Test Date(s):	28Jun04 - 29Jul04
Test Type:	FCC Part 15.247

DECLARATION OF COMPLIANCE

Test Lab		Applicant	
CELLTECH LABS INC. Testing and Engineering Services 1955 Moss Court Kelowna, B.C. Canada V1Y 9L3		ITRONIX CORPORATION 801 South Stevens Street Spokane, WA 99210 USA	
Phone:	250-448-7047		
Fax:	250-448-7048		
e-mail:	info@celltechlabs.com		
web site:	www.celltechlabs.com		
Laboratory Registration No.(s):		FCC: 714830	IC IC 3874
Rule Part(s):	FCC: §15.247; §2.1091; §1.1310		
Device Classification:	FCC: Digital Transmission System (DTS)		
Device Identification:	FCC ID: KBCIX260PROGC82		
DUT Description:			
Model:	IX260+		
Device Type:	IX260+ Rugged Laptop PC including the Intel Pro 2200BG 802.11b/g Mini-PCI 2.4 GHz DSSS WLAN Card with the RangeStar internal dual surface-mount antenna, co-located with the Sony Ericsson GC82 Dual-Band GSM GPRS/EDGE PCMCIA Modem & external swivel dipole antenna		
TX Frequency Range:	WLAN: 2412 - 2462 MHz		
Max. RF Output Power:	17.48 dBm Peak Conducted - 802.11b 16.15 dBm Peak Conducted - 802.11g		
Modulation(s):	WLAN: DBPSK, DQPSK, CCK		
Antenna Type(s):	WLAN: RangeStar P/N: 100929 Internal Surface-Mount DUAL-BAND GSM: External Swivel Dipole		
Power Supply:	Stationary: 90 Watt AC Power Adapter/11.1V Lithium-ion Battery, 6.0Ah (Model: A2121-2)		

This wireless mobile device has demonstrated compliance with the applicable technical standards as indicated in the measurement report and was tested in accordance with the measurement procedures specified in FCC 47 CFR Part 15.247.

I attest to the accuracy of the data. All measurements reported herein were performed by me or were under my supervision and are correct to the best of my knowledge and belief. I assume full responsibility for the completeness of these measurements and vouch for the qualifications of all persons taking them.

This test report shall not be reproduced partially, or in full, without the prior written approval of Celltech Labs Inc. The results and statements contained in this report pertain only to the device(s) evaluated.

Russell Pipe
Senior Compliance Technologist
Celltech Labs Inc.

Duane M. Friesen
EMC Manager
Celltech Labs Inc.

Itronix Corporation	Model: IX260+	FCC ID:	KBCIX260PROGC82
Rugged Laptop PC with internal WLAN (802.11b/g) & Dual-Band GSM GPRS/EDGE Modem			
2004 Celltech Labs Inc	This document is not to be reproduced in whole or in part without the written permission of Celltech Labs Inc.		2 of 80

Test Report S/N:	052604-514KBC
Test Date(s):	28Jun04 - 29Jul04
Test Type:	FCC Part 15.247

TABLE OF CONTENTS

1.0 SCOPE	7
2.0 REFERENCES	7
2.1 Normative References	7
3.0 TERMS AND DEFINITIONS	8
4.0 FACILITIES AND ACCREDITATIONS	9
5.0 GENERAL INFORMATION	9
5.1 Applicant Information	9
5.2 DUT Description.....	9
5.3 Co-Located Equipment	10
5.4 Cable Descriptions.....	10
5.5 Support Equipment	10
5.6 Clock Frequencies	11
5.7 Mode(s) of Operation Tested	11
5.8 Configuration Description	12
6.0 PASS/FAIL CRITERIA.....	12
APPENDIX	13
Appendix A - DUT Photographs	14
Appendix B - 6 dB Bandwidth Measurement	15
Appendix C - Peak Conducted Power Measurement.....	24
Appendix D - Maximum Permissible Exposure Calculation.....	27
Appendix E - Radiated Spurious Emissions Measurement.....	30
Appendix F - Restricted Band Emissions Measurement	49
Appendix G - Peak Power Spectral Density Measurement.....	64
Appendix H - Conducted Powerline Emissions Measurement	73
END OF DOCUMENT	80

Test Report S/N:	052604-514KBC
Test Date(s):	28Jun04 - 29Jul04
Test Type:	FCC Part 15.247

FIGURES

Figure B-1 – Setup Drawing.....	16
Figure C-1 – Setup Drawing.....	25
Figure E-1 – Setup Drawing.....	31
Figure F-1 – Setup Drawing.....	51
Figure G-1 – Setup Drawing.....	65
Figure H-1 – Setup Drawing.....	76

PLOTS

Plot B-1 - 6 dB Bandwidth Low Channel (802.11b).....	17
Plot B-2 - 6 dB Bandwidth Mid Channel (802.11b).....	18
Plot B-3 - 6 dB Bandwidth High Channel (802.11b).....	19
Plot B-4 - 6 dB Bandwidth Low Channel (802.11g).....	20
Plot B-5 - 6 dB Bandwidth Mid Channel (802.11g).....	21
Plot B-6 - 6 dB Bandwidth High Channel (802.11g).....	22
Plot G-1 - PPSD Low Channel (802.11b).....	66
Plot G-2 - PPSD Mid Channel (802.11b).....	67
Plot G-3 - PPSD High Channel (802.11b).....	68
Plot G-4 - PPSD Low Channel (802.11g).....	69
Plot G-5 - PPSD Mid Channel (802.11g).....	70
Plot G-6 - PPSD High Channel (802.11g).....	71
Plot H-1 - Line 1 Peak Conducted Powerline Emissions.....	78
Plot H-2 - Line 2 Peak Conducted Powerline Emissions.....	78

Test Report S/N:	052604-514KBC
Test Date(s):	28Jun04 - 29Jul04
Test Type:	FCC Part 15.247

PHOTOGRAPHS

Photograph A-1 - Front of Open IX260+ Laptop PC.....	14
Photograph A-2 - Back of Open IX260+ Laptop PC.....	14
Photograph A-3 - Left Side of Open IX260+ Laptop PC.....	14
Photograph A-4 - Right Side of Open IX260+ Laptop PC.....	14
Photograph E-1 - Horizontal Polarization (30MHz – 1 GHz).....	32
Photograph E-2 - Vertical Polarization (30MHz – 1 GHz).....	32
Photograph E-3 - Front of Radiated Emission Configuration.....	32
Photograph E-4 - Back of Radiated Emission Configuration.....	32
Photograph F-1 - Horizontal Polarization (30MHz – 1 GHz).....	52
Photograph F-2 - Vertical Polarization (30MHz – 1 GHz).....	52
Photograph F-3 - Front of Radiated Emission Configuration.....	52
Photograph F-4 - Back of Radiated Emission Configuration.....	52
Photograph H-1 – AC Powerline Conducted Emission Configuration.....	75
Photograph H-2 – AC Powerline Conducted Emission Cable Placement.....	75

Test Report S/N:	052604-514KBC
Test Date(s):	28Jun04 - 29Jul04
Test Type:	FCC Part 15.247

TEST SUMMARY



Referenced Standard: CFR Title 47 Part 15

<u>Appendix</u>	<u>Test Description</u>	<u>Procedure Reference</u>	<u>Limit Reference</u>	<u>Test Start Date</u>	<u>Test End Date</u>	<u>Result</u>
B	6 dB Bandwidth	FCC 97-114	§15.247(2)	26Jul04	26Jul04	Pass
C	Peak Conducted Power	FCC 97-114	§15.247 (b) (3)	28Jun04	26Jul04	Pass
D	Maximum Permissible Exposure	FCC CFR 47 § 2.1091 IEEE Std C95.1-1992	§1.1310 Table 1 (b)	28Jun04	28Jun04	Pass
E	Radiated Spurious Emissions	FCC 97-114	§15.247(c)	26Jul04	29Jul04	Pass
F	Restricted Band Emissions	FCC 97-114	§15.205 (a), (b) §15.209 (a)	26Jul04	29Jul04	Pass
G	Peak Power Spectral Density	FCC 97-114	§15.247(d)	27Jul04	27Jul04	Pass
H	Powerline Conducted Emissions	ANSI C63.4	§15.207	29Jun04	5Jul04	Pass

REVISION LOG

<u>Issue</u>	<u>Description</u>	<u>Implemented By</u>	<u>Implementation Date</u>
1.0	Initial Release	Jon Hughes	20Jul04
2.0	Updated Release	Jon Hughes	04Aug04

SIGNATORIES

Prepared By:		Aug 04, 2004
Name/Title	Russell Pipe / Senior Compliance Technologist	Date
Reviewed By:		Aug 04, 2004
Name/Title	Jon Hughes / General Manager	Date
Approved By:		Aug 04, 2004
Name/Title	Duane M. Friesen, C.E.T. / EMC Manager	Date

Test Report S/N:	052604-514KBC
Test Date(s):	28Jun04 - 29Jul04
Test Type:	FCC Part 15.247

1.0 SCOPE

This report outlines the measurements made and results collected during the Electromagnetic emissions testing of the Itronix Corporation IX260+ Rugged Laptop PC including the internal Intel Pro 2200BG 802.11b/g 2.4 GHz DSSS WLAN Mini-PCI Card with Rangestar internal dual surface-mount antenna, co-located with the Sony Ericsson GC82 Dual-Band GSM GPRS/EDGE PCMCIA Modem with external swivel dipole antenna. The results were applied against the EMC requirements and limits outlined in the technical rules and regulations set forth in the Federal Communication Commission Code of Federal Regulations Title 47 Part 15 subpart J.

2.0 REFERENCES

2.1 Normative References

ANSI/ISO 17025:1999	General Requirements for competence of testing and calibration laboratories
CFR Title 47 Part 2:2003	Code of Federal Regulations Title 47: Telecommunication Part 2: Frequency Allocations and Radio Treaty Matters; General Rules and Regulations
CFR Title 47 Part 15:2003	Code of Federal Regulations Title 47: Telecommunication Part 15: Radio Frequency Devices

Test Report S/N:	052604-514KBC
Test Date(s):	28Jun04 - 29Jul04
Test Type:	FCC Part 15.247

3.0 TERMS AND DEFINITIONS

AVG	Average
CFR	Code of Federal Regulations
dB	decibel
dBm	dB referenced to 1 mW
dBuV	dB referenced to 1 uV
DUT	Device under Test
dBc	dB down from carrier
EBW	Emission Bandwidth
EMC	Electromagnetic Compatibility
FCC	Federal Communication Commission
HP	Hewlett Packard
HPF	High Pass Filter
Hpol	Horizontal Polarization
IC	Industry Canada
kHz	kilohertz
LNA	Low Noise Amplifier
m	meter
MHz	Megahertz
Mbps	megabits per second
na	not applicable
n/a	not available
PK	Peak
PPSD	Peak Power Spectral Density
QP	Quasi-peak
RBW	Resolution Bandwidth
R&S	Rohde & Schwarz
RSS	Radio Standard Specification
SA	Spectrum Analyzer
VBW	Video Bandwidth
Vpol	Vertical Polarization
WLAN	Wireless Local Area Network

Test Report S/N:	052604-514KBC
Test Date(s):	28Jun04 - 29Jul04
Test Type:	FCC Part 15.247

4.0 FACILITIES AND ACCREDITATIONS

The facilities used in collecting the test results outlined in this report are located at 1955 Moss Court, Kelowna, British Columbia, Canada, V1Y 9L3. The radiated and conducted emissions sites conform with the requirements set forth in ANSI C63.4 and are filed and listed with the FCC under Registration Number 714830 and Industry Canada under File Number IC 3874.

5.0 GENERAL INFORMATION

5.1 Applicant Information

Company Name:	Itronix Corporation
Address:	801 South Stevens Street Spokane, WA 99210 USA

5.2 DUT Description

The DUT consisted of Model IX260+ Rugged Laptop PC with Intel Pro 2200BG 802.11b/g 2.4 GHz DSSS WLAN Mini-PCI Card installed in the Mini-PCI slot, and Internal Dual Surface-Mount Antenna installed in the LCD display. Co-located within the Laptop PC is a Sony Ericsson GC82 Dual-Band GSM GPRS/EDGE PCMCIA Modem with external swivel dipole antenna mounted to the upper right side of the LCD display. Photographs of the DUT placement and construction are shown in Appendix A.

Name:	Rugged Laptop PC		
Model:	IX260+		
Serial Number:	ZZGEG4112ZZ9777		
Device Identification:	FCC ID:	KBCIX260PROGC82	
Power Source:	Delta Electronics Model ADP-90AB Rev B 90 Watt AC-DC power supply		

Name:	2.4GHz DSSS WLAN Mini-PCI Card (802.11b/g)		
Model:	Intel Pro 2200BG		
Serial Number:	06036C074ADC54906006		
Rule Part(s):	FCC:	§15.247; §2.1091; §1.1310	
Device Classification:	FCC:	Digital Transmission System (DTS)	
Power Source:	Powered from the internal PC power supply		

Name:	Internal Dual Surface-Mount Antenna		
Model:	RangeStar P/N: 100929		
Gain:	4.5 dBi		

Itronix Corporation	Model: IX260+	FCC ID:	KBCIX260PROGC82
Rugged Laptop PC with internal WLAN (802.11b/g) & Dual-Band GSM GPRS/EDGE Modem			
2004 Celltech Labs Inc	This document is not to be reproduced in whole or in part without the written permission of Celltech Labs Inc.		9 of 80

Test Report S/N:	052604-514KBC
Test Date(s):	28Jun04 - 29Jul04
Test Type:	FCC Part 15.247

5.3 Co-Located Equipment

Name:	Dual-Band GSM GPRS/EDGE PCMCIA Modem		
Model:	Sony Ericsson GC82	FCC ID:	PY7F1041011
Serial Number:	TE60028259		

Name:	Dual-Band GSM External Mounted Swivel Dipole Antenna		
Model:	IX260+		
Gain:	2.6 dBi		

5.4 Cable Descriptions

ROUTING		Length m	Model	Terminations		Shield Type	Shield Termination		Suppression
From	To			End 1	End 2		End 1	End 2	
PC Fire Wire Port	Unterminated	1.0	Copartner E119932	IEEE-1528	Fire wire	n/a	n/a	n/a	None
PC modem port	Unterminated	1.0	n/a	RJ-11	RJ-11	None	na	na	None

5.5 Support Equipment

The following equipment was used in support of the DUT.

CO-LOCATED SUPPORT EQUIPMENT LIST		
MANUFACTURER	MODEL	DESCRIPTION
D-Link	DE-809TC/	Ethernet hub
YNG YUH	YP-040	Hub power supply
MLi	699	Speakers
Polk Audio	n/a	Speaker microphone
DeLorme	Tripmate	GPS Receiver
Intel	CS-430	Camera
Logitech	M-S34	Mouse

Itronix Corporation	Model: IX260+	FCC ID:	KBCIX260PROGC82
Rugged Laptop PC with internal WLAN (802.11b/g) & Dual-Band GSM GPRS/EDGE Modem			
2004 Celltech Labs Inc	This document is not to be reproduced in whole or in part without the written permission of Celltech Labs Inc.		10 of 80

Test Report S/N:	052604-514KBC
Test Date(s):	28Jun04 - 29Jul04
Test Type:	FCC Part 15.247

5.6 Clock Frequencies

5.6.1 DUT Clock Frequencies

Name:	Rugged Laptop PC
Clocks:	1.6 GHz processor
Name:	2.4GHz DSSS WLAN Mini-PCI Card
Clocks:	40 MHz, f _o /1.5 (Low – 1608.000 MHz, Mid – 1624.667 MHz, High – 1641.333 MHz)
Name:	Dual Internal Surface-Mount (WLAN) Antenna
Clocks:	None

5.6.2 Co-Located Clock Frequencies

Name:	Peripherals
Clocks:	n/a
Name:	GC82 Radio Modem
Clocks:	n/a

5.7 Mode(s) of Operation Tested

Customer supplied software was used to place the WLAN card in the appropriate mode, channel and power level for the specific measurement. **As described by the client, PC installed firmware would insure that the GC82 Radio Modem transmit mode would be disabled whenever the WLAN was active, therefore the radio modem was placed in receive mode during the measurements described herein.**

TX Frequency Range:	2412 – 2462 MHz Ch. 1 (2412 MHz), Ch. 6 (2437 MHz) & Ch. 11 (2462 MHz) measured unless otherwise noted	
Software Power Gain Settings:	802.11b set to 29 802.11g set to 24.5	
RF Peak Conducted Output Power Tested	802.11b 2412 MHz(1 Mbps) = 16.28 dBm 802.11b 2437 MHz(1 Mbps) = 16.79 dBm 802.11b 2462 MHz(1 Mbps) = 17.48 dBm	802.11g 2412 MHz(6 Mbps) = 15.14 dBm 802.11g 2437 MHz(6 Mbps) = 15.55 dBm 802.11g 2462 MHz(6 Mbps) = 16.15 dBm
Modes / Data Rates Tested:	802.11b (1, 5.5, 11 Mbps checked in prescan) (1 Mbps determined to be worse case and used unless otherwise noted)	
	802.11g (6, 36, 54 Mbps checked in prescan) (6 Mbps determined to be worse case and used unless otherwise noted)	
Battery Type(s)	11.1V Lithium-ion, 6.0Ah (Model: A2121-2)	
Modulation Type:	OFDM with BPSK, QPSK, 16QAM, 64QAM, DBPSK, DQPSK, CCK	

Itronix Corporation	Model: IX260+	FCC ID:	KBCIX260PROGC82
Rugged Laptop PC with internal WLAN (802.11b/g) & Dual-Band GSM GPRS/EDGE Modem			
2004 Celltech Labs Inc	This document is not to be reproduced in whole or in part without the written permission of Celltech Labs Inc.		11 of 80

Test Report S/N:	052604-514KBC
Test Date(s):	28Jun04 - 29Jul04
Test Type:	FCC Part 15.247

5.7.1 DUT Exercising Software Description

The DUT was configured and exercised using customer supplied test software that allowed an operator to set the parameters of the WLAN operation. The settings used are described in each appendix. Unless otherwise noted the power gain settings were set for 29 for 802.11b and 24.5 for 802.11g and the data rate set for 1 Mbps for 802.11b and 6 Mbps for 802.11g.

5.8 Configuration Description

The DUT was configured, as described by the client as being representative of what would be delivered to a final customer. This configuration included the radio modem and external antenna as described in section 5.2 installed in a typical manner. More specific details may be included in each appendix.

5.8.1 Configuration Justification

The DUT was tested in a configuration described by the client as being worse case but typical of normal use.

Prescan measurements were made with the WLAN in each of the two available modes (b & g), lowest, medium and highest bit rates and each of the lowest, highest and mid-band frequencies. From this preliminary data, it was determined that Channel 11, Mode b Rate 1 Mbps resulted in the highest emissions. When a measurement of Mode g was required, its data rate was set for a worse case setting of 6 Mbps. Unless otherwise specified in the applicable appendices, these settings were used for the measurements described in this report.

6.0 PASS/FAIL CRITERIA

Unless otherwise noted in the Appendices, the pass/fail criteria is the limit set forth in the reference standards. A DUT is considered to have passed the requirements, if the data collected during the described measurement procedure is less than or equal to the specified limits as defined. The pass/fail statements made in this report only apply to the unit tested.

Itronix Corporation	Model: IX260+	FCC ID:	KBCIX260PROGC82
Rugged Laptop PC with internal WLAN (802.11b/g) & Dual-Band GSM GPRS/EDGE Modem			
2004 Celltech Labs Inc	This document is not to be reproduced in whole or in part without the written permission of Celltech Labs Inc.		12 of 80

Test Report S/N:	052604-514KBC
Test Date(s):	28Jun04 - 29Jul04
Test Type:	FCC Part 15.247

APPENDIX

Itronix Corporation	Model: IX260+	FCC ID:	KBCIX260PROGC82
Rugged Laptop PC with internal WLAN (802.11b/g) & Dual-Band GSM GPRS/EDGE Modem			
2004 Celltech Labs Inc	This document is not to be reproduced in whole or in part without the written permission of Celltech Labs Inc.		13 of 80

Test Report S/N:	052604-514KBC
Test Date(s):	28Jun04 - 29Jul04
Test Type:	FCC Part 15.247

Appendix A - DUT Photographs

Photograph A-1 - Front of Open IX260+ Laptop PC



Photograph A-2 - Back of Open IX260+ Laptop PC



Photograph A-3 - Left Side of Open IX260+ Laptop PC



Photograph A-4 - Right Side of Open IX260+ Laptop PC



Itronix Corporation	Model: IX260+	FCC ID:	KBCIX260PROGC82
Rugged Laptop PC with internal WLAN (802.11b/g) & Dual-Band GSM GPRS/EDGE Modem			
2004 Celltech Labs Inc	This document is not to be reproduced in whole or in part without the written permission of Celltech Labs Inc.		14 of 80

Test Report S/N:	052604-514KBC
Test Date(s):	28Jun04 - 29Jul04
Test Type:	FCC Part 15.247

Appendix B - 6 dB Bandwidth Measurement

B.1. REFERENCES	
Normative Reference Standard	FCC CFR 47 §15.247 (2)
Procedure Reference	FCC 97-114

B.2. LIMITS	
B.2.1. FCC CFR 47	
FCC CFR 47 §15.247	(2) <i>Systems using digital modulation techniques may operate in the 902 – 928, 2400 – 2483.5 MHz, and 5725 – 5850 MHz bands. The minimum 6 dB bandwidth shall be at least 500 kHz</i>

B.3. ENVIRONMENTAL CONDITIONS	
Temperature	25.2 +/- 2 °C
Humidity	35 +/- 2 %
Barometric Pressure	96.34 kPa

B.4. EQUIPMENT LIST					
ASSET NUMBER	MANUFACTURER	MODEL	DESCRIPTION	LAST CAL	CAL DUE
00072	EMCO	2075	Mini-mast	n/a	n/a
00073	EMCO	2080	Turn Table	n/a	n/a
00071	EMCO	2090	Multi-Device Controller	n/a	n/a
00035	ETS	3115	Double Ridged Guide Horn	24Mar04	24Mar05
00015	Agilent	E4408B	Spectrum Analyzer	29Dec03	29Dec04
00048	Gore	65474	Microwave Cable	20May04	20May05

Itronix Corporation	Model: IX260+	FCC ID:	KBCIX260PROGC82
Rugged Laptop PC with internal WLAN (802.11b/g) & Dual-Band GSM GPRS/EDGE Modem			
2004 Celltech Labs Inc	This document is not to be reproduced in whole or in part without the written permission of Celltech Labs Inc.		15 of 80

Test Report S/N:	052604-514KBC
Test Date(s):	28Jun04 - 29Jul04
Test Type:	FCC Part 15.247

B.5. MEASUREMENT EQUIPMENT SETUP	
Measurement Equipment Connections	The equipment was connected as shown in the setup drawing in B.6.
Measurement Equipment Settings	The following spectrum analyzer settings were use for these measurements: RBW – 100 kHz VBW – 300 kHz Span – 30 MHz

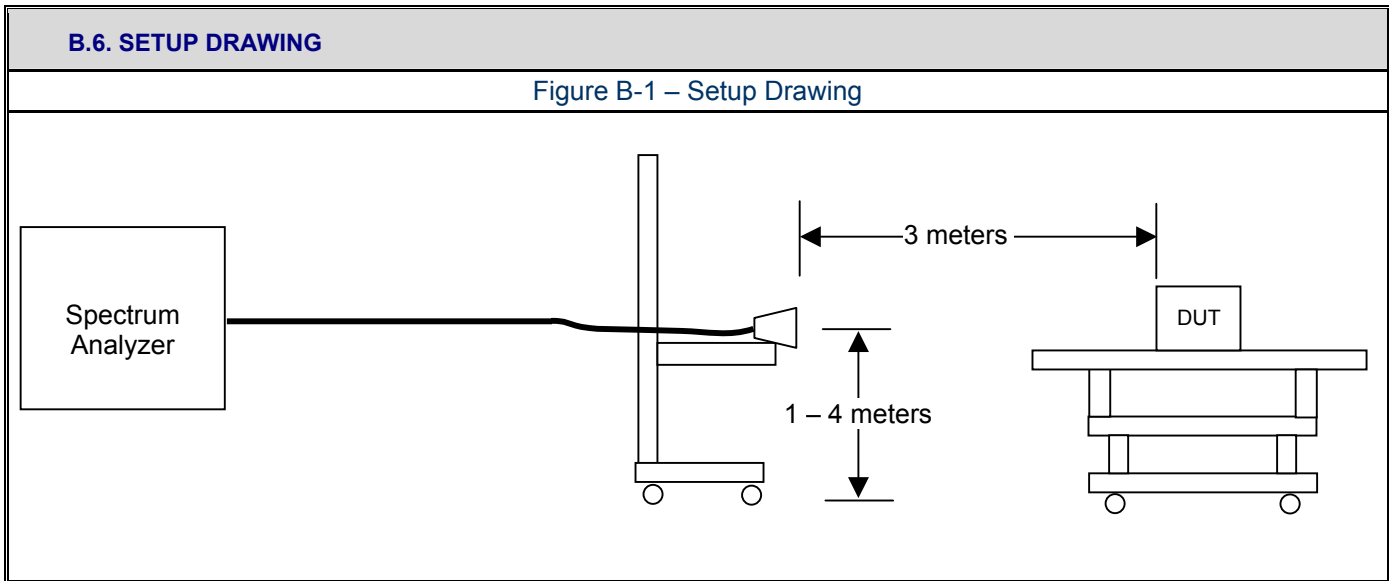

B.7. DUT OPERATING DESCRIPTION	
The worst-case data rate was determined from prescan investigations. Measurements were made at three channels throughout the band, Low Channel (2412 MHz), Mid Channel (2437 MHz), High Channel (2462 MHz) and for both Modes b and g.	

B.8. TEST RESULTS							
Channel	Frequency	802.11b			802.11g		
		6 dB Bandwidth	Limit	Data Rate	6 dB Bandwidth	Limit	Data Rate
	MHz	kHz	kHz	Mbps	kHz	kHz	Mbps
Low	2412	9127	>500	1	16444	>500	6
Mid	2437	9553	>500	1	16379	>500	6
High	2462	9169	>500	1	16402	>500	6

Itronix Corporation	Model: IX260+	FCC ID:	KBCIX260PROGC82
Rugged Laptop PC with internal WLAN (802.11b/g) & Dual-Band GSM GPRS/EDGE Modem			
2004 Celltech Labs Inc	This document is not to be reproduced in whole or in part without the written permission of Celltech Labs Inc.		16 of 80

Test Report S/N:	052604-514KBC
Test Date(s):	28Jun04 - 29Jul04
Test Type:	FCC Part 15.247

Plot B-1 - 6 dB Bandwidth Low Channel (802.11b)

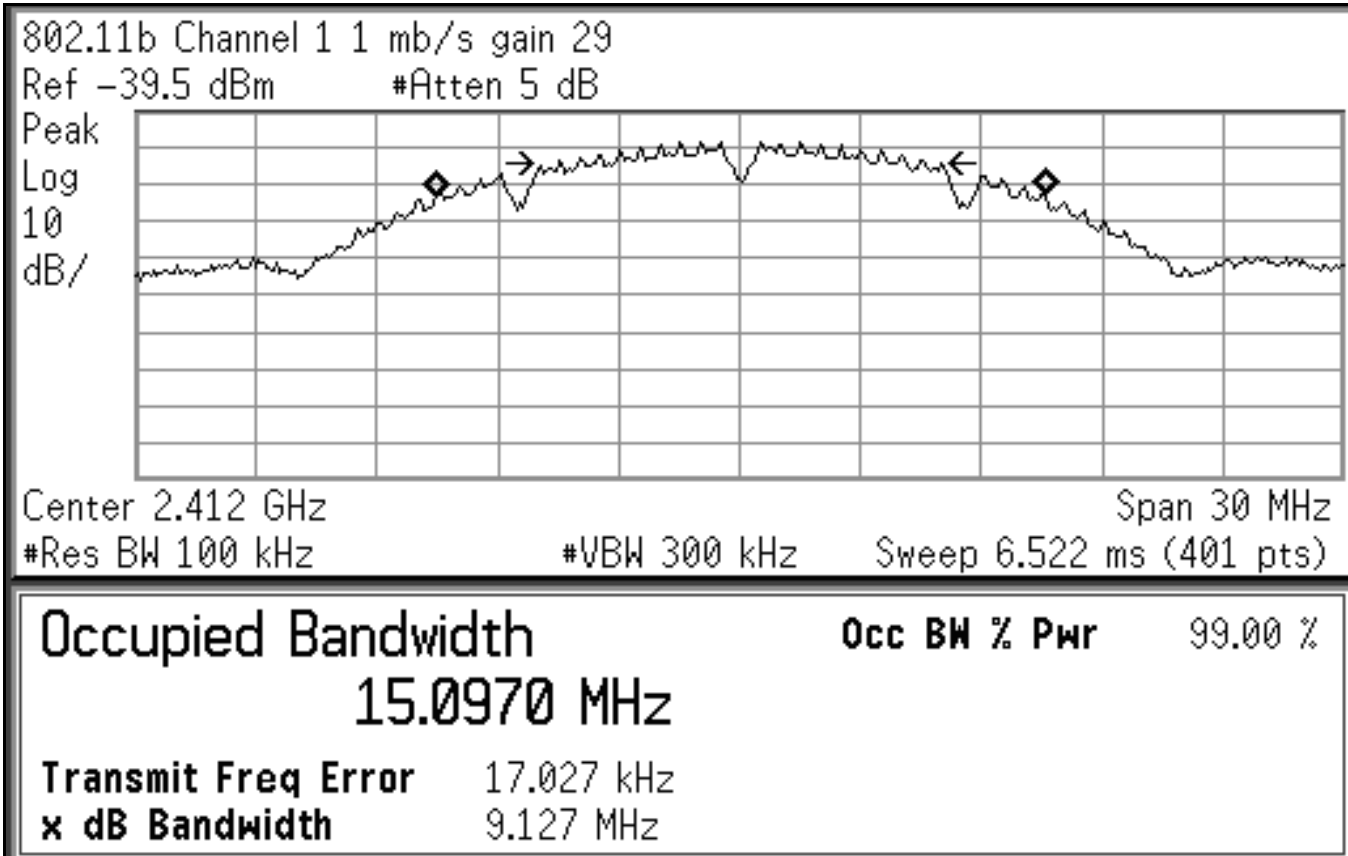

Test Report S/N:	052604-514KBC
Test Date(s):	28Jun04 - 29Jul04
Test Type:	FCC Part 15.247

Plot B-2 - 6 dB Bandwidth Mid Channel (802.11b)

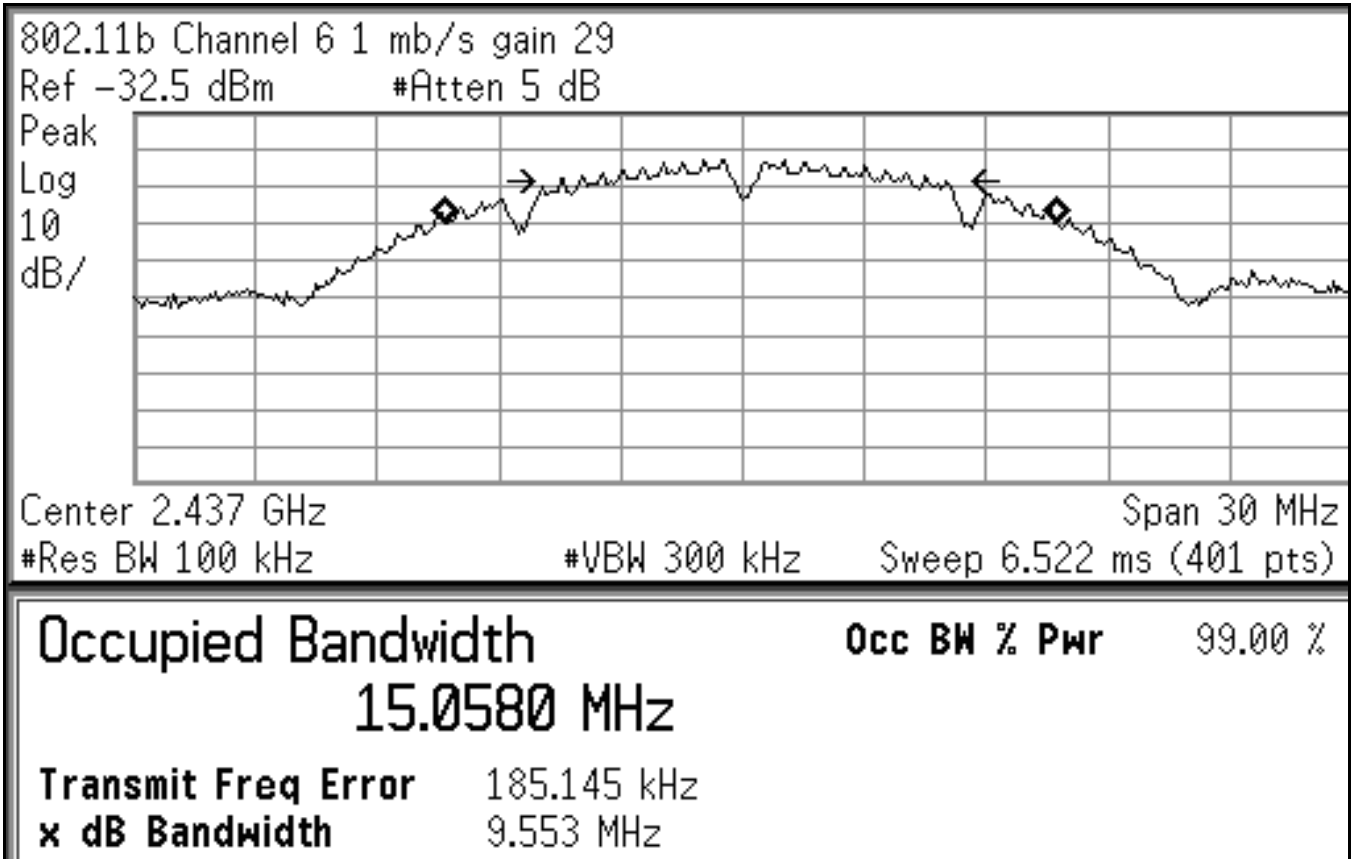

Test Report S/N:	052604-514KBC
Test Date(s):	28Jun04 - 29Jul04
Test Type:	FCC Part 15.247

Plot B-3 - 6 dB Bandwidth High Channel (802.11b)

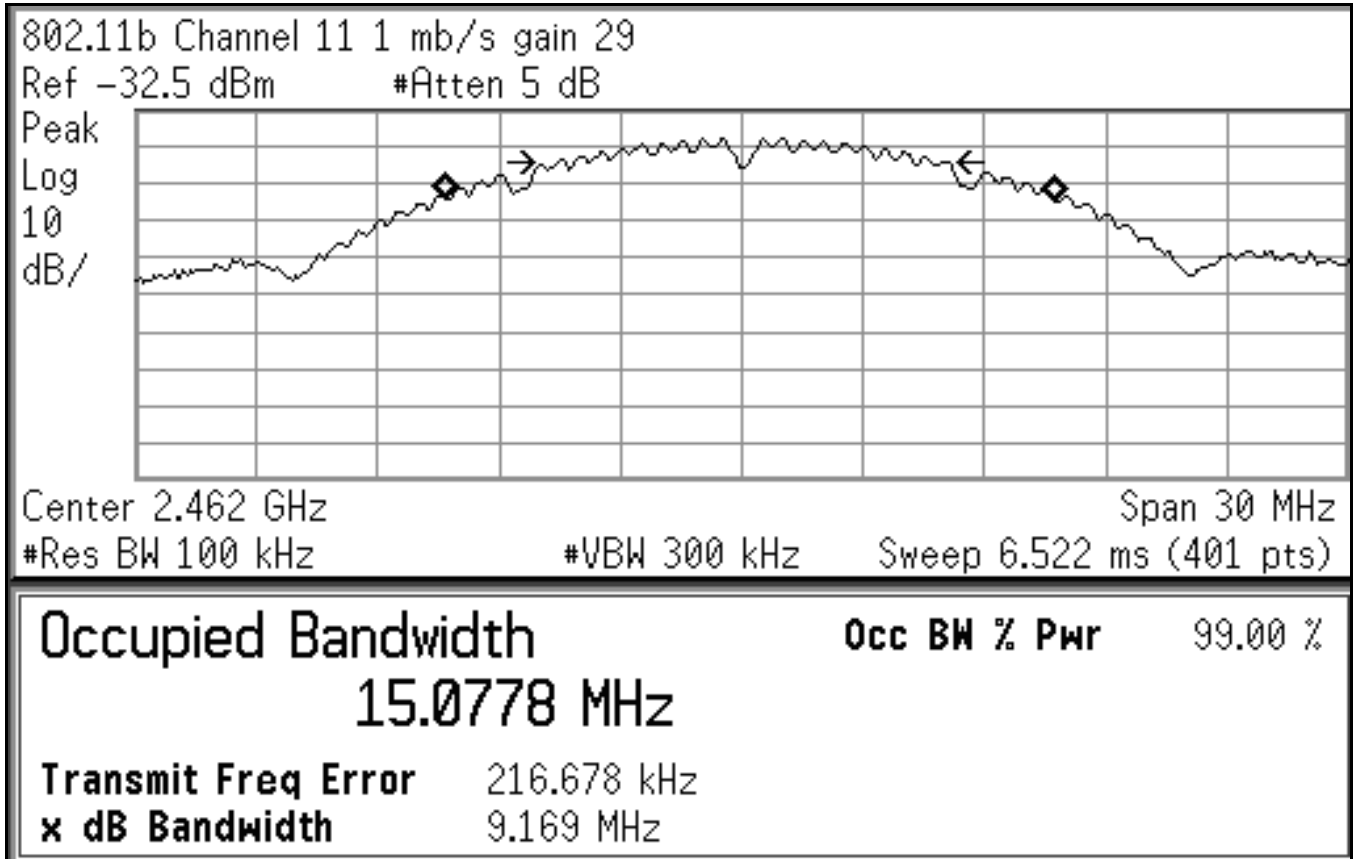

Test Report S/N:	052604-514KBC
Test Date(s):	28Jun04 - 29Jul04
Test Type:	FCC Part 15.247

Plot B-4 - 6 dB Bandwidth Low Channel (802.11g)

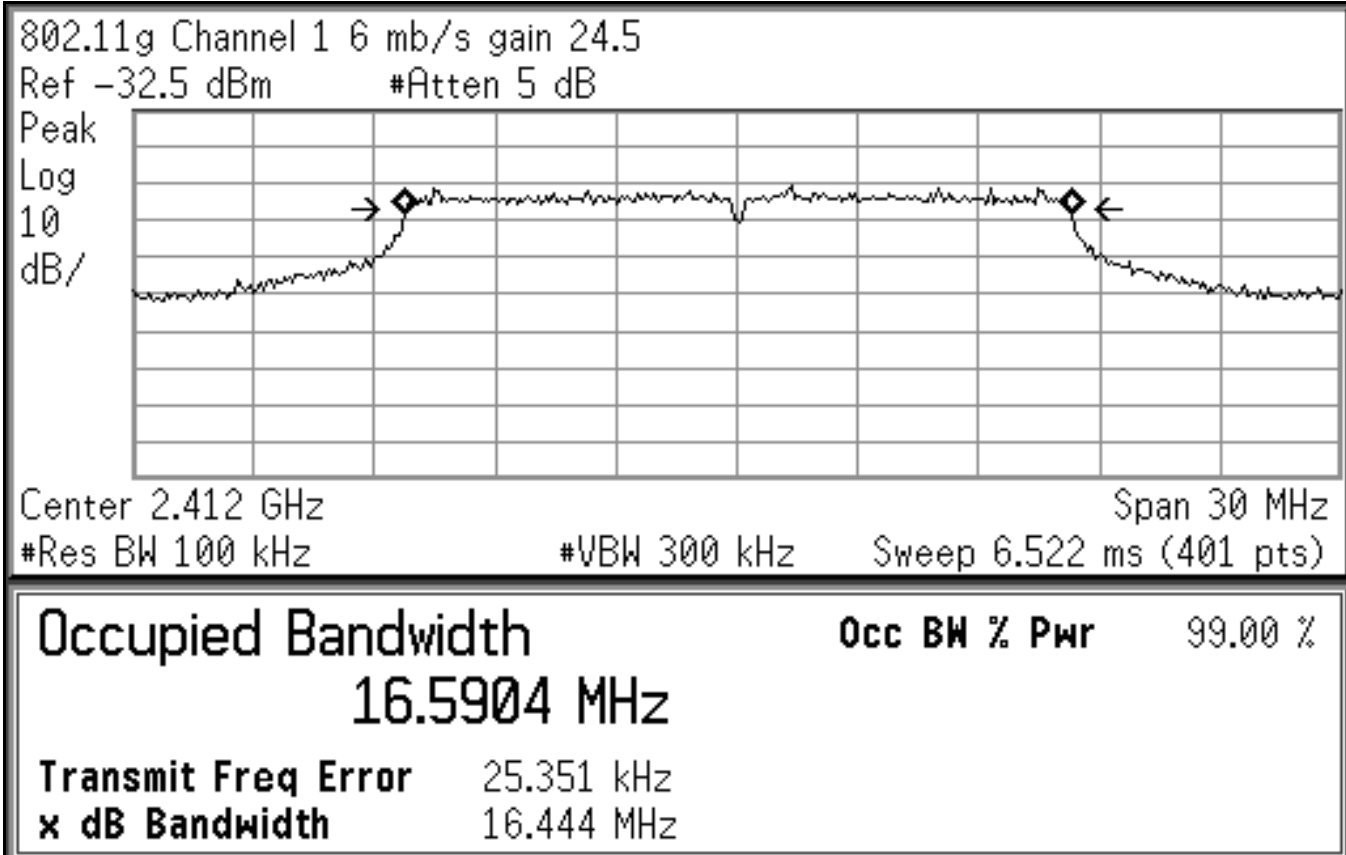

Test Report S/N:	052604-514KBC
Test Date(s):	28Jun04 - 29Jul04
Test Type:	FCC Part 15.247

Plot B-5 - 6 dB Bandwidth Mid Channel (802.11g)

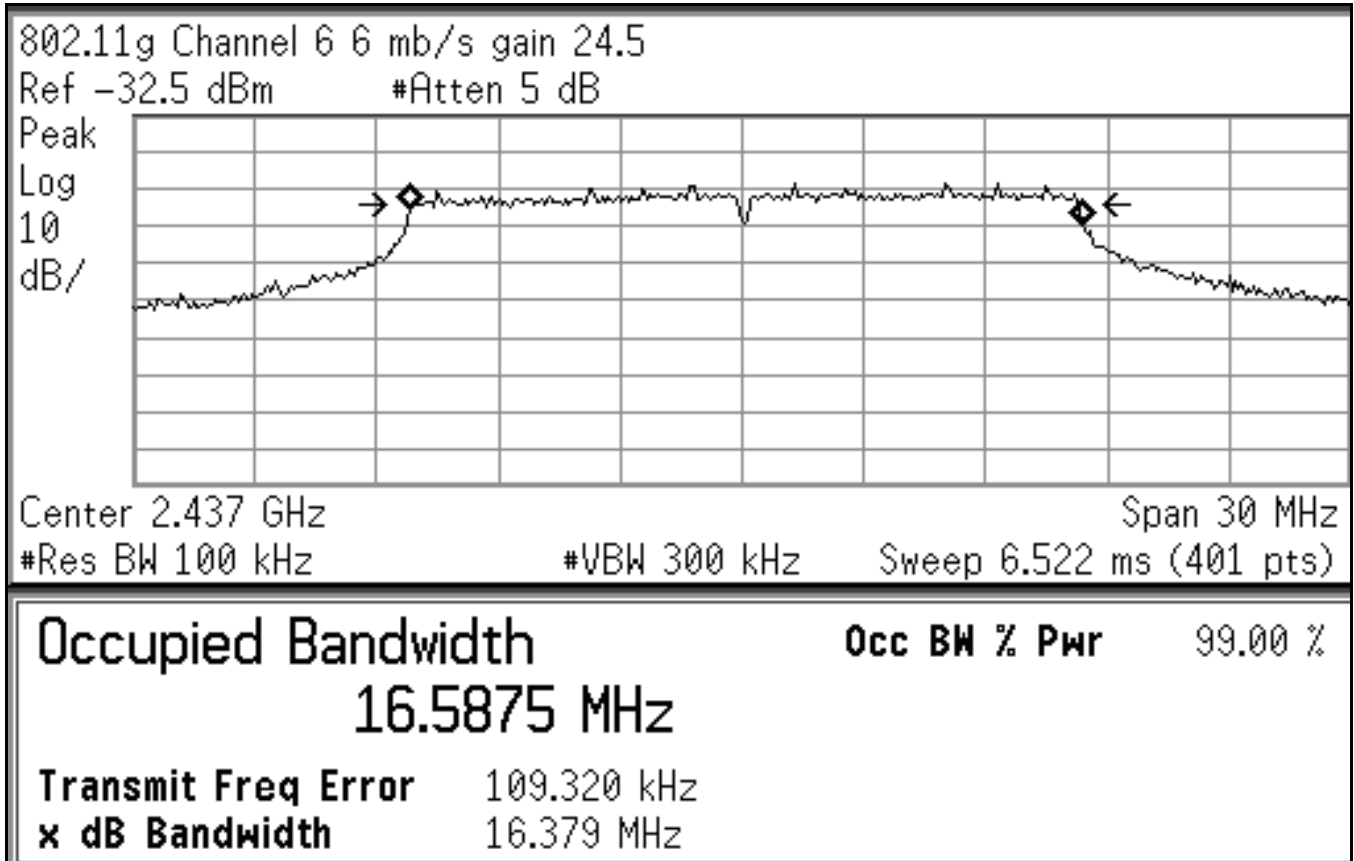

Test Report S/N:	052604-514KBC
Test Date(s):	28Jun04 - 29Jul04
Test Type:	FCC Part 15.247

Plot B-6 - 6 dB Bandwidth High Channel (802.11g)

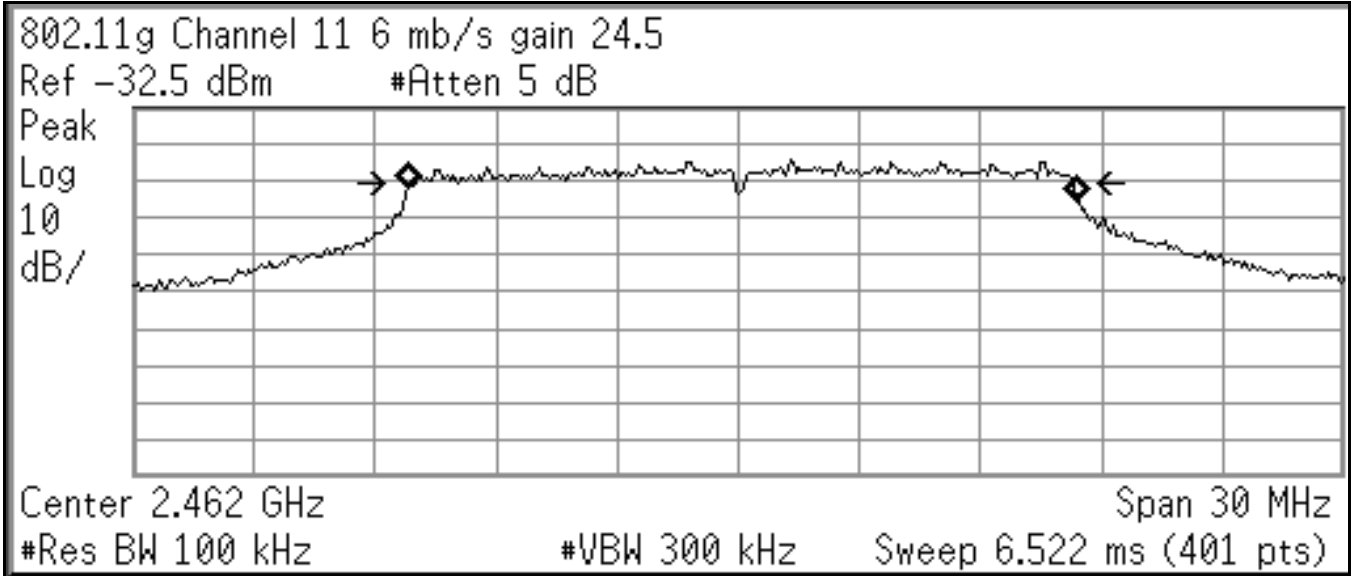

Occupied Bandwidth	Occ BW % Pwr	99.00 %
16.5917 MHz		
Transmit Freq Error	110.343 kHz	
x dB Bandwidth	16.402 MHz	

Test Report S/N:	052604-514KBC
Test Date(s):	28Jun04 - 29Jul04
Test Type:	FCC Part 15.247

B.9. PASS/FAIL

In reference to the results outlined in B.8 the DUT passes the requirements as stated in the reference standards as follows:
 FCC 15.247 (2): The 6 dB bandwidth as measured meets the minimum 500 kHz bandwidth requirement.

B.10. SIGN-OFF

I attest to the accuracy of the data. All measurements reported herein were performed by me and are correct to the best of my knowledge and belief. I assume full responsibility for the completeness of these measurements.

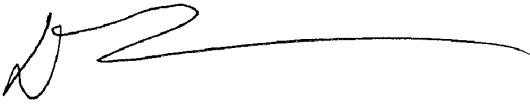

 Duane M. Friesen, C.E.T.
 EMC Manager
 Celltech Labs Inc.

 04Aug04
 Date

Test Report S/N:	052604-514KBC
Test Date(s):	28Jun04 - 29Jul04
Test Type:	FCC Part 15.247

Appendix C - Peak Conducted Power Measurement

C.1. REFERENCES	
Normative Reference Standard	FCC CFR 47 §15.247(b) (3)
Procedure Reference	FCC 97-114

C.2. LIMITS	
C.2.1. FCC CFR	
<p>§15.247(b): The maximum peak output power of the intentional radiator shall not exceed the following: §15.247(b) (3) For system using digital modulation in the 902 – 928 MHz, 2400 – 2483.5 MHz, and 5725 – 5850 MHz bands: 1 Watt.</p>	

C.3. ENVIRONMENTAL CONDITIONS	
Temperature	25.2 +/- 2 °C
Humidity	35 +/- 2 %
Barometric Pressure	96.34 kPa

C.4. EQUIPMENT LIST					
ASSET NUMBER	MANUFACTURER	MODEL	DESCRIPTION	LAST CAL	CAL DUE
00015	Agilent	E4408B	Spectrum Analyzer	29Dec03	29Dec04
00075	Alpha Wire-J	9223	2ft. RG223/U RF Cable	08Jul04*	24Jun05
00076	Pasternack	PE7014-30	30dB 2 Watt Attenuator	08Jul04*	24Jun05

*Cable and attenuator verified with power meter prior to use

C.5. MEASUREMENT EQUIPMENT SETUP	
Measurement Equipment Connections	The equipment was connected as shown in the setup drawing in C.6.
Measurement Equipment Settings	<p>To evaluate the maximum peak power, the 26 dB bandwidth needs to be determined. This is performed with the spectrum analyzer using the following setting:</p> <p>RBW – 300 kHz VBW – 1MHz Span – 50 MHz Detector – Peak Average – Power Trace Average – 100</p> <p>Once the 26 dB bandwidth is determined, the power is measured within the band with the following spectrum analyzer settings:</p> <p>RBW – 1 MHz VBW – 3 MHz Detector – Peak Average – Power Integrate BW – equal to specific –26 dB EBW</p>

Itronix Corporation	Model: IX260+	FCC ID:	KBCIX260PROGC82
Rugged Laptop PC with internal WLAN (802.11b/g) & Dual-Band GSM GPRS/EDGE Modem			
2004 Celltech Labs Inc	This document is not to be reproduced in whole or in part without the written permission of Celltech Labs Inc.		24 of 80

Test Report S/N:	052604-514KBC
Test Date(s):	28Jun04 - 29Jul04
Test Type:	FCC Part 15.247

C.6. SETUP DRAWING

Figure C-1 – Setup Drawing

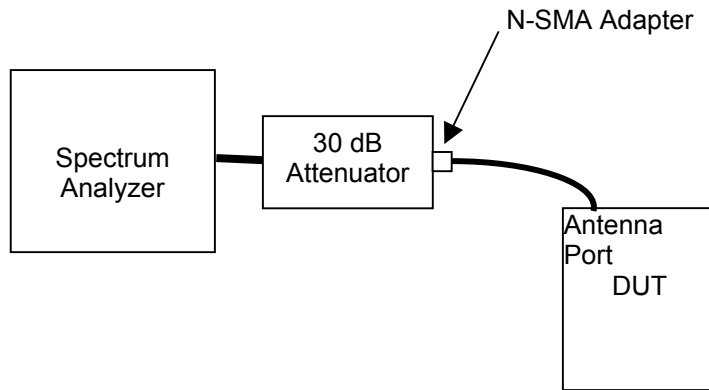

C.7. DUT OPERATING DESCRIPTION

The worst-case data rate was determined from prescan investigations. Measurements were made at three channels throughout the band, Low Channel (2412 MHz), Mid Channel (2437 MHz), High Channel (2462 MHz) and for both Modes b and g.

C.8. TEST RESULTS

Channel	Frequency	802.11b				802.11g			
		Peak Conducted Power		Limit	-26 dB EBW	Peak Conducted Power		Limit	-26 dB EBW
	MHz	dBm	Watts	Watts	MHz	dBm	Watts	Watts	MHz
Low	2412	16.28	.0424	1	19.53	15.14	.0327	1	23.55
Mid	2437	16.79	.0478	1	19.45	15.55	.0359	1	23.17
High	2462	17.48	.0560	1	19.43	16.15	.0412	1	23.05

Test Report S/N:	052604-514KBC
Test Date(s):	28Jun04 - 29Jul04
Test Type:	FCC Part 15.247

C.9. PASS/FAIL

In reference to the results outlined in C.8 the DUT passes the requirements as stated in the reference standards as follows:
 FCC 15.247 (b) (3): The peak power did not exceed 1 Watt.

C.10. SIGN-OFF

I attest to the accuracy of the data. All measurements reported herein were performed by me and are correct to the best of my knowledge and belief. I assume full responsibility for the completeness of these measurements.



 Russell Pipe
 Senior Compliance Technologist
 Celltech Labs Inc.

 04Aug04
 Date

Test Report S/N:	052604-514KBC
Test Date(s):	28Jun04 - 29Jul04
Test Type:	FCC Part 15.247

Appendix D - Maximum Permissible Exposure Calculation

D.1. REFERENCES	
Normative Reference Standard	FCC CFR 47§1.1310 IEEE Std C95.1-1992
Procedure Reference	FCC CFR 47§2.1091

D.2. LIMITS	
FCC CFR 47§1.1310 Table 1(b)	1.0 mW/cm ²

D.3. ENVIRONMENTAL CONDITIONS	
Temperature	na
Humidity	na
Barometric Pressure	na

D.4. EQUIPMENT LIST					
ASSET NUMBER	MANUFACTURER	MODEL	DESCRIPTION	LAST CAL	CAL DUE
na					

D.5. MEASUREMENT EQUIPMENT SETUP	
MEASUREMENT EQUIPMENT CONNECTIONS	The results described herein were determined by the following calculation, so no measurement equipment was used.
MEASUREMENT EQUIPMENT SETTINGS	na

D.6. SETUP PHOTOS	
na	

D.7. SETUP DRAWINGS	
na	

D.8. DUT OPERATING DESCRIPTION	
na	

Test Report S/N:	052604-514KBC
Test Date(s):	28Jun04 - 29Jul04
Test Type:	FCC Part 15.247

D.9. TEST RESULTS

Calculation:

Rangestar Internal Antenna (802.11b mode):

Tx Frequency: 2462.00 (MHz)
 Power at Antenna Input Terminal: 17.48 (dBm)
 Antenna gain: 4.50 (dBi)

S = 1.00 (mW/cm²)
 P = 55.9758 (mW)
 G = 2.82 (numeric)

R = 3.54 (cm)

S (mw/cm²) at 20cm = 0.031351575

Rangestar Internal Antenna (802.11g mode):

Tx Frequency: 2462.00 (MHz)
 Power at Antenna Input Terminal: 16.15 (dBm)
 Antenna gain: 4.50 (dBi)

S = 1.00 (mW/cm²)
 P = 41.2098 (mW)
 G = 2.82 (numeric)

R = 3.04 (cm)

S (mw/cm²) at 20cm = 0.023081252

Formulae:

$$S = \frac{PG}{4\pi R^2}$$

$$R = \sqrt{\frac{P}{4\pi S}}$$

where: S = Power Density Limit
 P = Power Applied to the Antenna
 G = Numeric Antenna Gain
 R = Distance from Antenna

Results:

Mode	Power Density Limit	Output Power	Antenna Gain	MPE Distance
	mW/cm ²	dBm	dBi	cm
802.11b	1.0	17.48	4.5	3.54
802.11g	1.0	16.15	4.5	3.04

NOTE: The required minimum separation distance is 20 cm, even if the resulting MPE compliance distance is less.

Test Report S/N:	052604-514KBC
Test Date(s):	28Jun04 - 29Jul04
Test Type:	FCC Part 15.247

D.10. PASS/FAIL

In reference to the results outlined in D.9 the DUT passes the requirements as stated in the reference standards as follows:
 1) The DUT spacing must be kept at 20 cm to insure an exposure not more than 1 mW/cm².

D.11. SIGN-OFF

I attest to the accuracy of the data. All measurements reported herein were performed by me and are correct to the best of my knowledge and belief. I assume full responsibility for the completeness of these measurements.



 Russell Pipe
 Senior Compliance Technologist
 Celltech Labs Inc.

 04Aug04

Date

Test Report S/N:	052604-514KBC
Test Date(s):	28Jun04 - 29Jul04
Test Type:	FCC Part 15.247

Appendix E - Radiated Spurious Emissions Measurement

E.1. REFERENCES	
Normative Reference Standard	FCC CFR 47 §15.247(c)
Procedure Reference	ANSI C63.4; FCC 97-114

E.2. LIMITS	
E.2.1. FCC CFR 47	
<p>§15.247 (c): <i>In any 100 kHz bandwidth outside the frequency band in which the spread spectrum or digitally modulated intentional radiator is operating, the radio frequency power that is produced by the intentional radiator shall be at least 20 dB below that in the 100 kHz bandwidth within the band that contains the highest level of desired power, based on either an RF conducted or a radiated measurement. Attenuation below the general limits specified in 15.209 (a) is not required.</i></p>	
<p>Note: Spurious emissions within the restricted bands are reported in Appendix F.</p>	

E.3. ENVIRONMENTAL CONDITIONS	
Temperature	27.4 +/- 2 °C
Humidity	33 +/- 2 %
Barometric Pressure	96.24 +/- 0.2 kPa

E.4. EQUIPMENT LIST					
ASSET NUMBER	MANUFACTURER	MODEL	DESCRIPTION	LAST CAL	CAL DUE
00072	EMCO	2075	Mini-mast	n/a	n/a
00073	EMCO	2080	Turntable	n/a	n/a
00071	EMCO	2090	Multi-Device Controller	n/a	n/a
00050	Chase	CBL-6111A	Bilog Antenna	30Apr04	30Apr05
00035	ETS	3115	Double Ridged Guide Horn	24Mar04	24Mar05
00202	ETS	3160-09	Small Horn Antenna	27May04	27Jun05
00015	Agilent	E4408B	Spectrum Analyzer	29Dec03	29Dec04
00049	HP	8566B	Spectrum Analyzer RF Section	18May04	18May05
00049	HP	85650A	Quasi-peak Adapter	18May04	18May05
00047	HP	85685A	RF Preselector	18May04	18May05
00048	Gore	65474	Microwave Cable	20May04	20May05
00030	HP	83017A	LNA	20May04	20May05

Itronix Corporation	Model: IX260+	FCC ID:	KBCIX260PROGC82
Rugged Laptop PC with internal WLAN (802.11b/g) & Dual-Band GSM GPRS/EDGE Modem			
2004 Celltech Labs Inc	This document is not to be reproduced in whole or in part without the written permission of Celltech Labs Inc.		30 of 80

Test Report S/N:	052604-514KBC
Test Date(s):	28Jun04 - 29Jul04
Test Type:	FCC Part 15.247

E.5. MEASUREMENT EQUIPMENT SETUP				
MEASUREMENT EQUIPMENT CONNECTIONS	The measurement equipment was connected as shown in the E.6. A number of antennas were used to cover the applicable frequency range test. The ranges in which each antenna was used are as follows:			
	Frequency Range	Antenna		
	30 MHz – 1 GHz	CBL-6111A Bilog		
	1 GHz – 18 GHz	ETS 3115 Horn		
	18 GHz– 26GHz	ETS 3160-09 Horn		
MEASUREMENT EQUIPMENT SETTINGS	The spectrum analyzer was set to the following settings:			
	Frequency Range	RBW	VBW	Detector
	MHz	kHz	kHz	
	30 – 1000	100	300	Peak*
	> 1000	1000*	1000	Peak*
*As a worse case measurement, the average limit was applied to measurements made with a peak detector using a RBW of 1 MHz (vs the specified 100 kHz), when possible.				

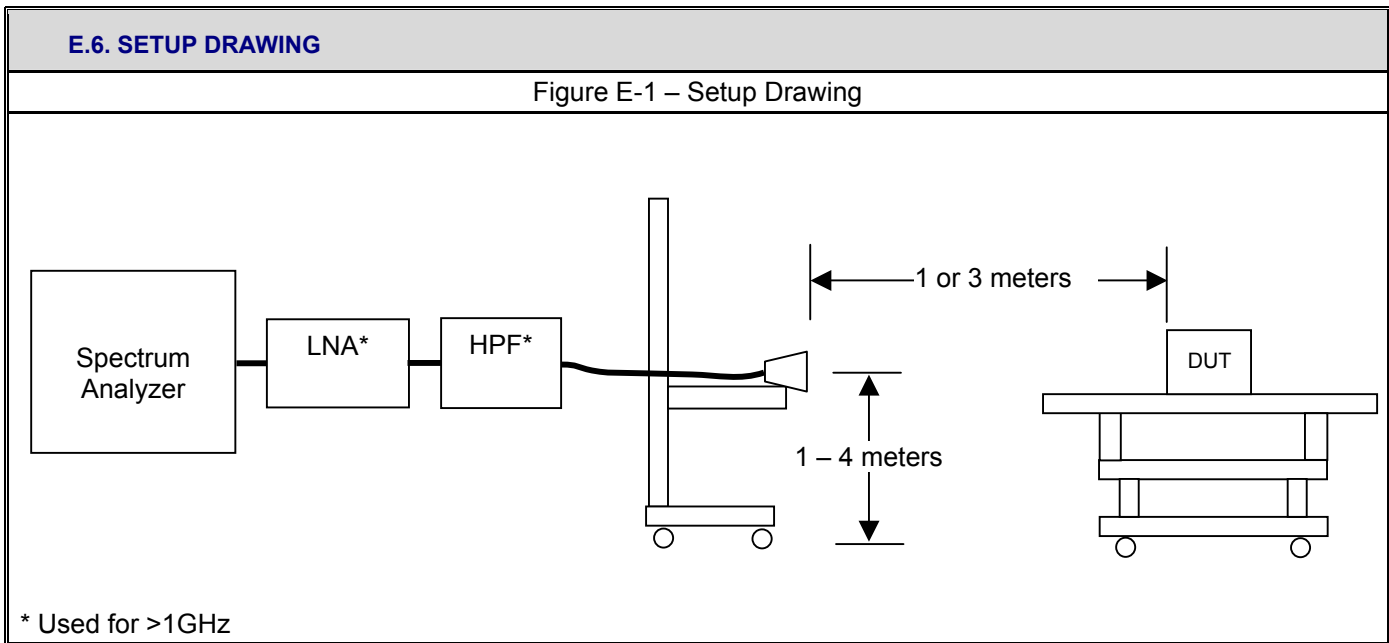

Test Report S/N:	052604-514KBC
Test Date(s):	28Jun04 - 29Jul04
Test Type:	FCC Part 15.247

E.7. SETUP PHOTOGRAPHS

Photograph E-1 - Horizontal Polarization (30MHz – 1 GHz)



Photograph E-2 - Vertical Polarization (30MHz – 1 GHz)



Photograph E-3 - Front of Radiated Emission Configuration



Photograph E-4 - Back of Radiated Emission Configuration

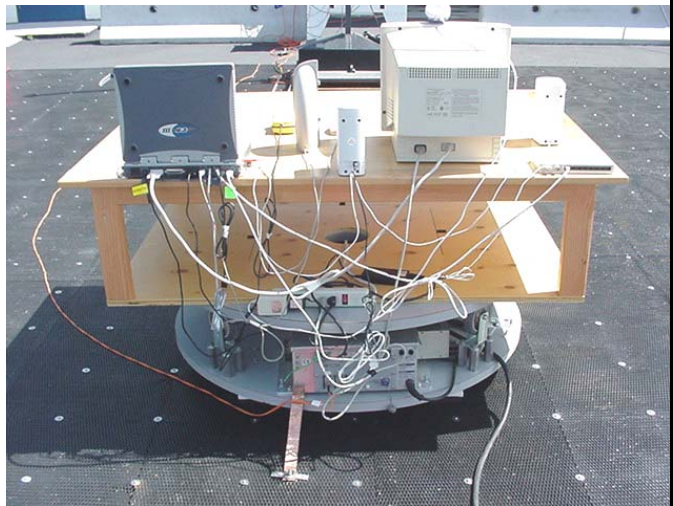

Itronix Corporation

Model: IX260+

FCC ID:

KBCIX260PROGC82

Rugged Laptop PC with internal WLAN (802.11b/g) & Dual-Band GSM GPRS/EDGE Modem

Test Report S/N:	052604-514KBC
Test Date(s):	28Jun04 - 29Jul04
Test Type:	FCC Part 15.247

E.8. DUT OPERATING DESCRIPTION

The worst-case data rate was determined from prescan investigations. Measurements were made at three channels throughout the band, Low Channel (2412 MHz), Mid Channel (2437 MHz), High Channel (2462 MHz) and for both Modes b and g for the band-edge measurements and for Mode b for the remaining measurements. The configuration used was Mode b, 1 mbps with a gain setting of 29 and Mode g, 6 mbps with a gain setting of 24.5.

E.9. TEST RESULTS

E.9.1. Mode b - Fundamental Field Strengths @ Specified Distance – Horizontal Polarization

Channel	Polarity	Measurement Distance	Antenna	Frequency	SA Level	Noise Floor	Antenna Factor	Cable Factor	Other Factors	Total CF	Field Strength	Detector	Limit Distance	Limit Distance Correction	*Calculated Limit
													m	dB	dBuV/m
1	H	3	Horn SN6276	2412.00	70.11		28.11	3.49	0.00	31.59	101.70	PK	3	0.00	81.70
6	H	3	Horn SN6276	2437.00	70.00		28.16	3.51	0.00	31.67	101.67	PK	3	0.00	81.67
11	H	3	Horn SN6276	2462.00	70.50		28.22	3.52	0.00	31.73	102.23	PK	3	0.00	82.23

E.9.2. Mode b - Fundamental Field Strengths @ Specified Distance – Vertical Polarization

1	V	3	Horn SN6276	2412.00	64.50		28.11	3.49	0.00	31.59	96.09	PK	3	0.00	76.09
6	V	3	Horn SN6276	2437.00	63.70		28.16	3.51	0.00	31.67	95.37	PK	3	0.00	75.37
11	V	3	Horn SN6276	2462.00	64.91		28.22	3.52	0.00	31.73	96.64	PK	3	0.00	76.64

Formulae:

Total CF = Antenna Factor + Cable Factor + Other Factor (Amplifier Gain, filter loss, etc)

Field Strength = SA Reading + Total CF

Limit Distance Correction = $40 \cdot \log(d1/d2)$ for $F < 30$ MHz, $20 \cdot \log(d1/d2)$ for $F > 30$ MHz :
where d1 is the measurement distance

Limit = Specified Limit + Limit Distance Correction

Margin = Limit - Field Strength

Calculated Limit (-20 dBc) = Field Strength -20

*Calculated Limit used for spurious emission evaluation

Test Report S/N:	052604-514KBC
Test Date(s):	28Jun04 - 29Jul04
Test Type:	FCC Part 15.247

E.9.3. Mode b - Band-edge Emission Field Strengths @ Specified Distance – Horizontal Polarization (not near restricted band)																	
Channel	Polarity	Measurement Distance	Antenna	Frequency	SA Level	Noise Floor	Antenna Factor	Cable Factor	Other Factors	Total CF	Field Strength	Detector	Limit Distance	Limit Distance Correction	-20 dBc Limit	Margin	Pass/Fail
													m	dB	dB	dBuV/m	Δ dB
1	H	3	Horn SN6276	2400.00	30.60		28.08	3.48	0.00	31.56	62.16	PK	3.00	0.00	81.70	19.54	PASS
1	H	3	Horn SN6276	2400.00	20.30		28.08	3.48	0.00	31.56	51.86	AV	3.00	0.00	81.70	29.84	PASS

E.9.4. Mode b - Band-edge Emission Field Strengths @ Specified Distance - Vertical Polarization (not near restricted band)																	
1	V	3	Horn SN6276	2400.00	27.60		28.08	3.48	0.00	31.56	59.16	PK	3.00	0.00	76.09	16.93	PASS
1	V	3	Horn SN6276	2400.00	18.70		28.08	3.48	0.00	31.56	50.26	AV	3.00	0.00	76.09	25.83	PASS

Formulae:
 Total CF = Antenna Factor + Cable Factor + Other Factor (Amplifier Gain, filter loss, etc)
 Field Strength = SA Reading + Total CF
 Limit Distance Correction = 40*log(d1/d2) for F<30 MHz, 20*log(d1/d2) for F> 30 MHz:
 where d1 is the measurement distance, d2 is the published limit distance
 Limit = Specified Limit + Limit Distance Correction
 Margin = Limit - Field Strength

E.9.5. Mode g - Band-edge Emission Field Strengths @ Specified Distance – Horizontal Polarization (not near restricted band)																	
Channel	Polarity	Measurement Distance	Antenna	Frequency	SA Level*	Noise Floor	Antenna Factor	Cable Factor	Other Factors	Total CF	Field Strength	Detector	Limit Distance	Limit Distance Correction	-20 dBc Limit	Margin	Pass/Fail
													m	dB	dB	dBuV/m	Δ dB
1	H	3	Horn SN6276	2400.00	89.24		28.08	7.66	-37.38	-1.64	87.6	PK	3.00	0.00	88.4	0.8	PASS
1	H	3	Horn SN6276	2400.00	66.04		28.08	7.66	-37.38	-1.64	64.4	AV	3.00	0.00	88.4	24.0	PASS

E.9.6. Mode b - Band-edge Emission Field Strengths @ Specified Distance - Vertical Polarization (not near restricted band)																	
1	V	3	Horn SN6276	2400.00	82.84		28.08	7.66	-37.38	-1.64	81.20	PK	3.00	0.00	82.6	1.4	PASS
1	V	3	Horn SN6276	2400.00	63.54		28.08	7.66	-37.38	-1.64	61.9	AV	3.00	0.00	82.6	20.7	PASS

Formulae:
 Total CF = Antenna Factor + Cable Factor + Other Factor (Amplifier Gain, filter loss, etc)
 Field Strength = SA Reading + Total CF
 Limit Distance Correction = 40*log(d1/d2) for F<30 MHz, 20*log(d1/d2) for F> 30 MHz:
 where d1 is the measurement distance, d2 is the published limit distance
 Limit = Specified Limit + Limit Distance Correction
 Margin = Limit - Field Strength

*Measurements made with a worse case gain setting of 29

Test Report S/N:	052604-514KBC
Test Date(s):	28Jun04 - 29Jul04
Test Type:	FCC Part 15.247

E.9.7. Channel 1 Harmonic Emission Field Strengths @ Specified Distance – Horizontal Polarization

Channel	Polarity	Measurement Distance	Antenna	Frequency	SA Level	Noise Floor	Antenna Factor	Cable Factor	Other Factors	Total CF	Field Strength	Detector	Limit Distance	Limit Distance Correction	-20 dBc Limit	Margin	Pass/Fail
1	H	3	Horn SN6276	1000.00	53.90		24.30	2.21	-10.66	15.85	69.75	PK	3.00	0.00	81.70	11.95	PASS
1	H	3	Horn SN6276	2500.00	42.60		28.30	3.51	-36.42	-4.61	37.99	PK	3.00	0.00	81.70	43.71	PASS
1	H	3	Horn SN6276	17660.00	38.00		44.88	10.46	-36.36	18.98	56.98	PK	3.00	0.00	81.70	24.72	PASS
1	H	1	3160-09	19296.00	52.98		40.26	11.01	-35.81	15.45	68.43	PK	3.00	9.54	91.24	22.81	PASS
1	H	1	3160-09	19296.00	34.05	x	40.26	11.01	-35.81	15.45	49.50	AV	3.00	9.54	91.24	41.74	PASS
1	H	1	3160-09	21708.00	53.65	x	40.30	11.91	-35.73	16.48	70.13	PK	3.00	9.54	91.24	21.11	PASS
1	H	1	3160-09	21708.00	35.74	x	40.30	11.91	-35.73	16.48	52.22	AV	3.00	9.54	91.24	39.02	PASS
1	H	1	3160-09	24120.00	56.09		40.40	12.81	-35.73	17.48	73.57	PK	3.00	9.54	91.24	17.67	PASS
1	H	1	3160-09	24120.00	37.57		40.40	12.81	-35.73	17.48	55.05	AV	3.00	9.54	91.24	36.19	PASS
1	H	1	3160-09	24490.00	57.15	x	40.40	12.95	-35.73	17.62	74.77	PK	3.00	9.54	91.24	16.47	PASS

E.9.8. Channel 1 Harmonic Emission Field Strengths @ Specified Distance - Vertical Polarization

1	V	3	Horn SN6276	4810.00	47.00	x	32.88	4.96	-35.30	2.54	49.54	PK	3.00	0.00	76.09	26.55	PASS
1	V	3	Horn SN6276	9610.00	36.60		37.59	7.37	-35.71	9.25	45.85	AV	3.00	0.00	76.09	30.24	PASS
1	V	1	Horn SN6276	17770.00	37.60		45.70	10.30	-36.35	19.65	57.25	PK	3.00	9.54	85.63	28.39	PASS
1	V	1	3160-09	18820.00	53.92	x	40.20	11.05	-35.87	15.38	69.30	PK	3.00	9.54	85.63	16.33	PASS
1	V	1	3160-09	18820.00	33.66	x	40.20	11.05	-35.87	15.38	49.04	AV	3.00	9.54	85.63	36.59	PASS
1	V	1	3160-09	19296.00	52.65		40.26	11.01	-35.81	15.45	68.10	PK	3.00	9.54	85.63	17.53	PASS
1	V	1	3160-09	19296.00	33.76		40.26	11.01	-35.81	15.45	49.21	AV	3.00	9.54	85.63	36.42	PASS
1	V	1	3160-09	21708.00	53.27		40.30	11.91	-35.73	16.48	69.75	PK	3.00	9.54	85.63	15.88	PASS
1	V	1	3160-09	21708.00	36.04		40.30	11.91	-35.73	16.48	52.52	AV	3.00	9.54	85.63	33.11	PASS
1	V	1	3160-09	24120.00	56.03		40.40	12.81	-35.73	17.48	73.51	PK	3.00	9.54	85.63	12.12	PASS
1	V	1	3160-09	24120.00	37.21		40.40	12.81	-35.73	17.48	54.69	AV	3.00	9.54	85.63	30.94	PASS
1	V	1	3160-09	24550.00	56.31	x	40.40	12.97	-35.73	17.64	73.95	PK	3.00	9.54	85.63	11.68	PASS
1	V	1	3160-09	24550.00	38.30	x	40.40	12.97	-35.73	17.64	55.94	AV	3.00	9.54	85.63	29.69	PASS

Formulae:

Total CF = Antenna Factor + Cable Factor + Other Factor (Amplifier Gain, filter loss, etc)

Field Strength = SA Reading + Total CF

Limit Distance Correction = 40*log(d1/d2) for F<30 MHz, 20*log(d1/d2) for F> 30 MHz:

where d1 is the measurement distance, d2 is the published limit distance

Limit = Specified Limit + Limit Distance Correction

Margin = Limit - Field Strength

*No harmonic emission where measured above the field strengths noted

Itronix Corporation

Model: IX260+

FCC ID:

KBCIX260PROGC82

Rugged Laptop PC with internal WLAN (802.11b/g) & Dual-Band GSM GPRS/EDGE Modem

Test Report S/N:	052604-514KBC
Test Date(s):	28Jun04 - 29Jul04
Test Type:	FCC Part 15.247

E.9.9. Channel 6 Harmonic Emission Field Strengths @ Specified Distance – Horizontal Polarization

Channel	Polarity	Measurement Distance	Antenna	Frequency	SA Level	Noise Floor	Antenna Factor	Cable Factor	Other Factors	Total CF	Field Strength	Detector	Limit Distance	Limit Distance Correction	-20 dBc Limit	Margin	Pass/Fail
													m	dB	dB	dBuV/m	
6	H	3	Horn SN6276	5260.00	45.20	x	33.72	5.23	-35.47	3.47	48.67	PK	3.00	0.00	81.67	33.00	PASS
6	H	3	Horn SN6276	8360.00	42.30		37.06	6.79	-35.62	8.24	50.54	AV	3.00	0.00	81.67	31.13	PASS
6	H	3	Horn SN6276	17090.00	39.20		41.24	10.38	-36.09	15.54	54.74	PK	3.00	0.00	81.67	26.93	PASS
6	H	1	3160-09	19496.00	52.56		40.30	11.28	-35.79	15.79	68.35	PK	3.00	9.54	91.21	22.86	PASS
6	H	1	3160-09	19496.00	33.91		40.30	11.28	-35.79	15.79	49.70	AV	3.00	9.54	91.21	41.51	PASS
6	H	1	3160-09	21240.00	54.98	x	40.30	11.73	-35.73	16.31	71.29	PK	3.00	9.54	91.21	19.93	PASS
6	H	1	3160-09	21240.00	35.72	x	40.30	11.73	-35.73	16.31	52.03	AV	3.00	9.54	91.21	39.19	PASS
6	H	1	3160-09	21933.00	54.66		40.30	11.99	-35.73	16.57	71.23	PK	3.00	9.54	91.21	19.99	PASS
6	H	1	3160-09	21933.00	36.27		40.30	11.99	-35.73	16.57	52.84	AV	3.00	9.54	91.21	38.38	PASS
6	H	1	3160-09	24370.00	57.10		40.40	12.90	-35.73	17.58	74.68	PK	3.00	9.54	91.21	16.54	PASS
6	H	1	3160-09	24370.00	37.88		40.40	12.90	-35.73	17.58	55.46	AV	3.00	9.54	91.21	35.76	PASS
6	H	1	3160-09	24420.00	56.93	x	40.40	12.92	-35.73	17.60	74.53	PK	3.00	9.54	91.21	16.69	PASS
6	H	1	3160-09	24420.00	37.73	x	40.40	12.92	-35.73	17.60	55.33	AV	3.00	9.54	91.21	35.89	PASS

Formulae:

Total CF = Antenna Factor + Cable Factor + Other Factor (Amplifier Gain, filter loss, etc)

Field Strength = SA Reading + Total CF

Limit Distance Correction = $40 \cdot \log(d1/d2)$ for $F < 30$ MHz, $20 \cdot \log(d1/d2)$ for $F > 30$ MHz:

where d1 is the measurement distance, d2 is the published limit distance

Limit = Specified Limit + Limit Distance Correction

Margin = Limit - Field Strength

*No harmonic emission where measured above the field strengths noted

Test Report S/N:	052604-514KBC
Test Date(s):	28Jun04 - 29Jul04
Test Type:	FCC Part 15.247

E.9.10. Channel 6 Harmonic Emission Field Strengths @ Specified Distance - Vertical Polarization

Channel	Polarity	Measurement Distance	Antenna	Frequency	SA Level	Noise Floor	Antenna Factor	Cable Factor	Other Factors	Total CF	Field Strength	Detector	Limit Distance	Limit Distance Correction	-20 dBc Limit	Margin	Pass/Fail
													m	dB	dB	dBuV/m	
6	V	3	Horn SN6276	5770.00	40.10	x	34.21	5.45	-35.50	4.16	44.26	PK	3.00	0.00	75.37	31.11	PASS
6	V	3	Horn SN6276	9720.00	36.80		37.68	7.34	-35.71	9.31	46.11	PK	3.00	0.00	75.37	29.26	PASS
6	V	1	Horn SN6276	16480.00	38.30		38.45	10.25	-36.46	12.24	50.54	PK	3.00	9.54	84.91	34.37	PASS
6	V	1	3160-09	19190.00	54.26	x	40.24	10.91	-35.83	15.32	69.58	PK	3.00	9.54	84.91	15.33	PASS
6	V	1	3160-09	19190.00	33.78	x	40.24	10.91	-35.83	15.32	49.10	AV	3.00	9.54	84.91	35.81	PASS
6	V	1	3160-09	19496.00	52.89		40.30	11.28	-35.79	15.79	68.68	PK	3.00	9.54	84.91	16.23	PASS
6	V	1	3160-09	19496.00	33.88		40.30	11.28	-35.79	15.79	49.67	AV	3.00	9.54	84.91	35.24	PASS
6	V	1	3160-09	21933.00	53.99		40.30	11.99	-35.73	16.57	70.56	PK	3.00	9.54	84.91	14.36	PASS
6	V	1	3160-09	21933.00	36.23		40.30	11.99	-35.73	16.57	52.80	AV	3.00	9.54	84.91	32.12	PASS
6	V	1	3160-09	24370.00	55.56		40.40	12.90	-35.73	17.58	73.14	PK	3.00	9.54	84.91	11.78	PASS
6	V	1	3160-09	24370.00	37.88		40.40	12.90	-35.73	17.58	55.46	AV	3.00	9.54	84.91	29.46	PASS
6	V	1	3160-09	24400.00	56.66	x	40.40	12.91	-35.73	17.59	74.25	PK	3.00	9.54	84.91	10.66	PASS
6	V	1	3160-09	24400.00	37.87	x	40.40	12.91	-35.73	17.59	55.46	AV	3.00	9.54	84.91	29.45	PASS

Formulae:

Total CF = Antenna Factor + Cable Factor + Other Factor (Amplifier Gain, filter loss, etc)

Field Strength = SA Reading + Total CF

Limit Distance Correction = 40*log(d1/d2) for F<30 MHz, 20*log(d1/d2) for F> 30 MHz:

where d1 is the measurement distance, d2 is the published limit distance

Limit = Specified Limit + Limit Distance Correction

Margin = Limit - Field Strength

*No harmonic emission where measured above the field strengths noted

Test Report S/N:	052604-514KBC
Test Date(s):	28Jun04 - 29Jul04
Test Type:	FCC Part 15.247

E.9.11. Channel 11 Harmonic Emission Field Strengths @ Specified Distance – Horizontal Polarization

Channel	Polarity	Measurement Distance	Antenna	Frequency	SA Level	Noise Floor	Antenna Factor	Cable Factor	Other Factors	Total CF	Field Strength	Detector	Limit Distance	Limit Distance Correction	-20 dBc Limit	Margin	Pass/Fail
													m	dB	dB	dBuV/m	
11	H	3	Horn SN6276	5260.00	45.80	x	33.72	5.23	-35.47	3.47	49.27	PK	3.00	0.00	82.23	32.96	PASS
11	H	3	Horn SN6276	8360.00	42.10		37.06	6.79	-35.62	8.24	50.34	PK	3.00	0.00	82.23	31.89	PASS
11	H	1	Horn SN6276	15920.00	38.90		37.38	9.83	-36.23	10.98	49.88	PK	3.00	9.54	91.77	41.89	PASS
11	H	1	3160-09	18810.00	53.72	x	40.20	11.15	-35.87	15.48	69.20	PK	3.00	9.54	91.77	22.58	PASS
11	H	1	3160-09	18810.00	33.94	x	40.20	11.15	-35.87	15.48	49.42	AV	3.00	9.54	91.77	42.36	PASS
11	H	1	3160-09	19696.00	53.67		40.30	11.42	-35.76	15.95	69.62	PK	3.00	9.54	91.77	22.15	PASS
11	H	1	3160-09	19696.00	33.44		40.30	11.42	-35.76	15.95	49.39	AV	3.00	9.54	91.77	42.38	PASS
11	H	1	3160-09	22158.00	53.69		40.33	12.08	-35.73	16.68	70.37	PK	3.00	9.54	91.77	21.40	PASS
11	H	1	3160-09	22158.00	35.90		40.33	12.08	-35.73	16.68	52.58	AV	3.00	9.54	91.77	39.19	PASS
11	H	1	3160-09	24620.00	55.75		40.40	13.00	-35.73	17.67	73.42	PK	3.00	9.54	91.77	18.35	PASS
11	H	1	3160-09	24620.00	37.57		40.40	13.00	-35.73	17.67	55.24	AV	3.00	9.54	91.77	36.53	PASS
11	H	1	3160-09	24460.00	56.88	x	40.40	12.94	-35.73	17.61	74.49	PK	3.00	9.54	91.77	17.28	PASS
11	H	1	3160-09	24460.00	37.32	x	40.40	12.94	-35.73	17.61	54.93	AV	3.00	9.54	91.77	36.84	PASS

Formulae:

Total CF = Antenna Factor + Cable Factor + Other Factor (Amplifier Gain, filter loss, etc)

Field Strength = SA Reading + Total CF

Limit Distance Correction = $40 \cdot \log(d1/d2)$ for $F < 30$ MHz, $20 \cdot \log(d1/d2)$ for $F > 30$ MHz:

where d1 is the measurement distance, d2 is the published limit distance

Limit = Specified Limit + Limit Distance Correction

Margin = Limit - Field Strength

*No harmonic emission where measured above the field strengths noted

Test Report S/N:	052604-514KBC
Test Date(s):	28Jun04 - 29Jul04
Test Type:	FCC Part 15.247

E.9.12. Channel 11 Harmonic Emission Field Strengths @ Specified Distance - Vertical Polarization

Channel	Polarity	Measurement Distance	Antenna	Frequency	SA Level	Noise Floor	Antenna Factor	Cable Factor	Other Factors	Total CF	Field Strength	Detector	Limit Distance	Limit Distance Correction	-20 dBc Limit	Margin	Pass/Fail
													m	dB	dB	dBuV/m	
11	V	3	Horn SN6276	5770.00	42.50	x	34.21	5.45	-35.50	4.16	46.66	PK	3.00	0.00	76.64	29.98	PASS
11	V	1	Horn SN6276	16680.00	39.00		39.29	10.24	-36.14	13.40	52.40	PK	3.00	9.54	86.18	33.79	PASS
11	V	1	3160-09	19696.00	53.07		40.30	11.42	-35.76	15.95	69.02	PK	3.00	9.54	86.18	17.16	PASS
11	V	1	3160-09	19696.00	33.28		40.30	11.42	-35.76	15.95	49.23	AV	3.00	9.54	86.18	36.95	PASS
11	V	1	3160-09	20660.00	55.02	x	40.30	11.74	-35.73	16.31	71.33	PK	3.00	9.54	86.18	14.85	PASS
11	V	1	3160-09	20660.00	35.18	x	40.30	11.74	-35.73	16.31	51.49	AV	3.00	9.54	86.18	34.69	PASS
11	V	1	3160-09	22158.00	54.12		40.33	12.08	-35.73	16.68	70.80	PK	3.00	9.54	86.18	15.38	PASS
11	V	1	3160-09	22158.00	35.80		40.33	12.08	-35.73	16.68	52.48	AV	3.00	9.54	86.18	33.70	PASS
11	V	1	3160-09	23950.00	57.28	x	40.40	12.75	-35.73	17.42	74.70	PK	3.00	9.54	86.18	11.48	PASS
11	V	1	3160-09	23950.00	36.43	x	40.40	12.75	-35.73	17.42	53.85	AV	3.00	9.54	86.18	32.33	PASS
11	V	1	3160-09	24620.00	55.73		40.40	13.00	-35.73	17.67	73.40	PK	3.00	9.54	86.18	12.78	PASS
11	V	1	3160-09	24620.00	37.92		40.40	13.00	-35.73	17.67	55.59	AV	3.00	9.54	86.18	30.59	PASS

Formulae:

Total CF = Antenna Factor + Cable Factor + Other Factor (Amplifier Gain, filter loss, etc)

Field Strength = SA Reading + Total CF

Limit Distance Correction = $40 \cdot \log(d1/d2)$ for $F < 30$ MHz, $20 \cdot \log(d1/d2)$ for $F > 30$ MHz:
 where d1 is the measurement distance, d2 is the published limit distance

Limit = Specified Limit + Limit Distance Correction

Margin = Limit - Field Strength

*No harmonic emission where measured above the field strengths noted

Test Report S/N:	052604-514KBC
Test Date(s):	28Jun04 - 29Jul04
Test Type:	FCC Part 15.247

E.9.13. Channel 1 Out-of-Band Spurious Emission Field Strengths @ Specified Distance – Horizontal Polarization

Channel	Polarity	Measurement Distance	Antenna	Frequency	SA Level	Noise Floor	Antenna Factor	Cable Factor	Other Factors	Total CF	Field Strength	Detector	Limit Distance	Limit Distance Correction	-20 dBc Limit	Margin	Pass/Fail
													m	dB	dB	dBuV/m	
1	H	3	Bilog SN1607	57.48	49.20		5.53	0.53	0.00	6.06	55.26	PK	3.00	0.00	81.70	26.44	PASS
1	H	3	Bilog SN1607	99.52	35.20		9.90	0.84	0.00	10.75	45.95	PK	3.00	0.00	81.70	35.75	PASS
1	H	3	Bilog SN1607	107.28	36.80		10.65	0.89	0.00	11.55	48.35	PK	3.00	0.00	81.70	33.35	PASS
1	H	3	Bilog SN1607	167.09	32.00		9.40	0.98	0.00	10.39	42.39	PK	3.00	0.00	81.70	39.31	PASS
1	H	3	Bilog SN1607	208.48	27.30		8.25	1.04	0.00	9.29	36.59	PK	3.00	0.00	81.70	45.11	PASS
1	H	3	Bilog SN1607	245.34	30.00		11.79	1.10	0.00	12.89	42.89	PK	3.00	0.00	81.70	38.81	PASS
1	H	3	Bilog SN1607	380.82	35.30		15.43	1.30	0.00	16.73	52.03	PK	3.00	0.00	81.70	29.67	PASS
1	H	3	Bilog SN1607	787.89	20.30		22.46	1.90	0.00	24.36	44.66	PK	3.00	0.00	81.70	37.04	PASS
1	H	3	Bilog SN1607	855.15	31.30		23.55	1.99	0.00	25.54	56.84	PK	3.00	0.00	81.70	24.86	PASS
1	H	3	Bilog SN1607	931.78	36.00		24.89	2.11	0.00	27.00	63.00	PK	3.00	0.00	81.70	18.70	PASS
1	H	3	Horn SN6276	2500.00	42.60		28.30	3.51	-36.42	-4.61	37.99	PK	3.00	0.00	81.70	43.71	PASS
1	H	3	Horn SN6276	4810.00	22.60	x	32.88	4.96	0.00	37.85	60.45	PK	3.00	0.00	81.70	21.25	PASS
1	H	3	Horn SN6276	5240.00	23.30	x	33.68	5.22	0.00	38.91	62.21	PK	3.00	0.00	81.70	19.49	PASS
1	H	3	Horn SN6276	7230.00	38.90		35.71	6.27	-35.56	6.41	45.31	PK	3.00	0.00	81.70	36.39	PASS
1	H	3	Horn SN6276	9610.00	37.10		37.59	7.37	-35.67	9.29	46.39	PK	3.00	0.00	81.70	35.31	PASS
1	H	3	Horn SN6276	17660.00	38.00	x	44.88	10.46	-36.02	19.33	57.33	PK	3.00	0.00	81.70	24.37	PASS
1	H	1	3160-09	19296.00	52.98		40.26	11.01	-35.81	15.45	68.43	PK	3.00	9.54	91.24	22.81	PASS
1	H	1	3160-09	19296.00	34.05		40.26	11.01	-35.81	15.45	49.50	AV	3.00	9.54	91.24	41.74	PASS
1	H	1	3160-09	21708.00	53.65		40.30	11.91	-35.73	16.48	70.13	PK	3.00	9.54	91.24	21.11	PASS
1	H	1	3160-09	21708.00	35.74		40.30	11.91	-35.73	16.48	52.22	AV	3.00	9.54	91.24	39.02	PASS
1	H	1	3160-09	24120.00	56.09		40.40	12.81	-35.73	17.48	73.57	PK	3.00	9.54	91.24	17.67	PASS
1	H	1	3160-09	24120.00	37.57		40.40	12.81	-35.73	17.48	55.05	AV	3.00	9.54	91.24	36.19	PASS
1	H	1	3160-09	24490.00	57.15		40.40	12.95	-35.73	17.62	74.77	PK	3.00	9.54	91.24	16.47	PASS
1	H	1	3160-09	24490.00	38.00		40.40	12.95	-35.73	17.62	55.62	AV	3.00	9.54	91.24	35.62	PASS

Formulae:

Total CF = Antenna Factor + Cable Factor + Other Factor (Amplifier Gain, filter loss, etc)

Field Strength = SA Reading + Total CF

Limit Distance Correction = 40*log(d1/d2) for F<30 MHz, 20*log(d1/d2) for F> 30 MHz:

where d1 is the measurement distance, d2 is the published limit distance

Limit = Specified Limit + Limit Distance Correction

Margin = Limit - Field Strength

*No out-of-band emissions where measured above the levels noted

Itronix Corporation	Model: IX260+	FCC ID:	KBCIX260PROGC82
Rugged Laptop PC with internal WLAN (802.11b/g) & Dual-Band GSM GPRS/EDGE Modem			
2004 Celltech Labs Inc	This document is not to be reproduced in whole or in part without the written permission of Celltech Labs Inc.		40 of 80

Test Report S/N:	052604-514KBC
Test Date(s):	28Jun04 - 29Jul04
Test Type:	FCC Part 15.247

E.9.14. Channel 1 Out-of-Band Spurious Emission Field Strengths @ Specified Distance - Vertical Polarization

Channel	Polarity	Measurement Distance	Antenna	Frequency	SA Level	Noise Floor	Antenna Factor	Cable Factor	Other Factors	Total CF	Field Strength	Detector	Limit Distance	Limit Distance Correction	-20 dBc Limit	Margin	Pass/Fail
													m	dB	dBuV/m	Δ dB	
1	V	3	LP-105	0.078	17.37		48.70	0.03	0.00	48.73	66.10	PK	3.00	0.00	76.09	9.99	PASS
1	V	3	LG-105	0.203	1.41		59.86	0.07	0.00	59.94	61.35	PK	3.00	0.00	76.09	14.74	PASS
1	V	3	LG-105	0.485	2.42		58.03	0.09	0.00	58.12	60.54	PK	3.00	0.00	76.09	15.55	PASS
1	V	3	LG-105	1.50	9.04		53.10	0.15	0.00	53.25	62.29	PK	3.00	0.00	76.09	13.80	PASS
1	V	3	LG-105	2.62	7.21		50.69	0.20	0.00	50.89	58.10	PK	3.00	0.00	76.09	17.99	PASS
1	V	3	LG-105	5.48	11.74		44.38	0.31	0.00	44.68	56.42	PK	3.00	0.00	76.09	19.67	PASS
1	V	3	LG-105	27.15	10.24		40.62	0.68	0.00	41.30	51.54	PK	3.00	0.00	76.09	24.55	PASS
1	V	3	Bilog SN1607	99.52	29.60		9.90	0.84	0.00	10.75	40.35	PK	3.00	0.00	76.09	35.74	PASS
1	V	3	Bilog SN1607	208.80	46.80		8.28	1.04	0.00	9.32	56.12	PK	3.00	0.00	76.09	19.97	PASS
1	V	3	Bilog SN1607	245.34	52.50		11.79	1.10	0.00	12.89	65.39	PK	3.00	0.00	76.09	10.70	PASS
1	V	3	Bilog SN1607	449.36	44.80		17.03	1.40	0.00	18.43	63.23	PK	3.00	0.00	76.09	12.86	PASS
1	V	3	Bilog SN1607	736.16	23.70		22.93	1.82	0.00	24.75	48.45	PK	3.00	0.00	76.09	27.64	PASS
1	V	3	Bilog SN1607	772.70	44.40		22.57	1.87	0.00	24.45	68.85	PK	3.00	0.00	76.09	7.24	PASS
1	V	3	Horn SN6276	3200.00	43.50		30.48	4.04	-35.93	-1.40	42.10	PK	3.00	0.00	76.09	33.99	PASS
1	V	3	Horn SN6276	4810.00	47.00		32.88	4.96	-35.30	2.54	49.54	PK	3.00	0.00	76.09	26.55	PASS
1	V	3	Horn SN6276	5260.00	40.10		33.72	5.23	-35.34	3.61	43.71	PK	3.00	0.00	76.09	32.38	PASS
1	V	3	Horn SN6276	5720.00	41.60		34.19	5.44	-35.38	4.25	45.85	PK	3.00	0.00	76.09	30.24	PASS
1	V	3	Horn SN6276	5770.00	44.80		34.21	5.45	-35.38	4.28	49.08	PK	3.00	0.00	76.09	27.01	PASS
1	V	3	Horn SN6276	7520.00	40.40		36.32	6.43	-35.53	7.21	47.61	PK	3.00	0.00	76.09	28.48	PASS
1	V	3	Horn SN6276	8360.00	37.60		37.06	6.79	-35.60	8.25	45.85	PK	3.00	0.00	76.09	30.24	PASS
1	V	3	Horn SN6276	9610.00	36.60		37.59	7.37	-35.71	9.25	45.85	PK	3.00	0.00	76.09	30.24	PASS

Formulae:

Total CF = Antenna Factor + Cable Factor + Other Factor (Amplifier Gain, filter loss, etc)

Field Strength = SA Reading + Total CF

Limit Distance Correction = $40 \cdot \log(d1/d2)$ for $F < 30$ MHz, $20 \cdot \log(d1/d2)$ for $F > 30$ MHz:

where d1 is the measurement distance, d2 is the published limit distance

Limit = Specified Limit + Limit Distance Correction

Margin = Limit - Field Strength

*No out-of-band emissions where measured above the levels noted

Continued

Itronix Corporation	Model: IX260+	FCC ID:	KBCIX260PROGC82
Rugged Laptop PC with internal WLAN (802.11b/g) & Dual-Band GSM GPRS/EDGE Modem			
2004 Celltech Labs Inc	This document is not to be reproduced in whole or in part without the written permission of Celltech Labs Inc.		41 of 80

Test Report S/N:	052604-514KBC
Test Date(s):	28Jun04 - 29Jul04
Test Type:	FCC Part 15.247

Continued

Channel	Polarity	Measurement Distance	Antenna	Frequency	SA Level	Noise Floor	Antenna Factor	Cable Factor	Other Factors	Total CF	Field Strength	Detector	Limit Distance	Limit Distance Correction	-20 dBc Limit	Margin	Pass/Fail
													m	dB	dBuV/m	Δ dB	
1	V	3	Horn SN6276	12640.00	36.90		38.71	8.68	-36.79	10.59	47.49	PK	3.00	0.00	76.09	28.60	PASS
1	V	3	Horn SN6276	15740.00	38.20		37.56	9.77	-36.53	10.80	49.00	PK	3.00	0.00	76.09	27.09	PASS
1	V	3	Horn SN6276	17770.00	37.60	x	45.70	10.30	-36.35	19.65	57.25	PK	3.00	0.00	76.09	18.84	PASS
1	V	1	3160-09	18820.00	53.92	x	40.20	11.05	-35.87	15.38	69.30	PK	3.00	9.54	85.63	16.33	PASS
1	V	1	3160-09	18820.00	33.66	x	40.20	11.05	-35.87	15.38	49.04	AV	3.00	9.54	85.63	36.59	PASS
1	V	1	3160-09	19296.00	52.65		40.26	11.01	-35.81	15.45	68.10	PK	3.00	9.54	85.63	17.53	PASS
1	V	1	3160-09	19296.00	33.76		40.26	11.01	-35.81	15.45	49.21	AV	3.00	9.54	85.63	36.42	PASS
1	V	1	3160-09	21708.00	53.27		40.30	11.91	-35.73	16.48	69.75	PK	3.00	9.54	85.63	15.88	PASS
1	V	1	3160-09	21708.00	36.04		40.30	11.91	-35.73	16.48	52.52	AV	3.00	9.54	85.63	33.11	PASS
1	V	1	3160-09	24120.00	56.03		40.40	12.81	-35.73	17.48	73.51	PK	3.00	9.54	85.63	12.12	PASS
1	V	1	3160-09	24120.00	37.21		40.40	12.81	-35.73	17.48	54.69	AV	3.00	9.54	85.63	30.94	PASS
1	V	1	3160-09	24550.00	56.31	x	40.40	12.97	-35.73	17.64	73.95	PK	3.00	9.54	85.63	11.68	PASS
1	V	1	3160-09	24550.00	38.30	x	40.40	12.97	-35.73	17.64	55.94	AV	3.00	9.54	85.63	29.69	PASS

Formulae:

Total CF = Antenna Factor + Cable Factor + Other Factor (Amplifier Gain, filter loss, etc)

Field Strength = SA Reading + Total CF

Limit Distance Correction = $40 \cdot \log(d1/d2)$ for $F < 30$ MHz, $20 \cdot \log(d1/d2)$ for $F > 30$ MHz:

where d1 is the measurement distance, d2 is the published limit distance

Limit = Specified Limit + Limit Distance Correction

Margin = Limit - Field Strength

*No out-of-band emissions where measured above the levels noted

Itronix Corporation	Model: IX260+	FCC ID:	KBCIX260PROGC82
Rugged Laptop PC with internal WLAN (802.11b/g) & Dual-Band GSM GPRS/EDGE Modem			
2004 Celltech Labs Inc	This document is not to be reproduced in whole or in part without the written permission of Celltech Labs Inc.		42 of 80

Test Report S/N:	052604-514KBC
Test Date(s):	28Jun04 - 29Jul04
Test Type:	FCC Part 15.247

E.9.15. Channel 6 Out-of-Band Spurious Emission Field Strengths @ Specified Distance – Horizontal Polarization

Channel	Polarity	Measurement Distance	Antenna	Frequency	SA Level	Noise Floor	Antenna Factor	Cable Factor	Other Factors	Total CF	Field Strength	Detector	Limit Distance	Limit Distance Correction	-20 dBc Limit	Margin	Pass/Fail
													m	dB	dB	dBuV/m	
6	H	3	Bilog SN1607	60.70	29.20		5.03	0.56	0.00	5.59	34.79	PK	3.00	0.00	81.67	46.88	PASS
6	H	3	Bilog SN1607	107.28	36.50		10.65	0.89	0.00	11.55	48.05	PK	3.00	0.00	81.67	33.62	PASS
6	H	3	Bilog SN1607	149.96	34.10		10.70	0.96	0.00	11.66	45.76	PK	3.00	0.00	81.67	35.91	PASS
6	H	3	Bilog SN1607	208.48	29.70		8.25	1.04	0.00	9.29	38.99	PK	3.00	0.00	81.67	42.68	PASS
6	H	3	Bilog SN1607	245.34	34.80		11.79	1.10	0.00	12.89	47.69	PK	3.00	0.00	81.67	33.98	PASS
6	H	3	Bilog SN1607	786.92	24.50		22.47	1.89	0.00	24.36	48.86	PK	3.00	0.00	81.67	32.81	PASS
6	H	3	Bilog SN1607	929.51	19.50		24.83	2.10	0.00	26.94	46.44	PK	3.00	0.00	81.67	35.23	PASS
6	H	3	Horn SN6276	2750.00	38.60		29.15	3.69	-36.38	-3.53	35.07	PK	3.00	0.00	81.67	46.60	PASS
6	H	3	Horn SN6276	3240.00	37.00		30.58	4.06	-36.12	-1.48	35.52	PK	3.00	0.00	81.67	46.15	PASS
6	H	3	Horn SN6276	4860.00	36.70		32.99	5.02	-35.46	2.55	39.25	PK	3.00	0.00	81.67	42.42	PASS
6	H	3	Horn SN6276	5260.00	45.20		33.72	5.23	-35.47	3.47	48.67	PK	3.00	0.00	81.67	33.00	PASS
6	H	3	Horn SN6276	5770.00	37.20		34.21	5.45	-35.50	4.16	41.36	PK	3.00	0.00	81.67	40.31	PASS
6	H	3	Horn SN6276	8280.00	38.40		36.98	6.75	-35.61	8.11	46.51	PK	3.00	0.00	81.67	35.16	PASS
6	H	3	Horn SN6276	8360.00	42.30		37.06	6.79	-35.62	8.24	50.54	PK	3.00	0.00	81.67	31.13	PASS
6	H	3	Horn SN6276	17090.00	39.20		41.24	10.38	-36.09	15.54	54.74	PK	3.00	0.00	81.67	26.93	PASS
6	H	1	3160-09	19496.00	52.56		40.30	11.28	-35.79	15.79	68.35	PK	3.00	9.54	91.21	22.86	PASS
6	H	1	3160-09	19496.00	33.91		40.30	11.28	-35.79	15.79	49.70	AV	3.00	9.54	91.21	41.51	PASS
6	H	1	3160-09	21240.00	54.98	x	40.30	11.73	-35.73	16.31	71.29	PK	3.00	9.54	91.21	19.93	PASS
6	H	1	3160-09	21240.00	35.72	x	40.30	11.73	-35.73	16.31	52.03	AV	3.00	9.54	91.21	39.19	PASS
6	H	1	3160-09	21933.00	54.66		40.30	11.99	-35.73	16.57	71.23	PK	3.00	9.54	91.21	19.99	PASS
6	H	1	3160-09	21933.00	36.27		40.30	11.99	-35.73	16.57	52.84	AV	3.00	9.54	91.21	38.38	PASS
6	H	1	3160-09	24370.00	57.10		40.40	12.90	-35.73	17.58	74.68	PK	3.00	9.54	91.21	16.54	PASS
6	H	1	3160-09	24370.00	37.88		40.40	12.90	-35.73	17.58	55.46	AV	3.00	9.54	91.21	35.76	PASS
6	H	1	3160-09	24420.00	56.93	x	40.40	12.92	-35.73	17.60	74.53	PK	3.00	9.54	91.21	16.69	PASS
6	H	1	3160-09	24420.00	37.73	x	40.40	12.92	-35.73	17.60	55.33	AV	3.00	9.54	91.21	35.89	PASS

Formulae:

Total CF = Antenna Factor + Cable Factor + Other Factor (Amplifier Gain, filter loss, etc)

Field Strength = SA Reading + Total CF

Limit Distance Correction = 40*log(d1/d2) for F<30 MHz, 20*log(d1/d2) for F> 30 MHz:

where d1 is the measurement distance, d2 is the published limit distance

Limit = Specified Limit + Limit Distance Correction

Margin = Limit - Field Strength

*No out-of-band emissions where measured above the levels noted

Itronix Corporation	Model: IX260+	FCC ID:	KBCIX260PROGC82
Rugged Laptop PC with internal WLAN (802.11b/g) & Dual-Band GSM GPRS/EDGE Modem			
2004 Celltech Labs Inc	This document is not to be reproduced in whole or in part without the written permission of Celltech Labs Inc.		43 of 80

Test Report S/N:	052604-514KBC
Test Date(s):	28Jun04 - 29Jul04
Test Type:	FCC Part 15.247

E.9.16. Channel 6 Out-of-Band Spurious Emission Field Strengths @ Specified Distance - Vertical Polarization

Channel	Polarity	Measurement Distance	Antenna	Frequency	SA Level	Noise Floor	Antenna Factor	Cable Factor	Other Factors	Total CF	Field Strength	Detector	Limit Distance	Limit Distance Correction	-20 dBc Limit	Margin	Pass/Fail
													m	dB	dBuV/m	Δ dB	
6	V	3	LP-105	0.08	17.57		48.71	0.05	0.00	48.76	66.33	PK	3.00	0.00	75.37	9.04	PASS
6	V	3	LG-105	2.03	9.04		52.21	0.17	0.00	52.39	61.43	PK	3.00	0.00	75.37	13.94	PASS
6	V	3	LG-105	0.83	2.38		57.38	0.11	0.00	57.49	59.87	PK	3.00	0.00	75.37	15.50	PASS
6	V	3	LG-105	1.50	8.52		53.11	0.15	0.00	53.26	61.78	PK	3.00	0.00	75.37	13.59	PASS
6	V	3	LG-105	3.22	8.34		49.31	0.23	0.00	49.54	57.88	PK	3.00	0.00	75.37	17.49	PASS
6	V	3	LG-105	5.63	12.44		44.09	0.31	0.00	44.40	56.84	PK	3.00	0.00	75.37	18.53	PASS
6	V	3	LG-105	17.80	9.89		41.04	0.55	0.00	41.59	51.48	PK	3.00	0.00	75.37	23.89	PASS
6	V	3	Bilog SN1607	57.48	30.80		5.53	0.53	0.00	6.06	36.86	PK	3.00	0.00	75.37	38.51	PASS
6	V	3	Bilog SN1607	99.52	28.50		9.90	0.84	0.00	10.75	39.25	PK	3.00	0.00	75.37	36.12	PASS
6	V	3	Bilog SN1607	103.72	27.90		10.33	0.88	0.00	11.21	39.11	PK	3.00	0.00	75.37	36.26	PASS
6	V	3	Bilog SN1607	138.96	37.30		11.14	0.94	0.00	12.08	49.38	PK	3.00	0.00	75.37	25.99	PASS
6	V	3	Bilog SN1607	166.77	24.50		9.43	0.98	0.00	10.41	34.91	PK	3.00	0.00	75.37	40.46	PASS
6	V	3	Bilog SN1607	196.19	31.70		8.47	1.03	0.00	9.49	41.19	PK	3.00	0.00	75.37	34.18	PASS
6	V	3	Bilog SN1607	196.52	29.70		8.44	1.03	0.00	9.47	39.17	PK	3.00	0.00	75.37	36.20	PASS
6	V	3	Bilog SN1607	244.37	56.10		11.68	1.10	0.00	12.78	68.88	PK	3.00	0.00	75.37	6.49	PASS
6	V	3	Bilog SN1607	246.96	28.50		11.97	1.10	0.00	13.07	41.57	PK	3.00	0.00	75.37	33.80	PASS
6	V	3	Bilog SN1607	306.45	27.50		13.40	1.19	0.00	14.58	42.08	PK	3.00	0.00	75.37	33.29	PASS
6	V	3	Bilog SN1607	772.70	37.20		22.57	1.87	0.00	24.45	61.65	PK	3.00	0.00	75.37	13.72	PASS
6	V	3	Bilog SN1607	952.47	34.80		25.36	2.14	0.00	27.50	62.30	PK	3.00	0.00	75.37	13.07	PASS
6	V	3	Horn SN6276	2830.00	37.90		29.42	3.75	-36.33	-3.16	34.74	PK	3.00	0.00	75.37	40.63	PASS
6	V	3	Horn SN6276	5240.00	37.30		33.68	5.22	-35.47	3.43	40.73	PK	3.00	0.00	75.37	34.64	PASS
6	V	3	Horn SN6276	5770.00	40.10		34.21	5.45	-35.50	4.16	44.26	PK	3.00	0.00	75.37	31.11	PASS
6	V	3	Horn SN6276	7520.00	37.80		36.32	6.43	-35.58	7.17	44.97	PK	3.00	0.00	75.37	30.40	PASS

Formulae:

Total CF = Antenna Factor + Cable Factor + Other Factor (Amplifier Gain, filter loss, etc)

Field Strength = SA Reading + Total CF

Limit Distance Correction = $40 \cdot \log(d1/d2)$ for $F < 30$ MHz, $20 \cdot \log(d1/d2)$ for $F > 30$ MHz:

where d1 is the measurement distance, d2 is the published limit distance

Limit = Specified Limit + Limit Distance Correction

Margin = Limit - Field Strength

*No out-of-band emissions where measured above the levels noted

Continued

Itronix Corporation	Model: IX260+	FCC ID:	KBCIX260PROGC82
Rugged Laptop PC with internal WLAN (802.11b/g) & Dual-Band GSM GPRS/EDGE Modem			
2004 Celltech Labs Inc	This document is not to be reproduced in whole or in part without the written permission of Celltech Labs Inc.		44 of 80

Test Report S/N:	052604-514KBC
Test Date(s):	28Jun04 - 29Jul04
Test Type:	FCC Part 15.247

Continued

Channel	Polarity	Measurement Distance	Antenna	Frequency	SA Level	Noise Floor	Antenna Factor	Cable Factor	Other Factors	Total CF	Field Strength	Detector	Limit Distance	Limit Distance Correction	-20 dBc Limit	Margin	Pass/Fail
													m	dB	dBuV/m	Δ dB	
6	V	3	Horn SN6276	9720.00	36.80		37.68	7.34	-35.71	9.31	46.11	PK	3.00	0.00	75.37	29.26	PASS
6	V	3	Horn SN6276	16480.00	38.30	x	38.45	10.25	-36.16	12.54	50.84	PK	3.00	0.00	75.37	24.53	PASS
6	V	1	3160-09	19190.00	54.26	x	40.24	10.91	-35.83	15.32	69.58	PK	3.00	9.54	84.91	15.33	PASS
6	V	1	3160-09	19190.00	33.78	x	40.24	10.91	-35.83	15.32	49.10	AV	3.00	9.54	84.91	35.81	PASS
6	V	1	3160-09	19496.00	52.89		40.30	11.28	-35.79	15.79	68.68	PK	3.00	9.54	84.91	16.23	PASS
6	V	1	3160-09	19496.00	33.88		40.30	11.28	-35.79	15.79	49.67	AV	3.00	9.54	84.91	35.24	PASS
6	V	1	3160-09	21933.00	53.99		40.30	11.99	-35.73	16.57	70.56	PK	3.00	9.54	84.91	14.36	PASS
6	V	1	3160-09	21933.00	36.23		40.30	11.99	-35.73	16.57	52.80	AV	3.00	9.54	84.91	32.12	PASS
6	V	1	3160-09	24370.00	55.56		40.40	12.90	-35.73	17.58	73.14	PK	3.00	9.54	84.91	11.78	PASS
6	V	1	3160-09	24370.00	37.88		40.40	12.90	-35.73	17.58	55.46	AV	3.00	9.54	84.91	29.46	PASS
6	V	1	3160-09	24400.00	56.66	x	40.40	12.91	-35.73	17.59	74.25	PK	3.00	9.54	84.91	10.66	PASS
6	V	1	3160-09	24400.00	37.87	x	40.40	12.91	-35.73	17.59	55.46	AV	3.00	9.54	84.91	29.45	PASS

Formulae:

Total CF = Antenna Factor + Cable Factor + Other Factor (Amplifier Gain, filter loss, etc)

Field Strength = SA Reading + Total CF

Limit Distance Correction = $40 \cdot \log(d1/d2)$ for $F < 30$ MHz, $20 \cdot \log(d1/d2)$ for $F > 30$ MHz:
 where d1 is the measurement distance, d2 is the published limit distance

Limit = Specified Limit + Limit Distance Correction

Margin = Limit - Field Strength

*No out-of-band emissions where measured above the levels noted

Test Report S/N:	052604-514KBC
Test Date(s):	28Jun04 - 29Jul04
Test Type:	FCC Part 15.247

E.9.17. Channel 11 Out-of-Band Spurious Emission Field Strengths @ Specified Distance – Horizontal Polarization

Channel	Polarity	Measurement Distance	Antenna	Frequency	SA Level	Noise Floor	Antenna Factor	Cable Factor	Other Factors	Total CF	Field Strength	Detector	Limit Distance	Limit Distance Correction	-20 dBc Limit	Margin	Pass/Fail
													m	dB	dB	dBuV/m	
11	H	3	Bilog SN1607	57.80	48.10		5.45	0.54	0.00	5.99	54.09	PK	3.00	0.00	82.23	28.14	PASS
11	H	3	Bilog SN1607	101.13	38.90		10.10	0.86	0.00	10.96	49.86	PK	3.00	0.00	82.23	32.37	PASS
11	H	3	Bilog SN1607	141.55	31.30		11.07	0.95	0.00	12.01	43.31	PK	3.00	0.00	82.23	38.92	PASS
11	H	3	Bilog SN1607	208.80	31.20		8.28	1.04	0.00	9.32	40.52	PK	3.00	0.00	82.23	41.71	PASS
11	H	3	Bilog SN1607	297.72	29.20		13.28	1.17	0.00	14.45	43.65	PK	3.00	0.00	82.23	38.58	PASS
11	H	3	Bilog SN1607	381.14	44.00		15.45	1.30	0.00	16.74	60.74	PK	3.00	0.00	82.23	21.49	PASS
11	H	3	Bilog SN1607	772.70	28.40		22.57	1.87	0.00	24.45	52.85	PK	3.00	0.00	82.23	29.38	PASS
11	H	3	Bilog SN1607	944.39	31.30		25.21	2.13	0.00	27.34	58.64	PK	3.00	0.00	82.23	23.59	PASS
11	H	3	Horn SN6276	2810.00	37.50		29.35	3.74	-36.34	-3.25	34.25	PK	3.00	0.00	82.23	47.98	PASS
11	H	3	Horn SN6276	4900.00	39.50		33.08	5.05	-35.46	2.68	42.18	PK	3.00	0.00	82.23	40.05	PASS
11	H	3	Horn SN6276	5260.00	45.80		33.72	5.23	-35.47	3.47	49.27	PK	3.00	0.00	82.23	32.96	PASS
11	H	3	Horn SN6276	8280.00	39.30		36.98	6.75	-35.61	8.11	47.41	PK	3.00	0.00	82.23	34.82	PASS
11	H	3	Horn SN6276	8360.00	42.10		37.06	6.79	-35.62	8.24	50.34	PK	3.00	0.00	82.23	31.89	PASS
11	H	3	Horn SN6276	9820.00	39.00		37.76	7.44	-35.77	9.42	48.42	PK	3.00	0.00	82.23	33.81	PASS
11	H	3	Horn SN6276	15920.00	38.90	x	37.38	9.83	-36.23	10.98	49.88	PK	3.00	0.00	82.23	32.35	PASS
11	H	1	3160-09	18810.00	53.72	x	40.20	11.15	-35.87	15.48	69.20	PK	3.00	9.54	91.77	22.58	PASS
11	H	1	3160-09	18810.00	33.94	x	40.20	11.15	-35.87	15.48	49.42	AV	3.00	9.54	91.77	42.36	PASS
11	H	1	3160-09	19696.00	53.67		40.30	11.42	-35.76	15.95	69.62	PK	3.00	9.54	91.77	22.15	PASS
11	H	1	3160-09	19696.00	33.44		40.30	11.42	-35.76	15.95	49.39	AV	3.00	9.54	91.77	42.38	PASS
11	H	1	3160-09	22158.00	53.69		40.33	12.08	-35.73	16.68	70.37	PK	3.00	9.54	91.77	21.40	PASS
11	H	1	3160-09	22158.00	35.90		40.33	12.08	-35.73	16.68	52.58	AV	3.00	9.54	91.77	39.19	PASS
11	H	1	3160-09	24460.00	56.88	x	40.40	12.94	-35.73	17.61	74.49	PK	3.00	9.54	91.77	17.28	PASS
11	H	1	3160-09	24460.00	37.32	x	40.40	12.94	-35.73	17.61	54.93	AV	3.00	9.54	91.77	36.84	PASS
11	H	1	3160-09	24620.00	55.75		40.40	13.00	-35.73	17.67	73.42	PK	3.00	9.54	91.77	18.35	PASS
11	H	1	3160-09	24620.00	37.57		40.40	13.00	-35.73	17.67	55.24	AV	3.00	9.54	91.77	36.53	PASS

Formulae:

Total CF = Antenna Factor + Cable Factor + Other Factor (Amplifier Gain, filter loss, etc)

Field Strength = SA Reading + Total CF

Limit Distance Correction = 40*log(d1/d2) for F<30 MHz, 20*log(d1/d2) for F> 30 MHz:
where d1 is the measurement distance, d2 is the published limit distance

Limit = Specified Limit + Limit Distance Correction

Margin = Limit - Field Strength

*No out-of-band emissions where measured above the levels noted

Itronix Corporation	Model: IX260+	FCC ID:	KBCIX260PROGC82
Rugged Laptop PC with internal WLAN (802.11b/g) & Dual-Band GSM GPRS/EDGE Modem			
2004 Celltech Labs Inc	This document is not to be reproduced in whole or in part without the written permission of Celltech Labs Inc.		46 of 80

Test Report S/N:	052604-514KBC
Test Date(s):	28Jun04 - 29Jul04
Test Type:	FCC Part 15.247

E.9.18. Channel 11 Out-of-Band Spurious Emission Field Strengths @ Specified Distance – Vertical Polarization

Channel	Polarity	Measurement Distance	Antenna	Frequency	SA Level	Noise Floor	Antenna Factor	Cable Factor	Other Factors	Total CF	Field Strength	Detector	Limit Distance	Limit Distance Correction	-20 dBc Limit	Margin	Pass/Fail
													m	dB	dB	dBuV/m	
11	V	3	LP-105	0.08	19.50		48.79	0.04	0.00	48.83	68.33	PK	3.00	0.00	76.64	8.31	PASS
11	V	3	LG-105	0.20	1.04		59.88	0.07	0.00	59.95	60.99	PK	3.00	0.00	76.64	15.65	PASS
11	V	3	LG-105	0.79	1.46		57.46	0.12	0.00	57.57	59.03	PK	3.00	0.00	76.64	17.61	PASS
11	V	3	LG-105	1.44	8.37		53.25	0.15	0.00	53.40	61.77	PK	3.00	0.00	76.64	14.87	PASS
11	V	3	LG-105	4.05	10.60		47.10	0.26	0.00	47.36	57.96	PK	3.00	0.00	76.64	18.68	PASS
11	V	3	LG-105	5.26	10.77		44.79	0.30	0.00	45.09	55.86	PK	3.00	0.00	76.64	20.78	PASS
11	V	3	LG-105	13.95	9.95		40.60	0.50	0.00	41.09	51.04	PK	3.00	0.00	76.64	25.60	PASS
11	V	3	Bilog SN1607	138.96	37.30		11.14	0.94	0.00	12.08	49.38	PK	3.00	0.00	76.64	27.26	PASS
11	V	3	Bilog SN1607	149.63	56.50		10.72	0.96	0.00	11.68	68.18	PK	3.00	0.00	76.64	8.46	PASS
11	V	3	Bilog SN1607	164.83	39.20		9.57	0.98	0.00	10.54	49.74	PK	3.00	0.00	76.64	26.90	PASS
11	V	3	Bilog SN1607	208.48	44.90		8.25	1.04	0.00	9.29	54.19	PK	3.00	0.00	76.64	22.45	PASS
11	V	3	Bilog SN1607	245.02	44.80		11.75	1.10	0.00	12.85	57.65	PK	3.00	0.00	76.64	18.99	PASS
11	V	3	Bilog SN1607	794.04	35.60		22.51	1.90	0.00	24.42	60.02	PK	3.00	0.00	76.64	16.62	PASS
11	V	3	Horn SN6276	2810.00	37.20		29.35	3.74	-36.34	-3.25	33.95	PK	3.00	0.00	76.64	42.69	PASS
11	V	3	Horn SN6276	5270.00	36.40		33.73	5.24	-35.47	3.49	39.89	PK	3.00	0.00	76.64	36.75	PASS
11	V	3	Horn SN6276	5770.00	42.50		34.21	5.45	-35.50	4.16	46.66	PK	3.00	0.00	76.64	29.98	PASS
11	V	3	Horn SN6276	9820.00	36.60		37.76	7.44	-35.77	9.42	46.02	PK	3.00	0.00	76.64	30.62	PASS
11	V	3	Horn SN6276	16680.00	39.00	x	39.29	10.24	-36.14	13.40	52.40	PK	3.00	0.00	76.64	24.24	PASS
11	V	1	3160-09	19696.00	53.07		40.30	11.42	-35.76	15.95	69.02	PK	3.00	9.54	86.18	17.16	PASS
11	V	1	3160-09	19696.00	33.28		40.30	11.42	-35.76	15.95	49.23	AV	3.00	9.54	86.18	36.95	PASS
11	V	1	3160-09	20660.00	55.02	x	40.30	11.74	-35.73	16.31	71.33	PK	3.00	9.54	86.18	14.85	PASS
11	V	1	3160-09	20660.00	35.18	x	40.30	11.74	-35.73	16.31	51.49	AV	3.00	9.54	86.18	34.69	PASS
11	V	1	3160-09	22158.00	54.12		40.33	12.08	-35.73	16.68	70.80	PK	3.00	9.54	86.18	15.38	PASS
11	V	1	3160-09	22158.00	35.80		40.33	12.08	-35.73	16.68	52.48	AV	3.00	9.54	86.18	33.70	PASS
11	V	1	3160-09	23950.00	57.28	x	40.40	12.75	-35.73	17.42	74.70	PK	3.00	9.54	86.18	11.48	PASS
11	V	1	3160-09	23950.00	36.43	x	40.40	12.75	-35.73	17.42	53.85	AV	3.00	9.54	86.18	32.33	PASS
11	V	1	3160-09	24620.00	55.73		40.40	13.00	-35.73	17.67	73.40	PK	3.00	9.54	86.18	12.78	PASS

Formulae:

Total CF = Antenna Factor + Cable Factor + Other Factor (Amplifier Gain, filter loss, etc)

Field Strength = SA Reading + Total CF

Limit Distance Correction = 40*log(d1/d2) for F<30 MHz, 20*log(d1/d2) for F> 30 MHz:

where d1 is the measurement distance, d2 is the published limit distance

Limit = Specified Limit + Limit Distance Correction

Margin = Limit - Field Strength

*No out-of-band emissions where measured above the levels noted

Itronix Corporation	Model: IX260+	FCC ID:	KBCIX260PROGC82
Rugged Laptop PC with internal WLAN (802.11b/g) & Dual-Band GSM GPRS/EDGE Modem			
2004 Celltech Labs Inc	This document is not to be reproduced in whole or in part without the written permission of Celltech Labs Inc.		47 of 80

Test Report S/N:	052604-514KBC
Test Date(s):	28Jun04 - 29Jul04
Test Type:	FCC Part 15.247

E.10. PASS/FAIL

In reference to the results outlined in E.9, the DUT passes the requirements as stated in the reference standards as follows: FCC 15.247 (c): All emissions within any 100 kHz bandwidth outside the operating frequency band are greater than 20 dB below the maximum 100 kHz bandwidth signal within the operating band.

E.11. SIGN-OFF

I attest to the accuracy of the data. All measurements reported herein were performed by me and are correct to the best of my knowledge and belief. I assume full responsibility for the completeness of these measurements.



 Russell Pipe
 Senior Compliance Technologist
 Celltech Labs Inc.

 04Aug04
 Date

Test Report S/N:	052604-514KBC
Test Date(s):	28Jun04 - 29Jul04
Test Type:	FCC Part 15.247

Appendix F - Restricted Band Emissions Measurement

F.1. REFERENCES	
Normative Reference Standard	FCC CFR 47 §15.205 (a) (b), FCC CFR 47 §15.209 (a)
Procedure Reference	FCC 97-114

F.2. LIMITS																																																																									
FCC CFR 47 §15.205	<p>(a) Except as shown in paragraph (d) of this section, only spurious emissions are permitted in any of the frequency bands listed below:</p> <table border="1" style="width: 100%; border-collapse: collapse;"> <thead> <tr> <th style="width: 25%;">MHz</th> <th style="width: 25%;">MHz</th> <th style="width: 25%;">MHz</th> <th style="width: 25%;">GHz</th> </tr> </thead> <tbody> <tr><td>0.090–0.110</td><td>16.42–16.423</td><td>399.9–410</td><td>4.5–5.15</td></tr> <tr><td>1.0495–0.505</td><td>16.69475–16.69525</td><td>608–614</td><td>5.35–5.46</td></tr> <tr><td>2.1735–2.1905</td><td>16.80425–16.80475</td><td>960–1240</td><td>7.25–7.75</td></tr> <tr><td>4.125–4.128</td><td>25.5–25.67</td><td>1300–1427</td><td>8.025–8.5</td></tr> <tr><td>4.17725–4.17775</td><td>37.5–38.25</td><td>1435–1626.5</td><td>9.0–9.2</td></tr> <tr><td>4.20725–4.20775</td><td>73–74.6</td><td>1645.5–1646.5</td><td>9.3–9.5</td></tr> <tr><td>6.215–6.218</td><td>74.8–75.2</td><td>1660–1710</td><td>10.6–12.7</td></tr> <tr><td>6.26775–6.26825</td><td>108–121.94</td><td>1718.8–1722.2</td><td>13.25–13.4</td></tr> <tr><td>6.31175–6.31225</td><td>123–138</td><td>2200–2300</td><td>14.47–14.5</td></tr> <tr><td>8.291–8.294</td><td>149.9–150.05</td><td>2310–2390</td><td>15.35–16.2</td></tr> <tr><td>8.362–8.366</td><td>156.52475–156.52525</td><td>2483.5–2500</td><td>17.7–21.4</td></tr> <tr><td>8.37625–8.38675</td><td>156.7–156.9</td><td>2655–2900</td><td>22.01–23.12</td></tr> <tr><td>8.41425–8.41475</td><td>162.0125–167.17</td><td>3260–3267</td><td>23.6–24.0</td></tr> <tr><td>12.29–12.293</td><td>167.72–173.2</td><td>3332–3339</td><td>31.2–31.8</td></tr> <tr><td>12.51975–12.52025</td><td>240–285</td><td>3345.8–3358</td><td>36.43–36.5</td></tr> <tr><td>12.57675–12.57725</td><td>322–335.4</td><td>3600–4400</td><td>(²)</td></tr> <tr><td>13.36–13.41</td><td></td><td></td><td></td></tr> </tbody> </table> <p>¹Until February 1, 1999, this restricted band shall be 0.490–0.510 MHz. ²Above 38.6</p> <p>(b) Except as provided in paragraphs (d) and (e), the field strength of emissions appearing within these frequency bands shall not exceed the limits shown in 15.209. At frequencies equal to or less than 1000 MHz, compliance with the limits in Section 15.209 shall be demonstrated using measurement instrumentation employing a CISPR quasi-peak detector. Above 1000 MHz, compliance with the emission limits in Section 15.209 shall be demonstrated based on the average value of the measured emissions. The provisions of 15.35 apply to these measurements.</p>	MHz	MHz	MHz	GHz	0.090–0.110	16.42–16.423	399.9–410	4.5–5.15	1.0495–0.505	16.69475–16.69525	608–614	5.35–5.46	2.1735–2.1905	16.80425–16.80475	960–1240	7.25–7.75	4.125–4.128	25.5–25.67	1300–1427	8.025–8.5	4.17725–4.17775	37.5–38.25	1435–1626.5	9.0–9.2	4.20725–4.20775	73–74.6	1645.5–1646.5	9.3–9.5	6.215–6.218	74.8–75.2	1660–1710	10.6–12.7	6.26775–6.26825	108–121.94	1718.8–1722.2	13.25–13.4	6.31175–6.31225	123–138	2200–2300	14.47–14.5	8.291–8.294	149.9–150.05	2310–2390	15.35–16.2	8.362–8.366	156.52475–156.52525	2483.5–2500	17.7–21.4	8.37625–8.38675	156.7–156.9	2655–2900	22.01–23.12	8.41425–8.41475	162.0125–167.17	3260–3267	23.6–24.0	12.29–12.293	167.72–173.2	3332–3339	31.2–31.8	12.51975–12.52025	240–285	3345.8–3358	36.43–36.5	12.57675–12.57725	322–335.4	3600–4400	(²)	13.36–13.41			
MHz	MHz	MHz	GHz																																																																						
0.090–0.110	16.42–16.423	399.9–410	4.5–5.15																																																																						
1.0495–0.505	16.69475–16.69525	608–614	5.35–5.46																																																																						
2.1735–2.1905	16.80425–16.80475	960–1240	7.25–7.75																																																																						
4.125–4.128	25.5–25.67	1300–1427	8.025–8.5																																																																						
4.17725–4.17775	37.5–38.25	1435–1626.5	9.0–9.2																																																																						
4.20725–4.20775	73–74.6	1645.5–1646.5	9.3–9.5																																																																						
6.215–6.218	74.8–75.2	1660–1710	10.6–12.7																																																																						
6.26775–6.26825	108–121.94	1718.8–1722.2	13.25–13.4																																																																						
6.31175–6.31225	123–138	2200–2300	14.47–14.5																																																																						
8.291–8.294	149.9–150.05	2310–2390	15.35–16.2																																																																						
8.362–8.366	156.52475–156.52525	2483.5–2500	17.7–21.4																																																																						
8.37625–8.38675	156.7–156.9	2655–2900	22.01–23.12																																																																						
8.41425–8.41475	162.0125–167.17	3260–3267	23.6–24.0																																																																						
12.29–12.293	167.72–173.2	3332–3339	31.2–31.8																																																																						
12.51975–12.52025	240–285	3345.8–3358	36.43–36.5																																																																						
12.57675–12.57725	322–335.4	3600–4400	(²)																																																																						
13.36–13.41																																																																									
FCC CFR 47 §15.209	<p>(a) Except as provided elsewhere in this Subpart, the emissions from an intentional radiator shall not exceed the field strength levels specified in the following table:</p> <table border="1" style="width: 100%; border-collapse: collapse;"> <thead> <tr> <th style="width: 33%;">Frequency</th> <th style="width: 33%;">Field Strength</th> <th style="width: 34%;">Measurement Distance</th> </tr> <tr> <th style="text-align: center;">MHz</th> <th style="text-align: center;">uV/m</th> <th style="text-align: center;">Meters</th> </tr> </thead> <tbody> <tr><td style="text-align: center;">.009 – 0.490</td><td style="text-align: center;">2400/F(kHz)</td><td style="text-align: center;">300</td></tr> <tr><td style="text-align: center;">0.490 – 1.705</td><td style="text-align: center;">24000/F(kHz)</td><td style="text-align: center;">30</td></tr> <tr><td style="text-align: center;">1.705 – 30.0</td><td style="text-align: center;">30</td><td style="text-align: center;">30</td></tr> <tr><td style="text-align: center;">30 – 88</td><td style="text-align: center;">100</td><td style="text-align: center;">3</td></tr> <tr><td style="text-align: center;">88 – 216</td><td style="text-align: center;">150</td><td style="text-align: center;">3</td></tr> <tr><td style="text-align: center;">216 - 960</td><td style="text-align: center;">200</td><td style="text-align: center;">3</td></tr> <tr><td style="text-align: center;">Above 960</td><td style="text-align: center;">500</td><td style="text-align: center;">3</td></tr> </tbody> </table> <p>(b) In the emission table above, the tighter limit applies at the band edges.</p>	Frequency	Field Strength	Measurement Distance	MHz	uV/m	Meters	.009 – 0.490	2400/F(kHz)	300	0.490 – 1.705	24000/F(kHz)	30	1.705 – 30.0	30	30	30 – 88	100	3	88 – 216	150	3	216 - 960	200	3	Above 960	500	3																																													
Frequency	Field Strength	Measurement Distance																																																																							
MHz	uV/m	Meters																																																																							
.009 – 0.490	2400/F(kHz)	300																																																																							
0.490 – 1.705	24000/F(kHz)	30																																																																							
1.705 – 30.0	30	30																																																																							
30 – 88	100	3																																																																							
88 – 216	150	3																																																																							
216 - 960	200	3																																																																							
Above 960	500	3																																																																							

Test Report S/N:	052604-514KBC
Test Date(s):	28Jun04 - 29Jul04
Test Type:	FCC Part 15.247

F.3. ENVIRONMENTAL CONDITIONS	
Temperature	27.4 +/- 2 °C
Humidity	33 +/- 2 %
Barometric Pressure	96.24 +/- 0.2 kPa

F.4. EQUIPMENT LIST					
ASSET NUMBER	MANUFACTURER	MODEL	DESCRIPTION	LAST CAL	CAL DUE
00072	EMCO	2075	Mini-mast	n/a	n/a
00073	EMCO	2080	Turn Table	n/a	n/a
00071	EMCO	2090	Multi-Device Controller	n/a	n/a
00200	Empire	LG-105	Large Loop Antenna	30Apr04	30Apr05
00201	Empire	LC-105	Small Loop Antenna	30Apr04	30Apr05
00050	Chase	CBL-6111A	Bilog Antenna	30Apr04	30Apr05
00035	ETS	3115	Double Ridged Guide Horn	24Mar04	24Mar05
00202	ETS	3160-09	Small Horn Antenna	27May04	27Jun05
00015	Agilent	E4408B	Spectrum Analyzer	29Dec03	29Dec04
00049	HP	8566B	Spectrum Analyzer RF Section	18May04	18May05
00049	HP	85650A	Quasi-peak Adapter	18May04	18May05
00047	HP	85685A	RF Preselector	18May04	18May05
00048	Gore	65474	Microwave Cable	20May04	20May05
00030	HP	83017A	LNA	20May04	20May05

Itronix Corporation	Model: IX260+	FCC ID:	KBCIX260PROGC82
Rugged Laptop PC with internal WLAN (802.11b/g) & Dual-Band GSM GPRS/EDGE Modem			
2004 Celltech Labs Inc	This document is not to be reproduced in whole or in part without the written permission of Celltech Labs Inc.		50 of 80

Test Report S/N:	052604-514KBC
Test Date(s):	28Jun04 - 29Jul04
Test Type:	FCC Part 15.247

F.5. MEASUREMENT EQUIPMENT SETUP

MEASUREMENT EQUIPMENT CONNECTIONS	The measurement equipment was connected as shown in the F.6. A number of antennas were used to cover the applicable frequency range test. The ranges in which each antenna was used are as follows:			
	Frequency Range	Antenna		
	9 kHz – 150 kHz	LP-105 Loop		
	150 kHz – 30 MHz	LG-105 Loop		
	30 MHz – 1 GHz	CBL-6111A Bilog		
	1 GHz – 18 GHz	ETS 3115 Horn		
	18 GHz– 26GHz	ETS 3160-09 Horn		
MEASUREMENT EQUIPMENT SETTINGS	The spectrum analyzer was set to the following settings:			
	Frequency Range	RBW	VBW	Detector
	MHz	kHz	kHz	
	0.009 - 0.150	0.200	10	Peak*
	0.150 - 30	9	30	Peak*
	30 – 1000	100	300	Peak*
> 1000	1000*	1000	Peak*	
*As a worse case measurement, the average/quasi-peak limits were applied to measurements made with a peak detector.				

F.6. SETUP DRAWING

Figure F-1 – Setup Drawing

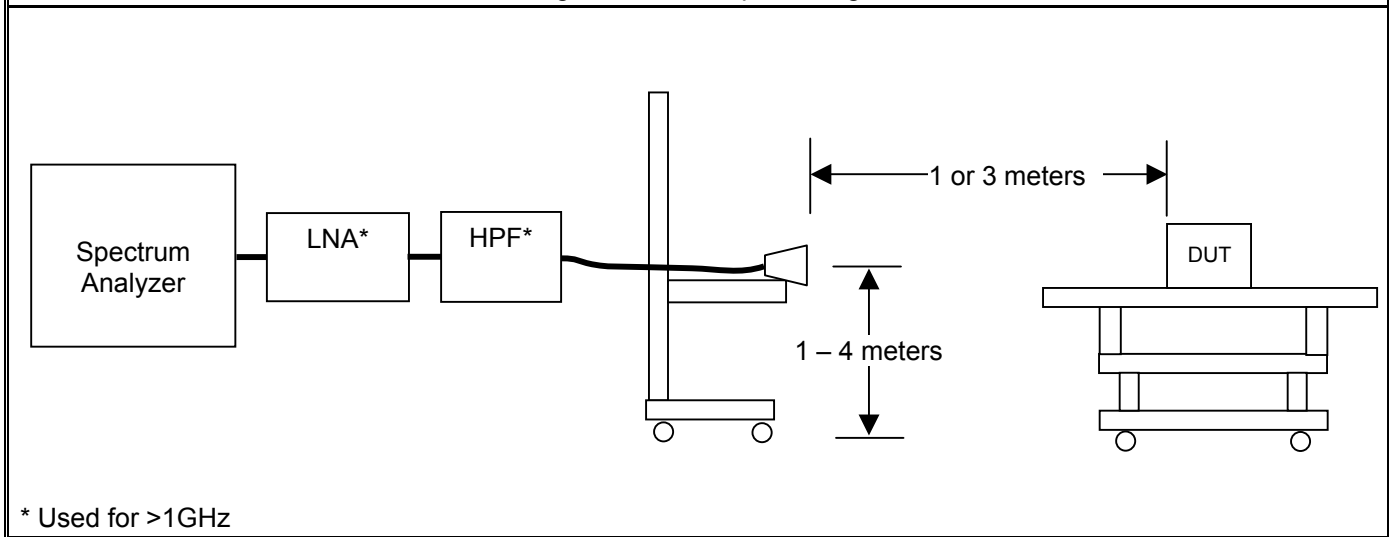

* Used for >1GHz

Test Report S/N:	052604-514KBC
Test Date(s):	28Jun04 - 29Jul04
Test Type:	FCC Part 15.247

F.7. SETUP PHOTOGRAPHS

Photograph F-1 - Horizontal Polarization (30MHz – 1 GHz)



Photograph F-2 - Vertical Polarization (30MHz – 1 GHz)



Photograph F-3 - Front of Radiated Emission Configuration



Photograph F-4 - Back of Radiated Emission Configuration

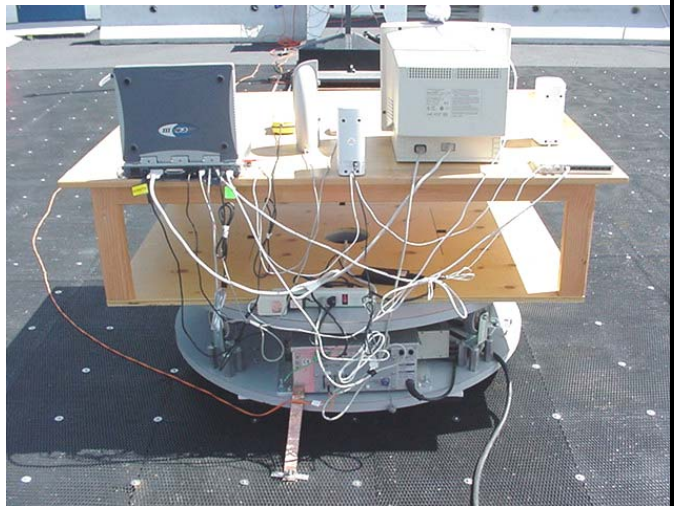

Itronix Corporation

Model: IX260+

FCC ID:

KBCIX260PROGC82

Rugged Laptop PC with internal WLAN (802.11b/g) & Dual-Band GSM GPRS/EDGE Modem

Test Report S/N:	052604-514KBC
Test Date(s):	28Jun04 - 29Jul04
Test Type:	FCC Part 15.247

F.8. DUT OPERATING DESCRIPTION

The worst-case data rate was determined from prescan investigations. Measurements were made at three channels throughout the band, Low Channel (2412 MHz), Mid Channel (2437 MHz), High Channel (2462 MHz) and for both Modes b and g for the band-edge measurements and for Mode b for the remaining measurements.

F.9. TEST RESULTS

F.9.1. Mode b - Band-edge Emission Field Strengths @ Specified Distance – Horizontal Polarization (near restricted band)

Channel	Polarity	Measurement Distance	Antenna	Frequency	SA Level	Noise Floor	Antenna Factor	Cable Factor	Other Factors	Total CF	Field Strength	Detector	Limit Distance	Limit Distance Correction	Limit	Margin	Pass/Fail
													m	dB	dBuV/m	Δ dB	
1	H	3	Horn SN6276	2390.00	28.40		28.06	3.47	0.00	31.53	59.93	PK	3.00	0.00	73.98	14.05	PASS
1	H	3	Horn SN6276	2390.00	17.00		28.06	3.47	0.00	31.53	48.53	AV	3.00	0.00	53.98	5.45	PASS
11	H	3	Horn SN6276	2483.50	27.20		28.26	3.51	0.00	31.78	58.98	PK	3.00	0.00	73.98	15.00	PASS
11	H	3	Horn SN6276	2483.50	17.30		28.26	3.51	0.00	31.78	49.08	AV	3.00	0.00	53.98	4.90	PASS

F.9.2. Mode b - Band-edge Emission Field Strengths @ Specified Distance - Vertical Polarization (near restricted band)

1	V	3	Horn SN6276	2390.00	28.40		28.06	3.47	0.00	31.53	59.93	PK	3.00	0.00	73.98	14.05	PASS
1	V	3	Horn SN6276	2390.00	17.00		28.06	3.47	0.00	31.53	48.53	AV	3.00	0.00	53.98	5.45	PASS
11	V	3	Horn SN6276	2483.50	26.50		28.26	3.51	0.00	31.78	58.28	PK	3.00	0.00	73.98	15.70	PASS
11	V	3	Horn SN6276	2483.50	16.80		28.26	3.51	0.00	31.78	48.58	AV	3.00	0.00	53.98	5.40	PASS

Formulae:

Total CF = Antenna Factor + Cable Factor + Other Factor (Amplifier Gain, filter loss, etc)

Field Strength = SA Reading + Total CF

Limit Distance Correction = $40 \cdot \log(d1/d2)$ for $F < 30$ MHz, $20 \cdot \log(d1/d2)$ for $F > 30$ MHz:

where d1 is the measurement distance, d2 is the published limit distance

Limit = Specified Limit + Limit Distance Correction

Margin = Limit - Field Strength

Test Report S/N:	052604-514KBC
Test Date(s):	28Jun04 - 29Jul04
Test Type:	FCC Part 15.247

F.9.3. Mode g - Band-edge Emission Field Strengths @ Specified Distance – Horizontal Polarization (near restricted band)

Channel	Polarity	Measurement Distance	Antenna	Frequency	SA Level	Noise Floor	Antenna Factor	Cable Factor	Other Factors	Total CF	Field Strength	Detector	Limit Distance	Limit Distance Correction	Limit	Margin	Pass/Fail
							dB/m	dB	dB	dB/m	dBuV/m		m	dB			
1	H	3	Horn SN6276	2390.00	31.20		28.06	3.47	0.00	31.53	62.73	PK	3.00	0.00	73.98	11.25	PASS
1	H	3	Horn SN6276	2390.00	18.90		28.06	3.47	0.00	31.53	50.43	AV	3.00	0.00	53.98	3.55	PASS
11	H	3	Horn SN6276	2483.50	35.20		28.26	3.51	0.00	31.78	66.98	PK	3.00	0.00	73.98	7.00	PASS
11	H	3	Horn SN6276	2483.50	20.90		28.26	3.51	0.00	31.78	52.68	AV	3.00	0.00	53.98	1.30	PASS

F.9.4. Mode g - Band-edge Emission Field Strengths @ Specified Distance - Vertical Polarization (near restricted band)

1	V	3	Horn SN6276	2390.00	28.10		28.06	3.47	0.00	31.53	59.63	PK	3.00	0.00	73.98	14.35	PASS
1	V	3	Horn SN6276	2390.00	17.40		28.06	3.47	0.00	31.53	48.93	AV	3.00	0.00	53.98	5.05	PASS
11	V	3	Horn SN6276	2483.50	31.10		28.26	3.51	0.00	31.78	62.88	PK	3.00	0.00	73.98	11.10	PASS
11	V	3	Horn SN6276	2483.50	18.30		28.26	3.51	0.00	31.78	50.08	AV	3.00	0.00	53.98	3.90	PASS

Formulae:

Total CF = Antenna Factor + Cable Factor + Other Factor (Amplifier Gain, filter loss, etc)

Field Strength = SA Reading + Total CF

Limit Distance Correction = $40 \cdot \log(d1/d2)$ for $F < 30$ MHz, $20 \cdot \log(d1/d2)$ for $F > 30$ MHz:

where d1 is the measurement distance, d2 is the published limit distance

Limit = Specified Limit + Limit Distance Correction

Margin = Limit - Field Strength

Test Report S/N:	052604-514KBC
Test Date(s):	28Jun04 - 29Jul04
Test Type:	FCC Part 15.247

F.9.5. Channel 1 Restricted Band Spurious Emission Field Strengths @ Specified Distance – Horizontal Polarization

Channel	Polarity	Measurement Distance	Antenna	Frequency	SA Level	Noise Floor	Antenna Factor	Cable Factor	Other Factors	Total CF	Field Strength	Detector	Limit Distance	Limit Distance Correction	15.209 (a) Limit	Margin	Pass/Fail
													m	dB	dBuV/m		
1	H	3	Bilog SN1607	57.48	49.20		5.53	0.53	0.00	6.06	55.26	PK	3.00	0.00	60.00	4.74	PASS
1	H	3	Bilog SN1607	99.52	35.20		9.90	0.84	0.00	10.75	45.95	PK	3.00	0.00	63.52	17.57	PASS
1	H	3	Bilog SN1607	107.28	36.80		10.65	0.89	0.00	11.55	48.35	PK	3.00	0.00	63.52	15.17	PASS
1	H	3	Bilog SN1607	167.09	32.00		9.40	0.98	0.00	10.39	42.39	PK	3.00	0.00	63.52	21.14	PASS
1	H	3	Bilog SN1607	208.48	27.30		8.25	1.04	0.00	9.29	36.59	PK	3.00	0.00	63.52	26.93	PASS
1	H	3	Bilog SN1607	245.34	30.00		11.79	1.10	0.00	12.89	42.89	PK	3.00	0.00	66.02	23.14	PASS
1	H	3	Bilog SN1607	380.82	35.30		15.43	1.30	0.00	16.73	52.03	PK	3.00	0.00	66.02	13.99	PASS
1	H	3	Bilog SN1607	787.89	20.30		22.46	1.90	0.00	24.36	44.66	PK	3.00	0.00	66.02	21.36	PASS
1	H	3	Bilog SN1607	855.15	31.30		23.55	1.99	0.00	25.54	56.84	PK	3.00	0.00	66.02	9.18	PASS
1	H	3	Bilog SN1607	931.78	36.00		24.89	2.11	0.00	27.00	63.00	PK	3.00	0.00	66.02	3.02	PASS
1	H	3	Horn SN6276	2500.00	42.60		28.30	3.51	-36.42	-4.61	37.99	PK	3.00	0.00	73.98	35.99	PASS
1	H	3	Horn SN6276	4810.00	22.60	x	32.88	4.96	0.00	37.85	60.45	PK	3.00	0.00	73.98	13.53	PASS
1	H	3	Horn SN6276	5240.00	23.30	x	33.68	5.22	0.00	38.91	62.21	PK	3.00	0.00	73.98	11.77	PASS
1	H	3	Horn SN6276	7230.00	38.90	x	35.71	6.27	-35.51	6.47	45.37	PK	3.00	0.00	73.98	28.61	PASS
1	H	3	Horn SN6276	9610.00	37.10		37.59	7.37	-35.71	9.25	46.35	PK	3.00	0.00	73.98	27.63	PASS
1	H	3	Horn SN6276	17660.00	38.00	x	44.88	10.46	-36.36	18.98	56.98	PK	3.00	0.00	73.98	17.00	PASS
1	H	1	3160-09	19296.00	52.98		40.26	11.01	-35.81	15.45	68.43	PK	3.00	9.54	83.52	15.09	PASS
1	H	1	3160-09	19296.00	34.05		40.26	11.01	-35.81	15.45	49.50	AV	3.00	9.54	63.52	14.02	PASS
1	H	1	3160-09	21708.00	53.65		40.30	11.91	-35.73	16.48	70.13	PK	3.00	9.54	83.52	13.39	PASS
1	H	1	3160-09	21708.00	35.74		40.30	11.91	-35.73	16.48	52.22	AV	3.00	9.54	63.52	11.30	PASS
1	H	1	3160-09	24120.00	56.09		40.40	12.81	-35.73	17.48	73.57	PK	3.00	9.54	83.52	9.95	PASS
1	H	1	3160-09	24120.00	37.57		40.40	12.81	-35.73	17.48	55.05	AV	3.00	9.54	63.52	8.47	PASS
1	H	1	3160-09	24490.00	57.15		40.40	12.95	-35.73	17.62	74.77	PK	3.00	9.54	83.52	8.75	PASS
1	H	1	3160-09	24490.00	38.00		40.40	12.95	-35.73	17.62	55.62	AV	3.00	9.54	63.52	7.90	PASS

Formulae:

Total CF = Antenna Factor + Cable Factor + Other Factor (Amplifier Gain, filter loss, etc)

Field Strength = SA Reading + Total CF

Limit Distance Correction = 40*log(d1/d2) for F<30 MHz, 20*log(d1/d2) for F> 30 MHz:

where d1 is the measurement distance, d2 is the published limit distance

Limit = Specified Limit + Limit Distance Correction

Margin = Limit - Field Strength

*No emissions within the restricted bands where measured above the levels noted

Itronix Corporation	Model: IX260+	FCC ID:	KBCIX260PROGC82
Rugged Laptop PC with internal WLAN (802.11b/g) & Dual-Band GSM GPRS/EDGE Modem			
2004 Celltech Labs Inc	This document is not to be reproduced in whole or in part without the written permission of Celltech Labs Inc.		55 of 80

Test Report S/N:	052604-514KBC
Test Date(s):	28Jun04 - 29Jul04
Test Type:	FCC Part 15.247

F.9.6. Channel 1 Restricted Band Spurious Emission Field Strengths @ Specified Distance – Vertical Polarization

Channel	Polarity	Measurement Distance	Antenna	Frequency	SA Level	Noise Floor	Antenna Factor	Cable Factor	Other Factors	Total CF	Field Strength	Detector	Limit Distance	Limit Distance Correction	15.209 (a) Limit	Margin	Pass/Fail
													m	dB	dBuV/m		
1	V	3	LP-105	0.08	17.37		48.70	0.03	0.00	48.73	66.10	PK	300.00	80.00	143.54	77.44	PASS
1	V	3	LG-105	0.20	1.41		59.86	0.07	0.00	59.94	61.35	PK	300.00	80.00	134.52	73.17	PASS
1	V	3	LG-105	0.49	2.42		58.03	0.09	0.00	58.12	60.54	PK	300.00	80.00	114.16	53.62	PASS
1	V	3	LG-105	1.50	9.04		53.10	0.15	0.00	53.25	62.29	PK	30.00	40.00	84.80	22.51	PASS
1	V	3	LG-105	2.62	7.21		50.69	0.20	0.00	50.89	58.10	PK	30.00	40.00	89.54	31.44	PASS
1	V	3	LG-105	5.48	11.74		44.38	0.31	0.00	44.68	56.42	PK	30.00	40.00	89.54	33.12	PASS
1	V	3	LG-105	27.15	10.24		40.62	0.68	0.00	41.30	51.54	PK	30.00	40.00	89.54	38.00	PASS
1	V	3	Bilog SN1607	99.52	29.60		9.90	0.84	0.00	10.75	40.35	PK	3.00	0.00	63.52	23.17	PASS
1	V	3	Bilog SN1607	208.80	46.80		8.28	1.04	0.00	9.32	56.12	PK	3.00	0.00	63.52	7.40	PASS
1	V	3	Bilog SN1607	245.34	52.50		11.79	1.10	0.00	12.89	65.39	PK	3.00	0.00	66.02	0.64	PASS
1	V	3	Bilog SN1607	449.36	44.80		17.03	1.40	0.00	18.43	63.23	PK	3.00	0.00	66.02	2.79	PASS
1	V	3	Bilog SN1607	736.16	23.70		22.93	1.82	0.00	24.75	48.45	PK	3.00	0.00	66.02	17.57	PASS
1	V	3	Horn SN6276	3200.00	43.50		30.48	4.04	-35.93	-1.40	42.10	PK	3.00	0.00	73.98	31.88	PASS
1	V	3	Horn SN6276	4810.00	47.00		32.88	4.96	-35.30	2.54	49.54	PK	3.00	0.00	73.98	24.44	PASS
1	V	3	Horn SN6276	5260.00	40.10		33.72	5.23	-35.34	3.61	43.71	PK	3.00	0.00	73.98	30.27	PASS
1	V	3	Horn SN6276	5720.00	41.60		34.19	5.44	-35.38	4.25	45.85	PK	3.00	0.00	73.98	28.13	PASS
1	V	3	Horn SN6276	5770.00	44.80		34.21	5.45	-35.38	4.28	49.08	PK	3.00	0.00	73.98	24.90	PASS
1	V	3	Horn SN6276	7520.00	40.40		36.32	6.43	-35.53	7.21	47.61	PK	3.00	0.00	73.98	26.37	PASS
1	V	3	Horn SN6276	8360.00	37.60		37.06	6.79	-35.60	8.25	45.85	PK	3.00	0.00	73.98	28.13	PASS
1	V	3	Horn SN6276	9610.00	36.60		37.59	7.37	-35.71	9.25	45.85	PK	3.00	0.00	73.98	28.13	PASS
1	V	3	Horn SN6276	12640.00	36.90		38.71	8.68	-36.79	10.59	47.49	PK	3.00	0.00	73.98	26.49	PASS
1	V	3	Horn SN6276	15740.00	38.20		37.56	9.77	-36.53	10.80	49.00	PK	3.00	0.00	73.98	24.98	PASS
1	V	3	Horn SN6276	17770.00	37.60		45.70	10.30	-36.35	19.65	57.25	PK	3.00	0.00	73.98	16.73	PASS

Formulae:

Total CF = Antenna Factor + Cable Factor + Other Factor (Amplifier Gain, filter loss, etc)

Field Strength = SA Reading + Total CF

Limit Distance Correction = $40 \cdot \log(d1/d2)$ for $F < 30$ MHz, $20 \cdot \log(d1/d2)$ for $F > 30$ MHz:

where d1 is the measurement distance, d2 is the published limit distance

Limit = Specified Limit + Limit Distance Correction

Margin = Limit - Field Strength

*No emissions within the restricted bands where measured above the levels noted

Continued

Itronix Corporation	Model: IX260+	FCC ID:	KBCIX260PROGC82
Rugged Laptop PC with internal WLAN (802.11b/g) & Dual-Band GSM GPRS/EDGE Modem			
2004 Celltech Labs Inc	This document is not to be reproduced in whole or in part without the written permission of Celltech Labs Inc.		56 of 80

Test Report S/N:	052604-514KBC
Test Date(s):	28Jun04 - 29Jul04
Test Type:	FCC Part 15.247

Continued

Channel	Polarity	Measurement Distance	Antenna	Frequency	SA Level	Noise Floor	Antenna Factor	Cable Factor	Other Factors	Total CF	Field Strength	Detector	Limit Distance	Limit Distance Correction	15.209 (a) Limit	Margin	Pass/Fail
													m	dB	dBuV/m		
1	V	1	3160-09	18820.00	53.92		40.20	11.05	-35.87	15.38	69.30	PK	3.00	9.54	83.52	14.22	PASS
1	V	1	3160-09	18820.00	33.66		40.20	11.05	-35.87	15.38	49.04	AV	3.00	9.54	63.52	14.48	PASS
1	V	1	3160-09	19296.00	52.65		40.26	11.01	-35.81	15.45	68.10	PK	3.00	9.54	83.52	15.42	PASS
1	V	1	3160-09	19296.00	33.76		40.26	11.01	-35.81	15.45	49.21	AV	3.00	9.54	63.52	14.31	PASS
1	V	1	3160-09	21708.00	53.27		40.30	11.91	-35.73	16.48	69.75	PK	3.00	9.54	83.52	13.77	PASS
1	V	1	3160-09	21708.00	36.04		40.30	11.91	-35.73	16.48	52.52	AV	3.00	9.54	63.52	11.00	PASS
1	V	1	3160-09	24120.00	56.03		40.40	12.81	-35.73	17.48	73.51	PK	3.00	9.54	83.52	10.01	PASS
1	V	1	3160-09	24120.00	37.21		40.40	12.81	-35.73	17.48	54.69	AV	3.00	9.54	63.52	8.83	PASS
1	V	1	3160-09	24550.00	56.31		40.40	12.97	-35.73	17.64	73.95	PK	3.00	9.54	83.52	9.57	PASS
1	V	1	3160-09	24550.00	38.30		40.40	12.97	-35.73	17.64	55.94	AV	3.00	9.54	63.52	7.58	PASS

Formulae:

Total CF = Antenna Factor + Cable Factor + Other Factor (Amplifier Gain, filter loss, etc)

Field Strength = SA Reading + Total CF

Limit Distance Correction = $40 \cdot \log(d1/d2)$ for $F < 30$ MHz, $20 \cdot \log(d1/d2)$ for $F > 30$ MHz:

where d1 is the measurement distance, d2 is the published limit distance

Limit = Specified Limit + Limit Distance Correction

Margin = Limit - Field Strength

*No emissions within the restricted bands where measured above the levels noted

Itronix Corporation	Model: IX260+	FCC ID:	KBCIX260PROGC82
Rugged Laptop PC with internal WLAN (802.11b/g) & Dual-Band GSM GPRS/EDGE Modem			
2004 Celltech Labs Inc	This document is not to be reproduced in whole or in part without the written permission of Celltech Labs Inc.		57 of 80

Test Report S/N:	052604-514KBC
Test Date(s):	28Jun04 - 29Jul04
Test Type:	FCC Part 15.247

F.9.7. Channel 6 Restricted Band Spurious Emission Field Strengths @ Specified Distance – Horizontal Polarization

Channel	Polarity	Measurement Distance	Antenna	Frequency	SA Level	Noise Floor	Antenna Factor	Cable Factor	Other Factors	Total CF	Field Strength	Detector	Limit Distance	Limit Distance Correction	15.209 (a) Limit	Margin	Pass/Fail
													m	dB	dBuV/m		
6	H	3	Bilog SN1607	60.70	29.20		5.03	0.56	0.00	5.59	34.79	PK	3.00	0.00	60.00	25.21	PASS
6	H	3	Bilog SN1607	107.28	36.50		10.65	0.89	0.00	11.55	48.05	PK	3.00	0.00	63.52	15.47	PASS
6	H	3	Bilog SN1607	149.96	34.10		10.70	0.96	0.00	11.66	45.76	PK	3.00	0.00	63.52	17.76	PASS
6	H	3	Bilog SN1607	208.48	29.70		8.25	1.04	0.00	9.29	38.99	PK	3.00	0.00	63.52	24.53	PASS
6	H	3	Bilog SN1607	245.34	34.80		11.79	1.10	0.00	12.89	47.69	PK	3.00	0.00	66.02	18.34	PASS
6	H	3	Bilog SN1607	786.92	24.50		22.47	1.89	0.00	24.36	48.86	PK	3.00	0.00	66.02	17.16	PASS
6	H	3	Bilog SN1607	929.51	19.50		24.83	2.10	0.00	26.94	46.44	PK	3.00	0.00	66.02	19.58	PASS
6	H	3	Horn SN6276	2750.00	38.60		29.15	3.69	-36.38	-3.53	35.07	PK	3.00	0.00	73.98	38.91	PASS
6	H	3	Horn SN6276	3240.00	37.00		30.58	4.06	-36.12	-1.48	35.52	PK	3.00	0.00	73.98	38.46	PASS
6	H	3	Horn SN6276	4860.00	36.70		32.99	5.02	-35.46	2.55	39.25	PK	3.00	0.00	73.98	34.73	PASS
6	H	3	Horn SN6276	5260.00	45.20		33.72	5.23	-35.47	3.47	48.67	PK	3.00	0.00	73.98	25.31	PASS
6	H	3	Horn SN6276	5770.00	37.20		34.21	5.45	-35.50	4.16	41.36	PK	3.00	0.00	73.98	32.61	PASS
6	H	3	Horn SN6276	8280.00	38.40		36.98	6.75	-35.61	8.11	46.51	PK	3.00	0.00	73.98	27.47	PASS
6	H	3	Horn SN6276	8360.00	42.30		37.06	6.79	-35.62	8.24	50.54	PK	3.00	0.00	73.98	23.44	PASS
6	H	3	Horn SN6276	17090.00	39.20		41.24	10.38	-36.09	15.54	54.74	PK	3.00	0.00	73.98	19.24	PASS
6	H	1	3160-09	19496.00	52.56		40.30	11.28	-35.79	15.79	68.35	PK	3.00	9.54	83.52	15.17	PASS
6	H	1	3160-09	19496.00	33.91		40.30	11.28	-35.79	15.79	49.70	AV	3.00	9.54	63.52	13.82	PASS
6	H	1	3160-09	21240.00	54.98		40.30	11.73	-35.73	16.31	71.29	PK	3.00	9.54	83.52	12.23	PASS
6	H	1	3160-09	21240.00	35.72		40.30	11.73	-35.73	16.31	52.03	AV	3.00	9.54	63.52	11.49	PASS
6	H	1	3160-09	21933.00	54.66		40.30	11.99	-35.73	16.57	71.23	PK	3.00	9.54	83.52	12.30	PASS
6	H	1	3160-09	21933.00	36.27		40.30	11.99	-35.73	16.57	52.84	AV	3.00	9.54	63.52	10.69	PASS
6	H	1	3160-09	24370.00	57.10		40.40	12.90	-35.73	17.58	74.68	PK	3.00	9.54	83.52	8.84	PASS
6	H	1	3160-09	24370.00	37.88		40.40	12.90	-35.73	17.58	55.46	AV	3.00	9.54	63.52	8.06	PASS
6	H	1	3160-09	24420.00	56.93		40.40	12.92	-35.73	17.60	74.53	PK	3.00	9.54	83.52	9.00	PASS
6	H	1	3160-09	24420.00	37.73		40.40	12.92	-35.73	17.60	55.33	AV	3.00	9.54	63.52	8.20	PASS

Formulae:

Total CF = Antenna Factor + Cable Factor + Other Factor (Amplifier Gain, filter loss, etc)

Field Strength = SA Reading + Total CF

Limit Distance Correction = 40*log(d1/d2) for F<30 MHz, 20*log(d1/d2) for F> 30 MHz:

where d1 is the measurement distance, d2 is the published limit distance

Limit = Specified Limit + Limit Distance Correction

Margin = Limit - Field Strength

*No emissions within the restricted bands where measured above the levels noted

Itronix Corporation	Model: IX260+	FCC ID:	KBCIX260PROGC82
Rugged Laptop PC with internal WLAN (802.11b/g) & Dual-Band GSM GPRS/EDGE Modem			
2004 Celltech Labs Inc	This document is not to be reproduced in whole or in part without the written permission of Celltech Labs Inc.		58 of 80

Test Report S/N:	052604-514KBC
Test Date(s):	28Jun04 - 29Jul04
Test Type:	FCC Part 15.247

F.9.8. Channel 6 Restricted Band Spurious Emission Field Strengths @ Specified Distance – Vertical Polarization

Channel	Polarity	Measurement Distance	Antenna	Frequency	SA Level	Noise Floor	Antenna Factor	Cable Factor	Other Factors	Total CF	Field Strength	Detector	Limit Distance	Limit Distance Correction	15.209 (a) Limit	Margin	Pass/Fail
													m	dB	dBuV/m		
6	V	3	LP-105	0.08	17.57		48.71	0.05	0.00	48.76	66.33	PK	300.00	80.00	143.55	77.22	PASS
6	V	3	LG-105	2.03	9.04		52.21	0.17	0.00	52.39	61.43	PK	30.00	40.00	89.54	28.11	PASS
6	V	3	LG-105	0.83	2.38		57.38	0.11	0.00	57.49	59.87	PK	30.00	40.00	90.77	30.90	PASS
6	V	3	LG-105	1.50	8.52		53.11	0.15	0.00	53.26	61.78	PK	30.00	40.00	84.82	23.04	PASS
6	V	3	LG-105	3.22	8.34		49.31	0.23	0.00	49.54	57.88	PK	30.00	40.00	89.54	31.66	PASS
6	V	3	LG-105	5.63	12.44		44.09	0.31	0.00	44.40	56.84	PK	30.00	40.00	89.54	32.70	PASS
6	V	3	LG-105	17.80	9.89		41.04	0.55	0.00	41.59	51.48	PK	30.00	40.00	89.54	38.06	PASS
6	V	3	Bilog SN1607	57.48	30.80		5.53	0.53	0.00	6.06	36.86	PK	3.00	0.00	60.00	23.14	PASS
6	V	3	Bilog SN1607	99.52	28.50		9.90	0.84	0.00	10.75	39.25	PK	3.00	0.00	63.52	24.27	PASS
6	V	3	Bilog SN1607	103.72	27.90		10.33	0.88	0.00	11.21	39.11	PK	3.00	0.00	63.52	24.41	PASS
6	V	3	Bilog SN1607	138.96	37.30		11.14	0.94	0.00	12.08	49.38	PK	3.00	0.00	63.52	14.14	PASS
6	V	3	Bilog SN1607	166.77	24.50		9.43	0.98	0.00	10.41	34.91	PK	3.00	0.00	63.52	28.61	PASS
6	V	3	Bilog SN1607	196.19	31.70		8.47	1.03	0.00	9.49	41.19	PK	3.00	0.00	63.52	22.33	PASS
6	V	3	Bilog SN1607	196.52	29.70		8.44	1.03	0.00	9.47	39.17	PK	3.00	0.00	63.52	24.35	PASS
6	V	3	Bilog SN1607	246.96	28.50		11.97	1.10	0.00	13.07	41.57	PK	3.00	0.00	66.02	24.46	PASS
6	V	3	Bilog SN1607	306.45	27.50		13.40	1.19	0.00	14.58	42.08	PK	3.00	0.00	66.02	23.94	PASS
6	V	3	Bilog SN1607	772.70	37.20		22.57	1.87	0.00	24.45	61.65	PK	3.00	0.00	66.02	4.37	PASS
6	V	3	Bilog SN1607	952.47	34.80		25.36	2.14	0.00	27.50	62.30	PK	3.00	0.00	66.02	3.72	PASS
6	V	3	Horn SN6276	2830.00	37.90		29.42	3.75	-36.33	-3.16	34.74	PK	3.00	0.00	73.98	39.24	PASS
6	V	3	Horn SN6276	5240.00	37.30		33.68	5.22	-35.47	3.43	40.73	PK	3.00	0.00	73.98	33.24	PASS
6	V	3	Horn SN6276	5770.00	40.10		34.21	5.45	-35.50	4.16	44.26	PK	3.00	0.00	73.98	29.71	PASS
6	V	3	Horn SN6276	7520.00	37.80		36.32	6.43	-35.58	7.17	44.97	PK	3.00	0.00	73.98	29.01	PASS

Formulae:

Total CF = Antenna Factor + Cable Factor + Other Factor (Amplifier Gain, filter loss, etc)

Field Strength = SA Reading + Total CF

Limit Distance Correction = 40*log(d1/d2) for F<30 MHz, 20*log(d1/d2) for F> 30 MHz:

where d1 is the measurement distance, d2 is the published limit distance

Limit = Specified Limit + Limit Distance Correction

Margin = Limit - Field Strength

*No emissions within the restricted bands where measured above the levels noted

Continued

Itronix Corporation	Model: IX260+	FCC ID:	KBCIX260PROGC82
Rugged Laptop PC with internal WLAN (802.11b/g) & Dual-Band GSM GPRS/EDGE Modem			
2004 Celltech Labs Inc	This document is not to be reproduced in whole or in part without the written permission of Celltech Labs Inc.		59 of 80

Test Report S/N:	052604-514KBC
Test Date(s):	28Jun04 - 29Jul04
Test Type:	FCC Part 15.247

Continued

Channel	Polarity	Measurement Distance	Antenna	Frequency	SA Level	Noise Floor	Antenna Factor	Cable Factor	Other Factors	Total CF	Field Strength	Detector	Limit Distance	Limit Distance Correction	15.209 (a) Limit	Margin	Pass/Fail
													m	dB	dBuV/m		
6	V	3	Horn SN6276	9720.00	36.80		37.68	7.34	-35.71	9.31	46.11	PK	3.00	0.00	73.98	27.87	PASS
6	V	3	Horn SN6276	16480.00	38.30		38.45	10.25	-36.16	12.54	50.84	PK	3.00	0.00	73.98	23.14	PASS
6	V	1	3160-09	19190.00	54.26		40.24	10.91	-35.83	15.32	69.58	PK	3.00	9.54	83.52	13.94	PASS
6	V	1	3160-09	19190.00	33.78		40.24	10.91	-35.83	15.32	49.10	AV	3.00	9.54	63.52	14.42	PASS
6	V	1	3160-09	19496.00	52.89		40.30	11.28	-35.79	15.79	68.68	PK	3.00	9.54	83.52	14.84	PASS
6	V	1	3160-09	19496.00	33.88		40.30	11.28	-35.79	15.79	49.67	AV	3.00	9.54	63.52	13.85	PASS
6	V	1	3160-09	21933.00	53.99		40.30	11.99	-35.73	16.57	70.56	PK	3.00	9.54	83.52	12.97	PASS
6	V	1	3160-09	21933.00	36.23		40.30	11.99	-35.73	16.57	52.80	AV	3.00	9.54	63.52	10.73	PASS
6	V	1	3160-09	24370.00	55.56		40.40	12.90	-35.73	17.58	73.14	PK	3.00	9.54	83.52	10.38	PASS
6	V	1	3160-09	24370.00	37.88		40.40	12.90	-35.73	17.58	55.46	AV	3.00	9.54	63.52	8.06	PASS
6	V	1	3160-09	24400.00	56.66		40.40	12.91	-35.73	17.59	74.25	PK	3.00	9.54	83.52	9.27	PASS
6	V	1	3160-09	24400.00	37.87		40.40	12.91	-35.73	17.59	55.46	AV	3.00	9.54	63.52	8.06	PASS

Formulae:

Total CF = Antenna Factor + Cable Factor + Other Factor (Amplifier Gain, filter loss, etc)

Field Strength = SA Reading + Total CF

Limit Distance Correction = $40 \cdot \log(d1/d2)$ for $F < 30$ MHz, $20 \cdot \log(d1/d2)$ for $F > 30$ MHz:
 where d1 is the measurement distance, d2 is the published limit distance

Limit = Specified Limit + Limit Distance Correction

Margin = Limit - Field Strength

*No emissions within the restricted bands where measured above the levels noted

Test Report S/N:	052604-514KBC
Test Date(s):	28Jun04 - 29Jul04
Test Type:	FCC Part 15.247

F.9.9. Channel 11 Restricted Band Spurious Emission Field Strengths @ Specified Distance – Horizontal Polarization

Channel	Polarity	Measurement Distance	Antenna	Frequency	SA Level	Noise Floor	Antenna Factor	Cable Factor	Other Factors	Total CF	Field Strength	Detector	Limit Distance	Limit Distance Correction	15.209 (a) Limit	Margin	Pass/Fail
													m	dB	dBuV/m		
11	H	3	Bilog SN1607	57.80	48.10		5.45	0.54	0.00	5.99	54.09	PK	3.00	0.00	60.00	5.91	PASS
11	H	3	Bilog SN1607	101.13	38.90		10.10	0.86	0.00	10.96	49.86	PK	3.00	0.00	63.52	13.66	PASS
11	H	3	Bilog SN1607	141.55	31.30		11.07	0.95	0.00	12.01	43.31	PK	3.00	0.00	63.52	20.21	PASS
11	H	3	Bilog SN1607	208.80	31.20		8.28	1.04	0.00	9.32	40.52	PK	3.00	0.00	63.52	23.00	PASS
11	H	3	Bilog SN1607	297.72	29.20		13.28	1.17	0.00	14.45	43.65	PK	3.00	0.00	66.02	22.37	PASS
11	H	3	Bilog SN1607	381.14	44.00		15.45	1.30	0.00	16.74	60.74	PK	3.00	0.00	66.02	5.28	PASS
11	H	3	Bilog SN1607	772.70	28.40		22.57	1.87	0.00	24.45	52.85	PK	3.00	0.00	66.02	13.17	PASS
11	H	3	Bilog SN1607	944.39	31.30		25.21	2.13	0.00	27.34	58.64	PK	3.00	0.00	66.02	7.38	PASS
11	H	3	Horn SN6276	2810.00	37.50		29.35	3.74	-36.34	-3.25	34.25	PK	3.00	0.00	73.98	39.73	PASS
11	H	3	Horn SN6276	4900.00	39.50		33.08	5.05	-35.46	2.68	42.18	PK	3.00	0.00	73.98	31.80	PASS
11	H	3	Horn SN6276	5260.00	45.80		33.72	5.23	-35.47	3.47	49.27	PK	3.00	0.00	73.98	24.71	PASS
11	H	3	Horn SN6276	8280.00	39.30		36.98	6.75	-35.61	8.11	47.41	PK	3.00	0.00	73.98	26.57	PASS
11	H	3	Horn SN6276	8360.00	42.10		37.06	6.79	-35.62	8.24	50.34	PK	3.00	0.00	73.98	23.64	PASS
11	H	3	Horn SN6276	9820.00	39.00		37.76	7.44	-35.77	9.42	48.42	PK	3.00	0.00	73.98	25.56	PASS
11	H	3	Horn SN6276	15920.00	38.90		37.38	9.83	-36.23	10.98	49.88	PK	3.00	0.00	73.98	24.10	PASS
11	H	1	3160-09	18810.00	53.72		40.20	11.15	-35.87	15.48	69.20	PK	3.00	9.54	83.52	14.33	PASS
11	H	1	3160-09	18810.00	33.94		40.20	11.15	-35.87	15.48	49.42	AV	3.00	9.54	63.52	14.11	PASS
11	H	1	3160-09	19696.00	53.67		40.30	11.42	-35.76	15.95	69.62	PK	3.00	9.54	83.52	13.90	PASS
11	H	1	3160-09	19696.00	33.44		40.30	11.42	-35.76	15.95	49.39	AV	3.00	9.54	63.52	14.13	PASS
11	H	1	3160-09	22158.00	53.69		40.33	12.08	-35.73	16.68	70.37	PK	3.00	9.54	83.52	13.15	PASS
11	H	1	3160-09	22158.00	35.90		40.33	12.08	-35.73	16.68	52.58	AV	3.00	9.54	63.52	10.94	PASS
11	H	1	3160-09	24460.00	56.88		40.40	12.94	-35.73	17.61	74.49	PK	3.00	9.54	83.52	9.03	PASS
11	H	1	3160-09	24460.00	37.32		40.40	12.94	-35.73	17.61	54.93	AV	3.00	9.54	63.52	8.59	PASS
11	H	1	3160-09	24620.00	55.75		40.40	13.00	-35.73	17.67	73.42	PK	3.00	9.54	83.52	10.10	PASS
11	H	1	3160-09	24620.00	37.57		40.40	13.00	-35.73	17.67	55.24	AV	3.00	9.54	63.52	8.28	PASS

Formulae:

Total CF = Antenna Factor + Cable Factor + Other Factor (Amplifier Gain, filter loss, etc)

Field Strength = SA Reading + Total CF

Limit Distance Correction = 40*log(d1/d2) for F<30 MHz, 20*log(d1/d2) for F> 30 MHz:

where d1 is the measurement distance, d2 is the published limit distance

Limit = Specified Limit + Limit Distance Correction

Margin = Limit - Field Strength

*No emissions within the restricted bands where measured above the levels noted

Itronix Corporation	Model: IX260+	FCC ID:	KBCIX260PROGC82
Rugged Laptop PC with internal WLAN (802.11b/g) & Dual-Band GSM GPRS/EDGE Modem			
2004 Celltech Labs Inc	This document is not to be reproduced in whole or in part without the written permission of Celltech Labs Inc.		61 of 80

Test Report S/N:	052604-514KBC
Test Date(s):	28Jun04 - 29Jul04
Test Type:	FCC Part 15.247

F.9.10. Channel 11 Restricted Band Spurious Emission Field Strengths @ Specified Distance – Vertical Polarization

Channel	Polarity	Measurement Distance	Antenna	Frequency	SA Level	Noise Floor	Antenna Factor	Cable Factor	Other Factors	Total CF	Field Strength	Detector	Limit Distance	Limit Distance Correction	15.209 (a) Limit	Margin	Pass/Fail
													m	dB	dBuV/m		
11	V	3	LP-105	0.08	19.50		48.79	0.04	0.00	48.83	68.33	PK	300.00	80.00	143.60	75.27	PASS
11	V	3	LG-105	0.20	1.04		59.88	0.07	0.00	59.95	60.99	PK	300.00	80.00	134.59	73.60	PASS
11	V	3	LG-105	0.79	1.46		57.46	0.12	0.00	57.57	59.03	PK	30.00	40.00	91.16	32.13	PASS
11	V	3	LG-105	1.44	8.37		53.25	0.15	0.00	53.40	61.77	PK	30.00	40.00	85.34	23.57	PASS
11	V	3	LG-105	4.05	10.60		47.10	0.26	0.00	47.36	57.96	PK	30.00	40.00	89.54	31.58	PASS
11	V	3	LG-105	5.26	10.77		44.79	0.30	0.00	45.09	55.86	PK	30.00	40.00	89.54	33.68	PASS
11	V	3	LG-105	13.95	9.95		40.60	0.50	0.00	41.09	51.04	PK	30.00	40.00	89.54	38.50	PASS
11	V	3	Bilog SN1607	138.96	37.30		11.14	0.94	0.00	12.08	49.38	PK	3.00	0.00	63.52	14.14	PASS
11	V	3	Bilog SN1607	164.83	39.20		9.57	0.98	0.00	10.54	49.74	PK	3.00	0.00	63.52	13.78	PASS
11	V	3	Bilog SN1607	208.48	44.90		8.25	1.04	0.00	9.29	54.19	PK	3.00	0.00	63.52	9.33	PASS
11	V	3	Bilog SN1607	245.02	44.80		11.75	1.10	0.00	12.85	57.65	PK	3.00	0.00	66.02	8.37	PASS
11	V	3	Bilog SN1607	794.04	35.60		22.51	1.90	0.00	24.42	60.02	PK	3.00	0.00	66.02	6.01	PASS
11	V	3	Horn SN6276	2810.00	37.20		29.35	3.74	-36.34	-3.25	33.95	PK	3.00	0.00	73.98	40.03	PASS
11	V	3	Horn SN6276	5270.00	36.40		33.73	5.24	-35.47	3.49	39.89	PK	3.00	0.00	73.98	34.09	PASS
11	V	3	Horn SN6276	5770.00	42.50		34.21	5.45	-35.50	4.16	46.66	PK	3.00	0.00	73.98	27.31	PASS
11	V	3	Horn SN6276	9820.00	36.60		37.76	7.44	-35.77	9.42	46.02	PK	3.00	0.00	73.98	27.96	PASS
11	V	3	Horn SN6276	16680.00	39.00		39.29	10.24	-36.14	13.40	52.40	PK	3.00	0.00	73.98	21.58	PASS
11	V	1	3160-09	19696.00	53.07		40.30	11.42	-35.76	15.95	69.02	PK	3.00	9.54	83.52	14.50	PASS
11	V	1	3160-09	19696.00	33.28		40.30	11.42	-35.76	15.95	49.23	AV	3.00	9.54	63.52	14.29	PASS
11	V	1	3160-09	20660.00	55.02		40.30	11.74	-35.73	16.31	71.33	PK	3.00	9.54	83.52	12.19	PASS
11	V	1	3160-09	20660.00	35.18		40.30	11.74	-35.73	16.31	51.49	AV	3.00	9.54	63.52	12.03	PASS

Formulae:

Total CF = Antenna Factor + Cable Factor + Other Factor (Amplifier Gain, filter loss, etc)

Field Strength = SA Reading + Total CF

Limit Distance Correction = 40*log(d1/d2) for F<30 MHz, 20*log(d1/d2) for F> 30 MHz:

where d1 is the measurement distance, d2 is the published limit distance

Limit = Specified Limit + Limit Distance Correction

Margin = Limit - Field Strength

*No emissions within the restricted bands where measured above the levels noted

Continued

Itronix Corporation	Model: IX260+	FCC ID:	KBCIX260PROGC82
Rugged Laptop PC with internal WLAN (802.11b/g) & Dual-Band GSM GPRS/EDGE Modem			
2004 Celltech Labs Inc	This document is not to be reproduced in whole or in part without the written permission of Celltech Labs Inc.		62 of 80

Test Report S/N:	052604-514KBC
Test Date(s):	28Jun04 - 29Jul04
Test Type:	FCC Part 15.247

Continued

Channel	Polarity	Measurement Distance	Antenna	Frequency	SA Level	Noise Floor	Antenna Factor	Cable Factor	Other Factors	Total CF	Field Strength	Detector	Limit Distance	Limit Distance Correction	15.209 (a) Limit	Margin	Pass/Fail
													m	dB	dBuV/m		
11	V	1	3160-09	22158.00	54.12		40.33	12.08	-35.73	16.68	70.80	PK	3.00	9.54	83.52	12.72	PASS
11	V	1	3160-09	22158.00	33.80		40.33	12.08	-35.73	16.68	50.48	AV	3.00	9.54	63.52	13.04	PASS
11	V	1	3160-09	23950.00	57.28		40.40	12.75	-35.73	17.42	74.70	PK	3.00	9.54	83.52	8.82	PASS
11	V	1	3160-09	23950.00	36.43		40.40	12.75	-35.73	17.42	53.85	AV	3.00	9.54	63.52	9.67	PASS
11	V	1	3160-09	24620.00	55.73		40.40	13.00	-35.73	17.67	73.40	PK	3.00	9.54	83.52	10.12	PASS
11	V	1	3160-09	24620.00	37.92		40.40	13.00	-35.73	17.67	55.59	AV	3.00	9.54	63.52	7.93	PASS

Formulae:

Total CF = Antenna Factor + Cable Factor + Other Factor (Amplifier Gain, filter loss, etc)

Field Strength = SA Reading + Total CF

Limit Distance Correction = $40 \cdot \log(d1/d2)$ for $F < 30$ MHz, $20 \cdot \log(d1/d2)$ for $F > 30$ MHz:

where d1 is the measurement distance, d2 is the published limit distance

Limit = Specified Limit + Limit Distance Correction

Margin = Limit - Field Strength

*No emissions within the restricted bands where measured above the levels noted

F.10. PASS/FAIL

In reference to the results outlined in F.9, the DUT passes the requirements as stated in the reference standards as follows: FCC 15.205 (a) (b) and 15.209 (a): No emissions were measured within the restricted bands as outlined in 15.205 that exceeded the limits stated in 15.209.

F.11. SIGN-OFF

I attest to the accuracy of the data. All measurements reported herein were performed by me and are correct to the best of my knowledge and belief. I assume full responsibility for the completeness of these measurements.



Russell Pipe
Senior Compliance Technologist
Celltech Labs Inc.

04Aug04
Date

Test Report S/N:	052604-514KBC
Test Date(s):	28Jun04 - 29Jul04
Test Type:	FCC Part 15.247

Appendix G - Peak Power Spectral Density Measurement

G.1. REFERENCES	
Normative Reference Standard	FCC CFR 47 §15.247(d)
Procedure Reference	FCC 97-114

G.2. LIMITS	
G.2.1. FCC CFR	
<p>§15.247(d): For digitally modulated systems, the peak power spectral density conducted from the intentional radiator to the antenna shall not be greater than +8 dBm in any 3 kHz band during any time interval of continuous transmission.</p>	

G.3. ENVIRONMENTAL CONDITIONS	
Temperature	25.2 +/- 2 °C
Humidity	35 +/- 2 %
Barometric Pressure	96.34 kPa

G.4. EQUIPMENT LIST					
ASSET NUMBER	MANUFACTURER	MODEL	DESCRIPTION	LAST CAL	CAL DUE
00015	Agilent	E4408B	Spectrum Analyzer	29Dec03	29Dec04
00075	Alpha Wire-J	9223	2ft. RG223/U RF Cable	08Jul04*	24Jun05
00076	Pasternack	PE7014-30	30dB 2 Watt Attenuator	08Jul04*	24Jun05

*Cable and attenuator verified with power meter prior to use

G.5. MEASUREMENT EQUIPMENT SETUP	
Measurement Equipment Connections	The equipment was connected as shown in the setup drawing in G.6.
Measurement Equipment Settings	<p>The spectrum analyzer was configured with the following settings:</p> <ul style="list-style-type: none"> RBW – 3 kHz VBW – 10 kHz Sweep time – 500 seconds Span – 1.5 MHz

Test Report S/N:	052604-514KBC
Test Date(s):	28Jun04 - 29Jul04
Test Type:	FCC Part 15.247

G.6. SETUP DRAWING

Figure G-1 – Setup Drawing

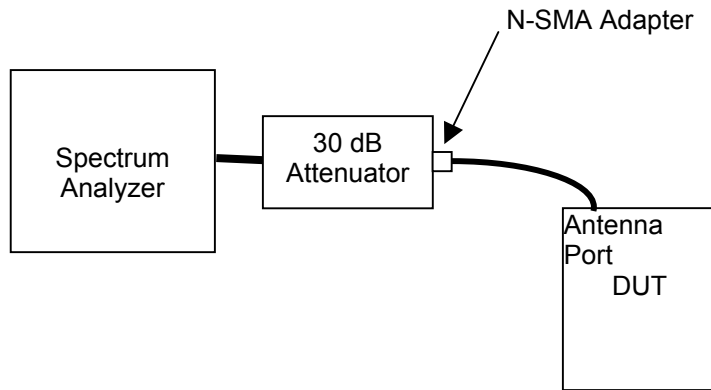

G.7. DUT OPERATING DESCRIPTION

The worst-case data rate was determined from prescan investigations. Measurements were made at three channels throughout the band, Low Channel (2412 MHz), Mid Channel (2437 MHz), High Channel (2462 MHz) and for both Modes b and g.

G.8. TEST RESULTS

Channel	802.11b			802.11g		
	Frequency (GHz)	PPSD (dBm)	Data Rate Mb/s	Frequency (GHz)	PPSD (dBm)	Data Rate Mb/s
Low	2.411340	-8.516	1	2.411374	-11.69	6
Mid	2.437589	-8.287	1	2.436670	-12.35	6
High	2.461261	-7.351	1	2.462623	-12.05	6

Test Report S/N:	052604-514KBC
Test Date(s):	28Jun04 - 29Jul04
Test Type:	FCC Part 15.247

Plot G-1 - PPSD Low Channel (802.11b)

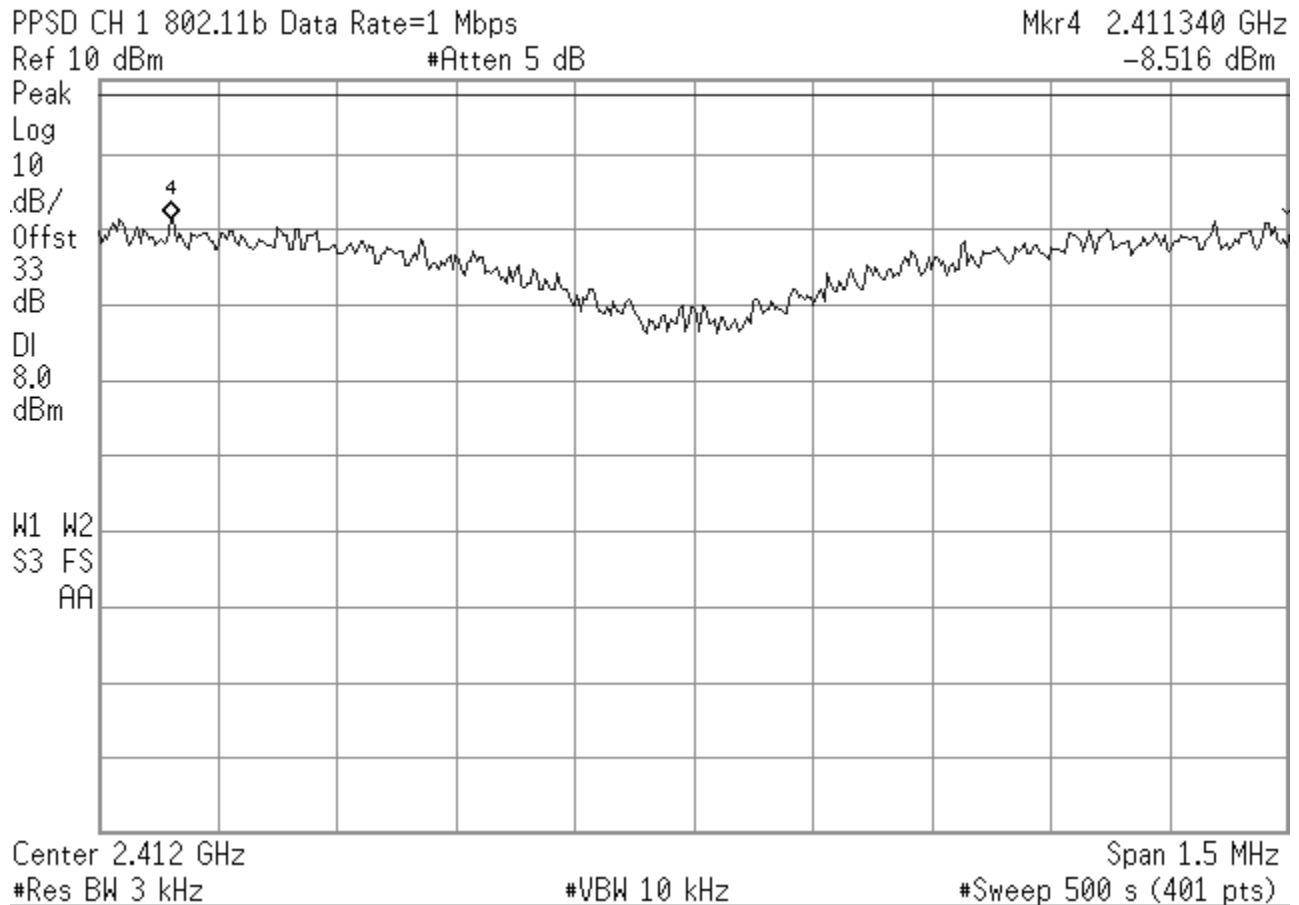

Itronix Corporation	Model: IX260+	FCC ID:	KBCIX260PROGC82
Rugged Laptop PC with internal WLAN (802.11b/g) & Dual-Band GSM GPRS/EDGE Modem			
2004 Celltech Labs Inc	This document is not to be reproduced in whole or in part without the written permission of Celltech Labs Inc.		66 of 80

Test Report S/N:	052604-514KBC
Test Date(s):	28Jun04 - 29Jul04
Test Type:	FCC Part 15.247

Plot G-2 - PSD Mid Channel (802.11b)

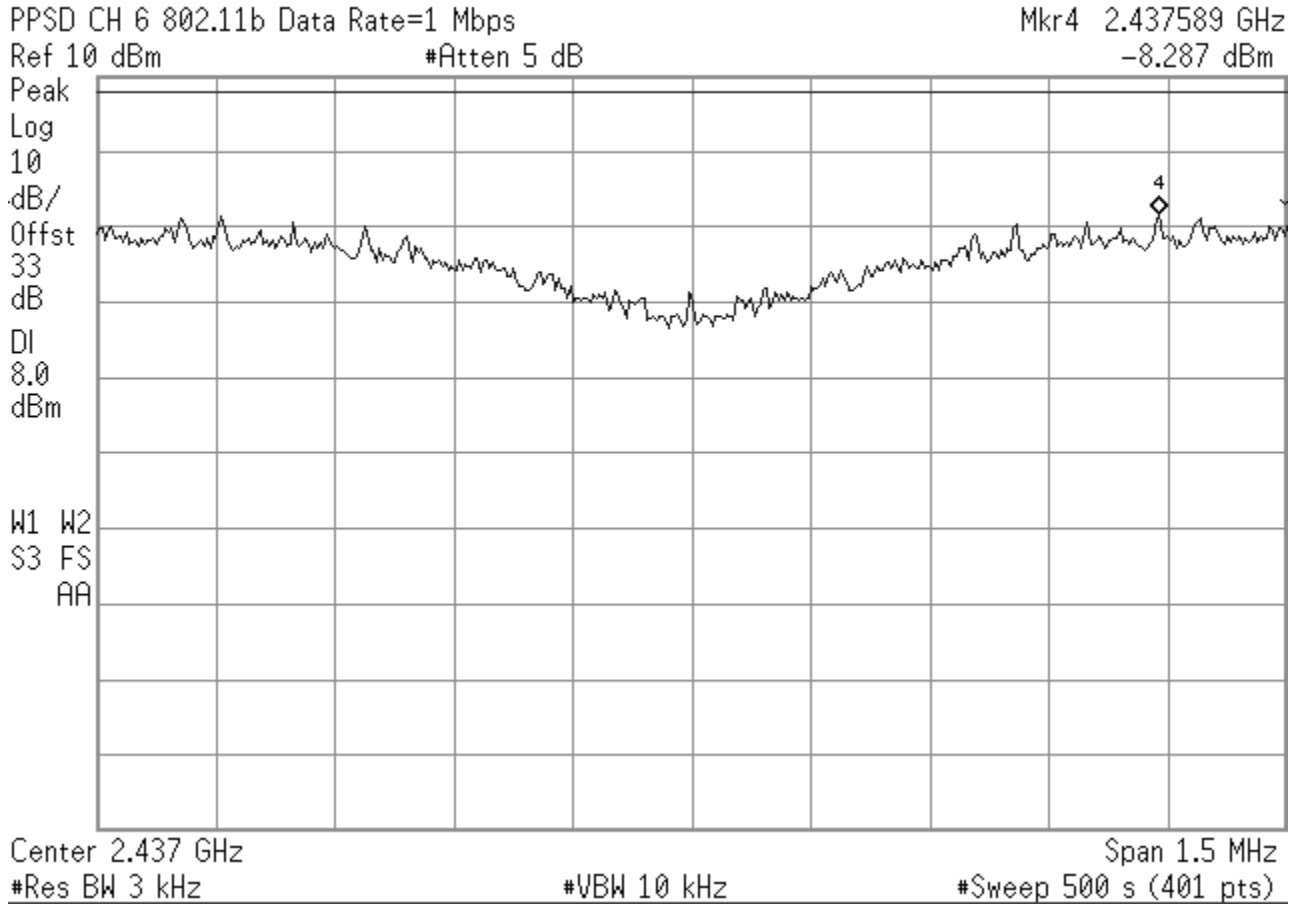

Itronix Corporation	Model: IX260+	FCC ID:	KBCIX260PROGC82
Rugged Laptop PC with internal WLAN (802.11b/g) & Dual-Band GSM GPRS/EDGE Modem			
2004 Celltech Labs Inc	This document is not to be reproduced in whole or in part without the written permission of Celltech Labs Inc.		67 of 80

Test Report S/N:	052604-514KBC
Test Date(s):	28Jun04 - 29Jul04
Test Type:	FCC Part 15.247

Plot G-3 - PPSD High Channel (802.11b)

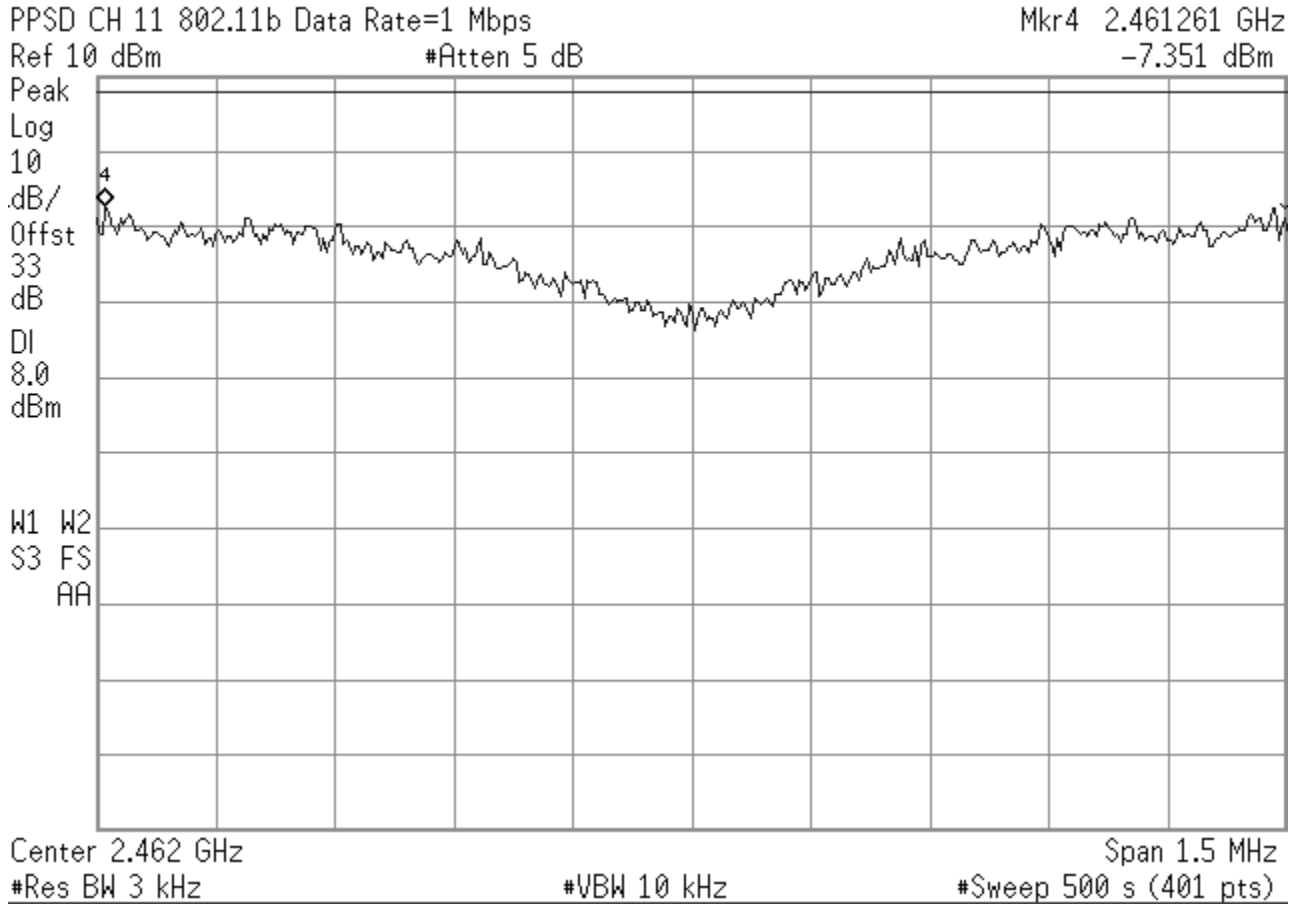

Test Report S/N:	052604-514KBC
Test Date(s):	28Jun04 - 29Jul04
Test Type:	FCC Part 15.247

Plot G-4 - PPSD Low Channel (802.11g)

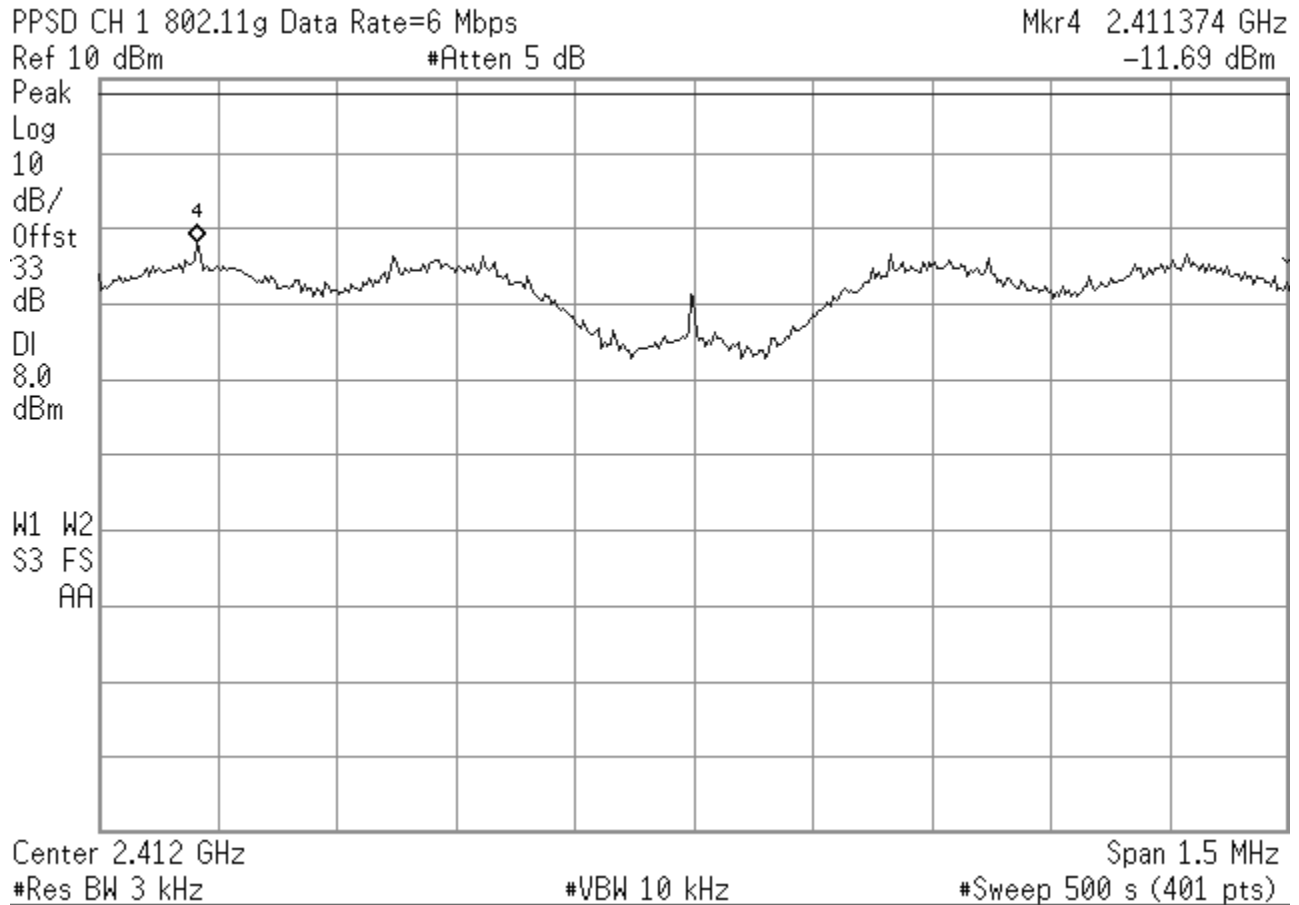

Test Report S/N:	052604-514KBC
Test Date(s):	28Jun04 - 29Jul04
Test Type:	FCC Part 15.247

Plot G-5 - PSD Mid Channel (802.11g)

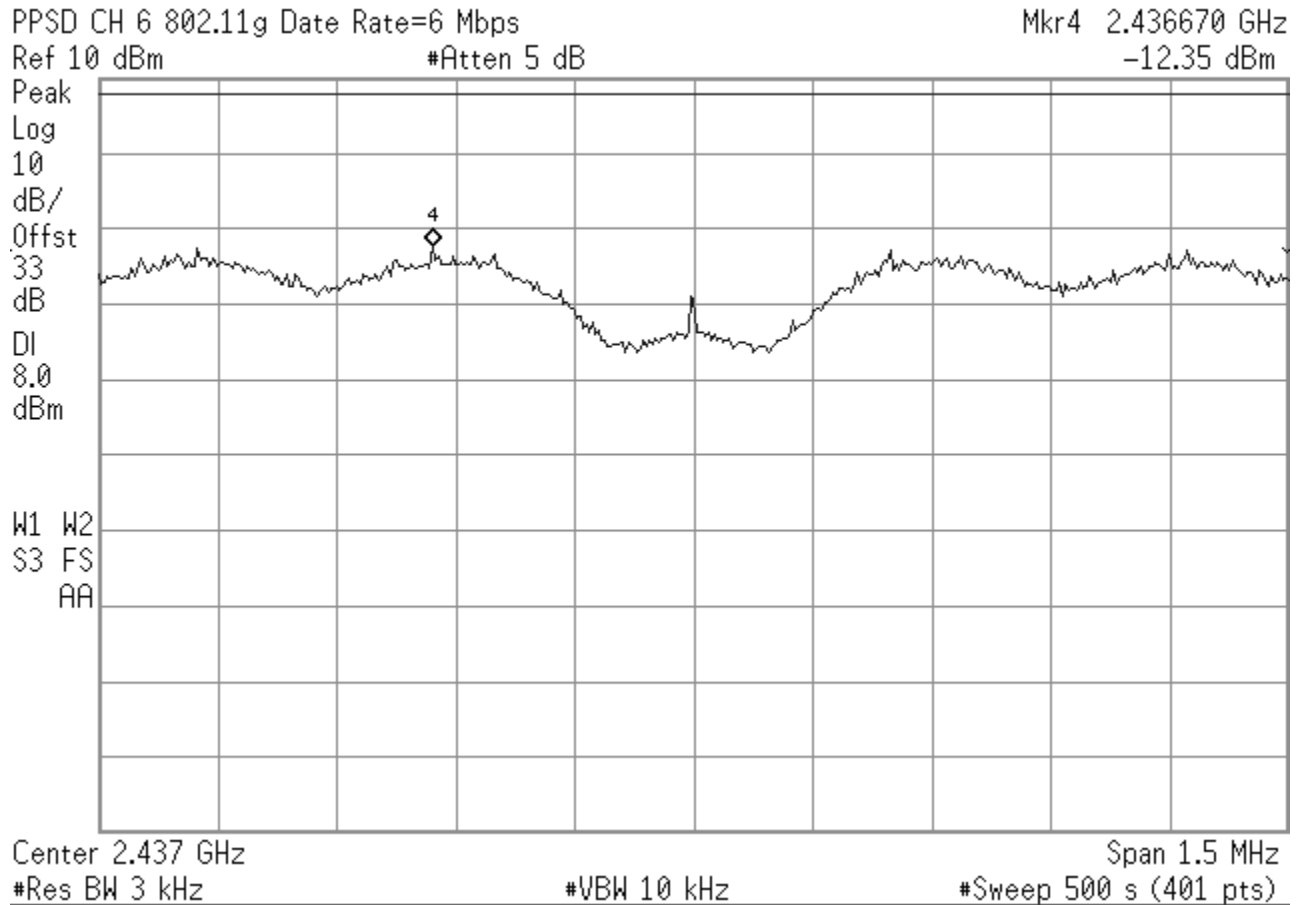

Itronix Corporation	Model: IX260+	FCC ID:	KBCIX260PROGC82
Rugged Laptop PC with internal WLAN (802.11b/g) & Dual-Band GSM GPRS/EDGE Modem			
2004 Celltech Labs Inc	This document is not to be reproduced in whole or in part without the written permission of Celltech Labs Inc.		70 of 80

Test Report S/N:	052604-514KBC
Test Date(s):	28Jun04 - 29Jul04
Test Type:	FCC Part 15.247

Plot G-6 - PPSD High Channel (802.11g)

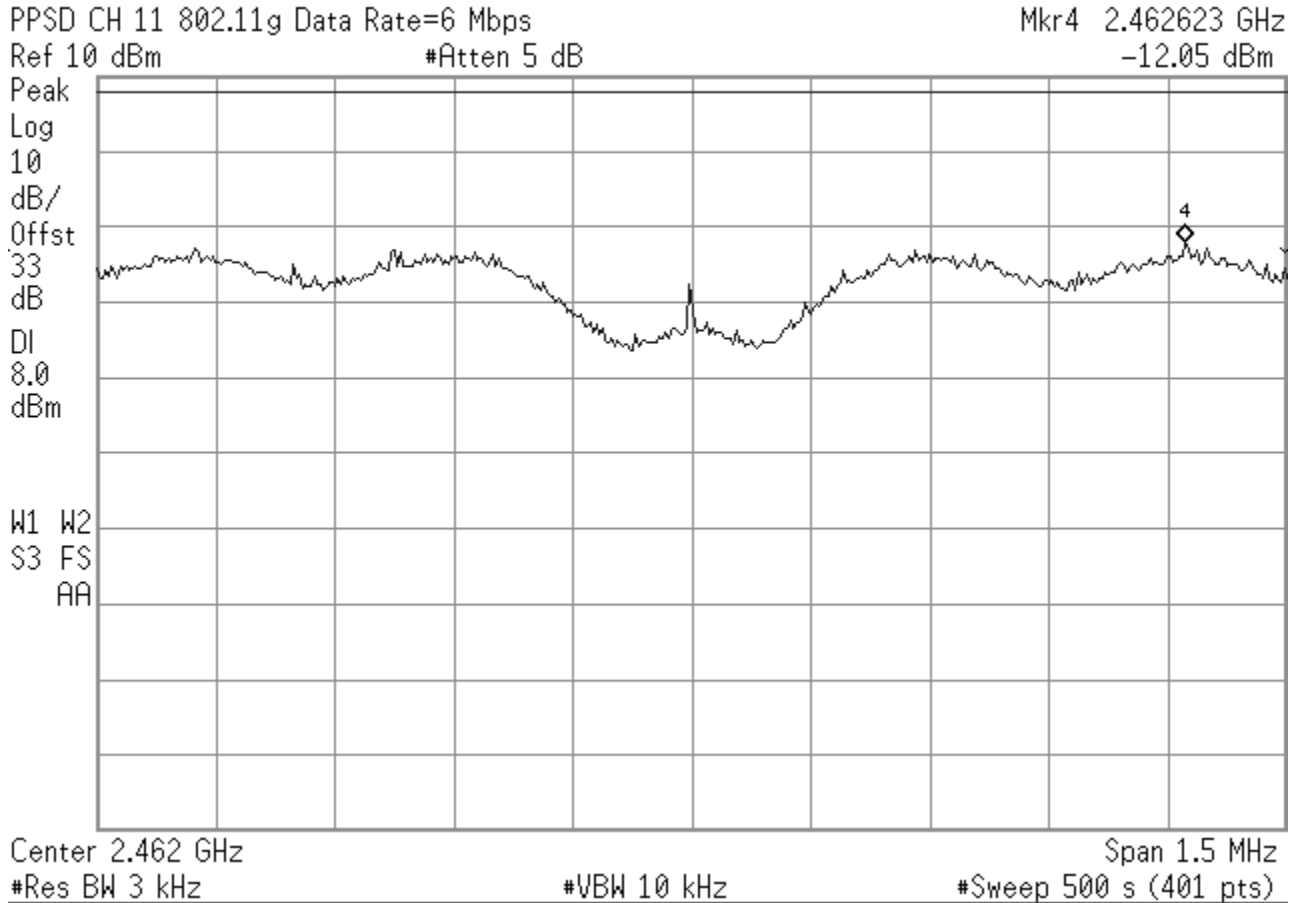

Itronix Corporation	Model: IX260+	FCC ID:	KBCIX260PROGC82
Rugged Laptop PC with internal WLAN (802.11b/g) & Dual-Band GSM GPRS/EDGE Modem			
2004 Celltech Labs Inc	This document is not to be reproduced in whole or in part without the written permission of Celltech Labs Inc.		71 of 80

Test Report S/N:	052604-514KBC
Test Date(s):	28Jun04 - 29Jul04
Test Type:	FCC Part 15.247

G.9. PASS/FAIL

In reference to the results outlined in G.8 the DUT passes the requirements as stated in the reference standards as follows:
FCC 15.247 (d): The peak power spectral density did not exceed +8 dBm in any 3 kHz band.

G.10. SIGN-OFF

I attest to the accuracy of the data. All measurements reported herein were performed by me and are correct to the best of my knowledge and belief. I assume full responsibility for the completeness of these measurements.



Russell Pipe
Senior Compliance Technologist
Celltech Labs Inc.

04Aug04
Date

Test Report S/N:	052604-514KBC
Test Date(s):	28Jun04 - 29Jul04
Test Type:	FCC Part 15.247

Appendix H - Conducted Powerline Emissions Measurement

H.1. REFERENCES	
Normative Reference Standard	CFR 47 FCC Part 15 §15.207
Procedure Reference	ANSI C63.4

H.2. LIMITS		
§15.207: Compliance with the provisions of this paragraph shall be based on the measurement of the radio frequency voltage between each powerline and ground at the power terminal.		
Frequency of Emission (MHz)	Conducted Limit (dBuV)	
	Quasi-Peak	Average
0.15 – 0.5	66 to 56*	56 o 46*
0.50 – 5.0	56	46
5.0 – 30.0	60	50

H.3. ENVIRONMENTAL CONDITIONS	
Temperature	+26 ± 5 °C
Humidity	31 % ± 10% RH
Barometric Pressure	101.4 kpa

H.4. EQUIPMENT LIST					
ASSET NUMBER	MANUFACTURER	MODEL	DESCRIPTION	LAST CAL	CAL DUE
00063	HP	85662A	Spectrum Analyzer Display	na	na
00051	HP	8566B	Spectrum Analyzer RF Section	18May04	18May05
00049	HP	85650A	Quasi-Peak Adapter	18May04	18May05
00047	HP	85685A	Preselector	18May04	18May05
00083	EMCO	3825/2	Line Impedance Stabilization Network	29Apr04	29Apr05
00084	EMCO	3825/2	Line Impedance Stabilization Network	29Apr04	29Apr05

Itronix Corporation	Model: IX260+	FCC ID:	KBCIX260PROGC82
Rugged Laptop PC with internal WLAN (802.11b/g) & Dual-Band GSM GPRS/EDGE Modem			
2004 Celltech Labs Inc	This document is not to be reproduced in whole or in part without the written permission of Celltech Labs Inc.		73 of 80

Test Report S/N:	052604-514KBC
Test Date(s):	28Jun04 - 29Jul04
Test Type:	FCC Part 15.247

H.5. MEASUREMENT EQUIPMENT SETUP	
MEASUREMENT EQUIPMENT CONNECTIONS	The conducted emissions were measured on each of the two AC powerline leads connected to the DUT's power supply brick. A two line LISN was used to make this measurement. A drawing of the equipment setup is shown in H.6
MEASUREMENT EQUIPMENT SETTINGS	<p>Each of the monitor ports from the 2-line LISN was connected in turn to the spectrum analyzer. The port not connected to the analyzer was terminated in a 50-ohm load. A prescan of the peak emission levels was made of the 150 kHz – 30 MHz range split into 4 equal frequency bands. The following were the spectrum analyzer settings:</p> <ul style="list-style-type: none"> Start Frequency and Stop Frequency set by software for each of the four bands RBW: 100 kHz VBW: 300 kHz Sweep: 500 mS <p>The resulting data from each band was corrected and collected by software and presented in the graphical representations shown in H.8 for the two leads.</p> <p>The frequency points with the highest 10 levels on each lead were used by software to optimize a set of 20 readings for each type of detector (peak, quasi-peak and average). This data was corrected by the software is presented in the tables shown in section H.8.</p>

Test Report S/N:	052604-514KBC
Test Date(s):	28Jun04 - 29Jul04
Test Type:	FCC Part 15.247

H.6. SETUP PHOTOS

Photograph H-1 – AC Powerline Conducted Emission Configuration



Photograph H-2 – AC Powerline Conducted Emission Cable Placement

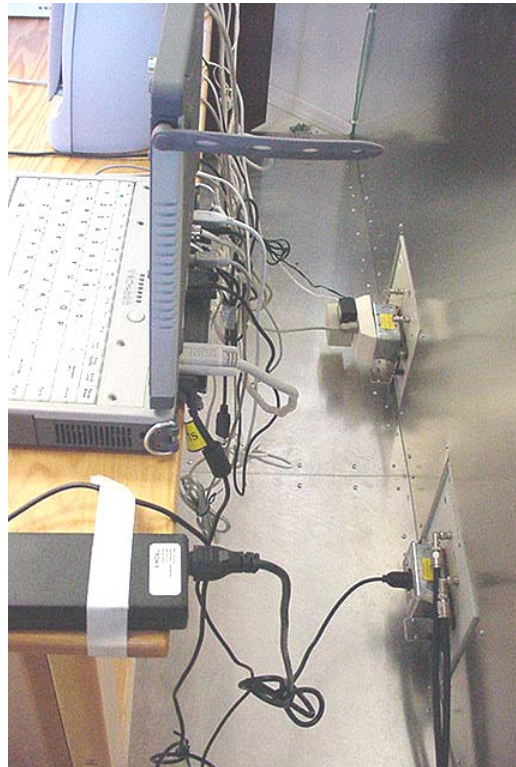

Itronix Corporation	Model: IX260+	FCC ID:	KBCIX260PROGC82
Rugged Laptop PC with internal WLAN (802.11b/g) & Dual-Band GSM GPRS/EDGE Modem			
2004 Celltech Labs Inc	This document is not to be reproduced in whole or in part without the written permission of Celltech Labs Inc.		75 of 80

Test Report S/N:	052604-514KBC
Test Date(s):	28Jun04 - 29Jul04
Test Type:	FCC Part 15.247

H.7. SETUP DRAWING

Figure H-1 – Setup Drawing

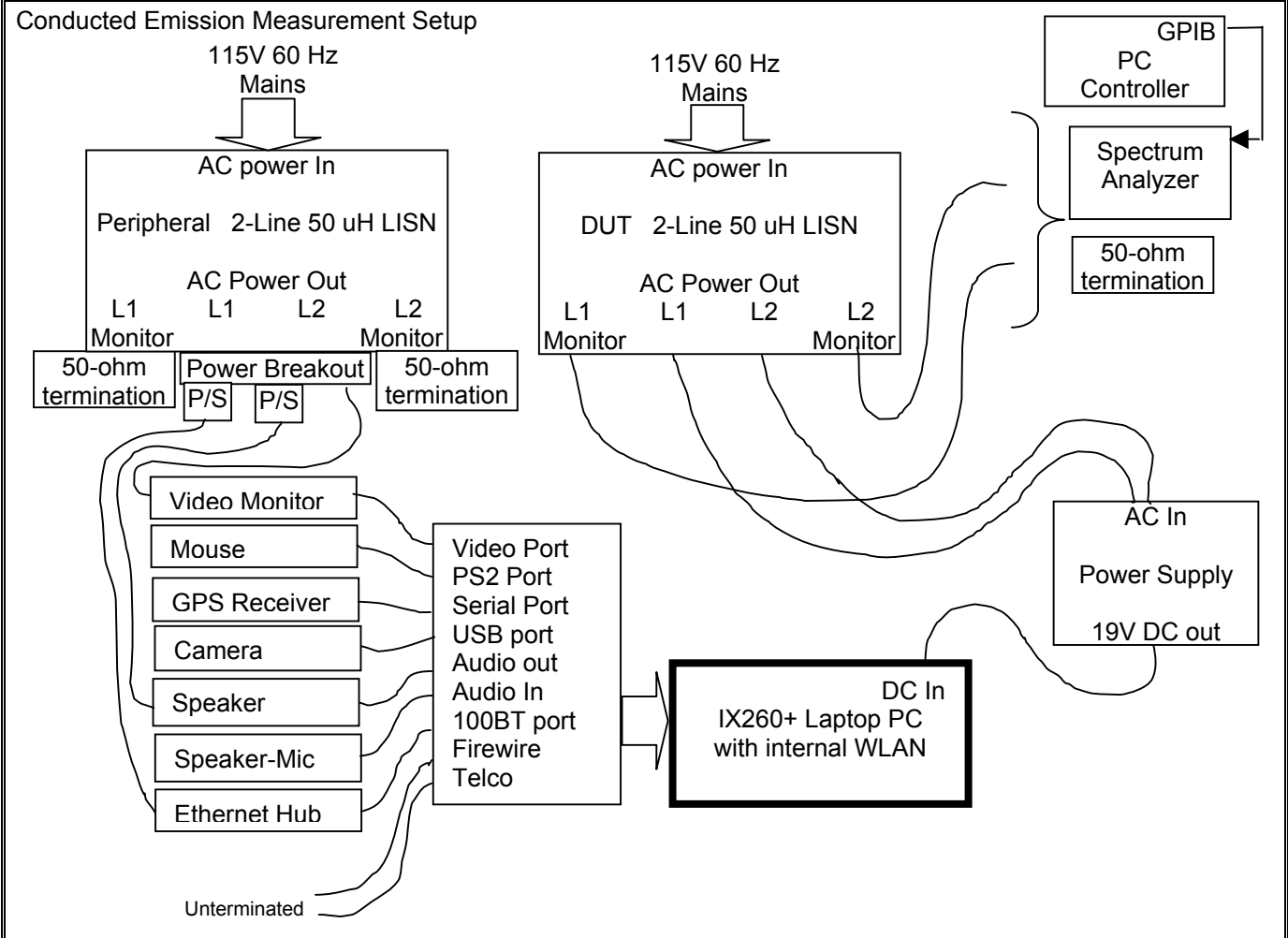

H.8. DUT OPERATING DESCRIPTION

WLAN:	The WLAN was set to transmit at full power on Channel 1, Mode g 6 Mb/s
PC:	Other than operating the WLAN software and running MS windows, no PC exercising was performed.
Peripherals:	All peripherals were active, but no specific traffic was initiated.

Test Report S/N:	052604-514KBC
Test Date(s):	28Jun04 - 29Jul04
Test Type:	FCC Part 15.247

H.9. TEST RESULTS								
					Standard: FCC15.207			
Lead	Frequency	SA Level	CF	Emission Level	Detector	Limit	Margin	Pass/Fail
	MHz	dBuV	dB/m	dBuV/m	PK/QP/AVG	dBuV/m	dB	
L1	0.150	39.600	2.13	41.73	QP	66.00	24.27	PASS
L1	0.150	37.400	2.13	39.53	AVG	56.00	16.47	PASS
L1	2.737	41.800	0.28	42.08	QP	56.00	13.92	PASS
L1	2.737	41.900	0.28	42.18	AVG	46.00	3.82	PASS
L1	8.666	40.200	0.89	41.09	QP	56.59	15.49	PASS
L1	8.666	36.600	0.89	37.49	AVG	46.59	9.09	PASS
L1	24.575	22.400	2.88	25.28	PK	49.13	23.85	PASS
L1	24.575	20.000	2.88	22.88	AVG	49.13	26.25	PASS
L2	0.154	43.300	2.07	45.37	QP	65.89	20.52	PASS
L2	0.154	43.100	2.07	45.17	AVG	55.89	10.72	PASS
L2	3.191	42.500	0.29	42.79	QP	56.00	13.21	PASS
L2	3.191	42.400	0.29	42.69	AVG	46.00	3.31	PASS
L2	8.358	40.300	0.86	41.16	QP	56.54	15.38	PASS
L2	8.358	39.100	0.86	39.96	AVG	46.54	6.58	PASS
L2	24.575	23.400	2.89	26.29	QP	59.13	32.84	PASS
L2	24.575	20.200	2.89	23.09	AVG	49.13	26.04	PASS
Calculations								
CF = Correction Factor								
Emission Level = Measured Level + correction factor								
Margin = Limit – Emission Level								

Test Report S/N:	052604-514KBC
Test Date(s):	28Jun04 - 29Jul04
Test Type:	FCC Part 15.247

Plot H-1 - Line 1 Peak Conducted Powerline Emissions

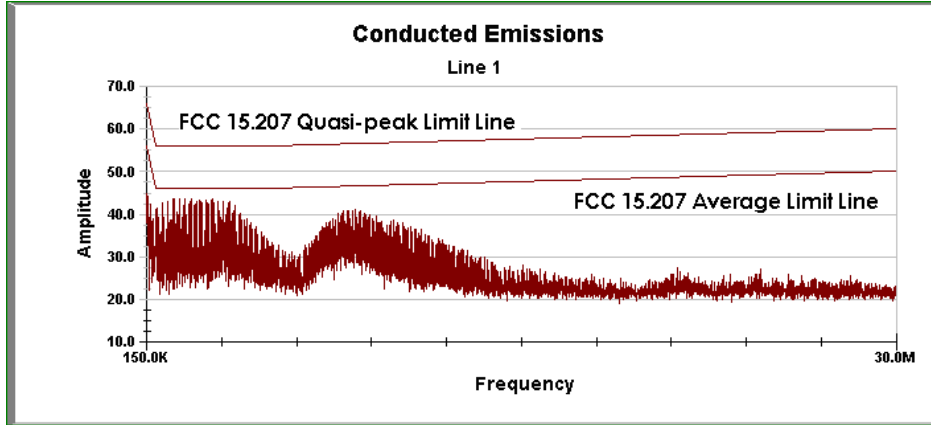

Plot H-2 - Line 2 Peak Conducted Powerline Emissions

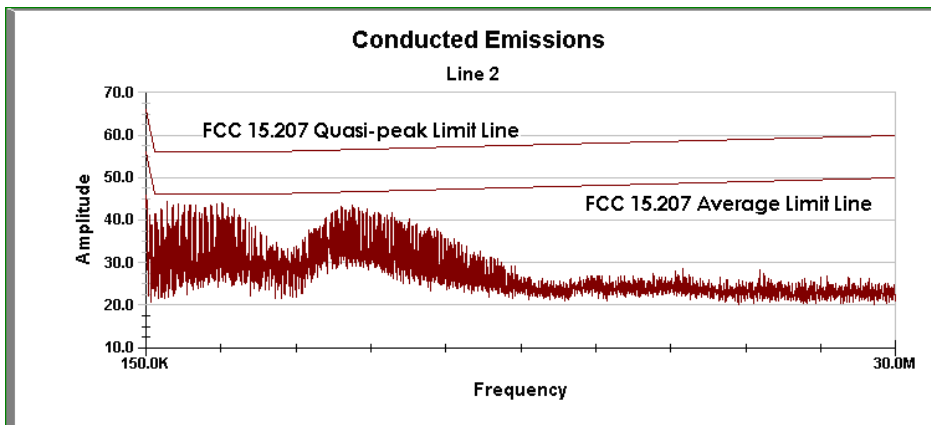

Test Report S/N:	052604-514KBC
Test Date(s):	28Jun04 - 29Jul04
Test Type:	FCC Part 15.247

H.10. PASS/FAIL

In reference to the results outlined in H.8 the DUT passes the requirements as stated in the reference standards as follows:
 1) The pass-band gain does not exceed the nominal gain of +10.0 dB stated by the manufacturer by more than 1.0 dB.
 2) The gain outside the 20dB bandwidth does not exceed the gain at the 20 dB point (-10.0 dB).

H.11. SIGN-OFF

I attest to the accuracy of the data. All measurements reported herein were performed by me and are correct to the best of my knowledge and belief. I assume full responsibility for the completeness of these measurements.



 Duane M. Friesen, C.E.T.
 EMC Manager
 Celltech Labs Inc.

04Aug04

 Date

Test Report S/N:	052604-514KBC
Test Date(s):	28Jun04 - 29Jul04
Test Type:	FCC Part 15.247

END OF DOCUMENT