

| | | |
|--------------------------------|-----------------------------|--------------------|
| Test Report Serial No.: | 022305KBC-T618-E15B | Issue 1.0 |
| Test Date(s): | 21Sept04 - 14Oct04, 22Oct04 | |
| Test Type(s): | FCC §15.247 | IC RSS-210 Issue 5 |
| Lab Registration(s): | FCC #714830 | IC Lab File #3874 |

EMC TEST REPORT
FOR THE
ITRONIX RUGGED LAPTOP PC MODEL: IX260PROA580BT
WITH
CIRRONET BT2022 BLUETOOTH TRANSMITTER
AND
INTERNAL RANGESTAR SURFACE-MOUNT ANTENNA
CO-LOCATED WITH
INTEL PRO 2200BG 802.11B/G 2.4 GHz DSSS WLAN MINI-PCI CARD
AND THE RANGESTAR INTERNAL SURFACE-MOUNT ANTENNA
CO-LOCATED WITH
SIERRA WIRELESS DUAL-BAND CDMA PCMCIA MODEM
AND EXTERNAL SWIVEL DIPOLE ANTENNA

TRSN 022305KBC-T618-E15B
Issue 1.0

Celltech Compliance Testing & Engineering Lab
(Celltech Labs Inc.)
1955 Moss Court
Kelowna, BC
Canada
V1Y 9L3

May 09, 2005

| | | |
|--------------------------------|-----------------------------|--------------------|
| Test Report Serial No.: | 022305KBC-T618-E15B | Issue 1.0 |
| Test Date(s): | 21Sept04 - 14Oct04, 22Oct04 | |
| Test Type(s): | FCC §15.247 | IC RSS-210 Issue 5 |
| Lab Registration(s): | FCC #714830 | IC Lab File #3874 |

DECLARATION OF COMPLIANCE

| | | | |
|-------------------------------------------------------------------------------------------------------------------------------------------------------------------------------------------------------------------------------------------------------------------------------------------|-----------------------------------------------------------------------------------------------|----------------------------------------------------------------------------------------------------------------------------------|--|
| Test Lab CELLTECH LABS INC. Testing and Engineering Services 1955 Moss Court Kelowna, B.C. Canada V1Y 9L3 Phone: 250-448-7047 Fax: 250-448-7048 e-mail: info@celltechlabs.com web site: www.celltechlabs.com | | Applicant Information ITRONIX CORPORATION 801 South Stevens Street Spokane, WA 99204 United States | |
| Laboratory Registration No.(s): | FCC: 714830 | IC: IC 3874 | |
| Rule Part(s): | FCC: §15.247; §2.1091; §1.1310 | IC: RSS-210 Issue 5 | |
| Device Classification: | FCC: Spread Spectrum Transmitter (DSS) | IC: Low Power Licence-Exempt Transmitter | |
| Device Identification: | FCC ID: KBCIX260PROA580BT | IC: 1943A-IX260Pf | |
| DUT Description: | | | |
| Model: | IX260PROA580BT | | |
| Device Description: | Rugged Laptop PC | | |
| Internal Transmitter: | Cirronet BT2022 Bluetooth | | |
| Co-located Transmitter(s): | Intel Pro 2200BG 802.11b/g 2.4 GHz DSSS WLAN Mini-PCI Card | | |
| | Sierra Wireless Dual-Band PCS/Cellular CDMA PCMCIA Modem | | |
| Tx Frequency Range: | 2402 - 2480 MHz (Bluetooth) | | |
| Max. RF Output Power: | 0.0364 Watts / 15.61 dBm (Peak Conducted) | | |
| Mode(s) of Operation: | Frequency Hopping Spread Spectrum (FHSS) | | |
| Modulation Type(s): | GFSK 1 Mbps 0.5 BT Gaussian | | |
| Antenna Type(s): | Bluetooth: RangeStar P/N: 100929 Internal Surface-Mount (upper left side rear of LCD Display) | | |
| | WLAN: RangeStar P/N: 100929 Internal Surface-Mount (upper right side rear of LCD Display) | | |
| | CDMA: Itronix IX260+ External Swivel Dipole (upper right side edge of LCD Display) | | |
| Power Source(s): | Stationary: 90 Watt AC Power Adapter | 11.1V Lithium-ion Battery, 6.0Ah (Model: A2121-2) | |

This wireless mobile device has demonstrated compliance with the applicable technical standards as indicated in the measurement report and was tested in accordance with the measurement procedures specified in FCC 47 CFR Part 15(C), Industry Canada RSS-210 Issue 5, and ANSI TIA/EIA-603-B-2002.

I attest to the accuracy of the data. All measurements reported herein were performed by me or were under my supervision and are correct to the best of my knowledge and belief. I assume full responsibility for the completeness of these measurements and vouch for the qualifications of all persons taking them.

This test report shall not be reproduced partially, or in full, without the prior written approval of Celltech Labs Inc. The results and statements contained in this report pertain only to the device(s) evaluated.



Russell Pipe
Senior Compliance Technologist
Celltech Labs Inc.



Duane M. Friesen
EMC Manager
Celltech Labs Inc.



| | | | |
|---------------------------------------------------------------------------------------------------------------------------------------|------------------------------|----------------------------------|---------------------------------------------------------------------------------------|
| Applicant: Itronix Corporation | Model: IX260PROA580BT | FCC ID: KBCIX260PROA580BT | IC ID: 1943A-IX260Pf |
| Rugged Laptop PC with Cirronet BT2022 Bluetooth, Intel Pro 2200BG 802.11b/g WLAN, & Dual-Band CDMA | | |  |
| 2005 Celltech Labs Inc This document is not to be reproduced in whole or in part without the written permission of Celltech Labs Inc. | | | 2 of 45 |

| | | |
|--------------------------------|-----------------------------|--------------------|
| Test Report Serial No.: | 022305KBC-T618-E15B | Issue 1.0 |
| Test Date(s): | 21Sept04 - 14Oct04, 22Oct04 | |
| Test Type(s): | FCC §15.247 | IC RSS-210 Issue 5 |
| Lab Registration(s): | FCC #714830 | IC Lab File #3874 |

TABLE OF CONTENTS

| | |
|---------------------------------------------------------------|----|
| 1.0 SCOPE | 6 |
| 2.0 REFERENCES | 6 |
| 2.1 Normative References | 6 |
| 3.0 TERMS AND DEFINITIONS | 7 |
| 4.0 FACILITIES AND ACCREDITATIONS | 8 |
| 5.0 GENERAL INFORMATION | 8 |
| 5.1 Applicant Information | 8 |
| 5.2 DUT Description..... | 8 |
| 5.3 Co-Located Equipment | 9 |
| 5.4 Cable Descriptions..... | 9 |
| 5.5 Support Equipment | 9 |
| 5.6 Clock Frequencies | 10 |
| 5.7 Mode(s) of Operation Tested | 10 |
| 5.8 Configuration Description | 11 |
| 6.0 PASS/FAIL CRITERIA..... | 11 |
| APPENDICES..... | 12 |
| Appendix A - DUT Photographs | 13 |
| Appendix B - Conducted Powerline Emissions Measurement | 14 |
| Appendix C - Peak Conducted RF Output Power Measurement | 21 |
| Appendix D - Adjacent Channel Separation | 24 |
| Appendix E - Number of Hopping Channels..... | 25 |
| Appendix F - Channel Dwell Time | 26 |
| Appendix G - 20 dB Bandwidth Measurement..... | 27 |
| Appendix H - Radiated Spurious Emissions Measurement..... | 28 |
| Appendix I - Restricted Band Emissions Measurement | 34 |
| Appendix J - Maximum Permissible Exposure Calculation | 42 |
| END OF DOCUMENT..... | 45 |

| | | |
|--------------------------------|-----------------------------|--------------------|
| Test Report Serial No.: | 022305KBC-T618-E15B | Issue 1.0 |
| Test Date(s): | 21Sept04 - 14Oct04, 22Oct04 | |
| Test Type(s): | FCC §15.247 | IC RSS-210 Issue 5 |
| Lab Registration(s): | FCC #714830 | IC Lab File #3874 |

FIGURES

| | |
|----------------------------------|----|
| Figure B-1 - Setup Drawing | 17 |
| Figure C-1 - Setup Drawing | 22 |
| Figure H-1 - Setup Drawing | 29 |
| Figure I-1 - Setup Drawing..... | 36 |

PHOTOGRAPHS

| | |
|-----------------------------------------------------------------------|----|
| Photograph A-1 - Front of Open IX260+ Laptop PC..... | 13 |
| Photograph A-2 - Back of Open IX260+ Laptop PC..... | 13 |
| Photograph A-3 - Left Side of Open IX260+ Laptop PC..... | 13 |
| Photograph A-4 - Right Side of Open IX260+ Laptop PC | 13 |
| Photograph B-1 - AC Powerline Conducted Emission Configuration..... | 16 |
| Photograph B-2 - AC Powerline Conducted Emission Cable Placement..... | 16 |
| Photograph H-1 - 3115 Horn Antenna (1-18GHz)..... | 30 |
| Photograph H-2 - 3160-09 Horn Antenna (18-26GHz)..... | 30 |
| Photograph I-1 - Loop Antenna (10kHz- 30MHz)..... | 37 |
| Photograph I-2 - Bilog Antenna (30MHz - 1 GHz)..... | 37 |
| Photograph I-3 - Horizontal Polarization (30MHz - 1 GHz)..... | 37 |
| Photograph I-4 - Vertical Polarization (30MHz - 1 GHz) | 37 |
| Photograph I-5 - Front of Radiated Emission Configuration | 38 |
| Photograph I-6 - Back of Radiated Emission Configuration..... | 38 |

| | | |
|--------------------------------|-----------------------------|--------------------|
| Test Report Serial No.: | 022305KBC-T618-E15B | Issue 1.0 |
| Test Date(s): | 21Sept04 - 14Oct04, 22Oct04 | |
| Test Type(s): | FCC §15.247 | IC RSS-210 Issue 5 |
| Lab Registration(s): | FCC #714830 | IC Lab File #3874 |

TEST SUMMARY

Referenced Standard: FCC CFR Title 47 Part 15

| Appendix | Test Description | Procedure Reference | Limit Reference | Test Start Date | Test End Date | Result |
|----------|-------------------------------|--------------------------------------------|------------------------------------------|-----------------|--------------------|--------|
| B | Powerline Conducted Emissions | ANSI C63.4 | §15.207 | 14Oct04 | 14Oct04 | Pass |
| C | Peak Conducted RF Power | FCC 97-114 | §15.247 (b) (1) | 21Sep04 | 21Sep04 | Pass |
| D | Adjacent Channel Separation | Note 1 | §15.247 (a) (1) | Note 1 | Note 1 | Pass |
| E | Number of Hopping Channels | Note 1 | §15.247 (a) (1) (iii) | Note 1 | Note 1 | Pass |
| F | Channel Dwell Time | Note 1 | §15.247 (a) (1) §15.247 (a) (1) (iii) | Note 1 | Note 1 | Pass |
| G | 20 dB Bandwidth | Note 1 | §15.247 (a) (1) (iii) | Note 1 | Note 1 | Pass |
| H | Radiated Spurious Emissions | FCC 97-114 | §15.247(c) | 22Sep04 | 01Oct04 22Oct04 | Pass |
| I | Restricted Band Emissions | FCC 97-114 | §15.205 (a), (b) §15.209 (a) | 22Sep04 | 01Oct04 22Oct04 | Pass |
| J | Maximum Permissible Exposure | FCC CFR 47 § 2.1091 IEEE Std C95.1-1999 | §1.1310 Table 1 (b) | 13Oct04 | 13Oct04 | Pass |

Referenced Standard: IC RSS-210 Issue 5



| | | | | | | |
|---|-------------------------------|---------------------|--------------------------------------------------|---------|--------------------|------|
| B | Powerline Conducted Emissions | RSS-212, ANSI C63.4 | RSS-210 §6.6 | 14Oct04 | 14Oct04 | Pass |
| C | Peak Conducted RF Power | RSS-210 § 10 | RSS-210 §6.2.2 (o)(a3) | 21Sep04 | 21Sep04 | Pass |
| D | Adjacent Channel Separation | RSS-210 § 10 | RSS-210 A1 §I (ii) | Note 1 | Note 1 | Pass |
| E | Number of Hopping Channels | RSS-210 § 10 | RSS-210 A1 §I (ii) | Note 1 | Note 1 | Pass |
| F | Channel Dwell Time | RSS-210 § 10 | RSS-210 A1 §I (ii) | Note 1 | Note 1 | Pass |
| G | 20 dB Bandwidth | RSS-210 § 10 | RSS-210 A1 §I (ii) | Note 1 | Note 1 | Pass |
| H | Radiated Spurious Emissions | RSS-212, ANSI C63.4 | RSS-210 §6.2.2 (o)(e1) | 22Sep04 | 01Oct04 22Oct04 | Pass |
| I | Restricted Band Emissions | RSS-212, ANSI C63.4 | RSS-210 §6.3 | 22Sep04 | 01Oct04 22Oct04 | Pass |
| J | Maximum Permissible Exposure | RSS-102 | RSS-210 §14 Safety Code 6 2.2.1(a) Table 5 | 13Oct04 | 13Oct04 | Pass |

Note 1: The test procedures used and the results obtained are referenced to the ACS Test Report Number 03-0193-15BC.

REVISION LOG

| Issue | Description | Implemented By | Implementation Date |
|-------|-----------------|----------------|---------------------|
| 1.0 | Initial Release | Jon Hughes | 09May05 |

SIGNATORIES

| | | |
|-------------|-------------------------------------------------------------------------------------|--------------|
| Prepared By |  | May 09, 2005 |
| Name/Title | Duane M. Friesen, C.E.T. / EMC Manager | Date |
| Approved By |  | May 09, 2005 |
| Name/Title | Jon Hughes / General Manager | Date |

| | | | | | | | | |
|----------------------------------------------------------------------------------------------------|---------------------|----------------------------------------------------------------------------------------------------------------|----------------|----------------|-------------------|---------------|---------------------------------------------------------------------------------------|--|
| Applicant: | Itronix Corporation | Model: | IX260PROA580BT | FCC ID: | KBCIX260PROA580BT | IC ID: | 1943A-IX260PF | |
| Rugged Laptop PC with Cirronet BT2022 Bluetooth, Intel Pro 2200BG 802.11b/g WLAN, & Dual-Band CDMA | | | | | | |  | |
| 2005 Celltech Labs Inc | | This document is not to be reproduced in whole or in part without the written permission of Celltech Labs Inc. | | | | | 5 of 45 | |

| | | |
|--------------------------------|-----------------------------|--------------------|
| Test Report Serial No.: | 022305KBC-T618-E15B | Issue 1.0 |
| Test Date(s): | 21Sept04 - 14Oct04, 22Oct04 | |
| Test Type(s): | FCC §15.247 | IC RSS-210 Issue 5 |
| Lab Registration(s): | FCC #714830 | IC Lab File #3874 |

1.0 SCOPE

This report outlines the measurements made and results collected during electromagnetic emissions testing of the Itronix Corporation Rugged Laptop PC including the internal Cirronet BT2022 Bluetooth Transmitter with a RangeStar internal surface-mount antenna located in the upper left side rear of the LCD display. The DUT also incorporates an internal Intel Pro 2200BG 802.11b/g 2.4 GHz DSSS WLAN Mini-PCI Card with a RangeStar internal surface-mount antenna located in the upper right side rear of the LCD display. The DUT also incorporates an internal co-located internal Sierra Wireless Dual-Band CDMA PCMCIA Modem with an external swivel dipole antenna located at the upper right side edge of the LCD display. **The Cirronet BT2022 Bluetooth and the Intel Pro 2200BG 802.11b/g WLAN can transmit simultaneously. The Cirronet BT2022 Bluetooth and the Sierra Wireless CDMA Modem can transmit simultaneously. The Intel Pro 2200BG 802.11b/g WLAN and the Sierra Wireless CDMA PCMCIA Modem were disabled during the Cirronet BT2022 Bluetooth measurements referenced in this report. Please refer to the Supplementary EMC test reports for simultaneous transmit measurement data.** The results were applied against the EMC requirements and limits outlined in the technical rules and regulations set forth in the Federal Communication Commission Code of Federal Regulations Title 47 Part 15 Subpart C, and Industry Canada Radio Standards Specifications RSS-210 Issue 5.

2.0 REFERENCES

2.1 Normative References

| | |
|----------------------------------------------------|------------------------------------------------------------------------------------------------------------------------------------------------------------------------------------------------------------------------------------------------------------------------------------------------------------------------------------------------------------------------------------------------------------------------------------------------|
| ANSI/ISO 17025:1999 | General Requirements for competence of testing and calibration laboratories |
| IEEE/ANSI C63.4-2003 | Methods of Measurement of Radio-Noise Emissions from Low-Voltage Electrical and Electronic Equipment in the Range of 9 kHz to 40 GHz |
| IEEE/ANSI Std C95.1-1999 | American National Standard Safety Levels with Respect to Human Exposure to Radio Frequency Electromagnetic Fields |
| CFR Title 47 Part 2:2003 | Code of Federal Regulations Title 47: Telecommunication Part 2: Frequency Allocations and Radio Treaty Matters; General Rules and Regulations |
| CFR Title 47 Part 15:2003 | Code of Federal Regulations Title 47: Telecommunication Part 15: Radio Frequency Devices |
| IC Spectrum Management & Telecommunications Policy | Radio Standards Specification RSS-212 Issue 1 (Provisional) - Test Facilities & Test Methods for Radio Equipment RSS-210 Issue 5 - Low Power Licence-Exempt Radiocommunication Devices: November 2001 & Amendment November 30, 2002 RSS-102 Issue 1 (Provisional) - Evaluation Procedure for Mobile and Portable Radio Transmitters with respect to Health Canada's Safety Code 6 for Exposure of Humans to Radio Frequency Fields |
| ACS Test Report | FCC Part 15 Certification Test Report 2.4 GHz Frequency Hopping Spread Spectrum (Modular Approval) ACS Report Number 03-0193-15BC Issue Date: January 5, 2004 |

| | | | | | | | |
|---------------------------------------------------------------------------------------------------------------|----------------------------------------------------------------------------------------------------------------|---------------|----------------|----------------|-------------------|---------------|---------------------------------------------------------------------------------------|
| Applicant: | Itronix Corporation | Model: | IX260PROA580BT | FCC ID: | KBCIX260PROA580BT | IC ID: | 1943A-IX260Pf |
| Rugged Laptop PC with Cirronet BT2022 Bluetooth, Intel Pro 2200BG 802.11b/g WLAN, & Dual-Band CDMA | | | | | | |  |
| 2005 Celltech Labs Inc | This document is not to be reproduced in whole or in part without the written permission of Celltech Labs Inc. | | | | | | 6 of 45 |

| | | |
|--------------------------------|-----------------------------|--------------------|
| Test Report Serial No.: | 022305KBC-T618-E15B | Issue 1.0 |
| Test Date(s): | 21Sept04 - 14Oct04, 22Oct04 | |
| Test Type(s): | FCC §15.247 | IC RSS-210 Issue 5 |
| Lab Registration(s): | FCC #714830 | IC Lab File #3874 |

3.0 TERMS AND DEFINITIONS

| | |
|------|-----------------------------------|
| AVG | Average |
| CFR | Code of Federal Regulations |
| dB | decibel |
| dBm | dB referenced to 1 mW |
| dBuV | dB referenced to 1 uV |
| DUT | Device under Test |
| dBc | dB down from carrier |
| EBW | Emission Bandwidth |
| EMC | Electromagnetic Compatibility |
| FCC | Federal Communication Commission |
| FHSS | Frequency Hopping Spread Spectrum |
| HP | Hewlett Packard |
| HPF | High Pass Filter |
| Hpol | Horizontal Polarization |
| Hz | Hertz |
| IC | Industry Canada |
| kHz | kilohertz |
| LNA | Low Noise Amplifier |
| m | meter |
| MHz | Megahertz |
| Mbps | megabits per second |
| na | not applicable |
| n/a | not available |
| PK | Peak |
| PPSD | Peak Power Spectral Density |
| QP | Quasi-peak |
| RBW | Resolution Bandwidth |
| R&S | Rohde & Schwarz |
| RSS | Radio Standard Specification |
| SA | Spectrum Analyzer |
| VBW | Video Bandwidth |
| Vpol | Vertical Polarization |
| WLAN | Wireless Local Area Network |

| | | | | | | | | |
|---------------------------------------------------------------------------------------------------------------|---------------------|----------------------------------------------------------------------------------------------------------------|----------------|----------------|-------------------|---------------|---------------------------------------------------------------------------------------|--|
| Applicant: | Itronix Corporation | Model: | IX260PROA580BT | FCC ID: | KBCIX260PROA580BT | IC ID: | 1943A-IX260Pf | |
| Rugged Laptop PC with Cirronet BT2022 Bluetooth, Intel Pro 2200BG 802.11b/g WLAN, & Dual-Band CDMA | | | | | | |  | |
| 2005 Celltech Labs Inc | | This document is not to be reproduced in whole or in part without the written permission of Celltech Labs Inc. | | | | | 7 of 45 | |

| | | |
|--------------------------------|-----------------------------|--------------------|
| Test Report Serial No.: | 022305KBC-T618-E15B | Issue 1.0 |
| Test Date(s): | 21Sept04 - 14Oct04, 22Oct04 | |
| Test Type(s): | FCC §15.247 | IC RSS-210 Issue 5 |
| Lab Registration(s): | FCC #714830 | IC Lab File #3874 |

4.0 FACILITIES AND ACCREDITATIONS

The facilities used in collecting the test results outlined in this report are located at 1955 Moss Court, Kelowna, British Columbia, Canada, V1Y 9L3. The radiated and conducted emissions sites conform with the requirements set forth in ANSI C63.4 and are filed and listed with the FCC under Registration Number 714830 and Industry Canada under File Number IC 3874.

5.0 GENERAL INFORMATION

5.1 Applicant Information

| | |
|----------------------|----------------------------------------------------------------|
| Company Name: | Itronix Corporation |
| Address: | 801 South Stevens Street Spokane, WA 99204 United States |

5.2 DUT Description

The DUT consisted of the Rugged Laptop PC with the Cirronet BT2022 Bluetooth Transmitter connected to the RangeStar Internal Surface-Mount Antenna installed in the upper left side rear of the LCD display. Co-located within the Rugged Laptop PC is an Intel Pro 2200BG 802.11b/g 2.4 GHz DSSS WLAN Mini-PCI Card connected to the RangeStar Internal Surface-Mount Antenna installed in the upper right side rear of the LCD display. The DUT also incorporates an internal co-located Sierra Wireless Dual-Band CDMA PCMCIA Modem with external swivel dipole antenna located at the upper right side edge of the LCD display. Photographs of the DUT placement and construction are shown in Appendix A.

| | | | |
|-------------------------|--------------------------------------------------------------------------------------------------------------------------|------------|---------------|
| Device: | IX260+ Rugged Laptop PC | | |
| Model: | IX260PROA580BT | | |
| Serial Number: | ZZGEG4196ZZ6473 | | |
| Identifier(s): | FCC ID: KBCIX260PROA580BT | IC: | 1943A-IX260Pf |
| Power Source(s): | Delta Electronics Model ADP-90AB Rev B 90 Watt AC-DC power supply 11.1 V Lithium-ion Battery, 6.0 Ah (Model: A2121-2) | | |

| | | | |
|------------------------|----------------------------------------------------------------------|------------|--------------------------------------|
| Device: | 2.4GHz FHSS Bluetooth Transmitter | | |
| Model: | Cirronet BT2022 | | |
| Serial Number: | n/a | | |
| Rule Part(s): | FCC: §15.247; §2.1091; §1.1310 | IC: | RSS-210 Issue 5 |
| Classification: | FCC: Spread Spectrum Transmitter (DSS) | IC: | Low Power Licence-Exempt Transmitter |
| Power Source: | Powered from the internal PC power supply | | |
| Device: | Internal Surface-Mount Antenna (upper left side rear of LCD display) | | |
| Model: | RangeStar P/N: 100929 | | |
| Gain: | +4.5 dBi | | |

| | | | |
|---------------------------------------------------------------------------------------------------------------|----------------------------------------------------------------------------------------------------------------|----------------------------------|---------------------------------------------------------------------------------------|
| Applicant: Itronix Corporation | Model: IX260PROA580BT | FCC ID: KBCIX260PROA580BT | IC ID: 1943A-IX260Pf |
| Rugged Laptop PC with Cirronet BT2022 Bluetooth, Intel Pro 2200BG 802.11b/g WLAN, & Dual-Band CDMA | | |  |
| 2005 Celltech Labs Inc | This document is not to be reproduced in whole or in part without the written permission of Celltech Labs Inc. | | 8 of 45 |

| | | |
|--------------------------------|-----------------------------|--------------------|
| Test Report Serial No.: | 022305KBC-T618-E15B | Issue 1.0 |
| Test Date(s): | 21Sept04 - 14Oct04, 22Oct04 | |
| Test Type(s): | FCC §15.247 | IC RSS-210 Issue 5 |
| Lab Registration(s): | FCC #714830 | IC Lab File #3874 |

5.3 Co-Located Equipment

| | |
|-----------------------|-----------------------------------------------------------------------|
| Device: | 2.4GHz DSSS WLAN Mini-PCI Card (802.11b/g) |
| Model: | Intel Pro 2200BG |
| Serial Number: | 06036C074ADC54906006 |
| Device: | Internal Surface-Mount Antenna (upper right side rear of LCD display) |
| Model: | RangeStar P/N: 100929 |
| Gain: | +4.5 dBi |

| | |
|----------------|-----------------------------------------------------------------------|
| Device: | Dual-Band PCS/Cellular CDMA PCMCIA Modem |
| Model: | Sierra Wireless AirCard |
| Device: | External Swivel Dipole Antenna (upper right side edge of LCD display) |
| Model: | Itronix IX260+ |
| Gain: | +2.6 dBi |

| | |
|----------------|------------------------------------------------|
| Device: | GPS Receiver Module and Antenna (Receive only) |
| Model: | Leadtek P/N GPS9547 |

5.4 Cable Descriptions

| ROUTING | | Length m | Model | Terminations | | Shield Type | Shield Termination | | Suppression |
|-------------------|--------------|-------------|-------------------|--------------|-----------|-------------|--------------------|-------|-------------|
| From | To | | | End 1 | End 2 | | End 1 | End 2 | |
| PC Fire Wire Port | Unterminated | 1.0 | Copartner E119932 | IEEE-1528 | Fire wire | n/a | n/a | n/a | None |
| PC modem port | Unterminated | 1.0 | n/a | RJ-11 | RJ-11 | None | na | na | None |
| PC Ethernet Port | Ethernet Hub | 1.0 | N/a | RJ-45 | RJ-45 | None | na | na | None |

5.5 Support Equipment

The following equipment was used in support of the DUT.

| CO-LOCATED SUPPORT EQUIPMENT LIST | | |
|-----------------------------------|-----------|--------------------|
| MANUFACTURER | MODEL | DESCRIPTION |
| D-Link | DE-809TC/ | Ethernet hub |
| YNG YUH | YP-040 | Hub power supply |
| MLi | 699 | Speakers |
| Polk Audio | n/a | Speaker-microphone |
| DeLorme | Tripmate | GPS Receiver |
| Intel | CS-430 | Camera |
| Logitech | M-S34 | Mouse |

| | | | | | | | | |
|---------------------------------------------------------------------------------------------------------------|---------------------|----------------------------------------------------------------------------------------------------------------|----------------|----------------|-------------------|---------------|---------------------------------------------------------------------------------------|--|
| Applicant: | Itronix Corporation | Model: | IX260PROA580BT | FCC ID: | KBCIX260PROA580BT | IC ID: | 1943A-IX260Pf | |
| Rugged Laptop PC with Cirronet BT2022 Bluetooth, Intel Pro 2200BG 802.11b/g WLAN, & Dual-Band CDMA | | | | | | |  | |
| 2005 Celltech Labs Inc | | This document is not to be reproduced in whole or in part without the written permission of Celltech Labs Inc. | | | | | 9 of 45 | |

5.6 Clock Frequencies

5.6.1 DUT Clock Frequencies

| | |
|----------------|--------------------------------|
| Device: | Rugged Laptop PC |
| Clocks: | 1.6 GHz processor |
| Device: | 2.4GHz FHSS Cirronet Bluetooth |
| Clocks: | n/a |
| Device: | Internal Surface-Mount Antenna |
| Clocks: | None |

5.6.2 Co-Located Clock Frequencies

| | |
|----------------|-------------|
| Device: | Peripherals |
| Clocks: | n/a |

5.7 Mode(s) of Operation Tested

Customer supplied software was used to place the Bluetooth transmitter at the appropriate channel with the power level and modulation for the specific measurement.

| | |
|----------------------------------------------|-------------------------------------------------------------------------------------------------------------|
| TX Frequency Range | 2402 - 2480 MHz Ch. 0 (2402 MHz), Ch. 39 (2441 MHz) & Ch. 78 (2480 MHz) measured unless otherwise noted) |
| Software Power Gain Settings | Ch. 0 - 250 / 40 Ch. 39 - 250 / 44 Ch. 78 - 220 / 45 |
| RF Peak Conducted Output Power Tested | Ch. 0 - +15.40 dBm Ch. 39 - +15.61 dBm Ch. 78 - +15.34 dBm |
| Modulation Type | GFSK 0.5 BT Gaussian |
| Modulation Frequency | 1000 |
| Battery Type(s) | 11.1V Lithium-Ion, 6.0Ah (Model: A2121-2) |

5.7.1 DUT Exercising Software Description

The DUT was configured and exercised using customer supplied test software that allowed an operator to set the parameters of the Bluetooth transmitter's operation. The settings used are described in each appendix.

| | | |
|--------------------------------|-----------------------------|--------------------|
| Test Report Serial No.: | 022305KBC-T618-E15B | Issue 1.0 |
| Test Date(s): | 21Sept04 - 14Oct04, 22Oct04 | |
| Test Type(s): | FCC §15.247 | IC RSS-210 Issue 5 |
| Lab Registration(s): | FCC #714830 | IC Lab File #3874 |

5.8 Configuration Description

The DUT was configured, as described by the client as being representative of what would be delivered to a final customer. More specific details may be included in each appendix.

5.8.1 Configuration Justification

The DUT was tested in a configuration described by the client as being worse case but typical of normal use.

Prescan measurements were made with the Bluetooth transmitter set at each of three frequencies describing the frequency band of operation; low (2402 MHz), mid (2441 MHz) and high (2480 MHz) to determine the highest emission present in each band. The transmit power setting for each of these frequencies was set to closely match that defined in the modular certification. A representative modulation of 1000 was applied when applicable. Unless otherwise specified in the applicable appendices, these settings were used for the measurements described in this report.

6.0 PASS/FAIL CRITERIA

Unless otherwise noted in the Appendices, the pass/fail criteria is the limit set forth in the reference standards. A DUT is considered to have passed the requirements, if the data collected during the described measurement procedure is no greater than the specified limits as defined. The pass/fail statements made in this report only apply to the unit tested.

| | | | | | | | | |
|---------------------------------------------------------------------------------------------------------------|---------------------|----------------------------------------------------------------------------------------------------------------|----------------|----------------|-------------------|---------------|---------------------------------------------------------------------------------------|--|
| Applicant: | Itronix Corporation | Model: | IX260PROA580BT | FCC ID: | KBCIX260PROA580BT | IC ID: | 1943A-IX260Pf | |
| Rugged Laptop PC with Cirronet BT2022 Bluetooth, Intel Pro 2200BG 802.11b/g WLAN, & Dual-Band CDMA | | | | | | |  | |
| 2005 Celltech Labs Inc | | This document is not to be reproduced in whole or in part without the written permission of Celltech Labs Inc. | | | | | 11 of 45 | |

| | | |
|--------------------------------|-----------------------------|--------------------|
| Test Report Serial No.: | 022305KBC-T618-E15B | Issue 1.0 |
| Test Date(s): | 21Sept04 - 14Oct04, 22Oct04 | |
| Test Type(s): | FCC §15.247 | IC RSS-210 Issue 5 |
| Lab Registration(s): | FCC #714830 | IC Lab File #3874 |

APPENDICES

| | | | | | | | | |
|---------------------------------------------------------------------------------------------------------------|---------------------|----------------------------------------------------------------------------------------------------------------|----------------|----------------|-------------------|---------------|---------------------------------------------------------------------------------------|--|
| Applicant: | Itronix Corporation | Model: | IX260PROA580BT | FCC ID: | KBCIX260PROA580BT | IC ID: | 1943A-IX260Pf | |
| Rugged Laptop PC with Cirronet BT2022 Bluetooth, Intel Pro 2200BG 802.11b/g WLAN, & Dual-Band CDMA | | | | | | |  | |
| 2005 Celltech Labs Inc | | This document is not to be reproduced in whole or in part without the written permission of Celltech Labs Inc. | | | | | 12 of 45 | |

| | | |
|--------------------------------|-----------------------------|--------------------|
| Test Report Serial No.: | 022305KBC-T618-E15B | Issue 1.0 |
| Test Date(s): | 21Sept04 - 14Oct04, 22Oct04 | |
| Test Type(s): | FCC §15.247 | IC RSS-210 Issue 5 |
| Lab Registration(s): | FCC #714830 | IC Lab File #3874 |

Appendix A - DUT Photographs

Photograph A-1 - Front of Open IX260+ Laptop PC



Photograph A-2 - Back of Open IX260+ Laptop PC



Photograph A-3 - Left Side of Open IX260+ Laptop PC



Photograph A-4 - Right Side of Open IX260+ Laptop PC



| | | | | | | | | |
|---------------------------------------------------------------------------------------------------------------|---------------------|----------------------------------------------------------------------------------------------------------------|----------------|----------------|-------------------|---------------|---------------------------------------------------------------------------------------|--|
| Applicant: | Itronix Corporation | Model: | IX260PROA580BT | FCC ID: | KBCIX260PROA580BT | IC ID: | 1943A-IX260Pf | |
| Rugged Laptop PC with Cirronet BT2022 Bluetooth, Intel Pro 2200BG 802.11b/g WLAN, & Dual-Band CDMA | | | | | | |  | |
| 2005 Celltech Labs Inc | | This document is not to be reproduced in whole or in part without the written permission of Celltech Labs Inc. | | | | | 13 of 45 | |

| | | |
|--------------------------------|-----------------------------|--------------------|
| Test Report Serial No.: | 022305KBC-T618-E15B | Issue 1.0 |
| Test Date(s): | 21Sept04 - 14Oct04, 22Oct04 | |
| Test Type(s): | FCC §15.247 | IC RSS-210 Issue 5 |
| Lab Registration(s): | FCC #714830 | IC Lab File #3874 |

Appendix B - Conducted Powerline Emissions Measurement

| B.1. REFERENCES | |
|-------------------------------------|----------------------------|
| Normative Reference Standard | CFR 47 FCC Part 15 §15.207 |
| Procedure Reference | ANSI C63.4 |

| B.2. LIMITS | | |
|--------------------------------------------------------------------------------------------------------------------------------------------------------------------------------------------|------------------------|-----------|
| <p>§15.207: Compliance with the provisions of this paragraph shall be based on the measurement of the radio frequency voltage between each powerline and ground at the power terminal.</p> | | |
| Frequency of Emission (MHz) | Conducted Limit (dBuV) | |
| | Quasi-Peak | Average |
| 0.15 – 0.5 | 66 to 56* | 56 to 46* |
| 0.50 – 5.0 | 56 | 46 |
| 5.0 – 30.0 | 60 | 50 |

*Decreases with the logarithm of the frequency

| B.3. ENVIRONMENTAL CONDITIONS | |
|-------------------------------|---------------|
| Temperature | +26 ± 5 °C |
| Humidity | 31 % ± 10% RH |
| Barometric Pressure | 101.4 kpa |

| B.4. EQUIPMENT LIST | | | | | |
|---------------------|--------------|--------|--------------------------------------|----------|---------|
| ASSET NUMBER | MANUFACTURER | MODEL | DESCRIPTION | LAST CAL | CAL DUE |
| 00063 | HP | 85662A | Spectrum Analyzer Display | na | na |
| 00051 | HP | 8566B | Spectrum Analyzer RF Section | 18May04 | 18May05 |
| 00049 | HP | 85650A | Quasi-Peak Adapter | 18May04 | 18May05 |
| 00047 | HP | 85685A | Preselector | 18May04 | 18May05 |
| 00083 | EMCO | 3825/2 | Line Impedance Stabilization Network | 29Apr04 | 29Apr05 |
| 00084 | EMCO | 3825/2 | Line Impedance Stabilization Network | 29Apr04 | 29Apr05 |

| | | | | | | | | |
|---------------------------------------------------------------------------------------------------------------|---------------------|----------------------------------------------------------------------------------------------------------------|----------------|----------------|-------------------|---------------|---------------------------------------------------------------------------------------|--|
| Applicant: | Itronix Corporation | Model: | IX260PROA580BT | FCC ID: | KBCIX260PROA580BT | IC ID: | 1943A-IX260Pf | |
| Rugged Laptop PC with Cirronet BT2022 Bluetooth, Intel Pro 2200BG 802.11b/g WLAN, & Dual-Band CDMA | | | | | | |  | |
| 2005 Celltech Labs Inc | | This document is not to be reproduced in whole or in part without the written permission of Celltech Labs Inc. | | | | | 14 of 45 | |

| | | |
|--------------------------------|-----------------------------|--------------------|
| Test Report Serial No.: | 022305KBC-T618-E15B | Issue 1.0 |
| Test Date(s): | 21Sept04 - 14Oct04, 22Oct04 | |
| Test Type(s): | FCC §15.247 | IC RSS-210 Issue 5 |
| Lab Registration(s): | FCC #714830 | IC Lab File #3874 |

| B.5. MEASUREMENT EQUIPMENT SETUP | |
|------------------------------------------|-------------------------------------------------------------------------------------------------------------------------------------------------------------------------------------------------------------------------------------------------------------------------------------------------------------------------------------------------------------------------------------------------------------------------------------------------------------------------------------------------------------------------------------------------------------------------------------------------------------------------------------------------------------------------------------------------------------------------------------------------------------------------------------------------------------------------------------------------------------------------------------------------------------------------------------------------------------------------------------------------------------------------------------------------------------------------------------------------|
| MEASUREMENT EQUIPMENT CONNECTIONS | The conducted emissions were measured on each of the two AC powerline leads connected to the DUT's power supply brick. A two line LISN was used to make this measurement. A drawing of the equipment setup is shown in B.7 |
| MEASUREMENT EQUIPMENT SETTINGS | <p>Each of the monitor ports from the 2-line LISN was connected in turn to the spectrum analyzer. The port not connected to the analyzer was terminated in a 50-ohm load. A pre-scan of the peak emission levels was made of the 150 kHz – 30 MHz range split into 4 equal frequency bands. The following were the instrumentation settings:</p> <p>Spectrum Analyzer: Start Frequency and Stop Frequency set by software for each of the four bands RBW: 100 kHz VBW: 300 kHz Sweep: 500 mS</p> <p>Quasi-Peak Adapter: Normal - Automatic Bandwidth Setting: 9 kHz</p> <p>The resulting data from each band was corrected and collected by software and presented in the graphical representations shown in B.9 for the two leads.</p> <p>A defined set of frequency points of interest on each lead were used by software to optimize a set of readings for each type of detector (peak, quasi-peak and average). This data was corrected by the software and is presented in the tables shown in section B.9.</p> |

| | | | | | | | | |
|---------------------------------------------------------------------------------------------------------------|---------------------|----------------------------------------------------------------------------------------------------------------|----------------|----------------|-------------------|---------------|---------------------------------------------------------------------------------------|--|
| Applicant: | Itronix Corporation | Model: | IX260PROA580BT | FCC ID: | KBCIX260PROA580BT | IC ID: | 1943A-IX260Pf | |
| Rugged Laptop PC with Cirronet BT2022 Bluetooth, Intel Pro 2200BG 802.11b/g WLAN, & Dual-Band CDMA | | | | | | |  | |
| 2005 Celltech Labs Inc | | This document is not to be reproduced in whole or in part without the written permission of Celltech Labs Inc. | | | | | 15 of 45 | |

| | | |
|--------------------------------|-----------------------------|--------------------|
| Test Report Serial No.: | 022305KBC-T618-E15B | Issue 1.0 |
| Test Date(s): | 21Sept04 - 14Oct04, 22Oct04 | |
| Test Type(s): | FCC §15.247 | IC RSS-210 Issue 5 |
| Lab Registration(s): | FCC #714830 | IC Lab File #3874 |

B.6. SETUP PHOTOS

Photograph B-1 - AC Powerline Conducted Emission Configuration



Photograph B-2 - AC Powerline Conducted Emission Cable Placement



| | | | | | | | | |
|---------------------------------------------------------------------------------------------------------------|---------------------|----------------------------------------------------------------------------------------------------------------|----------------|----------------|-------------------|---------------|---------------------------------------------------------------------------------------|--|
| Applicant: | Itronix Corporation | Model: | IX260PROA580BT | FCC ID: | KBCIX260PROA580BT | IC ID: | 1943A-IX260Pf | |
| Rugged Laptop PC with Cirronet BT2022 Bluetooth, Intel Pro 2200BG 802.11b/g WLAN, & Dual-Band CDMA | | | | | | |  | |
| 2005 Celltech Labs Inc | | This document is not to be reproduced in whole or in part without the written permission of Celltech Labs Inc. | | | | | 16 of 45 | |

B.7. SETUP DRAWING

Figure B-1 - Setup Drawing

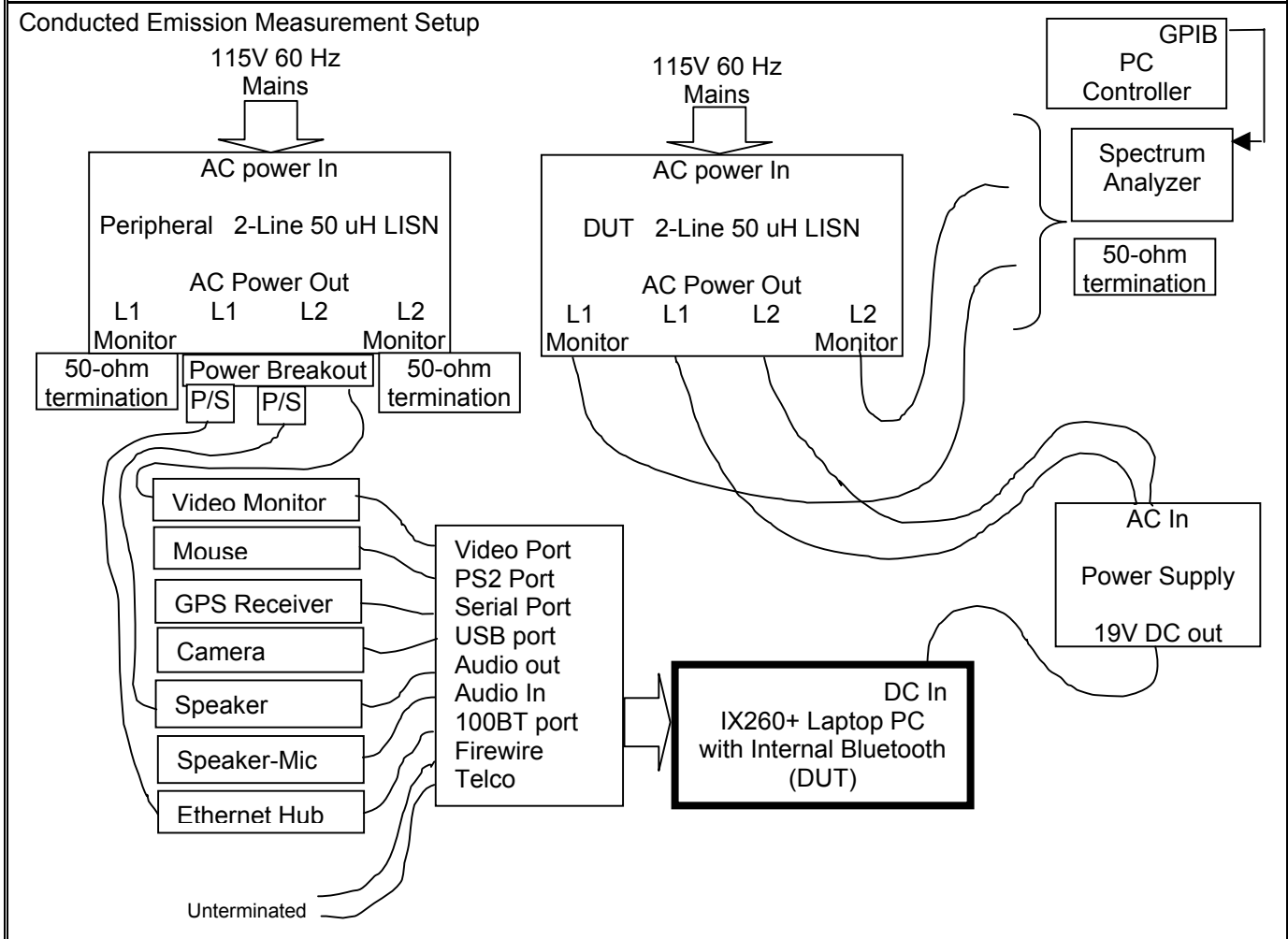

B.8. DUT OPERATING DESCRIPTION

| | |
|--------------------|----------------------------------------------------------------------------------------------------------------------|
| Bluetooth | The Bluetooth transmitter was set to transmit at full power on Channel 39 (2441 MHz) with a 1000 modulation setting. |
| PC | Other than operating the Bluetooth software and running MS windows, no PC exercising was performed. |
| Peripherals | All peripherals were active, but no specific traffic was initiated. |

| | | |
|--------------------------------|-----------------------------|--------------------|
| Test Report Serial No.: | 022305KBC-T618-E15B | Issue 1.0 |
| Test Date(s): | 21Sept04 - 14Oct04, 22Oct04 | |
| Test Type(s): | FCC §15.247 | IC RSS-210 Issue 5 |
| Lab Registration(s): | FCC #714830 | IC Lab File #3874 |

B.9. TEST RESULTS

Following are peak emission plots and tabular data describing the peak, quasi-peak and average measurements made of the DUT.

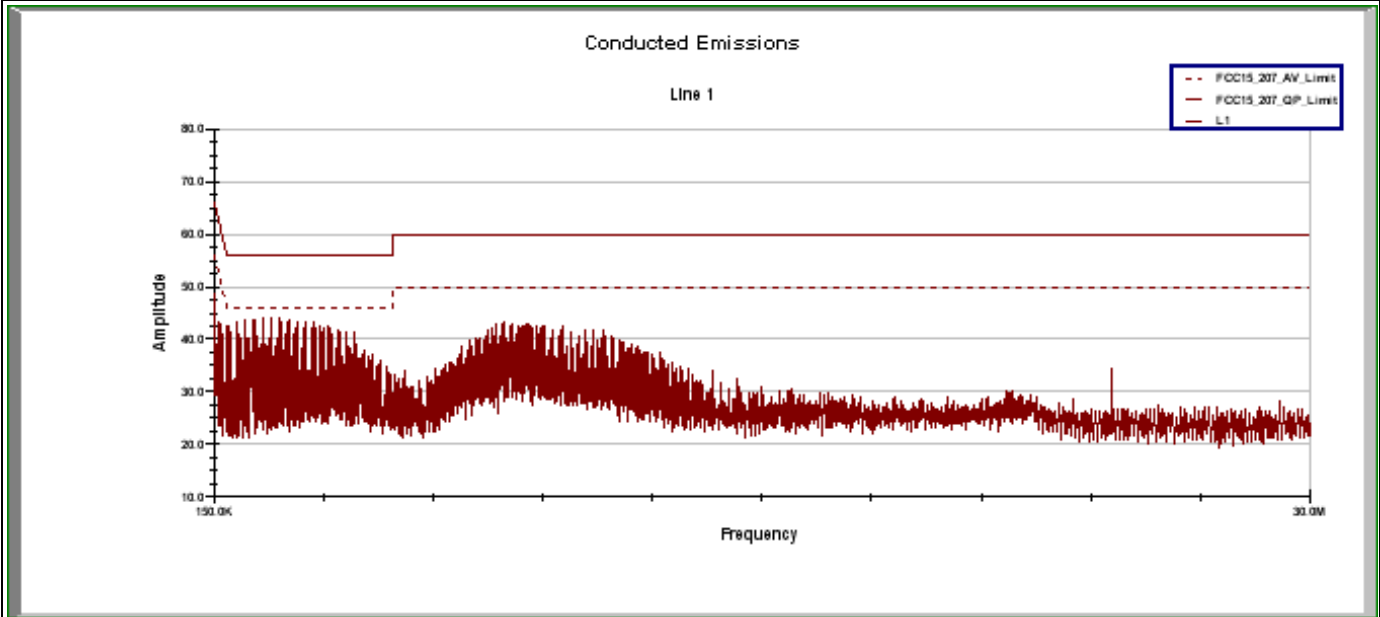

| | | | | |
|--|------------------------|---------------------------------------|-------------------------|------------|
| | Project Number: | 072804KBC-T543-E15B | Standard: | FCC 15.207 |
| | Company: | Itronix | Test Start Date: | 14-Oct-04 |
| | Product: | IX260+ with Cirronet BT2022 Bluetooth | Test End Date: | 14-Oct-04 |

| Line 1 Conducted Emissions | | | | | | | | | | | | |
|----------------------------|---------------------|--------------------|-----------------|----------------------------|--------------------------|--------------------|-----------------|-----------------------------|----------------------------|--------------------------|-------------------------|-----------|
| Frequency MHz | Uncorrected Reading | | | Correction Factor dB | Corrected Emission Level | | | Quasi-Peak Limit dBuV | Quasi-Peak Margin dB | Average Limit dBuV | Average Margin dB | Pass/Fail |
| | Peak dBuV | Quasi-Peak dBuV | Average dBuV | | Peak dBuV | Quasi-Peak dBuV | Average dBuV | | | | | |
| 0.159 | 50.40 | 47.24 | 45.54 | 1.98 | 52.38 | 49.22 | 47.52 | 65.53 | 16.31 | 55.53 | 8.01 | Pass |
| 1.251 | 43.60 | 43.04 | 43.15 | 0.31 | 43.91 | 43.35 | 43.46 | 56.00 | 12.66 | 46.00 | 2.55 | Pass |
| 1.252 | 43.80 | 43.14 | 43.29 | 0.30 | 44.10 | 43.44 | 43.59 | 56.00 | 12.56 | 46.00 | 2.41 | Pass |
| 1.486 | 44.00 | 43.19 | 43.32 | 0.29 | 44.29 | 43.48 | 43.61 | 56.00 | 12.52 | 46.00 | 2.39 | Pass |
| 1.718 | 43.80 | 43.15 | 43.18 | 0.29 | 44.09 | 43.44 | 43.47 | 56.00 | 12.57 | 46.00 | 2.54 | Pass |
| 1.722 | 44.00 | 43.34 | 43.50 | 0.28 | 44.29 | 43.63 | 43.78 | 56.00 | 12.38 | 46.00 | 2.22 | Pass |
| 1.957 | 44.10 | 43.25 | 43.34 | 0.28 | 44.38 | 43.53 | 43.62 | 56.00 | 12.47 | 46.00 | 2.38 | Pass |
| 8.055 | 43.40 | 41.99 | 39.94 | 0.32 | 43.72 | 42.31 | 40.26 | 60.00 | 17.69 | 50.00 | 9.74 | Pass |

Corrected Emission Level (dBuV) = Uncorrected Reading (dBuV) + Correction Factor (dB)
Margin (dB) = Limit (dBuV) - Corrected Emission Level (dBuV)

| | | | | | | | | |
|---------------------------------------------------------------------------------------------------------------|---------------------|----------------------------------------------------------------------------------------------------------------|----------------|----------------|-------------------|---------------|---------------|--|
| Applicant: | Itronix Corporation | Model: | IX260PROA580BT | FCC ID: | KBCIX260PROA580BT | IC ID: | 1943A-IX260PF | |
| Rugged Laptop PC with Cirronet BT2022 Bluetooth, Intel Pro 2200BG 802.11b/g WLAN, & Dual-Band CDMA | | | | | | | | |
| 2005 Celltech Labs Inc | | This document is not to be reproduced in whole or in part without the written permission of Celltech Labs Inc. | | | | | 18 of 45 | |

| | | |
|--------------------------------|-----------------------------|--------------------|
| Test Report Serial No.: | 022305KBC-T618-E15B | Issue 1.0 |
| Test Date(s): | 21Sept04 - 14Oct04, 22Oct04 | |
| Test Type(s): | FCC §15.247 | IC RSS-210 Issue 5 |
| Lab Registration(s): | FCC #714830 | IC Lab File #3874 |

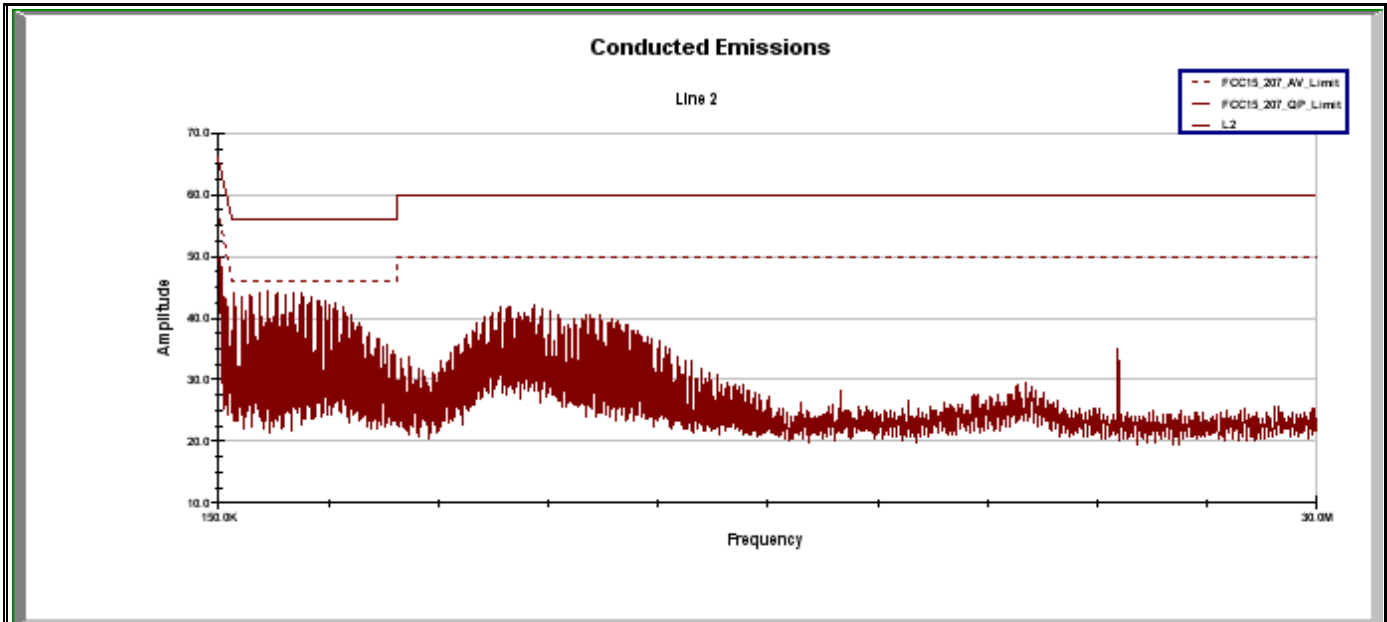

| | Project Number: | 072804KBC-T543-E15B | Standard: | FCC 15.207 | | | | | | | | |
|---------------------------------------------------------------------------------------|------------------------|---------------------------------------|-------------------------|----------------------------|--------------------------|--------------------|-----------------|-----------------------------|----------------------------|--------------------------|-------------------------|-----------|
| | Company: | Itronix | Test Start Date: | 14-Oct-04 | | | | | | | | |
| | Product: | IX260+ with Cirronet BT2022 Bluetooth | Test End Date: | 14-Oct-04 | | | | | | | | |
| Line 2 Conducted Emissions | | | | | | | | | | | | |
| Frequency MHz | Uncorrected Reading | | | Correction Factor dB | Corrected Emission Level | | | Quasi-Peak Limit dBuV | Quasi-Peak Margin dB | Average Limit dBuV | Average Margin dB | Pass/Fail |
| | Peak dBuV | Quasi-Peak dBuV | Average dBuV | | Peak dBuV | Quasi-Peak dBuV | Average dBuV | | | | | |
| 0.158 | 51.50 | 48.10 | 47.43 | 1.98 | 53.48 | 50.08 | 49.41 | 65.55 | 15.47 | 55.55 | 6.14 | Pass |
| 0.215 | 47.50 | 45.05 | 36.85 | 1.28 | 48.78 | 46.33 | 38.13 | 63.00 | 16.67 | 53.00 | 14.87 | Pass |
| 0.500 | 47.09 | 45.17 | 39.25 | 0.47 | 47.56 | 45.64 | 39.72 | 56.00 | 10.36 | 46.00 | 6.28 | Pass |
| 1.253 | 44.00 | 43.50 | 43.59 | 0.30 | 44.30 | 43.80 | 43.89 | 56.00 | 12.20 | 46.00 | 2.11 | Pass |
| 1.483 | 44.10 | 43.48 | 43.48 | 0.29 | 44.39 | 43.77 | 43.77 | 56.00 | 12.23 | 46.00 | 2.23 | Pass |
| 1.485 | 44.30 | 43.51 | 43.59 | 0.29 | 44.59 | 43.80 | 43.89 | 56.00 | 12.20 | 46.00 | 2.11 | Pass |
| 5.000 | 43.18 | 42.37 | 41.73 | 0.30 | 43.48 | 42.67 | 42.03 | 56.00 | 13.33 | 46.00 | 3.97 | Pass |
| 8.683 | 41.99 | 41.15 | 39.76 | 0.33 | 42.32 | 41.48 | 40.09 | 60.00 | 18.52 | 50.00 | 9.91 | Pass |
| Corrected Emission Level (dBuV) = Uncorrected Reading (dBuV) + Correction Factor (dB) | | | | | | | | | | | | |
| Margin (dB) = Limit (dBuV) - Corrected Emission Level (dBuV) | | | | | | | | | | | | |

| | | | | | | | | |
|---------------------------------------------------------------------------------------------------------------|---------------------|----------------------------------------------------------------------------------------------------------------|----------------|----------------|-------------------|---------------|---------------|--|
| Applicant: | Itronix Corporation | Model: | IX260PROA580BT | FCC ID: | KBCIX260PROA580BT | IC ID: | 1943A-IX260Pf | |
| Rugged Laptop PC with Cirronet BT2022 Bluetooth, Intel Pro 2200BG 802.11b/g WLAN, & Dual-Band CDMA | | | | | | | | |
| 2005 Celltech Labs Inc | | This document is not to be reproduced in whole or in part without the written permission of Celltech Labs Inc. | | | | | 19 of 45 | |

| | | |
|--------------------------------|-----------------------------|--------------------|
| Test Report Serial No.: | 022305KBC-T618-E15B | Issue 1.0 |
| Test Date(s): | 21Sept04 - 14Oct04, 22Oct04 | |
| Test Type(s): | FCC §15.247 | IC RSS-210 Issue 5 |
| Lab Registration(s): | FCC #714830 | IC Lab File #3874 |

B.10. PASS/FAIL

In reference to the results outlined in B.9 the DUT passes the requirements as stated in the reference standards as follows:
 The RF voltage measured in reference to ground on each of the power line conductors does not exceed the limits as outline in FCC 15.207.

B.11. SIGN-OFF

I attest to the accuracy of the data. All measurements reported herein were performed by me and are correct to the best of my knowledge and belief. I assume full responsibility for the completeness of these measurements.



 Duane M. Friesen, C.E.T.
 EMC Manager
 Celltech Labs Inc.

 12Oct04
 Date

| | | |
|--------------------------------|-----------------------------|--------------------|
| Test Report Serial No.: | 022305KBC-T618-E15B | Issue 1.0 |
| Test Date(s): | 21Sept04 - 14Oct04, 22Oct04 | |
| Test Type(s): | FCC §15.247 | IC RSS-210 Issue 5 |
| Lab Registration(s): | FCC #714830 | IC Lab File #3874 |

Appendix C - Peak Conducted RF Output Power Measurement

| C.1. REFERENCES | |
|-------------------------------------|---------------------------|
| Normative Reference Standard | FCC CFR 47 §15.247(b) (1) |
| Procedure Reference | FCC 97-114 |

| C.2. LIMITS | |
|-----------------------------------------------------------------------------------------------------------------------------------------------------------------------------------------------------------------------------------------------------------------------------------------------------------------------------------|--|
| C.2.1. FCC CFR 47 | |
| <p>§15.247(b): The maximum peak output power of the intentional radiator shall not exceed the following: §15.247(b) (1) For frequency hopping systems operating in the 2400 – 2483.5 MHz band employing at least 75 hopping channels, and all frequency hopping systems in the 5725 – 5850 MHz bands: 1 Watt.*</p> | |

*Appendix E results confirm the number of hopping channels is at least 75.

Note: When a reference is made to conducted results outlined in the ACS test report they will be referenced to the conducted power measurements outlined in section 6.4 of that report. The conducted power measurements reported herein were made for correlation purposes and are applicable as references for the measurements described in this report.

| C.3. ENVIRONMENTAL CONDITIONS | |
|-------------------------------|---------------|
| Temperature | 25.2 +/- 2 °C |
| Humidity | 35 +/- 2 % |
| Barometric Pressure | 96.34 kPa |

| C.4. EQUIPMENT LIST | | | | | |
|---------------------|--------------|-----------|------------------------|----------|---------|
| ASSET NUMBER | MANUFACTURER | MODEL | DESCRIPTION | LAST CAL | CAL DUE |
| 00015 | Agilent | E4408B | Spectrum Analyzer | 29Dec03 | 29Dec04 |
| 00076 | Pasternack | PE7014-30 | 30dB 2 Watt Attenuator | 08Jul04* | 08Jul05 |

*Attenuator verified with power meter prior to use

| | | | | | | | | |
|----------------------------------------------------------------------------------------------------|---------------------|----------------------------------------------------------------------------------------------------------------|----------------|----------------|-------------------|---------------|---------------------------------------------------------------------------------------|--|
| Applicant: | Itronix Corporation | Model: | IX260PROA580BT | FCC ID: | KBCIX260PROA580BT | IC ID: | 1943A-IX260Pf | |
| Rugged Laptop PC with Cirronet BT2022 Bluetooth, Intel Pro 2200BG 802.11b/g WLAN, & Dual-Band CDMA | | | | | | |  | |
| 2005 Celltech Labs Inc | | This document is not to be reproduced in whole or in part without the written permission of Celltech Labs Inc. | | | | | 21 of 45 | |

| | | |
|--------------------------------|-----------------------------|--------------------|
| Test Report Serial No.: | 022305KBC-T618-E15B | Issue 1.0 |
| Test Date(s): | 21Sept04 - 14Oct04, 22Oct04 | |
| Test Type(s): | FCC §15.247 | IC RSS-210 Issue 5 |
| Lab Registration(s): | FCC #714830 | IC Lab File #3874 |

C.5. MEASUREMENT EQUIPMENT SETUP

| | |
|------------------------------------------|------------------------------------------------------------------------------------------------------------------------------------------------------------|
| Measurement Equipment Connections | The equipment was connected as shown in the setup drawing in C.6. |
| Measurement Equipment Settings | The power is measured within the band with the following spectrum analyzer settings: RBW – 100 kHz VBW – 1 MHz Detector – Peak Average – Power |

C.6. SETUP DRAWING

Figure C-1 - Setup Drawing

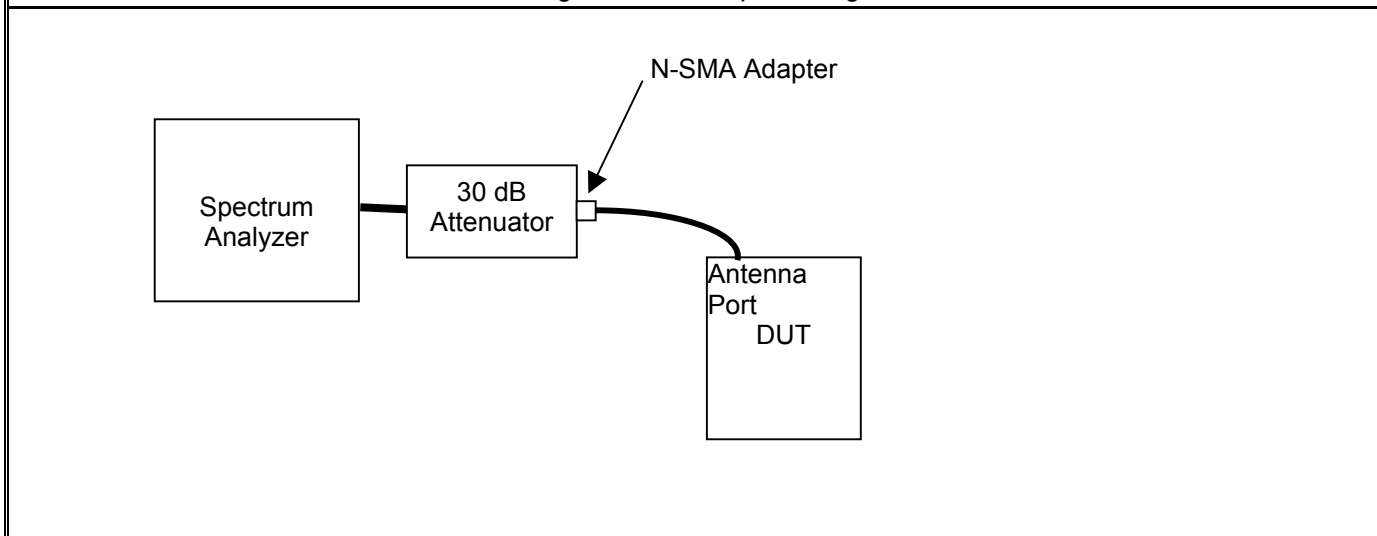

C.7. DUT OPERATING DESCRIPTION

The unmodulated carrier was set to each of the three frequencies representing the frequency band of operation.

| | | |
|--------------------------------|-----------------------------|--------------------|
| Test Report Serial No.: | 022305KBC-T618-E15B | Issue 1.0 |
| Test Date(s): | 21Sept04 - 14Oct04, 22Oct04 | |
| Test Type(s): | FCC §15.247 | IC RSS-210 Issue 5 |
| Lab Registration(s): | FCC #714830 | IC Lab File #3874 |

| C.8. TEST RESULTS | | | | |
|-------------------|-----------|----------------------|-------|-------|
| Channel | Frequency | Peak Conducted Power | | Limit |
| | | dBm | Watts | Watts |
| Low | 2402 | 15.40 | .0347 | 1 |
| Mid | 2441 | 15.61 | .0364 | 1 |
| High | 2480 | 15.34 | .0342 | 1 |

C.9. PASS/FAIL

In reference to the results outlined in C.8 the DUT passes the requirements as stated in the reference standards as follows:
 FCC 15.247 (b) (1): The peak power did not exceed 1 Watt.

C.10. SIGN-OFF

I attest to the accuracy of the data. All measurements reported herein were performed by me and are correct to the best of my knowledge and belief. I assume full responsibility for the completeness of these measurements.



Duane M. Friesen, C.E.T.
 EMC Manager
 Celltech Labs Inc.

14Oct04
 Date

| | | |
|--------------------------------|-----------------------------|--------------------|
| Test Report Serial No.: | 022305KBC-T618-E15B | Issue 1.0 |
| Test Date(s): | 21Sept04 - 14Oct04, 22Oct04 | |
| Test Type(s): | FCC §15.247 | IC RSS-210 Issue 5 |
| Lab Registration(s): | FCC #714830 | IC Lab File #3874 |

Appendix D - Adjacent Channel Separation

| D.1. REFERENCES | |
|-------------------------------------|---------------------------------------------------------------------------------------------------------------------------------------------------------------------------------------------------------------|
| Normative Reference Standard | FCC CFR 47 §15.247 (a) (1) |
| Test Reference | ACS Test Report: FCC Part 15 Certification Test Report - FCC ID: HSW-BT2022M 2.4 GHz Frequency Hopping Spread Spectrum (Modular Approval) ACS Report Number 03-0193-15BC Issue Date: January 5, 2004 |

| D.2. LIMITS |
|---------------------------------------------------------------------------------------------------------------------------------------------------------------------------------------------------|
| <i>§15.247(a) (1): Frequency hopping systems shall have hopping channel carrier frequencies separated by a minimum of 25 kHz or 20 dB bandwidth of the hopping channel, whichever is greater.</i> |

Note: The 20 dB bandwidth of the hopping channel is described to be 1 MHz as outlined in section 6.5.4 of the ACS report. Therefore the channel separation must be 1 MHz.

| D.3. TEST PROCEDURE & RESULTS |
|------------------------------------------------------------------------------------------------------------------------------------------------------------------------------------------------------------------------------------------|
| The test method used to show compliance to the applicable parts and the results obtained are outlined in the ACS reference test report number 03-0193-15BC section 6.5.1. A channel separation of 1.0 MHz was reported for all channels. |

| D.4. PASS/FAIL |
|-------------------------------------------------------------------------------------------------------------------------------------------|
| As stated in the ACS reference test report number 03-0193-15BC, the DUT complies with the applicable requirements of the referenced part. |

| | | |
|--------------------------------|-----------------------------|--------------------|
| Test Report Serial No.: | 022305KBC-T618-E15B | Issue 1.0 |
| Test Date(s): | 21Sept04 - 14Oct04, 22Oct04 | |
| Test Type(s): | FCC §15.247 | IC RSS-210 Issue 5 |
| Lab Registration(s): | FCC #714830 | IC Lab File #3874 |

Appendix E - Number of Hopping Channels

| E.1. REFERENCES | |
|-------------------------------------|---------------------------------------------------------------------------------------------------------------------------------------------------------------------------------------------------------------|
| Normative Reference Standard | FCC CFR 47 §15.247 (a) (1) (iii) |
| Test Reference | ACS Test Report: FCC Part 15 Certification Test Report - FCC ID: HSW-BT2022M 2.4 GHz Frequency Hopping Spread Spectrum (Modular Approval) ACS Report Number 03-0193-15BC Issue Date: January 5, 2004 |

| E.2. LIMITS |
|---------------------------------------------------------------------------------------------------------------------------------------|
| <i>§15.247 (a) (1) (iii): Frequency hopping systems in the 2400 – 2483.5 MHz band shall use at least 15 non-overlapping channels.</i> |

| E.3. TEST PROCEDURE & RESULTS |
|--------------------------------------------------------------------------------------------------------------------------------------------------------------------------------------------------------------------------------------------------------------------------------------------------------------------------------------------------------------------------------------------|
| The test method used to show compliance to the applicable parts and the results obtained are outlined in the ACS reference test report number 03-0193-15BC section 6.5.2 The results outlined in the reference test report show that the number of hopping channels is at least 75; which implies an applicable power limit of 1 watt be applied to the results outlined in Appendix C. |

| E.4. PASS/FAIL |
|-------------------------------------------------------------------------------------------------------------------------------------------|
| As stated in the ACS reference test report number 03-0193-15BC, the DUT complies with the applicable requirements of the referenced part. |

| | | |
|--------------------------------|-----------------------------|--------------------|
| Test Report Serial No.: | 022305KBC-T618-E15B | Issue 1.0 |
| Test Date(s): | 21Sept04 - 14Oct04, 22Oct04 | |
| Test Type(s): | FCC §15.247 | IC RSS-210 Issue 5 |
| Lab Registration(s): | FCC #714830 | IC Lab File #3874 |

Appendix F - Channel Dwell Time

| F.1. REFERENCES | |
|-------------------------------------|---------------------------------------------------------------------------------------------------------------------------------------------------------------------------------------------------------------|
| Normative Reference Standard | FCC CFR 47 §15.247 (a) (1), FCC CFR 47 §15.247 (a) (1) (iii) |
| Test Reference | ACS Test Report: FCC Part 15 Certification Test Report - FCC ID: HSW-BT2022M 2.4 GHz Frequency Hopping Spread Spectrum (Modular Approval) ACS Report Number 03-0193-15BC Issue Date: January 5, 2004 |

| F.2. LIMITS |
|----------------------------------------------------------------------------------------------------------------------------------------------------------------------------------------------------------------------------------------------------------------------------------------------------------------------------------------------------------------------------------------------------------------------------------------------------------|
| <p>§15.247 (a) (1):The system shall hop to channel frequencies that are selected at the hopping rate from a pseudorandomly ordered list of hopping frequencies. Each frequency must be used equally on the average by each transmitter.</p> <p>§15.247 (a) (1) (iii):The average time of occupancy on any channel shall be greater than 0.4 seconds within a period of 0.4 seconds multiplied by the number of hopping channels employed.</p> |

| F.3. TEST PROCEDURE & RESULTS |
|----------------------------------------------------------------------------------------------------------------------------------------------------------------------------------------------------------------------------------|
| The test method used to show compliance to the applicable parts and the results obtained are outlined in the ACS reference test report number 03-0193-15BC section 6.5.3. A channel dwell of 10 mS each 20 seconds was reported. |

| F.4. PASS/FAIL |
|-------------------------------------------------------------------------------------------------------------------------------------------|
| As stated in the ACS reference test report number 03-0193-15BC, the DUT complies with the applicable requirements of the referenced part. |

| | | | | | | | | |
|---------------------------------------------------------------------------------------------------------------|---------------------|----------------------------------------------------------------------------------------------------------------|----------------|----------------|-------------------|---------------|---------------------------------------------------------------------------------------|--|
| Applicant: | Itronix Corporation | Model: | IX260PROA580BT | FCC ID: | KBCIX260PROA580BT | IC ID: | 1943A-IX260Pf | |
| Rugged Laptop PC with Cirronet BT2022 Bluetooth, Intel Pro 2200BG 802.11b/g WLAN, & Dual-Band CDMA | | | | | | |  | |
| 2005 Celltech Labs Inc | | This document is not to be reproduced in whole or in part without the written permission of Celltech Labs Inc. | | | | | 26 of 45 | |

| | | |
|--------------------------------|-----------------------------|--------------------|
| Test Report Serial No.: | 022305KBC-T618-E15B | Issue 1.0 |
| Test Date(s): | 21Sept04 - 14Oct04, 22Oct04 | |
| Test Type(s): | FCC §15.247 | IC RSS-210 Issue 5 |
| Lab Registration(s): | FCC #714830 | IC Lab File #3874 |

Appendix G - 20 dB Bandwidth Measurement

| G.1. REFERENCES | |
|-------------------------------------|---------------------------------------------------------------------------------------------------------------------------------------------------------------------------------------------------------------|
| Normative Reference Standard | FCC CFR 47 §15.247 (a) (1) (iii) |
| Test Reference | ACS Test Report: FCC Part 15 Certification Test Report - FCC ID: HSW-BT2022M 2.4 GHz Frequency Hopping Spread Spectrum (Modular Approval) ACS Report Number 03-0193-15BC Issue Date: January 5, 2004 |

| G.2. LIMITS |
|--------------------------------------------------------------------------------------------------------------------------------------------------------------------------------------------------------------------------------------------------------------------------------------------------------------------------------------------------------------|
| <p>§15.247 (a) (1) (iii): <i>Frequency hopping systems in the 2400 – 2483.5 MHz band shall use at least 15 non-overlapping channels.</i></p> <p>Note: The channel width as referenced in the results outlined in Appendix C and D is 1 MHz, therefore to be non-overlapping, the 20 dB bandwidth must be no greater than 1 MHz for the system to comply.</p> |

| G.3. TEST PROCEDURE & RESULTS |
|--------------------------------------------------------------------------------------------------------------------------------------------------------------------------------------------------------------------------------|
| The test method used to show compliance to the applicable parts and the results obtained are outlined in the ACS reference test report number 03-0193-15BC section 6.5.4. A 20 dB bandwidth measurement of 1 MHz was reported. |

| G.4. PASS/FAIL |
|-------------------------------------------------------------------------------------------------------------------------------------------|
| As stated in the ACS reference test report number 03-0193-15BC, the DUT complies with the applicable requirements of the referenced part. |

| | | | | | | | | |
|---------------------------------------------------------------------------------------------------------------|---------------------|----------------------------------------------------------------------------------------------------------------|----------------|----------------|-------------------|---------------|---------------------------------------------------------------------------------------|--|
| Applicant: | Itronix Corporation | Model: | IX260PROA580BT | FCC ID: | KBCIX260PROA580BT | IC ID: | 1943A-IX260Pf | |
| Rugged Laptop PC with Cirronet BT2022 Bluetooth, Intel Pro 2200BG 802.11b/g WLAN, & Dual-Band CDMA | | | | | | |  | |
| 2005 Celltech Labs Inc | | This document is not to be reproduced in whole or in part without the written permission of Celltech Labs Inc. | | | | | 27 of 45 | |

| | | |
|--------------------------------|-----------------------------|--------------------|
| Test Report Serial No.: | 022305KBC-T618-E15B | Issue 1.0 |
| Test Date(s): | 21Sept04 - 14Oct04, 22Oct04 | |
| Test Type(s): | FCC §15.247 | IC RSS-210 Issue 5 |
| Lab Registration(s): | FCC #714830 | IC Lab File #3874 |

Appendix H - Radiated Spurious Emissions Measurement

| H.1. REFERENCES | |
|-------------------------------------|------------------------|
| Normative Reference Standard | FCC CFR 47 §15.247(c) |
| Procedure Reference | ANSI C63.4; FCC 97-114 |

| H.2. LIMITS | |
|--------------------------------------------------------------------------------------------------------------------------------------------------------------------------------------------------------------------------------------------------------------------------------------------------------------------------------------------------------------------------------------------------------------------------------------------------------------------------------------------------------------|--|
| H.2.1. FCC CFR 47 | |
| <p>§15.247 (c): In any 100 kHz bandwidth outside the frequency band in which the spread spectrum or digitally modulated intentional radiator is operating, the radio frequency power that is produced by the intentional radiator shall be at least 20 dB below that in the 100 kHz bandwidth within the band that contains the highest level of desired power, based on either an RF conducted or a radiated measurement. Attenuation below the general limits specified in 15.209 (a) is not required.</p> | |
| <p>Note: Spurious emissions within the restricted bands are reported in Appendix I.</p> | |
| <p>The maximum carrier field strength @ 3m was determined to be in the horizontal orientation with transmitter set for the mid channel (2441 MHz). The field strength in this configuration was 108.31 dBuV/m and was used as the limit reference. Therefore the calculated limit used was 88.31 dBuV/m (Limit (dBuV/m) = 108.31 (dBuV/m) – 20 dB) for the horizontal polarization and 83.21 dBuV/m (Limit (dBuV/m) = 103.21 (dBuV/m) – 20 dB) for vertical.</p> | |

| H.3. ENVIRONMENTAL CONDITIONS | |
|-------------------------------|-------------------|
| Temperature | 27.4 +/- 2 °C |
| Humidity | 33 +/- 2 % |
| Barometric Pressure | 96.24 +/- 0.2 kPa |

| H.4. EQUIPMENT LIST | | | | | |
|---------------------|--------------|---------|------------------------------|----------|---------|
| ASSET NUMBER | MANUFACTURER | MODEL | DESCRIPTION | LAST CAL | CAL DUE |
| 00072 | EMCO | 2075 | Mini-mast | n/a | n/a |
| 00073 | EMCO | 2080 | Turn Table | n/a | n/a |
| 00071 | EMCO | 2090 | Multi-Device Controller | n/a | n/a |
| 00035 | ETS | 3115 | Double Ridged Guide Horn | 24Mar04 | 24Mar05 |
| 00202 | ETS | 3160-09 | Small Horn Antenna | 27May04 | 27Jun05 |
| 00015 | Agilent | E4408B | Spectrum Analyzer | 29Dec03 | 29Dec04 |
| 00049 | HP | 8566B | Spectrum Analyzer RF Section | 18May04 | 18May05 |
| 00048 | Gore | 65474 | Microwave Cable | 20May04 | 20May05 |
| 00030 | HP | 83017A | LNA | 20May04 | 20May05 |

| | | | | | | | | |
|----------------------------------------------------------------------------------------------------|---------------------|----------------------------------------------------------------------------------------------------------------|----------------|----------------|-------------------|---------------|---------------------------------------------------------------------------------------|--|
| Applicant: | Itronix Corporation | Model: | IX260PROA580BT | FCC ID: | KBCIX260PROA580BT | IC ID: | 1943A-IX260PF | |
| Rugged Laptop PC with Cirronet BT2022 Bluetooth, Intel Pro 2200BG 802.11b/g WLAN, & Dual-Band CDMA | | | | | | |  | |
| 2005 Celltech Labs Inc | | This document is not to be reproduced in whole or in part without the written permission of Celltech Labs Inc. | | | | | 28 of 45 | |

| | | |
|--------------------------------|-----------------------------|--------------------|
| Test Report Serial No.: | 022305KBC-T618-E15B | Issue 1.0 |
| Test Date(s): | 21Sept04 - 14Oct04, 22Oct04 | |
| Test Type(s): | FCC §15.247 | IC RSS-210 Issue 5 |
| Lab Registration(s): | FCC #714830 | IC Lab File #3874 |

| H.5. MEASUREMENT EQUIPMENT SETUP | | | | |
|-------------------------------------------------------------------------------------------------------------------------------------------------------------------------------------------------------------------------------------------------------------------------------------------|-------------------------------------------------------------------------------------------------------------------------------------------------------------------------------------------------|-------------------|------|-------------------|
| MEASUREMENT EQUIPMENT CONNECTIONS | The measurement equipment was connected as shown in H.6. A number of antennas were used to cover the applicable frequency range test. The ranges in which each antenna was used are as follows: | | | |
| | Frequency Range | Antenna | | |
| | 1 GHz – 18 GHz | ETS 3115 Horn | | |
| | 18 GHz– 26GHz | ETS 3160-09 Horn | | |
| MEASUREMENT EQUIPMENT SETTINGS | The spectrum analyzer was set to the following settings: | | | |
| | Frequency Range | RBW | VBW | Detector |
| | MHz | kHz | kHz | |
| | > 1000 | 1000 ¹ | 1000 | Peak ² |
| Note 1: As a worse case measurement, when suitable margin could be realized, the applicable limit was applied to measurements made with a peak detector using a 1 MHz RBW. When an average measurement was reported, it was made with 100 kHz RBW using video average with a VBW of 1 Hz. | | | | |

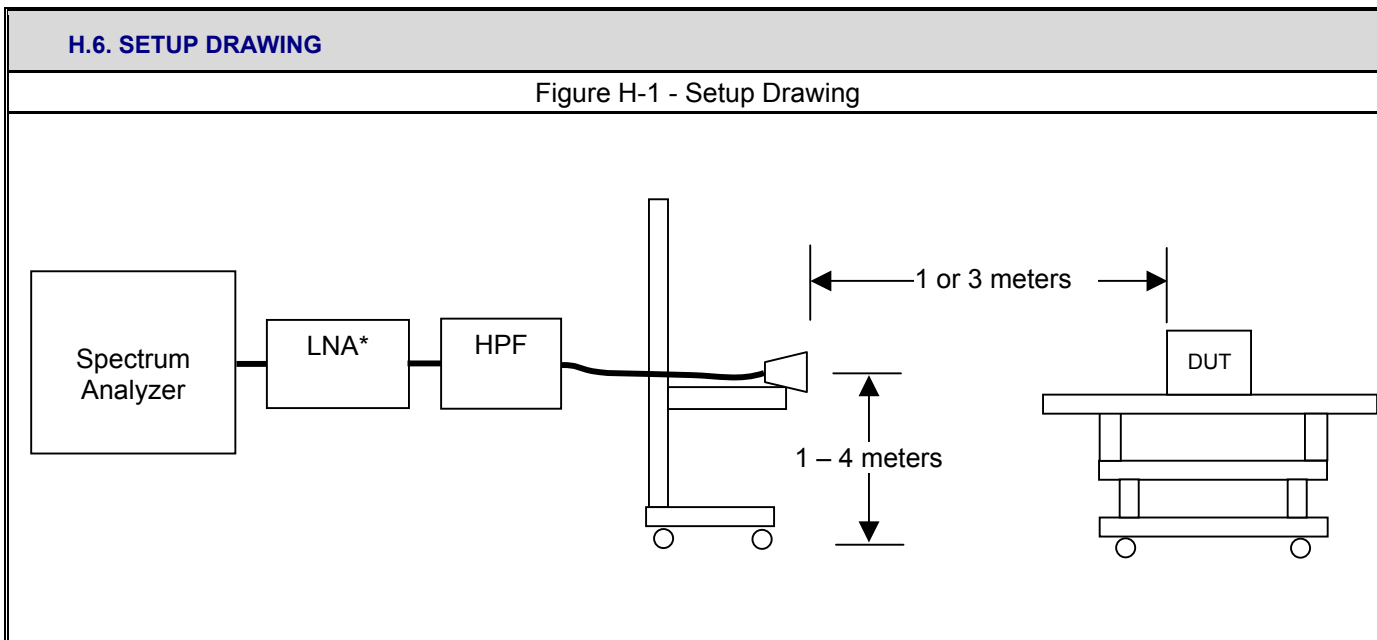

| | | |
|--------------------------------|-----------------------------|--------------------|
| Test Report Serial No.: | 022305KBC-T618-E15B | Issue 1.0 |
| Test Date(s): | 21Sept04 - 14Oct04, 22Oct04 | |
| Test Type(s): | FCC §15.247 | IC RSS-210 Issue 5 |
| Lab Registration(s): | FCC #714830 | IC Lab File #3874 |

H.7. SETUP PHOTOGRAPHS

Photograph H-1 - 3115 Horn Antenna (1-18GHz)



Photograph H-2 - 3160-09 Horn Antenna (18-26GHz)



H.8. DUT OPERATING DESCRIPTION

Measurements were made at three channels throughout the band, Low Channel (2402 MHz), Mid Channel (2441 MHz), High Channel (2480 MHz). The configuration used was with a gain setting of 250/40 for the low channel, 250/44 for mid channel and 220/45 for the high channel. The modulation was set to 1000. As a worst case, the band-edge measurements were made of the low and high channels with data stream modulation.

| | | | | | | | | |
|---------------------------------------------------------------------------------------------------------------|----------------------------|----------------------------------------------------------------------------------------------------------------|-----------------------|----------------|--------------------------|---------------|---------------------------------------------------------------------------------------|--|
| Applicant: | Itronix Corporation | Model: | IX260PROA580BT | FCC ID: | KBCIX260PROA580BT | IC ID: | 1943A-IX260Pf | |
| Rugged Laptop PC with Cirronet BT2022 Bluetooth, Intel Pro 2200BG 802.11b/g WLAN, & Dual-Band CDMA | | | | | | |  | |
| 2005 Celltech Labs Inc | | This document is not to be reproduced in whole or in part without the written permission of Celltech Labs Inc. | | | | | 30 of 45 | |

| | | |
|--------------------------------|-----------------------------|--------------------|
| Test Report Serial No.: | 022305KBC-T618-E15B | Issue 1.0 |
| Test Date(s): | 21Sept04 - 14Oct04, 22Oct04 | |
| Test Type(s): | FCC §15.247 | IC RSS-210 Issue 5 |
| Lab Registration(s): | FCC #714830 | IC Lab File #3874 |

H.9. TEST RESULTS

H.9.1. Lower Band-edge Emission Field Strengths @ Specified Distance

Note: (Upper Band-edge (Restricted) is in Appendix I)

Channel 0 - Conducted Band-edge Plots

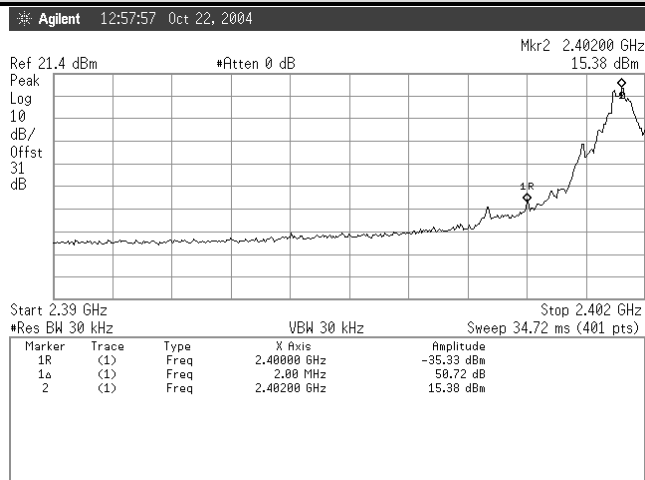

Channel 0 - Radiated Carrier Field Strengths

| Polarity | Distance m | Rx Antenna | Channel | Frequency | SA Level | Rx AF | Rx CL | Other Rx | Total Rx CF | Field Strength | Detector |
|----------|---------------|-------------|---------|-----------|----------|-------|-------|----------|-------------|--------------------|----------|
| | | | | MHz | dBuV | dB/m | dB | dB | dB/m | dBuV/m (PK/QP/AVG) | |
| H | 3 | Horn SN6276 | 0 | 2402.00 | 83.90 | 30.24 | 3.48 | 0.00 | 33.72 | 117.62 | PK |
| H | 3 | Horn SN6276 | 0 | 2402.00 | 42.30 | 30.24 | 3.48 | 0.00 | 33.72 | 76.02 | AV |
| V | 3 | Horn SN6276 | 0 | 2402.00 | 75.50 | 30.24 | 3.48 | 0.00 | 33.72 | 109.22 | PK |
| V | 3 | Horn SN6276 | 0 | 2402.00 | 38.70 | 30.24 | 3.48 | 0.00 | 33.72 | 72.42 | AV |

Channel 0 - Calculated Band-edge (Out-of-Band) Field Strengths

| Polarity | Distance m | Rx Antenna | Channel | Frequency | Carrier Radiated Field Strength | Detector | Marker-Delta | Calculated Bandedge Field Strength | Limit Distance | Limit Distance Correction | Calculated Limit | Margin | Pass/Fail |
|----------|---------------|-------------|---------|-----------|---------------------------------|----------|--------------|------------------------------------|----------------|---------------------------|------------------|--------|-----------|
| | | | | MHz | dBuV/m | | dB | dBuV/m | m | dB | dBuV/m | dB | |
| H | 3 | Horn SN6276 | 0 | 2400.0 | 117.62 | PK | 50.72 | 66.9 | 3 | 0 | 97.62 | 30.72 | Pass |
| H | 3 | Horn SN6276 | 0 | 2400.0 | 76.02 | AV | 50.72 | 25.3 | 3 | 0 | 56.02 | 30.72 | Pass |
| V | 3 | Horn SN6276 | 0 | 2400.0 | 109.22 | PK | 50.72 | 58.5 | 3 | 0 | 97.62 | 39.12 | Pass |
| V | 3 | Horn SN6276 | 0 | 2400.0 | 72.42 | AV | 50.72 | 21.7 | 3 | 0 | 56.02 | 34.32 | Pass |

Formulae:

Total CF (dB) = Antenna Factor (dB) + Cable Factor (dB) + Other Factor (Amplifier Gain, Filter Loss, etc) (dB)

Field Strength (dBuV/m) = SA Reading (dBuV) + Total CF (dB/m)

Limit Distance Correction (dB) = 40 * log(d1/d2) for f < 30 MHz, 20*log(d1/d2) for f > 30 MHz; where d1 is the measurement distance and d2 is the published limit

Limit (dBuV/m) = Published Limit (dBuV/m) + Limit Distance Correction (dB)

Margin (dB) = Limit (dBuV/m) - Field Strength (dBuV/m)

Note: Measurements and calculation reference the Marker-Delta Method Described in FCC Public Notice DA 00-705

| | | | | | | | | |
|---------------------------------------------------------------------------------------------------------------|---------------------|----------------------------------------------------------------------------------------------------------------|----------------|----------------|-------------------|---------------|---------------|--|
| Applicant: | Itronix Corporation | Model: | IX260PROA580BT | FCC ID: | KBCIX260PROA580BT | IC ID: | 1943A-IX260PF | |
| Rugged Laptop PC with Cirronet BT2022 Bluetooth, Intel Pro 2200BG 802.11b/g WLAN, & Dual-Band CDMA | | | | | | | | |
| 2005 Celltech Labs Inc | | This document is not to be reproduced in whole or in part without the written permission of Celltech Labs Inc. | | | | | 31 of 45 | |

| | | |
|-------------------------|-----------------------------|--------------------|
| Test Report Serial No.: | 022305KBC-T618-E15B | Issue 1.0 |
| Test Date(s): | 21Sept04 - 14Oct04, 22Oct04 | |
| Test Type(s): | FCC §15.247 | IC RSS-210 Issue 5 |
| Lab Registration(s): | FCC #714830 | IC Lab File #3874 |

H.9.2. Spurious Emission Field Strengths @ Specified Distance

Company: 072804KBC-T543-E15B
 Product: Itronix
 IX260+ with Bluetooth

Standard: FCC15.247c
 Test Start Date: 21Sep04
 Test End Date: 12Oct04

| IX260+ with Bluetooth | | | | | | | | | | | | | | | | | | |
|-----------------------|----------|----------|-------------|-----------|----------|-------------|-------|-------|----------|------------------------|-------------|----------------|------------|----------------|---------------------------|------------------|--------|-----------|
| Channel | Polarity | Distance | Rx Antenna | Frequency | SA Level | Noise Floor | Rx AF | Rx CL | Other Rx | *Duty Cycle Correction | Total Rx CF | Field Strength | Detector | Limit Distance | Limit Distance Correction | Calculated Limit | Margin | Pass/Fail |
| | | m | | MHz | dBuV | | dB/m | dB | dB | dB | dB/m | dBuV/m | (PK/QP/AV) | m | dB | dBuV/m | dB | |
| BT-Low | H | 3 | Horn SN6276 | 2000.00 | 14.40 | x | 29.60 | 3.18 | 0.00 | -20.00 | 12.78 | 27.18 | PK | 3.00 | 0.00 | 88.31 | 61.13 | PASS |
| BT-Low | H | 3 | Horn SN6276 | 7206.72 | 52.40 | | 38.17 | 6.21 | -34.32 | -20.00 | -9.94 | 42.46 | PK | 3.00 | 0.00 | 88.31 | 45.85 | PASS |
| BT-Low | H | 1 | Horn SN6276 | 17986.00 | 44.90 | | 45.86 | 10.43 | -32.01 | -20.00 | 4.28 | 49.18 | PK | 3.00 | 9.54 | 97.85 | 48.68 | PASS |
| BT-Low | V | 3 | Horn SN6276 | 2000.00 | 17.00 | x | 29.60 | 3.18 | 0.00 | -20.00 | 12.78 | 29.78 | PK | 3.00 | 0.00 | 83.21 | 53.43 | PASS |
| BT-Low | V | 3 | Horn SN6276 | 4804.58 | 52.70 | | 35.31 | 4.96 | -34.08 | -20.00 | -13.81 | 38.89 | PK | 3.00 | 0.00 | 83.21 | 44.32 | PASS |
| BT-Low | V | 3 | Horn SN6276 | 4804.46 | 50.80 | | 35.31 | 4.96 | -34.08 | -20.00 | -13.81 | 36.99 | PK | 3.00 | 0.00 | 83.21 | 46.22 | PASS |
| BT-Low | V | 3 | Horn SN6276 | 7207.22 | 57.30 | | 38.17 | 6.21 | -34.32 | -20.00 | -9.93 | 47.37 | PK | 3.00 | 0.00 | 83.21 | 35.85 | PASS |
| BT-Low | V | 1 | Horn SN6276 | 17874.00 | 44.50 | | 45.52 | 10.28 | -32.09 | -20.00 | 3.71 | 48.21 | PK | 3.00 | 9.54 | 92.75 | 44.54 | PASS |
| BT-Mid | H | 3 | Horn SN6276 | 2000.00 | 14.40 | x | 29.60 | 3.18 | 0.00 | -20.00 | 12.78 | 27.18 | PK | 3.00 | 0.00 | 88.31 | 61.13 | PASS |
| BT-Mid | H | 3 | Horn SN6276 | 4882.41 | 55.90 | | 35.46 | 5.04 | -34.09 | -20.00 | -13.59 | 42.31 | PK | 3.00 | 0.00 | 88.31 | 46.00 | PASS |
| BT-Mid | H | 3 | Horn SN6276 | 7323.65 | 50.00 | | 38.38 | 6.32 | -34.32 | -20.00 | -9.62 | 40.38 | PK | 3.00 | 0.00 | 88.31 | 47.93 | PASS |
| BT-Mid | H | 1 | Horn SN6276 | 17982.00 | 44.50 | | 45.88 | 10.45 | -32.01 | -20.00 | 4.32 | 48.82 | PK | 3.00 | 9.54 | 97.85 | 49.03 | PASS |
| BT-Mid | V | 3 | Horn SN6276 | 2000.00 | 17.00 | x | 29.60 | 3.18 | 0.00 | -20.00 | 12.78 | 29.78 | PK | 3.00 | 0.00 | 83.21 | 53.43 | PASS |
| BT-Mid | V | 3 | Horn SN6276 | 4882.23 | 49.80 | | 35.46 | 5.04 | -34.09 | -20.00 | -13.59 | 36.21 | PK | 3.00 | 0.00 | 83.21 | 47.00 | PASS |
| BT-Mid | V | 3 | Horn SN6276 | 7323.74 | 55.80 | | 38.38 | 6.32 | -34.32 | -20.00 | -9.62 | 46.18 | PK | 3.00 | 0.00 | 83.21 | 37.03 | PASS |
| BT-Mid | V | 3 | Horn SN6276 | 9764.87 | 49.40 | | 40.30 | 7.41 | -34.25 | -20.00 | -6.54 | 42.86 | PK | 3.00 | 0.00 | 83.21 | 40.35 | PASS |
| BT-Mid | V | 1 | Horn SN6276 | 18000.00 | 43.90 | | 45.90 | 10.48 | -32.00 | -20.00 | 4.38 | 48.28 | PK | 3.00 | 9.54 | 92.75 | 44.47 | PASS |
| BT-High | H | 3 | Horn SN6276 | 2000.00 | 14.40 | x | 29.60 | 3.18 | 0.00 | -20.00 | 12.78 | 27.18 | PK | 3.00 | 0.00 | 88.31 | 61.13 | PASS |
| BT-High | H | 3 | Horn SN6276 | 4960.48 | 52.20 | | 35.62 | 5.06 | -34.10 | -20.00 | -13.42 | 38.78 | PK | 3.00 | 0.00 | 88.31 | 49.53 | PASS |
| BT-High | H | 1 | Horn SN6276 | 17862.00 | 44.70 | | 45.49 | 10.28 | -32.10 | -20.00 | 3.67 | 48.37 | PK | 3.00 | 9.54 | 97.85 | 49.49 | PASS |
| BT-High | V | 3 | Horn SN6276 | 2000.00 | 17.00 | x | 29.60 | 3.18 | 0.00 | -20.00 | 12.78 | 29.78 | PK | 3.00 | 0.00 | 83.21 | 53.43 | PASS |
| BT-High | V | 3 | Horn SN6276 | 4960.39 | 50.80 | | 35.62 | 5.06 | -34.10 | -20.00 | -13.42 | 37.38 | PK | 3.00 | 0.00 | 83.21 | 45.83 | PASS |
| BT-High | V | 3 | Horn SN6276 | 7440.88 | 49.80 | | 38.59 | 6.43 | -34.32 | -20.00 | -9.29 | 40.51 | PK | 3.00 | 0.00 | 83.21 | 42.70 | PASS |
| BT-High | V | 1 | Horn SN6276 | 17936.00 | 44.70 | | 45.71 | 10.28 | -32.04 | -20.00 | 3.94 | 48.64 | PK | 3.00 | 9.54 | 92.75 | 44.11 | PASS |

Formulae:

Total CF (dB) = Antenna Factor (dB)+ Cable Factor (dB) + Other Factor (Amplifier Gain, Filter Loss, etc) (dB)
 Field Strength (dBuV/m) = SA Reading (dBuV) + Total CF (dB/m)
 Limit Distance Correction (dB) = 40 * log(d1/d2) for f < 30 MHz, 20*log(d1/d2) for f > 30 MHz; where d1 is the measurement distance and d2 is the published limit distance
 Limit (dBuV/m) = Published Limit (dBuV/m) + Limit Distance Correction (dB)
 Margin (dB) = Limit (dBuV/m) - Field Strength (dBuV/m)
 Duty Cycle Correction (dB) = 20 * log (duty cycle ratio*)
 Duty Cycle ratio = maximum time on in any 100 mS period (in mS) / 100 mS

*DUT duty cycle = 10 mS in each 10 seconds

***The frequency points reported, describe the highest emission measured in each of the ranges tested and are used to describe the measured spectrum as a whole. Emissions that may be present in the restricted bands are evaluated against the appropriate limits in Appendix I. No out-of-band emissions were measured above the levels noted.**

| | | | | | | | | |
|----------------------------------------------------------------------------------------------------|---------------------|----------------------------------------------------------------------------------------------------------------|----------------|---------|-------------------|--------|---------------|--|
| Applicant: | Itronix Corporation | Model: | IX260PROA580BT | FCC ID: | KBCIX260PROA580BT | IC ID: | 1943A-IX260PF | |
| Rugged Laptop PC with Cirronet BT2022 Bluetooth, Intel Pro 2200BG 802.11b/g WLAN, & Dual-Band CDMA | | | | | | | | |
| 2005 Celltech Labs Inc | | This document is not to be reproduced in whole or in part without the written permission of Celltech Labs Inc. | | | | | 32 of 45 | |

| | | |
|--------------------------------|-----------------------------|--------------------|
| Test Report Serial No.: | 022305KBC-T618-E15B | Issue 1.0 |
| Test Date(s): | 21Sept04 - 14Oct04, 22Oct04 | |
| Test Type(s): | FCC §15.247 | IC RSS-210 Issue 5 |
| Lab Registration(s): | FCC #714830 | IC Lab File #3874 |

H.10. PASS/FAIL

In reference to the results outlined in H.9, the DUT passes the requirements as stated in the reference standards as follows:
 FCC 15.247 (c): All emissions within any 100 kHz bandwidth outside the operating frequency band are greater than 20 dB below the maximum 100 kHz bandwidth signal within the operating band.

H.11. SIGN-OFF

I attest to the accuracy of the data. All measurements reported herein were performed by me and are correct to the best of my knowledge and belief. I assume full responsibility for the completeness of these measurements.



Russell Pipe
 Senior Compliance Technologist
 Celltech Labs Inc.

22Oct04

Date

| | | | | | | | | |
|---------------------------------------------------------------------------------------------------------------|---------------------|----------------------------------------------------------------------------------------------------------------|----------------|----------------|-------------------|---------------|---------------------------------------------------------------------------------------|--|
| Applicant: | Itronix Corporation | Model: | IX260PROA580BT | FCC ID: | KBCIX260PROA580BT | IC ID: | 1943A-IX260Pf | |
| Rugged Laptop PC with Cirronet BT2022 Bluetooth, Intel Pro 2200BG 802.11b/g WLAN, & Dual-Band CDMA | | | | | | |  | |
| 2005 Celltech Labs Inc | | This document is not to be reproduced in whole or in part without the written permission of Celltech Labs Inc. | | | | | 33 of 45 | |

| | | |
|-------------------------|-----------------------------|--------------------|
| Test Report Serial No.: | 022305KBC-T618-E15B | Issue 1.0 |
| Test Date(s): | 21Sept04 - 14Oct04, 22Oct04 | |
| Test Type(s): | FCC §15.247 | IC RSS-210 Issue 5 |
| Lab Registration(s): | FCC #714830 | IC Lab File #3874 |

Appendix I - Restricted Band Emissions Measurement

| I.1. REFERENCES | |
|------------------------------|----------------------------------------------------|
| Normative Reference Standard | FCC CFR 47 §15.205 (a) (b), FCC CFR 47 §15.209 (a) |
| Procedure Reference | FCC 97-114 |

| I.2. LIMITS | | | | | | | | | | | | | | | | | | | | | | | | | | | | | | | | | | | | | | | | | | | | | | | | | | | | | | | | | | | | | | | | | | | | | | | | | |
|--------------------------|---------------------------------------------------------------------------------------------------------------------------------------------------------------------------------------------------------------------------------------------------------------------------------------------------------------------------------------------------------------------------------------------------------------------------------------------------------------------------------------------------------------------------------------------------------------------------------------------------------------------------------------------------------------------------------------------------------------------------------------------------------------------------------------------------------------------------------------------------------------------------------------------------------------------------------------------------------------------------------------------------------------------------------------------------------------------------------------------------------------------------------------------------------------------------------------------------------------------------------------------------------------------------------------------------------------------------------------------------------------------------------------------------------------------------------------------------------------------------------------------------------------------------------------------------------------------------------------------------------------------------------------------------------------------------------------------------------------------------------------------------------------------------------------------------------------------------|----------------------|------------------|----------------------|-----|-------------|--------------|--------------|-------------|--------------------------|-------------------|--------------|-----------|---------------|-------------------|----------|-----------|-------------|------------|-----------|-----------|-----------------|------------|-------------|---------|-----------------|---------|---------------|---------|-------------|-----------|-----------|-----------|-----------------|------------|---------------|------------|-----------------|---------|-----------|------------|-------------|--------------|-----------|------------|-------------|---------------------|-------------|-----------|-----------------|-------------|-----------|-------------|-----------------|-----------------|-----------|-----------|--------------|--------------|-----------|-----------|-------------------|---------|-------------|------------|-------------------|-----------|-----------|------------------|-------------|--|--|--|
| FCC CFR 47 §15.205 | (a) Except as shown in paragraph (d) of this section, only spurious emissions are permitted in any of the frequency bands listed below: | | | | | | | | | | | | | | | | | | | | | | | | | | | | | | | | | | | | | | | | | | | | | | | | | | | | | | | | | | | | | | | | | | | | | | | | |
| | <table border="1"> <thead> <tr> <th>MHz</th> <th>MHz</th> <th>MHz</th> <th>GHz</th> </tr> </thead> <tbody> <tr><td>0.090-0.110</td><td>16.42-16.423</td><td>399.9-410</td><td>4.5-5.15</td></tr> <tr><td>¹0.495-0.505</td><td>16.69475-16.69525</td><td>608-614</td><td>5.35-5.46</td></tr> <tr><td>2.1735-2.1905</td><td>16.80425-16.80475</td><td>960-1240</td><td>7.25-7.75</td></tr> <tr><td>4.125-4.128</td><td>25.5-25.67</td><td>1300-1427</td><td>8.025-8.5</td></tr> <tr><td>4.17725-4.17775</td><td>37.5-38.25</td><td>1435-1626.5</td><td>9.0-9.2</td></tr> <tr><td>4.20725-4.20775</td><td>73-74.6</td><td>1645.5-1646.5</td><td>9.3-9.5</td></tr> <tr><td>6.215-6.218</td><td>74.8-75.2</td><td>1660-1710</td><td>10.6-12.7</td></tr> <tr><td>6.26775-6.26825</td><td>108-121.94</td><td>1718.8-1722.2</td><td>13.25-13.4</td></tr> <tr><td>6.31175-6.31225</td><td>123-138</td><td>2200-2300</td><td>14.47-14.5</td></tr> <tr><td>8.291-8.294</td><td>149.9-150.05</td><td>2310-2390</td><td>15.35-16.2</td></tr> <tr><td>8.362-8.366</td><td>156.52475-156.52525</td><td>2483.5-2500</td><td>17.7-21.4</td></tr> <tr><td>8.37625-8.38675</td><td>156.7-156.9</td><td>2655-2900</td><td>22.01-23.12</td></tr> <tr><td>8.41425-8.41475</td><td>162.0125-167.17</td><td>3260-3267</td><td>23.6-24.0</td></tr> <tr><td>12.29-12.293</td><td>167.72-173.2</td><td>3332-3339</td><td>31.2-31.8</td></tr> <tr><td>12.51975-12.52025</td><td>240-285</td><td>3345.8-3358</td><td>36.43-36.5</td></tr> <tr><td>12.57675-12.57725</td><td>322-335.4</td><td>3600-4400</td><td>(²)</td></tr> <tr><td>13.36-13.41</td><td></td><td></td><td></td></tr> </tbody> </table> <p>¹ Until February 1, 1999, this restricted band shall be 0.490-0.510 MHz. ² Above 38.6</p> | MHz | MHz | MHz | GHz | 0.090-0.110 | 16.42-16.423 | 399.9-410 | 4.5-5.15 | ¹ 0.495-0.505 | 16.69475-16.69525 | 608-614 | 5.35-5.46 | 2.1735-2.1905 | 16.80425-16.80475 | 960-1240 | 7.25-7.75 | 4.125-4.128 | 25.5-25.67 | 1300-1427 | 8.025-8.5 | 4.17725-4.17775 | 37.5-38.25 | 1435-1626.5 | 9.0-9.2 | 4.20725-4.20775 | 73-74.6 | 1645.5-1646.5 | 9.3-9.5 | 6.215-6.218 | 74.8-75.2 | 1660-1710 | 10.6-12.7 | 6.26775-6.26825 | 108-121.94 | 1718.8-1722.2 | 13.25-13.4 | 6.31175-6.31225 | 123-138 | 2200-2300 | 14.47-14.5 | 8.291-8.294 | 149.9-150.05 | 2310-2390 | 15.35-16.2 | 8.362-8.366 | 156.52475-156.52525 | 2483.5-2500 | 17.7-21.4 | 8.37625-8.38675 | 156.7-156.9 | 2655-2900 | 22.01-23.12 | 8.41425-8.41475 | 162.0125-167.17 | 3260-3267 | 23.6-24.0 | 12.29-12.293 | 167.72-173.2 | 3332-3339 | 31.2-31.8 | 12.51975-12.52025 | 240-285 | 3345.8-3358 | 36.43-36.5 | 12.57675-12.57725 | 322-335.4 | 3600-4400 | (²) | 13.36-13.41 | | | |
| MHz | MHz | MHz | GHz | | | | | | | | | | | | | | | | | | | | | | | | | | | | | | | | | | | | | | | | | | | | | | | | | | | | | | | | | | | | | | | | | | | | | | |
| 0.090-0.110 | 16.42-16.423 | 399.9-410 | 4.5-5.15 | | | | | | | | | | | | | | | | | | | | | | | | | | | | | | | | | | | | | | | | | | | | | | | | | | | | | | | | | | | | | | | | | | | | | | |
| ¹ 0.495-0.505 | 16.69475-16.69525 | 608-614 | 5.35-5.46 | | | | | | | | | | | | | | | | | | | | | | | | | | | | | | | | | | | | | | | | | | | | | | | | | | | | | | | | | | | | | | | | | | | | | | |
| 2.1735-2.1905 | 16.80425-16.80475 | 960-1240 | 7.25-7.75 | | | | | | | | | | | | | | | | | | | | | | | | | | | | | | | | | | | | | | | | | | | | | | | | | | | | | | | | | | | | | | | | | | | | | | |
| 4.125-4.128 | 25.5-25.67 | 1300-1427 | 8.025-8.5 | | | | | | | | | | | | | | | | | | | | | | | | | | | | | | | | | | | | | | | | | | | | | | | | | | | | | | | | | | | | | | | | | | | | | | |
| 4.17725-4.17775 | 37.5-38.25 | 1435-1626.5 | 9.0-9.2 | | | | | | | | | | | | | | | | | | | | | | | | | | | | | | | | | | | | | | | | | | | | | | | | | | | | | | | | | | | | | | | | | | | | | | |
| 4.20725-4.20775 | 73-74.6 | 1645.5-1646.5 | 9.3-9.5 | | | | | | | | | | | | | | | | | | | | | | | | | | | | | | | | | | | | | | | | | | | | | | | | | | | | | | | | | | | | | | | | | | | | | | |
| 6.215-6.218 | 74.8-75.2 | 1660-1710 | 10.6-12.7 | | | | | | | | | | | | | | | | | | | | | | | | | | | | | | | | | | | | | | | | | | | | | | | | | | | | | | | | | | | | | | | | | | | | | | |
| 6.26775-6.26825 | 108-121.94 | 1718.8-1722.2 | 13.25-13.4 | | | | | | | | | | | | | | | | | | | | | | | | | | | | | | | | | | | | | | | | | | | | | | | | | | | | | | | | | | | | | | | | | | | | | | |
| 6.31175-6.31225 | 123-138 | 2200-2300 | 14.47-14.5 | | | | | | | | | | | | | | | | | | | | | | | | | | | | | | | | | | | | | | | | | | | | | | | | | | | | | | | | | | | | | | | | | | | | | | |
| 8.291-8.294 | 149.9-150.05 | 2310-2390 | 15.35-16.2 | | | | | | | | | | | | | | | | | | | | | | | | | | | | | | | | | | | | | | | | | | | | | | | | | | | | | | | | | | | | | | | | | | | | | | |
| 8.362-8.366 | 156.52475-156.52525 | 2483.5-2500 | 17.7-21.4 | | | | | | | | | | | | | | | | | | | | | | | | | | | | | | | | | | | | | | | | | | | | | | | | | | | | | | | | | | | | | | | | | | | | | | |
| 8.37625-8.38675 | 156.7-156.9 | 2655-2900 | 22.01-23.12 | | | | | | | | | | | | | | | | | | | | | | | | | | | | | | | | | | | | | | | | | | | | | | | | | | | | | | | | | | | | | | | | | | | | | | |
| 8.41425-8.41475 | 162.0125-167.17 | 3260-3267 | 23.6-24.0 | | | | | | | | | | | | | | | | | | | | | | | | | | | | | | | | | | | | | | | | | | | | | | | | | | | | | | | | | | | | | | | | | | | | | | |
| 12.29-12.293 | 167.72-173.2 | 3332-3339 | 31.2-31.8 | | | | | | | | | | | | | | | | | | | | | | | | | | | | | | | | | | | | | | | | | | | | | | | | | | | | | | | | | | | | | | | | | | | | | | |
| 12.51975-12.52025 | 240-285 | 3345.8-3358 | 36.43-36.5 | | | | | | | | | | | | | | | | | | | | | | | | | | | | | | | | | | | | | | | | | | | | | | | | | | | | | | | | | | | | | | | | | | | | | | |
| 12.57675-12.57725 | 322-335.4 | 3600-4400 | (²) | | | | | | | | | | | | | | | | | | | | | | | | | | | | | | | | | | | | | | | | | | | | | | | | | | | | | | | | | | | | | | | | | | | | | | |
| 13.36-13.41 | | | | | | | | | | | | | | | | | | | | | | | | | | | | | | | | | | | | | | | | | | | | | | | | | | | | | | | | | | | | | | | | | | | | | | | | | |
| | (b) Except as provided in paragraphs (d) and (e), the field strength of emissions appearing within these frequency bands shall not exceed the limits shown in 15.209. At frequencies equal to or less than 1000 MHz, compliance with the limits in Section 15.209 shall be demonstrated using measurement instrumentation employing a CISPR quasi-peak detector. Above 1000 MHz, compliance with the emission limits in Section 15.209 shall be demonstrated based on the average value of the measured emissions. The provisions of 15.35 apply to these measurements. | | | | | | | | | | | | | | | | | | | | | | | | | | | | | | | | | | | | | | | | | | | | | | | | | | | | | | | | | | | | | | | | | | | | | | | | |
| FCC CFR 47 §15.209 | (a) Except as provided elsewhere in this Subpart, the emissions from an intentional radiator shall not exceed the field strength levels specified in the following table: | | | | | | | | | | | | | | | | | | | | | | | | | | | | | | | | | | | | | | | | | | | | | | | | | | | | | | | | | | | | | | | | | | | | | | | | |
| | <table border="1"> <thead> <tr> <th>Frequency</th> <th>Field Strength</th> <th>Measurement Distance</th> </tr> <tr> <th>MHz</th> <th>uV/m</th> <th>Meters</th> </tr> </thead> <tbody> <tr><td>.009 - 0.490</td><td>2400/F(kHz)</td><td>300</td></tr> <tr><td>0.490 - 1.705</td><td>24000/F(kHz)</td><td>30</td></tr> <tr><td>1.705 - 30.0</td><td>30</td><td>30</td></tr> <tr><td>30 - 88</td><td>100</td><td>3</td></tr> <tr><td>88 - 216</td><td>150</td><td>3</td></tr> <tr><td>216 - 960</td><td>200</td><td>3</td></tr> <tr><td>Above 960</td><td>500</td><td>3</td></tr> </tbody> </table> | Frequency | Field Strength | Measurement Distance | MHz | uV/m | Meters | .009 - 0.490 | 2400/F(kHz) | 300 | 0.490 - 1.705 | 24000/F(kHz) | 30 | 1.705 - 30.0 | 30 | 30 | 30 - 88 | 100 | 3 | 88 - 216 | 150 | 3 | 216 - 960 | 200 | 3 | Above 960 | 500 | 3 | | | | | | | | | | | | | | | | | | | | | | | | | | | | | | | | | | | | | | | | | | | | | |
| Frequency | Field Strength | Measurement Distance | | | | | | | | | | | | | | | | | | | | | | | | | | | | | | | | | | | | | | | | | | | | | | | | | | | | | | | | | | | | | | | | | | | | | | | |
| MHz | uV/m | Meters | | | | | | | | | | | | | | | | | | | | | | | | | | | | | | | | | | | | | | | | | | | | | | | | | | | | | | | | | | | | | | | | | | | | | | | |
| .009 - 0.490 | 2400/F(kHz) | 300 | | | | | | | | | | | | | | | | | | | | | | | | | | | | | | | | | | | | | | | | | | | | | | | | | | | | | | | | | | | | | | | | | | | | | | | |
| 0.490 - 1.705 | 24000/F(kHz) | 30 | | | | | | | | | | | | | | | | | | | | | | | | | | | | | | | | | | | | | | | | | | | | | | | | | | | | | | | | | | | | | | | | | | | | | | | |
| 1.705 - 30.0 | 30 | 30 | | | | | | | | | | | | | | | | | | | | | | | | | | | | | | | | | | | | | | | | | | | | | | | | | | | | | | | | | | | | | | | | | | | | | | | |
| 30 - 88 | 100 | 3 | | | | | | | | | | | | | | | | | | | | | | | | | | | | | | | | | | | | | | | | | | | | | | | | | | | | | | | | | | | | | | | | | | | | | | | |
| 88 - 216 | 150 | 3 | | | | | | | | | | | | | | | | | | | | | | | | | | | | | | | | | | | | | | | | | | | | | | | | | | | | | | | | | | | | | | | | | | | | | | | |
| 216 - 960 | 200 | 3 | | | | | | | | | | | | | | | | | | | | | | | | | | | | | | | | | | | | | | | | | | | | | | | | | | | | | | | | | | | | | | | | | | | | | | | |
| Above 960 | 500 | 3 | | | | | | | | | | | | | | | | | | | | | | | | | | | | | | | | | | | | | | | | | | | | | | | | | | | | | | | | | | | | | | | | | | | | | | | |
| | (b) In the emission table above, the tighter limit applies at the band edges. | | | | | | | | | | | | | | | | | | | | | | | | | | | | | | | | | | | | | | | | | | | | | | | | | | | | | | | | | | | | | | | | | | | | | | | | |

| | | |
|--------------------------------|-----------------------------|--------------------|
| Test Report Serial No.: | 022305KBC-T618-E15B | Issue 1.0 |
| Test Date(s): | 21Sept04 - 14Oct04, 22Oct04 | |
| Test Type(s): | FCC §15.247 | IC RSS-210 Issue 5 |
| Lab Registration(s): | FCC #714830 | IC Lab File #3874 |

| I.3. ENVIRONMENTAL CONDITIONS | |
|-------------------------------|-------------------|
| Temperature | 27.4 +/- 2 °C |
| Humidity | 33 +/- 2 % |
| Barometric Pressure | 96.24 +/- 0.2 kPa |

| I.4. EQUIPMENT LIST | | | | | |
|---------------------|--------------|-----------|------------------------------|----------|---------|
| ASSET NUMBER | MANUFACTURER | MODEL | DESCRIPTION | LAST CAL | CAL DUE |
| 00072 | EMCO | 2075 | Mini-mast | n/a | n/a |
| 00073 | EMCO | 2080 | Turn Table | n/a | n/a |
| 00071 | EMCO | 2090 | Multi-Device Controller | n/a | n/a |
| 00085 | EMCO | 6502 | Loop Antenna | 10Aug04 | 10Aug05 |
| 00050 | Chase | CBL-6111A | Bilog Antenna | 30Apr04 | 30Apr05 |
| 00035 | ETS | 3115 | Double Ridged Guide Horn | 24Mar04 | 24Mar05 |
| 00202 | ETS | 3160-09 | Small Horn Antenna | 27May04 | 27May05 |
| 00015 | Agilent | E4408B | Spectrum Analyzer | 29Dec03 | 29Dec04 |
| 00049 | HP | 8566B | Spectrum Analyzer RF Section | 18May04 | 18May05 |
| 00049 | HP | 85650A | Quasi-peak Adapter | 18May04 | 18May05 |
| 00047 | HP | 85685A | RF Preselector | 18May04 | 18May05 |
| 00048 | Gore | 65474 | Microwave Cable | 20May04 | 20May05 |
| 00030 | HP | 83017A | LNA | 20May04 | 20May05 |

| | | | | | | | | |
|---------------------------------------------------------------------------------------------------------------|---------------------|----------------------------------------------------------------------------------------------------------------|----------------|----------------|-------------------|---------------|---------------------------------------------------------------------------------------|--|
| Applicant: | Itronix Corporation | Model: | IX260PROA580BT | FCC ID: | KBCIX260PROA580BT | IC ID: | 1943A-IX260Pf | |
| Rugged Laptop PC with Cirronet BT2022 Bluetooth, Intel Pro 2200BG 802.11b/g WLAN, & Dual-Band CDMA | | | | | | |  | |
| 2005 Celltech Labs Inc | | This document is not to be reproduced in whole or in part without the written permission of Celltech Labs Inc. | | | | | 35 of 45 | |

I.5. MEASUREMENT EQUIPMENT SETUP

| | | | | | |
|-------------------------------------------------------------------------------------------------------------------------------------------------------|-------------------------------------------------------------------------------------------------------------------------------------------------------------------------------------------------|-------------------|-----------------|---------------|-------------------|
| MEASUREMENT EQUIPMENT CONNECTIONS | The measurement equipment was connected as shown in I.6. A number of antennas were used to cover the applicable frequency range test. The ranges in which each antenna was used are as follows: | | | | |
| | Frequency Range | | Antenna | | |
| | 10 kHz – 30 MHz | | EMCO 6502 Loop | | |
| | 30 MHz – 1 GHz | | CBL-6111A Bilog | | |
| | 1 GHz – 18 GHz | | ETS 3115 Horn | | |
| 18 GHz– 26GHz | | ETS 3160-09 Horn | | | |
| MEASUREMENT EQUIPMENT SETTINGS | The spectrum analyzer was set to the following settings: | | | | |
| | Frequency Range | RBW | VBW | Quasi-Peak BW | Detector |
| | MHz | kHz | kHz | kHz | |
| | 0.01 - 0.15 | 3 ¹ | 30 | 0.2 | Peak ² |
| | 0.15 – 30 | 100 ¹ | 300 | 3 | Peak ² |
| | 30 – 1000 | 1000 ¹ | 300 | 120 | Peak ² |
| | > 1000 | 1000 | 1000 | na | Peak ² |
| Note 1: The Quasi-peak adapter was placed in normal for all measurements below 1000 MHz, therefore its bandwidths take precedence. | | | | | |
| Note 2: As a worse case measurement, when suitable margin could be realized, the average limit was applied to measurements made with a peak detector. | | | | | |

I.6. SETUP DRAWING

Figure I-1 - Setup Drawing

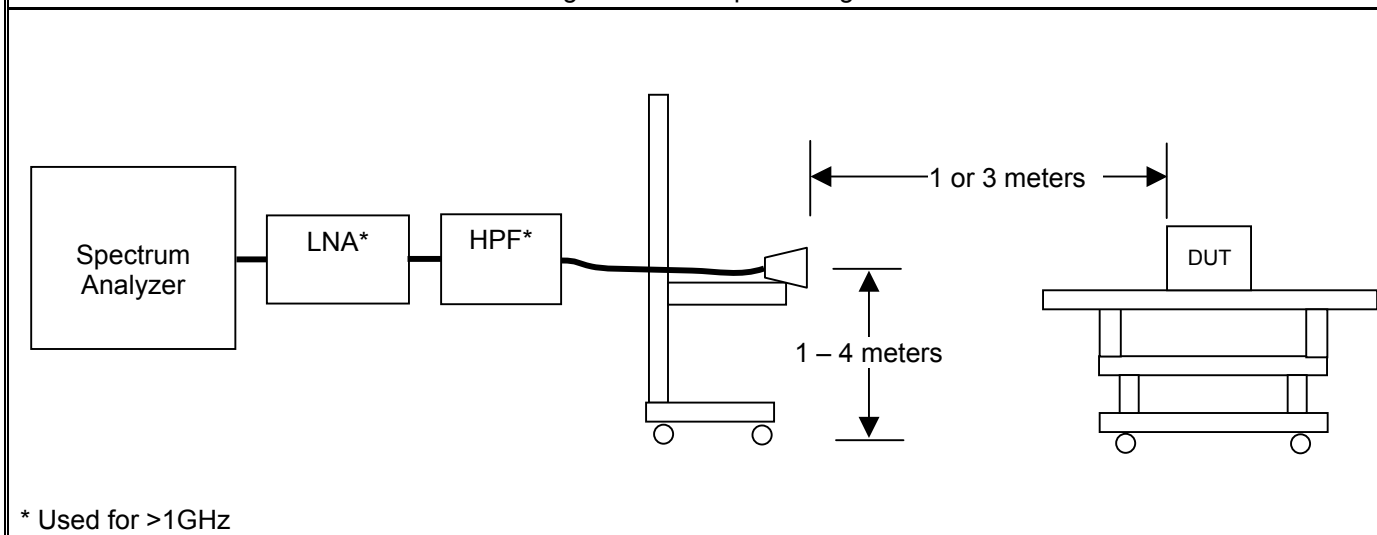

| | | |
|--------------------------------|-----------------------------|--------------------|
| Test Report Serial No.: | 022305KBC-T618-E15B | Issue 1.0 |
| Test Date(s): | 21Sept04 - 14Oct04, 22Oct04 | |
| Test Type(s): | FCC §15.247 | IC RSS-210 Issue 5 |
| Lab Registration(s): | FCC #714830 | IC Lab File #3874 |

I.7. SETUP PHOTOGRAPHS

Photograph I-1 - Loop Antenna (10kHz- 30MHz)



Photograph I-2 - Bilog Antenna (30MHz - 1 GHz)



Photograph I-3 - Horizontal Polarization (30MHz - 1 GHz)



Photograph I-4 - Vertical Polarization (30MHz - 1 GHz)



| | | | | | | | | |
|---------------------------------------------------------------------------------------------------------------|---------------------|----------------------------------------------------------------------------------------------------------------|----------------|----------------|-------------------|---------------|---------------------------------------------------------------------------------------|--|
| Applicant: | Itronix Corporation | Model: | IX260PROA580BT | FCC ID: | KBCIX260PROA580BT | IC ID: | 1943A-IX260PF | |
| Rugged Laptop PC with Cirronet BT2022 Bluetooth, Intel Pro 2200BG 802.11b/g WLAN, & Dual-Band CDMA | | | | | | |  | |
| 2005 Celltech Labs Inc | | This document is not to be reproduced in whole or in part without the written permission of Celltech Labs Inc. | | | | | 37 of 45 | |

| | | |
|--------------------------------|-----------------------------|--------------------|
| Test Report Serial No.: | 022305KBC-T618-E15B | Issue 1.0 |
| Test Date(s): | 21Sept04 - 14Oct04, 22Oct04 | |
| Test Type(s): | FCC §15.247 | IC RSS-210 Issue 5 |
| Lab Registration(s): | FCC #714830 | IC Lab File #3874 |

Photograph I-5 - Front of Radiated Emission Configuration



Photograph I-6 - Back of Radiated Emission Configuration

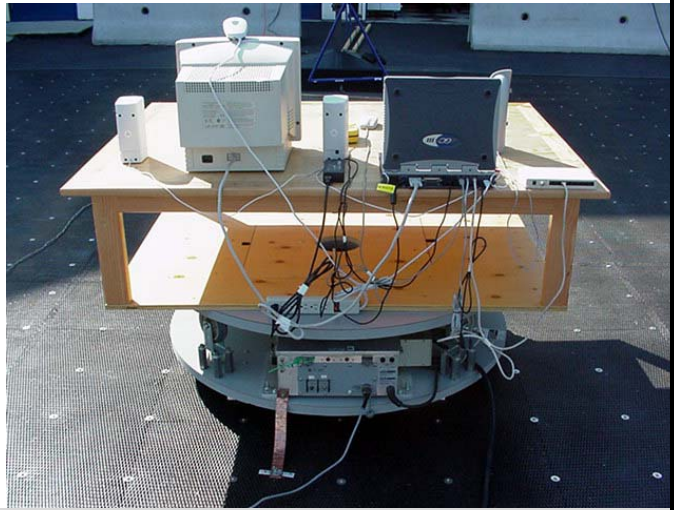

I.8. DUT OPERATING DESCRIPTION

Measurements were made at three channels throughout the band, Low Channel (2402 MHz), Mid Channel (2441 MHz), High Channel (2480 MHz). The configuration used was with a gain setting of 250/40 for the low channel, 250/44 for mid channel and 220/45 for the high channel. The modulation was set to 1000. As a worst case, the band-edge measurements were made of the low and high channels with data stream modulation.

| | | | | | | | | |
|---------------------------------------------------------------------------------------------------------------|---------------------|----------------------------------------------------------------------------------------------------------------|----------------|----------------|-------------------|---------------|---------------------------------------------------------------------------------------|--|
| Applicant: | Itronix Corporation | Model: | IX260PROA580BT | FCC ID: | KBCIX260PROA580BT | IC ID: | 1943A-IX260Pf | |
| Rugged Laptop PC with Cirronet BT2022 Bluetooth, Intel Pro 2200BG 802.11b/g WLAN, & Dual-Band CDMA | | | | | | |  | |
| 2005 Celltech Labs Inc | | This document is not to be reproduced in whole or in part without the written permission of Celltech Labs Inc. | | | | | 38 of 45 | |

| | | |
|--------------------------------|-----------------------------|--------------------|
| Test Report Serial No.: | 022305KBC-T618-E15B | Issue 1.0 |
| Test Date(s): | 21Sept04 - 14Oct04, 22Oct04 | |
| Test Type(s): | FCC §15.247 | IC RSS-210 Issue 5 |
| Lab Registration(s): | FCC #714830 | IC Lab File #3874 |

I.9. TEST RESULTS

I.9.1. Upper Band-edge Emission Field Strengths @ Specified Distance

Note: (Lower Band-edge (Out-of-Band) is in Appendix H)

Channel 79 - Conducted Band-edge Plots

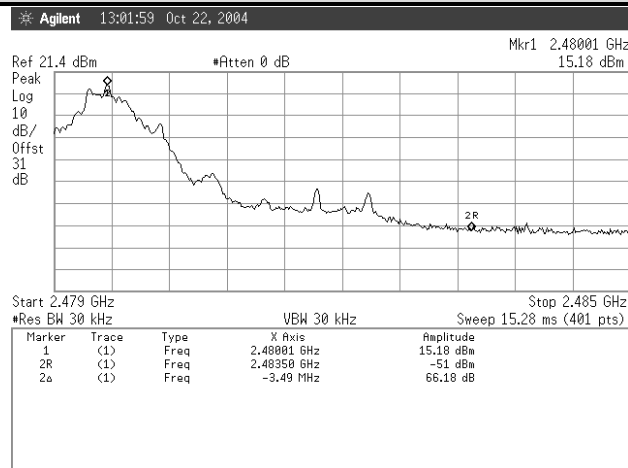

Channel 0 - Radiated Carrier Field Strengths

| Polarity | Distance | Rx Antenna | Channel | Frequency | SA Level | Rx AF | Rx CL | Other Rx | Total Rx CF | Field Strength | Detector |
|----------|----------|-------------|---------|-----------|----------|-------|-------|----------|-------------|----------------|----------|
| | | | | MHz | dBuV | dB/m | dB | dB | dB/m | dBuV/m | |
| H | 3 | Horn SN6276 | 79 | 2480.00 | 83.00 | 30.37 | 3.51 | 0.00 | 33.88 | 116.88 | PK |
| H | 3 | Horn SN6276 | 79 | 2480.00 | 41.80 | 30.37 | 3.51 | 0.00 | 33.88 | 75.68 | AV |
| V | 3 | Horn SN6276 | 79 | 2480.00 | 76.70 | 30.37 | 3.51 | 0.00 | 33.88 | 110.58 | PK |
| V | 3 | Horn SN6276 | 79 | 2480.00 | 39.10 | 30.37 | 3.51 | 0.00 | 33.88 | 72.98 | AV |

Channel 0 - Calculated Band-edge (Out-of-Band) Field Strengths

| Polarity | Distance | Rx Antenna | Channel | Frequency | Carrier Radiated Field Strength | Detector | Marker-Delta | Calculated Bandedge Field Strength | Limit Distance | Limit Distance Correction | Calculated Limit | Margin | Pass/Fail |
|----------|----------|-------------|---------|-----------|---------------------------------|----------|--------------|------------------------------------|----------------|---------------------------|------------------|--------|-----------|
| | | | | MHz | dBuV/m | | dB | dBuV/m | m | dB | dBuV/m | dB | |
| H | 3 | Horn SN6276 | 79 | 2483.5 | 116.88 | PK | 66.18 | 50.7 | 3 | 0 | 73.98 | 23.28 | Pass |
| H | 3 | Horn SN6276 | 79 | 2483.5 | 75.68 | AV | 66.18 | 9.5 | 3 | 0 | 53.98 | 44.48 | Pass |
| V | 3 | Horn SN6276 | 79 | 2483.5 | 110.58 | PK | 66.18 | 44.4 | 3 | 0 | 73.98 | 29.58 | Pass |
| V | 3 | Horn SN6276 | 79 | 2483.5 | 72.98 | AV | 66.18 | 6.8 | 3 | 0 | 53.98 | 47.18 | Pass |

Formulae:

Total CF (dB) = Antenna Factor (dB) + Cable Factor (dB) + Other Factor (Amplifier Gain, Filter Loss, etc) (dB)

Field Strength (dBuV/m) = SA Reading (dBuV) + Total CF (dB/m)

Limit Distance Correction (dB) = 40 * log(d1/d2) for f < 30 MHz, 20*log(d1/d2) for f > 30 MHz, where d1 is the measurement distance and d2 is the published limit

Limit (dBuV/m) = Published Limit (dBuV/m) + Limit Distance Correction (dB)

Margin (dB) = Limit (dBuV/m) - Field Strength (dBuV/m)

Note: Measurements and calculation reference the Marker-Delta Method Described in FCC Public Notice DA 00-705

| | | | | | | | | |
|---------------------------------------------------------------------------------------------------------------|---------------------|----------------------------------------------------------------------------------------------------------------|----------------|----------------|-------------------|---------------|---------------|--|
| Applicant: | Itronix Corporation | Model: | IX260PROA580BT | FCC ID: | KBCIX260PROA580BT | IC ID: | 1943A-IX260PF | |
| Rugged Laptop PC with Cirronet BT2022 Bluetooth, Intel Pro 2200BG 802.11b/g WLAN, & Dual-Band CDMA | | | | | | | | |
| 2005 Celltech Labs Inc | | This document is not to be reproduced in whole or in part without the written permission of Celltech Labs Inc. | | | | | 39 of 45 | |

| | | |
|-------------------------|----------------------------|--------------------|
| Test Report Serial No.: | 022305KBC-T618-E15B | Issue 1.0 |
| Test Date(s): | 21Sep04 - 14Oct04, 22Oct04 | |
| Test Type(s): | FCC §15.247 | IC RSS-210 Issue 5 |
| Lab Registration(s): | FCC #714830 | IC Lab File #3874 |

I.9.2. Spurious Emission Field Strengths @ Specified Distance



Company: 072804KBC-T543-E15B
 Product: Itronix
 IX260+ with Bluetooth

Standard: FCC15.209
 Test Start Date: 21Sep04
 Test End Date: 12Oct04

| IX260+ with Bluetooth | | | | | | | | | | | | | | | | | | |
|-----------------------|----------|----------|-------------|-----------|----------|-------------|-------|-------|----------|------------------------|-------------|----------------|----------|----------------|---------------------------|------------------|--------|-----------|
| Channel | Polarity | Distance | Rx Antenna | Frequency | SA Level | Noise Floor | Rx AF | Rx CL | Other Rx | *Duty Cycle Correction | Total Rx CF | Field Strength | Detector | Limit Distance | Limit Distance Correction | Calculated Limit | Margin | Pass/Fail |
| | | | | | | | | | | | | | | | | | | |
| BT-Low | H | 3 | Horn SN6276 | 2000.00 | 14.40 | x | 29.60 | 3.18 | 0.00 | -20.00 | 12.78 | 27.18 | PK | 3.00 | 0.00 | 53.98 | 26.80 | PASS |
| BT-Low | H | 3 | Horn SN6276 | 2390.00 | 36.40 | | 30.22 | 3.47 | 0.00 | -20.00 | 13.69 | 50.09 | PK | 3.00 | 0.00 | 53.98 | 3.89 | PASS |
| BT-Low | H | 3 | Horn SN6276 | 2483.00 | 50.90 | | 30.37 | 3.51 | -20.26 | -20.00 | -6.37 | 44.53 | PK | 3.00 | 0.00 | 53.98 | 9.45 | PASS |
| BT-Low | H | 3 | Horn SN6276 | 7206.72 | 52.40 | | 38.17 | 6.21 | -34.32 | -20.00 | -9.94 | 42.46 | PK | 3.00 | 0.00 | 53.98 | 11.52 | PASS |
| BT-Low | H | 1 | Horn SN6276 | 17986.00 | 44.90 | | 45.86 | 10.43 | -32.01 | -20.00 | 4.28 | 49.18 | PK | 3.00 | 9.54 | 63.52 | 14.35 | PASS |
| BT-Low | V | 3 | Horn SN6276 | 2000.00 | 17.00 | x | 29.60 | 3.18 | 0.00 | -20.00 | 12.78 | 29.78 | PK | 3.00 | 0.00 | 53.98 | 24.20 | PASS |
| BT-Low | V | 3 | Horn SN6276 | 2390.00 | 29.20 | | 30.22 | 3.47 | 0.00 | -20.00 | 13.69 | 42.89 | PK | 3.00 | 0.00 | 53.98 | 11.09 | PASS |
| BT-Low | V | 3 | Horn SN6276 | 2483.00 | 44.00 | | 30.37 | 3.51 | -20.26 | -20.00 | -6.37 | 37.63 | PK | 3.00 | 0.00 | 53.98 | 16.35 | PASS |
| BT-Low | V | 3 | Horn SN6276 | 4804.58 | 52.70 | | 35.31 | 4.96 | -34.08 | -20.00 | -13.81 | 38.89 | PK | 3.00 | 0.00 | 53.98 | 15.09 | PASS |
| BT-Low | V | 3 | Horn SN6276 | 4804.46 | 50.80 | | 35.31 | 4.96 | -34.08 | -20.00 | -13.81 | 36.99 | PK | 3.00 | 0.00 | 53.98 | 16.99 | PASS |
| BT-Low | V | 3 | Horn SN6276 | 7207.22 | 57.30 | | 38.17 | 6.21 | -34.32 | -20.00 | -9.93 | 47.37 | PK | 3.00 | 0.00 | 53.98 | 6.61 | PASS |
| BT-Low | V | 1 | Horn SN6276 | 17874.00 | 44.50 | | 45.52 | 10.28 | -32.09 | -20.00 | 3.71 | 48.21 | PK | 3.00 | 9.54 | 63.52 | 15.31 | PASS |
| BT-Mid | H | 3 | Horn SN6276 | 2000.00 | 14.40 | x | 29.60 | 3.18 | 0.00 | -20.00 | 12.78 | 27.18 | PK | 3.00 | 0.00 | 53.98 | 26.80 | PASS |
| BT-Mid | H | 3 | Horn SN6276 | 2390.00 | 47.20 | | 30.22 | 3.47 | -20.40 | -20.00 | -6.71 | 40.49 | PK | 3.00 | 0.00 | 53.98 | 13.49 | PASS |
| BT-Mid | H | 3 | Horn SN6276 | 2483.50 | 51.60 | | 30.37 | 3.51 | -20.26 | -20.00 | -6.37 | 45.23 | PK | 3.00 | 0.00 | 53.98 | 8.75 | PASS |
| BT-Mid | H | 3 | Horn SN6276 | 4882.41 | 55.90 | | 35.46 | 5.04 | -34.09 | -20.00 | -13.59 | 42.31 | PK | 3.00 | 0.00 | 53.98 | 11.67 | PASS |
| BT-Mid | H | 3 | Horn SN6276 | 7323.65 | 50.00 | | 38.38 | 6.32 | -34.32 | -20.00 | -9.62 | 40.38 | PK | 3.00 | 0.00 | 53.98 | 13.60 | PASS |
| BT-Mid | H | 1 | Horn SN6276 | 17992.00 | 44.50 | | 45.88 | 10.45 | -32.01 | -20.00 | 4.32 | 48.82 | PK | 3.00 | 9.54 | 63.52 | 14.70 | PASS |
| BT-Mid | V | 3 | Horn SN6276 | 2000.00 | 17.00 | x | 29.60 | 3.18 | 0.00 | -20.00 | 12.78 | 29.78 | PK | 3.00 | 0.00 | 53.98 | 24.20 | PASS |
| BT-Mid | V | 3 | Horn SN6276 | 2390.00 | 50.30 | | 30.22 | 3.47 | -20.40 | -20.00 | -6.71 | 43.59 | PK | 3.00 | 0.00 | 53.98 | 10.39 | PASS |
| BT-Mid | V | 3 | Horn SN6276 | 2483.50 | 45.90 | | 30.37 | 3.51 | -20.26 | -20.00 | -6.37 | 39.53 | PK | 3.00 | 0.00 | 53.98 | 14.45 | PASS |
| BT-Mid | V | 3 | Horn SN6276 | 4882.23 | 49.80 | | 35.46 | 5.04 | -34.09 | -20.00 | -13.59 | 36.21 | PK | 3.00 | 0.00 | 53.98 | 17.77 | PASS |
| BT-Mid | V | 3 | Horn SN6276 | 7323.74 | 55.80 | | 38.38 | 6.32 | -34.32 | -20.00 | -9.62 | 46.18 | PK | 3.00 | 0.00 | 53.98 | 7.80 | PASS |
| BT-Mid | V | 3 | Horn SN6276 | 9764.87 | 49.40 | | 40.30 | 7.41 | -34.25 | -20.00 | -6.54 | 42.86 | PK | 3.00 | 0.00 | 53.98 | 11.12 | PASS |
| BT-Mid | V | 1 | Horn SN6276 | 18000.00 | 43.90 | | 45.90 | 10.48 | -32.00 | -20.00 | 4.38 | 48.28 | PK | 3.00 | 9.54 | 63.52 | 15.24 | PASS |
| BT-High | H | 3 | Horn SN6276 | 2000.00 | 14.40 | x | 29.60 | 3.18 | 0.00 | -20.00 | 12.78 | 27.18 | PK | 3.00 | 0.00 | 53.98 | 26.80 | PASS |
| BT-High | H | 3 | Horn SN6276 | 2390.00 | 50.50 | | 30.22 | 3.47 | -20.40 | -20.00 | -6.71 | 43.79 | PK | 3.00 | 0.00 | 53.98 | 10.19 | PASS |
| BT-High | H | 3 | Horn SN6276 | 2483.50 | 46.40 | | 30.37 | 3.51 | 0.00 | -20.00 | 13.89 | 60.29 | PK | 3.00 | 0.00 | 73.98 | 13.69 | PASS |
| BT-High | H | 3 | Horn SN6276 | 2483.50 | 26.60 | | 30.37 | 3.51 | 0.00 | -20.00 | 13.89 | 40.49 | PK | 3.00 | 0.00 | 53.98 | 13.49 | PASS |
| BT-High | H | 3 | Horn SN6276 | 4960.48 | 52.20 | | 35.62 | 5.06 | -34.10 | -20.00 | -13.42 | 38.78 | PK | 3.00 | 0.00 | 53.98 | 15.19 | PASS |
| BT-High | H | 1 | Horn SN6276 | 17862.00 | 44.70 | | 45.49 | 10.28 | -32.10 | -20.00 | 3.67 | 48.37 | PK | 3.00 | 9.54 | 63.52 | 15.16 | PASS |
| BT-High | V | 3 | Horn SN6276 | 2000.00 | 17.00 | x | 29.60 | 3.18 | 0.00 | -20.00 | 12.78 | 29.78 | PK | 3.00 | 0.00 | 53.98 | 24.20 | PASS |
| BT-High | V | 3 | Horn SN6276 | 2390.00 | 48.00 | | 30.22 | 3.47 | -20.40 | -20.00 | -6.71 | 41.29 | PK | 3.00 | 0.00 | 53.98 | 12.69 | PASS |
| BT-High | V | 3 | Horn SN6276 | 2483.50 | 40.30 | | 30.37 | 3.51 | 0.00 | -20.00 | 13.89 | 54.19 | PK | 3.00 | 0.00 | 73.98 | 19.79 | PASS |
| BT-High | V | 3 | Horn SN6276 | 2483.50 | 24.10 | | 30.37 | 3.51 | 0.00 | -20.00 | 13.89 | 37.99 | AV | 3.00 | 0.00 | 53.98 | 15.99 | PASS |
| BT-High | V | 3 | Horn SN6276 | 4960.39 | 50.80 | | 35.62 | 5.06 | -34.10 | -20.00 | -13.42 | 37.38 | PK | 3.00 | 0.00 | 53.98 | 16.59 | PASS |
| BT-High | V | 3 | Horn SN6276 | 7440.88 | 49.80 | | 38.59 | 6.43 | -34.32 | -20.00 | -9.29 | 40.51 | PK | 3.00 | 0.00 | 53.98 | 13.47 | PASS |
| BT-High | V | 1 | Horn SN6276 | 17936.00 | 44.70 | | 45.71 | 10.28 | -32.04 | -20.00 | 3.94 | 48.64 | PK | 3.00 | 9.54 | 63.52 | 14.88 | PASS |

Formulae:

Total CF (dB) = Antenna Factor (dB) + Cable Factor (dB) + Other Factor (Amplifier Gain, Filter Loss, etc) (dB)
 Field Strength (dBuV/m) = SA Reading (dBuV) + Total CF (dB/m)
 Limit Distance Correction (dB) = 40 * log(d1/d2) for f < 30 MHz, 20*log(d1/d2) for f > 30 MHz; where d1 is the measurement distance and d2 is the published limit distance
 Limit (dBuV/m) = Published Limit (dBuV/m) + Limit Distance Correction (dB)
 Margin (dB) = Limit (dBuV/m) - Field Strength (dBuV/m)
 Duty Cycle Correction (dB) = 20 * log (duty cycle ratio)
 Duty Cycle ratio = maximum time on in any 100 mS period (in mS) / 100 mS

*DUT duty cycle = 10 mS in each 10 seconds

*The frequency points reported, describe the highest emission measured in each of the ranges tested and are used to describe the measured spectrum as a whole. Though a frequency point detailed may not be in a restricted band, it was the highest emission present in the band measured therefore infers that all emissions that may be present within the restricted bands are in compliance if it is in compliance.

| | | | | | | | | |
|----------------------------------------------------------------------------------------------------|---------------------|----------------------------------------------------------------------------------------------------------------|----------------|---------|-------------------|--------|---------------|--|
| Applicant: | Itronix Corporation | Model: | IX260PROA580BT | FCC ID: | KBCIX260PROA580BT | IC ID: | 1943A-IX260PF | |
| Rugged Laptop PC with Cirronet BT2022 Bluetooth, Intel Pro 2200BG 802.11b/g WLAN, & Dual-Band CDMA | | | | | | | | |
| 2005 Celltech Labs Inc | | This document is not to be reproduced in whole or in part without the written permission of Celltech Labs Inc. | | | | | 40 of 45 | |

| | | |
|--------------------------------|-----------------------------|--------------------|
| Test Report Serial No.: | 022305KBC-T618-E15B | Issue 1.0 |
| Test Date(s): | 21Sept04 - 14Oct04, 22Oct04 | |
| Test Type(s): | FCC §15.247 | IC RSS-210 Issue 5 |
| Lab Registration(s): | FCC #714830 | IC Lab File #3874 |

I.10. PASS/FAIL

In reference to the results outlined in I.9, the DUT passes the requirements as stated in the reference standards as follows: FCC 15.205 (a) (b) and 15.209 (a): No emissions were measured within the restricted bands as outlined in 15.205 that exceeded the limits stated in 15.209.

I.11. SIGN-OFF

I attest to the accuracy of the data. All measurements reported herein were performed by me and are correct to the best of my knowledge and belief. I assume full responsibility for the completeness of these measurements.



Russell Pipe
Senior Compliance Technologist
Celltech Labs Inc.

22Oct04
Date

| | | | | | | | | |
|---------------------------------------------------------------------------------------------------------------|---------------------|----------------------------------------------------------------------------------------------------------------|----------------|----------------|-------------------|---------------|---------------------------------------------------------------------------------------|--|
| Applicant: | Itronix Corporation | Model: | IX260PROA580BT | FCC ID: | KBCIX260PROA580BT | IC ID: | 1943A-IX260Pf | |
| Rugged Laptop PC with Cirronet BT2022 Bluetooth, Intel Pro 2200BG 802.11b/g WLAN, & Dual-Band CDMA | | | | | | |  | |
| 2005 Celltech Labs Inc | | This document is not to be reproduced in whole or in part without the written permission of Celltech Labs Inc. | | | | | 41 of 45 | |

| | | |
|--------------------------------|-----------------------------|--------------------|
| Test Report Serial No.: | 022305KBC-T618-E15B | Issue 1.0 |
| Test Date(s): | 21Sept04 - 14Oct04, 22Oct04 | |
| Test Type(s): | FCC §15.247 | IC RSS-210 Issue 5 |
| Lab Registration(s): | FCC #714830 | IC Lab File #3874 |

Appendix J - Maximum Permissible Exposure Calculation

| J.1. REFERENCES | |
|-------------------------------------|------------------------------------------|
| Normative Reference Standard | FCC CFR 47§1.1310 IEEE Std C95.1-1999 |
| Procedure Reference | FCC CFR 47§2.1091 |

| J.2. LIMITS | |
|------------------------------|------------------------|
| FCC CFR 47§1.1310 Table 1(b) | 1.0 mW/cm ² |

| J.3. ENVIRONMENTAL CONDITIONS | |
|-------------------------------|----|
| Temperature | na |
| Humidity | na |
| Barometric Pressure | na |

| J.4. EQUIPMENT LIST | | | | | |
|---------------------|--------------|-------|-------------|----------|---------|
| ASSET NUMBER | MANUFACTURER | MODEL | DESCRIPTION | LAST CAL | CAL DUE |
| na | | | | | |

| J.5. MEASUREMENT EQUIPMENT SETUP | |
|------------------------------------------|------------------------------------------------------------------------------------------------------------------|
| MEASUREMENT EQUIPMENT CONNECTIONS | The results described herein were determined by the following calculation, so no measurement equipment was used. |
| MEASUREMENT EQUIPMENT SETTINGS | na |

| J.6. SETUP PHOTOS | |
|-------------------|--|
| na | |

| J.7. SETUP DRAWINGS | |
|---------------------|--|
| na | |

| J.8. DUT OPERATING DESCRIPTION | |
|--------------------------------|--|
| na | |

| | | | | | | | | |
|----------------------------------------------------------------------------------------------------|---------------------|----------------------------------------------------------------------------------------------------------------|----------------|----------------|-------------------|---------------|---------------------------------------------------------------------------------------|--|
| Applicant: | Itronix Corporation | Model: | IX260PROA580BT | FCC ID: | KBCIX260PROA580BT | IC ID: | 1943A-IX260Pf | |
| Rugged Laptop PC with Cirronet BT2022 Bluetooth, Intel Pro 2200BG 802.11b/g WLAN, & Dual-Band CDMA | | | | | | |  | |
| 2005 Celltech Labs Inc | | This document is not to be reproduced in whole or in part without the written permission of Celltech Labs Inc. | | | | | 42 of 45 | |

| | | |
|-------------------------|-----------------------------|--------------------|
| Test Report Serial No.: | 022305KBC-T618-E15B | Issue 1.0 |
| Test Date(s): | 21Sept04 - 14Oct04, 22Oct04 | |
| Test Type(s): | FCC §15.247 | IC RSS-210 Issue 5 |
| Lab Registration(s): | FCC #714830 | IC Lab File #3874 |

J.9. EVALUATION RESULTS

Calculation:

Rangestar Internal Surface-Mount Antenna:

Tx Frequency: **2441** (MHz)
 RF Output Power at Antenna Input Terminal: **15.61** (dBm)
 Antenna gain: **4.50** (dBi)

S = **1.00** (mW/cm²)

P = **36.3915** (mW)

G = **2.82** (numeric)

R = 2.86 (cm)

S at 20cm: **0.02038259** (mW/cm²)

Formulae:

$$S = \frac{PG}{4\pi R^2}$$

where: S = Power Density Limit

P = Power Applied to the Antenna

G = Numeric Antenna Gain

R = Distance from Antenna

$$R = \sqrt{\frac{P}{4\pi S}}$$

Results:

| Channel | RF Conducted Output Power | Antenna Gain | MPE Distance | Power Density at 20 cm | Power Density Limit |
|---------|---------------------------|--------------|--------------|------------------------|---------------------|
| | dBm | dBi | cm | mW/cm ² | mW/cm ² |
| 39 | 15.61 | 4.5 | 2.86 | 0.020 | 1.0 |

| | | |
|--------------------------------|-----------------------------|--------------------|
| Test Report Serial No.: | 022305KBC-T618-E15B | Issue 1.0 |
| Test Date(s): | 21Sept04 - 14Oct04, 22Oct04 | |
| Test Type(s): | FCC §15.247 | IC RSS-210 Issue 5 |
| Lab Registration(s): | FCC #714830 | IC Lab File #3874 |

J.10. PASS/FAIL

In reference to the results outlined in J.9, the DUT passes the requirements as stated in the reference standards as follows:
 1) The DUT must comply with the minimum spacing requirement of 20 cm to ensure an exposure of not more than 1 mW/cm².

J.11. SIGN-OFF

I attest to the accuracy of the data. All measurements reported herein were performed by me and are correct to the best of my knowledge and belief. I assume full responsibility for the completeness of these measurements.



 Duane M. Friesen, C.E.T.
 EMC Manager
 Celltech Labs Inc.

 09Oct04

Date

| | | | | | | | | |
|---------------------------------------------------------------------------------------------------------------|---------------------|----------------------------------------------------------------------------------------------------------------|----------------|----------------|-------------------|---------------|---------------------------------------------------------------------------------------|--|
| Applicant: | Itronix Corporation | Model: | IX260PROA580BT | FCC ID: | KBCIX260PROA580BT | IC ID: | 1943A-IX260Pf | |
| Rugged Laptop PC with Cirronet BT2022 Bluetooth, Intel Pro 2200BG 802.11b/g WLAN, & Dual-Band CDMA | | | | | | |  | |
| 2005 Celltech Labs Inc | | This document is not to be reproduced in whole or in part without the written permission of Celltech Labs Inc. | | | | | 44 of 45 | |

| | | |
|--------------------------------|-----------------------------|--------------------|
| Test Report Serial No.: | 022305KBC-T618-E15B | Issue 1.0 |
| Test Date(s): | 21Sept04 - 14Oct04, 22Oct04 | |
| Test Type(s): | FCC §15.247 | IC RSS-210 Issue 5 |
| Lab Registration(s): | FCC #714830 | IC Lab File #3874 |

END OF DOCUMENT

| | | | | | | | | |
|---------------------------------------------------------------------------------------------------------------|---------------------|----------------------------------------------------------------------------------------------------------------|----------------|----------------|-------------------|---------------|---------------------------------------------------------------------------------------|--|
| Applicant: | Itronix Corporation | Model: | IX260PROA580BT | FCC ID: | KBCIX260PROA580BT | IC ID: | 1943A-IX260Pf | |
| Rugged Laptop PC with Cirronet BT2022 Bluetooth, Intel Pro 2200BG 802.11b/g WLAN, & Dual-Band CDMA | | | | | | |  | |
| 2005 Celltech Labs Inc | | This document is not to be reproduced in whole or in part without the written permission of Celltech Labs Inc. | | | | | 45 of 45 | |