

Test Report Serial No.:	022305KBC-T618-E15W/B	Issue 1.0
Test Date(s):	01Oct04 - 14Oct04	
Test Type(s):	FCC §15.247	IC RSS-210 Issue 5
Lab Registration(s):	FCC #714830	IC Lab File #3874

SUPPLEMENTARY EMC TEST REPORT
FOR THE
ITRONIX RUGGED LAPTOP PC MODEL: IX260PROA580BT
WITH THE
INTERNAL CIRRONET BT2022 BLUETOOTH TRANSMITTER
UTILIZING THE
INTERNAL RANGESTAR SURFACE-MOUNT ANTENNA
(INSTALLED IN THE UPPER LEFT SIDE REAR OF LCD DISPLAY)
CO-TRANSMITTING WITH THE
INTERNAL INTEL PRO 2200BG 2.4 DSSS WLAN MINI-PCI CARD
UTILIZING THE
INTERNAL RANGESTAR SURFACE-MOUNT ANTENNA
(INSTALLED IN THE UPPER RIGHT SIDE REAR OF LCD DISPLAY)

TRSN 022305KBC-T618-E15W/B
Issue 1.0

Celltech Compliance Testing & Engineering Lab
(Celltech Labs Inc.)
1955 Moss Court
Kelowna, BC
Canada
V1Y 9L3

May 09, 2005

Test Report Serial No.:	022305KBC-T618-E15W/B	Issue 1.0
Test Date(s):	01Oct04 - 14Oct04	
Test Type(s):	FCC §15.247	IC RSS-210 Issue 5
Lab Registration(s):	FCC #714830	IC Lab File #3874

DECLARATION OF COMPLIANCE

Test Lab		Applicant Information	
CELLTECH LABS INC. Testing and Engineering Services 1955 Moss Court Kelowna, B.C. Canada V1Y 9L3 Phone: 250-448-7047 Fax: 250-448-7048 e-mail: info@celltechlabs.com web site: www.celltechlabs.com		ITRONIX CORPORATION 801 South Stevens Street Spokane, WA 99204 United States	
Laboratory Registration No.(s):	FCC: 714830	IC: IC 3874	
Rule Part(s):	FCC: §15.247; §2.1091; §1.1310	IC: RSS-210 Issue 5	
Device Classification:	FCC: WLAN - DSSS	- Digital Transmission System (DTS)	
	Bluetooth - FHSS	- Part 15 Spread Spectrum Transmitter (DSS)	
Device Identification:	FCC ID: KBCIX260PROA580BT	IC ID: 1943A-IX260Pf	
DUT Description:			
Model:	IX260PROA580BT		
Device Description:	Rugged Laptop PC including the Cirronet BT2022 Bluetooth Transmitter and internal RangeStar surface-mount antenna (upper left side rear of LCD display), co-transmitting with the Intel Pro 2200BG 802.11b/g 2.4 GHz DSSS WLAN Mini-PCI Card and internal RangeStar surface-mount antenna (upper right side rear of LCD display)		
Tx Frequency Range(s):	Bluetooth	2402 - 2480 MHz	
	WLAN	2412 - 2462 MHz	
Max. RF Output Power:	Bluetooth	15.61 dBm / 0.0364 Watts (Peak Conducted)	
	WLAN	17.48 dBm / 0.0560 Watts (Peak Conducted - 802.11b)	
		16.15 dBm / 0.0412 Watts (Peak Conducted - 802.11g)	
Modulation Type(s):	Bluetooth	GFSK 1 Mbps 0.5 BT Gaussian	
	WLAN	DBPSK, DQPSK, CCK	
Antenna Type(s):	RangeStar P/N: 100929 Dual Internal Surface-Mount		
Power Source(s):	Stationary: 90 Watt AC Power Adapter	11.1V Lithium-ion Battery, 6.0Ah (Model: A2121-2)	

This wireless mobile transmitting device has demonstrated compliance with the applicable technical standards as indicated in the measurement report and was tested in accordance with the measurement procedures specified in FCC 47 CFR Part 15(C), Industry Canada RSS-210 Issue 5, and ANSI TIA/EIA-603-B-2002.

I attest to the accuracy of the data. All measurements reported herein were performed by me or were under my supervision and are correct to the best of my knowledge and belief. I assume full responsibility for the completeness of these measurements and vouch for the qualifications of all persons taking them.

This test report shall not be reproduced partially, or in full, without the prior written approval of Celltech Labs Inc. The results and statements contained in this report pertain only to the device(s) evaluated.



Russell Pipe
Senior Compliance Technologist
Celltech Labs Inc.



Duane M. Friesen
EMC Manager
Celltech Labs Inc.



Applicant: Itronix Corporation	Model: IX260PROA580BT	IC ID: 1943A-IX260Pf	FCC ID: KBCIX260PROA580BT
IX260+ Rugged Laptop PC with internal Intel Pro 2200BG 802.11b/g WLAN and Cirronet BT2022 Bluetooth			
2005 Celltech Labs Inc This document is not to be reproduced in whole or in part without the written permission of Celltech Labs Inc.			2 of 42

Test Report Serial No.:	022305KBC-T618-E15W/B	Issue 1.0
Test Date(s):	01Oct04 - 14Oct04	
Test Type(s):	FCC §15.247	IC RSS-210 Issue 5
Lab Registration(s):	FCC #714830	IC Lab File #3874

TABLE OF CONTENTS

1.0 SCOPE	5
2.0 REFERENCES	5
2.1 Normative References	5
3.0 TERMS AND DEFINITIONS	6
4.0 FACILITIES AND ACCREDITATIONS	7
5.0 GENERAL INFORMATION	7
5.1 Applicant Information	7
5.2 DUT Description	7
5.3 Co-Located Equipment	8
5.4 Cable Descriptions	8
5.5 Support Equipment	9
5.6 Clock Frequencies	9
5.7 Mode(s) of Operation Tested	10
5.8 Configuration Description	11
6.0 PASS/FAIL CRITERIA	11
APPENDICES	12
Appendix A - DUT Photographs	13
Appendix B - Conducted Powerline Emissions Measurement	15
Appendix C - Radiated Spurious Emissions Measurement	22
Appendix D - Restricted Band Emissions Measurement	26
Appendix E - Maximum Permissible Exposure Calculation	39
END OF DOCUMENT	42

FIGURES

Figure B-1 - Setup Drawing	18
Figure C-1 - Setup Drawing	23
Figure D-1 - Setup Drawing	28

PHOTOGRAPHS

Photograph A-1 - Front of Open IX260+ Laptop PC	13
Photograph A-2 - Back of Open IX260+ Laptop PC	13
Photograph A-3 - WLAN Mini-PCI Card Location	13
Photograph A-4 - Bluetooth Transmitter Location	13
Photograph A-5 - WLAN Mini-PCI Card	14
Photograph A-6 - Bluetooth Transmitter	14
Photograph A-7 - Surface Mount Antenna Placement	14
Photograph B-1 - AC Powerline Conducted Emission Configuration	17
Photograph B-2 - AC Powerline Conducted Emission Cable Placement	17
Photograph C-1 - Loop Antenna (10kHz - 30MHz)	24
Photograph C-2 - Bilog Antenna (30MHz - 1 GHz)	24
Photograph C-3 - 3115 Horn Antenna	24
Photograph C-4 - 3160-09 Horn Antenna	24
Photograph D-1 - Horizontal Polarization (30MHz - 1 GHz)	29
Photograph D-2 - Vertical Polarization (30MHz - 1 GHz)	29
Photograph D-3 - Front of Radiated Emission Configuration	29
Photograph D-4 - Back of Radiated Emission Configuration	29

Applicant:	Itronix Corporation	Model:	IX260PROA580BT	IC ID:	1943A-IX260Pf	FCC ID:	KBCIX260PROA580BT	
IX260+ Rugged Laptop PC with internal Intel Pro 2200BG 802.11b/g WLAN and Cirronet BT2022 Bluetooth								
2005 Celltech Labs Inc		This document is not to be reproduced in whole or in part without the written permission of Celltech Labs Inc.					3 of 42	

Test Report Serial No.:	022305KBC-T618-E15W/B	Issue 1.0
Test Date(s):	01Oct04 - 14Oct04	
Test Type(s):	FCC §15.247	IC RSS-210 Issue 5
Lab Registration(s):	FCC #714830	IC Lab File #3874

TEST SUMMARY

Referenced Standard: FCC CFR Title 47 Part 15

Appendix	Test Description	Procedure Reference	Limit Reference	Test Start Date	Test End Date	Result
B	Powerline Conducted Emissions	ANSI C63.4	§15.207	14Oct04	14Oct04	Pass
C	Radiated Spurious Emissions	FCC 97-114	§15.247	01Oct04	05Oct04	Pass
D	Restricted Band Emissions	FCC 97-114	§15.205 (a), (b) §15.209 (a)	01Oct04	05Oct04	Pass
E	Maximum Permissible Exposure	FCC CFR 47 § 2.1091 IEEE Std C95.1-1999	§1.1310 Table 1 (b)	na	na	Pass



Referenced Standard: IC RSS-210 Issue 5

B	Powerline Conducted Emissions	RSS-212, ANSI C63.4	RSS-210 §6.6	14Oct04	14Oct04	Pass
C	Radiated Spurious Emissions	RSS-212, ANSI C63.4	RSS-210 §6.2.2 (e1)	01Oct04	05Oct04	Pass
D	Restricted Band Emissions	RSS-212, ANSI C63.4	RSS-210 §6.3	01Oct04	05Oct04	Pass
E	Maximum Permissible Exposure	RSS-102	RSS-210 §14 Safety Code 6 2.2.1(a) Table 5	na	na	Pass

REVISION LOG

Issue	Description	Implemented By	Implementation Date
1.0	Initial Release	Jon Hughes	09May05

SIGNATORIES

Prepared By		May 09, 2005
Name/Title	Duane M. Friesen, C.E.T. / EMC Manager	Date
Reviewed By		May 09, 2005
Name/Title	Jon Hughes / General Manager	Date

Test Report Serial No.:	022305KBC-T618-E15W/B	Issue 1.0
Test Date(s):	01Oct04 - 14Oct04	
Test Type(s):	FCC §15.247	IC RSS-210 Issue 5
Lab Registration(s):	FCC #714830	IC Lab File #3874

1.0 SCOPE

This report outlines the measurements made and results collected during electromagnetic emissions testing of the Itronix Corporation Rugged Laptop PC with internal Cirronet BT2022 Bluetooth Transmitter co-transmitting with the Intel Pro 2200BG Mini-PCI 2.4 GHz DSSS WLAN card, each connected to separate Rangestar internal surface-mount antennas. This report describes the results obtained when inter-modulation product measurements were made with both transmitters installed in the Rugged Laptop PC as described, and transmitting simultaneously. The measurement results were applied against the EMC requirements and limits outlined in the technical rules and regulations set forth in the Federal Communication Commission Code of Federal Regulations Title 47 Part 15 Subpart C, and Industry Canada Radio Standards Specification RSS-210 Issue 5.

2.0 REFERENCES

2.1 Normative References

ANSI/ISO 17025:1999	General Requirements for competence of testing and calibration laboratories
IEEE/ANSI C63.4-2003	Methods of Measurement of Radio-Noise Emissions from Low-Voltage Electrical and Electronic Equipment in the Range of 9 kHz to 40 GHz
IEEE/ANSI Std C95.1-1999	American National Standard Safety Levels with Respect to Human Exposure to Radio Frequency Electromagnetic Fields
CFR Title 47 Part 2:2003	Code of Federal Regulations Title 47: Telecommunication Part 2: Frequency Allocations and Radio Treaty Matters; General Rules and Regulations
CFR Title 47 Part 15:2003	Code of Federal Regulations Title 47: Telecommunication Part 15: Radio Frequency Devices
IC Spectrum Management & Telecommunications Policy	Radio Standards Specification RSS-212 Issue 1 (Provisional) – Test Facilities & Test Methods for Radio Equipment RSS-210 Issue 5 – Low Power Licence-Exempt Radiocommunication Devices RSS-102 Issue 1 (Provisional) – Evaluation Procedure for Mobile and Portable Radio Transmitters with respect to Health Canada’s Safety Code 6 for Exposure of Humans to Radio Frequency Fields
Celltech Labs Test Report	EMC Test Report For the Model IX260PROA580BT Rugged Laptop PC with Intel Pro 2200 BG Mini-PCI 2.4 GHz DSSS WLAN Card and Internal Antenna Test Report Serial Number 022305KBC-T618-E15W Date: May 09, 2005
Celltech Labs Test Report	EMC Test Report For the Model IX260PROA580BT Rugged Laptop PC with Cirronet BT2022 Bluetooth Transmitter and Internal Antenna Test Report Serial Number 022305KBC-T618-E15B Date: May 09, 2005

Applicant:	Itronix Corporation	Model:	IX260PROA580BT	IC ID:	1943A-IX260Pf	FCC ID:	KBCIX260PROA580BT
IX260+ Rugged Laptop PC with internal Intel Pro 2200BG 802.11b/g WLAN and Cirronet BT2022 Bluetooth							
2005 Celltech Labs Inc This document is not to be reproduced in whole or in part without the written permission of Celltech Labs Inc.							5 of 42

Test Report Serial No.:	022305KBC-T618-E15W/B	Issue 1.0
Test Date(s):	01Oct04 - 14Oct04	
Test Type(s):	FCC §15.247	IC RSS-210 Issue 5
Lab Registration(s):	FCC #714830	IC Lab File #3874

3.0 TERMS AND DEFINITIONS

AVG	Average
CFR	Code of Federal Regulations
dB	decibel
dBm	dB referenced to 1 mW
dBuV	dB referenced to 1 uV
DUT	Device under Test
dBc	dB down from carrier
EBW	Emission Bandwidth
EMC	Electromagnetic Compatibility
FCC	Federal Communication Commission
FHSS	Frequency Hopping Spread Spectrum
HP	Hewlett Packard
HPF	High Pass Filter
Hpol	Horizontal Polarization
Hz	Hertz
IC	Industry Canada
kHz	kilohertz
LNA	Low Noise Amplifier
m	meter
MHz	Megahertz
Mbps	megabits per second
na	not applicable
n/a	not available
PK	Peak
PPSD	Peak Power Spectral Density
QP	Quasi-peak
RBW	Resolution Bandwidth
R&S	Rohde & Schwarz
RSS	Radio Standard Specification
SA	Spectrum Analyzer
VBW	Video Bandwidth
Vpol	Vertical Polarization
WLAN	Wireless Local Area Network

Applicant:	Itronix Corporation	Model:	IX260PROA580BT	IC ID:	1943A-IX260Pf	FCC ID:	KBCIX260PROA580BT	
IX260+ Rugged Laptop PC with internal Intel Pro 2200BG 802.11b/g WLAN and Cirronet BT2022 Bluetooth								
2005 Celltech Labs Inc		This document is not to be reproduced in whole or in part without the written permission of Celltech Labs Inc.					6 of 42	

Test Report Serial No.:	022305KBC-T618-E15W/B	Issue 1.0
Test Date(s):	01Oct04 - 14Oct04	
Test Type(s):	FCC §15.247	IC RSS-210 Issue 5
Lab Registration(s):	FCC #714830	IC Lab File #3874

4.0 FACILITIES AND ACCREDITATIONS

The facilities used in collecting the test results outlined in this report are located at 1955 Moss Court, Kelowna, British Columbia, Canada, V1Y 9L3. The radiated and conducted emissions sites conform with the requirements set forth in ANSI C63.4 and are filed and listed with the FCC under Registration Number 714830 and Industry Canada under File Number IC 3874.

5.0 GENERAL INFORMATION

5.1 Applicant Information

Company Name:	Itronix Corporation
Address:	801 South Stevens Street Spokane, WA 99204 United States

5.2 DUT Description

The DUT consisted of the Model: IX260PROA580BT Rugged Laptop PC containing a Cirronet BT2022 Bluetooth Transmitter connected to an Internal Surface-Mount Antenna installed in the upper left side rear edge of the LCD display. Co-located within the Rugged Laptop PC was an Intel Pro 2200BG 802.11b/g WLAN Mini-PCI Card connected to a second Internal Surface-Mount Antenna installed in the upper right side rear edge of the LCD display. Photographs of the DUT placement and construction are shown in Appendix A.

Device:	Rugged Laptop PC		
Model:	IX260PROA580BT		
Serial Number:	ZZGEG4196ZZ6473		
Identifier(s):	FCC ID:	KBCIX260PROA580BT	IC: 1943A-IX260Pf
Power Source:	Delta Electronics Model ADP-90AB Rev B 90 Watt AC-DC power supply		

Device:	2.4GHz FHSS Bluetooth Transmitter		
Model:	Cirronet BT2022		
Serial Number:	n/a		
Rule Part(s):	FCC:	§15.247; §2.1091; §1.1310	IC: RSS-210 Issue 5
Classification:	FCC:	Part 15 Spread Spectrum Transmitter (DSS)	IC: Low Power Licence-Exempt Transmitter
Power Source:	Powered from the internal PC power supply		

Test Report Serial No.:	022305KBC-T618-E15W/B	Issue 1.0
Test Date(s):	01Oct04 - 14Oct04	
Test Type(s):	FCC §15.247	IC RSS-210 Issue 5
Lab Registration(s):	FCC #714830	IC Lab File #3874

Device:	2.4GHz DSSS WLAN Mini-PCI Card		
Model:	Intel Pro2200BG		
Serial Number:	06036C074ADC54906006		
Rule Part(s):	FCC: §15.247; §2.1091; §1.1310	IC:	RSS-210 Issue 5
Classification:	FCC: Digital Transmission System (DTS)	IC:	Low Power Licence-Exempt Transmitter
Power Source:	Powered from the internal PC power supply		

Device:	Internal Surface-Mount Antenna (Bluetooth - upper left side rear edge of the LCD display)		
Model:	RangeStar P/N: 100929		
Gain:	+4.5 dBi		

Device:	Internal Surface-Mount Antenna (WLAN - upper right side rear edge of the LCD display)		
Model:	RangeStar P/N: 100929		
Gain:	+4.5 dBi		

5.3 Co-Located Equipment

Device:	GPS Receiver Module with attached Antenna (Receive only)		
Model:	Leadtek P/N GPS9547		

5.4 Cable Descriptions

ROUTING		Length m	Model	Terminations		Shield Type	Shield Termination		Suppression
From	To			End 1	End 2		End 1	End 2	
PC Fire Wire Port	Unterminated	1.0	Copartner E119932	IEEE-1528	Fire wire	n/a	n/a	n/a	None
PC modem port	Unterminated	1.0	n/a	RJ-11	RJ-11	None	na	na	None
PC Ethernet Port	Ethernet Hub	1.0	n/a	RJ-45	RJ-45	None	na	na	None

5.5 Support Equipment

The following equipment was used in support of the DUT.

CO-LOCATED SUPPORT EQUIPMENT LIST		
MANUFACTURER	MODEL	DESCRIPTION
D-Link	DE-809TC/	Ethernet hub
YNG YUH	YP-040	Hub power supply
Mli	699	Speakers
Polk Audio	n/a	Speaker-microphone
DeLorme	Tripmate	GPS Receiver
Intel	CS-430	Camera
Logitech	M-S34	Mouse

5.6 Clock Frequencies

5.6.1 DUT Clock Frequencies

Device:	Rugged Laptop PC
Clocks:	1.6 GHz processor
Device:	2.4GHz FHSS Cirronet Bluetooth Transmitter
Clocks:	n/a
Device:	2.4GHz DSSS WLAN Mini-PCI Card (802.11b/g)
Clocks:	40 MHz, $f_0/1.5$ (Low – 1608.000 MHz, Mid – 1624.667 MHz, High – 1641.333 MHz)
Device:	Internal Dual Surface-Mount Antennas
Clocks:	None

5.6.2 Co-Located Clock Frequencies

Device:	Peripherals
Clocks:	n/a

Test Report Serial No.:	022305KBC-T618-E15W/B	Issue 1.0
Test Date(s):	01Oct04 - 14Oct04	
Test Type(s):	FCC §15.247	IC RSS-210 Issue 5
Lab Registration(s):	FCC #714830	IC Lab File #3874

5.7 Mode(s) of Operation Tested

5.7.1 Bluetooth Transmitter

Customer supplied software was used to place the Bluetooth Transmitter at the appropriate channel with the power level and modulation for the specific measurement.

TX Frequency Range:	2402 - 2480 MHz Ch. 0 (2402 MHz), Ch. 39 (2441 MHz) & Ch. 78 (2480 MHz) measured unless otherwise noted)
Software Power Gain Settings:	Ch. 0 - 250 /40 Ch. 39 - 250 /44 Ch. 78 - 220 /45
RF Peak Conducted Output Power Tested:	Ch. 0 - +15.40 dBm Ch. 39 - +15.61 dBm Ch. 78 - +15.34 dBm
Modulation Type(s):	GFSK 0.5 BT Gaussian
Modulation Frequency:	1000
Battery Type(s):	11.1V Lithium-Ion, 6.0Ah (Model: A2121-2)

5.7.2 WLAN Mini-PCI Card

TX Frequency Range:	2412 - 2462 MHz Ch. 1 (2412 MHz), Ch. 6 (2437 MHz) & Ch. 11 (2462 MHz) measured unless otherwise noted)	
Software Power Gain Settings:	802.11b set to 29 802.11g set to 24.5	
RF Peak Conducted Output Power Tested:	802.11b 2412 MHz(1 Mbps) = 16.28 dBm 802.11b 2437 MHz(1 Mbps) = 16.79 dBm 802.11b 2462 MHz(1 Mbps) = 17.48 dBm	802.11g 2412 MHz(6 Mbps) = 15.14 dBm 802.11g 2437 MHz(6 Mbps) = 15.55 dBm 802.11g 2462 MHz(6 Mbps) = 16.15 dBm
Modes / Data Rates Tested:	802.11b (1, 5.5, 11 Mbps checked in prescan) (1 Mbps determined to be worse case and used unless otherwise noted)	
	802.11g (6, 36, 54 Mbps checked in prescan) (6 Mbps determined to be worse case and used unless otherwise noted)	
Modulation Type(s):	OFDM with BPSK, QPSK, 16QAM, 64QAM, DBPSK, DQPSK, CCK	
Battery Type(s):	11.1V Lithium-Ion, 6.0Ah (Model: A2121-2)	

5.7.3 DUT Exercising Software Description

The DUT was configured and exercised using customer supplied test software that allowed an operator to set the parameters of the Bluetooth transmitter and WLAN Mini-PCI card operation. The settings used are described in each appendix. More specific information on the configuration and exercising can be found in the referenced single-transmit test reports.

Applicant:	Itronix Corporation	Model:	IX260PROA580BT	IC ID:	1943A-IX260Pf	FCC ID:	KBCIX260PROA580BT	
IX260+ Rugged Laptop PC with internal Intel Pro 2200BG 802.11b/g WLAN and Cirronet BT2022 Bluetooth								
2005 Celltech Labs Inc		This document is not to be reproduced in whole or in part without the written permission of Celltech Labs Inc.					10 of 42	

Test Report Serial No.:	022305KBC-T618-E15W/B	Issue 1.0
Test Date(s):	01Oct04 - 14Oct04	
Test Type(s):	FCC §15.247	IC RSS-210 Issue 5
Lab Registration(s):	FCC #714830	IC Lab File #3874

5.8 Configuration Description

The DUT was configured, as described by the client as being representative of what would be delivered to a final customer. More specific details may be included in each appendix.

5.8.1 Configuration Justification

The DUT was tested in a configuration described by the client as being worse case but typical of normal use.

6.0 PASS/FAIL CRITERIA

Unless otherwise noted in the Appendices, the pass/fail criteria is the limit set forth in the reference standards. A DUT is considered to have passed the requirements, if the data collected during the described measurement procedure is no greater than the specified limits as defined. The pass/fail statements made in this report only apply to the unit tested.

Applicant:	Itronix Corporation	Model:	IX260PROA580BT	IC ID:	1943A-IX260Pf	FCC ID:	KBCIX260PROA580BT	
IX260+ Rugged Laptop PC with internal Intel Pro 2200BG 802.11b/g WLAN and Cirronet BT2022 Bluetooth								
2005 Celltech Labs Inc		This document is not to be reproduced in whole or in part without the written permission of Celltech Labs Inc.					11 of 42	

Test Report Serial No.:	022305KBC-T618-E15W/B	Issue 1.0
Test Date(s):	01Oct04 - 14Oct04	
Test Type(s):	FCC §15.247	IC RSS-210 Issue 5
Lab Registration(s):	FCC #714830	IC Lab File #3874

APPENDICES

Applicant:	Itronix Corporation	Model:	IX260PROA580BT	IC ID:	1943A-IX260Pf	FCC ID:	KBCIX260PROA580BT
IX260+ Rugged Laptop PC with internal Intel Pro 2200BG 802.11b/g WLAN and Cirronet BT2022 Bluetooth							
2005 Celltech Labs Inc	This document is not to be reproduced in whole or in part without the written permission of Celltech Labs Inc.						12 of 42

Test Report Serial No.:	022305KBC-T618-E15W/B	Issue 1.0
Test Date(s):	01Oct04 - 14Oct04	
Test Type(s):	FCC §15.247	IC RSS-210 Issue 5
Lab Registration(s):	FCC #714830	IC Lab File #3874

Appendix A - DUT Photographs

Photograph A-1 - Front of Open IX260+ Laptop PC



Photograph A-2 - Back of Open IX260+ Laptop PC



Photograph A-3 - WLAN Mini-PCI Card Location

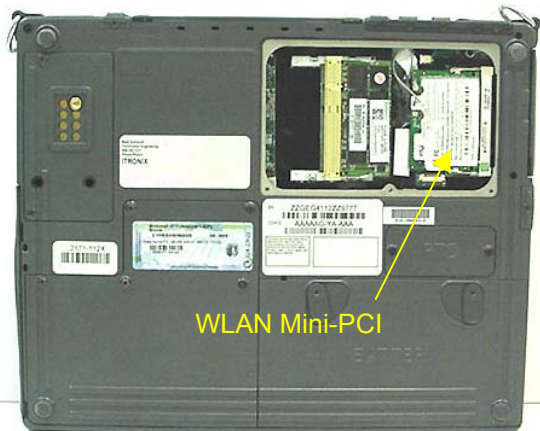

Photograph A-4 - Bluetooth Transmitter Location

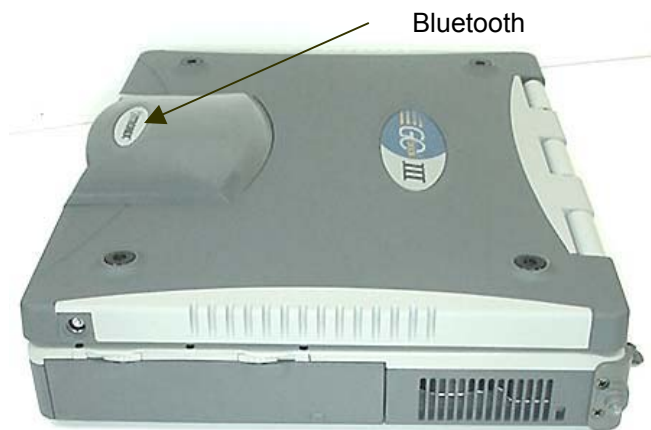

Applicant:	Itronix Corporation	Model:	IX260PROA580BT	IC ID:	1943A-IX260Pf	FCC ID:	KBCIX260PROA580BT	
IX260+ Rugged Laptop PC with internal Intel Pro 2200BG 802.11b/g WLAN and Cirronet BT2022 Bluetooth								
2005 Celltech Labs Inc		This document is not to be reproduced in whole or in part without the written permission of Celltech Labs Inc.					13 of 42	

Test Report Serial No.:	022305KBC-T618-E15W/B	Issue 1.0
Test Date(s):	01Oct04 - 14Oct04	
Test Type(s):	FCC §15.247	IC RSS-210 Issue 5
Lab Registration(s):	FCC #714830	IC Lab File #3874

Photograph A-5 - WLAN Mini-PCI Card



Photograph A-6 - Bluetooth Transmitter

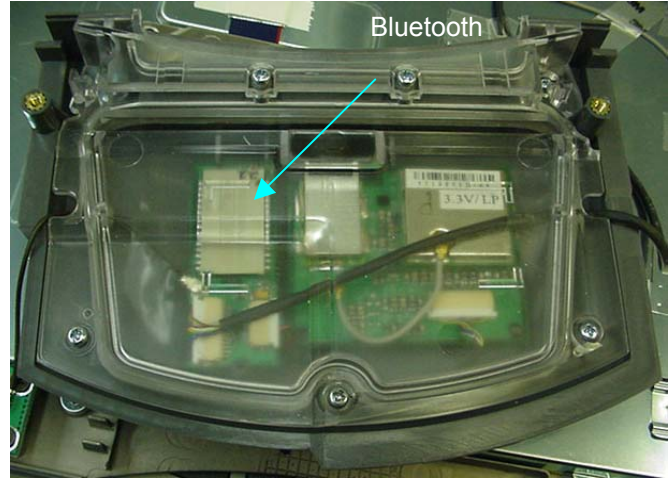

Photograph A-7 - Surface Mount Antenna Placement



Applicant:	Itronix Corporation	Model:	IX260PROA580BT	IC ID:	1943A-IX260Pf	FCC ID:	KBCIX260PROA580BT	
IX260+ Rugged Laptop PC with internal Intel Pro 2200BG 802.11b/g WLAN and Cirronet BT2022 Bluetooth								
2005 Celltech Labs Inc		This document is not to be reproduced in whole or in part without the written permission of Celltech Labs Inc.					14 of 42	

Test Report Serial No.:	022305KBC-T618-E15W/B	Issue 1.0
Test Date(s):	01Oct04 - 14Oct04	
Test Type(s):	FCC §15.247	IC RSS-210 Issue 5
Lab Registration(s):	FCC #714830	IC Lab File #3874

Appendix B - Conducted Powerline Emissions Measurement

B.1. REFERENCES

Normative Reference Standard	CFR 47 FCC Part 15 §15.207
Procedure Reference	ANSI C63.4

B.2. LIMITS

§15.207: Compliance with the provisions of this paragraph shall be based on the measurement of the radio frequency voltage between each powerline and ground at the power terminal.

Frequency of Emission (MHz)	Conducted Limit (dBuV)	
	Quasi-Peak	Average
0.15 – 0.5	66 to 56*	56 to 46*
0.50 – 5.0	56	46
5.0 – 30.0	60	50

*Decrease with the logarithm of the frequency

B.3. ENVIRONMENTAL CONDITIONS

Temperature	+26 ± 5 °C
Humidity	31 % ± 10% RH
Barometric Pressure	101.4 kpa

B.4. EQUIPMENT LIST

ASSET NUMBER	MANUFACTURER	MODEL	DESCRIPTION	LAST CAL	CAL DUE
00063	HP	85662A	Spectrum Analyzer Display	na	na
00051	HP	8566B	Spectrum Analyzer RF Section	18May04	18May05
00049	HP	85650A	Quasi-Peak Adapter	18May04	18May05
00047	HP	85685A	Preselector	18May04	18May05
00083	EMCO	3825/2	Line Impedance Stabilization Network	29Apr04	29Apr05
00084	EMCO	3825/2	Line Impedance Stabilization Network	29Apr04	29Apr05

Applicant:	Itronix Corporation	Model:	IX260PROA580BT	IC ID:	1943A-IX260Pf	FCC ID:	KBCIX260PROA580BT
IX260+ Rugged Laptop PC with internal Intel Pro 2200BG 802.11b/g WLAN and Cirronet BT2022 Bluetooth							
2005 Celltech Labs Inc		This document is not to be reproduced in whole or in part without the written permission of Celltech Labs Inc.					15 of 42

Test Report Serial No.:	022305KBC-T618-E15W/B	Issue 1.0
Test Date(s):	01Oct04 - 14Oct04	
Test Type(s):	FCC §15.247	IC RSS-210 Issue 5
Lab Registration(s):	FCC #714830	IC Lab File #3874

B.5. MEASUREMENT EQUIPMENT SETUP

MEASUREMENT EQUIPMENT CONNECTIONS	The conducted emissions were measured on each of the two AC powerline leads connected to the DUT's power supply brick. A two line LISN was used to make this measurement. A drawing of the equipment setup is shown in B.7
MEASUREMENT EQUIPMENT SETTINGS	<p>Each of the monitor ports from the 2-line LISN was connected in turn to the spectrum analyzer. The port not connected to the analyzer was terminated in a 50-ohm load. A pre-scan of the peak emission levels was made of the 150 kHz – 30 MHz range split into 4 equal frequency bands. The following were the instrumentation settings:</p> <p>Spectrum Analyzer: Start Frequency and Stop Frequency set by software for each of the four bands RBW: 100 kHz VBW: 300 kHz Sweep: 500 mS</p> <p>Quasi-Peak Adapter: Normal – Automatic Bandwidth Setting: 9 kHz</p> <p>The resulting data from each band was corrected and collected by software and presented in the graphical representations shown in B.9 for the two leads.</p> <p>A defined set of frequency points of interest on each lead were used by software to optimize a set of readings for each type of detector (peak, quasi-peak and average). This data was corrected by the software is presented in the tables shown in section B.9.</p>

Applicant:	Itronix Corporation	Model:	IX260PROA580BT	IC ID:	1943A-IX260Pf	FCC ID:	KBCIX260PROA580BT	
IX260+ Rugged Laptop PC with internal Intel Pro 2200BG 802.11b/g WLAN and Cirronet BT2022 Bluetooth								
2005 Celltech Labs Inc		This document is not to be reproduced in whole or in part without the written permission of Celltech Labs Inc.					16 of 42	

Test Report Serial No.:	022305KBC-T618-E15W/B	Issue 1.0
Test Date(s):	01Oct04 - 14Oct04	
Test Type(s):	FCC §15.247	IC RSS-210 Issue 5
Lab Registration(s):	FCC #714830	IC Lab File #3874

B.6. SETUP PHOTOS

Photograph B-1 - AC Powerline Conducted Emission Configuration



Photograph B-2 - AC Powerline Conducted Emission Cable Placement



Applicant:	Itronix Corporation	Model:	IX260PROA580BT	IC ID:	1943A-IX260Pf	FCC ID:	KBCIX260PROA580BT	
IX260+ Rugged Laptop PC with internal Intel Pro 2200BG 802.11b/g WLAN and Cirronet BT2022 Bluetooth								
2005 Celltech Labs Inc		This document is not to be reproduced in whole or in part without the written permission of Celltech Labs Inc.					17 of 42	

B.7. SETUP DRAWING

Figure B-1 - Setup Drawing

Conducted Emission Measurement Setup

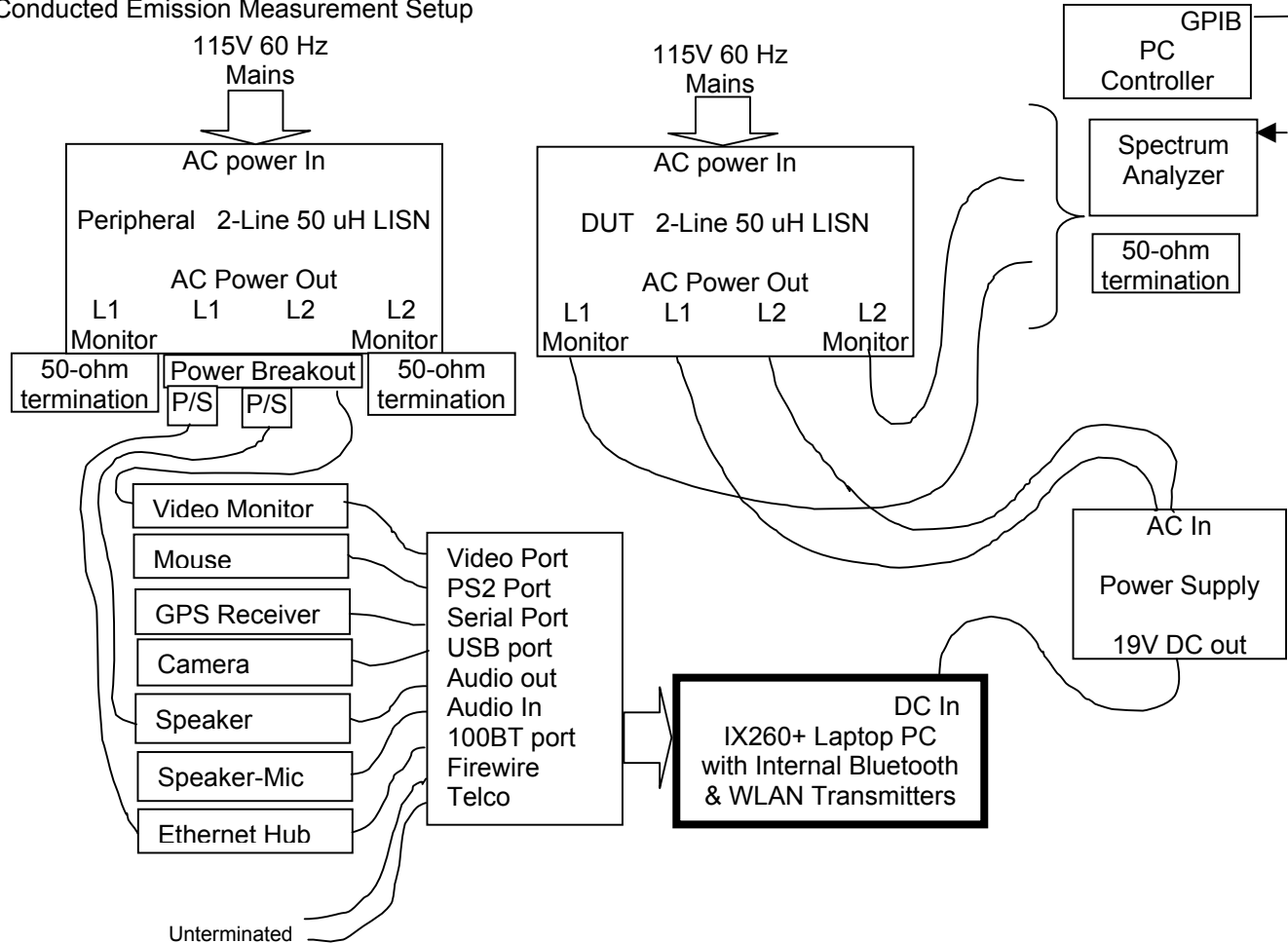



B.8. DUT OPERATING DESCRIPTION

Bluetooth	While hopping channels, the Bluetooth transmitter was set to transmit a data stream with a max. power setting equivalent to that described in the referenced single-transmit test report.
WLAN	The WLAN transmitter was set to transmit with a max. power setting equivalent to that described in the referenced single-transmit test report for 2462 MHz in Mode b.
PC	Other than operating the Bluetooth software and running MS windows, no PC exercising was performed.
Peripherals	All peripherals were active, but no specific traffic was initiated.

B.9. TEST RESULTS

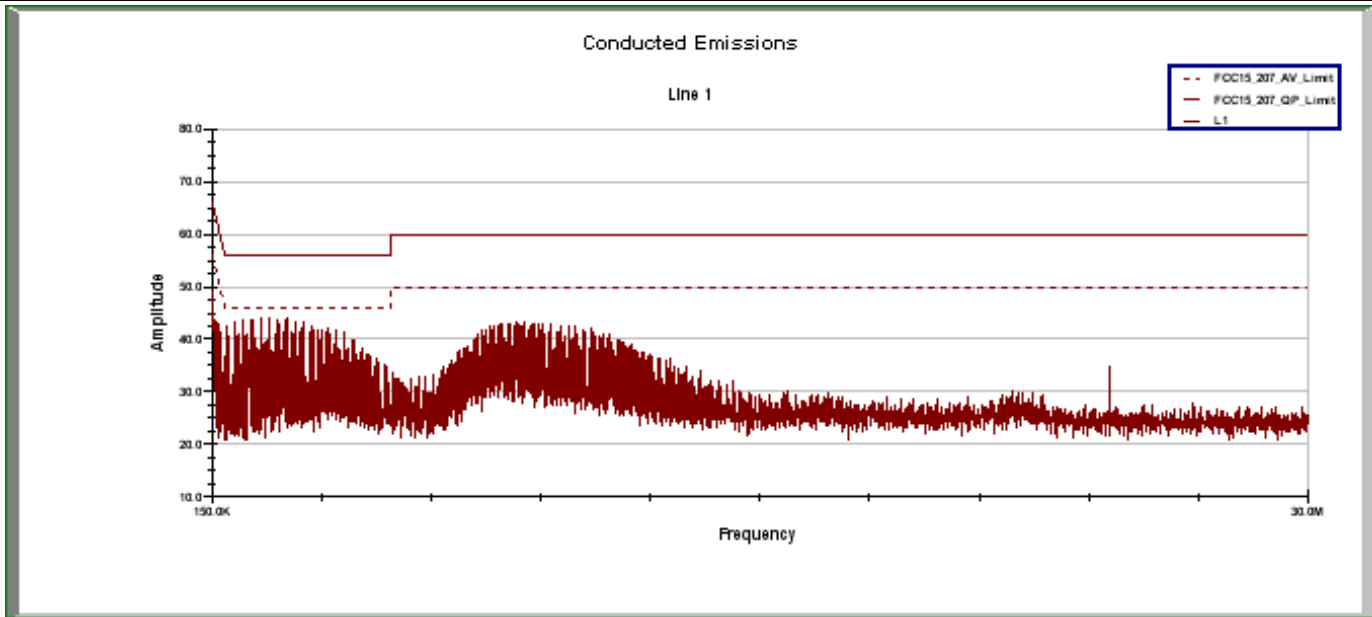
Following are peak emission plots and tabular data describing the peak, quasi-peak and average measurements made of the DUT.



	Project Number:	072804KBC-T543-E15W/B	Standard:	FCC 15.207								
	Company:	Itronix	Test Start Date:	14-Oct-04								
	Product:	IX260+ with Cirronet BT2022 Bluetooth & Intel 2200BG WLAN	Test End Date:	14-Oct-04								
Line 1 Conducted Emissions												
Frequency MHz	Uncorrected Reading			Correction Factor dB	Corrected Emission Level			Quasi-Peak Limit dBuV	Quasi-Peak Margin dB	Average Limit dBuV	Average Margin dB	Pass/Fail
	Peak dBuV	Quasi-Peak dBuV	Average dBuV		Peak dBuV	Quasi-Peak dBuV	Average dBuV					
0.157	50.00	47.74	46.20	2.01	52.01	49.75	48.21	65.63	15.88	55.63	7.42	Pass
1.486	43.90	43.36	43.47	0.29	44.19	43.65	43.76	56.00	12.35	46.00	2.24	Pass
1.722	44.10	43.44	43.48	0.28	44.39	43.73	43.77	56.00	12.28	46.00	2.24	Pass
8.523	43.60	42.16	38.61	0.32	43.92	42.48	38.93	60.00	17.52	50.00	11.07	Pass
Corrected Emission Level (dBuV) = Uncorrected Reading (dBuV) + Correction Factor (dB)												
Margin (dB) = Limit (dBuV) - Corrected Emission Level (dBuV)												

Test Report Serial No.:	022305KBC-T618-E15W/B	Issue 1.0
Test Date(s):	01Oct04 - 14Oct04	
Test Type(s):	FCC §15.247	IC RSS-210 Issue 5
Lab Registration(s):	FCC #714830	IC Lab File #3874

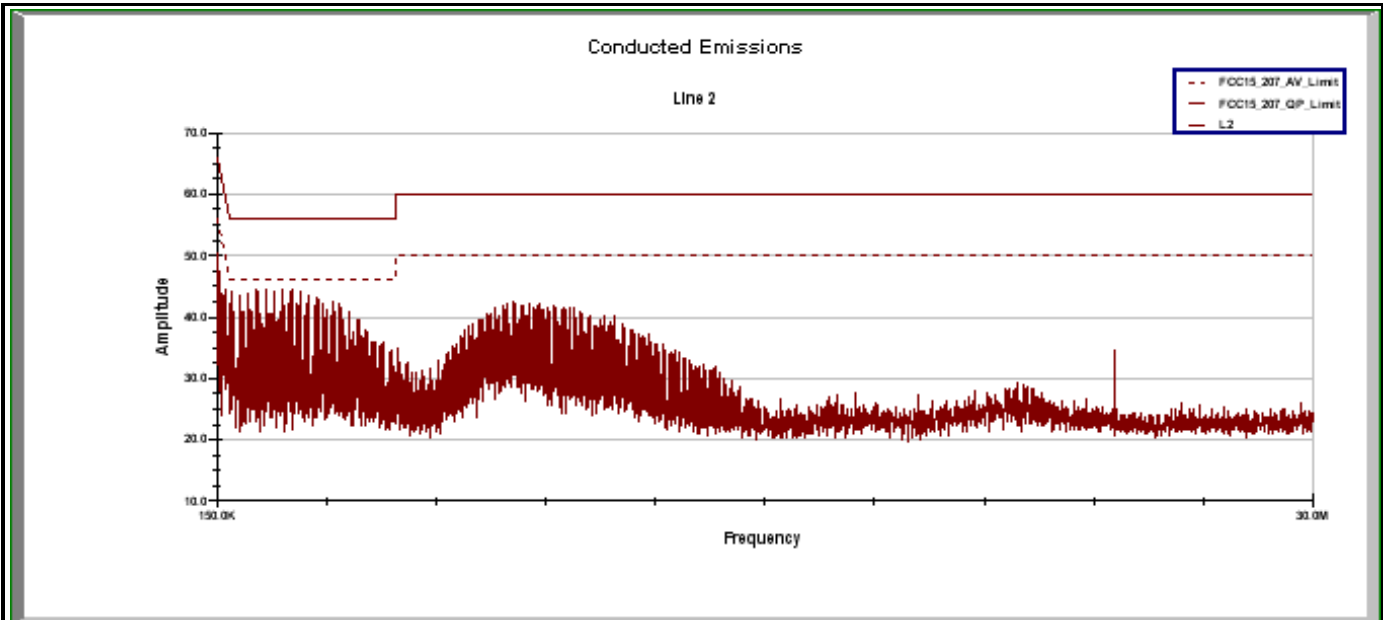

	Project Number:	072804KBC-T543-E15W/B	Standard:	FCC 15.207									
	Company:	Itronix	Test Start Date:	14-Oct-04									
	Product:	IX260+ with Cirronet BT2022 Bluetooth & Intel 2200BG WLAN	Test End Date:	14-Oct-04									
Line 2 Conducted Emissions													
Frequency MHz	Uncorrected Reading			Correction Factor dB	Corrected Emission Level			Quasi-Peak Limit dBuV	Quasi-Peak Margin dB	Average Limit dBuV	Average Margin dB	Pass/Fail	
	Peak dBuV	Quasi-Peak dBuV	Average dBuV		Peak dBuV	Quasi-Peak dBuV	Average dBuV						
0.158	51.70	47.94	47.30	1.99	53.69	49.93	49.29	65.55	15.61	55.55	6.26	Pass	
0.390	44.30	41.49	40.68	0.61	44.91	42.10	41.29	58.07	15.97	48.07	6.78	Pass	
1.251	44.10	43.42	43.55	0.31	44.41	43.73	43.85	56.00	12.27	46.00	2.15	Pass	
1.954	44.20	43.49	43.45	0.29	44.49	43.78	43.74	56.00	12.22	46.00	2.26	Pass	
8.212	42.50	41.68	40.17	0.33	42.83	42.01	40.50	60.00	17.99	50.00	9.50	Pass	
24.579	35.00	33.02	31.59	0.43	35.43	33.45	32.01	60.00	26.55	50.00	17.99	Pass	
Corrected Emission Level (dBuV) = Uncorrected Reading (dBuV) + Correction Factor (dB) Margin (dB) = Limit (dBuV) - Corrected Emission Level (dBuV)													

Applicant:	Itronix Corporation	Model:	IX260PROA580BT	IC ID:	1943A-IX260Pf	FCC ID:	KBCIX260PROA580BT
IX260+ Rugged Laptop PC with internal Intel Pro 2200BG 802.11b/g WLAN and Cirronet BT2022 Bluetooth							
2005 Celltech Labs Inc This document is not to be reproduced in whole or in part without the written permission of Celltech Labs Inc.							20 of 42

Test Report Serial No.:	022305KBC-T618-E15W/B	Issue 1.0
Test Date(s):	01Oct04 - 14Oct04	
Test Type(s):	FCC §15.247	IC RSS-210 Issue 5
Lab Registration(s):	FCC #714830	IC Lab File #3874

B.10. PASS/FAIL

In reference to the results outlined in B.9 the DUT passes the requirements as stated in the reference standards as follows:
The RF voltage measured in reference to ground on each of the power line conductors does not exceed the limits as outlined in FCC 15.207.

B.11. SIGN-OFF

I attest to the accuracy of the data. All measurements reported herein were performed by me and are correct to the best of my knowledge and belief. I assume full responsibility for the completeness of these measurements.



Duane M. Friesen, C.E.T.
EMC Manager
Celltech Labs Inc.

14Oct04
Date

Applicant:	Itronix Corporation	Model:	IX260PROA580BT	IC ID:	1943A-IX260Pf	FCC ID:	KBCIX260PROA580BT	
IX260+ Rugged Laptop PC with internal Intel Pro 2200BG 802.11b/g WLAN and Cirronet BT2022 Bluetooth								
2005 Celltech Labs Inc		This document is not to be reproduced in whole or in part without the written permission of Celltech Labs Inc.					21 of 42	

Test Report Serial No.:	022305KBC-T618-E15W/B	Issue 1.0
Test Date(s):	01Oct04 - 14Oct04	
Test Type(s):	FCC §15.247	IC RSS-210 Issue 5
Lab Registration(s):	FCC #714830	IC Lab File #3874

Appendix C - Radiated Spurious Emissions Measurement

C.1. REFERENCES

Normative Reference Standard	FCC CFR 47 §15.247I
Procedure Reference	ANSI C63.4; FCC 97-114

C.2. LIMITS

C.2.1. FCC CFR 47

§15.247 I: In any 100 kHz bandwidth outside the frequency band in which the spread spectrum or digitally modulated intentional radiator is operating, the radio frequency power that is produced by the intentional radiator shall be at least 20 dB below that in the 100 kHz bandwidth within the band that contains the highest level of desired power, based on either an RF conducted or a radiated measurement. Attenuation below the general limits specified in 15.209 (a) is not required.

Note: Spurious emissions within the restricted bands are reported in Appendix I.

C.3. ENVIRONMENTAL CONDITIONS

Temperature	27.4 +/- 2 °C
Humidity	33 +/- 2 %
Barometric Pressure	96.24 +/- 0.2 kPa

C.4. EQUIPMENT LIST

ASSET NUMBER	MANUFACTURER	MODEL	DESCRIPTION	LAST CAL	CAL DUE
00072	EMCO	2075	Mini-mast	n/a	n/a
00073	EMCO	2080	Turn Table	n/a	n/a
00071	EMCO	2090	Multi-Device Controller	n/a	n/a
00050	Chase	CBL-6111A	Bilog Antenna	30Apr04	30Apr05
00035	ETS	3115	Double Ridged Guide Horn	24Mar04	24Mar05
00202	ETS	3160-09	Small Horn Antenna	27May04	27Jun05
00015	Agilent	E4408B	Spectrum Analyzer	29Dec03	29Dec04
00049	HP	8566B	Spectrum Analyzer RF Section	18May04	18May05
00049	HP	85650A	Quasi-peak Adapter	18May04	18May05
00047	HP	85685A	RF Preselector	18May04	18May05
00048	Gore	65474	Microwave Cable	20May04	20May05
00030	HP	83017A	LNA	20May04	20May05

Applicant:	Itronix Corporation	Model:	IX260PROA580BT	IC ID:	1943A-IX260Pf	FCC ID:	KBCIX260PROA580BT
IX260+ Rugged Laptop PC with internal Intel Pro 2200BG 802.11b/g WLAN and Cirronet BT2022 Bluetooth							
2005 Celltech Labs Inc This document is not to be reproduced in whole or in part without the written permission of Celltech Labs Inc.							22 of 42

Test Report Serial No.:	022305KBC-T618-E15W/B	Issue 1.0
Test Date(s):	01Oct04 - 14Oct04	
Test Type(s):	FCC §15.247	IC RSS-210 Issue 5
Lab Registration(s):	FCC #714830	IC Lab File #3874

C.5. MEASUREMENT EQUIPMENT SETUP

MEASUREMENT EQUIPMENT CONNECTIONS	The measurement equipment was connected as shown in E.6. A number of antennas were used to cover the applicable frequency range test. The ranges in which each antenna was used are as follows:			
	Frequency Range	Antenna		
	30 MHz – 1 GHz	CBL-6111A Bilog		
	1 GHz – 18 GHz	ETS 3115 Horn		
	18 GHz – 26GHz	ETS 3160-09 Horn		
MEASUREMENT EQUIPMENT SETTINGS	The spectrum analyzer was set to the following settings:			
	Frequency Range	RBW	VBW	Detector
	MHz	kHz	kHz	
	30 – 1000	100	300	Peak*
	> 1000	1000*	1000	Peak*
*As a worse case measurement, the average limit was applied to measurements made with a peak detector using a RBW of 1 MHz (vs the specified 100 kHz), when possible.				

C.6. SETUP DRAWING

Figure C-1 - Setup Drawing

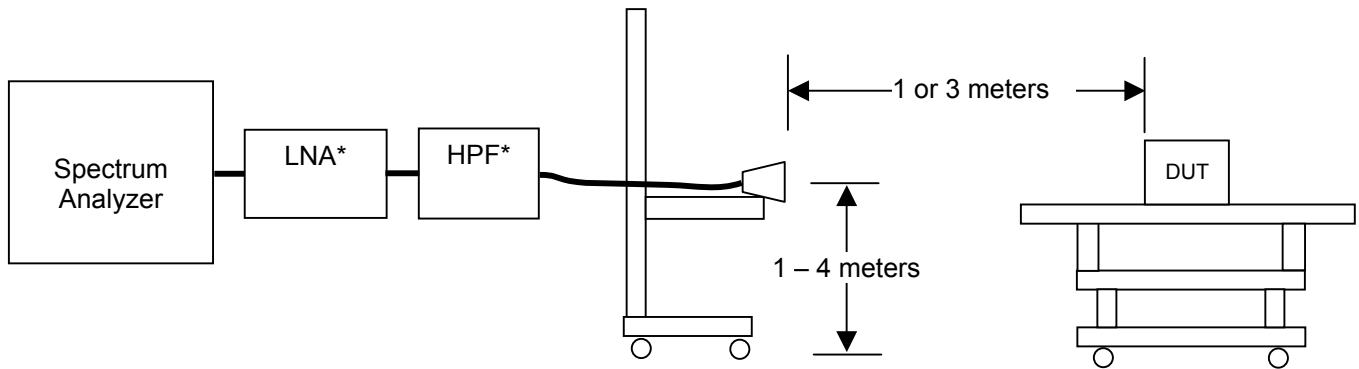

* Used for >1GHz

Applicant:	Itronix Corporation	Model:	IX260PROA580BT	IC ID:	1943A-IX260Pf	FCC ID:	KBCIX260PROA580BT	
IX260+ Rugged Laptop PC with internal Intel Pro 2200BG 802.11b/g WLAN and Cirronet BT2022 Bluetooth								
2005 Celltech Labs Inc		This document is not to be reproduced in whole or in part without the written permission of Celltech Labs Inc.					23 of 42	

Test Report Serial No.:	022305KBC-T618-E15W/B	Issue 1.0
Test Date(s):	01Oct04 - 14Oct04	
Test Type(s):	FCC §15.247	IC RSS-210 Issue 5
Lab Registration(s):	FCC #714830	IC Lab File #3874

C.7. SETUP PHOTOGRAPHS

Photograph C-1 - Loop Antenna (10kHz - 30MHz)



Photograph C-2 - Bilog Antenna (30MHz - 1 GHz)



Photograph C-3 - 3115 Horn Antenna

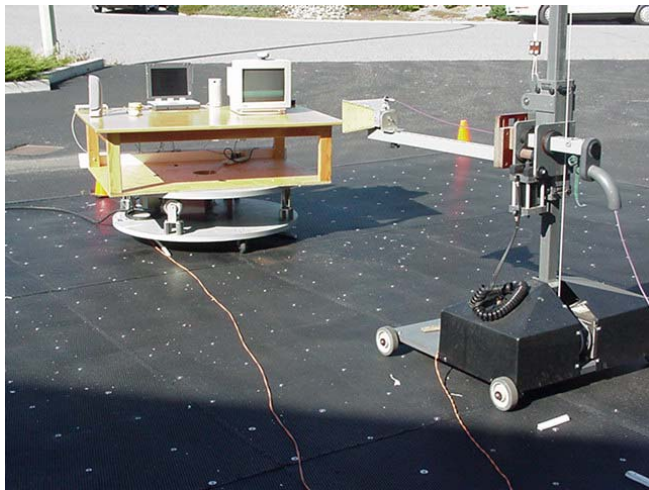

Photograph C-4 - 3160-09 Horn Antenna



C.8. DUT OPERATING DESCRIPTION

Measurements were made of the bands that may contain inter-modulation products with both the Bluetooth and WLAN radios transmitting. Measurements were made for each combination of channels with each radio transmission modulated and with power settings equivalent to those described in the referenced single-transmit test reports.

Applicant:	Itronix Corporation	Model:	IX260PROA580BT	IC ID:	1943A-IX260Pf	FCC ID:	KBCIX260PROA580BT	
IX260+ Rugged Laptop PC with internal Intel Pro 2200BG 802.11b/g WLAN and Cirronet BT2022 Bluetooth								
2005 Celltech Labs Inc		This document is not to be reproduced in whole or in part without the written permission of Celltech Labs Inc.					24 of 42	

Test Report Serial No.:	022305KBC-T618-E15W/B	Issue 1.0
Test Date(s):	01Oct04 - 14Oct04	
Test Type(s):	FCC §15.247	IC RSS-210 Issue 5
Lab Registration(s):	FCC #714830	IC Lab File #3874

C.9. TEST RESULTS

All significant inter-modulations products were measured as they related to the restricted band limit. This comparison was worst-case (versus an out of band emission limit comparison) and described in Appendix D of this report. All other spurious emissions are described in the appropriate sections in the individual reports referenced.

C.10. PASS/FAIL

In reference to the results outlined in D.9, the DUT passes the requirements as stated in the reference standards as follows:
 FCC 15.247 I: All emissions within any 100kHz bandwidth outside the operating frequency band are greater than 20 dB below the maximum 100 kHz bandwidth signal within the operating band.

C.11. SIGN-OFF

I attest to the accuracy of the data. All measurements reported herein were performed by me and are correct to the best of my knowledge and belief. I assume full responsibility for the completeness of these measurements.



Russell Pipe
 Senior Compliance Technologist
 Celltech Labs Inc.

14Oct04
 Date

Applicant:	Itronix Corporation	Model:	IX260PROA580BT	IC ID:	1943A-IX260Pf	FCC ID:	KBCIX260PROA580BT	
IX260+ Rugged Laptop PC with internal Intel Pro 2200BG 802.11b/g WLAN and Cirronet BT2022 Bluetooth								
2005 Celltech Labs Inc		This document is not to be reproduced in whole or in part without the written permission of Celltech Labs Inc.					25 of 42	

Test Report Serial No.:	022305KBC-T618-E15W/B	Issue 1.0
Test Date(s):	01Oct04 - 14Oct04	
Test Type(s):	FCC §15.247	IC RSS-210 Issue 5
Lab Registration(s):	FCC #714830	IC Lab File #3874

Appendix D - Restricted Band Emissions Measurement

D.1. REFERENCES

Normative Reference Standard	FCC CFR 47 §15.205 (a) (b), FCC CFR 47 §15.209 (a)
Procedure Reference	FCC 97-114

D.2. LIMITS

FCC CFR 47 §15.205	<i>(a) Except as shown in paragraph (d) of this section, only spurious emissions are permitted in any of the frequency bands listed below:</i>																																																																										
	<table border="1"> <thead> <tr> <th>MHz</th> <th>MHz</th> <th>MHz</th> <th>GHz</th> </tr> </thead> <tbody> <tr><td>0.090-0.110</td><td>16.42-16.423</td><td>399.9-410</td><td>4.5-5.15</td></tr> <tr><td>10.495-0.505</td><td>16.69475-16.69525</td><td>608-614</td><td>5.35-5.46</td></tr> <tr><td>2.1735-2.1905</td><td>16.80425-16.80475</td><td>960-1240</td><td>7.25-7.75</td></tr> <tr><td>4.125-4.128</td><td>25.5-25.67</td><td>1300-1427</td><td>8.025-8.5</td></tr> <tr><td>4.17725-4.17775</td><td>37.5-38.25</td><td>1435-1626.5</td><td>9.0-9.2</td></tr> <tr><td>4.20725-4.20775</td><td>73-74.6</td><td>1645.5-1646.5</td><td>9.3-9.5</td></tr> <tr><td>6.215-6.218</td><td>74.8-75.2</td><td>1660-1710</td><td>10.6-12.7</td></tr> <tr><td>6.26775-6.26825</td><td>108-121.94</td><td>1718.8-1722.2</td><td>13.25-13.4</td></tr> <tr><td>6.31175-6.31225</td><td>123-138</td><td>2200-2300</td><td>14.47-14.5</td></tr> <tr><td>8.291-8.294</td><td>149.9-150.05</td><td>2310-2390</td><td>15.35-16.2</td></tr> <tr><td>8.362-8.366</td><td>156.52475-156.52525</td><td>2483.5-2500</td><td>17.7-21.4</td></tr> <tr><td>8.37625-8.38675</td><td>156.7-156.9</td><td>2655-2900</td><td>22.01-23.12</td></tr> <tr><td>8.41425-8.41475</td><td>162.0125-167.17</td><td>3260-3267</td><td>23.6-24.0</td></tr> <tr><td>12.29-12.293</td><td>167.72-173.2</td><td>3332-3339</td><td>31.2-31.8</td></tr> <tr><td>12.51975-12.52025</td><td>240-285</td><td>3345.8-3358</td><td>36.43-36.5</td></tr> <tr><td>12.57675-12.57725</td><td>322-335.4</td><td>3600-4400</td><td>(2)</td></tr> <tr><td>13.36-13.41</td><td></td><td></td><td></td></tr> </tbody> </table>	MHz	MHz	MHz	GHz	0.090-0.110	16.42-16.423	399.9-410	4.5-5.15	10.495-0.505	16.69475-16.69525	608-614	5.35-5.46	2.1735-2.1905	16.80425-16.80475	960-1240	7.25-7.75	4.125-4.128	25.5-25.67	1300-1427	8.025-8.5	4.17725-4.17775	37.5-38.25	1435-1626.5	9.0-9.2	4.20725-4.20775	73-74.6	1645.5-1646.5	9.3-9.5	6.215-6.218	74.8-75.2	1660-1710	10.6-12.7	6.26775-6.26825	108-121.94	1718.8-1722.2	13.25-13.4	6.31175-6.31225	123-138	2200-2300	14.47-14.5	8.291-8.294	149.9-150.05	2310-2390	15.35-16.2	8.362-8.366	156.52475-156.52525	2483.5-2500	17.7-21.4	8.37625-8.38675	156.7-156.9	2655-2900	22.01-23.12	8.41425-8.41475	162.0125-167.17	3260-3267	23.6-24.0	12.29-12.293	167.72-173.2	3332-3339	31.2-31.8	12.51975-12.52025	240-285	3345.8-3358	36.43-36.5	12.57675-12.57725	322-335.4	3600-4400	(2)	13.36-13.41					
MHz	MHz	MHz	GHz																																																																								
0.090-0.110	16.42-16.423	399.9-410	4.5-5.15																																																																								
10.495-0.505	16.69475-16.69525	608-614	5.35-5.46																																																																								
2.1735-2.1905	16.80425-16.80475	960-1240	7.25-7.75																																																																								
4.125-4.128	25.5-25.67	1300-1427	8.025-8.5																																																																								
4.17725-4.17775	37.5-38.25	1435-1626.5	9.0-9.2																																																																								
4.20725-4.20775	73-74.6	1645.5-1646.5	9.3-9.5																																																																								
6.215-6.218	74.8-75.2	1660-1710	10.6-12.7																																																																								
6.26775-6.26825	108-121.94	1718.8-1722.2	13.25-13.4																																																																								
6.31175-6.31225	123-138	2200-2300	14.47-14.5																																																																								
8.291-8.294	149.9-150.05	2310-2390	15.35-16.2																																																																								
8.362-8.366	156.52475-156.52525	2483.5-2500	17.7-21.4																																																																								
8.37625-8.38675	156.7-156.9	2655-2900	22.01-23.12																																																																								
8.41425-8.41475	162.0125-167.17	3260-3267	23.6-24.0																																																																								
12.29-12.293	167.72-173.2	3332-3339	31.2-31.8																																																																								
12.51975-12.52025	240-285	3345.8-3358	36.43-36.5																																																																								
12.57675-12.57725	322-335.4	3600-4400	(2)																																																																								
13.36-13.41																																																																											
	¹ Until February 1, 1999, this restricted band shall be 0.490-0.510 MHz. ² Above 38.6																																																																										
	<i>(b) Except as provided in paragraphs (d) and (e), the field strength of emissions appearing within these frequency bands shall not exceed the limits shown in 15.209. At frequencies equal to or less than 1000 MHz, compliance with the limits in Section 15.209 shall be demonstrated using measurement instrumentation employing a CISPR quasi-peak detector. Above 1000 MHz, compliance with the emission limits in Section 15.209 shall be demonstrated based on the average value of the measured emissions. The provisions of 15.35 apply to these measurements.</i>																																																																										
FCC CFR 47 §15.209	<i>(a) Except as provided elsewhere in this Subpart, the emissions from an intentional radiator shall not exceed the field strength levels specified in the following table:</i>																																																																										
	<table border="1"> <thead> <tr> <th>Frequency</th> <th>Field Strength</th> <th>Measurement Distance</th> </tr> <tr> <th>MHz</th> <th>uV/m</th> <th>Meters</th> </tr> </thead> <tbody> <tr><td>.009 – 0.490</td><td>2400/F(kHz)</td><td>300</td></tr> <tr><td>0.490 – 1.705</td><td>24000/F(kHz)</td><td>30</td></tr> <tr><td>1.705 – 30.0</td><td>30</td><td>30</td></tr> <tr><td>30 – 88</td><td>100</td><td>3</td></tr> <tr><td>88 – 216</td><td>150</td><td>3</td></tr> <tr><td>216 – 960</td><td>200</td><td>3</td></tr> <tr><td>Above 960</td><td>500</td><td>3</td></tr> </tbody> </table>	Frequency	Field Strength	Measurement Distance	MHz	uV/m	Meters	.009 – 0.490	2400/F(kHz)	300	0.490 – 1.705	24000/F(kHz)	30	1.705 – 30.0	30	30	30 – 88	100	3	88 – 216	150	3	216 – 960	200	3	Above 960	500	3																																															
Frequency	Field Strength	Measurement Distance																																																																									
MHz	uV/m	Meters																																																																									
.009 – 0.490	2400/F(kHz)	300																																																																									
0.490 – 1.705	24000/F(kHz)	30																																																																									
1.705 – 30.0	30	30																																																																									
30 – 88	100	3																																																																									
88 – 216	150	3																																																																									
216 – 960	200	3																																																																									
Above 960	500	3																																																																									
	<i>(b) In the emission table above, the tighter limit applies at the band edges.</i>																																																																										

Test Report Serial No.:	022305KBC-T618-E15W/B	Issue 1.0
Test Date(s):	01Oct04 - 14Oct04	
Test Type(s):	FCC §15.247	IC RSS-210 Issue 5
Lab Registration(s):	FCC #714830	IC Lab File #3874

ENVIRONMENTAL CONDITIONS

Temperature	27.4 +/- 2 °C
Humidity	33 +/- 2 %
Barometric Pressure	96.24 +/- 0.2 kPa

EQUIPMENT LIST

ASSET NUMBER	MANUFACTURER	MODEL	DESCRIPTION	LAST CAL	CAL DUE
00072	EMCO	2075	Mini-mast	n/a	n/a
00073	EMCO	2080	Turn Table	n/a	n/a
00071	EMCO	2090	Multi-Device Controller	n/a	n/a
00085	EMCO	6502	Loop Antenna	10Aug04	10Aug05
00050	Chase	CBL-6111A	Bilog Antenna	30Apr04	30Apr05
00035	ETS	3115	Double Ridged Guide Horn	24Mar04	24Mar05
00202	ETS	3160-09	Small Horn Antenna	27May04	27Jun05
00015	Agilent	E4408B	Spectrum Analyzer	29Dec03	29Dec04
00049	HP	8566B	Spectrum Analyzer RF Section	18May04	18May05
00049	HP	85650A	Quasi-peak Adapter	18May04	18May05
00047	HP	85685A	RF Preselector	18May04	18May05
00048	Gore	65474	Microwave Cable	20May04	20May05
00030	HP	83017A	LNA	20May04	20May05

Applicant:	Itronix Corporation	Model:	IX260PROA580BT	IC ID:	1943A-IX260Pf	FCC ID:	KBCIX260PROA580BT
IX260+ Rugged Laptop PC with internal Intel Pro 2200BG 802.11b/g WLAN and Cirronet BT2022 Bluetooth							
2005 Celltech Labs Inc This document is not to be reproduced in whole or in part without the written permission of Celltech Labs Inc.							27 of 42

Test Report Serial No.:	022305KBC-T618-E15W/B	Issue 1.0
Test Date(s):	01Oct04 - 14Oct04	
Test Type(s):	FCC §15.247	IC RSS-210 Issue 5
Lab Registration(s):	FCC #714830	IC Lab File #3874

D.5. MEASUREMENT EQUIPMENT SETUP

MEASUREMENT EQUIPMENT CONNECTIONS	The measurement equipment was connected as shown in F.6. A number of antennas were used to cover the applicable frequency range test. The ranges in which each antenna was used are as follows:			
	Frequency Range		Antenna	
	9 kHz – 150 kHz		LP-105 Loop	
	150 kHz – 30 MHz		LG-105 Loop	
	30 MHz – 1 GHz		CBL-6111A Bilog	
	1 GHz – 18 GHz		ETS 3115 Horn	
MEASUREMENT EQUIPMENT SETTINGS	18 GHz– 26GHz			
	The spectrum analyzer was set to the following settings:			
	Frequency Range	RBW	VBW	Detector
	MHz	kHz	kHz	
	0.009 – 0.150	0.200	10	Peak*
	0.150 – 30	9	30	Peak*
30 – 1000	100	300	Peak*	
> 1000	1000*	1000	Peak*	
*As a worse case measurement, the average/quasi-peak limits were applied to measurements made with a peak detector.				

D.6. SETUP DRAWING

Figure D-1 - Setup Drawing

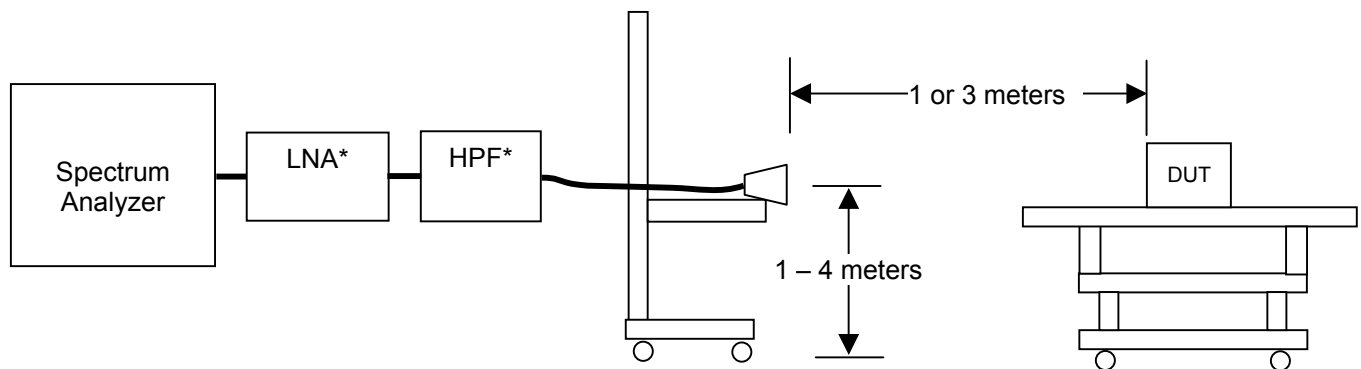

* Used for >1GHz

Test Report Serial No.:	022305KBC-T618-E15W/B	Issue 1.0
Test Date(s):	01Oct04 - 14Oct04	
Test Type(s):	FCC §15.247	IC RSS-210 Issue 5
Lab Registration(s):	FCC #714830	IC Lab File #3874

D.7. SETUP PHOTOGRAPHS

Photograph D-1 - Horizontal Polarization
(30MHz - 1 GHz)

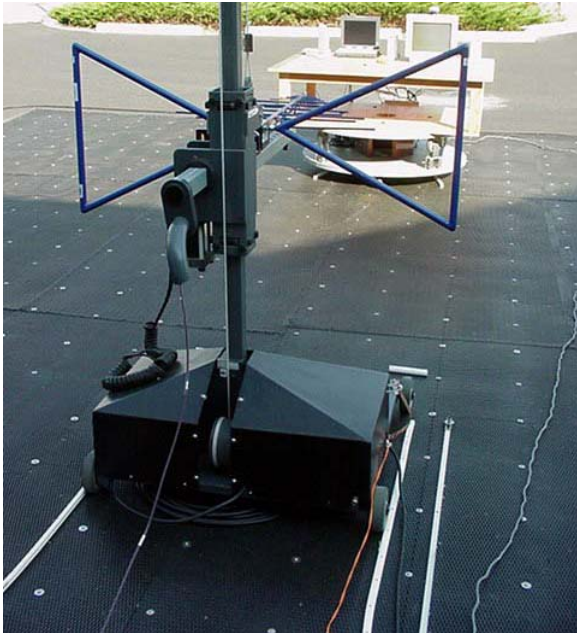

Photograph D-2 - Vertical Polarization
(30MHz - 1 GHz)



Photograph D-3 - Front of Radiated Emission
Configuration



Photograph D-4 - Back of Radiated Emission
Configuration

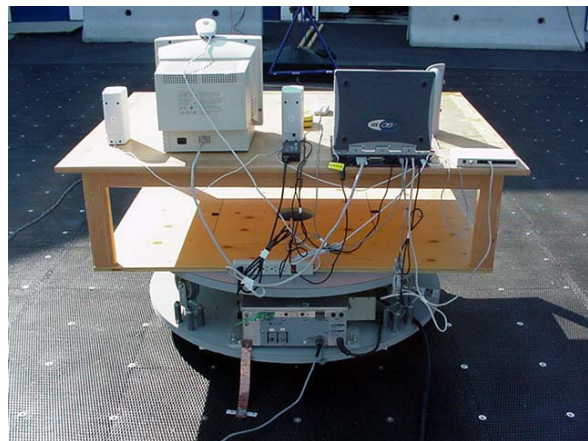

Applicant:	Itronix Corporation	Model:	IX260PROA580BT	IC ID:	1943A-IX260Pf	FCC ID:	KBCIX260PROA580BT	
IX260+ Rugged Laptop PC with internal Intel Pro 2200BG 802.11b/g WLAN and Cirronet BT2022 Bluetooth								
2005 Celltech Labs Inc		This document is not to be reproduced in whole or in part without the written permission of Celltech Labs Inc.					29 of 42	

Test Report Serial No.:	022305KBC-T618-E15W/B	Issue 1.0
Test Date(s):	01Oct04 - 14Oct04	
Test Type(s):	FCC §15.247	IC RSS-210 Issue 5
Lab Registration(s):	FCC #714830	IC Lab File #3874

D.8. DUT OPERATING DESCRIPTION

Measurements were made of the bands that may contain inter-modulation products with both the Bluetooth and WLAN radios transmitting. Each combination of channels with each radio transmission modulated and with power settings equivalent to those described in the referenced single-transmit test reports was tested. The fundamental carrier power for each radio, as well as those of the inter-modulation products of interest were recorded. A matrix of the channel combinations investigated is outlined below:

Bluetooth Frequency	WLAN Frequency	Lower InterMod of Interest	Frequency Checked	Comment
MHz	MHz	MHz	MHz	
2402	2412	2392	2392	out-of-band (restricted limit applied)
2402	2437	2367	2367	restricted band 2310-2390
2402	2462	2342	2342	restricted band 2310-2390
2441	2412	2383	2383	restricted band 2310-2390
2441	2437	2433	2390	out-of-band (band-edge checked)
2441	2462	2420	2390	out-of-band (band-edge checked)
2480	2412	2344	2344	restricted band 2310-2390
2480	2437	2394	2390	out-of-band (band-edge checked)
2480	2462	2444	2390	out-of-band (band-edge checked)

Bluetooth Frequency	WLAN Frequency	Upper InterMod of Interest	Frequency Checked	Comment
MHz	MHz	MHz	MHz	
2402	2412	2422	2483.5	out-of-band (band-edge checked)
2402	2437	2472	2483.5	out-of-band (band-edge checked)
2402	2462	2522	2522	out-of-band (restricted limit applied)
2441	2412	2470	2483.5	out-of-band (band-edge checked)
2441	2437	2445	2483.5	out-of-band (band-edge checked)
2441	2462	2483	2483	out-of-band (restricted limit applied)
2480	2412	2548	2548	out-of-band (restricted limit applied)
2480	2437	2523	2523	out-of-band (restricted limit applied)
2480	2462	2498	2498	restricted band 2483.5-2500

Test Report Serial No.:	022305KBC-T618-E15W/B	Issue 1.0
Test Date(s):	01Oct04 - 14Oct04	
Test Type(s):	FCC §15.247	IC RSS-210 Issue 5
Lab Registration(s):	FCC #714830	IC Lab File #3874

D.9. TEST RESULTS

D.9.1. Low Bluetooth Channel Carrier Field Strength @ Specified Distance



Project Number: 072804KBC-T543-E15W/B
 Company: Itronix
 Product: IX260+ with Co-Transmitting Bluetooth and WLAN

Standard: FCC15.247a
 Test Start Date: 04Oct04
 Test End Date: 12Oct04

Bluetooth CH 0 (2402 MHz) co-transmitting with WLAN Carrier Field Strengths																		
Co-transmit Channel	Polarity	Measurement Distance	Antenna	Carrier Freq	SA Level	Noise Floor	AF	CL	Other	*Duty Cycle Correction	Total CF	Field Strength	Detector	Limit Distance	Limit Distance Correction	Calculated Limit	Margin	Pass/Fail
							dB/m	dB	dB	dB	dB/m	dBuV/m						
Bluetooth Carrier Field Strengths with WLAN Mode b Co-Transmitting																		
WLAN-2412b	H	3	Horn SN6276	2402.15	102.90		30.24	3.48	-36.56	0.00	-2.84	100.06	PK	3	0.00	116.20	16.14	PASS
WLAN-2437b	H	3	Horn SN6276	2402.18	104.70		30.24	3.48	-36.56	0.00	-2.84	101.86	PK	3	0.00	116.20	14.34	PASS
WLAN-2462b	H	3	Horn SN6276	2402.27	103.00		30.24	3.48	-36.56	0.00	-2.84	100.16	PK	3	0.00	116.20	16.04	PASS
WLAN-2412b	V	3	Horn SN6276	2402.00	96.90		30.24	3.48	-36.56	0.00	-2.84	94.06	PK	3	0.00	116.20	22.14	PASS
WLAN-2437b	V	3	Horn SN6276	2402.24	96.80		30.24	3.48	-36.56	0.00	-2.84	93.96	PK	3	0.00	116.20	22.24	PASS
WLAN-2462b	V	3	Horn SN6276	2402.16	96.80		30.24	3.48	-36.56	0.00	-2.84	93.96	PK	3	0.00	116.20	22.24	PASS
WLAN Mode b Carrier Field Strengths with Bluetooth Co-Transmitting																		
WLAN-2412b	H	3	Horn SN6276	2412.92	93.20		30.26	3.49	-36.55	0.00	-2.80	90.40	PK	3	0.00	116.20	25.80	PASS
WLAN-2437b	H	3	Horn SN6276	2435.95	93.60		30.30	3.51	-36.51	0.00	-2.71	90.89	PK	3	0.00	116.20	25.31	PASS
WLAN-2462b	H	3	Horn SN6276	2462.93	94.60		30.34	3.52	-36.47	0.00	-2.62	91.98	PK	3	0.00	116.20	24.21	PASS
WLAN-2412b	V	3	Horn SN6276	2412.92	89.50		30.26	3.49	-36.55	0.00	-2.80	86.70	PK	3	0.00	116.20	29.50	PASS
WLAN-2437b	V	3	Horn SN6276	2435.90	86.80		30.30	3.51	-36.51	0.00	-2.71	84.09	PK	3	0.00	116.20	32.11	PASS
WLAN-2462b	V	3	Horn SN6276	2463.01	88.40		30.34	3.52	-36.47	0.00	-2.62	85.78	PK	3	0.00	116.20	30.41	PASS
Bluetooth Carrier Field Strengths with WLAN Mode g Co-Transmitting																		
WLAN-2412g	H	3	Horn SN6276	2402.21	103.00		30.24	3.48	-36.56	0.00	-2.84	100.16	PK	3	0.00	116.20	16.04	PASS
WLAN-2437g	H	3	Horn SN6276	2402.20	101.20		30.24	3.48	-36.56	0.00	-2.84	98.36	PK	3	0.00	116.20	17.84	PASS
WLAN-2462g	H	3	Horn SN6276	2402.25	102.00		30.24	3.48	-36.56	0.00	-2.84	99.16	PK	3	0.00	116.20	17.04	PASS
WLAN-2412g	V	3	Horn SN6276	2402.23	97.30		30.24	3.48	-36.56	0.00	-2.84	94.46	PK	3	0.00	116.20	21.74	PASS
WLAN-2437g	V	3	Horn SN6276	2402.23	97.00		30.24	3.48	-36.56	0.00	-2.84	94.16	PK	3	0.00	116.20	22.04	PASS
WLAN-2462g	V	3	Horn SN6276	2402.27	95.90		30.24	3.48	-36.56	0.00	-2.84	93.06	PK	3	0.00	116.20	23.14	PASS
WLAN Mode g Carrier Field Strengths with Bluetooth Co-Transmitting																		
WLAN-2412g	H	3	Horn SN6276	2414.83	93.30		30.26	3.49	-36.55	0.00	-2.79	90.51	PK	3	0.00	116.20	25.69	PASS
WLAN-2437g	H	3	Horn SN6276	2440.85	90.50		30.31	3.51	-36.51	0.00	-2.69	87.81	PK	3	0.00	116.20	28.39	PASS
WLAN-2462g	H	3	Horn SN6276	2463.21	93.30		30.34	3.52	-36.47	0.00	-2.61	90.69	PK	3	0.00	116.20	25.51	PASS
WLAN-2412g	V	3	Horn SN6276	2409.82	85.10		30.26	3.49	-36.55	0.00	-2.81	82.29	PK	3	0.00	116.20	33.91	PASS
WLAN-2437g	V	3	Horn SN6276	2436.98	85.80		30.30	3.51	-36.51	0.00	-2.70	83.10	PK	3	0.00	116.20	33.10	PASS
WLAN-2462g	V	3	Horn SN6276	2463.38	87.50		30.34	3.52	-36.47	0.00	-2.61	84.89	PK	3	0.00	116.20	31.31	PASS

Formulae:

Total CF = AF + CL + Other

Field Strength = SA Level + Total CF

*Worst case Duty Cycle of 100% used

Applicant:	Itronix Corporation	Model:	IX260PROA580BT	IC ID:	1943A-IX260Pf	FCC ID:	KBCIX260PROA580BT	
IX260+ Rugged Laptop PC with internal Intel Pro 2200BG 802.11b/g WLAN and Cirronet BT2022 Bluetooth								
2005 Celltech Labs Inc This document is not to be reproduced in whole or in part without the written permission of Celltech Labs Inc.							31 of 42	

Test Report Serial No.:	022305KBC-T618-E15W/B	Issue 1.0
Test Date(s):	01Oct04 - 14Oct04	
Test Type(s):	FCC §15.247	IC RSS-210 Issue 5
Lab Registration(s):	FCC #714830	IC Lab File #3874

D.9.2. Mid Bluetooth Channel Carrier Field Strength @ Specified Distance

Project Number: 072804KBC-T543-E15W/B **Standard:** FCC15.247a
Company: Itronix **Test Start Date:** 04Oct04
Product: IX260+ with Co-Transmitting Bluetooth and WLAN **Test End Date:** 12Oct04

Bluetooth CH 39 (2441 MHz) co-transmitting with WLAN Carrier Field Strengths																		
Co-transmit Channel	Polarity	Measurement Distance	Antenna	Carrier Freq	SA Level	Noise Floor	AF	CL	Other	*Duty Cycle Correction	Total CF	Field Strength	Detector	Limit Distance	Limit Distance Correction	Calculated Limit	Margin	Pass/Fail
							dB/m	dB	dB	dB	dB/m	dBuV/m		m	dB	dBuV/m	dB	
Bluetooth Carrier Field Strengths with WLAN Mode b Co-Transmitting																		
WLAN-2412b	H	3	Horn SN6276	2441.29	102.80		30.31	3.51	-36.51	0.00	-2.69	100.11	PK	3	0.00	116.20	16.09	PASS
WLAN-2437b	H	3	Horn SN6276	2441.24	104.40		30.31	3.51	-36.51	0.00	-2.69	101.71	PK	3	0.00	116.20	14.49	PASS
WLAN-2462b	H	3	Horn SN6276	2441.22	102.50		30.31	3.51	-36.51	0.00	-2.69	99.81	PK	3	0.00	116.20	16.39	PASS
WLAN-2412b	V	3	Horn SN6276	2441.22	96.70		30.31	3.51	-36.51	0.00	-2.69	94.01	PK	3	0.00	116.20	22.19	PASS
WLAN-2437b	V	3	Horn SN6276	2441.19	96.60		30.31	3.51	-36.51	0.00	-2.69	93.91	PK	3	0.00	116.20	22.29	PASS
WLAN-2462b	V	3	Horn SN6276	2441.20	95.20		30.31	3.51	-36.51	0.00	-2.69	92.51	PK	3	0.00	116.20	23.69	PASS
WLAN Mode b Carrier Field Strengths with Bluetooth Co-Transmitting																		
WLAN-2412b	H	3	Horn SN6276	2412.91	91.20		30.26	3.49	-36.55	0.00	-2.80	88.40	PK	3	0.00	116.20	27.80	PASS
WLAN-2437b	H	3	Horn SN6276	2436.03	93.90		30.30	3.51	-36.51	0.00	-2.71	91.19	PK	3	0.00	116.20	25.01	PASS
WLAN-2462b	H	3	Horn SN6276	2463.21	94.90		30.34	3.52	-36.47	0.00	-2.61	92.29	PK	3	0.00	116.20	23.91	PASS
WLAN-2412b	V	3	Horn SN6276	2412.86	88.80		30.26	3.49	-36.55	0.00	-2.80	86.00	PK	3	0.00	116.20	30.20	PASS
WLAN-2437b	V	3	Horn SN6276	2436.08	88.20		30.30	3.51	-36.51	0.00	-2.71	85.49	PK	3	0.00	116.20	30.71	PASS
WLAN-2462b	V	3	Horn SN6276	2461.00	88.00		30.34	3.52	-36.48	0.00	-2.62	85.38	PK	3	0.00	116.20	30.82	PASS
Bluetooth Carrier Field Strengths with WLAN Mode g Co-Transmitting																		
WLAN-2412g	H	3	Horn SN6276	2441.18	104.20		30.31	3.51	-36.51	0.00	-2.69	101.51	PK	3	0.00	116.20	14.69	PASS
WLAN-2437g	H	3	Horn SN6276	2441.18	104.70		30.31	3.51	-36.51	0.00	-2.69	102.01	PK	3	0.00	116.20	14.19	PASS
WLAN-2462g	H	3	Horn SN6276	2441.20	102.50		30.31	3.51	-36.51	0.00	-2.69	99.81	PK	3	0.00	116.20	16.39	PASS
WLAN-2412g	V	3	Horn SN6276	2441.18	96.60		30.31	3.51	-36.51	0.00	-2.69	93.91	PK	3	0.00	116.20	22.29	PASS
WLAN-2437g	V	3	Horn SN6276	2441.25	98.70		30.31	3.51	-36.51	0.00	-2.69	96.01	PK	3	0.00	116.20	20.19	PASS
WLAN-2462g	V	3	Horn SN6276	2441.22	96.80		30.31	3.51	-36.51	0.00	-2.69	94.11	PK	3	0.00	116.20	22.09	PASS
WLAN Mode g Carrier Field Strengths with Bluetooth Co-Transmitting																		
WLAN-2412g	H	3	Horn SN6276	2413.75	93.60		30.26	3.49	-36.55	0.00	-2.80	90.80	PK	3	0.00	116.20	25.39	PASS
WLAN-2437g	H	3	Horn SN6276	2436.45	93.30		30.30	3.51	-36.51	0.00	-2.71	90.59	PK	3	0.00	116.20	25.60	PASS
WLAN-2462g	H	3	Horn SN6276	2465.41	93.30		30.34	3.52	-36.47	0.00	-2.61	90.69	PK	3	0.00	116.20	25.51	PASS
WLAN-2412g	V	3	Horn SN6276	2414.22	87.60		30.26	3.49	-36.55	0.00	-2.79	84.81	PK	3	0.00	116.20	31.39	PASS
WLAN-2437g	V	3	Horn SN6276	2436.33	86.20		30.30	3.51	-36.51	0.00	-2.71	83.49	PK	3	0.00	116.20	32.71	PASS
WLAN-2462g	V	3	Horn SN6276	2458.99	86.40		30.33	3.52	-36.48	0.00	-2.63	83.77	PK	3	0.00	116.20	32.42	PASS

Formulae:
 Total CF = AF + CL + Other
 Field Strength = SA Level + Total CF

 *Worst case Duty Cycle of 100% used

Test Report Serial No.:	022305KBC-T618-E15W/B	Issue 1.0
Test Date(s):	01Oct04 - 14Oct04	
Test Type(s):	FCC §15.247	IC RSS-210 Issue 5
Lab Registration(s):	FCC #714830	IC Lab File #3874

D.9.3. High Bluetooth Channel Carrier Field Strength @ Specified Distance



Project Number: 072804KBC-T543-E15W/B
Company: Itronix
Product: IX260+ with Co-Transmitting Bluetooth and WLAN

Standard: FCC15.247a
Test Start Date: 04Oct04
Test End Date: 12Oct04

Bluetooth CH 79 (2480 MHz) co-transmitting with WLAN Carrier Field Strengths																		
Co-transmit Channel	Polarity	Measurement Distance	Antenna	Carrier Freq	SA Level	Noise Floor	AF	CL	*Duty Cycle Correction	Other	Total CF	Field Strength	Detector	Limit Distance	Limit Distance Correction	Calculated Limit	Margin	Pass/Fail
Bluetooth Carrier Field Strengths with WLAN Mode g Co-Transmitting																		
WLAN-2412b	H	3	Horn SN6276	2480.24	99.80		30.37	3.51	0.00	-36.45	-2.56	97.24	PK	3	0.00	116.20	18.96	PASS
WLAN-2437b	H	3	Horn SN6276	2480.23	100.50		30.37	3.51	0.00	-36.45	-2.56	97.94	PK	3	0.00	116.20	18.26	PASS
WLAN-2462b	H	3	Horn SN6276	2480.21	101.20		30.37	3.51	0.00	-36.45	-2.56	98.64	PK	3	0.00	116.20	17.56	PASS
WLAN-2412b	V	3	Horn SN6276	2480.19	92.90		30.37	3.51	0.00	-36.45	-2.56	90.34	PK	3	0.00	116.20	25.86	PASS
WLAN-2437b	V	3	Horn SN6276	2480.20	92.30		30.37	3.51	0.00	-36.45	-2.56	89.74	PK	3	0.00	116.20	26.46	PASS
WLAN-2462b	V	3	Horn SN6276	2480.20	94.70		30.37	3.51	0.00	-36.45	-2.56	92.14	PK	3	0.00	116.20	24.06	PASS
WLAN Mode g Carrier Field Strengths with Bluetooth Co-Transmitting																		
WLAN-2412b	H	3	Horn SN6276	2412.91	92.20		30.26	3.49	0.00	-36.55	-2.80	89.40	PK	3	0.00	116.20	26.80	PASS
WLAN-2437b	H	3	Horn SN6276	2437.94	92.80		30.30	3.51	0.00	-36.51	-2.70	90.10	PK	3	0.00	116.20	26.10	PASS
WLAN-2462b	H	3	Horn SN6276	2461.02	93.60		30.34	3.52	0.00	-36.48	-2.62	90.98	PK	3	0.00	116.20	25.22	PASS
WLAN-2412b	V	3	Horn SN6276	2412.96	86.80		30.26	3.49	0.00	-36.55	-2.80	84.00	PK	3	0.00	116.20	32.20	PASS
WLAN-2437b	V	3	Horn SN6276	2437.90	87.30		30.30	3.51	0.00	-36.51	-2.70	84.60	PK	3	0.00	116.20	31.60	PASS
WLAN-2462b	V	3	Horn SN6276	2460.92	87.90		30.34	3.52	0.00	-36.48	-2.62	85.28	PK	3	0.00	116.20	30.92	PASS
Bluetooth Carrier Field Strengths with WLAN Mode g Co-Transmitting																		
WLAN-2412g	H	3	Horn SN6276	2480.23	100.10		30.37	3.51	0.00	-36.45	-2.56	97.54	PK	3	0.00	116.20	18.66	PASS
WLAN-2437g	H	3	Horn SN6276	2480.17	100.20		30.37	3.51	0.00	-36.45	-2.56	97.64	PK	3	0.00	116.20	18.56	PASS
WLAN-2462g	H	3	Horn SN6276	2480.15	101.20		30.37	3.51	0.00	-36.45	-2.56	98.64	PK	3	0.00	116.20	17.56	PASS
WLAN-2412g	V	3	Horn SN6276	2480.20	94.50		30.37	3.51	0.00	-36.45	-2.56	91.94	PK	3	0.00	116.20	24.26	PASS
WLAN-2437g	V	3	Horn SN6276	2480.17	93.10		30.37	3.51	0.00	-36.45	-2.56	90.54	PK	3	0.00	116.20	25.66	PASS
WLAN-2462g	V	3	Horn SN6276	2480.21	93.10		30.37	3.51	0.00	-36.45	-2.56	90.54	PK	3	0.00	116.20	25.66	PASS
WLAN Mode g Carrier Field Strengths with Bluetooth Co-Transmitting																		
WLAN-2412g	H	3	Horn SN6276	2414.68	91.90		30.26	3.49	0.00	-36.55	-2.79	89.11	PK	3	0.00	116.20	27.09	PASS
WLAN-2437g	H	3	Horn SN6276	2435.49	93.20		30.30	3.51	0.00	-36.51	-2.71	90.49	PK	3	0.00	116.20	25.71	PASS
WLAN-2462g	H	3	Horn SN6276	2461.85	93.70		30.34	3.52	0.00	-36.47	-2.62	91.08	PK	3	0.00	116.20	25.12	PASS
WLAN-2412g	V	3	Horn SN6276	2409.36	85.60		30.25	3.48	0.00	-36.55	-2.81	82.79	PK	3	0.00	116.20	33.41	PASS
WLAN-2437g	V	3	Horn SN6276	2439.33	86.50		30.30	3.51	0.00	-36.51	-2.70	83.80	PK	3	0.00	116.20	32.39	PASS
WLAN-2462g	V	3	Horn SN6276	2459.16	86.00		30.33	3.52	0.00	-36.48	-2.63	83.37	PK	3	0.00	116.20	32.82	PASS

Formulae:
 Total CF = AF + CL + Other
 Field Strength = SA Level + Total CF

 *Worst case Duty Cycle of 100% used

Test Report Serial No.:	022305KBC-T618-E15W/B	Issue 1.0
Test Date(s):	01Oct04 - 14Oct04	
Test Type(s):	FCC §15.247	IC RSS-210 Issue 5
Lab Registration(s):	FCC #714830	IC Lab File #3874

D.9.4. Band-edge Spurious Field Strength @ Specified Distance

		Company:	072804KBC-T543-E15W/B										Standard:	FCC15.209 / 15.247				
		Product:	Itronix IX260+ with Bluetooth & WLAN										Test Start Date:	21 Sep04				
													Test End Date:	12 Oct04				
Bluetooth Channel 0 (2402 MHz) Lower Band-Edge																		
WLAN Co-Transmitting Channel Mode b	Polarity	Distance	Rx Antenna	Frequency	SA Level	Noise Floor	Rx AF	Rx CL	Other Rx	Duty Cycle Correction	Total Rx CF	Field Strength	Detector	Limit Distance	Limit Distance Correction	Calculated Limit	Margin	Pass/Fail
							dBm	dB	dB	dB	dBm	dBuV/m	(PK/QP/AV)	m	dB	dBuV/m	dB	
2412	H	3	Horn SN6276	2400.00	41.80		30.24	3.48	-20.38	-20.00	-6.67	35.13	AV	3.00	0.00	88.31	53.18	PASS
2412	V	3	Horn SN6276	2400.00	32.10		30.24	3.48	-20.38	-20.00	-6.67	25.43	AV	3.00	0.00	83.21	57.78	PASS
2462	H	3	Horn SN6276	2400.00	32.50		30.24	3.48	-20.38	-20.00	-6.67	25.83	AV	3.00	0.00	88.31	62.48	PASS
2462	V	3	Horn SN6276	2400.00	30.20		30.24	3.48	-20.38	-20.00	-6.67	23.53	AV	3.00	0.00	83.21	59.68	PASS
Note: Occupied Band-edge measured with 100 kHz RBW																		
Bluetooth Channel 79 (2480 MHz) Upper Band-Edge																		
WLAN Co-Transmitting Channel Mode b	Polarity	Distance	Rx Antenna	Frequency	SA Level	Noise Floor	Rx AF	Rx CL	Other Rx	Duty Cycle Correction	Total Rx CF	Field Strength	Detector	Limit Distance	Limit Distance Correction	Calculated Limit	Margin	Pass/Fail
							dBm	dB	dB	dB	dBm	dBuV/m	(PK/QP/AV)	m	dB	dBuV/m	dB	
2412	H	3	Horn SN6276	2483.50	45.20		30.37	3.51	-20.26	-20.00	-6.37	38.83	AV	3.00	0.00	53.98	15.15	PASS
2412	V	3	Horn SN6276	2483.50	41.20		30.37	3.51	-20.26	-20.00	-6.37	34.83	AV	3.00	0.00	53.98	19.15	PASS
2462	H	3	Horn SN6276	2483.50	45.90		30.37	3.51	-20.26	-20.00	-6.37	39.53	AV	3.00	0.00	53.98	14.45	PASS
2462	V	3	Horn SN6276	2483.50	40.80		30.37	3.51	-20.26	-20.00	-6.37	34.43	AV	3.00	0.00	53.98	19.55	PASS
Note: Restricted Band-edge measured with 1 MHz RBW																		
WLAN Channel 1 (2412 MHz) Lower Band-Edge																		
Bluetooth Co-Transmitting Channel	Polarity	Distance	Rx Antenna	Frequency	SA Level	Noise Floor	Rx AF	Rx CL	Other Rx	Duty Cycle Correction	Total Rx CF	Field Strength	Detector	Limit Distance	Limit Distance Correction	Calculated Limit	Margin	Pass/Fail
							dBm	dB	dB	dB	dBm	dBuV/m	(PK/QP/AV)	m	dB	dBuV/m	dB	
2402	H	3	Horn SN6276	2400.00	41.80		30.24	3.48	-20.38	-20.00	-6.67	35.13	AV	3.00	0.00	88.31	53.18	PASS
2402	V	3	Horn SN6276	2400.00	32.10		30.24	3.48	-20.38	-20.00	-6.67	25.43	AV	3.00	0.00	83.21	57.78	PASS
2480	H	3	Horn SN6276	2400.00	40.50		30.24	3.48	-20.38	-20.00	-6.67	33.83	AV	3.00	0.00	88.31	54.48	PASS
2480	V	3	Horn SN6276	2400.00	34.70		30.24	3.48	-20.38	-20.00	-6.67	28.03	AV	3.00	0.00	83.21	55.18	PASS
Note: Occupied Band-edge measured with 100 kHz RBW																		
WLAN Channel 11 (2462 MHz) Upper Band-Edge																		
Bluetooth Co-Transmitting Channel	Polarity	Distance	Rx Antenna	Frequency	SA Level	Noise Floor	Rx AF	Rx CL	Other Rx	Duty Cycle Correction	Total Rx CF	Field Strength	Detector	Limit Distance	Limit Distance Correction	Calculated Limit	Margin	Pass/Fail
							dBm	dB	dB	dB	dBm	dBuV/m	(PK/QP/AV)	m	dB	dBuV/m	dB	
2402	H	3	Horn SN6276	2483.50	49.90		30.37	3.51	-20.26	-20.00	-6.37	43.53	AV	3.00	0.00	53.98	10.45	PASS
2402	V	3	Horn SN6276	2483.50	47.50		30.37	3.51	-20.26	-20.00	-6.37	41.13	AV	3.00	0.00	53.98	12.85	PASS
2480	H	3	Horn SN6276	2483.50	45.90		30.37	3.51	-20.26	-20.00	-6.37	39.53	AV	3.00	0.00	53.98	14.45	PASS
2480	V	3	Horn SN6276	2483.50	40.80		30.37	3.51	-20.26	-20.00	-6.37	34.43	AV	3.00	0.00	53.98	19.55	PASS
Note: Restricted Band-edge measured with 1 MHz RBW																		
<p>Formulae:</p> <p>Total CF (dB) = Antenna Factor (dB) + Cable Factor (dB) + Other Factor (Amplifier Gain, Filter Loss, etc) (dB)</p> <p>Field Strength (dBuV/m) = SA Reading (dBuV) + Total CF (dB/m)</p> <p>Limit Distance Correction (dB) = 40 * log(d1/d2) for f < 30 MHz, 20*log(d1/d2) for f > 30 MHz; where d1 is the measurement distance and d2 is the published limit distance</p> <p>Limit (dBuV/m) = Published Limit (dBuV/m) + Limit Distance Correction (dB)</p> <p>Margin (dB) = Limit (dBuV/m) - Field Strength (dBuV/m)</p> <p>Duty Cycle Correction (dB) = 20 * log (duty cycle ratio)</p> <p>Duty Cycle ratio = maximum time on in any 100 mS period (in mS) / 100 mS</p> <p>Note:</p> <p>DUT duty cycle = 10 mS in each 10 seconds</p> <p>Mode b determined to be worse case</p>																		

Applicant:	Itronix Corporation	Model:	IX260PROA580BT	IC ID:	1943A-IX260Pf	FCC ID:	KBCIX260PROA580BT	
IX260+ Rugged Laptop PC with internal Intel Pro 2200BG 802.11b/g WLAN and Cirronet BT2022 Bluetooth								
2005 Celltech Labs Inc This document is not to be reproduced in whole or in part without the written permission of Celltech Labs Inc.							34 of 42	

Test Report Serial No.:	022305KBC-T618-E15W/B	Issue 1.0
Test Date(s):	01Oct04 - 14Oct04	
Test Type(s):	FCC §15.247	IC RSS-210 Issue 5
Lab Registration(s):	FCC #714830	IC Lab File #3874

D.9.5. Spurious Field Strength @ Specified Distance (Low Bluetooth Channel)

		Company:	072804KBC-T543-E15WB										Standard:	FCC15.209				
		Product:	Itronix IX260+ with Co-Transmitting Bluetooth and WLAN										Test Start Date:	04Oct04				
													Test End Date:	12Oct04				
Bluetooth CH 0 (2402 MHz) co-transmitting with WLAN Spurious Emissions																		
Channel	Polarity	Distance	Rx Antenna	Frequency	SA Level	Noise Floor	Rx AF	Rx CL	Other Rx	*Duty Cycle Correction	Total Rx CF	Field Strength	Detector	Limit Distance	Limit Distance Correction	Calculated Limit	Margin	Pass/Fail
WLAN-2412b	H	3	Horn SN6276	2392.98	62.00	30.23	3.47	-20.40	-20.00	-6.70	55.30	PK	3.00	0.00	73.98	18.68	PASS	
WLAN-2412b	H	3	Horn SN6276	2392.98	54.00	30.23	3.47	-20.40	-20.00	-6.70	47.30	AV	3.00	0.00	53.98	6.68	PASS	
WLAN-2412b	H	3	Horn SN6276	2487.88	46.90	30.38	3.51	-20.25	-20.00	-6.36	40.54	AV	3.00	0.00	53.98	13.43	PASS	
WLAN-2437b	H	3	Horn SN6276	2368.51	51.50	30.19	3.45	-20.43	-20.00	-6.80	44.70	PK	3.00	0.00	53.98	9.27	PASS	
WLAN-2437b	H	3	Horn SN6276	2486.98	46.60	30.38	3.51	-20.25	-20.00	-6.36	40.24	AV	3.00	0.00	53.98	13.74	PASS	
WLAN-2462b	H	3	Horn SN6276	2341.70	50.00	30.15	3.42	-20.47	-20.00	-6.91	43.09	PK	3.00	0.00	53.98	10.88	PASS	
WLAN-2462b	H	3	Horn SN6276	2521.67	50.80	30.47	3.54	-20.20	-20.00	-6.19	44.61	PK	3.00	0.00	53.98	9.37	PASS	
WLAN-2412b	V	3	Horn SN6276	2392.58	63.90	30.23	3.47	-20.40	-20.00	-6.70	57.20	PK	3.00	0.00	73.98	16.78	PASS	
WLAN-2412b	V	3	Horn SN6276	2486.03	46.60	30.38	3.51	-20.25	-20.00	-6.36	40.24	AV	3.00	0.00	53.98	13.74	PASS	
WLAN-2437b	V	3	Horn SN6276	2363.86	48.30	30.18	3.44	-20.44	-20.00	-6.81	41.49	PK	3.00	0.00	53.98	12.49	PASS	
WLAN-2437b	V	3	Horn SN6276	2487.22	46.40	30.38	3.51	-20.25	-20.00	-6.36	40.04	AV	3.00	0.00	53.98	13.94	PASS	
WLAN-2462b	V	3	Horn SN6276	2346.38	48.10	30.15	3.43	-20.47	-20.00	-6.89	41.21	PK	3.00	0.00	53.98	12.77	PASS	
WLAN-2462b	V	3	Horn SN6276	2521.88	48.20	30.47	3.54	-20.20	-20.00	-6.19	42.01	PK	3.00	0.00	53.98	11.97	PASS	
WLAN-2412g	H	3	Horn SN6276	2392.00	54.80	30.23	3.47	-20.40	-20.00	-6.70	48.10	PK	3.00	0.00	53.98	5.88	PASS	
WLAN-2412g	H	3	Horn SN6276	2485.07	47.00	30.38	3.51	-20.25	-20.00	-6.36	40.64	AV	3.00	0.00	53.98	13.34	PASS	
WLAN-2437g	H	3	Horn SN6276	2366.21	51.50	30.19	3.45	-20.44	-20.00	-6.80	44.70	PK	3.00	0.00	53.98	9.28	PASS	
WLAN-2437g	H	3	Horn SN6276	2483.63	48.30	30.37	3.51	-20.26	-20.00	-6.37	41.93	PK	3.00	0.00	53.98	12.05	PASS	
WLAN-2462g	H	3	Horn SN6276	2344.01	48.50	30.15	3.42	-20.47	-20.00	-6.90	41.60	PK	3.00	0.00	53.98	12.38	PASS	
WLAN-2462g	H	3	Horn SN6276	2524.53	48.10	30.48	3.54	-20.19	-20.00	-6.17	41.93	PK	3.00	0.00	53.98	12.05	PASS	
WLAN-2412g	V	3	Horn SN6276	2392.00	50.70	30.23	3.47	-20.40	-20.00	-6.70	44.00	PK	3.00	0.00	53.98	9.98	PASS	
WLAN-2412g	V	3	Horn SN6276	2488.09	46.60	30.38	3.51	-20.25	-20.00	-6.35	40.25	AV	3.00	0.00	53.98	13.73	PASS	
WLAN-2437g	V	3	Horn SN6276	2368.73	51.80	30.19	3.45	-20.43	-20.00	-6.79	45.01	PK	3.00	0.00	53.98	8.97	PASS	
WLAN-2437g	V	3	Horn SN6276	2486.30	47.10	30.38	3.51	-20.25	-20.00	-6.36	40.74	PK	3.00	0.00	53.98	13.24	PASS	
WLAN-2462g	V	3	Horn SN6276	2340.04	47.10	30.14	3.42	-20.48	-20.00	-6.91	40.19	PK	3.00	0.00	53.98	13.79	PASS	
WLAN-2462g	V	3	Horn SN6276	2522.40	47.60	30.47	3.54	-20.20	-20.00	-6.19	41.41	PK	3.00	0.00	53.98	12.57	PASS	
Formulae: Total CF = AF + CL + Other Field Strength = SA Level + Total CF Duty Cycle Correction (dB) = 20 * log (duty cycle ratio) Duty Cycle ratio = maximum time on in any 100 mS period (in mS) / 100 mS *DUT duty cycle = 10 mS in each 10 seconds																		

*The frequency points reported describe the highest local emission measured and are used to describe the measured inter-modulation product or band-edge of interest. No out-of-band emissions were measured above the levels noted.

Where there is acceptable margin between the peak emission reported and the average limit stated, the average limit is referenced. Where the average limit is exceeded by the peak emission or the margin unacceptable, the peak limit is referenced and an average measurement made and referenced to the average limit.

Applicant:	Itronix Corporation	Model:	IX260PROA580BT	IC ID:	1943A-IX260Pf	FCC ID:	KBCIX260PROA580BT
IX260+ Rugged Laptop PC with internal Intel Pro 2200BG 802.11b/g WLAN and Cirronet BT2022 Bluetooth							
2005 Celltech Labs Inc This document is not to be reproduced in whole or in part without the written permission of Celltech Labs Inc.							35 of 42

Test Report Serial No.:	022305KBC-T618-E15W/B	Issue 1.0
Test Date(s):	01Oct04 - 14Oct04	
Test Type(s):	FCC §15.247	IC RSS-210 Issue 5
Lab Registration(s):	FCC #714830	IC Lab File #3874

D.9.6. Spurious Field Strength @ Specified Distance (Mid Bluetooth Channel)

		Company:	072804KBC-T543-E15W/B										Standard:	FCC15.209				
		Product:	Itronix IX260+ with Co-Transmitting Bluetooth and WLAN										Test Start Date:	04Oct04				
													Test End Date:	12Oct04				
Bluetooth CH 39 (2441 MHz) co-transmitting with WLAN																		
Channel	Polarity	Distance	Rx Antenna	Frequency	SA Level	Noise Floor	Rx AF	Rx CL	Other Rx	*Duty Cycle Correction	Total Rx CF	Field Strength	Detector	Limit Distance	Limit Distance Correction	Calculated Limit	Margin	Pass/Fail
		m		MHz	dBuV		dB/m	dB	dB	dB	dB/m	dBuV/m	PK/QP/AV	m	dB	dBuV/m	dB	
WLAN-2412b	H	3	Horn SN6276	2382.12	51.30		30.21	3.46	-20.41	-20.00	-6.74	44.56	PK	3.00	0.00	53.98	9.42	PASS
WLAN-2412b	H	3	Horn SN6276	2484.24	50.60		30.37	3.51	-20.26	-20.00	-6.37	44.23	PK	3.00	0.00	53.98	9.75	PASS
WLAN-2437b	H	3	Horn SN6276	2387.35	47.60		30.22	3.47	-20.40	-20.00	-6.72	40.88	PK	3.00	0.00	53.98	13.10	PASS
WLAN-2437b	H	3	Horn SN6276	2487.66	46.80		30.38	3.51	-20.25	-20.00	-6.36	40.44	AV	3.00	0.00	53.98	13.54	PASS
WLAN-2462b	H	3	Horn SN6276	2386.74	46.50		30.22	3.46	-20.41	-20.00	-6.72	39.78	PK	3.00	0.00	53.98	14.20	PASS
WLAN-2462b	H	3	Horn SN6276	2487.68	52.00		30.38	3.51	-20.25	-20.00	-6.36	45.64	PK	3.00	0.00	53.98	8.34	PASS
WLAN-2412b	V	3	Horn SN6276	2383.01	47.00		30.21	3.46	-20.41	-20.00	-6.74	40.26	PK	3.00	0.00	53.98	13.72	PASS
WLAN-2412b	V	3	Horn SN6276	2486.75	47.90		30.38	3.51	-20.25	-20.00	-6.36	41.54	PK	3.00	0.00	53.98	12.44	PASS
WLAN-2437b	V	3	Horn SN6276	2386.67	46.70		30.22	3.46	-20.41	-20.00	-6.72	39.98	PK	3.00	0.00	53.98	14.00	PASS
WLAN-2437b	V	3	Horn SN6276	2486.29	46.50		30.38	3.51	-20.25	-20.00	-6.36	40.14	PK	3.00	0.00	53.98	13.84	PASS
WLAN-2462b	V	3	Horn SN6276	2386.39	47.70		30.22	3.46	-20.41	-20.00	-6.72	40.98	PK	3.00	0.00	53.98	13.00	PASS
WLAN-2462b	V	3	Horn SN6276	2486.67	51.40		30.38	3.51	-20.25	-20.00	-6.36	45.04	PK	3.00	0.00	53.98	8.94	PASS
WLAN-2412g	H	3	Horn SN6276	2383.97	52.40		30.21	3.46	-20.41	-20.00	-6.73	45.67	PK	3.00	0.00	53.98	8.31	PASS
WLAN-2412g	H	3	Horn SN6276	2484.08	46.60		30.37	3.51	-20.26	-20.00	-6.37	40.23	PK	3.00	0.00	53.98	13.75	PASS
WLAN-2437g	H	3	Horn SN6276	2388.01	46.70		30.22	3.47	-20.40	-20.00	-6.72	39.98	PK	3.00	0.00	53.98	14.00	PASS
WLAN-2437g	H	3	Horn SN6276	2488.43	47.10		30.38	3.51	-20.25	-20.00	-6.35	40.75	PK	3.00	0.00	53.98	13.23	PASS
WLAN-2462g	H	3	Horn SN6276	2387.66	46.90		30.22	3.47	-20.40	-20.00	-6.72	40.18	PK	3.00	0.00	53.98	13.80	PASS
WLAN-2462g	H	3	Horn SN6276	2484.01	56.50		30.37	3.51	-20.26	-20.00	-6.37	50.13	PK	3.00	0.00	53.98	3.85	PASS
WLAN-2412g	V	3	Horn SN6276	2387.50	48.90		30.22	3.47	-20.40	-20.00	-6.72	42.18	PK	3.00	0.00	53.98	11.80	PASS
WLAN-2412g	V	3	Horn SN6276	2485.54	47.40		30.38	3.51	-20.25	-20.00	-6.36	41.04	PK	3.00	0.00	53.98	12.94	PASS
WLAN-2437g	V	3	Horn SN6276	2387.78	46.70		30.22	3.47	-20.40	-20.00	-6.72	39.98	PK	3.00	0.00	53.98	14.00	PASS
WLAN-2437g	V	3	Horn SN6276	2483.72	47.10		30.37	3.51	-20.26	-20.00	-6.37	40.73	PK	3.00	0.00	53.98	13.25	PASS
WLAN-2462g	V	3	Horn SN6276	2389.18	46.50		30.22	3.47	-20.40	-20.00	-6.71	39.79	PK	3.00	0.00	53.98	14.19	PASS
WLAN-2462g	V	3	Horn SN6276	2483.00	52.10		30.37	3.51	-20.26	-20.00	-6.37	45.73	PK	3.00	0.00	53.98	8.25	PASS
Formulae: Total CF = AF + CL + Other Field Strength = SA Level + Total CF Duty Cycle Correction (dB) = 20 * log (duty cycle ratio*) Duty Cycle ratio = maximum time on in any 100 mS period (in mS) / 100 mS *DUT duty cycle = 10 mS in each 10 seconds																		

*The frequency points reported describe the highest local emission measured and are used to describe the measured inter-modulation product or band-edge of interest. No out-of-band emissions were measured above the levels noted.

Where there is acceptable margin between the peak emission reported and the average limit stated, the average limit is referenced. Where the average limit is exceeded by the peak emission or the margin unacceptable, the peak limit is referenced and an average measurement made and referenced to the average limit.

Applicant:	Itronix Corporation	Model:	IX260PROA580BT	IC ID:	1943A-IX260Pf	FCC ID:	KBCIX260PROA580BT	
IX260+ Rugged Laptop PC with internal Intel Pro 2200BG 802.11b/g WLAN and Cirronet BT2022 Bluetooth								
2005 Celltech Labs Inc This document is not to be reproduced in whole or in part without the written permission of Celltech Labs Inc.							36 of 42	

Test Report Serial No.:	022305KBC-T618-E15W/B	Issue 1.0
Test Date(s):	01Oct04 - 14Oct04	
Test Type(s):	FCC §15.247	IC RSS-210 Issue 5
Lab Registration(s):	FCC #714830	IC Lab File #3874

D.9.7. Spurious Field Strength @ Specified Distance (High Bluetooth Channel)



Company: 072804KBC-T543-E15W/B
 Product: Itronix
 IX260+ with Co-Transmitting Bluetooth and WLAN

Standard: FCC15.209
 Test Start Date: 04Oct04
 Test End Date: 12Oct04

Bluetooth CH 79 (2480 MHz) co-transmitting with WLAN																			
Channel	Polarity	Distance	Rx Antenna	Frequency	SA Level	Noise Floor	Rx AF	Rx CL	*Duty Cycle Correction	Other Rx	Total Rx CF	Field Strength	Detector	Limit Distance	Limit Distance Correction	Calculated Limit	Margin	Pass/Fail	
							dB/m	dB	dB	dB	dB/m	dBuV/m	(PK/QP/AV)	m	dB	dBuV/m	dB		
WLAN-2412b	H	3	Horn SN6276	2341.14	46.90		30.15	3.42	-20.00	-20.48	-6.91	39.99	PK	3.00	0.00	53.98	13.99	PASS	
WLAN-2412b	H	3	Horn SN6276	2552.78	47.50		30.57	3.57	-20.00	-20.15	-6.01	41.49	PK	3.00	0.00	53.98	12.49	PASS	
WLAN-2437b	H	3	Horn SN6276	2391.30	50.50		30.23	3.47	-20.00	-20.40	-6.70	43.80	PK	3.00	0.00	53.98	10.18	PASS	
WLAN-2437b	H	3	Horn SN6276	2524.03	54.30		30.48	3.54	-20.00	-20.19	-6.18	48.12	AV	3.00	0.00	53.98	5.86	PASS	
WLAN-2462b	H	3	Horn SN6276	2392.79	47.10		30.23	3.47	-20.00	-20.40	-6.70	40.40	PK	3.00	0.00	53.98	13.58	PASS	
WLAN-2462b	H	3	Horn SN6276	2499.35	55.00		30.40	3.51	-20.00	-20.23	-6.32	48.68	PK	3.00	0.00	53.98	5.30	PASS	
WLAN-2412b	V	3	Horn SN6276	2339.57	47.20		30.14	3.42	-20.00	-20.48	-6.91	40.29	PK	3.00	0.00	53.98	13.69	PASS	
WLAN-2412b	V	3	Horn SN6276	2545.68	47.50		30.55	3.57	-20.00	-20.16	-6.05	41.45	PK	3.00	0.00	53.98	12.53	PASS	
WLAN-2437b	V	3	Horn SN6276	2393.05	51.00		30.23	3.47	-20.00	-20.40	-6.70	44.30	PK	3.00	0.00	53.98	9.68	PASS	
WLAN-2437b	V	3	Horn SN6276	2524.87	52.90		30.48	3.54	-20.00	-20.19	-6.17	46.73	PK	3.00	0.00	53.98	7.25	PASS	
WLAN-2462b	V	3	Horn SN6276	2387.47	46.80		30.22	3.47	-20.00	-20.40	-6.72	40.08	PK	3.00	0.00	53.98	13.90	PASS	
WLAN-2462b	V	3	Horn SN6276	2499.63	53.20		30.40	3.51	-20.00	-20.23	-6.32	46.88	PK	3.00	0.00	53.98	7.10	PASS	
WLAN-2412g	H	3	Horn SN6276	2346.91	46.90		30.16	3.43	-20.00	-20.47	-6.88	40.02	PK	3.00	0.00	53.98	13.96	PASS	
WLAN-2412g	H	3	Horn SN6276	2546.47	51.40		30.55	3.57	-20.00	-20.16	-6.04	45.36	PK	3.00	0.00	53.98	8.62	PASS	
WLAN-2437g	H	3	Horn SN6276	2391.37	50.90		30.23	3.47	-20.00	-20.40	-6.70	44.20	PK	3.00	0.00	53.98	9.78	PASS	
WLAN-2437g	H	3	Horn SN6276	2523.57	52.80		30.48	3.54	-20.00	-20.19	-6.18	46.62	PK	3.00	0.00	53.98	7.36	PASS	
WLAN-2462g	H	3	Horn SN6276	2388.64	46.80		30.22	3.47	-20.00	-20.40	-6.71	40.09	PK	3.00	0.00	53.98	13.89	PASS	
WLAN-2462g	H	3	Horn SN6276	2500.64	54.90		30.40	3.51	-20.00	-20.23	-6.31	48.59	PK	3.00	0.00	53.98	5.39	PASS	
WLAN-2412g	V	3	Horn SN6276	2345.01	46.90		30.15	3.43	-20.00	-20.47	-6.89	40.01	PK	3.00	0.00	53.98	13.97	PASS	
WLAN-2412g	V	3	Horn SN6276	2546.24	49.00		30.55	3.57	-20.00	-20.16	-6.04	42.96	PK	3.00	0.00	53.98	11.02	PASS	
WLAN-2437g	V	3	Horn SN6276	2390.59	51.60		30.22	3.47	-20.00	-20.40	-6.71	44.89	PK	3.00	0.00	53.98	9.09	PASS	
WLAN-2437g	V	3	Horn SN6276	2525.62	51.70		30.48	3.54	-20.00	-20.19	-6.17	45.53	PK	3.00	0.00	53.98	8.45	PASS	
WLAN-2462g	V	3	Horn SN6276	2386.94	46.90		30.22	3.46	-20.00	-20.40	-6.72	40.18	PK	3.00	0.00	53.98	13.80	PASS	
WLAN-2462g	V	3	Horn SN6276	2500.28	51.50		30.40	3.51	-20.00	-20.23	-6.32	45.18	PK	3.00	0.00	53.98	8.80	PASS	

Formulae:
 Total CF = AF + CL + Other
 Field Strength = SA Level + Total CF
 Duty Cycle Correction (dB) = 20 * log (duty cycle ratio*)
 Duty Cycle ratio = maximum time on in any 100 mS period (in mS) / 100 mS
 *DUT duty cycle = 10 mS in each 10 seconds

*The frequency points reported describe the highest local emission measured and are used to describe the measured inter-modulation product or band-edge of interest. No out-of-band emissions were measured above the levels noted.

Where there is acceptable margin between the peak emission reported and the average limit stated, the average limit is referenced. Where the average limit is exceeded by the peak emission or the margin unacceptable, the peak limit is referenced and an average measurement made and referenced to the average limit.

Applicant:	Itronix Corporation	Model:	IX260PROA580BT	IC ID:	1943A-IX260Pf	FCC ID:	KBCIX260PROA580BT	
IX260+ Rugged Laptop PC with internal Intel Pro 2200BG 802.11b/g WLAN and Cirronet BT2022 Bluetooth								
2005 Celltech Labs Inc This document is not to be reproduced in whole or in part without the written permission of Celltech Labs Inc.							37 of 42	

Test Report Serial No.:	022305KBC-T618-E15W/B	Issue 1.0
Test Date(s):	01Oct04 - 14Oct04	
Test Type(s):	FCC §15.247	IC RSS-210 Issue 5
Lab Registration(s):	FCC #714830	IC Lab File #3874

D.10. PASS/FAIL

In reference to the results outlined in D.9, the DUT passes the requirements as stated in the reference standards as follows: FCC 15.205 (a) (b) and 15.209 (a): No emissions were measured within the restricted bands as outlined in 15.205 that exceeded the limits stated in 15.209.

D.11. SIGN-OFF

I attest to the accuracy of the data. All measurements reported herein were performed by me and are correct to the best of my knowledge and belief. I assume full responsibility for the completeness of these measurements.



Russell Pipe
Senior Compliance Technologist
Celltech Labs Inc.

14Oct04
Date

Applicant:	Itronix Corporation	Model:	IX260PROA580BT	IC ID:	1943A-IX260Pf	FCC ID:	KBCIX260PROA580BT	
IX260+ Rugged Laptop PC with internal Intel Pro 2200BG 802.11b/g WLAN and Cirronet BT2022 Bluetooth								
2005 Celltech Labs Inc		This document is not to be reproduced in whole or in part without the written permission of Celltech Labs Inc.					38 of 42	

Test Report Serial No.:	022305KBC-T618-E15W/B	Issue 1.0
Test Date(s):	01Oct04 - 14Oct04	
Test Type(s):	FCC §15.247	IC RSS-210 Issue 5
Lab Registration(s):	FCC #714830	IC Lab File #3874

Appendix E - Maximum Permissible Exposure Calculation

E.1. REFERENCES

Normative Reference Standard	FCC CFR 47§1.1310 IEEE Std C95.1-1999
Procedure Reference	FCC CFR 47§2.1091

E.2. LIMITS

FCC CFR 47§1.1310 Table 1(b)	1.0 mW/cm ²
------------------------------	------------------------

E.3. ENVIRONMENTAL CONDITIONS

Temperature	na
Humidity	na
Barometric Pressure	na

E.4. EQUIPMENT LIST

ASSET NUMBER	MANUFACTURER	MODEL	DESCRIPTION	LAST CAL	CAL DUE
na					

E.5. MEASUREMENT EQUIPMENT SETUP

MEASUREMENT EQUIPMENT CONNECTIONS	The results described herein were determined by the calculation, so no measurement equipment was used.
MEASUREMENT EQUIPMENT SETTINGS	na

E.6. SETUP PHOTOS

na

E.7. SETUP DRAWINGS

na

E.8. DUT OPERATING DESCRIPTION

na (the power levels calculated are equivalent to those described in the referenced single-transmit test reports)

E.9. TEST RESULTS

E.9.1. Single-Transmit Calculations:

RangeStar Internal Antenna (WLAN 802.11b mode):

Tx Frequency: 2462.00 (MHz)
 Source-Based Time-Averaged Power at Antenna Input Terminal: 17.48 (dBm)
 Antenna gain: 4.50 (dBi)

S = 1.00 (mW/cm²)
 P = 55.9758 (mW)
 G = 2.82 (numeric)

R = 3.54 (cm)

S (mw/cm²) at 20cm = 0.031351575

RangeStar Internal Antenna (Bluetooth):

Tx Frequency: 2441 (MHz)
 RF Output Power at Antenna Input Terminal: 15.61 (dBm)
 Antenna gain: 4.50 (dBi)

S = 1.00 (mW/cm²)
 P = 36.3915 (mW)
 G = 2.82 (numeric)

R = 2.86 (cm)

S at 20cm: 0.02038259 (mW/cm²)

Formulae:

$$S = \frac{PG}{4\pi R^2}$$

$$R = \sqrt{\frac{P}{4\pi S}}$$

where: S = Power Density Limit
 P = Power Applied to the Antenna
 G = Numeric Antenna Gain
 R = Distance from Antenna

Results:

Mode	Power Density Limit	RF Conducted Output Power	Antenna Gain	MPE Distance	Power Density at 20 cm
	mW/cm ²	dBm	dBi	cm	mW/cm ²
WLAN (802.11b)	1.0	17.48	4.5	3.54	0.031
Bluetooth (CH39)	1.0	15.61	4.5	2.86	0.020

Test Report Serial No.:	022305KBC-T618-E15W/B	Issue 1.0
Test Date(s):	01Oct04 - 14Oct04	
Test Type(s):	FCC §15.247	IC RSS-210 Issue 5
Lab Registration(s):	FCC #714830	IC Lab File #3874

E.9.2. Co-Transmit MPE Calculations

Radio	20 cm Power Density mW/cm ²	Ratio (S/Limit)	Limit mW/cm ²
WLAN	0.031	0.031	1
Bluetooth	0.020	0.020	1
	Sum =	0.051	1

E.10. PASS/FAIL

In reference to the results outlined in D.9 the DUT passes the requirements as stated in the reference standards as follows:
1) The DUT must comply with the minimum spacing requirement of 20 cm to ensure an exposure of not more than 1 mW/cm².

E.11. SIGN-OFF

I attest to the accuracy of the data. All measurements reported herein were performed by me and are correct to the best of my knowledge and belief. I assume full responsibility for the completeness of these measurements.



Duane M. Friesen, C.E.T.
EMC Manager
Celltech Labs Inc.

09Oct04
Date

Applicant:	Itronix Corporation	Model:	IX260PROA580BT	IC ID:	1943A-IX260Pf	FCC ID:	KBCIX260PROA580BT	
IX260+ Rugged Laptop PC with internal Intel Pro 2200BG 802.11b/g WLAN and Cirronet BT2022 Bluetooth								
2005 Celltech Labs Inc		This document is not to be reproduced in whole or in part without the written permission of Celltech Labs Inc.					41 of 42	

Test Report Serial No.:	022305KBC-T618-E15W/B	Issue 1.0
Test Date(s):	01Oct04 - 14Oct04	
Test Type(s):	FCC §15.247	IC RSS-210 Issue 5
Lab Registration(s):	FCC #714830	IC Lab File #3874

END OF DOCUMENT

Applicant:	Itronix Corporation	Model:	IX260PROA580BT	IC ID:	1943A-IX260Pf	FCC ID:	KBCIX260PROA580BT	
IX260+ Rugged Laptop PC with internal Intel Pro 2200BG 802.11b/g WLAN and Cirronet BT2022 Bluetooth								
2005 Celltech Labs Inc		This document is not to be reproduced in whole or in part without the written permission of Celltech Labs Inc.					42 of 42	