

<b>Test Report Serial No.:</b>	022305KBC-T618-E15W	Issue 1
<b>Test Date(s):</b>	28Jun04 - 29Jul04, 22Oct04	
<b>Test Type(s):</b>	FCC §15.247	IC RSS-210 Issue 5
<b>Lab Registration(s):</b>	FCC #714830	IC Lab File #3874

**EMC TEST REPORT**  
FOR THE  
**ITRONIX RUGGED LAPTOP PC MODEL: IX260PROA580BT**  
INCLUDING THE  
**INTEL PRO 2200BG 802.11B/G 2.4 GHz DSSS WLAN MINI-PCI CARD**  
WITH THE **RANGESTAR INTERNAL SURFACE-MOUNT ANTENNA**  
CO-LOCATED WITH  
**SIERRA WIRELESS DUAL-BAND CDMA PCMCIA MODEM**  
& **EXTERNAL SWIVEL DIPOLE ANTENNA**

TRSN: 022305KBC-T618-E15W  
Issue 1.0

**Celltech Compliance Testing & Engineering Lab**  
**(Celltech Labs Inc.)**  
**1955 Moss Court**  
**Kelowna, BC**  
**Canada**  
**V1Y 9L3**

**May 9, 2005**

Test Report Serial No.:	022305KBC-T618-E15W	Issue 1
Test Date(s):	28Jun04 - 29Jul04, 22Oct04	
Test Type(s):	FCC §15.247	IC RSS-210 Issue 5
Lab Registration(s):	FCC #714830	IC Lab File #3874

## DECLARATION OF COMPLIANCE

<b>Test Lab</b>		<b>CELLTECH LABS INC.</b> Testing and Engineering Services 1955 Moss Court Kelowna, B.C. Canada V1Y 9L3  Phone: 250-448-7047 Fax: 250-448-7048 e-mail: info@celltechlabs.com web site: www.celltechlabs.com		<b>Applicant</b>		<b>ITRONIX CORPORATION</b> 801 South Stevens Street Spokane, WA 99204 United States	
<b>Laboratory Registration No.(s):</b>		FCC:	714830	IC:	IC 3874		
<b>Rule Part(s):</b>		FCC:	§15.247; §2.1091; §1.1310	IC:	RSS-210 Issue 5		
<b>Device Classification:</b>		FCC:	Digital Transmission System (DTS)	IC:	Low Power License-Exempt Transmitter		
<b>Device Identification:</b>		FCC ID:	KBCIX260PROA580BT	IC:	1943A-IX260Pf		
<b>DUT Description:</b>							
<b>Model:</b>		IX260PROA580BT					
<b>Device Description:</b>		Rugged Laptop PC					
<b>Internal Transmitter:</b>		Intel Pro 2200BG 802.11b/g 2.4 GHz DSSS WLAN Mini-PCI Card					
<b>Co-located Transmitter(s):</b>		Sierra Wireless Dual-Band CDMA PCMCIA Modem					
<b>Tx Frequency Range:</b>		WLAN: 2412 - 2462 MHz					
<b>Max. RF Output Power:</b>		17.48 dBm / 0.056 Watts (Peak Conducted) - 802.11b 16.15 dBm / 0.041 Watts (Peak Conducted) - 802.11g					
<b>Modulation Type(s):</b>		WLAN: DBPSK, DQPSK, CCK					
<b>Antenna Type(s):</b>		WLAN: RangeStar P/N: 100929 Internal Surface-Mount (upper right side rear of LCD Display) CDMA: Itronix IX260+ External Swivel Dipole (upper right side edge of LCD Display)					
<b>Power Source(s):</b>		Stationary: 90 Watt AC Power Adapter			11.1V Lithium-ion Battery, 6.0Ah (Model: A2121-2)		

This wireless mobile device has demonstrated compliance with the applicable technical standards as indicated in the measurement report and was tested in accordance with the measurement procedures specified in FCC 47 CFR Part 15.247, Industry Canada RSS-210 Issue 5; and ANSI TIA/EIA-603-B-2002.

I attest to the accuracy of the data. All measurements reported herein were performed by me or were under my supervision and are correct to the best of my knowledge and belief. I assume full responsibility for the completeness of these measurements and vouch for the qualifications of all persons taking them.

This test report shall not be reproduced partially, or in full, without the prior written approval of Celltech Labs Inc. The results and statements contained in this report pertain only to the device(s) evaluated.



**Russell Pipe**  
Senior Compliance Technologist  
Celltech Labs Inc.



**Duane M. Friesen**  
EMC Manager  
Celltech Labs Inc.



<b>Applicant:</b>	Itronix Corporation	<b>IC ID:</b>	1943A-IX260Pf	<b>FCC ID:</b>	KBCIX260PROA580BT	
<b>Rugged Laptop PC with Intel Pro 2200BG 802.11b/g WLAN Mini-PCI Card</b>				<b>Model:</b>	IX260PROA580BT	
2005 Celltech Labs Inc. This document is not to be reproduced in whole or in part without the written permission of Celltech Labs Inc.						2 of 77

<b>Test Report Serial No.:</b>	022305KBC-T618-E15W	Issue 1
<b>Test Date(s):</b>	28Jun04 - 29Jul04, 22Oct04	
<b>Test Type(s):</b>	FCC §15.247	IC RSS-210 Issue 5
<b>Lab Registration(s):</b>	FCC #714830	IC Lab File #3874

## TABLE OF CONTENTS

1.0 SCOPE .....	6
2.0 REFERENCES .....	6
2.1 Normative References .....	6
3.0 TERMS AND DEFINITIONS .....	7
4.0 FACILITIES AND ACCREDITATIONS .....	8
5.0 GENERAL INFORMATION .....	8
5.1 Applicant Information .....	8
5.2 DUT Description.....	8
5.3 Co-Located Equipment .....	9
5.4 Cable Descriptions.....	9
5.5 Support Equipment .....	9
5.6 Clock Frequencies .....	10
5.7 Mode(s) of Operation Tested .....	10
5.8 Configuration Description .....	11
6.0 PASS/FAIL CRITERIA.....	11
APPENDICES.....	12
Appendix A - DUT Photographs .....	13
Appendix B - 6 dB Bandwidth Measurement.....	14
Appendix C - Peak Conducted Power Measurement.....	23
Appendix D - Maximum Permissible Exposure Calculation.....	26
Appendix E - Radiated Spurious Emissions Measurement.....	29
Appendix F - Restricted Band Emissions Measurement .....	48
Appendix G - Peak Power Spectral Density Measurement.....	62
Appendix H - Conducted Powerline Emissions Measurement .....	71
END OF DOCUMENT.....	77

<b>Test Report Serial No.:</b>	022305KBC-T618-E15W	Issue 1
<b>Test Date(s):</b>	28Jun04 - 29Jul04, 22Oct04	
<b>Test Type(s):</b>	FCC §15.247	IC RSS-210 Issue 5
<b>Lab Registration(s):</b>	FCC #714830	IC Lab File #3874

## FIGURES

Figure B-1 - Setup Drawing .....	15
Figure C-1 - Setup Drawing .....	24
Figure E-1 - Setup Drawing .....	30
Figure F-1 - Setup Drawing.....	50
Figure G-1 - Setup Drawing.....	63
Figure H-1 - Setup Drawing .....	73

## PLOTS

Plot B-1 - 6 dB Bandwidth Low Channel (802.11b) .....	16
Plot B-2 - 6 dB Bandwidth Mid Channel (802.11b).....	17
Plot B-3 - 6 dB Bandwidth High Channel (802.11b).....	18
Plot B-4 - 6 dB Bandwidth Low Channel (802.11g).....	19
Plot B-5 - 6 dB Bandwidth Mid Channel (802.11g).....	20
Plot B-6 - 6 dB Bandwidth High Channel (802.11g).....	21
Plot G-1 - PPSD Low Channel (802.11b) .....	64
Plot G-2 - PPSD Mid Channel (802.11b).....	65
Plot G-3 - PPSD High Channel (802.11b) .....	66
Plot G-4 - PPSD Low Channel (802.11g).....	67
Plot G-5 - PPSD Mid Channel (802.11g).....	68
Plot G-6 - PPSD High Channel (802.11g) .....	69
Plot H-1 - Line 1 Peak Conducted Powerline Emissions.....	75
Plot H-2 - Line 2 Peak Conducted Powerline Emissions.....	75

## PHOTOGRAPHS

Photograph A-1 - Front of Open IX260+ Laptop PC.....	13
Photograph A-2 - Back of Open IX260+ Laptop PC.....	13
Photograph A-3 - Left Side of Open IX260+ Laptop PC.....	13
Photograph A-4 - Right Side of Open IX260+ Laptop PC .....	13
Photograph E-1 - Vertical Polarization (1-18 GHz).....	31
Photograph E-2 - Vertical Polarization (18-26 GHz).....	31
Photograph E-3 - Front of Radiated Emission Configuration .....	31
Photograph E-4 - Back of Radiated Emission Configuration .....	31
Photograph F-1 - Horizontal Polarization (30MHz - 1 GHz).....	51
Photograph F-2 - Vertical Polarization (1-18 GHz).....	51
Photograph F-3 - Front of Radiated Emission Configuration.....	51
Photograph F-4 - Back of Radiated Emission Configuration.....	51
Photograph H-1 - AC Powerline Conducted Emission Configuration.....	72
Photograph H-2 - AC Powerline Conducted Emission Cable Placement.....	72



Test Report Serial No.:	022305KBC-T618-E15W	Issue 1
Test Date(s):	28Jun04 - 29Jul04, 22Oct04	
Test Type(s):	FCC §15.247	IC RSS-210 Issue 5
Lab Registration(s):	FCC #714830	IC Lab File #3874

TEST SUMMARY						
Appendix	Test Description	Procedure Reference	Limit Reference	Test Start Date	Test End Date	Result
<b>Referenced Standard: FCC CFR Title 47 Part 15</b>						
B	6 dB Bandwidth	FCC 97-114	§15.247(2)	26Jul04	26Jul04	Pass
C	Peak Conducted Power	FCC 97-114	§15.247 (b) (3)	28Jun04	26Jul04	Pass
D	Maximum Permissible Exposure	FCC CFR 47 § 2.1091 IEEE Std C95.1-1999	§1.1310 Table 1 (b)	28Jun04	28Jun04	Pass
E	Radiated Spurious Emissions	FCC 97-114	§15.247(c)	26Jul04	29Jul04 22Oct04	Pass
F	Restricted Band Emissions	FCC 97-114	§15.205 (a), (b) §15.209 (a)	26Jul04	29Jul04 22Oct04	Pass
G	Peak Power Spectral Density	FCC 97-114	§15.247(d)	27Jul04	27Jul04	Pass
H	Powerline Conducted Emissions	ANSI C63.4	§15.207	29Jun04	5Jul04	Pass
<b>Referenced Standard: IC RSS-210 Issue 5</b>						
B	6 dB Bandwidth	RSS-210 § 10	RSS-210 A1 §(l)(iv)	26Jul04	26Jul04	Pass
C	Peak Conducted Power	RSS-210 § 10	RSS-210 A1 §(l)(iv) RSS-210 §6.2.2 (o)(b)	28Jun04	26Jul04	Pass
D	Maximum Permissible Exposure	RSS-102	RSS-210 §14 Safety Code 6 2.2.1(a) Table 5	28Jun04	28Jun04	Pass
E	Radiated Spurious Emissions	RSS-212, ANSI C63.4	RSS-210 §6.2.2 (o)(e1)	26Jul04	29Jul04 22Oct04	Pass
F	Restricted Band Emissions	RSS-212, ANSI C63.4	RSS-210 §6.3	26Jul04	29Jul04 22Oct04	Pass
G	Peak Power Spectral Density	RSS-210 § 10	RSS-210 §6.2.2 (o)(b)	27Jul04	27Jul04	Pass
H	Powerline Conducted Emissions	RSS-212, ANSI C63.4	RSS-210 §6.6	29Jun04	5Jul04	Pass

### REVISION LOG

Issue	Description	Implemented By	Implementation Date
1.0	Initial Release	Jon Hughes	09May05

### SIGNATORIES

Prepared By		May 09, 2005
Name/Title	Duane M. Friesen, C.E.T. / EMC Manager	Date
Reviewed By		May 09, 2005
Name/Title	Jon Hughes / General Manager	Date

Applicant:	Itronix Corporation	IC ID:	1943A-IX260Pf	FCC ID:	KBCIX260PROA580BT	
Rugged Laptop PC with Intel Pro 2200BG 802.11b/g WLAN Mini-PCI Card				Model:	IX260PROA580BT	
2005 Celltech Labs Inc. This document is not to be reproduced in whole or in part without the written permission of Celltech Labs Inc.						5 of 77

<b>Test Report Serial No.:</b>	022305KBC-T618-E15W	Issue 1
<b>Test Date(s):</b>	28Jun04 - 29Jul04, 22Oct04	
<b>Test Type(s):</b>	FCC §15.247	IC RSS-210 Issue 5
<b>Lab Registration(s):</b>	FCC #714830	IC Lab File #3874

## 1.0 SCOPE

This report outlines the measurements made and results collected during the Electromagnetic emissions testing of the Itronix Corporation Rugged Laptop PC including the internal Intel Pro 2200BG 802.11b/g 2.4 GHz DSSS WLAN Mini-PCI Card with a RangeStar internal surface-mount antenna located in the upper right side rear of the LCD display. The DUT also incorporates an internal co-located Sierra Wireless Dual-Band CDMA PCMCIA Modem with external swivel dipole antenna located at the upper right side edge of the LCD display. **The Intel Pro 2200BG 802.11b/g WLAN and Sierra Wireless CDMA Modem do not transmit simultaneously.** The results were applied against the EMC requirements and limits outlined in the technical rules and regulations set forth in the Federal Communication Commission Code of Federal Regulations Title 47 Part 15 Subpart C, and Industry Canada Radio Standards Specifications RSS-210 Issue 5.

## 2.0 REFERENCES

### 2.1 Normative References

ANSI/ISO 17025:1999	General Requirements for competence of testing and calibration laboratories
IEEE/ANSI C63.4-2003	Methods of Measurement of Radio-Noise Emissions from Low-Voltage Electrical and Electronic Equipment in the Range of 9 kHz to 40 GHz
IEEE/ANSI Std C95.1-1999	American National Standard Safety Levels with Respect to Human Exposure to Radio Frequency Electromagnetic Fields
CFR Title 47 Part 2:2003	Code of Federal Regulations Title 47: Telecommunication Part 2: Frequency Allocations and Radio Treaty Matters; General Rules and Regulations
CFR Title 47 Part 15:2003	Code of Federal Regulations Title 47: Telecommunication Part 15: Radio Frequency Devices
IC Spectrum Management & Telecommunications Policy	Radio Standards Specification RSS-212 Issue 1 (Provisional) - Test Facilities & Test Methods for Radio Equipment RSS-210 Issue 5 - Low Power Licence-Exempt Radiocommunication Devices: Amendment November 30, 2002 RSS-102 Issue 1 (Provisional) - Evaluation Procedure for Mobile and Portable Radio Transmitters with respect to Health Canada's Safety Code 6 for Exposure of Humans to Radio Frequency Fields

<b>Applicant:</b>	Itronix Corporation	<b>IC ID:</b>	1943A-IX260Pf	<b>FCC ID:</b>	KBCIX260PROA580BT	
<b>Rugged Laptop PC with Intel Pro 2200BG 802.11b/g WLAN Mini-PCI Card</b>				<b>Model:</b>	IX260PROA580BT	
2005 Celltech Labs Inc. This document is not to be reproduced in whole or in part without the written permission of Celltech Labs Inc.						6 of 77

<b>Test Report Serial No.:</b>	022305KBC-T618-E15W	Issue 1
<b>Test Date(s):</b>	28Jun04 - 29Jul04, 22Oct04	
<b>Test Type(s):</b>	FCC §15.247	IC RSS-210 Issue 5
<b>Lab Registration(s):</b>	FCC #714830	IC Lab File #3874

### 3.0 TERMS AND DEFINITIONS

AVG	Average
CFR	Code of Federal Regulations
dB	decibel
dBm	dB referenced to 1 mW
dBuV	dB referenced to 1 uV
DUT	Device under Test
dBc	dB down from carrier
EBW	Emission Bandwidth
EMC	Electromagnetic Compatibility
FCC	Federal Communication Commission
HP	Hewlett Packard
HPF	High Pass Filter
Hpol	Horizontal Polarization
IC	Industry Canada
kHz	kilohertz
LNA	Low Noise Amplifier
m	meter
MHz	Megahertz
Mbps	megabits per second
na	not applicable
n/a	not available
PK	Peak
PPSD	Peak Power Spectral Density
QP	Quasi-peak
RBW	Resolution Bandwidth
R&S	Rohde & Schwarz
RSS	Radio Standard Specification
SA	Spectrum Analyzer
VBW	Video Bandwidth
Vpol	Vertical Polarization
WLAN	Wireless Local Area Network



<b>Test Report Serial No.:</b>	022305KBC-T618-E15W	Issue 1
<b>Test Date(s):</b>	28Jun04 - 29Jul04, 22Oct04	
<b>Test Type(s):</b>	FCC §15.247	IC RSS-210 Issue 5
<b>Lab Registration(s):</b>	FCC #714830	IC Lab File #3874

#### 4.0 FACILITIES AND ACCREDITATIONS

The facilities used in collecting the test results outlined in this report are located at 1955 Moss Court, Kelowna, British Columbia, Canada, V1Y 9L3. The radiated and conducted emissions sites conform with the requirements set forth in ANSI C63.4 and are filed and listed with the FCC under Registration Number 714830 and Industry Canada under File Number IC 3874.

#### 5.0 GENERAL INFORMATION

##### 5.1 Applicant Information

<b>Company Name:</b>	<b>Itronix Corporation</b>
<b>Address:</b>	801 South Stevens Street Spokane, WA 99204 United States

##### 5.2 DUT Description

The DUT consisted of the Rugged Laptop PC with Intel Pro 2200BG 802.11b/g 2.4 GHz DSSS WLAN Mini-PCI Card installed in the Mini-PCI slot, and Internal Surface-Mount Antenna installed in the upper right side rear of the LCD display. The DUT also incorporates an internal co-located Sierra Wireless Dual-Band CDMA PCMCIA Modem with external swivel dipole antenna located at the upper right side edge of the LCD display. Photographs of the DUT placement and construction are shown in Appendix A.

<b>Device:</b>	Rugged Laptop PC		
<b>Model:</b>	IX260PROA580BT		
<b>Serial Number:</b>	ZZGEG4196ZZ6473		
<b>Identifier(s):</b>	<b>FCC ID:</b>	KBCIX260PROA580BT	<b>IC ID:</b> 1943A-IX260Pf
<b>Power Source(s):</b>	Delta Electronics Model ADP-90AB Rev B 90 Watt AC-DC power supply 11.1 V Lithium-ion Battery, 6.0 Ah (Model: A2121-2)		

<b>Device:</b>	2.4GHz DSSS WLAN Mini-PCI Card (802.11b/g)		
<b>Model:</b>	Intel Pro2200BG		
<b>Serial Number:</b>	06036C074ADC54906006		
<b>Rule Part(s):</b>	<b>FCC:</b>	§15.247; §2.1091; §1.1310	<b>IC:</b> RSS-210 Issue 5
<b>Classification:</b>	<b>FCC:</b>	Digital Transmission System (DTS)	<b>IC:</b> Low Power Licence-Exempt Transmitter
<b>Power Source:</b>	Powered from the internal PC power supply		

<b>Device:</b>	Internal Surface-Mount Antenna (upper right side rear of LCD display)		
<b>Model:</b>	RangeStar P/N: 100929		
<b>Gain:</b>	+4.5 dBi		

<b>Applicant:</b>	Itronix Corporation	<b>IC ID:</b>	1943A-IX260Pf	<b>FCC ID:</b>	KBCIX260PROA580BT	
<b>Rugged Laptop PC with Intel Pro 2200BG 802.11b/g WLAN Mini-PCI Card</b>					<b>Model:</b>	
2005 Celltech Labs Inc. This document is not to be reproduced in whole or in part without the written permission of Celltech Labs Inc. 8 of 77						



<b>Test Report Serial No.:</b>	022305KBC-T618-E15W	Issue 1
<b>Test Date(s):</b>	28Jun04 - 29Jul04, 22Oct04	
<b>Test Type(s):</b>	FCC §15.247	IC RSS-210 Issue 5
<b>Lab Registration(s):</b>	FCC #714830	IC Lab File #3874

### 5.3 Co-Located Equipment

<b>Device:</b>	Dual-Band PCS/Cellular CDMA PCMCIA Modem
<b>Model:</b>	Sierra Wireless AirCard
<b>Antenna:</b>	External Swivel Dipole Antenna (upper right side edge of LCD display)
<b>Model:</b>	Itronix IX260+
<b>Gain:</b>	+2.6 dBi

<b>Device:</b>	GPS Receiver Module and Antenna (Receive only)
<b>Model:</b>	Leadtek P/N: GPS9547

### 5.4 Cable Descriptions

ROUTING		Length m	Model	Terminations		Shield Type	Shield Termination		Suppression
From	To			End 1	End 2		End 1	End 2	
PC Fire Wire Port	Unterminated	1.0	Copartner E119932	IEEE-1528	Fire wire	n/a	n/a	n/a	None
PC modem port	Unterminated	1.0	n/a	RJ-11	RJ-11	None	na	na	None

### 5.5 Support Equipment

The following equipment was used in support of the DUT.

CO-LOCATED SUPPORT EQUIPMENT LIST		
MANUFACTURER	MODEL	DESCRIPTION
D-Link	DE-809TC/	Ethernet hub
YNG YUH	YP-040	Hub power supply
MLi	699	Speakers
Polk Audio	n/a	Speaker-microphone
DeLorme	Tripmate	GPS Receiver
Intel	CS-430	Camera
Logitech	M-S34	Mouse

## 5.6 Clock Frequencies

### 5.6.1 DUT Clock Frequencies

<b>Device:</b>	Rugged Laptop PC
<b>Clocks:</b>	1.6 GHz processor
<b>Name:</b>	2.4GHz DSSS 802.11b/g WLAN Mini-PCI Card
<b>Clocks:</b>	40 MHz, $f_o/1.5$ (Low - 1608.000 MHz, Mid - 1624.667 MHz, High - 1641.333 MHz)
<b>Name:</b>	Internal Surface-Mount Antenna (WLAN)
<b>Clocks:</b>	None

### 5.6.2 Co-Located Clock Frequencies

<b>Device:</b>	Peripherals
<b>Clocks:</b>	n/a

## 5.7 Mode(s) of Operation Tested

Customer supplied software was used to place the WLAN card in the appropriate mode, channel and power level for the specific measurement.

<b>TX Frequency Range:</b>	2412 - 2462 MHz Ch. 1 (2412 MHz), Ch. 6 (2437 MHz) & Ch. 11 (2462 MHz) measured unless otherwise noted	
<b>Software Power Gain Settings:</b>	802.11b set to 29 802.11g set to 24.5	
<b>RF Peak Conducted Output Power Tested:</b>	802.11b 2412 MHz(1 Mbps) = 16.28 dBm 802.11b 2437 MHz(1 Mbps) = 16.79 dBm 802.11b 2462 MHz(1 Mbps) = 17.48 dBm	802.11g 2412 MHz(6 Mbps) = 15.14 dBm 802.11g 2437 MHz(6 Mbps) = 15.55 dBm 802.11g 2462 MHz(6 Mbps) = 16.15 dBm
<b>Modes / Data Rates Tested:</b>	802.11b (1, 5.5, 11 Mbps checked in prescan) (1 Mbps determined to be worst-case and used unless otherwise noted)	
	802.11g (6, 36, 54 Mbps checked in prescan) (6 Mbps determined to be worst-case and used unless otherwise noted)	
<b>Modulation Type:</b>	OFDM with BPSK, QPSK, 16QAM, 64QAM, DBPSK, DQPSK, CCK	

<b>Test Report Serial No.:</b>	022305KBC-T618-E15W	Issue 1
<b>Test Date(s):</b>	28Jun04 - 29Jul04, 22Oct04	
<b>Test Type(s):</b>	FCC §15.247	IC RSS-210 Issue 5
<b>Lab Registration(s):</b>	FCC #714830	IC Lab File #3874

### 5.7.1 DUT Exercising Software Description

The DUT was configured and exercised using customer supplied test software that allowed an operator to set the parameters of the WLAN operation. The settings used are described in each appendix. Unless otherwise noted the power gain settings were set for 29 for 802.11b and 24.5 for 802.11g and the data rate set for 1 Mbps for 802.11b and 6 Mbps for 802.11g.

### 5.8 Configuration Description

The DUT was configured, as described by the client as being representative of what would be delivered to an end customer. This configuration included the radio modem and antenna as described in section 5.2 installed in a typical manner. More specific details may be included in each appendix.

#### 5.8.1 Configuration Justification

The DUT was tested in a configuration described by the client as being worst-case but typical of normal use.

Prescan measurements were made with the WLAN in each of the two available modes (b & g), low, mid, and high bit rates, and the low, mid, and high frequencies of the band. From this preliminary data, it was determined that Channel 11, Mode b Rate 1 Mbps resulted in the highest emissions. When a measurement of Mode g was required, its data rate was set for a worst-case setting of 6 Mbps. Unless otherwise specified in the applicable appendices, these settings were used for the measurements described in this report.

## 6.0 PASS/FAIL CRITERIA

Unless otherwise noted in the Appendices, the pass/fail criteria is the limit set forth in the reference standards. A DUT is considered to have passed the requirements, if the data collected during the described measurement procedure is less than or equal to the specified limits as defined. The pass/fail statements made in this report only apply to the unit tested.

<b>Applicant:</b>	Itronix Corporation	<b>IC ID:</b>	1943A-IX260Pf	<b>FCC ID:</b>	KBCIX260PROA580BT	
<b>Rugged Laptop PC with Intel Pro 2200BG 802.11b/g WLAN Mini-PCI Card</b>				<b>Model:</b>	IX260PROA580BT	
2005 Celltech Labs Inc. This document is not to be reproduced in whole or in part without the written permission of Celltech Labs Inc.						11 of 77

<b>Test Report Serial No.:</b>	022305KBC-T618-E15W	Issue 1
<b>Test Date(s):</b>	28Jun04 - 29Jul04, 22Oct04	
<b>Test Type(s):</b>	FCC §15.247	IC RSS-210 Issue 5
<b>Lab Registration(s):</b>	FCC #714830	IC Lab File #3874

## APPENDICES

<b>Applicant:</b>	Itronix Corporation	<b>IC ID:</b>	1943A-IX260Pf	<b>FCC ID:</b>	KBCIX260PROA580BT	
<b>Rugged Laptop PC with Intel Pro 2200BG 802.11b/g WLAN Mini-PCI Card</b>				<b>Model:</b>	IX260PROA580BT	
2005 Celltech Labs Inc. This document is not to be reproduced in whole or in part without the written permission of Celltech Labs Inc.						12 of 77

<b>Test Report Serial No.:</b>	022305KBC-T618-E15W	Issue 1
<b>Test Date(s):</b>	28Jun04 - 29Jul04, 22Oct04	
<b>Test Type(s):</b>	FCC §15.247	IC RSS-210 Issue 5
<b>Lab Registration(s):</b>	FCC #714830	IC Lab File #3874

### Appendix A - DUT Photographs

Photograph A-1 - Front of Open IX260+ Laptop PC



Photograph A-2 - Back of Open IX260+ Laptop PC



Photograph A-3 - Left Side of Open IX260+ Laptop PC



Photograph A-4 - Right Side of Open IX260+ Laptop PC



<b>Applicant:</b>	Itronix Corporation	<b>IC ID:</b>	1943A-IX260Pf	<b>FCC ID:</b>	KBCIX260PROA580BT	
<b>Rugged Laptop PC with Intel Pro 2200BG 802.11b/g WLAN Mini-PCI Card</b>				<b>Model:</b>	IX260PROA580BT	
2005 Celltech Labs Inc. This document is not to be reproduced in whole or in part without the written permission of Celltech Labs Inc.						13 of 77

Test Report Serial No.:	022305KBC-T618-E15W	Issue 1
Test Date(s):	28Jun04 - 29Jul04, 22Oct04	
Test Type(s):	FCC §15.247	IC RSS-210 Issue 5
Lab Registration(s):	FCC #714830	IC Lab File #3874

### Appendix B - 6 dB Bandwidth Measurement

B.1. REFERENCES	
Normative Reference Standard	FCC CFR 47 §15.247 (2)
Procedure Reference	FCC 97-114

B.2. LIMITS	
B.2.1. FCC CFR 47	
FCC CFR 47 §15.247	(2) Systems using digital modulation techniques may operate in the 902-928 MHz, 2400-2483.5 MHz, and 5725-5850 MHz bands. The minimum 6 dB bandwidth shall be at least 500 kHz

B.3. ENVIRONMENTAL CONDITIONS	
Temperature	25.2 +/- 2 °C
Humidity	35 +/- 2 %
Barometric Pressure	96.34 kPa

B.4. EQUIPMENT LIST					
ASSET NUMBER	MANUFACTURER	MODEL	DESCRIPTION	LAST CAL	CAL DUE
00072	EMCO	2075	Mini-mast	n/a	n/a
00073	EMCO	2080	Turn Table	n/a	n/a
00071	EMCO	2090	Multi-Device Controller	n/a	n/a
00035	ETS	3115	Double Ridged Guide Horn	24Mar04	24Mar05
00015	Agilent	E4408B	Spectrum Analyzer	29Dec03	29Dec04
00048	Gore	65474	Microwave Cable	20May04	20May05

Applicant:	Itronix Corporation	IC ID:	1943A-IX260Pf	FCC ID:	KBCIX260PROA580BT	
Rugged Laptop PC with Intel Pro 2200BG 802.11b/g WLAN Mini-PCI Card				Model:	IX260PROA580BT	
2005 Celltech Labs Inc. This document is not to be reproduced in whole or in part without the written permission of Celltech Labs Inc.						14 of 77

### B.5. MEASUREMENT EQUIPMENT SETUP

<b>Measurement Equipment Connections</b>	The equipment was connected as shown in the setup drawing in B.6.
<b>Measurement Equipment Settings</b>	The following spectrum analyzer settings were use for these measurements: RBW – 100 kHz VBW – 300 kHz Span – 30 MHz

### B.6. SETUP DRAWING

Figure B-1 - Setup Drawing

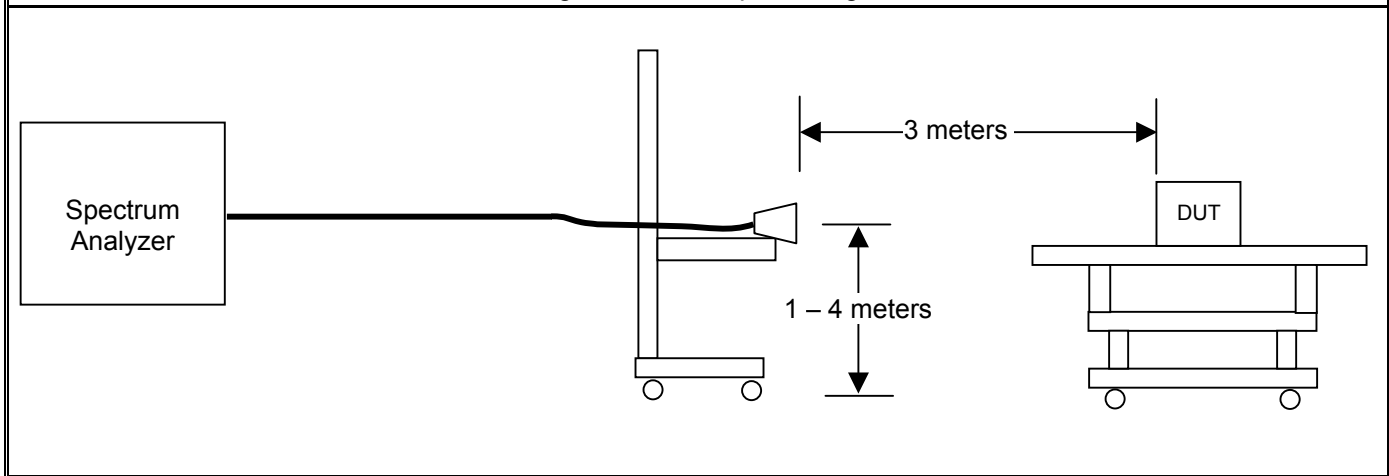

### B.7. DUT OPERATING DESCRIPTION

The worst-case data rate was determined from prescan investigations. Measurements were made at three channels throughout the band, Low Channel (2412 MHz), Mid Channel (2437 MHz), High Channel (2462 MHz) and for both Modes b and g.

### B.8. TEST RESULTS

Channel	Frequency	802.11b			802.11g		
		6 dB Bandwidth	Limit	Data Rate	6 dB Bandwidth	Limit	Data Rate
		MHz	kHz	Mbps	kHz	kHz	Mbps
Low	2412	9127	>500	1	16444	>500	6
Mid	2437	9553	>500	1	16379	>500	6
High	2462	9169	>500	1	16402	>500	6



Test Report Serial No.:	022305KBC-T618-E15W	Issue 1
Test Date(s):	28Jun04 - 29Jul04, 22Oct04	
Test Type(s):	FCC §15.247	IC RSS-210 Issue 5
Lab Registration(s):	FCC #714830	IC Lab File #3874

Plot B-1 - 6 dB Bandwidth Low Channel (802.11b)

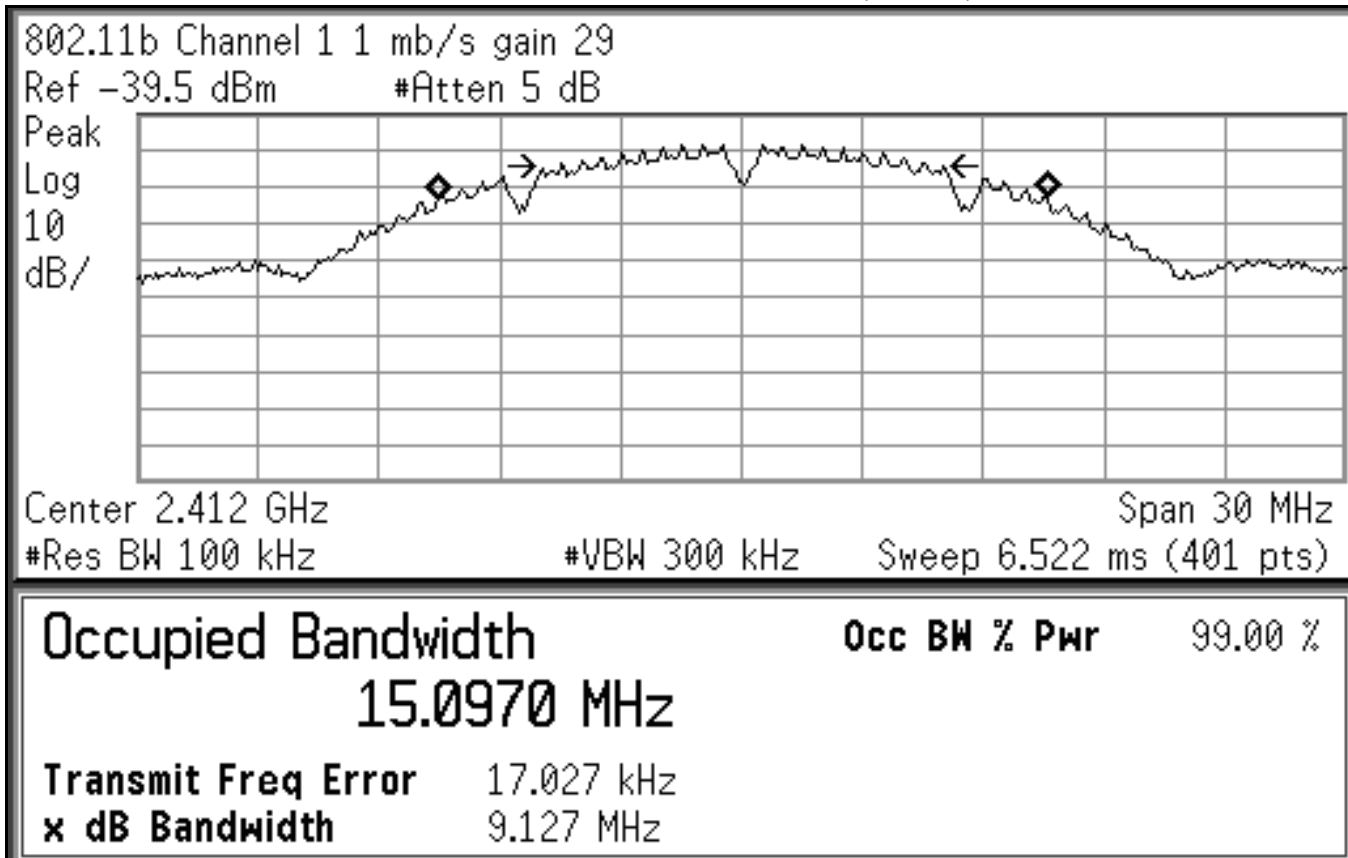

Test Report Serial No.:	022305KBC-T618-E15W	Issue 1
Test Date(s):	28Jun04 - 29Jul04, 22Oct04	
Test Type(s):	FCC §15.247	IC RSS-210 Issue 5
Lab Registration(s):	FCC #714830	IC Lab File #3874

Plot B-2 - 6 dB Bandwidth Mid Channel (802.11b)

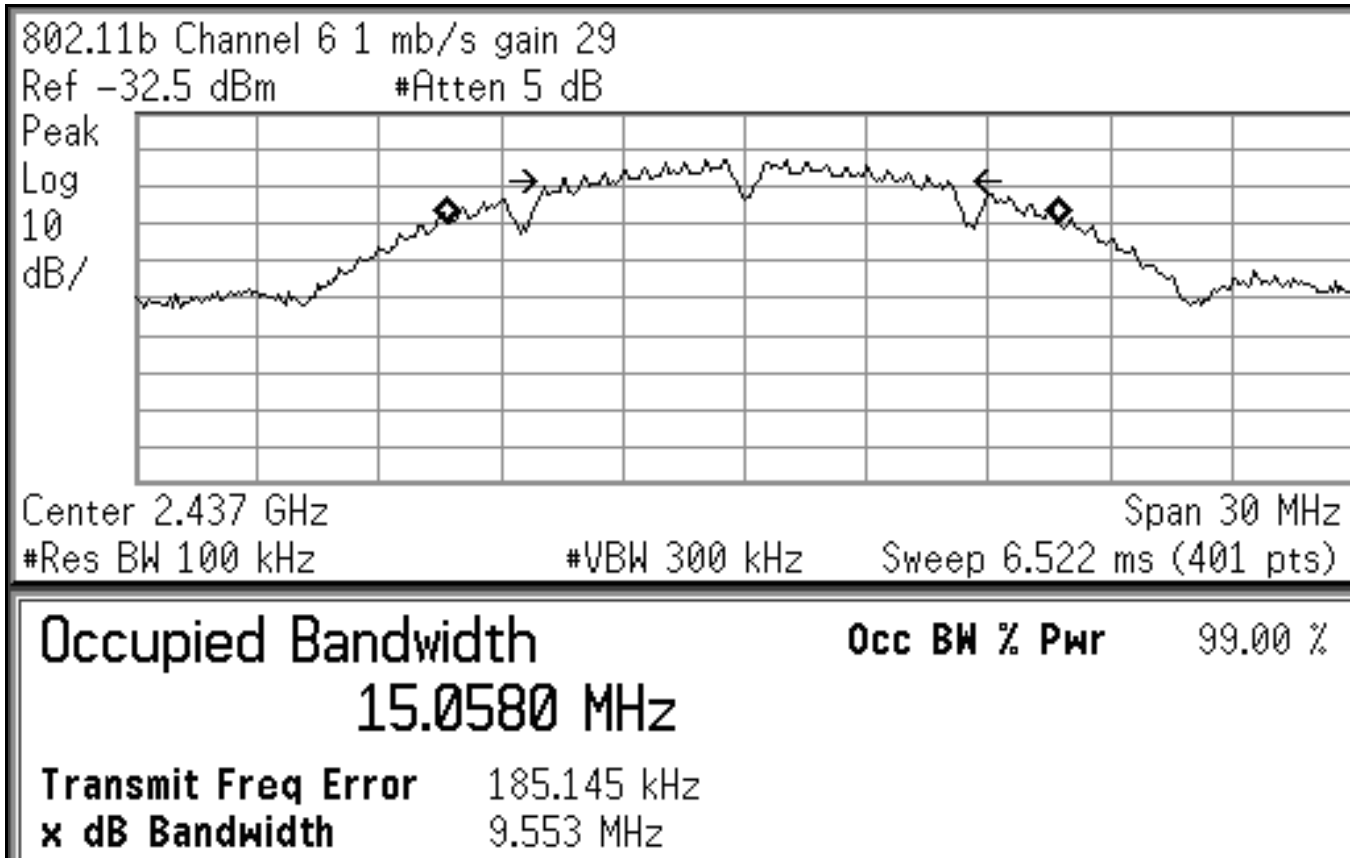

Applicant:	Itronix Corporation	IC ID:	1943A-IX260Pf	FCC ID:	KBCIX260PROA580BT	
Rugged Laptop PC with Intel Pro 2200BG 802.11b/g WLAN Mini-PCI Card				Model:	IX260PROA580BT	
2005 Celltech Labs Inc. This document is not to be reproduced in whole or in part without the written permission of Celltech Labs Inc.						17 of 77

Test Report Serial No.:	022305KBC-T618-E15W	Issue 1
Test Date(s):	28Jun04 - 29Jul04, 22Oct04	
Test Type(s):	FCC §15.247	IC RSS-210 Issue 5
Lab Registration(s):	FCC #714830	IC Lab File #3874

Plot B-3 - 6 dB Bandwidth High Channel (802.11b)

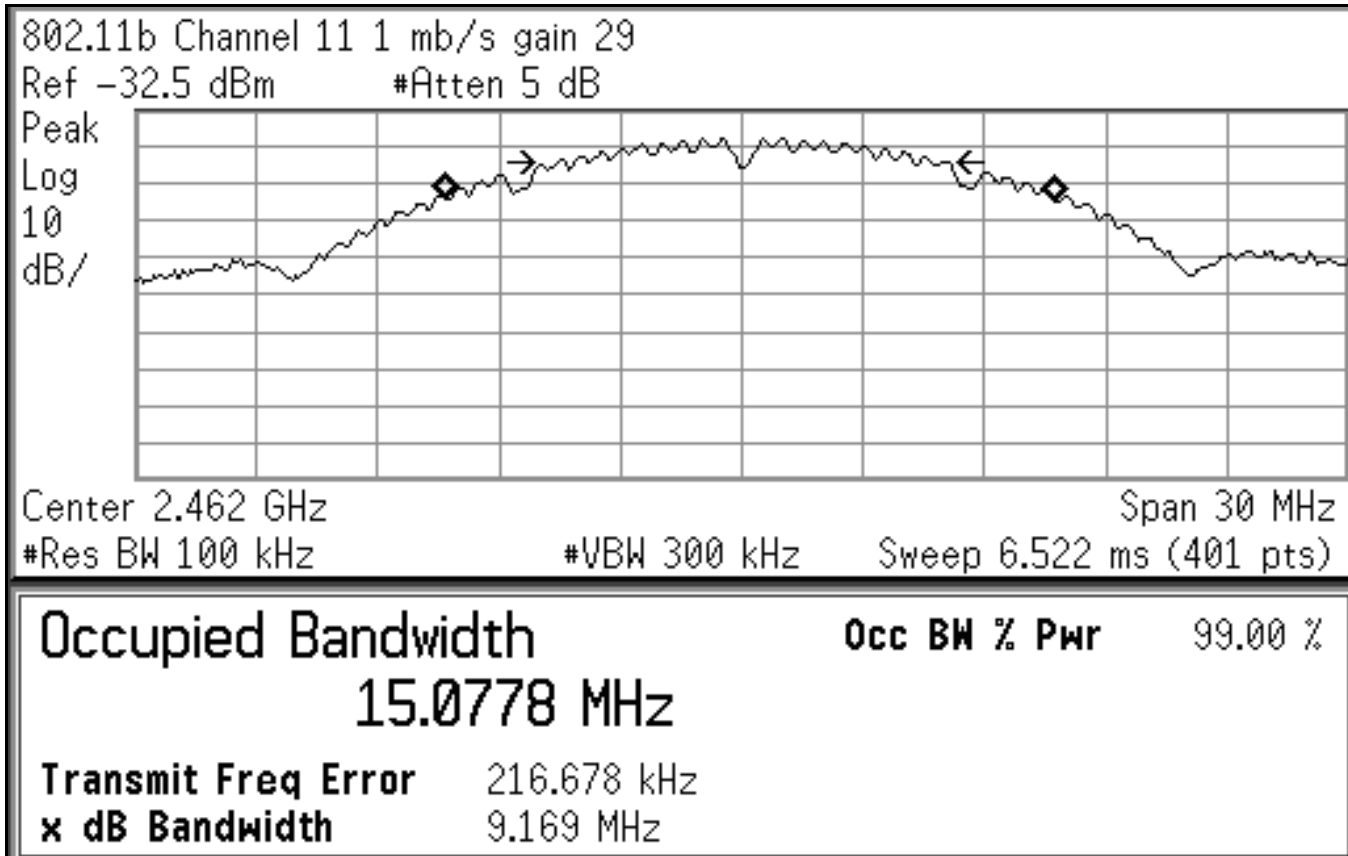

Applicant:	Itronix Corporation	IC ID:	1943A-IX260Pf	FCC ID:	KBCIX260PROA580BT	
Rugged Laptop PC with Intel Pro 2200BG 802.11b/g WLAN Mini-PCI Card				Model:	IX260PROA580BT	
2005 Celltech Labs Inc. This document is not to be reproduced in whole or in part without the written permission of Celltech Labs Inc.						18 of 77

Test Report Serial No.:	022305KBC-T618-E15W	Issue 1
Test Date(s):	28Jun04 - 29Jul04, 22Oct04	
Test Type(s):	FCC §15.247	IC RSS-210 Issue 5
Lab Registration(s):	FCC #714830	IC Lab File #3874

Plot B-4 - 6 dB Bandwidth Low Channel (802.11g)

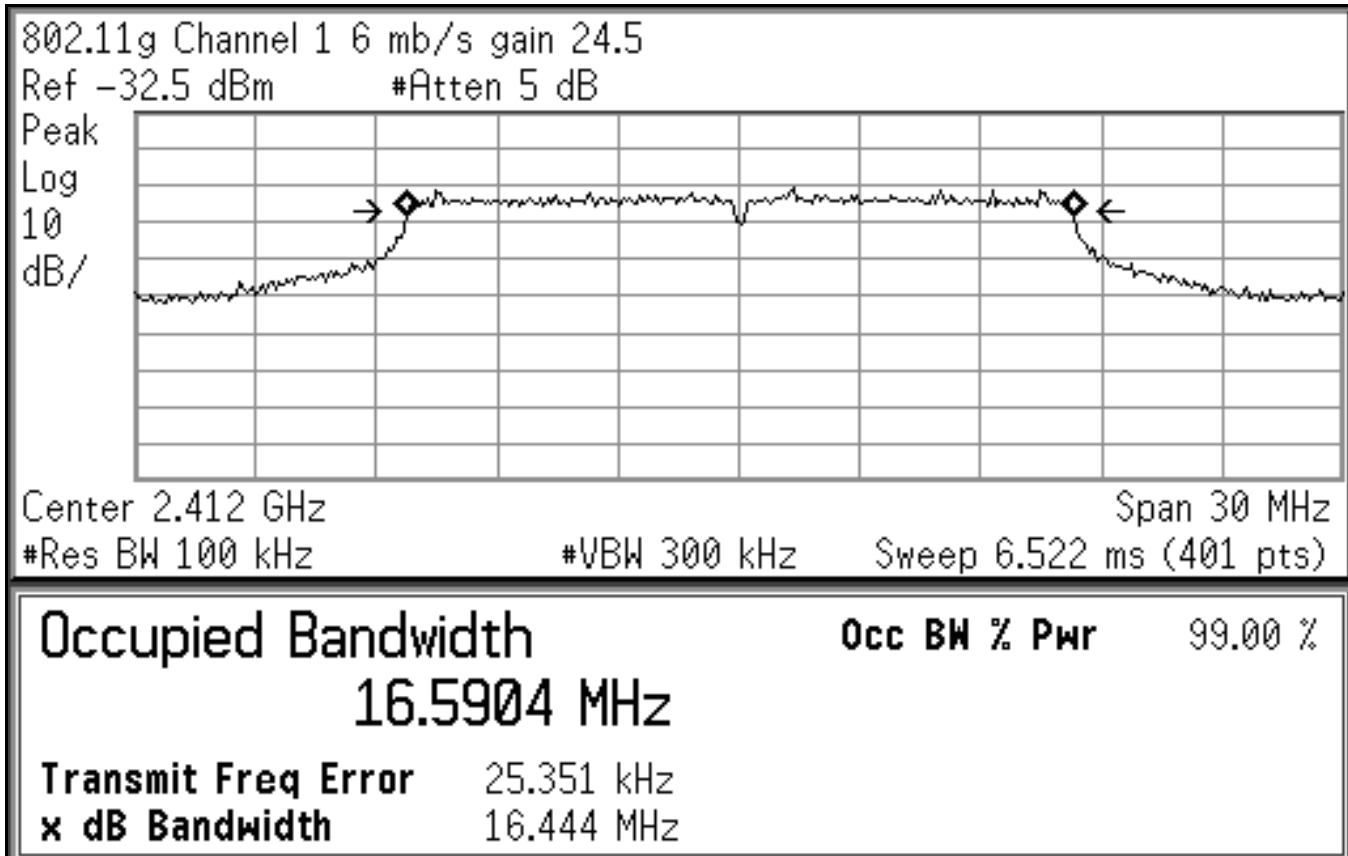

Applicant:	Itronix Corporation	IC ID:	1943A-IX260Pf	FCC ID:	KBCIX260PROA580BT	
Rugged Laptop PC with Intel Pro 2200BG 802.11b/g WLAN Mini-PCI Card				Model:	IX260PROA580BT	
2005 Celltech Labs Inc. This document is not to be reproduced in whole or in part without the written permission of Celltech Labs Inc.						19 of 77

Test Report Serial No.:	022305KBC-T618-E15W	Issue 1
Test Date(s):	28Jun04 - 29Jul04, 22Oct04	
Test Type(s):	FCC §15.247	IC RSS-210 Issue 5
Lab Registration(s):	FCC #714830	IC Lab File #3874

Plot B-5 - 6 dB Bandwidth Mid Channel (802.11g)

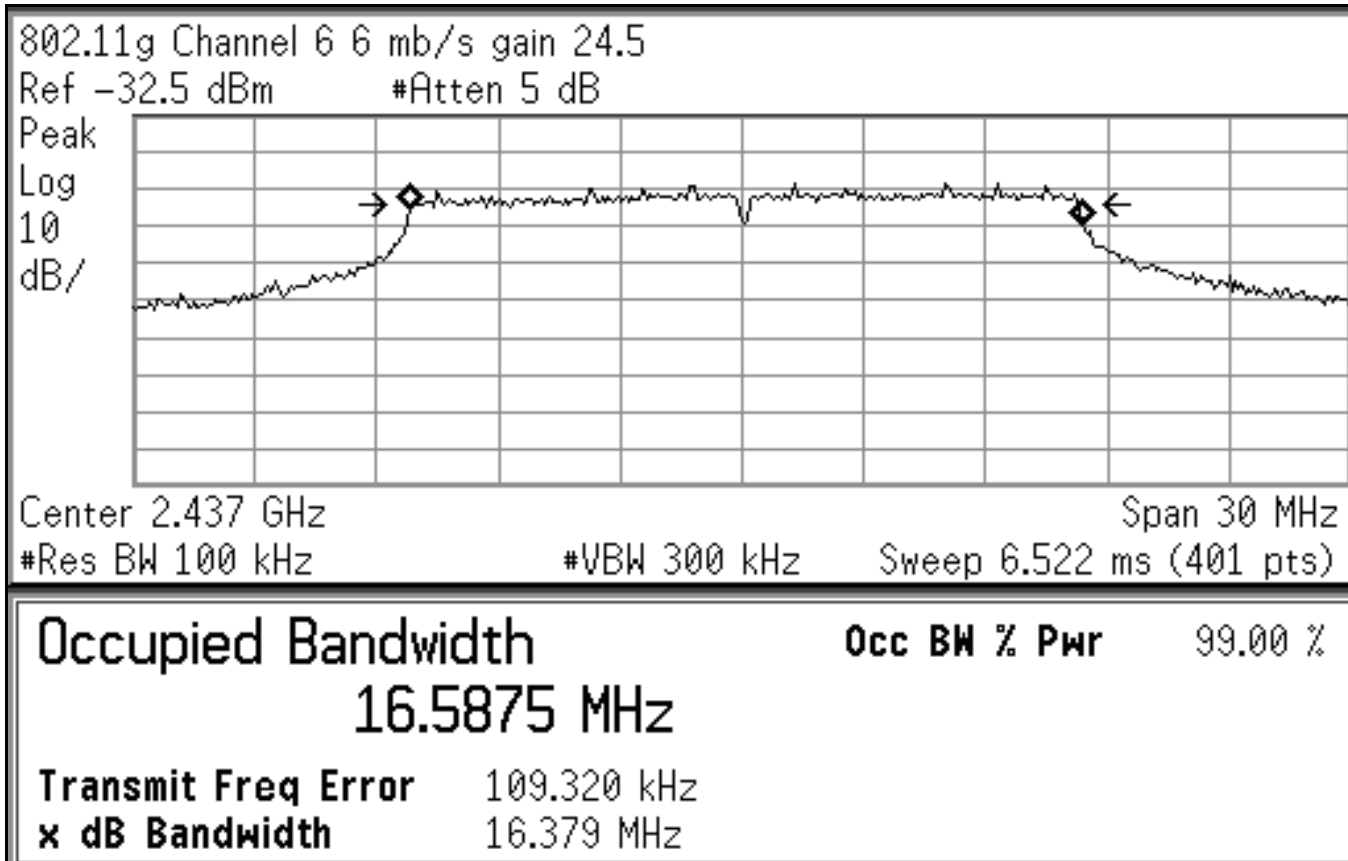

Applicant:	Itronix Corporation	IC ID:	1943A-IX260Pf	FCC ID:	KBCIX260PROA580BT	
Rugged Laptop PC with Intel Pro 2200BG 802.11b/g WLAN Mini-PCI Card				Model:	IX260PROA580BT	
2005 Celltech Labs Inc. This document is not to be reproduced in whole or in part without the written permission of Celltech Labs Inc.						20 of 77

Test Report Serial No.:	022305KBC-T618-E15W	Issue 1
Test Date(s):	28Jun04 - 29Jul04, 22Oct04	
Test Type(s):	FCC §15.247	IC RSS-210 Issue 5
Lab Registration(s):	FCC #714830	IC Lab File #3874

Plot B-6 - 6 dB Bandwidth High Channel (802.11g)

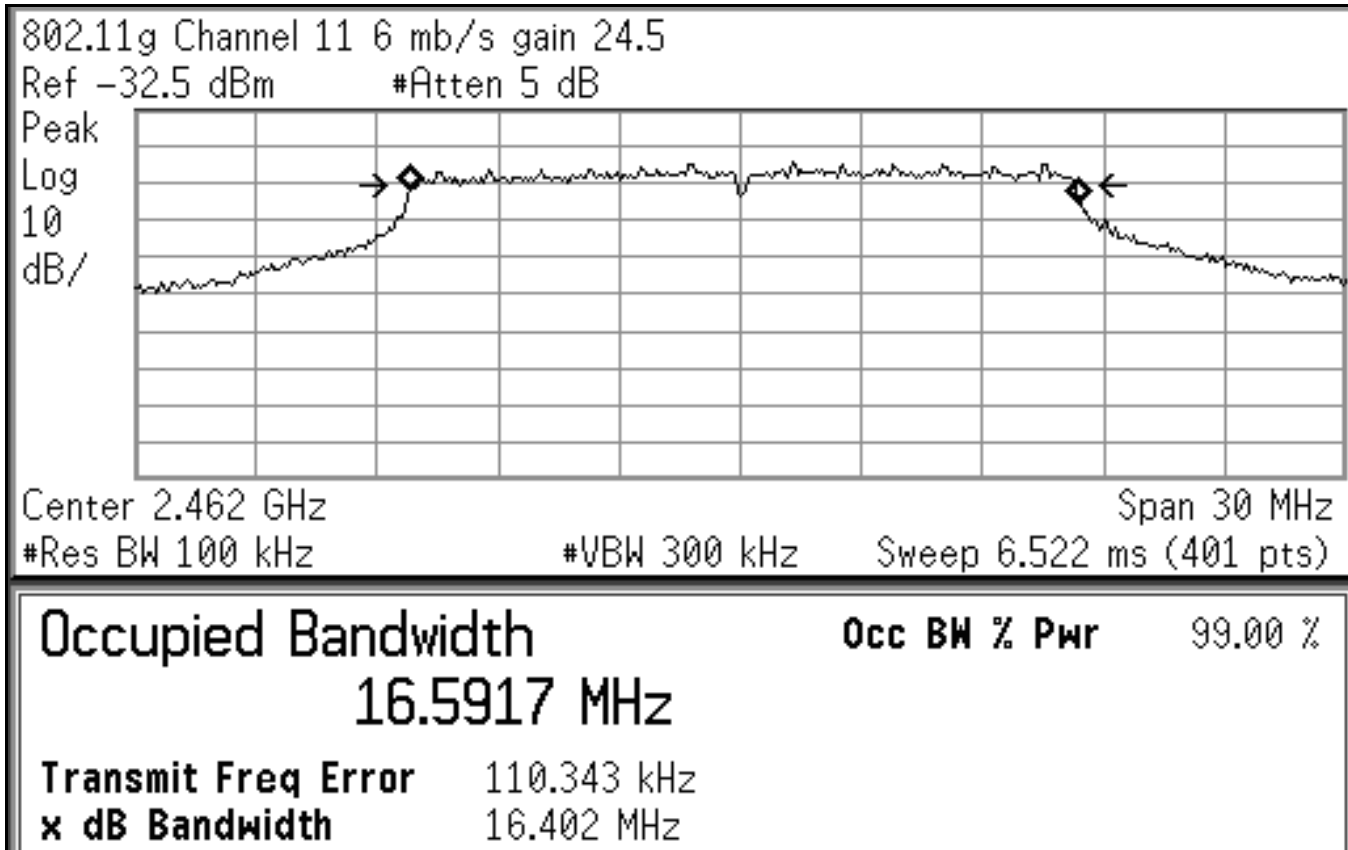

<b>Test Report Serial No.:</b>	022305KBC-T618-E15W	Issue 1
<b>Test Date(s):</b>	28Jun04 - 29Jul04, 22Oct04	
<b>Test Type(s):</b>	FCC §15.247	IC RSS-210 Issue 5
<b>Lab Registration(s):</b>	FCC #714830	IC Lab File #3874

**B.9. PASS/FAIL**

In reference to the results outlined in B.8 the DUT passes the requirements as stated in the reference standards as follows:  
 FCC 15.247 (2): The 6 dB bandwidth as measured meets the minimum 500 kHz bandwidth requirement.

**B.10. SIGN-OFF**

I attest to the accuracy of the data. All measurements reported herein were performed by me and are correct to the best of my knowledge and belief. I assume full responsibility for the completeness of these measurements.



\_\_\_\_\_  
 Duane M. Friesen, C.E.T.  
 EMC Manager  
 Celltech Labs Inc.

\_\_\_\_\_  
 04Aug04

Date



Test Report Serial No.:	022305KBC-T618-E15W	Issue 1
Test Date(s):	28Jun04 - 29Jul04, 22Oct04	
Test Type(s):	FCC §15.247	IC RSS-210 Issue 5
Lab Registration(s):	FCC #714830	IC Lab File #3874

### Appendix C - Peak Conducted Power Measurement

C.1. REFERENCES	
Normative Reference Standard	FCC CFR 47 §15.247(b) (3)
Procedure Reference	FCC 97-114

C.2. LIMITS	
C.2.1. FCC CFR	
§15.247(b): The maximum peak output power of the intentional radiator shall not exceed the following:	
§15.247(b) (3) For system using digital modulation in the 902 – 928 MHz, 2400 – 2483.5 MHz, and 5725 – 5850 MHz bands: 1 Watt.	

C.3. ENVIRONMENTAL CONDITIONS	
Temperature	25.2 +/- 2 °C
Humidity	35 +/- 2 %
Barometric Pressure	96.34 kPa

C.4. EQUIPMENT LIST					
ASSET NUMBER	MANUFACTURER	MODEL	DESCRIPTION	LAST CAL	CAL DUE
00015	Agilent	E4408B	Spectrum Analyzer	29Dec03	29Dec04
00075	Alpha Wire-J	9223	2ft. RG223/U RF Cable	08Jul04*	24Jun05
00076	Pasternack	PE7014-30	30dB 2 Watt Attenuator	08Jul04*	24Jun05

\*Cable and attenuator verified with power meter prior to use

C.5. MEASUREMENT EQUIPMENT SETUP	
Measurement Equipment Connections	The equipment was connected as shown in the setup drawing in C.6.
Measurement Equipment Settings	<p>To evaluate the maximum peak power, the 26 dB bandwidth needs to be determined. This is performed with the spectrum analyzer using the following setting:</p> <ul style="list-style-type: none"> <li>RBW – 300 kHz</li> <li>VBW – 1MHz</li> <li>Span – 50 MHz</li> <li>Detector – Peak</li> <li>Average – Power</li> <li>Trace Average – 100</li> </ul> <p>Once the 26 dB bandwidth is determined, the power is measured within the band with the following spectrum analyzer settings:</p> <ul style="list-style-type: none"> <li>RBW – 1 MHz</li> <li>VBW – 3 MHz</li> <li>Detector – Peak</li> <li>Average – Power</li> <li>Integrate BW – equal to specific -26 dB EBW</li> </ul>

Applicant:	Itronix Corporation	IC ID:	1943A-IX260Pf	FCC ID:	KBCIX260PROA580BT	
Rugged Laptop PC with Intel Pro 2200BG 802.11b/g WLAN Mini-PCI Card				Model:	IX260PROA580BT	
2005 Celltech Labs Inc. This document is not to be reproduced in whole or in part without the written permission of Celltech Labs Inc.						23 of 77

**C.6. SETUP DRAWING**

Figure C-1 - Setup Drawing

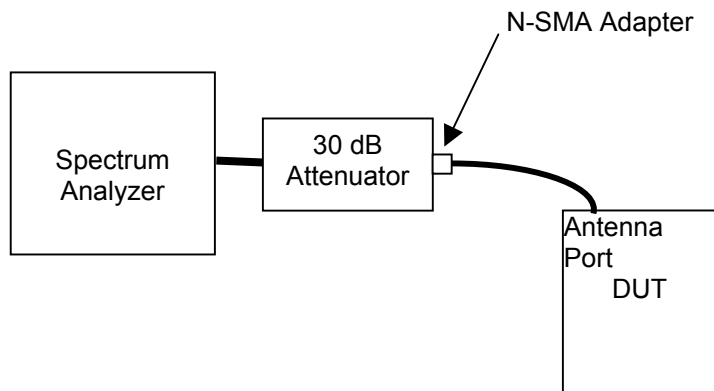

**C.7. DUT OPERATING DESCRIPTION**

The worst-case data rate was determined from prescan investigations. Measurements were made at three channels throughout the band, Low Channel (2412 MHz), Mid Channel (2437 MHz), High Channel (2462 MHz) and for both Modes b and g.

**C.8. TEST RESULTS**

Channel	Frequency	802.11b				802.11g			
		Peak Conducted Power		Limit	-26 dB EBW	Peak Conducted Power		Limit	-26 dB EBW
	MHz	dBm	Watts	Watts	MHz	dBm	Watts	Watts	MHz
Low	2412	16.28	.0424	1	19.53	15.14	.0327	1	23.55
Mid	2437	16.79	.0478	1	19.45	15.55	.0359	1	23.17
High	2462	17.48	.0560	1	19.43	16.15	.0412	1	23.05

<b>Test Report Serial No.:</b>	022305KBC-T618-E15W	Issue 1
<b>Test Date(s):</b>	28Jun04 - 29Jul04, 22Oct04	
<b>Test Type(s):</b>	FCC §15.247	IC RSS-210 Issue 5
<b>Lab Registration(s):</b>	FCC #714830	IC Lab File #3874

**C.9. PASS/FAIL**

In reference to the results outlined in C.8 the DUT passes the requirements as stated in the reference standards as follows:  
 FCC 15.247 (b) (3): The peak power did not exceed 1 Watt.

**C.10. SIGN-OFF**

I attest to the accuracy of the data. All measurements reported herein were performed by me and are correct to the best of my knowledge and belief. I assume full responsibility for the completeness of these measurements.



\_\_\_\_\_  
 Russell Pipe  
 Senior Compliance Technologist  
 Celltech Labs Inc.

\_\_\_\_\_  
 04Aug04  
 Date

Test Report Serial No.:	022305KBC-T618-E15W	Issue 1
Test Date(s):	28Jun04 - 29Jul04, 22Oct04	
Test Type(s):	FCC §15.247	IC RSS-210 Issue 5
Lab Registration(s):	FCC #714830	IC Lab File #3874

### Appendix D - Maximum Permissible Exposure Calculation

D.1. REFERENCES	
Normative Reference Standard	FCC CFR 47§1.1310 IEEE Std C95.1-1999
Procedure Reference	FCC CFR 47§2.1091

D.2. LIMITS	
FCC CFR 47§1.1310 Table 1(b)	1.0 mW/cm <sup>2</sup>

D.3. ENVIRONMENTAL CONDITIONS	
Temperature	na
Humidity	na
Barometric Pressure	na

D.4. EQUIPMENT LIST					
ASSET NUMBER	MANUFACTURER	MODEL	DESCRIPTION	LAST CAL	CAL DUE
na					

D.5. MEASUREMENT EQUIPMENT SETUP	
MEASUREMENT EQUIPMENT CONNECTIONS	The results described herein were determined by calculation, so no measurement equipment was used.
MEASUREMENT EQUIPMENT SETTINGS	na

D.6. SETUP PHOTOS	
na	

D.7. SETUP DRAWINGS	
na	

D.8. DUT OPERATING DESCRIPTION	
na	

Applicant:	Itronix Corporation	IC ID:	1943A-IX260Pf	FCC ID:	KBCIX260PROA580BT	
Rugged Laptop PC with Intel Pro 2200BG 802.11b/g WLAN Mini-PCI Card				Model:	IX260PROA580BT	
2005 Celltech Labs Inc. This document is not to be reproduced in whole or in part without the written permission of Celltech Labs Inc.						26 of 77

Test Report Serial No.:	022305KBC-T618-E15W	Issue 1
Test Date(s):	28Jun04 - 29Jul04, 22Oct04	
Test Type(s):	FCC §15.247	IC RSS-210 Issue 5
Lab Registration(s):	FCC #714830	IC Lab File #3874

### D.9. TEST RESULTS

#### Calculation:

##### RangeStar Internal Antenna (802.11b mode):

Tx Frequency: 2462.00 (MHz)  
 Power at Antenna Input Terminal: 17.48 (dBm)  
 Antenna gain: 4.50 (dBi)

S = 1.00 (mW/cm<sup>2</sup>)  
 P = 55.9758 (mW)  
 G = 2.82 (numeric)

R = 3.54 (cm)

S (mw/cm<sup>2</sup>) at 20cm = 0.031351575

##### RangeStar Internal Antenna (802.11g mode):

Tx Frequency: 2462.00 (MHz)  
 Power at Antenna Input Terminal: 16.15 (dBm)  
 Antenna gain: 4.50 (dBi)

S = 1.00 (mW/cm<sup>2</sup>)  
 P = 41.2098 (mW)  
 G = 2.82 (numeric)

R = 3.04 (cm)

S (mw/cm<sup>2</sup>) at 20cm = 0.023081252

#### Formulae:

$$S = \frac{PG}{4\pi R^2}$$

$$R = \sqrt{\frac{P}{4\pi S}}$$
 where: S = Power Density Limit  
 P = Power Applied to the Antenna  
 G = Numeric Antenna Gain  
 R = Distance from Antenna

#### Results:

Mode	Power Density Limit	RF Conducted Output Power	Antenna Gain	MPE Distance	Power Density at 20 cm
	mW/cm <sup>2</sup>	dBm	dBi	cm	mW/cm <sup>2</sup>
802.11b	1.0	17.48	4.5	3.54	0.031
802.11g	1.0	16.15	4.5	3.04	0.023

Applicant:	Itronix Corporation	IC ID:	1943A-IX260Pf	FCC ID:	KBCIX260PROA580BT	
Rugged Laptop PC with Intel Pro 2200BG 802.11b/g WLAN Mini-PCI Card				Model:	IX260PROA580BT	
2005 Celltech Labs Inc. This document is not to be reproduced in whole or in part without the written permission of Celltech Labs Inc.						27 of 77

<b>Test Report Serial No.:</b>	022305KBC-T618-E15W	Issue 1
<b>Test Date(s):</b>	28Jun04 - 29Jul04, 22Oct04	
<b>Test Type(s):</b>	FCC §15.247	IC RSS-210 Issue 5
<b>Lab Registration(s):</b>	FCC #714830	IC Lab File #3874

**D.10. PASS/FAIL**

In reference to the results outlined in D.9 the DUT passes the requirements as stated in the reference standards as follows:  
 1) The DUT must comply with the minimum spacing requirement of 20 cm to ensure an exposure of not more than 1 mW/cm<sup>2</sup>.

**D.11. SIGN-OFF**

I attest to the accuracy of the data. All measurements reported herein were performed by me and are correct to the best of my knowledge and belief. I assume full responsibility for the completeness of these measurements.



\_\_\_\_\_  
 Russell Pipe  
 Senior Compliance Technologist  
 Celltech Labs Inc.

\_\_\_\_\_  
 04Aug04

Date

<b>Applicant:</b>	Itronix Corporation	<b>IC ID:</b>	1943A-IX260Pf	<b>FCC ID:</b>	KBCIX260PROA580BT	
<b>Rugged Laptop PC with Intel Pro 2200BG 802.11b/g WLAN Mini-PCI Card</b>				<b>Model:</b>	IX260PROA580BT	
2005 Celltech Labs Inc. This document is not to be reproduced in whole or in part without the written permission of Celltech Labs Inc.						28 of 77

Test Report Serial No.:	022305KBC-T618-E15W	Issue 1
Test Date(s):	28Jun04 - 29Jul04, 22Oct04	
Test Type(s):	FCC §15.247	IC RSS-210 Issue 5
Lab Registration(s):	FCC #714830	IC Lab File #3874

## Appendix E - Radiated Spurious Emissions Measurement

E.1. REFERENCES	
<b>Normative Reference Standard</b>	FCC CFR 47 §15.247(c)
<b>Procedure Reference</b>	ANSI C63.4; FCC 97-114

E.2. LIMITS	
E.2.1. FCC CFR 47	
<p>§15.247 (c): <i>In any 100 kHz bandwidth outside the frequency band in which the spread spectrum or digitally modulated intentional radiator is operating, the radio frequency power that is produced by the intentional radiator shall be at least 20 dB below that in the 100 kHz bandwidth within the band that contains the highest level of desired power, based on either an RF conducted or a radiated measurement. Attenuation below the general limits specified in 15.209 (a) is not required.</i></p>	
<p>Note: Spurious emissions within the restricted bands are reported in Appendix F.</p>	

E.3. ENVIRONMENTAL CONDITIONS	
<b>Temperature</b>	27.4 +/- 2 °C
<b>Humidity</b>	33 +/- 2 %
<b>Barometric Pressure</b>	96.24 +/- 0.2 kPa

E.4. EQUIPMENT LIST					
ASSET NUMBER	MANUFACTURER	MODEL	DESCRIPTION	LAST CAL	CAL DUE
00072	EMCO	2075	Mini-mast	n/a	n/a
00073	EMCO	2080	Turn Table	n/a	n/a
00071	EMCO	2090	Multi-Device Controller	n/a	n/a
00050	Chase	CBL-6111A	Bilog Antenna	30Apr04	30Apr05
00035	ETS	3115	Double Ridged Guide Horn	24Mar04	24Mar05
00202	ETS	3160-09	Small Horn Antenna	27May04	27May05
00015	Agilent	E4408B	Spectrum Analyzer	29Dec03	29Dec04
00049	HP	8566B	Spectrum Analyzer RF Section	18May04	18May05
00049	HP	85650A	Quasi-peak Adapter	18May04	18May05
00047	HP	85685A	RF Preselector	18May04	18May05
00048	Gore	65474	Microwave Cable	20May04	20May05
00030	HP	83017A	LNA	20May04	20May05

<b>Applicant:</b> Itronix Corporation	<b>IC ID:</b> 1943A-IX260Pf	<b>FCC ID:</b> KBCIX260PROA580BT	
<b>Rugged Laptop PC with Intel Pro 2200BG 802.11b/g WLAN Mini-PCI Card</b>		<b>Model:</b> IX260PROA580BT	
2005 Celltech Labs Inc. This document is not to be reproduced in whole or in part without the written permission of Celltech Labs Inc.			29 of 77



<b>Test Report Serial No.:</b>	022305KBC-T618-E15W	Issue 1
<b>Test Date(s):</b>	28Jun04 - 29Jul04, 22Oct04	
<b>Test Type(s):</b>	FCC §15.247	IC RSS-210 Issue 5
<b>Lab Registration(s):</b>	FCC #714830	IC Lab File #3874

### E.5. MEASUREMENT EQUIPMENT SETUP

<b>MEASUREMENT EQUIPMENT CONNECTIONS</b>	The measurement equipment was connected as shown in the E.6. A number of antennas were used to cover the applicable frequency range test. The ranges in which each antenna was used are as follows:			
	Frequency Range	Antenna		
	30 MHz – 1 GHz	CBL-6111A Bilog		
	1 GHz – 18 GHz	ETS 3115 Horn		
	18 GHz – 26 GHz	ETS 3160-09 Horn		
<b>MEASUREMENT EQUIPMENT SETTINGS</b>	The spectrum analyzer was set to the following settings:			
	Frequency Range	RBW	VBW	Detector
	MHz	kHz	kHz	
	30 – 1000	100	300	Peak*
	> 1000	1000*	1000	Peak*
*As a worst-case measurement, the average limit was applied to measurements made with a peak detector using a RBW of 1 MHz (vs the specified 100 kHz), when possible.				

### E.6. SETUP DRAWING

Figure E-1 - Setup Drawing

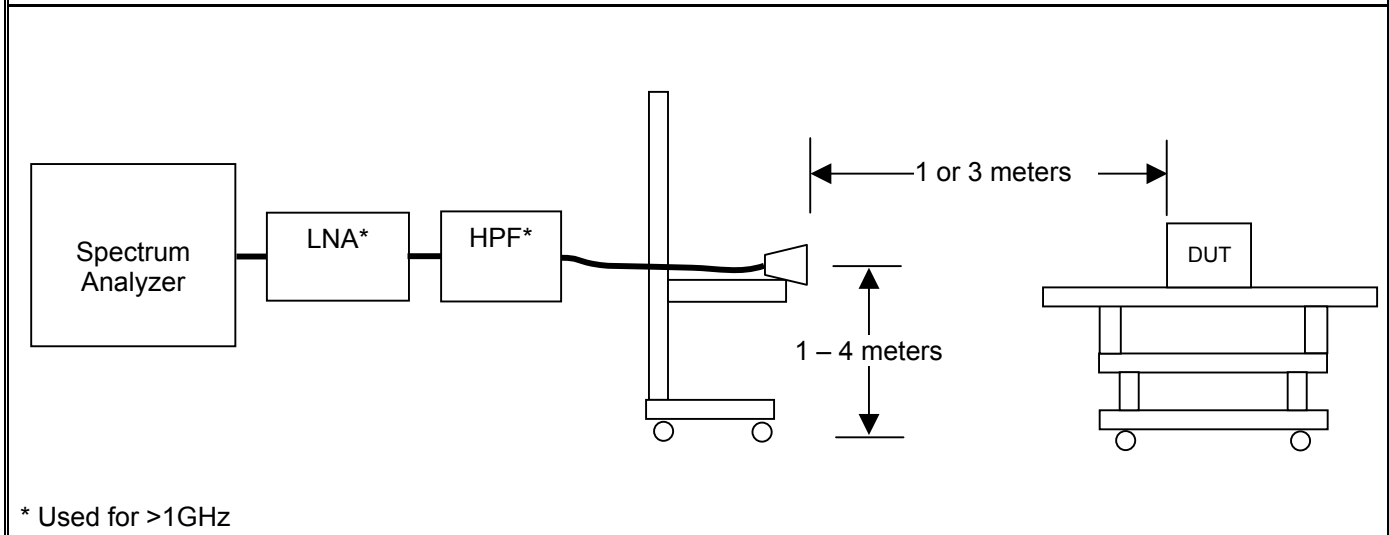

<b>Test Report Serial No.:</b>	022305KBC-T618-E15W	Issue 1
<b>Test Date(s):</b>	28Jun04 - 29Jul04, 22Oct04	
<b>Test Type(s):</b>	FCC §15.247	IC RSS-210 Issue 5
<b>Lab Registration(s):</b>	FCC #714830	IC Lab File #3874

**E.7. SETUP PHOTOGRAPHS**

Photograph E-1 - Vertical Polarization (1-18 GHz)



Photograph E-2 - Vertical Polarization (18-26 GHz)



Photograph E-3 - Front of Radiated Emission Configuration



Photograph E-4 - Back of Radiated Emission Configuration

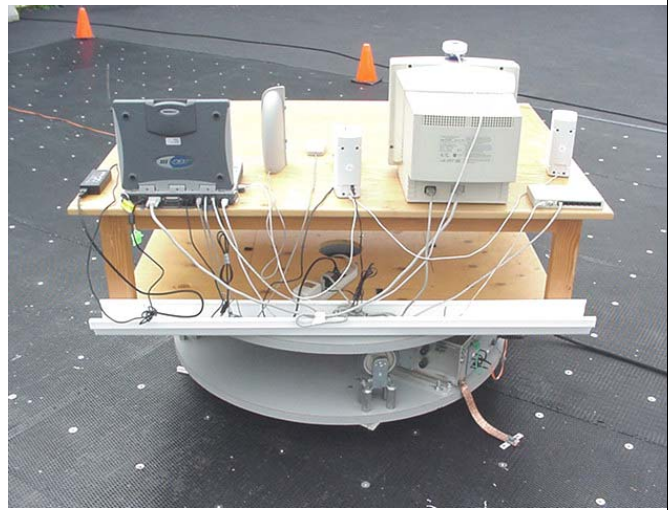

<b>Applicant:</b>	Itronix Corporation	<b>IC ID:</b>	1943A-IX260Pf	<b>FCC ID:</b>	KBCIX260PROA580BT	
<b>Rugged Laptop PC with Intel Pro 2200BG 802.11b/g WLAN Mini-PCI Card</b>				<b>Model:</b>	IX260PROA580BT	
2005 Celltech Labs Inc. This document is not to be reproduced in whole or in part without the written permission of Celltech Labs Inc.						31 of 77

### E.8. DUT OPERATING DESCRIPTION

The worst-case data rate was determined from prescan investigations. Measurements were made at three channels throughout the band, Low Channel (2412 MHz), Mid Channel (2437 MHz), High Channel (2462 MHz) and for both Modes b and g for the band-edge measurements and for Mode b for the remaining measurements. The configuration used was Mode b, 1 mbps with a gain setting of 29 and Mode g, 6 mbps with a gain setting of 24.5.

### E.9. TEST RESULTS

#### E.9.1. Mode b - Fundamental Field Strengths @ Specified Distance - Horizontal Polarization

Channel	Polarity	Measurement Distance	Antenna	Frequency	SA Level	Noise Floor	Antenna Factor	Cable Factor	Other Factors	Total CF	Field Strength	Detector	Limit Distance	Limit Distance Correction	*Calculated Limit
													m	dB	dBuV/m
1	H	3	Horn SN6276	2412.00	70.11		28.11	3.49	0.00	31.59	101.70	PK	3	0.00	81.70
6	H	3	Horn SN6276	2437.00	70.00		28.16	3.51	0.00	31.67	101.67	PK	3	0.00	81.67
11	H	3	Horn SN6276	2462.00	70.50		28.22	3.52	0.00	31.73	102.23	PK	3	0.00	82.23

#### E.9.2. Mode b - Fundamental Field Strengths @ Specified Distance - Vertical Polarization

1	V	3	Horn SN6276	2412.00	64.50		28.11	3.49	0.00	31.59	96.09	PK	3	0.00	76.09
6	V	3	Horn SN6276	2437.00	63.70		28.16	3.51	0.00	31.67	95.37	PK	3	0.00	75.37
11	V	3	Horn SN6276	2462.00	64.91		28.22	3.52	0.00	31.73	96.64	PK	3	0.00	76.64

**Formulae:**

Total CF = Antenna Factor + Cable Factor + Other Factor (Amplifier Gain, filter loss, etc)

Field Strength = SA Reading + Total CF

Limit Distance Correction =  $40 \cdot \log(d1/d2)$  for  $F < 30$  MHz,  $20 \cdot \log(d1/d2)$  for  $F > 30$  MHz :  
where d1 is the measurement distance

Limit = Specified Limit + Limit Distance Correction

Margin = Limit - Field Strength

Calculated Limit (-20 dBc) = Field Strength -20

\*Calculated Limit used for spurious emission evaluation

Test Report Serial No.:	022305KBC-T618-E15W	Issue 1
Test Date(s):	28Jun04 - 29Jul04, 22Oct04	
Test Type(s):	FCC §15.247	IC RSS-210 Issue 5
Lab Registration(s):	FCC #714830	IC Lab File #3874

### E.9.3. Lower Band-edge Emission Field Strengths @ Specified Distance

Note: (Upper Band-edge (Restricted Band) is in Appendix F)

#### Channel 1 Mode b - Conducted Band-edge Plots

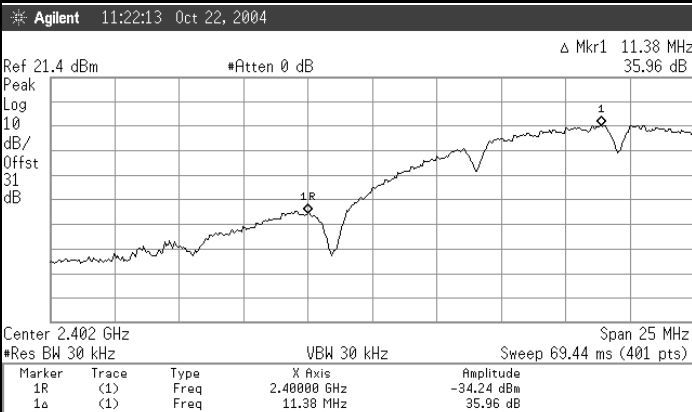

#### Channel 1 Mode g - Conducted Band-edge Plots

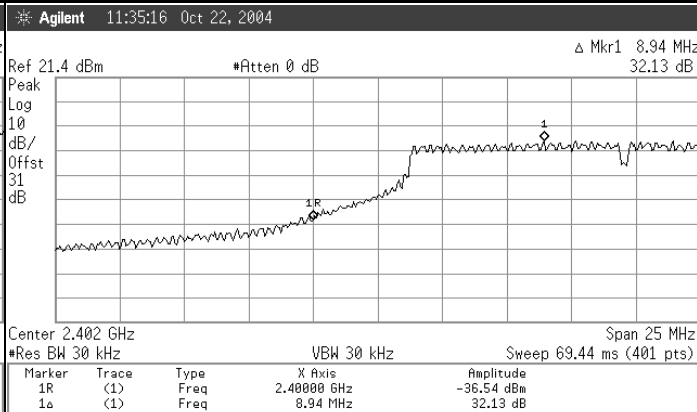

#### Channel 1 Mode b - Radiated Carrier Field Strengths

Channel	Polarity	Distance	Rx Antenna	Frequency	SA Level	Rx AF	Rx CL	Other Rx	Total Rx CF	Field Strength	Detector
		m		MHz	dBuV	dB/m	dB	dB	dB/m	dBuV/m	PK/QP/AV
1	H	3	Horn SN6276	2412.00	70.11	28.11	3.49	0.00	31.59	101.70	PK
1	H	3	Horn SN6276	2412.00	64.70	28.11	3.49	0.00	31.59	96.30	AV
1	V	3	Horn SN6276	2412.00	64.50	28.11	3.49	0.00	31.59	96.09	PK
1	V	3	Horn SN6276	2412.00	59.97	28.11	3.49	0.00	31.59	91.56	AV

#### Channel 1 Mode g - Radiated Carrier Field Strengths

Channel	Polarity	Distance	Rx Antenna	Frequency	SA Level	Rx AF	Rx CL	Other Rx	Total Rx CF	Field Strength	Detector
		m		MHz	dBuV	dB/m	dB	dB	dB/m	dBuV/m	PK/QP/AV
1	H	3	Horn SN6276	2412.00	70.20	28.11	3.49	0.00	31.59	101.79	PK
1	H	3	Horn SN6276	2412.00	58.60	28.11	3.49	0.00	31.59	90.19	AV
1	V	3	Horn SN6276	2412.00	65.80	28.11	3.49	0.00	31.59	97.39	PK
1	V	3	Horn SN6276	2412.00	54.20	28.11	3.49	0.00	31.59	85.79	AV

#### Channel 1 - Calculated Band-edge (Out-of-Band) Field Strengths

Channel	Polarity	Distance	Frequency	Carrier Radiated Field Strength	Marker-Delta	Detector	Calculated Band-edge Field Strength	Limit Distance	Limit Distance Correction	Specified Limit	Margin	Pass/Fail
		m	MHz	dBuV/m	dBuV		dBuV/m	m	dB	dBuV/m	dB	
1	H	3	2400.00	101.70	35.96	PK	65.74	3.00	0.00	81.70	15.96	Pass
1	H	3	2400.00	96.30	35.96	AV	60.34	3.00	0.00	76.30	15.96	Pass
1	V	3	2400.00	96.09	35.96	PK	60.13	3.00	0.00	81.70	21.57	Pass
1	V	3	2400.00	91.56	35.96	AV	55.60	3.00	0.00	76.30	20.69	Pass

#### Channel 1 g - Calculated Band-edge (Out-of-Band) Field Strengths

Channel	Polarity	Distance	Frequency	Carrier Radiated Field Strength	Marker-Delta	Detector	Calculated Band-edge Field Strength	Limit Distance	Limit Distance Correction	Specified Limit	Margin	Pass/Fail
		m	MHz	dBuV/m	dBuV		dBuV/m	m	dB	dBuV/m	dB	
1	H	3	2400.00	101.79	32.13	PK	69.66	3.00	0.00	81.79	12.13	Pass
1	H	3	2400.00	90.19	32.13	AV	58.06	3.00	0.00	70.19	12.13	Pass
1	V	3	2400.00	97.39	32.13	PK	65.26	3.00	0.00	81.79	16.53	Pass
1	V	3	2400.00	85.79	32.13	AV	53.66	3.00	0.00	70.19	16.53	Pass

Formulae:

Total CF (dB) = Antenna Factor (dB) + Cable Factor (dB) + Other Factor (Amplifier Gain, Filter Loss, etc) (dB)

Field Strength (dBuV/m) = SA Reading (dBuV) + Total CF (dB/m)

Limit Distance Correction (dB) = 40 \* log(d1/d2) for f < 30 MHz, 20\*log(d1/d2) for f > 30 MHz; where d1 is the measurement distance and d2 is the published limit

Limit (dBuV/m) = Published Limit (dBuV/m) + Limit Distance Correction (dB)

Margin (dB) = Limit (dBuV/m) - Field Strength (dBuV/m)

Note: Measurements and calculation reference the Marker-Delta Method Described in FCC Public Notice DA 00-705

Applicant: Itronix Corporation IC ID: 1943A-IX260Pf FCC ID: KBCIX260PROA580BT

Rugged Laptop PC with Intel Pro 2200BG 802.11b/g WLAN Mini-PCI Card Model: IX260PROA580BT



E.9.4. Channel 1 Harmonic Emission Field Strengths @ Specified Distance - Horizontal Polarization

Channel	Polarity	Measurement Distance	Antenna	Frequency	SA Level	Noise Floor	Antenna Factor	Cable Factor	Other Factors	Total CF	Field Strength	Detector	Limit Distance	Limit Distance Correction	-20 dBc Limit	Margin	Pass/Fail
1	H	3	Horn SN6276	1000.00	53.90		24.30	2.21	-10.66	15.85	69.75	PK	3.00	0.00	81.70	11.95	PASS
1	H	3	Horn SN6276	2500.00	42.60		28.30	3.51	-36.42	-4.61	37.99	PK	3.00	0.00	81.70	43.71	PASS
1	H	3	Horn SN6276	17660.00	38.00		44.88	10.46	-36.36	18.98	56.98	PK	3.00	0.00	81.70	24.72	PASS
1	H	1	3160-09	19296.00	52.98		40.26	11.01	-35.81	15.45	68.43	PK	3.00	9.54	91.24	22.81	PASS
1	H	1	3160-09	19296.00	34.05	x	40.26	11.01	-35.81	15.45	49.50	AV	3.00	9.54	91.24	41.74	PASS
1	H	1	3160-09	21708.00	53.65	x	40.30	11.91	-35.73	16.48	70.13	PK	3.00	9.54	91.24	21.11	PASS
1	H	1	3160-09	21708.00	35.74	x	40.30	11.91	-35.73	16.48	52.22	AV	3.00	9.54	91.24	39.02	PASS
1	H	1	3160-09	24120.00	56.09		40.40	12.81	-35.73	17.48	73.57	PK	3.00	9.54	91.24	17.67	PASS
1	H	1	3160-09	24120.00	37.57		40.40	12.81	-35.73	17.48	55.05	AV	3.00	9.54	91.24	36.19	PASS
1	H	1	3160-09	24490.00	57.15	x	40.40	12.95	-35.73	17.62	74.77	PK	3.00	9.54	91.24	16.47	PASS

E.9.5. Channel 1 Harmonic Emission Field Strengths @ Specified Distance - Vertical Polarization

1	V	3	Horn SN6276	4810.00	47.00	x	32.88	4.96	-35.30	2.54	49.54	PK	3.00	0.00	76.09	26.55	PASS
1	V	3	Horn SN6276	9610.00	36.60		37.59	7.37	-35.71	9.25	45.85	AV	3.00	0.00	76.09	30.24	PASS
1	V	1	Horn SN6276	17770.00	37.60		45.70	10.30	-36.35	19.65	57.25	PK	3.00	9.54	85.63	28.39	PASS
1	V	1	3160-09	18820.00	53.92	x	40.20	11.05	-35.87	15.38	69.30	PK	3.00	9.54	85.63	16.33	PASS
1	V	1	3160-09	18820.00	33.66	x	40.20	11.05	-35.87	15.38	49.04	AV	3.00	9.54	85.63	36.59	PASS
1	V	1	3160-09	19296.00	52.65		40.26	11.01	-35.81	15.45	68.10	PK	3.00	9.54	85.63	17.53	PASS
1	V	1	3160-09	19296.00	33.76		40.26	11.01	-35.81	15.45	49.21	AV	3.00	9.54	85.63	36.42	PASS
1	V	1	3160-09	21708.00	53.27		40.30	11.91	-35.73	16.48	69.75	PK	3.00	9.54	85.63	15.88	PASS
1	V	1	3160-09	21708.00	36.04		40.30	11.91	-35.73	16.48	52.52	AV	3.00	9.54	85.63	33.11	PASS
1	V	1	3160-09	24120.00	56.03		40.40	12.81	-35.73	17.48	73.51	PK	3.00	9.54	85.63	12.12	PASS
1	V	1	3160-09	24120.00	37.21		40.40	12.81	-35.73	17.48	54.69	AV	3.00	9.54	85.63	30.94	PASS
1	V	1	3160-09	24550.00	56.31	x	40.40	12.97	-35.73	17.64	73.95	PK	3.00	9.54	85.63	11.68	PASS
1	V	1	3160-09	24550.00	38.30	x	40.40	12.97	-35.73	17.64	55.94	AV	3.00	9.54	85.63	29.69	PASS

Formulae:

Total CF = Antenna Factor + Cable Factor + Other Factor (Amplifier Gain, filter loss, etc)

Field Strength = SA Reading + Total CF

Limit Distance Correction =  $40 \cdot \log(d1/d2)$  for  $F < 30$  MHz,  $20 \cdot \log(d1/d2)$  for  $F > 30$  MHz:  
where d1 is the measurement distance, d2 is the published limit distance

Limit = Specified Limit + Limit Distance Correction

Margin = Limit - Field Strength

\*No harmonic emission where measured above the field strengths noted

Applicant:	Itronix Corporation	IC ID:	1943A-IX260Pf	FCC ID:	KBCIX260PROA580BT	
Rugged Laptop PC with Intel Pro 2200BG 802.11b/g WLAN Mini-PCI Card				Model:	IX260PROA580BT	
2005 Celltech Labs Inc. This document is not to be reproduced in whole or in part without the written permission of Celltech Labs Inc.						34 of 77



<b>Test Report Serial No.:</b>	022305KBC-T618-E15W	Issue 1
<b>Test Date(s):</b>	28Jun04 - 29Jul04, 22Oct04	
<b>Test Type(s):</b>	FCC §15.247	IC RSS-210 Issue 5
<b>Lab Registration(s):</b>	FCC #714830	IC Lab File #3874

E.9.6. Channel 6 Harmonic Emission Field Strengths @ Specified Distance - Horizontal Polarization

Channel	Polarity	Measurement Distance	Antenna	Frequency	SA Level	Noise Floor	Antenna Factor	Cable Factor	Other Factors	Total CF	Field Strength	Detector	Limit Distance	Limit Distance Correction	-20 dBc Limit	Margin	Pass/Fail
													m	dB	dB	dBuV/m	
6	H	3	Horn SN6276	5260.00	45.20	x	33.72	5.23	-35.47	3.47	48.67	PK	3.00	0.00	81.67	33.00	PASS
6	H	3	Horn SN6276	8360.00	42.30		37.06	6.79	-35.62	8.24	50.54	AV	3.00	0.00	81.67	31.13	PASS
6	H	3	Horn SN6276	17090.00	39.20		41.24	10.38	-36.09	15.54	54.74	PK	3.00	0.00	81.67	26.93	PASS
6	H	1	3160-09	19496.00	52.56		40.30	11.28	-35.79	15.79	68.35	PK	3.00	9.54	91.21	22.86	PASS
6	H	1	3160-09	19496.00	33.91		40.30	11.28	-35.79	15.79	49.70	AV	3.00	9.54	91.21	41.51	PASS
6	H	1	3160-09	21240.00	54.98	x	40.30	11.73	-35.73	16.31	71.29	PK	3.00	9.54	91.21	19.93	PASS
6	H	1	3160-09	21240.00	35.72	x	40.30	11.73	-35.73	16.31	52.03	AV	3.00	9.54	91.21	39.19	PASS
6	H	1	3160-09	21933.00	54.66		40.30	11.99	-35.73	16.57	71.23	PK	3.00	9.54	91.21	19.99	PASS
6	H	1	3160-09	21933.00	36.27		40.30	11.99	-35.73	16.57	52.84	AV	3.00	9.54	91.21	38.38	PASS
6	H	1	3160-09	24370.00	57.10		40.40	12.90	-35.73	17.58	74.68	PK	3.00	9.54	91.21	16.54	PASS
6	H	1	3160-09	24370.00	37.88		40.40	12.90	-35.73	17.58	55.46	AV	3.00	9.54	91.21	35.76	PASS
6	H	1	3160-09	24420.00	56.93	x	40.40	12.92	-35.73	17.60	74.53	PK	3.00	9.54	91.21	16.69	PASS
6	H	1	3160-09	24420.00	37.73	x	40.40	12.92	-35.73	17.60	55.33	AV	3.00	9.54	91.21	35.89	PASS

Formulae:

Total CF = Antenna Factor + Cable Factor + Other Factor (Amplifier Gain, filter loss, etc)

Field Strength = SA Reading + Total CF

Limit Distance Correction = 40\*log(d1/d2) for F<30 MHz, 20\*log(d1/d2) for F> 30 MHz:

where d1 is the measurement distance, d2 is the published limit distance

Limit = Specified Limit + Limit Distance Correction

Margin = Limit - Field Strength

\*No harmonic emission where measured above the field strengths noted

<b>Applicant:</b>	Itronix Corporation	<b>IC ID:</b>	1943A-IX260Pf	<b>FCC ID:</b>	KBCIX260PROA580BT	
<b>Rugged Laptop PC with Intel Pro 2200BG 802.11b/g WLAN Mini-PCI Card</b>				<b>Model:</b>	IX260PROA580BT	
2005 Celltech Labs Inc. This document is not to be reproduced in whole or in part without the written permission of Celltech Labs Inc.						35 of 77

<b>Test Report Serial No.:</b>	022305KBC-T618-E15W	Issue 1
<b>Test Date(s):</b>	28Jun04 - 29Jul04, 22Oct04	
<b>Test Type(s):</b>	FCC §15.247	IC RSS-210 Issue 5
<b>Lab Registration(s):</b>	FCC #714830	IC Lab File #3874

**E.9.7. Channel 6 Harmonic Emission Field Strengths @ Specified Distance - Vertical Polarization**

Channel	Polarity	Measurement Distance	Antenna	Frequency	SA Level	Noise Floor	Antenna Factor	Cable Factor	Other Factors	Total CF	Field Strength	Detector	Limit Distance	Limit Distance Correction	-20 dBc Limit	Margin	Pass/Fail
													m	dB			
6	V	3	Horn SN6276	5770.00	40.10	x	34.21	5.45	-35.50	4.16	44.26	PK	3.00	0.00	75.37	31.11	PASS
6	V	3	Horn SN6276	9720.00	36.80		37.68	7.34	-35.71	9.31	46.11	PK	3.00	0.00	75.37	29.26	PASS
6	V	1	Horn SN6276	16480.00	38.30		38.45	10.25	-36.46	12.24	50.54	PK	3.00	9.54	84.91	34.37	PASS
6	V	1	3160-09	19190.00	54.26	x	40.24	10.91	-35.83	15.32	69.58	PK	3.00	9.54	84.91	15.33	PASS
6	V	1	3160-09	19190.00	33.78	x	40.24	10.91	-35.83	15.32	49.10	AV	3.00	9.54	84.91	35.81	PASS
6	V	1	3160-09	19496.00	52.89		40.30	11.28	-35.79	15.79	68.68	PK	3.00	9.54	84.91	16.23	PASS
6	V	1	3160-09	19496.00	33.88		40.30	11.28	-35.79	15.79	49.67	AV	3.00	9.54	84.91	35.24	PASS
6	V	1	3160-09	21933.00	53.99		40.30	11.99	-35.73	16.57	70.56	PK	3.00	9.54	84.91	14.36	PASS
6	V	1	3160-09	21933.00	36.23		40.30	11.99	-35.73	16.57	52.80	AV	3.00	9.54	84.91	32.12	PASS
6	V	1	3160-09	24370.00	55.56		40.40	12.90	-35.73	17.58	73.14	PK	3.00	9.54	84.91	11.78	PASS
6	V	1	3160-09	24370.00	37.88		40.40	12.90	-35.73	17.58	55.46	AV	3.00	9.54	84.91	29.46	PASS
6	V	1	3160-09	24400.00	56.66	x	40.40	12.91	-35.73	17.59	74.25	PK	3.00	9.54	84.91	10.66	PASS
6	V	1	3160-09	24400.00	37.87	x	40.40	12.91	-35.73	17.59	55.46	AV	3.00	9.54	84.91	29.45	PASS

**Formulae:**

Total CF = Antenna Factor + Cable Factor + Other Factor (Amplifier Gain, filter loss, etc)

Field Strength = SA Reading + Total CF

Limit Distance Correction =  $40 \cdot \log(d1/d2)$  for  $F < 30$  MHz,  $20 \cdot \log(d1/d2)$  for  $F > 30$  MHz:

where d1 is the measurement distance, d2 is the published limit distance

Limit = Specified Limit + Limit Distance Correction

Margin = Limit - Field Strength

\*No harmonic emission where measured above the field strengths noted

<b>Applicant:</b>	Itronix Corporation	<b>IC ID:</b>	1943A-IX260Pf	<b>FCC ID:</b>	KBCIX260PROA580BT	
<b>Rugged Laptop PC with Intel Pro 2200BG 802.11b/g WLAN Mini-PCI Card</b>				<b>Model:</b>	IX260PROA580BT	
2005 Celltech Labs Inc. This document is not to be reproduced in whole or in part without the written permission of Celltech Labs Inc.						36 of 77



<b>Test Report Serial No.:</b>	022305KBC-T618-E15W	Issue 1
<b>Test Date(s):</b>	28Jun04 - 29Jul04, 22Oct04	
<b>Test Type(s):</b>	FCC §15.247	IC RSS-210 Issue 5
<b>Lab Registration(s):</b>	FCC #714830	IC Lab File #3874

E.9.8. Channel 11 Harmonic Emission Field Strengths @ Specified Distance - Horizontal Polarization

Channel	Polarity	Measurement Distance	Antenna	Frequency	SA Level	Noise Floor	Antenna Factor	Cable Factor	Other Factors	Total CF	Field Strength	Detector	Limit Distance	Limit Distance Correction	-20 dBc Limit	Margin	Pass/Fail
													m	dB	dB	dBuV/m	
11	H	3	Horn SN6276	5260.00	45.80	x	33.72	5.23	-35.47	3.47	49.27	PK	3.00	0.00	82.23	32.96	PASS
11	H	3	Horn SN6276	8360.00	42.10		37.06	6.79	-35.62	8.24	50.34	PK	3.00	0.00	82.23	31.89	PASS
11	H	1	Horn SN6276	15920.00	38.90		37.38	9.83	-36.23	10.98	49.88	PK	3.00	9.54	91.77	41.89	PASS
11	H	1	3160-09	18810.00	53.72	x	40.20	11.15	-35.87	15.48	69.20	PK	3.00	9.54	91.77	22.58	PASS
11	H	1	3160-09	18810.00	33.94	x	40.20	11.15	-35.87	15.48	49.42	AV	3.00	9.54	91.77	42.36	PASS
11	H	1	3160-09	19696.00	53.67		40.30	11.42	-35.76	15.95	69.62	PK	3.00	9.54	91.77	22.15	PASS
11	H	1	3160-09	19696.00	33.44		40.30	11.42	-35.76	15.95	49.39	AV	3.00	9.54	91.77	42.38	PASS
11	H	1	3160-09	22158.00	53.69		40.33	12.08	-35.73	16.68	70.37	PK	3.00	9.54	91.77	21.40	PASS
11	H	1	3160-09	22158.00	35.90		40.33	12.08	-35.73	16.68	52.58	AV	3.00	9.54	91.77	39.19	PASS
11	H	1	3160-09	24620.00	55.75		40.40	13.00	-35.73	17.67	73.42	PK	3.00	9.54	91.77	18.35	PASS
11	H	1	3160-09	24620.00	37.57		40.40	13.00	-35.73	17.67	55.24	AV	3.00	9.54	91.77	36.53	PASS
11	H	1	3160-09	24460.00	56.88	x	40.40	12.94	-35.73	17.61	74.49	PK	3.00	9.54	91.77	17.28	PASS
11	H	1	3160-09	24460.00	37.32	x	40.40	12.94	-35.73	17.61	54.93	AV	3.00	9.54	91.77	36.84	PASS

Formulae:

Total CF = Antenna Factor + Cable Factor + Other Factor (Amplifier Gain, filter loss, etc)

Field Strength = SA Reading + Total CF

Limit Distance Correction = 40\*log(d1/d2) for F<30 MHz, 20\*log(d1/d2) for F> 30 MHz:

where d1 is the measurement distance, d2 is the published limit distance

Limit = Specified Limit + Limit Distance Correction

Margin = Limit - Field Strength

\*No harmonic emission where measured above the field strengths noted

<b>Applicant:</b>	Itronix Corporation	<b>IC ID:</b>	1943A-IX260Pf	<b>FCC ID:</b>	KBCIX260PROA580BT	
<b>Rugged Laptop PC with Intel Pro 2200BG 802.11b/g WLAN Mini-PCI Card</b>				<b>Model:</b>	IX260PROA580BT	
2005 Celltech Labs Inc. This document is not to be reproduced in whole or in part without the written permission of Celltech Labs Inc.						37 of 77

<b>Test Report Serial No.:</b>	022305KBC-T618-E15W	Issue 1
<b>Test Date(s):</b>	28Jun04 - 29Jul04, 22Oct04	
<b>Test Type(s):</b>	FCC §15.247	IC RSS-210 Issue 5
<b>Lab Registration(s):</b>	FCC #714830	IC Lab File #3874

E.9.9. Channel 11 Harmonic Emission Field Strengths @ Specified Distance - Vertical Polarization

Channel	Polarity	Measurement Distance	Antenna	Frequency	SA Level	Noise Floor	Antenna Factor	Cable Factor	Other Factors	Total CF	Field Strength	Detector	Limit Distance	Limit Distance Correction	-20 dBc Limit	Margin	Pass/Fail
													m	dB	dBuV/m	Δ dB	
11	V	3	Horn SN6276	5770.00	42.50	x	34.21	5.45	-35.50	4.16	46.66	PK	3.00	0.00	76.64	29.98	PASS
11	V	1	Horn SN6276	16680.00	39.00		39.29	10.24	-36.14	13.40	52.40	PK	3.00	9.54	86.18	33.79	PASS
11	V	1	3160-09	19696.00	53.07		40.30	11.42	-35.76	15.95	69.02	PK	3.00	9.54	86.18	17.16	PASS
11	V	1	3160-09	19696.00	33.28		40.30	11.42	-35.76	15.95	49.23	AV	3.00	9.54	86.18	36.95	PASS
11	V	1	3160-09	20660.00	55.02	x	40.30	11.74	-35.73	16.31	71.33	PK	3.00	9.54	86.18	14.85	PASS
11	V	1	3160-09	20660.00	35.18	x	40.30	11.74	-35.73	16.31	51.49	AV	3.00	9.54	86.18	34.69	PASS
11	V	1	3160-09	22158.00	54.12		40.33	12.08	-35.73	16.68	70.80	PK	3.00	9.54	86.18	15.38	PASS
11	V	1	3160-09	22158.00	35.80		40.33	12.08	-35.73	16.68	52.48	AV	3.00	9.54	86.18	33.70	PASS
11	V	1	3160-09	23950.00	57.28	x	40.40	12.75	-35.73	17.42	74.70	PK	3.00	9.54	86.18	11.48	PASS
11	V	1	3160-09	23950.00	36.43	x	40.40	12.75	-35.73	17.42	53.85	AV	3.00	9.54	86.18	32.33	PASS
11	V	1	3160-09	24620.00	55.73		40.40	13.00	-35.73	17.67	73.40	PK	3.00	9.54	86.18	12.78	PASS
11	V	1	3160-09	24620.00	37.92		40.40	13.00	-35.73	17.67	55.59	AV	3.00	9.54	86.18	30.59	PASS

Formulae:

Total CF = Antenna Factor + Cable Factor + Other Factor (Amplifier Gain, filter loss, etc)

Field Strength = SA Reading + Total CF

Limit Distance Correction =  $40 \cdot \log(d1/d2)$  for  $F < 30$  MHz,  $20 \cdot \log(d1/d2)$  for  $F > 30$  MHz:

where d1 is the measurement distance, d2 is the published limit distance

Limit = Specified Limit + Limit Distance Correction

Margin = Limit - Field Strength

\*No harmonic emission where measured above the field strengths noted

<b>Applicant:</b>	Itronix Corporation	<b>IC ID:</b>	1943A-IX260Pf	<b>FCC ID:</b>	KBCIX260PROA580BT	
<b>Rugged Laptop PC with Intel Pro 2200BG 802.11b/g WLAN Mini-PCI Card</b>				<b>Model:</b>	IX260PROA580BT	
2005 Celltech Labs Inc. This document is not to be reproduced in whole or in part without the written permission of Celltech Labs Inc.						38 of 77

E.9.10. Channel 1 Out-of-Band Spurious Emission Field Strengths @ Specified Distance - Horizontal Polarization

Channel	Polarity	Measurement Distance	Antenna	Frequency	SA Level	Noise Floor	Antenna Factor	Cable Factor	Other Factors	Total CF	Field Strength	Detector	Limit Distance	Limit Distance Correction	-20 dBc Limit	Margin	Pass/Fail
1	H	3	Bilog SN1607	57.48	49.20		5.53	0.53	0.00	6.06	55.26	PK	3.00	0.00	81.70	26.44	PASS
1	H	3	Bilog SN1607	99.52	35.20		9.90	0.84	0.00	10.75	45.95	PK	3.00	0.00	81.70	35.75	PASS
1	H	3	Bilog SN1607	107.28	36.80		10.65	0.89	0.00	11.55	48.35	PK	3.00	0.00	81.70	33.35	PASS
1	H	3	Bilog SN1607	167.09	32.00		9.40	0.98	0.00	10.39	42.39	PK	3.00	0.00	81.70	39.31	PASS
1	H	3	Bilog SN1607	208.48	27.30		8.25	1.04	0.00	9.29	36.59	PK	3.00	0.00	81.70	45.11	PASS
1	H	3	Bilog SN1607	245.34	30.00		11.79	1.10	0.00	12.89	42.89	PK	3.00	0.00	81.70	38.81	PASS
1	H	3	Bilog SN1607	380.82	35.30		15.43	1.30	0.00	16.73	52.03	PK	3.00	0.00	81.70	29.67	PASS
1	H	3	Bilog SN1607	787.89	20.30		22.46	1.90	0.00	24.36	44.66	PK	3.00	0.00	81.70	37.04	PASS
1	H	3	Bilog SN1607	855.15	31.30		23.55	1.99	0.00	25.54	56.84	PK	3.00	0.00	81.70	24.86	PASS
1	H	3	Bilog SN1607	931.78	36.00		24.89	2.11	0.00	27.00	63.00	PK	3.00	0.00	81.70	18.70	PASS
1	H	3	Horn SN6276	2500.00	42.60		28.30	3.51	-36.42	-4.61	37.99	PK	3.00	0.00	81.70	43.71	PASS
1	H	3	Horn SN6276	5240.00	23.30	x	33.68	5.22	0.00	38.91	62.21	PK	3.00	0.00	81.70	19.49	PASS
1	H	3	Horn SN6276	7230.00	38.90		35.71	6.27	-35.56	6.41	45.31	PK	3.00	0.00	81.70	36.39	PASS
1	H	3	Horn SN6276	9610.00	37.10		37.59	7.37	-35.67	9.29	46.39	PK	3.00	0.00	81.70	35.31	PASS
1	H	3	Horn SN6276	17660.00	38.00	x	44.88	10.46	-36.02	19.33	57.33	PK	3.00	0.00	81.70	24.37	PASS
1	H	1	3160-09	19296.00	52.98		40.26	11.01	-35.81	15.45	68.43	PK	3.00	9.54	91.24	22.81	PASS
1	H	1	3160-09	19296.00	34.05		40.26	11.01	-35.81	15.45	49.50	AV	3.00	9.54	91.24	41.74	PASS
1	H	1	3160-09	21708.00	53.65		40.30	11.91	-35.73	16.48	70.13	PK	3.00	9.54	91.24	21.11	PASS
1	H	1	3160-09	21708.00	35.74		40.30	11.91	-35.73	16.48	52.22	AV	3.00	9.54	91.24	39.02	PASS
1	H	1	3160-09	24120.00	56.09		40.40	12.81	-35.73	17.48	73.57	PK	3.00	9.54	91.24	17.67	PASS
1	H	1	3160-09	24120.00	37.57		40.40	12.81	-35.73	17.48	55.05	AV	3.00	9.54	91.24	36.19	PASS
1	H	1	3160-09	24490.00	57.15		40.40	12.95	-35.73	17.62	74.77	PK	3.00	9.54	91.24	16.47	PASS
1	H	1	3160-09	24490.00	38.00		40.40	12.95	-35.73	17.62	55.62	AV	3.00	9.54	91.24	35.62	PASS

Formulae:

Total CF = Antenna Factor + Cable Factor + Other Factor (Amplifier Gain, filter loss, etc)

Field Strength = SA Reading + Total CF

Limit Distance Correction =  $40 \cdot \log(d1/d2)$  for  $F < 30$  MHz,  $20 \cdot \log(d1/d2)$  for  $F > 30$  MHz:

where d1 is the measurement distance, d2 is the published limit distance

Limit = Specified Limit + Limit Distance Correction

Margin = Limit - Field Strength

\*The frequency points reported describe the highest emission measured in each of the ranges tested and are used to describe the measured spectrum as a whole. Emissions that may be present in the restricted bands are evaluated against the appropriate limits in Appendix F. No out-of-band emissions were measured above the levels noted.

Test Report Serial No.:	022305KBC-T618-E15W	Issue 1
Test Date(s):	28Jun04 - 29Jul04, 22Oct04	
Test Type(s):	FCC §15.247	IC RSS-210 Issue 5
Lab Registration(s):	FCC #714830	IC Lab File #3874

E.9.11. Channel 1 Out-of-Band Spurious Emission Field Strengths @ Specified Distance - Vertical Polarization

Channel	Polarity	Measurement Distance	Antenna	Frequency	SA Level	Noise Floor	Antenna Factor	Cable Factor	Other Factors	Total CF	Field Strength	Detector	Limit Distance	Limit Distance Correction	-20 dBc Limit	Margin	Pass/Fail
													m	dB	dBuV/m	Δ dB	
1	V	3	LP-105	0.078	17.37		48.70	0.03	0.00	48.73	66.10	PK	3.00	0.00	76.09	9.99	PASS
1	V	3	LG-105	0.203	1.41		59.86	0.07	0.00	59.94	61.35	PK	3.00	0.00	76.09	14.74	PASS
1	V	3	LG-105	0.485	2.42		58.03	0.09	0.00	58.12	60.54	PK	3.00	0.00	76.09	15.55	PASS
1	V	3	LG-105	1.50	9.04		53.10	0.15	0.00	53.25	62.29	PK	3.00	0.00	76.09	13.80	PASS
1	V	3	LG-105	2.62	7.21		50.69	0.20	0.00	50.89	58.10	PK	3.00	0.00	76.09	17.99	PASS
1	V	3	LG-105	5.48	11.74		44.38	0.31	0.00	44.68	56.42	PK	3.00	0.00	76.09	19.67	PASS
1	V	3	LG-105	27.15	10.24		40.62	0.68	0.00	41.30	51.54	PK	3.00	0.00	76.09	24.55	PASS
1	V	3	Bilog SN1607	99.52	29.60		9.90	0.84	0.00	10.75	40.35	PK	3.00	0.00	76.09	35.74	PASS
1	V	3	Bilog SN1607	208.80	46.80		8.28	1.04	0.00	9.32	56.12	PK	3.00	0.00	76.09	19.97	PASS
1	V	3	Bilog SN1607	449.36	44.80		17.03	1.40	0.00	18.43	63.23	PK	3.00	0.00	76.09	12.86	PASS
1	V	3	Bilog SN1607	736.16	23.70		22.93	1.82	0.00	24.75	48.45	PK	3.00	0.00	76.09	27.64	PASS
1	V	3	Bilog SN1607	772.70	44.40		22.57	1.87	0.00	24.45	68.85	PK	3.00	0.00	76.09	7.24	PASS
1	V	3	Horn SN6276	3200.00	43.50		30.48	4.04	-35.93	-1.40	42.10	PK	3.00	0.00	76.09	33.99	PASS
1	V	3	Horn SN6276	4810.00	47.00		32.88	4.96	-35.30	2.54	49.54	PK	3.00	0.00	76.09	26.55	PASS
1	V	3	Horn SN6276	5260.00	40.10		33.72	5.23	-35.34	3.61	43.71	PK	3.00	0.00	76.09	32.38	PASS
1	V	3	Horn SN6276	5720.00	41.60		34.19	5.44	-35.38	4.25	45.85	PK	3.00	0.00	76.09	30.24	PASS
1	V	3	Horn SN6276	5770.00	44.80		34.21	5.45	-35.38	4.28	49.08	PK	3.00	0.00	76.09	27.01	PASS
1	V	3	Horn SN6276	7520.00	40.40		36.32	6.43	-35.53	7.21	47.61	PK	3.00	0.00	76.09	28.48	PASS
1	V	3	Horn SN6276	8360.00	37.60		37.06	6.79	-35.60	8.25	45.85	PK	3.00	0.00	76.09	30.24	PASS
1	V	3	Horn SN6276	9610.00	36.60		37.59	7.37	-35.71	9.25	45.85	PK	3.00	0.00	76.09	30.24	PASS

Formulae:

Total CF = Antenna Factor + Cable Factor + Other Factor (Amplifier Gain, filter loss, etc)

Field Strength = SA Reading + Total CF

Limit Distance Correction = 40\*log(d1/d2) for F<30 MHz, 20\*log(d1/d2) for F> 30 MHz:

where d1 is the measurement distance, d2 is the published limit distance

Limit = Specified Limit + Limit Distance Correction

Margin = Limit - Field Strength

\*The frequency points reported describe the highest emission measured in each of the ranges tested and are used to describe the measured spectrum as a whole. Emissions that may be present in the restricted bands are evaluated against the appropriate limits in Appendix F. No out-of-band emissions were measured above the levels noted.

Continued

Applicant:	Itronix Corporation	IC ID:	1943A-IX260Pf	FCC ID:	KBCIX260PROA580BT	
Rugged Laptop PC with Intel Pro 2200BG 802.11b/g WLAN Mini-PCI Card				Model:	IX260PROA580BT	
2005 Celltech Labs Inc. This document is not to be reproduced in whole or in part without the written permission of Celltech Labs Inc.						40 of 77

<b>Test Report Serial No.:</b>	022305KBC-T618-E15W	Issue 1
<b>Test Date(s):</b>	28Jun04 - 29Jul04, 22Oct04	
<b>Test Type(s):</b>	FCC §15.247	IC RSS-210 Issue 5
<b>Lab Registration(s):</b>	FCC #714830	IC Lab File #3874

Continued

Channel	Polarity	Measurement Distance	Antenna	Frequency	SA Level	Noise Floor	Antenna Factor	Cable Factor	Other Factors	Total CF	Field Strength	Detector	Limit Distance	Limit Distance Correction	-20 dBc Limit	Margin	Pass/Fail
													m	dB	dBuV/m	Δ dB	
1	V	3	Horn SN6276	12640.00	36.90		38.71	8.68	-36.79	10.59	47.49	PK	3.00	0.00	76.09	28.60	PASS
1	V	3	Horn SN6276	15740.00	38.20		37.56	9.77	-36.53	10.80	49.00	PK	3.00	0.00	76.09	27.09	PASS
1	V	1	3160-09	18820.00	53.92	x	40.20	11.05	-35.87	15.38	69.30	PK	3.00	9.54	85.63	16.33	PASS
1	V	1	3160-09	18820.00	33.66	x	40.20	11.05	-35.87	15.38	49.04	AV	3.00	9.54	85.63	36.59	PASS
1	V	1	3160-09	19296.00	52.65		40.26	11.01	-35.81	15.45	68.10	PK	3.00	9.54	85.63	17.53	PASS
1	V	1	3160-09	19296.00	33.76		40.26	11.01	-35.81	15.45	49.21	AV	3.00	9.54	85.63	36.42	PASS
1	V	1	3160-09	21708.00	53.27		40.30	11.91	-35.73	16.48	69.75	PK	3.00	9.54	85.63	15.88	PASS
1	V	1	3160-09	21708.00	36.04		40.30	11.91	-35.73	16.48	52.52	AV	3.00	9.54	85.63	33.11	PASS
1	V	1	3160-09	24120.00	56.03		40.40	12.81	-35.73	17.48	73.51	PK	3.00	9.54	85.63	12.12	PASS
1	V	1	3160-09	24120.00	37.21		40.40	12.81	-35.73	17.48	54.69	AV	3.00	9.54	85.63	30.94	PASS
1	V	1	3160-09	24550.00	56.31	x	40.40	12.97	-35.73	17.64	73.95	PK	3.00	9.54	85.63	11.68	PASS
1	V	1	3160-09	24550.00	38.30	x	40.40	12.97	-35.73	17.64	55.94	AV	3.00	9.54	85.63	29.69	PASS

**Formulae:**

Total CF = Antenna Factor + Cable Factor + Other Factor (Amplifier Gain, filter loss, etc)

Field Strength = SA Reading + Total CF

Limit Distance Correction =  $40 \cdot \log(d1/d2)$  for  $F < 30$  MHz,  $20 \cdot \log(d1/d2)$  for  $F > 30$  MHz:

where d1 is the measurement distance, d2 is the published limit distance

Limit = Specified Limit + Limit Distance Correction

Margin = Limit - Field Strength

**\*The frequency points reported describe the highest emission measured in each of the ranges tested and are used to describe the measured spectrum as a whole. Emissions that may be present in the restricted bands are evaluated against the appropriate limits in Appendix F. No out-of-band emissions were measured above the levels noted.**

<b>Applicant:</b>	Itronix Corporation	<b>IC ID:</b>	1943A-IX260Pf	<b>FCC ID:</b>	KBCIX260PROA580BT	
<b>Rugged Laptop PC with Intel Pro 2200BG 802.11b/g WLAN Mini-PCI Card</b>				<b>Model:</b>	IX260PROA580BT	
2005 Celltech Labs Inc. This document is not to be reproduced in whole or in part without the written permission of Celltech Labs Inc.						41 of 77

Test Report Serial No.:	022305KBC-T618-E15W	Issue 1
Test Date(s):	28Jun04 - 29Jul04, 22Oct04	
Test Type(s):	FCC §15.247	IC RSS-210 Issue 5
Lab Registration(s):	FCC #714830	IC Lab File #3874

E.9.12. Channel 6 Out-of-Band Spurious Emission Field Strengths @ Specified Distance - Horizontal Polarization

Channel	Polarity	Measurement Distance	Antenna	Frequency	SA Level	Noise Floor	Antenna Factor	Cable Factor	Other Factors	Total CF	Field Strength	Detector	Limit Distance	Limit Distance Correction	-20 dBc Limit	Margin	Pass/Fail
6	H	3	Bilog SN1607	60.70	29.20		5.03	0.56	0.00	5.59	34.79	PK	3.00	0.00	81.67	46.88	PASS
6	H	3	Bilog SN1607	107.28	36.50		10.65	0.89	0.00	11.55	48.05	PK	3.00	0.00	81.67	33.62	PASS
6	H	3	Bilog SN1607	208.48	29.70		8.25	1.04	0.00	9.29	38.99	PK	3.00	0.00	81.67	42.68	PASS
6	H	3	Bilog SN1607	786.92	24.50		22.47	1.89	0.00	24.36	48.86	PK	3.00	0.00	81.67	32.81	PASS
6	H	3	Bilog SN1607	929.51	19.50		24.83	2.10	0.00	26.94	46.44	PK	3.00	0.00	81.67	35.23	PASS
6	H	3	Horn SN6276	2750.00	38.60		29.15	3.69	-36.38	-3.53	35.07	PK	3.00	0.00	81.67	46.60	PASS
6	H	3	Horn SN6276	3240.00	37.00		30.58	4.06	-36.12	-1.48	35.52	PK	3.00	0.00	81.67	46.15	PASS
6	H	3	Horn SN6276	4860.00	36.70		32.99	5.02	-35.46	2.55	39.25	PK	3.00	0.00	81.67	42.42	PASS
6	H	3	Horn SN6276	5260.00	45.20		33.72	5.23	-35.47	3.47	48.67	PK	3.00	0.00	81.67	33.00	PASS
6	H	3	Horn SN6276	5770.00	37.20		34.21	5.45	-35.50	4.16	41.36	PK	3.00	0.00	81.67	40.31	PASS
6	H	3	Horn SN6276	8280.00	38.40		36.98	6.75	-35.61	8.11	46.51	PK	3.00	0.00	81.67	35.16	PASS
6	H	3	Horn SN6276	8360.00	42.30		37.06	6.79	-35.62	8.24	50.54	PK	3.00	0.00	81.67	31.13	PASS
6	H	3	Horn SN6276	17090.00	39.20		41.24	10.38	-36.09	15.54	54.74	PK	3.00	0.00	81.67	26.93	PASS
6	H	1	3160-09	19496.00	52.56		40.30	11.28	-35.79	15.79	68.35	PK	3.00	9.54	91.21	22.86	PASS
6	H	1	3160-09	19496.00	33.91		40.30	11.28	-35.79	15.79	49.70	AV	3.00	9.54	91.21	41.51	PASS
6	H	1	3160-09	21240.00	54.98	x	40.30	11.73	-35.73	16.31	71.29	PK	3.00	9.54	91.21	19.93	PASS
6	H	1	3160-09	21240.00	35.72	x	40.30	11.73	-35.73	16.31	52.03	AV	3.00	9.54	91.21	39.19	PASS
6	H	1	3160-09	21933.00	54.66		40.30	11.99	-35.73	16.57	71.23	PK	3.00	9.54	91.21	19.99	PASS
6	H	1	3160-09	21933.00	36.27		40.30	11.99	-35.73	16.57	52.84	AV	3.00	9.54	91.21	38.38	PASS
6	H	1	3160-09	24370.00	57.10		40.40	12.90	-35.73	17.58	74.68	PK	3.00	9.54	91.21	16.54	PASS
6	H	1	3160-09	24370.00	37.88		40.40	12.90	-35.73	17.58	55.46	AV	3.00	9.54	91.21	35.76	PASS
6	H	1	3160-09	24420.00	56.93	x	40.40	12.92	-35.73	17.60	74.53	PK	3.00	9.54	91.21	16.69	PASS
6	H	1	3160-09	24420.00	37.73	x	40.40	12.92	-35.73	17.60	55.33	AV	3.00	9.54	91.21	35.89	PASS

Formulae:

Total CF = Antenna Factor + Cable Factor + Other Factor (Amplifier Gain, filter loss, etc)

Field Strength = SA Reading + Total CF

Limit Distance Correction =  $40 \cdot \log(d1/d2)$  for  $F < 30$  MHz,  $20 \cdot \log(d1/d2)$  for  $F > 30$  MHz:

where d1 is the measurement distance, d2 is the published limit distance

Limit = Specified Limit + Limit Distance Correction

Margin = Limit - Field Strength

\*The frequency points reported describe the highest emission measured in each of the ranges tested and are used to describe the measured spectrum as a whole. Emissions that may be present in the restricted bands are evaluated against the appropriate limits in Appendix F. No out-of-band emissions were measured above the levels noted.

Applicant:	Itronix Corporation	IC ID:	1943A-IX260Pf	FCC ID:	KBCIX260PROA580BT	
Rugged Laptop PC with Intel Pro 2200BG 802.11b/g WLAN Mini-PCI Card				Model:	IX260PROA580BT	
2005 Celltech Labs Inc. This document is not to be reproduced in whole or in part without the written permission of Celltech Labs Inc.						42 of 77

E.9.13. Channel 6 Out-of-Band Spurious Emission Field Strengths @ Specified Distance - Vertical Polarization

Channel	Polarity	Measurement Distance	Antenna	Frequency	SA Level	Noise Floor	Antenna Factor	Cable Factor	Other Factors	Total CF	Field Strength	Detector	Limit Distance	Limit Distance Correction	-20 dBc Limit	Margin	Pass/Fail
6	V	3	LP-105	0.08	17.57		48.71	0.05	0.00	48.76	66.33	PK	3.00	0.00	75.37	9.04	PASS
6	V	3	LG-105	2.03	9.04		52.21	0.17	0.00	52.39	61.43	PK	3.00	0.00	75.37	13.94	PASS
6	V	3	LG-105	0.83	2.38		57.38	0.11	0.00	57.49	59.87	PK	3.00	0.00	75.37	15.50	PASS
6	V	3	LG-105	1.50	8.52		53.11	0.15	0.00	53.26	61.78	PK	3.00	0.00	75.37	13.59	PASS
6	V	3	LG-105	3.22	8.34		49.31	0.23	0.00	49.54	57.88	PK	3.00	0.00	75.37	17.49	PASS
6	V	3	LG-105	5.63	12.44		44.09	0.31	0.00	44.40	56.84	PK	3.00	0.00	75.37	18.53	PASS
6	V	3	LG-105	17.80	9.89		41.04	0.55	0.00	41.59	51.48	PK	3.00	0.00	75.37	23.89	PASS
6	V	3	Bilog SN1607	57.48	30.80		5.53	0.53	0.00	6.06	36.86	PK	3.00	0.00	75.37	38.51	PASS
6	V	3	Bilog SN1607	99.52	28.50		9.90	0.84	0.00	10.75	39.25	PK	3.00	0.00	75.37	36.12	PASS
6	V	3	Bilog SN1607	103.72	27.90		10.33	0.88	0.00	11.21	39.11	PK	3.00	0.00	75.37	36.26	PASS
6	V	3	Bilog SN1607	138.96	37.30		11.14	0.94	0.00	12.08	49.38	PK	3.00	0.00	75.37	25.99	PASS
6	V	3	Bilog SN1607	166.77	24.50		9.43	0.98	0.00	10.41	34.91	PK	3.00	0.00	75.37	40.46	PASS
6	V	3	Bilog SN1607	196.19	31.70		8.47	1.03	0.00	9.49	41.19	PK	3.00	0.00	75.37	34.18	PASS
6	V	3	Bilog SN1607	196.52	29.70		8.44	1.03	0.00	9.47	39.17	PK	3.00	0.00	75.37	36.20	PASS
6	V	3	Bilog SN1607	246.96	28.50		11.97	1.10	0.00	13.07	41.57	PK	3.00	0.00	75.37	33.80	PASS
6	V	3	Bilog SN1607	306.45	27.50		13.40	1.19	0.00	14.58	42.08	PK	3.00	0.00	75.37	33.29	PASS
6	V	3	Bilog SN1607	772.70	37.20		22.57	1.87	0.00	24.45	61.65	PK	3.00	0.00	75.37	13.72	PASS
6	V	3	Bilog SN1607	952.47	34.80		25.36	2.14	0.00	27.50	62.30	PK	3.00	0.00	75.37	13.07	PASS
6	V	3	Horn SN6276	2830.00	37.90		29.42	3.75	-36.33	-3.16	34.74	PK	3.00	0.00	75.37	40.63	PASS
6	V	3	Horn SN6276	5240.00	37.30		33.68	5.22	-35.47	3.43	40.73	PK	3.00	0.00	75.37	34.64	PASS
6	V	3	Horn SN6276	5770.00	40.10		34.21	5.45	-35.50	4.16	44.26	PK	3.00	0.00	75.37	31.11	PASS
6	V	3	Horn SN6276	7520.00	37.80		36.32	6.43	-35.58	7.17	44.97	PK	3.00	0.00	75.37	30.40	PASS

Formulae:

Total CF = Antenna Factor + Cable Factor + Other Factor (Amplifier Gain, filter loss, etc)

Field Strength = SA Reading + Total CF

Limit Distance Correction = 40\*log(d1/d2) for F<30 MHz, 20\*log(d1/d2) for F> 30 MHz:

where d1 is the measurement distance, d2 is the published limit distance

Limit = Specified Limit + Limit Distance Correction

Margin = Limit - Field Strength

\*The frequency points reported describe the highest emission measured in each of the ranges tested and are used to describe the measured spectrum as a whole. Emissions that may be present in the restricted bands are evaluated against the appropriate limits in Appendix F. No out-of-band emissions were measured above the levels noted.

Continued

Applicant:	Itronix Corporation	IC ID:	1943A-IX260Pf	FCC ID:	KBCIX260PROA580BT	
Rugged Laptop PC with Intel Pro 2200BG 802.11b/g WLAN Mini-PCI Card				Model:	IX260PROA580BT	
2005 Celltech Labs Inc. This document is not to be reproduced in whole or in part without the written permission of Celltech Labs Inc.						43 of 77



<b>Test Report Serial No.:</b>	022305KBC-T618-E15W	Issue 1
<b>Test Date(s):</b>	28Jun04 - 29Jul04, 22Oct04	
<b>Test Type(s):</b>	FCC §15.247	IC RSS-210 Issue 5
<b>Lab Registration(s):</b>	FCC #714830	IC Lab File #3874

Continued

Channel	Polarity	Measurement Distance	Antenna	Frequency	SA Level	Noise Floor	Antenna Factor	Cable Factor	Other Factors	Total CF	Field Strength	Detector	Limit Distance	Limit Distance Correction	-20 dBc Limit	Margin	Pass/Fail
													m	dB	dBuV/m	Δ dB	
6	V	3	Horn SN6276	9720.00	36.80		37.68	7.34	-35.71	9.31	46.11	PK	3.00	0.00	75.37	29.26	PASS
6	V	3	Horn SN6276	16480.00	38.30	x	38.45	10.25	-36.16	12.54	50.84	PK	3.00	0.00	75.37	24.53	PASS
6	V	1	3160-09	19190.00	54.26	x	40.24	10.91	-35.83	15.32	69.58	PK	3.00	9.54	84.91	15.33	PASS
6	V	1	3160-09	19190.00	33.78	x	40.24	10.91	-35.83	15.32	49.10	AV	3.00	9.54	84.91	35.81	PASS
6	V	1	3160-09	19496.00	52.89		40.30	11.28	-35.79	15.79	68.68	PK	3.00	9.54	84.91	16.23	PASS
6	V	1	3160-09	19496.00	33.88		40.30	11.28	-35.79	15.79	49.67	AV	3.00	9.54	84.91	35.24	PASS
6	V	1	3160-09	21933.00	53.99		40.30	11.99	-35.73	16.57	70.56	PK	3.00	9.54	84.91	14.36	PASS
6	V	1	3160-09	21933.00	36.23		40.30	11.99	-35.73	16.57	52.80	AV	3.00	9.54	84.91	32.12	PASS
6	V	1	3160-09	24370.00	55.56		40.40	12.90	-35.73	17.58	73.14	PK	3.00	9.54	84.91	11.78	PASS
6	V	1	3160-09	24370.00	37.88		40.40	12.90	-35.73	17.58	55.46	AV	3.00	9.54	84.91	29.46	PASS
6	V	1	3160-09	24400.00	56.66	x	40.40	12.91	-35.73	17.59	74.25	PK	3.00	9.54	84.91	10.66	PASS
6	V	1	3160-09	24400.00	37.87	x	40.40	12.91	-35.73	17.59	55.46	AV	3.00	9.54	84.91	29.45	PASS

**Formulae:**

Total CF = Antenna Factor + Cable Factor + Other Factor (Amplifier Gain, filter loss, etc)

Field Strength = SA Reading + Total CF

Limit Distance Correction =  $40 \cdot \log(d1/d2)$  for  $F < 30$  MHz,  $20 \cdot \log(d1/d2)$  for  $F > 30$  MHz:

where d1 is the measurement distance, d2 is the published limit distance

Limit = Specified Limit + Limit Distance Correction

Margin = Limit - Field Strength

**\*The frequency points reported describe the highest emission measured in each of the ranges tested and are used to describe the measured spectrum as a whole. Emissions that may be present in the restricted bands are evaluated against the appropriate limits in Appendix F. No out-of-band emissions were measured above the levels noted.**

<b>Applicant:</b>	Itronix Corporation	<b>IC ID:</b>	1943A-IX260Pf	<b>FCC ID:</b>	KBCIX260PROA580BT	
<b>Rugged Laptop PC with Intel Pro 2200BG 802.11b/g WLAN Mini-PCI Card</b>				<b>Model:</b>	IX260PROA580BT	
2005 Celltech Labs Inc. This document is not to be reproduced in whole or in part without the written permission of Celltech Labs Inc.						44 of 77



E.9.14. Channel 11 Out-of-Band Spurious Emission Field Strengths @ Specified Distance - Horizontal Polarization

Channel	Polarity	Measurement Distance	Antenna	Frequency	SA Level	Noise Floor	Antenna Factor	Cable Factor	Other Factors	Total CF	Field Strength	Detector	Limit Distance	Limit Distance Correction	-20 dBc Limit	Margin	Pass/Fail
11	H	3	Bilog SN1607	57.80	48.10		5.45	0.54	0.00	5.99	54.09	PK	3.00	0.00	82.23	28.14	PASS
11	H	3	Bilog SN1607	101.13	38.90		10.10	0.86	0.00	10.96	49.86	PK	3.00	0.00	82.23	32.37	PASS
11	H	3	Bilog SN1607	141.55	31.30		11.07	0.95	0.00	12.01	43.31	PK	3.00	0.00	82.23	38.92	PASS
11	H	3	Bilog SN1607	208.80	31.20		8.28	1.04	0.00	9.32	40.52	PK	3.00	0.00	82.23	41.71	PASS
11	H	3	Bilog SN1607	297.72	29.20		13.28	1.17	0.00	14.45	43.65	PK	3.00	0.00	82.23	38.58	PASS
11	H	3	Bilog SN1607	381.14	44.00		15.45	1.30	0.00	16.74	60.74	PK	3.00	0.00	82.23	21.49	PASS
11	H	3	Bilog SN1607	772.70	28.40		22.57	1.87	0.00	24.45	52.85	PK	3.00	0.00	82.23	29.38	PASS
11	H	3	Bilog SN1607	944.39	31.30		25.21	2.13	0.00	27.34	58.64	PK	3.00	0.00	82.23	23.59	PASS
11	H	3	Horn SN6276	2810.00	37.50		29.35	3.74	-36.34	-3.25	34.25	PK	3.00	0.00	82.23	47.98	PASS
11	H	3	Horn SN6276	4900.00	39.50		33.08	5.05	-35.46	2.68	42.18	PK	3.00	0.00	82.23	40.05	PASS
11	H	3	Horn SN6276	5260.00	45.80		33.72	5.23	-35.47	3.47	49.27	PK	3.00	0.00	82.23	32.96	PASS
11	H	3	Horn SN6276	8280.00	39.30		36.98	6.75	-35.61	8.11	47.41	PK	3.00	0.00	82.23	34.82	PASS
11	H	3	Horn SN6276	8360.00	42.10		37.06	6.79	-35.62	8.24	50.34	PK	3.00	0.00	82.23	31.89	PASS
11	H	3	Horn SN6276	9820.00	39.00		37.76	7.44	-35.77	9.42	48.42	PK	3.00	0.00	82.23	33.81	PASS
11	H	3	Horn SN6276	15920.00	38.90	x	37.38	9.83	-36.23	10.98	49.88	PK	3.00	0.00	82.23	32.35	PASS
11	H	1	3160-09	18810.00	53.72	x	40.20	11.15	-35.87	15.48	69.20	PK	3.00	9.54	91.77	22.58	PASS
11	H	1	3160-09	18810.00	33.94	x	40.20	11.15	-35.87	15.48	49.42	AV	3.00	9.54	91.77	42.36	PASS
11	H	1	3160-09	19696.00	53.67		40.30	11.42	-35.76	15.95	69.62	PK	3.00	9.54	91.77	22.15	PASS
11	H	1	3160-09	19696.00	33.44		40.30	11.42	-35.76	15.95	49.39	AV	3.00	9.54	91.77	42.38	PASS
11	H	1	3160-09	22158.00	53.69		40.33	12.08	-35.73	16.68	70.37	PK	3.00	9.54	91.77	21.40	PASS
11	H	1	3160-09	22158.00	35.90		40.33	12.08	-35.73	16.68	52.58	AV	3.00	9.54	91.77	39.19	PASS
11	H	1	3160-09	24460.00	56.88	x	40.40	12.94	-35.73	17.61	74.49	PK	3.00	9.54	91.77	17.28	PASS
11	H	1	3160-09	24460.00	37.32	x	40.40	12.94	-35.73	17.61	54.93	AV	3.00	9.54	91.77	36.84	PASS
11	H	1	3160-09	24620.00	55.75		40.40	13.00	-35.73	17.67	73.42	PK	3.00	9.54	91.77	18.35	PASS
11	H	1	3160-09	24620.00	37.57		40.40	13.00	-35.73	17.67	55.24	AV	3.00	9.54	91.77	36.53	PASS

Formulae:

Total CF = Antenna Factor + Cable Factor + Other Factor (Amplifier Gain, filter loss, etc)

Field Strength = SA Reading + Total CF

Limit Distance Correction = 40\*log(d1/d2) for F<30 MHz, 20\*log(d1/d2) for F> 30 MHz:

where d1 is the measurement distance, d2 is the published limit distance

Limit = Specified Limit + Limit Distance Correction

Margin = Limit - Field Strength

**\*The frequency points reported describe the highest emission measured in each of the ranges tested and are used to describe the measured spectrum as a whole. Emissions that may be present in the restricted bands are evaluated against the appropriate limits in Appendix F. No out-of-band emissions were measured above the levels noted.**

Test Report Serial No.:	022305KBC-T618-E15W	Issue 1
Test Date(s):	28Jun04 - 29Jul04, 22Oct04	
Test Type(s):	FCC §15.247	IC RSS-210 Issue 5
Lab Registration(s):	FCC #714830	IC Lab File #3874

E.9.15. Channel 11 Out-of-Band Spurious Emission Field Strengths @ Specified Distance - Vertical Polarization

Channel	Polarity	Measurement Distance	Antenna	Frequency	SA Level	Noise Floor	Antenna Factor	Cable Factor	Other Factors	Total CF	Field Strength	Detector	Limit Distance	Limit Distance Correction	-20 dBc Limit	Margin	Pass/Fail
11	V	3	LP-105	0.08	19.50		48.79	0.04	0.00	48.83	68.33	PK	3.00	0.00	76.64	8.31	PASS
11	V	3	LG-105	0.20	1.04		59.88	0.07	0.00	59.95	60.99	PK	3.00	0.00	76.64	15.65	PASS
11	V	3	LG-105	0.79	1.46		57.46	0.12	0.00	57.57	59.03	PK	3.00	0.00	76.64	17.61	PASS
11	V	3	LG-105	1.44	8.37		53.25	0.15	0.00	53.40	61.77	PK	3.00	0.00	76.64	14.87	PASS
11	V	3	LG-105	4.05	10.60		47.10	0.26	0.00	47.36	57.96	PK	3.00	0.00	76.64	18.68	PASS
11	V	3	LG-105	5.26	10.77		44.79	0.30	0.00	45.09	55.86	PK	3.00	0.00	76.64	20.78	PASS
11	V	3	LG-105	13.95	9.95		40.60	0.50	0.00	41.09	51.04	PK	3.00	0.00	76.64	25.60	PASS
11	V	3	Bilog SN1607	138.96	37.30		11.14	0.94	0.00	12.08	49.38	PK	3.00	0.00	76.64	27.26	PASS
11	V	3	Bilog SN1607	149.63	56.50		10.72	0.96	0.00	11.68	68.18	PK	3.00	0.00	76.64	8.46	PASS
11	V	3	Bilog SN1607	208.48	44.90		8.25	1.04	0.00	9.29	54.19	PK	3.00	0.00	76.64	22.45	PASS
11	V	3	Bilog SN1607	794.04	35.60		22.51	1.90	0.00	24.42	60.02	PK	3.00	0.00	76.64	16.62	PASS
11	V	3	Horn SN6276	2810.00	37.20		29.35	3.74	-36.34	-3.25	33.95	PK	3.00	0.00	76.64	42.69	PASS
11	V	3	Horn SN6276	5270.00	36.40		33.73	5.24	-35.47	3.49	39.89	PK	3.00	0.00	76.64	36.75	PASS
11	V	3	Horn SN6276	5770.00	42.50		34.21	5.45	-35.50	4.16	46.66	PK	3.00	0.00	76.64	29.98	PASS
11	V	3	Horn SN6276	9820.00	36.60		37.76	7.44	-35.77	9.42	46.02	PK	3.00	0.00	76.64	30.62	PASS
11	V	3	Horn SN6276	16680.00	39.00	x	39.29	10.24	-36.14	13.40	52.40	PK	3.00	0.00	76.64	24.24	PASS
11	V	1	3160-09	19696.00	53.07		40.30	11.42	-35.76	15.95	69.02	PK	3.00	9.54	86.18	17.16	PASS
11	V	1	3160-09	19696.00	33.28		40.30	11.42	-35.76	15.95	49.23	AV	3.00	9.54	86.18	36.95	PASS
11	V	1	3160-09	20660.00	55.02	x	40.30	11.74	-35.73	16.31	71.33	PK	3.00	9.54	86.18	14.85	PASS
11	V	1	3160-09	20660.00	35.18	x	40.30	11.74	-35.73	16.31	51.49	AV	3.00	9.54	86.18	34.69	PASS
11	V	1	3160-09	22158.00	54.12		40.33	12.08	-35.73	16.68	70.80	PK	3.00	9.54	86.18	15.38	PASS
11	V	1	3160-09	22158.00	35.80		40.33	12.08	-35.73	16.68	52.48	AV	3.00	9.54	86.18	33.70	PASS
11	V	1	3160-09	23950.00	57.28	x	40.40	12.75	-35.73	17.42	74.70	PK	3.00	9.54	86.18	11.48	PASS
11	V	1	3160-09	23950.00	36.43	x	40.40	12.75	-35.73	17.42	53.85	AV	3.00	9.54	86.18	32.33	PASS
11	V	1	3160-09	24620.00	55.73		40.40	13.00	-35.73	17.67	73.40	PK	3.00	9.54	86.18	12.78	PASS

Formulae:

Total CF = Antenna Factor + Cable Factor + Other Factor (Amplifier Gain, filter loss, etc)  
 Field Strength = SA Reading + Total CF  
 Limit Distance Correction = 40\*log(d1/d2) for F<30 MHz, 20\*log(d1/d2) for F> 30 MHz:  
 where d1 is the measurement distance, d2 is the published limit distance  
 Limit = Specified Limit + Limit Distance Correction  
 Margin = Limit - Field Strength

\*The frequency points reported describe the highest emission measured in each of the ranges tested and are used to describe the measured spectrum as a whole. Emissions that may be present in the restricted bands are evaluated against the appropriate limits in Appendix F. No out-of-band emissions were measured above the levels noted.

Applicant:	Itronix Corporation	IC ID:	1943A-IX260Pf	FCC ID:	KBCIX260PROA580BT	
Rugged Laptop PC with Intel Pro 2200BG 802.11b/g WLAN Mini-PCI Card				Model:	IX260PROA580BT	
2005 Celltech Labs Inc. This document is not to be reproduced in whole or in part without the written permission of Celltech Labs Inc.						46 of 77

<b>Test Report Serial No.:</b>	022305KBC-T618-E15W	Issue 1
<b>Test Date(s):</b>	28Jun04 - 29Jul04, 22Oct04	
<b>Test Type(s):</b>	FCC §15.247	IC RSS-210 Issue 5
<b>Lab Registration(s):</b>	FCC #714830	IC Lab File #3874

### E.10. PASS/FAIL

In reference to the results outlined in E.9, the DUT passes the requirements as stated in the reference standards as follows:  
FCC 15.247 (c): All emissions within any 100 kHz bandwidth outside the operating frequency band are greater than 20 dB below the maximum 100 kHz bandwidth signal within the operating band.

### E.11. SIGN-OFF

I attest to the accuracy of the data. All measurements reported herein were performed by me and are correct to the best of my knowledge and belief. I assume full responsibility for the completeness of these measurements.



\_\_\_\_\_  
Russell Pipe  
Senior Compliance Technologist  
Celltech Labs Inc.

\_\_\_\_\_  
22Oct04  
Date

<b>Applicant:</b>	Itronix Corporation	<b>IC ID:</b>	1943A-IX260Pf	<b>FCC ID:</b>	KBCIX260PROA580BT	
<b>Rugged Laptop PC with Intel Pro 2200BG 802.11b/g WLAN Mini-PCI Card</b>				<b>Model:</b>	IX260PROA580BT	
2005 Celltech Labs Inc. This document is not to be reproduced in whole or in part without the written permission of Celltech Labs Inc.						47 of 77

Test Report Serial No.:	022305KBC-T618-E15W	Issue 1
Test Date(s):	28Jun04 - 29Jul04, 22Oct04	
Test Type(s):	FCC §15.247	IC RSS-210 Issue 5
Lab Registration(s):	FCC #714830	IC Lab File #3874

### Appendix F - Restricted Band Emissions Measurement

F.1. REFERENCES	
Normative Reference Standard	FCC CFR 47 §15.205 (a) (b), FCC CFR 47 §15.209 (a)
Procedure Reference	FCC 97-114

F.2. LIMITS																																																																									
FCC CFR 47 §15.205	(a) Except as shown in paragraph (d) of this section, only spurious emissions are permitted in any of the frequency bands listed below:																																																																								
	<table border="1"> <thead> <tr> <th>MHz</th> <th>MHz</th> <th>MHz</th> <th>GHz</th> </tr> </thead> <tbody> <tr><td>0.090-0.110</td><td>16.42-16.423</td><td>399.9-410</td><td>4.5-5.15</td></tr> <tr><td>10.495-0.505</td><td>16.69475-16.69525</td><td>608-614</td><td>5.35-5.46</td></tr> <tr><td>2.1735-2.1905</td><td>16.80425-16.80475</td><td>960-1240</td><td>7.25-7.75</td></tr> <tr><td>4.125-4.128</td><td>25.5-25.67</td><td>1300-1427</td><td>8.025-8.5</td></tr> <tr><td>4.17725-4.17775</td><td>37.5-38.25</td><td>1435-1626.5</td><td>9.0-9.2</td></tr> <tr><td>4.20725-4.20775</td><td>73-74.6</td><td>1645.5-1646.5</td><td>9.3-9.5</td></tr> <tr><td>6.215-6.218</td><td>74.8-75.2</td><td>1660-1710</td><td>10.6-12.7</td></tr> <tr><td>6.26775-6.26825</td><td>108-121.94</td><td>1718.8-1722.2</td><td>13.25-13.4</td></tr> <tr><td>6.31175-6.31225</td><td>123-138</td><td>2200-2300</td><td>14.47-14.5</td></tr> <tr><td>8.291-8.294</td><td>149.9-150.05</td><td>2310-2390</td><td>15.35-16.2</td></tr> <tr><td>8.362-8.366</td><td>156.52475-156.52525</td><td>2483.5-2500</td><td>17.7-21.4</td></tr> <tr><td>8.37625-8.38675</td><td>156.7-156.9</td><td>2655-2900</td><td>22.01-23.12</td></tr> <tr><td>8.41425-8.41475</td><td>162.0125-167.17</td><td>3260-3267</td><td>23.6-24.0</td></tr> <tr><td>12.29-12.293</td><td>167.72-173.2</td><td>3332-3339</td><td>31.2-31.8</td></tr> <tr><td>12.51975-12.52025</td><td>240-285</td><td>3345.8-3358</td><td>36.43-36.5</td></tr> <tr><td>12.57675-12.57725</td><td>322-335.4</td><td>3600-4400</td><td>(<sup>2</sup>)</td></tr> <tr><td>13.36-13.41</td><td></td><td></td><td></td></tr> </tbody> </table> <p><sup>1</sup> Until February 1, 1999, this restricted band shall be 0.490-0.510 MHz.  <sup>2</sup> Above 38.6</p>	MHz	MHz	MHz	GHz	0.090-0.110	16.42-16.423	399.9-410	4.5-5.15	10.495-0.505	16.69475-16.69525	608-614	5.35-5.46	2.1735-2.1905	16.80425-16.80475	960-1240	7.25-7.75	4.125-4.128	25.5-25.67	1300-1427	8.025-8.5	4.17725-4.17775	37.5-38.25	1435-1626.5	9.0-9.2	4.20725-4.20775	73-74.6	1645.5-1646.5	9.3-9.5	6.215-6.218	74.8-75.2	1660-1710	10.6-12.7	6.26775-6.26825	108-121.94	1718.8-1722.2	13.25-13.4	6.31175-6.31225	123-138	2200-2300	14.47-14.5	8.291-8.294	149.9-150.05	2310-2390	15.35-16.2	8.362-8.366	156.52475-156.52525	2483.5-2500	17.7-21.4	8.37625-8.38675	156.7-156.9	2655-2900	22.01-23.12	8.41425-8.41475	162.0125-167.17	3260-3267	23.6-24.0	12.29-12.293	167.72-173.2	3332-3339	31.2-31.8	12.51975-12.52025	240-285	3345.8-3358	36.43-36.5	12.57675-12.57725	322-335.4	3600-4400	( <sup>2</sup> )	13.36-13.41			
MHz	MHz	MHz	GHz																																																																						
0.090-0.110	16.42-16.423	399.9-410	4.5-5.15																																																																						
10.495-0.505	16.69475-16.69525	608-614	5.35-5.46																																																																						
2.1735-2.1905	16.80425-16.80475	960-1240	7.25-7.75																																																																						
4.125-4.128	25.5-25.67	1300-1427	8.025-8.5																																																																						
4.17725-4.17775	37.5-38.25	1435-1626.5	9.0-9.2																																																																						
4.20725-4.20775	73-74.6	1645.5-1646.5	9.3-9.5																																																																						
6.215-6.218	74.8-75.2	1660-1710	10.6-12.7																																																																						
6.26775-6.26825	108-121.94	1718.8-1722.2	13.25-13.4																																																																						
6.31175-6.31225	123-138	2200-2300	14.47-14.5																																																																						
8.291-8.294	149.9-150.05	2310-2390	15.35-16.2																																																																						
8.362-8.366	156.52475-156.52525	2483.5-2500	17.7-21.4																																																																						
8.37625-8.38675	156.7-156.9	2655-2900	22.01-23.12																																																																						
8.41425-8.41475	162.0125-167.17	3260-3267	23.6-24.0																																																																						
12.29-12.293	167.72-173.2	3332-3339	31.2-31.8																																																																						
12.51975-12.52025	240-285	3345.8-3358	36.43-36.5																																																																						
12.57675-12.57725	322-335.4	3600-4400	( <sup>2</sup> )																																																																						
13.36-13.41																																																																									
	(b) Except as provided in paragraphs (d) and (e), the field strength of emissions appearing within these frequency bands shall not exceed the limits shown in 15.209. At frequencies equal to or less than 1000 MHz, compliance with the limits in Section 15.209 shall be demonstrated using measurement instrumentation employing a CISPR quasi-peak detector. Above 1000 MHz, compliance with the emission limits in Section 15.209 shall be demonstrated based on the average value of the measured emissions. The provisions of 15.35 apply to these measurements.																																																																								
FCC CFR 47 §15.209	(a) Except as provided elsewhere in this Subpart, the emissions from an intentional radiator shall not exceed the field strength levels specified in the following table:																																																																								
	<table border="1"> <thead> <tr> <th>Frequency</th> <th>Field Strength</th> <th>Measurement Distance</th> </tr> <tr> <th>MHz</th> <th>uV/m</th> <th>Meters</th> </tr> </thead> <tbody> <tr><td>.009 - 0.490</td><td>2400/F(kHz)</td><td>300</td></tr> <tr><td>0.490 - 1.705</td><td>24000/F(kHz)</td><td>30</td></tr> <tr><td>1.705 - 30.0</td><td>30</td><td>30</td></tr> <tr><td>30 - 88</td><td>100</td><td>3</td></tr> <tr><td>88 - 216</td><td>150</td><td>3</td></tr> <tr><td>216 - 960</td><td>200</td><td>3</td></tr> <tr><td>Above 960</td><td>500</td><td>3</td></tr> </tbody> </table>	Frequency	Field Strength	Measurement Distance	MHz	uV/m	Meters	.009 - 0.490	2400/F(kHz)	300	0.490 - 1.705	24000/F(kHz)	30	1.705 - 30.0	30	30	30 - 88	100	3	88 - 216	150	3	216 - 960	200	3	Above 960	500	3																																													
Frequency	Field Strength	Measurement Distance																																																																							
MHz	uV/m	Meters																																																																							
.009 - 0.490	2400/F(kHz)	300																																																																							
0.490 - 1.705	24000/F(kHz)	30																																																																							
1.705 - 30.0	30	30																																																																							
30 - 88	100	3																																																																							
88 - 216	150	3																																																																							
216 - 960	200	3																																																																							
Above 960	500	3																																																																							
	(b) In the emission table above, the tighter limit applies at the band edges.																																																																								

<b>Test Report Serial No.:</b>	022305KBC-T618-E15W	Issue 1
<b>Test Date(s):</b>	28Jun04 - 29Jul04, 22Oct04	
<b>Test Type(s):</b>	FCC §15.247	IC RSS-210 Issue 5
<b>Lab Registration(s):</b>	FCC #714830	IC Lab File #3874

F.3. ENVIRONMENTAL CONDITIONS	
<b>Temperature</b>	27.4 +/- 2 °C
<b>Humidity</b>	33 +/- 2 %
<b>Barometric Pressure</b>	96.24 +/- 0.2 kPa

F.4. EQUIPMENT LIST					
ASSET NUMBER	MANUFACTURER	MODEL	DESCRIPTION	LAST CAL	CAL DUE
00072	EMCO	2075	Mini-mast	n/a	n/a
00073	EMCO	2080	Turn Table	n/a	n/a
00071	EMCO	2090	Multi-Device Controller	n/a	n/a
00200	Empire	LG-105	Large Loop Antenna	30Apr04	30Apr05
00201	Empire	LC-105	Small Loop Antenna	30Apr04	30Apr05
00050	Chase	CBL-6111A	Bilog Antenna	30Apr04	30Apr05
00035	ETS	3115	Double Ridged Guide Horn	24Mar04	24Mar05
00202	ETS	3160-09	Small Horn Antenna	27May04	27May05
00015	Agilent	E4408B	Spectrum Analyzer	29Dec03	29Dec04
00049	HP	8566B	Spectrum Analyzer RF Section	18May04	18May05
00049	HP	85650A	Quasi-peak Adapter	18May04	18May05
00047	HP	85685A	RF Preselector	18May04	18May05
00048	Gore	65474	Microwave Cable	20May04	20May05
00030	HP	83017A	LNA	20May04	20May05

<b>Applicant:</b>	Itronix Corporation	<b>IC ID:</b>	1943A-IX260Pf	<b>FCC ID:</b>	KBCIX260PROA580BT	
<b>Rugged Laptop PC with Intel Pro 2200BG 802.11b/g WLAN Mini-PCI Card</b>				<b>Model:</b>	IX260PROA580BT	
2005 Celltech Labs Inc. This document is not to be reproduced in whole or in part without the written permission of Celltech Labs Inc.						49 of 77

**F.5. MEASUREMENT EQUIPMENT SETUP**

<b>MEASUREMENT EQUIPMENT CONNECTIONS</b>	The measurement equipment was connected as shown in the F.6. A number of antennas were used to cover the applicable frequency range test. The ranges in which each antenna was used are as follows:			
	Frequency Range	Antenna		
	9 kHz – 150 kHz	LP-105 Loop		
	150 kHz – 30 MHz	LG-105 Loop		
	30 MHz – 1 GHz	CBL-6111A Bilog		
	1 GHz – 18 GHz	ETS 3115 Horn		
	18 GHz– 26GHz	ETS 3160-09 Horn		
<b>MEASUREMENT EQUIPMENT SETTINGS</b>	The spectrum analyzer was set to the following settings:			
	Frequency Range	RBW	VBW	Detector
	MHz	kHz	kHz	
	0.009 - 0.150	0.200	10	Peak*
	0.150 - 30	9	30	Peak*
	30 – 1000	100	300	Peak*
> 1000	1000*	1000	Peak*	
*As a worst-case measurement, the average/quasi-peak limits were applied to measurements made with a peak detector.				

**F.6. SETUP DRAWING**

Figure F-1 - Setup Drawing

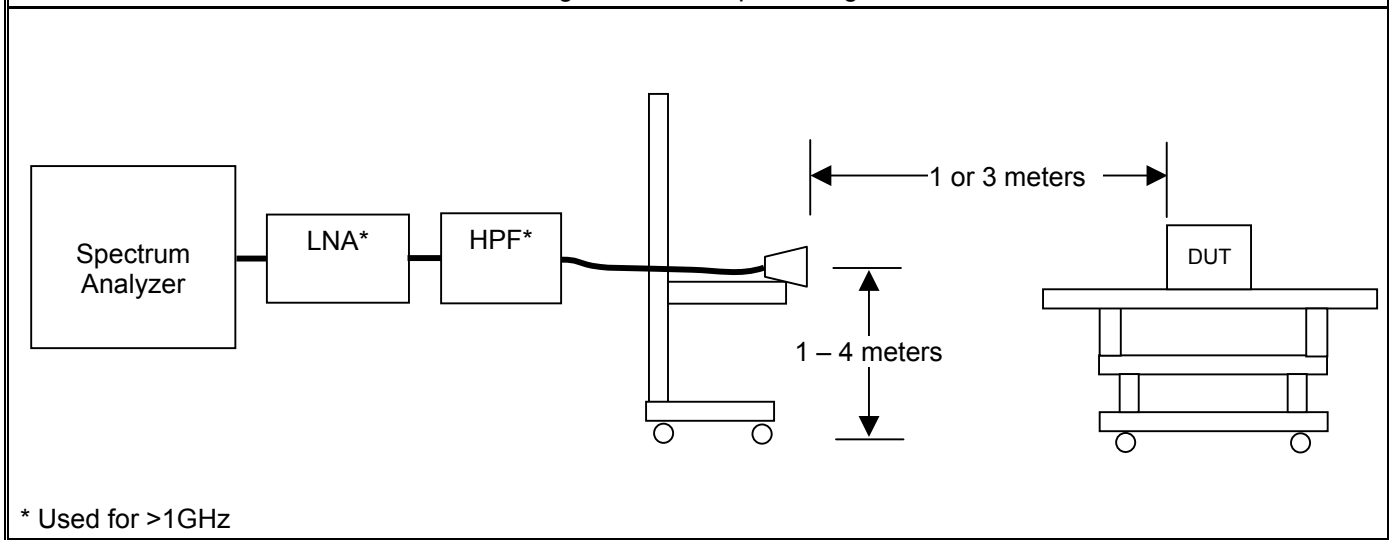

\* Used for >1GHz



<b>Test Report Serial No.:</b>	022305KBC-T618-E15W	Issue 1
<b>Test Date(s):</b>	28Jun04 - 29Jul04, 22Oct04	
<b>Test Type(s):</b>	FCC §15.247	IC RSS-210 Issue 5
<b>Lab Registration(s):</b>	FCC #714830	IC Lab File #3874

### F.7. SETUP PHOTOGRAPHS

Photograph F-1 - Horizontal Polarization (30MHz - 1 GHz)



Photograph F-2 - Vertical Polarization (1-18 GHz)



Photograph F-3 - Front of Radiated Emission Configuration



Photograph F-4 - Back of Radiated Emission Configuration

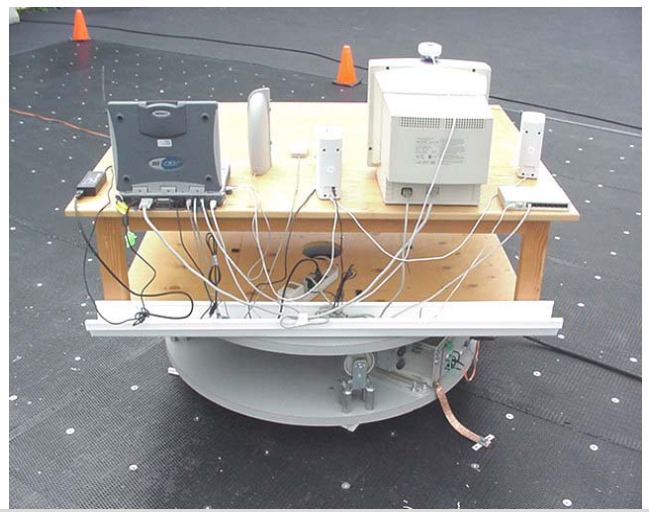

### F.8. DUT OPERATING DESCRIPTION

The worst-case data rate was determined from prescan investigations. Measurements were made at three channels throughout the band, Low Channel (2412 MHz), Mid Channel (2437 MHz), High Channel (2462 MHz) and for both Modes b and g for the band-edge measurements and for Mode b for the remaining measurements.

<b>Applicant:</b>	Itronix Corporation	<b>IC ID:</b>	1943A-IX260Pf	<b>FCC ID:</b>	KBCIX260PROA580BT	
<b>Rugged Laptop PC with Intel Pro 2200BG 802.11b/g WLAN Mini-PCI Card</b>				<b>Model:</b>	IX260PROA580BT	
2005 Celltech Labs Inc. This document is not to be reproduced in whole or in part without the written permission of Celltech Labs Inc.						51 of 77

Test Report Serial No.:	022305KBC-T618-E15W	Issue 1
Test Date(s):	28Jun04 - 29Jul04, 22Oct04	
Test Type(s):	FCC §15.247	IC RSS-210 Issue 5
Lab Registration(s):	FCC #714830	IC Lab File #3874

### F.9. TEST RESULTS

#### F.9.1. Upper Band-edge Emission Field Strengths @ Specified Distance

Note: (Lower Band-edge (Out-of-Band) is in Appendix E)

##### Channel 11 Mode b - Conducted Band-edge Plots

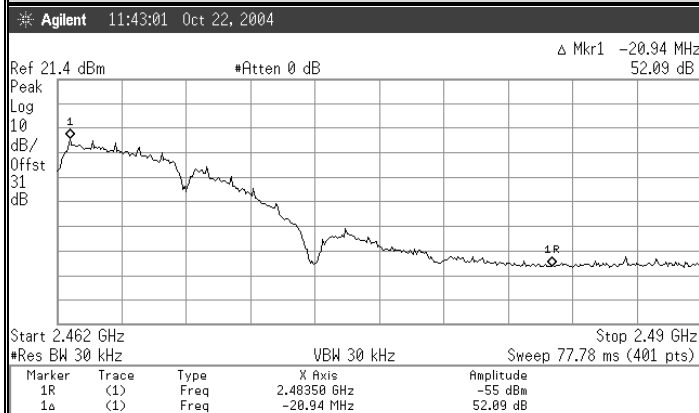

##### Channel 11 Mode g - Conducted Band-edge Plots

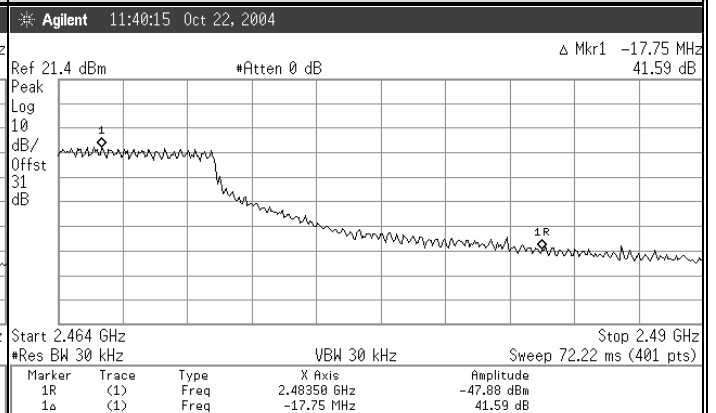

##### Channel 11 Mode b - Radiated Carrier Field Strengths

Channel	Polarity	Distance	Rx Antenna	Frequency	SA Level	Rx AF	Rx CL	Other Rx	Total Rx CF	Field Strength	Detector
		m		MHz	dBuV	dB/m	dB	dB	dB/m	dBuV/m	(PK/QP/AV)
11	H	3	Horn SN6276	2462.00	70.50	28.22	3.52	0.00	31.73	102.23	PK
11	H	3	Horn SN6276	2462.00	65.36	28.22	3.52	0.00	31.73	97.10	AV
11	V	3	Horn SN6276	2462.00	64.90	28.22	3.52	0.00	31.73	96.63	PK
11	V	3	Horn SN6276	2462.00	60.12	28.22	3.52	0.00	31.73	91.85	AV

##### Channel 11 Mode g - Radiated Carrier Field Strengths

Channel	Polarity	Distance	Rx Antenna	Frequency	SA Level	Rx AF	Rx CL	Other Rx	Total Rx CF	Field Strength	Detector
		m		MHz	dBuV	dB/m	dB	dB	dB/m	dBuV/m	(PK/QP/AV)
11	H	3	Horn SN6276	2462.00	72.00	28.22	3.52	0.00	31.73	103.73	PK
11	H	3	Horn SN6276	2462.00	59.80	28.22	3.52	0.00	31.73	91.53	AV
11	V	3	Horn SN6276	2462.00	65.00	28.22	3.52	0.00	31.73	96.73	PK
11	V	3	Horn SN6276	2462.00	54.30	28.22	3.52	0.00	31.73	86.03	AV

##### Channel 11 b - Calculated Band-edge (Restricted) Field Strengths

Channel	Polarity	Distance	Frequency	Carrier Radiated Field Strength	Marker-Delta	Detector	Calculated Band-edge Field Strength	Limit Distance	Limit Distance Correction	Specified Limit	Margin	Pass/Fail
		m	MHz	dBuV/m	dBuV		dBuV/m	m	dB	dBuV/m	dB	
11	H	3	2483.50	102.23	52.09	PK	50.14	3.00	0.00	73.98	23.84	Pass
11	H	3	2483.50	97.10	52.09	AV	45.01	3.00	0.00	53.98	8.97	Pass
11	V	3	2483.50	96.63	52.09	PK	44.54	3.00	0.00	73.98	29.44	Pass
11	V	3	2483.50	91.85	52.09	AV	39.76	3.00	0.00	53.98	14.22	Pass

##### Channel 11 g - Calculated Band-edge (Restricted) Field Strengths

Channel	Polarity	Distance	Frequency	Carrier Radiated Field Strength	Marker-Delta	Detector	Calculated Band-edge Field Strength	Limit Distance	Limit Distance Correction	Specified Limit	Margin	Pass/Fail
		m	MHz	dBuV/m	dBuV		dBuV/m	m	dB	dBuV/m	dB	
11	H	3	2483.50	103.73	41.59	PK	62.14	3.00	0.00	73.98	11.84	Pass
11	H	3	2483.50	91.53	41.59	AV	49.94	3.00	0.00	53.98	4.04	Pass
11	V	3	2483.50	96.73	41.59	PK	55.14	3.00	0.00	73.98	18.84	Pass
11	V	3	2483.50	86.03	41.59	AV	44.44	3.00	0.00	53.98	9.54	Pass

Formulae:

Total CF (dB) = Antenna Factor (dB) + Cable Factor (dB) + Other Factor (Amplifier Gain, Filter Loss, etc) (dB)

Field Strength (dBuV/m) = SA Reading (dBuV) + Total CF (dB/m)

Limit Distance Correction (dB) =  $40 \cdot \log(d1/d2)$  for  $f < 30$  MHz,  $20 \cdot \log(d1/d2)$  for  $f > 30$  MHz, where d1 is the measurement distance and d2 is the published limit

Limit (dBuV/m) = Published Limit (dBuV/m) + Limit Distance Correction (dB)

Margin (dB) = Limit (dBuV/m) - Field Strength (dBuV/m)

Note: Measurements and calculation reference the Marker-Delta Method described in FCC Public Notice DA 00-705

Applicant:	Itronix Corporation	IC ID:	1943A-IX260Pf	FCC ID:	KBCIX260PROA580BT	
Rugged Laptop PC with Intel Pro 2200BG 802.11b/g WLAN Mini-PCI Card				Model:	IX260PROA580BT	
2005 Celltech Labs Inc. This document is not to be reproduced in whole or in part without the written permission of Celltech Labs Inc.						52 of 77



Test Report Serial No.:	022305KBC-T618-E15W	Issue 1
Test Date(s):	28Jun04 - 29Jul04, 22Oct04	
Test Type(s):	FCC §15.247	IC RSS-210 Issue 5
Lab Registration(s):	FCC #714830	IC Lab File #3874

F.9.2. Channel 1 Restricted Band Spurious Emission Field Strengths @ Specified Distance - Horizontal Polarization

Channel	Polarity	Measurement Distance	Antenna	Frequency	SA Level	Noise Floor	Antenna Factor	Cable Factor	Other Factors	Total CF	Field Strength	Detector	Limit Distance	Limit Distance Correction	15.209 (a) Limit	Margin	Pass/Fail
													m	dB	dBuV/m		
1	H	3	Bilog SN1607	167.09	32.00		9.40	0.98	0.00	10.39	42.39	PK	3.00	0.00	63.52	21.14	PASS
1	H	3	Bilog SN1607	208.48	27.30		8.25	1.04	0.00	9.29	36.59	PK	3.00	0.00	63.52	26.93	PASS
1	H	3	Bilog SN1607	245.34	30.00		11.79	1.10	0.00	12.89	42.89	PK	3.00	0.00	66.02	23.14	PASS
1	H	3	Bilog SN1607	787.89	20.30		22.46	1.90	0.00	24.36	44.66	PK	3.00	0.00	66.02	21.36	PASS
1	H	3	Horn SN6276	2390.00	28.40		28.06	3.47	0.00	31.53	59.93	PK	3.00	0.00	73.98	14.05	PASS
1	H	3	Horn SN6276	2390.00	17.00		28.06	3.47	0.00	31.53	48.53	AV	3.00	0.00	53.98	5.45	PASS
1	H	3	Horn SN6276	2500.00	42.60		28.30	3.51	-36.42	-4.61	37.99	PK	3.00	0.00	73.98	35.99	PASS
1	H	3	Horn SN6276	7230.00	38.90	x	35.71	6.27	-35.51	6.47	45.37	PK	3.00	0.00	73.98	28.61	PASS
1	H	3	Horn SN6276	9610.00	37.10		37.59	7.37	-35.71	9.25	46.35	PK	3.00	0.00	73.98	27.63	PASS
1	H	1	3160-09	19296.00	52.98		40.26	11.01	-35.81	15.45	68.43	PK	3.00	9.54	83.52	15.09	PASS
1	H	1	3160-09	19296.00	34.05		40.26	11.01	-35.81	15.45	49.50	AV	3.00	9.54	63.52	14.02	PASS
1	H	1	3160-09	21708.00	53.65		40.30	11.91	-35.73	16.48	70.13	PK	3.00	9.54	83.52	13.39	PASS
1	H	1	3160-09	21708.00	35.74		40.30	11.91	-35.73	16.48	52.22	AV	3.00	9.54	63.52	11.30	PASS
1	H	1	3160-09	24120.00	56.09		40.40	12.81	-35.73	17.48	73.57	PK	3.00	9.54	83.52	9.95	PASS
1	H	1	3160-09	24120.00	37.57		40.40	12.81	-35.73	17.48	55.05	AV	3.00	9.54	63.52	8.47	PASS
1	H	1	3160-09	24490.00	57.15		40.40	12.95	-35.73	17.62	74.77	PK	3.00	9.54	83.52	8.75	PASS
1	H	1	3160-09	24490.00	38.00		40.40	12.95	-35.73	17.62	55.62	AV	3.00	9.54	63.52	7.90	PASS

Formulae:

Total CF = Antenna Factor + Cable Factor + Other Factor (Amplifier Gain, filter loss, etc)  
 Field Strength = SA Reading + Total CF  
 Limit Distance Correction =  $40 \cdot \log(d1/d2)$  for  $F < 30$  MHz,  $20 \cdot \log(d1/d2)$  for  $F > 30$  MHz:  
 where d1 is the measurement distance, d2 is the published limit distance  
 Limit = Specified Limit + Limit Distance Correction  
 Margin = Limit - Field Strength

\*The frequency points reported describe the highest emission measured in each of the ranges tested and are used to describe the measured spectrum as a whole. It is shown that the highest emissions measured within the spectrum pass the appropriate restricted limits; therefore all emissions within the restricted bands would also meet the requirements. No out-of-band emissions were measured above the levels noted.

Applicant:	Itronix Corporation	IC ID:	1943A-IX260Pf	FCC ID:	KBCIX260PROA580BT	
Rugged Laptop PC with Intel Pro 2200BG 802.11b/g WLAN Mini-PCI Card				Model:	IX260PROA580BT	
2005 Celltech Labs Inc. This document is not to be reproduced in whole or in part without the written permission of Celltech Labs Inc.						53 of 77

Test Report Serial No.:	022305KBC-T618-E15W	Issue 1
Test Date(s):	28Jun04 - 29Jul04, 22Oct04	
Test Type(s):	FCC §15.247	IC RSS-210 Issue 5
Lab Registration(s):	FCC #714830	IC Lab File #3874

F.9.3. Channel 1 Restricted Band Spurious Emission Field Strengths @ Specified Distance - Vertical Polarization

Channel	Polarity	Measurement Distance	Antenna	Frequency	SA Level	Noise Floor	Antenna Factor	Cable Factor	Other Factors	Total CF	Field Strength	Detector	Limit Distance	Limit Distance Correction	15.209 (a) Limit	Margin	Pass/Fail
													m	dB	dBuV/m		
1	V	3	LG-105	1.50	9.04		53.10	0.15	0.00	53.25	62.29	PK	30.00	40.00	84.80	22.51	PASS
1	V	3	LG-105	2.62	7.21		50.69	0.20	0.00	50.89	58.10	PK	30.00	40.00	89.54	31.44	PASS
1	V	3	LG-105	5.48	11.74		44.38	0.31	0.00	44.68	56.42	PK	30.00	40.00	89.54	33.12	PASS
1	V	3	LG-105	27.15	10.24		40.62	0.68	0.00	41.30	51.54	PK	30.00	40.00	89.54	38.00	PASS
1	V	3	Bilog SN1607	99.52	29.60		9.90	0.84	0.00	10.75	40.35	PK	3.00	0.00	63.52	23.17	PASS
1	V	3	Horn SN6276	2390.00	28.40		28.06	3.47	0.00	31.53	59.93	PK	3.00	0.00	73.98	14.05	PASS
1	V	3	Horn SN6276	2390.00	17.00		28.06	3.47	0.00	31.53	48.53	AV	3.00	0.00	53.98	5.45	PASS
1	V	3	Horn SN6276	3200.00	43.50		30.48	4.04	-35.93	-1.40	42.10	PK	3.00	0.00	73.98	31.88	PASS
1	V	3	Horn SN6276	4810.00	47.00		32.88	4.96	-35.30	2.54	49.54	PK	3.00	0.00	73.98	24.44	PASS
1	V	3	Horn SN6276	5260.00	40.10		33.72	5.23	-35.34	3.61	43.71	PK	3.00	0.00	73.98	30.27	PASS
1	V	3	Horn SN6276	5720.00	41.60		34.19	5.44	-35.38	4.25	45.85	PK	3.00	0.00	73.98	28.13	PASS
1	V	3	Horn SN6276	5770.00	44.80		34.21	5.45	-35.38	4.28	49.08	PK	3.00	0.00	73.98	24.90	PASS
1	V	3	Horn SN6276	7520.00	40.40		36.32	6.43	-35.53	7.21	47.61	PK	3.00	0.00	73.98	26.37	PASS
1	V	3	Horn SN6276	8360.00	37.60		37.06	6.79	-35.60	8.25	45.85	PK	3.00	0.00	73.98	28.13	PASS
1	V	3	Horn SN6276	9610.00	36.60		37.59	7.37	-35.71	9.25	45.85	PK	3.00	0.00	73.98	28.13	PASS
1	V	3	Horn SN6276	12640.00	36.90		38.71	8.68	-36.79	10.59	47.49	PK	3.00	0.00	73.98	26.49	PASS
1	V	3	Horn SN6276	15740.00	38.20		37.56	9.77	-36.53	10.80	49.00	PK	3.00	0.00	73.98	24.98	PASS

Formulae:

Total CF = Antenna Factor + Cable Factor + Other Factor (Amplifier Gain, filter loss, etc)

Field Strength = SA Reading + Total CF

Limit Distance Correction =  $40 \cdot \log(d1/d2)$  for  $F < 30$  MHz,  $20 \cdot \log(d1/d2)$  for  $F > 30$  MHz:

where d1 is the measurement distance, d2 is the published limit distance

Limit = Specified Limit + Limit Distance Correction

Margin = Limit - Field Strength

**\*The frequency points reported describe the highest emission measured in each of the ranges tested and are used to describe the measured spectrum as a whole. It is shown that the highest emissions measured within the spectrum pass the appropriate restricted limits; therefore all emissions within the restricted bands would also meet the requirements. No out-of-band emissions were measured above the levels noted.**

Continued

Applicant:	Itronix Corporation	IC ID:	1943A-IX260Pf	FCC ID:	KBCIX260PROA580BT	
Rugged Laptop PC with Intel Pro 2200BG 802.11b/g WLAN Mini-PCI Card				Model:	IX260PROA580BT	
2005 Celltech Labs Inc. This document is not to be reproduced in whole or in part without the written permission of Celltech Labs Inc.						54 of 77

<b>Test Report Serial No.:</b>	022305KBC-T618-E15W	Issue 1
<b>Test Date(s):</b>	28Jun04 - 29Jul04, 22Oct04	
<b>Test Type(s):</b>	FCC §15.247	IC RSS-210 Issue 5
<b>Lab Registration(s):</b>	FCC #714830	IC Lab File #3874

Continued

Channel	Polarity	Measurement Distance	Antenna	Frequency	SA Level	Noise Floor	Antenna Factor	Cable Factor	Other Factors	Total CF	Field Strength	Detector	Limit Distance	Limit Distance Correction	15.209 (a) Limit	Margin	Pass/Fail
													m	dB	dBuV/m		
1	V	1	3160-09	18820.00	53.92		40.20	11.05	-35.87	15.38	69.30	PK	3.00	9.54	83.52	14.22	PASS
1	V	1	3160-09	18820.00	33.66		40.20	11.05	-35.87	15.38	49.04	AV	3.00	9.54	63.52	14.48	PASS
1	V	1	3160-09	19296.00	52.65		40.26	11.01	-35.81	15.45	68.10	PK	3.00	9.54	83.52	15.42	PASS
1	V	1	3160-09	19296.00	33.76		40.26	11.01	-35.81	15.45	49.21	AV	3.00	9.54	63.52	14.31	PASS
1	V	1	3160-09	21708.00	53.27		40.30	11.91	-35.73	16.48	69.75	PK	3.00	9.54	83.52	13.77	PASS
1	V	1	3160-09	21708.00	36.04		40.30	11.91	-35.73	16.48	52.52	AV	3.00	9.54	63.52	11.00	PASS
1	V	1	3160-09	24120.00	56.03		40.40	12.81	-35.73	17.48	73.51	PK	3.00	9.54	83.52	10.01	PASS
1	V	1	3160-09	24120.00	37.21		40.40	12.81	-35.73	17.48	54.69	AV	3.00	9.54	63.52	8.83	PASS
1	V	1	3160-09	24550.00	56.31		40.40	12.97	-35.73	17.64	73.95	PK	3.00	9.54	83.52	9.57	PASS
1	V	1	3160-09	24550.00	38.30		40.40	12.97	-35.73	17.64	55.94	AV	3.00	9.54	63.52	7.58	PASS

**Formulae:**

Total CF = Antenna Factor + Cable Factor + Other Factor (Amplifier Gain, filter loss, etc)

Field Strength = SA Reading + Total CF

Limit Distance Correction =  $40 \cdot \log(d1/d2)$  for  $F < 30$  MHz,  $20 \cdot \log(d1/d2)$  for  $F > 30$  MHz:

where d1 is the measurement distance, d2 is the published limit distance

Limit = Specified Limit + Limit Distance Correction

Margin = Limit - Field Strength

**\*The frequency points reported describe the highest emission measured in each of the ranges tested and are used to describe the measured spectrum as a whole. It is shown that the highest emissions measured within the spectrum pass the appropriate restricted limits; therefore all emissions within the restricted bands would also meet the requirements. No out-of-band emissions were measured above the levels noted.**

<b>Applicant:</b>	Itronix Corporation	<b>IC ID:</b>	1943A-IX260Pf	<b>FCC ID:</b>	KBCIX260PROA580BT	
<b>Rugged Laptop PC with Intel Pro 2200BG 802.11b/g WLAN Mini-PCI Card</b>				<b>Model:</b>	IX260PROA580BT	
2005 Celltech Labs Inc. This document is not to be reproduced in whole or in part without the written permission of Celltech Labs Inc.						55 of 77

Test Report Serial No.:	022305KBC-T618-E15W	Issue 1
Test Date(s):	28Jun04 - 29Jul04, 22Oct04	
Test Type(s):	FCC §15.247	IC RSS-210 Issue 5
Lab Registration(s):	FCC #714830	IC Lab File #3874

F.9.4. Channel 6 Restricted Band Spurious Emission Field Strengths @ Specified Distance - Horizontal Polarization

Channel	Polarity	Measurement Distance	Antenna	Frequency	SA Level	Noise Floor	Antenna Factor	Cable Factor	Other Factors	Total CF	Field Strength	Detector	Limit Distance	Limit Distance Correction	15.209 (a) Limit	Margin	Pass/Fail
6	H	3	Bilog SN1607	60.70	29.20		5.03	0.56	0.00	5.59	34.79	PK	3.00	0.00	60.00	25.21	PASS
6	H	3	Bilog SN1607	208.48	29.70		8.25	1.04	0.00	9.29	38.99	PK	3.00	0.00	63.52	24.53	PASS
6	H	3	Horn SN6276	2750.00	38.60		29.15	3.69	-36.38	-3.53	35.07	PK	3.00	0.00	73.98	38.91	PASS
6	H	3	Horn SN6276	3240.00	37.00		30.58	4.06	-36.12	-1.48	35.52	PK	3.00	0.00	73.98	38.46	PASS
6	H	3	Horn SN6276	4860.00	36.70		32.99	5.02	-35.46	2.55	39.25	PK	3.00	0.00	73.98	34.73	PASS
6	H	3	Horn SN6276	5260.00	45.20		33.72	5.23	-35.47	3.47	48.67	PK	3.00	0.00	73.98	25.31	PASS
6	H	3	Horn SN6276	5770.00	37.20		34.21	5.45	-35.50	4.16	41.36	PK	3.00	0.00	73.98	32.61	PASS
6	H	3	Horn SN6276	8280.00	38.40		36.98	6.75	-35.61	8.11	46.51	PK	3.00	0.00	73.98	27.47	PASS
6	H	3	Horn SN6276	8360.00	42.30		37.06	6.79	-35.62	8.24	50.54	PK	3.00	0.00	73.98	23.44	PASS
6	H	1	3160-09	19496.00	52.56		40.30	11.28	-35.79	15.79	68.35	PK	3.00	9.54	83.52	15.17	PASS
6	H	1	3160-09	19496.00	33.91		40.30	11.28	-35.79	15.79	49.70	AV	3.00	9.54	63.52	13.82	PASS
6	H	1	3160-09	21240.00	54.98		40.30	11.73	-35.73	16.31	71.29	PK	3.00	9.54	83.52	12.23	PASS
6	H	1	3160-09	21240.00	35.72		40.30	11.73	-35.73	16.31	52.03	AV	3.00	9.54	63.52	11.49	PASS
6	H	1	3160-09	21933.00	54.66		40.30	11.99	-35.73	16.57	71.23	PK	3.00	9.54	83.52	12.30	PASS
6	H	1	3160-09	21933.00	36.27		40.30	11.99	-35.73	16.57	52.84	AV	3.00	9.54	63.52	10.69	PASS
6	H	1	3160-09	24370.00	57.10		40.40	12.90	-35.73	17.58	74.68	PK	3.00	9.54	83.52	8.84	PASS
6	H	1	3160-09	24370.00	37.88		40.40	12.90	-35.73	17.58	55.46	AV	3.00	9.54	63.52	8.06	PASS
6	H	1	3160-09	24420.00	56.93		40.40	12.92	-35.73	17.60	74.53	PK	3.00	9.54	83.52	9.00	PASS
6	H	1	3160-09	24420.00	37.73		40.40	12.92	-35.73	17.60	55.33	AV	3.00	9.54	63.52	8.20	PASS

Formulae:

Total CF = Antenna Factor + Cable Factor + Other Factor (Amplifier Gain, filter loss, etc)

Field Strength = SA Reading + Total CF

Limit Distance Correction =  $40 \cdot \log(d1/d2)$  for  $F < 30$  MHz,  $20 \cdot \log(d1/d2)$  for  $F > 30$  MHz:

where d1 is the measurement distance, d2 is the published limit distance

Limit = Specified Limit + Limit Distance Correction

Margin = Limit - Field Strength

**\*The frequency points reported describe the highest emission measured in each of the ranges tested and are used to describe the measured spectrum as a whole. It is shown that the highest emissions measured within the spectrum pass the appropriate restricted limits; therefore all emissions within the restricted bands would also meet the requirements. No out-of-band emissions were measured above the levels noted.**

Applicant:	Itronix Corporation	IC ID:	1943A-IX260Pf	FCC ID:	KBCIX260PROA580BT	
Rugged Laptop PC with Intel Pro 2200BG 802.11b/g WLAN Mini-PCI Card				Model:	IX260PROA580BT	
2005 Celltech Labs Inc. This document is not to be reproduced in whole or in part without the written permission of Celltech Labs Inc.						56 of 77

Test Report Serial No.:	022305KBC-T618-E15W	Issue 1
Test Date(s):	28Jun04 - 29Jul04, 22Oct04	
Test Type(s):	FCC §15.247	IC RSS-210 Issue 5
Lab Registration(s):	FCC #714830	IC Lab File #3874

F.9.5. Channel 6 Restricted Band Spurious Emission Field Strengths @ Specified Distance - Vertical Polarization

Channel	Polarity	Measurement Distance	Antenna	Frequency	SA Level	Noise Floor	Antenna Factor	Cable Factor	Other Factors	Total CF	Field Strength	Detector	Limit Distance	Limit Distance Correction	15.209 (a) Limit	Margin	Pass/Fail
													m	dB	dBuV/m		
6	V	3	LP-105	0.08	17.57		48.71	0.05	0.00	48.76	66.33	PK	300.00	80.00	143.55	77.22	PASS
6	V	3	LG-105	2.03	9.04		52.21	0.17	0.00	52.39	61.43	PK	30.00	40.00	89.54	28.11	PASS
6	V	3	LG-105	0.83	2.38		57.38	0.11	0.00	57.49	59.87	PK	30.00	40.00	90.77	30.90	PASS
6	V	3	LG-105	1.50	8.52		53.11	0.15	0.00	53.26	61.78	PK	30.00	40.00	84.82	23.04	PASS
6	V	3	LG-105	3.22	8.34		49.31	0.23	0.00	49.54	57.88	PK	30.00	40.00	89.54	31.66	PASS
6	V	3	LG-105	5.63	12.44		44.09	0.31	0.00	44.40	56.84	PK	30.00	40.00	89.54	32.70	PASS
6	V	3	LG-105	17.80	9.89		41.04	0.55	0.00	41.59	51.48	PK	30.00	40.00	89.54	38.06	PASS
6	V	3	Bilog SN1607	57.48	30.80		5.53	0.53	0.00	6.06	36.86	PK	3.00	0.00	60.00	23.14	PASS
6	V	3	Bilog SN1607	99.52	28.50		9.90	0.84	0.00	10.75	39.25	PK	3.00	0.00	63.52	24.27	PASS
6	V	3	Bilog SN1607	103.72	27.90		10.33	0.88	0.00	11.21	39.11	PK	3.00	0.00	63.52	24.41	PASS
6	V	3	Bilog SN1607	166.77	24.50		9.43	0.98	0.00	10.41	34.91	PK	3.00	0.00	63.52	28.61	PASS
6	V	3	Bilog SN1607	196.19	31.70		8.47	1.03	0.00	9.49	41.19	PK	3.00	0.00	63.52	22.33	PASS
6	V	3	Bilog SN1607	196.52	29.70		8.44	1.03	0.00	9.47	39.17	PK	3.00	0.00	63.52	24.35	PASS
6	V	3	Bilog SN1607	246.96	28.50		11.97	1.10	0.00	13.07	41.57	PK	3.00	0.00	66.02	24.46	PASS
6	V	3	Bilog SN1607	306.45	27.50		13.40	1.19	0.00	14.58	42.08	PK	3.00	0.00	66.02	23.94	PASS
6	V	3	Horn SN6276	2830.00	37.90		29.42	3.75	-36.33	-3.16	34.74	PK	3.00	0.00	73.98	39.24	PASS
6	V	3	Horn SN6276	5240.00	37.30		33.68	5.22	-35.47	3.43	40.73	PK	3.00	0.00	73.98	33.24	PASS
6	V	3	Horn SN6276	5770.00	40.10		34.21	5.45	-35.50	4.16	44.26	PK	3.00	0.00	73.98	29.71	PASS
6	V	3	Horn SN6276	7520.00	37.80		36.32	6.43	-35.58	7.17	44.97	PK	3.00	0.00	73.98	29.01	PASS

Formulae:

Total CF = Antenna Factor + Cable Factor + Other Factor (Amplifier Gain, filter loss, etc)

Field Strength = SA Reading + Total CF

Limit Distance Correction = 40\*log(d1/d2) for F<30 MHz, 20\*log(d1/d2) for F> 30 MHz:

where d1 is the measurement distance, d2 is the published limit distance

Limit = Specified Limit + Limit Distance Correction

Margin = Limit - Field Strength

**\*The frequency points reported describe the highest emission measured in each of the ranges tested and are used to describe the measured spectrum as a whole. It is shown that the highest emissions measured within the spectrum pass the appropriate restricted limits; therefore all emissions within the restricted bands would also meet the requirements. No out-of-band emissions were measured above the levels noted.**

Continued

Applicant:	Itronix Corporation	IC ID:	1943A-IX260Pf	FCC ID:	KBCIX260PROA580BT	
Rugged Laptop PC with Intel Pro 2200BG 802.11b/g WLAN Mini-PCI Card				Model:	IX260PROA580BT	
2005 Celltech Labs Inc. This document is not to be reproduced in whole or in part without the written permission of Celltech Labs Inc.						57 of 77

<b>Test Report Serial No.:</b>	022305KBC-T618-E15W	Issue 1
<b>Test Date(s):</b>	28Jun04 - 29Jul04, 22Oct04	
<b>Test Type(s):</b>	FCC §15.247	IC RSS-210 Issue 5
<b>Lab Registration(s):</b>	FCC #714830	IC Lab File #3874

Continued

Channel	Polarity	Measurement Distance	Antenna	Frequency	SA Level	Noise Floor	Antenna Factor	Cable Factor	Other Factors	Total CF	Field Strength	Detector	Limit Distance	Limit Distance Correction	15.209 (a) Limit	Margin	Pass/Fail
													m	dB	dBuV/m		
6	V	3	Horn SN6276	9720.00	36.80		37.68	7.34	-35.71	9.31	46.11	PK	3.00	0.00	73.98	27.87	PASS
6	V	3	Horn SN6276	16480.00	38.30		38.45	10.25	-36.16	12.54	50.84	PK	3.00	0.00	73.98	23.14	PASS
6	V	1	3160-09	19190.00	54.26		40.24	10.91	-35.83	15.32	69.58	PK	3.00	9.54	83.52	13.94	PASS
6	V	1	3160-09	19190.00	33.78		40.24	10.91	-35.83	15.32	49.10	AV	3.00	9.54	63.52	14.42	PASS
6	V	1	3160-09	19496.00	52.89		40.30	11.28	-35.79	15.79	68.68	PK	3.00	9.54	83.52	14.84	PASS
6	V	1	3160-09	19496.00	33.88		40.30	11.28	-35.79	15.79	49.67	AV	3.00	9.54	63.52	13.85	PASS
6	V	1	3160-09	21933.00	53.99		40.30	11.99	-35.73	16.57	70.56	PK	3.00	9.54	83.52	12.97	PASS
6	V	1	3160-09	21933.00	36.23		40.30	11.99	-35.73	16.57	52.80	AV	3.00	9.54	63.52	10.73	PASS
6	V	1	3160-09	24370.00	55.56		40.40	12.90	-35.73	17.58	73.14	PK	3.00	9.54	83.52	10.38	PASS
6	V	1	3160-09	24370.00	37.88		40.40	12.90	-35.73	17.58	55.46	AV	3.00	9.54	63.52	8.06	PASS
6	V	1	3160-09	24400.00	56.66		40.40	12.91	-35.73	17.59	74.25	PK	3.00	9.54	83.52	9.27	PASS
6	V	1	3160-09	24400.00	37.87		40.40	12.91	-35.73	17.59	55.46	AV	3.00	9.54	63.52	8.06	PASS

**Formulae:**

Total CF = Antenna Factor + Cable Factor + Other Factor (Amplifier Gain, filter loss, etc)

Field Strength = SA Reading + Total CF

Limit Distance Correction = 40\*log(d1/d2) for F<30 MHz, 20\*log(d1/d2) for F> 30 MHz:

where d1 is the measurement distance, d2 is the published limit distance

Limit = Specified Limit + Limit Distance Correction

Margin = Limit - Field Strength

**\*The frequency points reported describe the highest emission measured in each of the ranges tested and are used to describe the measured spectrum as a whole. It is shown that the highest emissions measured within the spectrum pass the appropriate restricted limits; therefore all emissions within the restricted bands would also meet the requirements. No out-of-band emissions were measured above the levels noted.**

<b>Applicant:</b>	Itronix Corporation	<b>IC ID:</b>	1943A-IX260Pf	<b>FCC ID:</b>	KBCIX260PROA580BT	
<b>Rugged Laptop PC with Intel Pro 2200BG 802.11b/g WLAN Mini-PCI Card</b>				<b>Model:</b>	IX260PROA580BT	
2005 Celltech Labs Inc. This document is not to be reproduced in whole or in part without the written permission of Celltech Labs Inc.						58 of 77

Test Report Serial No.:	022305KBC-T618-E15W	Issue 1
Test Date(s):	28Jun04 - 29Jul04, 22Oct04	
Test Type(s):	FCC §15.247	IC RSS-210 Issue 5
Lab Registration(s):	FCC #714830	IC Lab File #3874

F.9.6. Channel 11 Restricted Band Spurious Emission Field Strengths @ Specified Distance - Horizontal Polarization

Channel	Polarity	Measurement Distance	Antenna	Frequency	SA Level	Noise Floor	Antenna Factor	Cable Factor	Other Factors	Total CF	Field Strength	Detector	Limit Distance	Limit Distance Correction	15.209 (a) Limit	Margin	Pass/Fail
													m	dB	dBuV/m		
11	H	3	Bilog SN1607	141.55	31.30		11.07	0.95	0.00	12.01	43.31	PK	3.00	0.00	63.52	20.21	PASS
11	H	3	Bilog SN1607	208.80	31.20		8.28	1.04	0.00	9.32	40.52	PK	3.00	0.00	63.52	23.00	PASS
11	H	3	Bilog SN1607	297.72	29.20		13.28	1.17	0.00	14.45	43.65	PK	3.00	0.00	66.02	22.37	PASS
11	H	3	Horn SN6276	2810.00	37.50		29.35	3.74	-36.34	-3.25	34.25	PK	3.00	0.00	73.98	39.73	PASS
11	H	3	Horn SN6276	4900.00	39.50		33.08	5.05	-35.46	2.68	42.18	PK	3.00	0.00	73.98	31.80	PASS
11	H	3	Horn SN6276	5260.00	45.80		33.72	5.23	-35.47	3.47	49.27	PK	3.00	0.00	73.98	24.71	PASS
11	H	3	Horn SN6276	8280.00	39.30		36.98	6.75	-35.61	8.11	47.41	PK	3.00	0.00	73.98	26.57	PASS
11	H	3	Horn SN6276	8360.00	42.10		37.06	6.79	-35.62	8.24	50.34	PK	3.00	0.00	73.98	23.64	PASS
11	H	3	Horn SN6276	9820.00	39.00		37.76	7.44	-35.77	9.42	48.42	PK	3.00	0.00	73.98	25.56	PASS
11	H	3	Horn SN6276	15920.00	38.90		37.38	9.83	-36.23	10.98	49.88	PK	3.00	0.00	73.98	24.10	PASS
11	H	1	3160-09	18810.00	53.72		40.20	11.15	-35.87	15.48	69.20	PK	3.00	9.54	83.52	14.33	PASS
11	H	1	3160-09	18810.00	33.94		40.20	11.15	-35.87	15.48	49.42	AV	3.00	9.54	63.52	14.11	PASS
11	H	1	3160-09	19696.00	53.67		40.30	11.42	-35.76	15.95	69.62	PK	3.00	9.54	83.52	13.90	PASS
11	H	1	3160-09	19696.00	33.44		40.30	11.42	-35.76	15.95	49.39	AV	3.00	9.54	63.52	14.13	PASS
11	H	1	3160-09	22158.00	53.69		40.33	12.08	-35.73	16.68	70.37	PK	3.00	9.54	83.52	13.15	PASS
11	H	1	3160-09	22158.00	35.90		40.33	12.08	-35.73	16.68	52.58	AV	3.00	9.54	63.52	10.94	PASS
11	H	1	3160-09	24460.00	56.88		40.40	12.94	-35.73	17.61	74.49	PK	3.00	9.54	83.52	9.03	PASS
11	H	1	3160-09	24460.00	37.32		40.40	12.94	-35.73	17.61	54.93	AV	3.00	9.54	63.52	8.59	PASS
11	H	1	3160-09	24620.00	55.75		40.40	13.00	-35.73	17.67	73.42	PK	3.00	9.54	83.52	10.10	PASS
11	H	1	3160-09	24620.00	37.57		40.40	13.00	-35.73	17.67	55.24	AV	3.00	9.54	63.52	8.28	PASS

Formulae:

Total CF = Antenna Factor + Cable Factor + Other Factor (Amplifier Gain, filter loss, etc)

Field Strength = SA Reading + Total CF

Limit Distance Correction = 40\*log(d1/d2) for F<30 MHz, 20\*log(d1/d2) for F> 30 MHz:

where d1 is the measurement distance, d2 is the published limit distance

Limit = Specified Limit + Limit Distance Correction

Margin = Limit - Field Strength

**\*The frequency points reported describe the highest emission measured in each of the ranges tested and are used to describe the measured spectrum as a whole. It is shown that the highest emissions measured within the spectrum pass the appropriate restricted limits; therefore all emissions within the restricted bands would also meet the requirements. No out-of-band emissions were measured above the levels noted.**

Applicant:	Itronix Corporation	IC ID:	1943A-IX260Pf	FCC ID:	KBCIX260PROA580BT	
Rugged Laptop PC with Intel Pro 2200BG 802.11b/g WLAN Mini-PCI Card				Model:	IX260PROA580BT	
2005 Celltech Labs Inc. This document is not to be reproduced in whole or in part without the written permission of Celltech Labs Inc.						59 of 77



F.9.7. Channel 11 Restricted Band Spurious Emission Field Strengths @ Specified Distance - Vertical Polarization

Channel	Polarity	Measurement Distance	Antenna	Frequency	SA Level	Noise Floor	Antenna Factor	Cable Factor	Other Factors	Total CF	Field Strength	Detector	Limit Distance	Limit Distance Correction	15.209 (a) Limit	Margin	Pass/Fail
													m	dB	dBuV/m		
11	V	3	LP-105	0.08	19.50		48.79	0.04	0.00	48.83	68.33	PK	300.00	80.00	143.60	75.27	PASS
11	V	3	LG-105	0.20	1.04		59.88	0.07	0.00	59.95	60.99	PK	300.00	80.00	134.59	73.60	PASS
11	V	3	LG-105	0.79	1.46		57.46	0.12	0.00	57.57	59.03	PK	30.00	40.00	91.16	32.13	PASS
11	V	3	LG-105	1.44	8.37		53.25	0.15	0.00	53.40	61.77	PK	30.00	40.00	85.34	23.57	PASS
11	V	3	LG-105	4.05	10.60		47.10	0.26	0.00	47.36	57.96	PK	30.00	40.00	89.54	31.58	PASS
11	V	3	LG-105	5.26	10.77		44.79	0.30	0.00	45.09	55.86	PK	30.00	40.00	89.54	33.68	PASS
11	V	3	LG-105	13.95	9.95		40.60	0.50	0.00	41.09	51.04	PK	30.00	40.00	89.54	38.50	PASS
11	V	3	Horn SN6276	2810.00	37.20		29.35	3.74	-36.34	-3.25	33.95	PK	3.00	0.00	73.98	40.03	PASS
11	V	3	Horn SN6276	5270.00	36.40		33.73	5.24	-35.47	3.49	39.89	PK	3.00	0.00	73.98	34.09	PASS
11	V	3	Horn SN6276	5770.00	42.50		34.21	5.45	-35.50	4.16	46.66	PK	3.00	0.00	73.98	27.31	PASS
11	V	3	Horn SN6276	9820.00	36.60		37.76	7.44	-35.77	9.42	46.02	PK	3.00	0.00	73.98	27.96	PASS
11	V	3	Horn SN6276	16680.00	39.00		39.29	10.24	-36.14	13.40	52.40	PK	3.00	0.00	73.98	21.58	PASS
11	V	1	3160-09	19696.00	53.07		40.30	11.42	-35.76	15.95	69.02	PK	3.00	9.54	83.52	14.50	PASS
11	V	1	3160-09	19696.00	33.28		40.30	11.42	-35.76	15.95	49.23	AV	3.00	9.54	63.52	14.29	PASS
11	V	1	3160-09	20660.00	55.02		40.30	11.74	-35.73	16.31	71.33	PK	3.00	9.54	83.52	12.19	PASS
11	V	1	3160-09	20660.00	35.18		40.30	11.74	-35.73	16.31	51.49	AV	3.00	9.54	63.52	12.03	PASS

Formulae:

Total CF = Antenna Factor + Cable Factor + Other Factor (Amplifier Gain, filter loss, etc)

Field Strength = SA Reading + Total CF

Limit Distance Correction = 40\*log(d1/d2) for F<30 MHz, 20\*log(d1/d2) for F> 30 MHz:

where d1 is the measurement distance, d2 is the published limit distance

Limit = Specified Limit + Limit Distance Correction

Margin = Limit - Field Strength

\*The frequency points reported describe the highest emission measured in each of the ranges tested and are used to describe the measured spectrum as a whole. It is shown that the highest emissions measured within the spectrum pass the appropriate restricted limits; therefore all emissions within the restricted bands would also meet the requirements. No out-of-band emissions were measured above the levels noted.

Continued



Test Report Serial No.:	022305KBC-T618-E15W	Issue 1
Test Date(s):	28Jun04 - 29Jul04, 22Oct04	
Test Type(s):	FCC §15.247	IC RSS-210 Issue 5
Lab Registration(s):	FCC #714830	IC Lab File #3874

Continued

Channel	Polarity	Measurement Distance	Antenna	Frequency	SA Level	Noise Floor	Antenna Factor	Cable Factor	Other Factors	Total CF	Field Strength	Detector	Limit Distance	Limit Distance Correction	15.209 (a) Limit	Margin	Pass/Fail
													m	dB	dBuV/m		
11	V	1	3160-09	22158.00	54.12		40.33	12.08	-35.73	16.68	70.80	PK	3.00	9.54	83.52	12.72	PASS
11	V	1	3160-09	22158.00	33.80		40.33	12.08	-35.73	16.68	50.48	AV	3.00	9.54	63.52	13.04	PASS
11	V	1	3160-09	23950.00	57.28		40.40	12.75	-35.73	17.42	74.70	PK	3.00	9.54	83.52	8.82	PASS
11	V	1	3160-09	23950.00	36.43		40.40	12.75	-35.73	17.42	53.85	AV	3.00	9.54	63.52	9.67	PASS
11	V	1	3160-09	24620.00	55.73		40.40	13.00	-35.73	17.67	73.40	PK	3.00	9.54	83.52	10.12	PASS
11	V	1	3160-09	24620.00	37.92		40.40	13.00	-35.73	17.67	55.59	AV	3.00	9.54	63.52	7.93	PASS

**Formulae:**

Total CF = Antenna Factor + Cable Factor + Other Factor (Amplifier Gain, filter loss, etc)

Field Strength = SA Reading + Total CF

Limit Distance Correction =  $40 \cdot \log(d1/d2)$  for  $F < 30$  MHz,  $20 \cdot \log(d1/d2)$  for  $F > 30$  MHz:  
 where d1 is the measurement distance, d2 is the published limit distance

Limit = Specified Limit + Limit Distance Correction

Margin = Limit - Field Strength

**\*The frequency points reported describe the highest emission measured in each of the ranges tested and are used to describe the measured spectrum as a whole. It is shown that the highest emissions measured within the spectrum pass the appropriate restricted limits; therefore all emissions within the restricted bands would also meet the requirements. No out-of-band emissions were measured above the levels noted.**

**F.10. PASS/FAIL**

In reference to the results outlined in F.9, the DUT passes the requirements as stated in the reference standards as follows: FCC 15.205 (a) (b) and 15.209 (a): No emissions were measured within the restricted bands as outlined in 15.205 that exceeded the limits stated in 15.209.

**F.11. SIGN-OFF**

I attest to the accuracy of the data. All measurements reported herein were performed by me and are correct to the best of my knowledge and belief. I assume full responsibility for the completeness of these measurements.



Russell Pipe  
 Senior Compliance Technologist  
 Celltech Labs Inc.

22Oct04  
 Date

Applicant:	Itronix Corporation	IC ID:	1943A-IX260Pf	FCC ID:	KBCIX260PROA580BT	
Rugged Laptop PC with Intel Pro 2200BG 802.11b/g WLAN Mini-PCI Card				Model:	IX260PROA580BT	
2005 Celltech Labs Inc. This document is not to be reproduced in whole or in part without the written permission of Celltech Labs Inc.						61 of 77

<b>Test Report Serial No.:</b>	022305KBC-T618-E15W	Issue 1
<b>Test Date(s):</b>	28Jun04 - 29Jul04, 22Oct04	
<b>Test Type(s):</b>	FCC §15.247	IC RSS-210 Issue 5
<b>Lab Registration(s):</b>	FCC #714830	IC Lab File #3874

### Appendix G - Peak Power Spectral Density Measurement

G.1. REFERENCES	
<b>Normative Reference Standard</b>	FCC CFR 47 §15.247(d)
<b>Procedure Reference</b>	FCC 97-114

G.2. LIMITS	
G.2.1. FCC CFR	
<p>§15.247(d): For digitally modulated systems, the peak power spectral density conducted from the intentional radiator to the antenna shall not be greater than +8 dBm in any 3 kHz band during any time interval of continuous transmission.</p>	

G.3. ENVIRONMENTAL CONDITIONS	
<b>Temperature</b>	25.2 +/- 2 °C
<b>Humidity</b>	35 +/- 2 %
<b>Barometric Pressure</b>	96.34 kPa

G.4. EQUIPMENT LIST					
ASSET NUMBER	MANUFACTURER	MODEL	DESCRIPTION	LAST CAL	CAL DUE
00015	Agilent	E4408B	Spectrum Analyzer	29Dec03	29Dec04
00075	Alpha Wire-J	9223	2ft. RG223/U RF Cable	08Jul04*	08Jul05
00076	Pasternack	PE7014-30	30dB 2 Watt Attenuator	08Jul04*	08Jul05

\*Cable and attenuator verified with power meter prior to use

G.5. MEASUREMENT EQUIPMENT SETUP	
<b>Measurement Equipment Connections</b>	The equipment was connected as shown in the setup drawing in G.6.
<b>Measurement Equipment Settings</b>	<p>The spectrum analyzer was configured with the following settings:</p> <p>RBW – 3 kHz          VBW – 10 kHz          Sweep time – 500 seconds          Span – 1.5 MHz</p>

<b>Test Report Serial No.:</b>	022305KBC-T618-E15W	Issue 1
<b>Test Date(s):</b>	28Jun04 - 29Jul04, 22Oct04	
<b>Test Type(s):</b>	FCC §15.247	IC RSS-210 Issue 5
<b>Lab Registration(s):</b>	FCC #714830	IC Lab File #3874

**G.6. SETUP DRAWING**

Figure G-1 - Setup Drawing

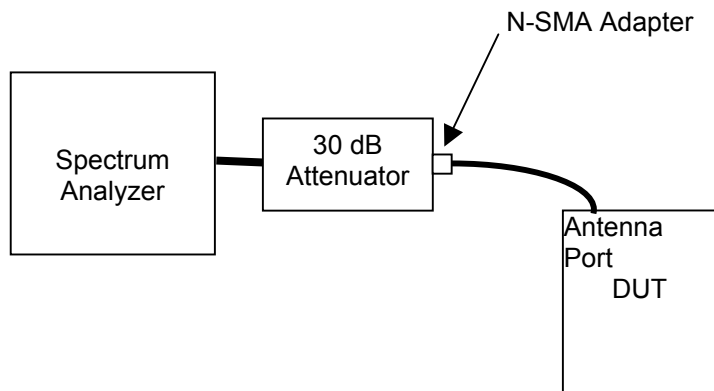

**G.7. DUT OPERATING DESCRIPTION**

The worst-case data rate was determined from prescan investigations. Measurements were made at three channels throughout the band, Low Channel (2412 MHz), Mid Channel (2437 MHz), High Channel (2462 MHz) and for both Modes b and g.

**G.8. TEST RESULTS**

Channel	802.11b			802.11g		
	Frequency (GHz)	PPSD (dBm)	Data Rate Mb/s	Frequency (GHz)	PPSD (dBm)	Data Rate Mb/s
Low	2.411340	-8.516	1	2.411374	-11.69	6
Mid	2.437589	-8.287	1	2.436670	-12.35	6
High	2.461261	-7.351	1	2.462623	-12.05	6

<b>Applicant:</b>	Itronix Corporation	<b>IC ID:</b>	1943A-IX260Pf	<b>FCC ID:</b>	KBCIX260PROA580BT	
<b>Rugged Laptop PC with Intel Pro 2200BG 802.11b/g WLAN Mini-PCI Card</b>				<b>Model:</b>	IX260PROA580BT	

<b>Test Report Serial No.:</b>	022305KBC-T618-E15W	Issue 1
<b>Test Date(s):</b>	28Jun04 - 29Jul04, 22Oct04	
<b>Test Type(s):</b>	FCC §15.247	IC RSS-210 Issue 5
<b>Lab Registration(s):</b>	FCC #714830	IC Lab File #3874

Plot G-1 - PPSD Low Channel (802.11b)

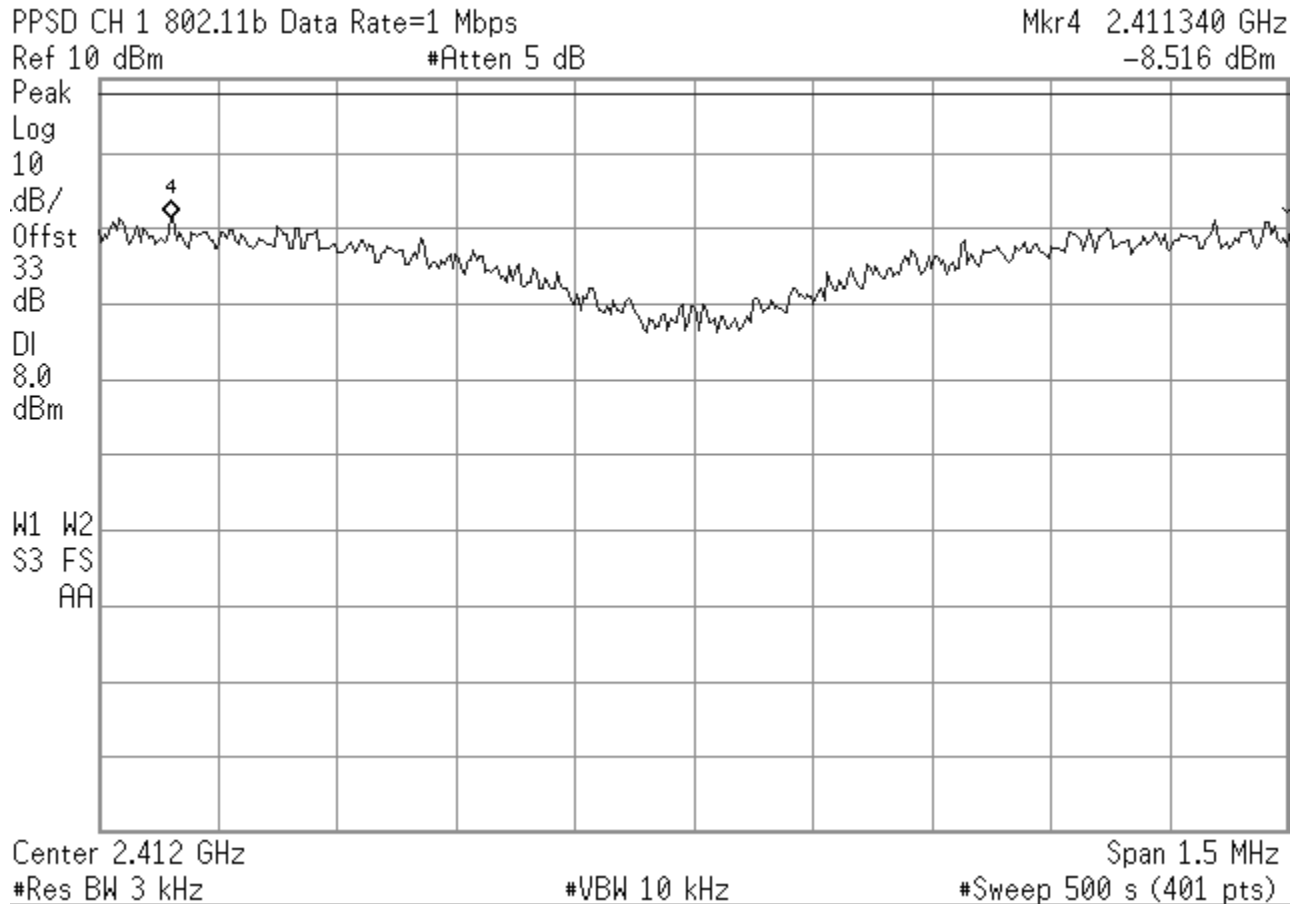

<b>Applicant:</b>	Itronix Corporation	<b>IC ID:</b>	1943A-IX260Pf	<b>FCC ID:</b>	KBCIX260PROA580BT	
<b>Rugged Laptop PC with Intel Pro 2200BG 802.11b/g WLAN Mini-PCI Card</b>				<b>Model:</b>	IX260PROA580BT	
2005 Celltech Labs Inc. This document is not to be reproduced in whole or in part without the written permission of Celltech Labs Inc.						64 of 77

<b>Test Report Serial No.:</b>	022305KBC-T618-E15W	Issue 1
<b>Test Date(s):</b>	28Jun04 - 29Jul04, 22Oct04	
<b>Test Type(s):</b>	FCC §15.247	IC RSS-210 Issue 5
<b>Lab Registration(s):</b>	FCC #714830	IC Lab File #3874

Plot G-2 - PPSD Mid Channel (802.11b)

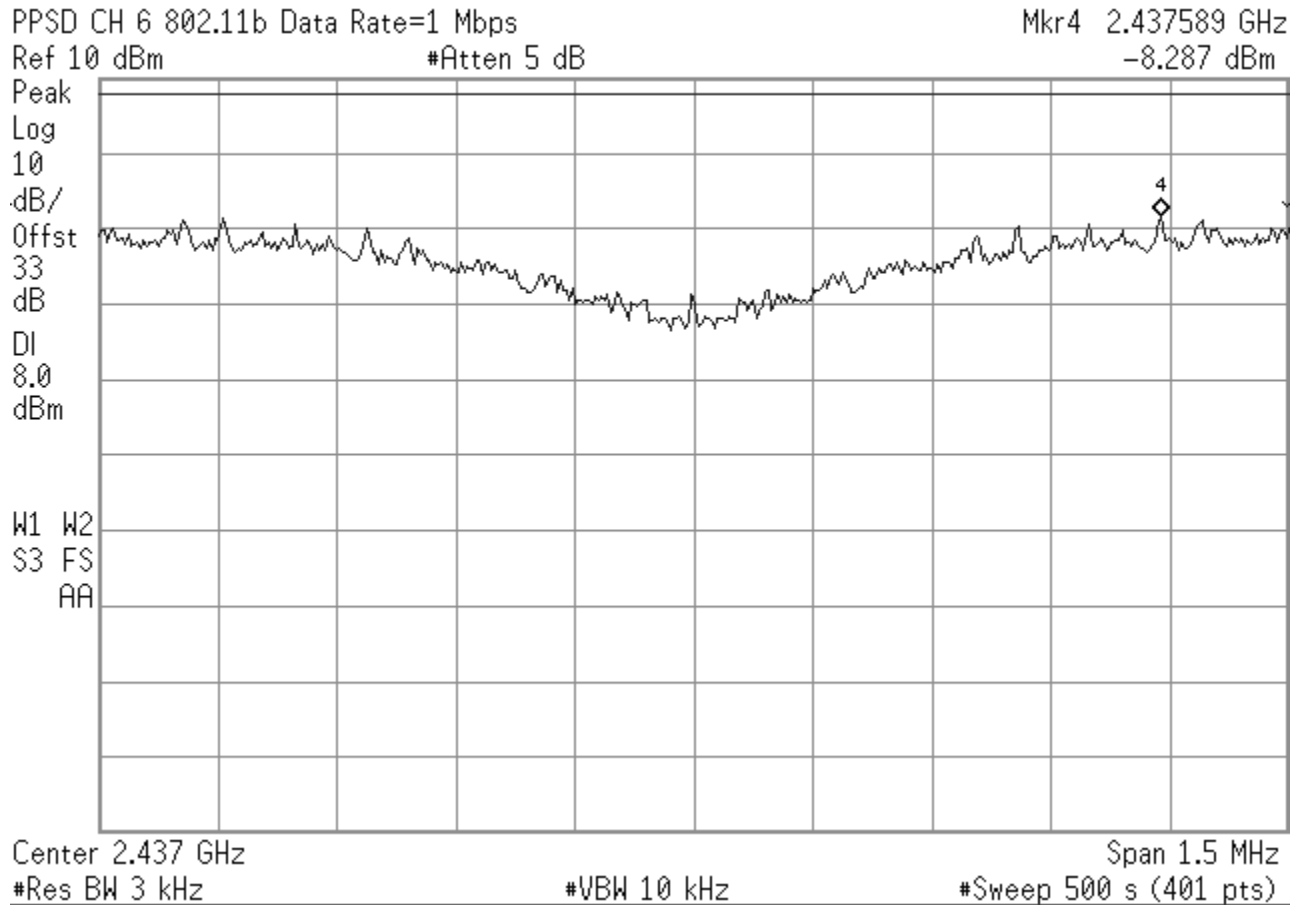

<b>Applicant:</b>	Itronix Corporation	<b>IC ID:</b>	1943A-IX260Pf	<b>FCC ID:</b>	KBCIX260PROA580BT	
<b>Rugged Laptop PC with Intel Pro 2200BG 802.11b/g WLAN Mini-PCI Card</b>				<b>Model:</b>	IX260PROA580BT	
2005 Celltech Labs Inc. This document is not to be reproduced in whole or in part without the written permission of Celltech Labs Inc.						65 of 77

<b>Test Report Serial No.:</b>	022305KBC-T618-E15W	Issue 1
<b>Test Date(s):</b>	28Jun04 - 29Jul04, 22Oct04	
<b>Test Type(s):</b>	FCC §15.247	IC RSS-210 Issue 5
<b>Lab Registration(s):</b>	FCC #714830	IC Lab File #3874

Plot G-3 - PPSD High Channel (802.11b)

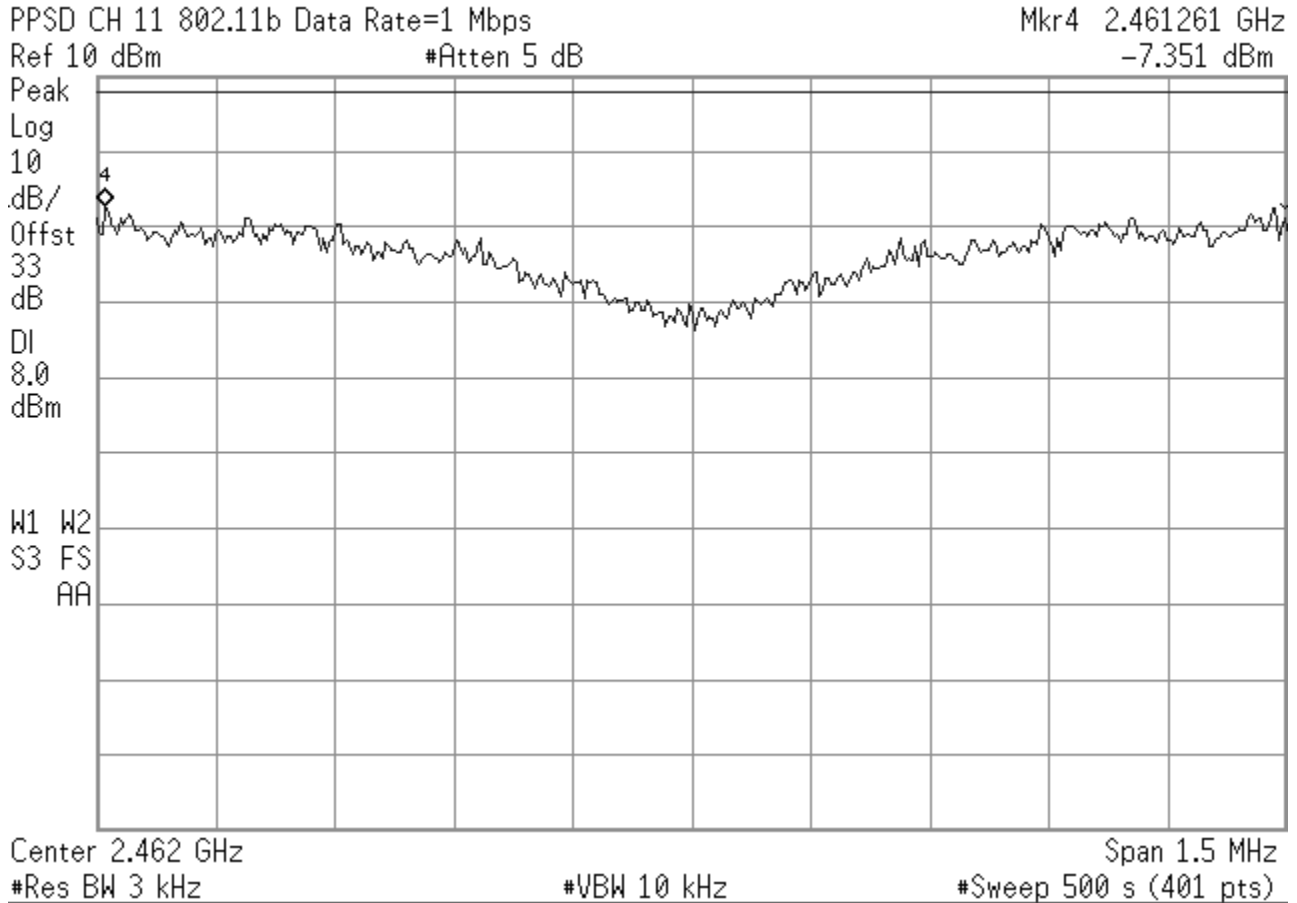

<b>Applicant:</b>	Itronix Corporation	<b>IC ID:</b>	1943A-IX260Pf	<b>FCC ID:</b>	KBCIX260PROA580BT	
<b>Rugged Laptop PC with Intel Pro 2200BG 802.11b/g WLAN Mini-PCI Card</b>				<b>Model:</b>	IX260PROA580BT	
2005 Celltech Labs Inc. This document is not to be reproduced in whole or in part without the written permission of Celltech Labs Inc.						66 of 77

<b>Test Report Serial No.:</b>	022305KBC-T618-E15W	Issue 1
<b>Test Date(s):</b>	28Jun04 - 29Jul04, 22Oct04	
<b>Test Type(s):</b>	FCC §15.247	IC RSS-210 Issue 5
<b>Lab Registration(s):</b>	FCC #714830	IC Lab File #3874

Plot G-4 - PPSD Low Channel (802.11g)

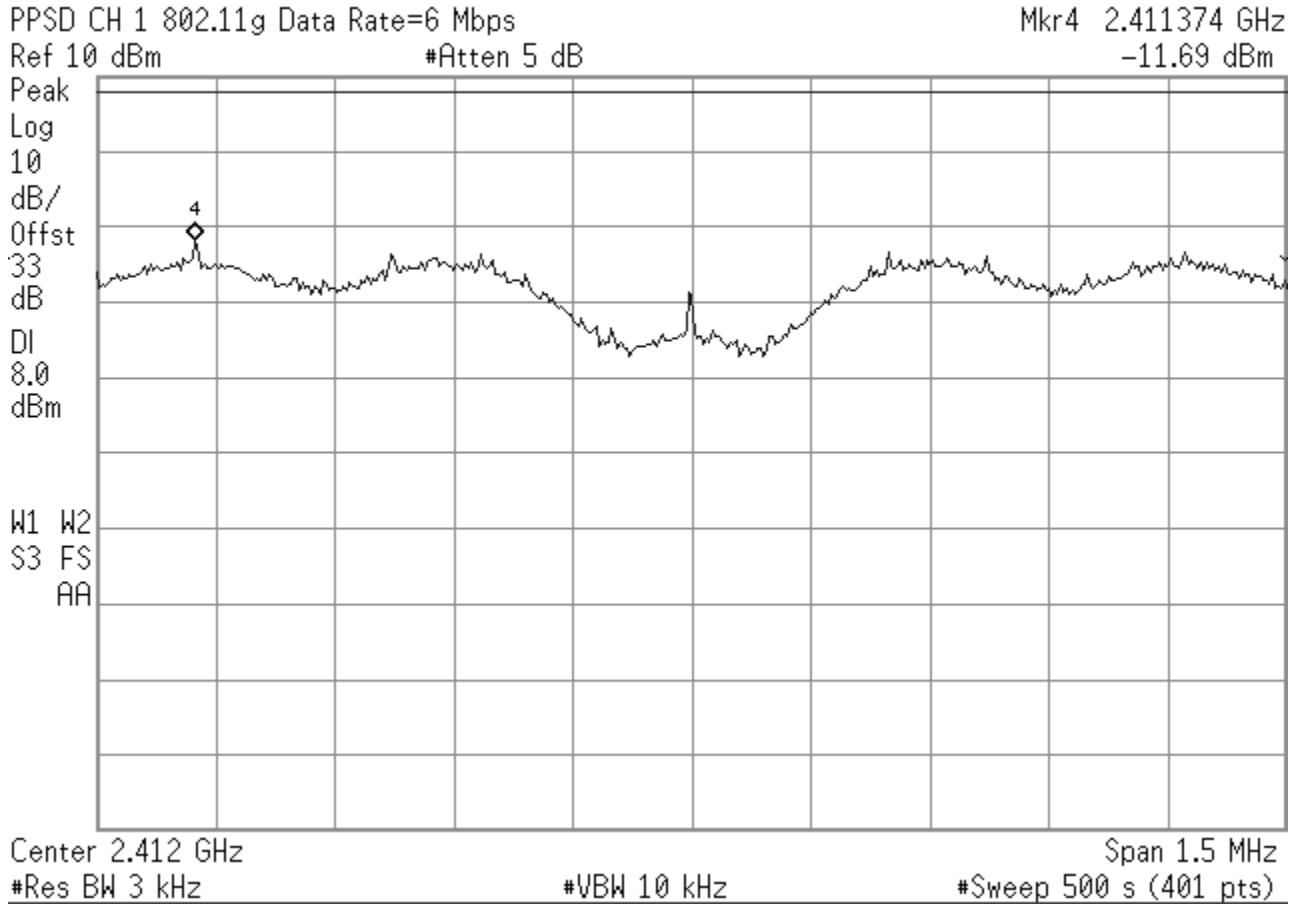



<b>Applicant:</b>	Itronix Corporation	<b>IC ID:</b>	1943A-IX260Pf	<b>FCC ID:</b>	KBCIX260PROA580BT	
<b>Rugged Laptop PC with Intel Pro 2200BG 802.11b/g WLAN Mini-PCI Card</b>				<b>Model:</b>	IX260PROA580BT	
2005 Celltech Labs Inc. This document is not to be reproduced in whole or in part without the written permission of Celltech Labs Inc.						67 of 77

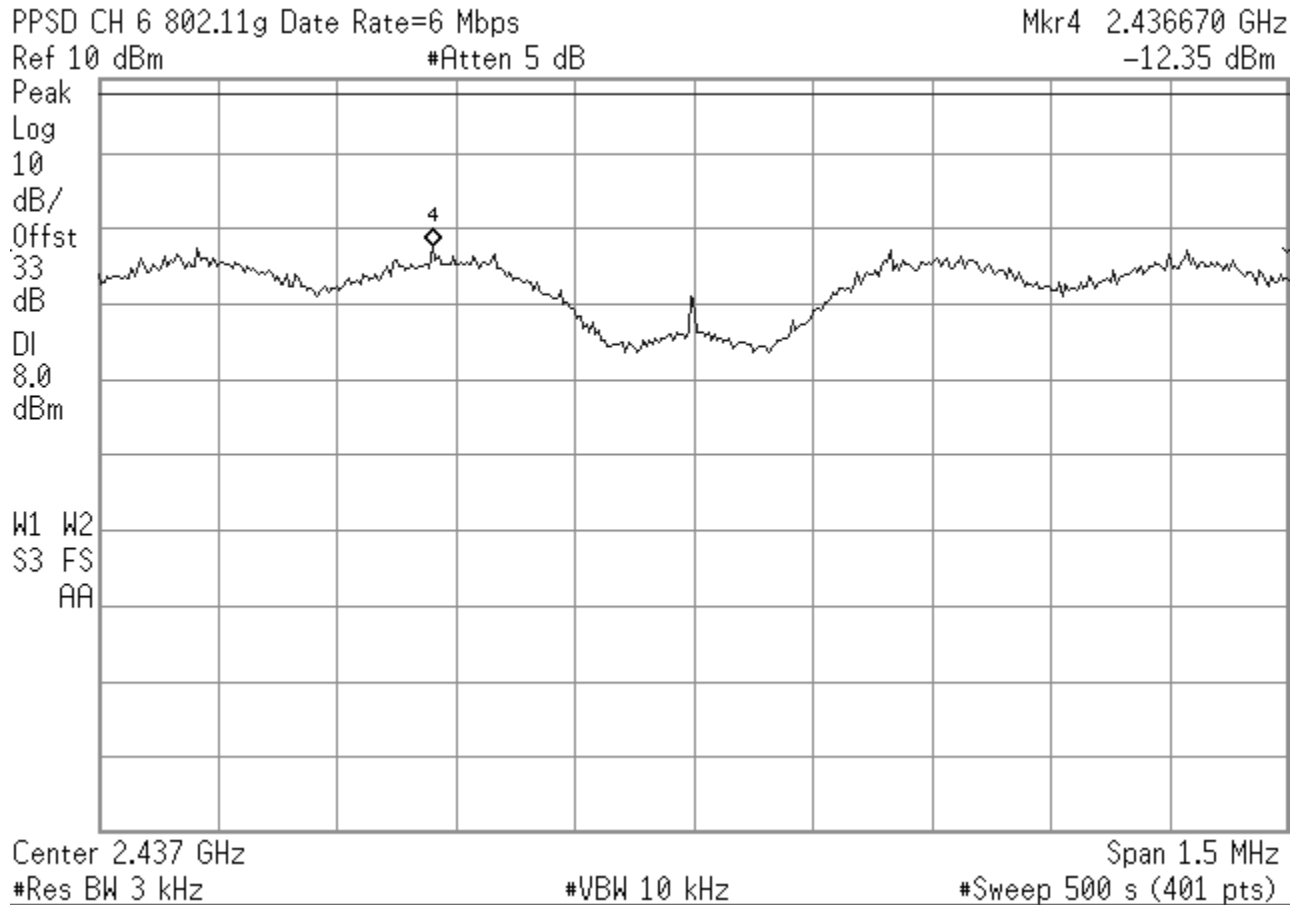

Test Report Serial No.:	022305KBC-T618-E15W	Issue 1
Test Date(s):	28Jun04 - 29Jul04, 22Oct04	
Test Type(s):	FCC §15.247	IC RSS-210 Issue 5
Lab Registration(s):	FCC #714830	IC Lab File #3874

Plot G-5 - PPSD Mid Channel (802.11g)



Applicant:	Itronix Corporation	IC ID:	1943A-IX260Pf	FCC ID:	KBCIX260PROA580BT	
Rugged Laptop PC with Intel Pro 2200BG 802.11b/g WLAN Mini-PCI Card				Model:	IX260PROA580BT	
2005 Celltech Labs Inc. This document is not to be reproduced in whole or in part without the written permission of Celltech Labs Inc.						68 of 77

<b>Test Report Serial No.:</b>	022305KBC-T618-E15W	Issue 1
<b>Test Date(s):</b>	28Jun04 - 29Jul04, 22Oct04	
<b>Test Type(s):</b>	FCC §15.247	IC RSS-210 Issue 5
<b>Lab Registration(s):</b>	FCC #714830	IC Lab File #3874

Plot G-6 - PPSD High Channel (802.11g)

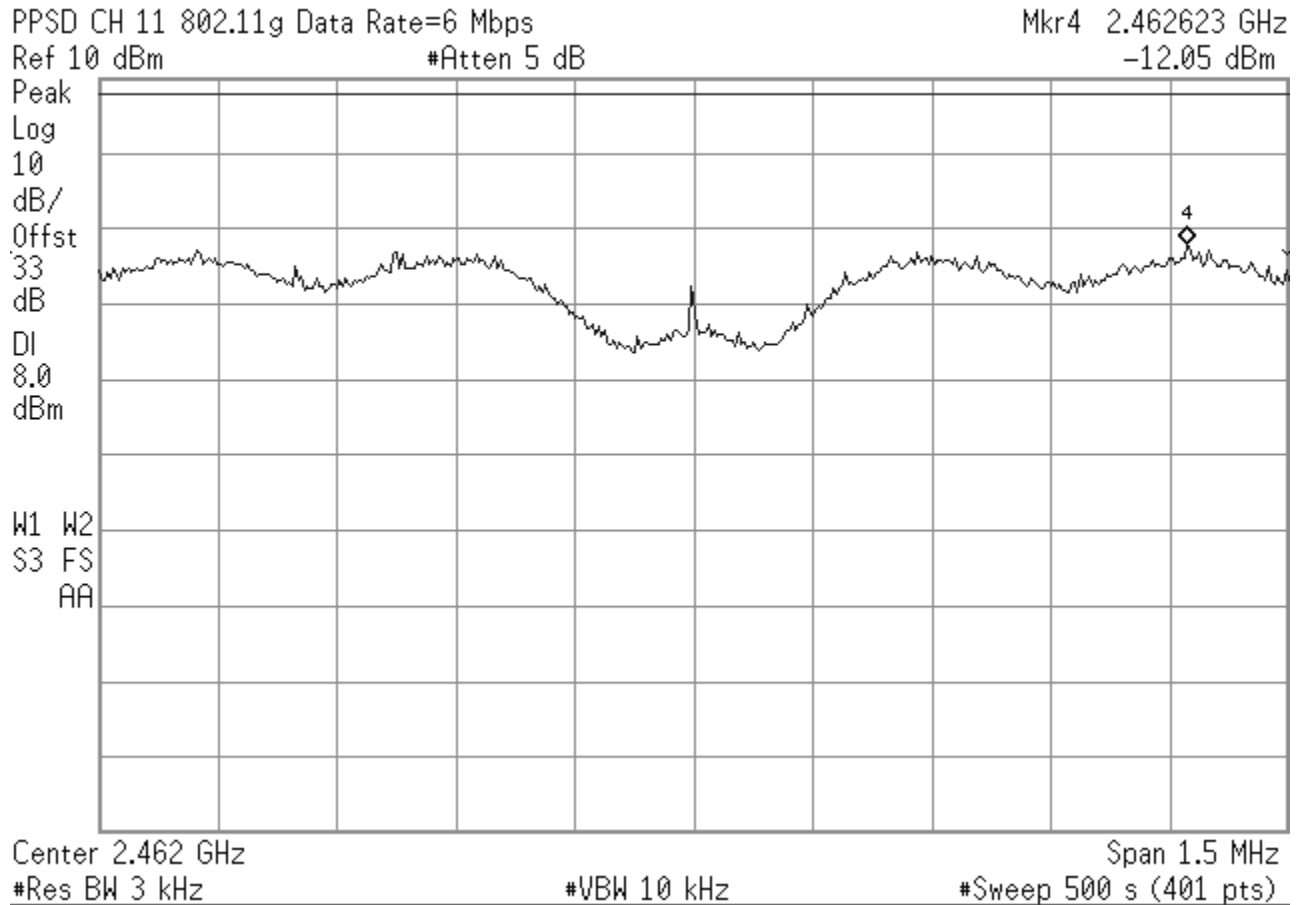

<b>Applicant:</b>	Itronix Corporation	<b>IC ID:</b>	1943A-IX260Pf	<b>FCC ID:</b>	KBCIX260PROA580BT	
<b>Rugged Laptop PC with Intel Pro 2200BG 802.11b/g WLAN Mini-PCI Card</b>				<b>Model:</b>	IX260PROA580BT	
2005 Celltech Labs Inc. This document is not to be reproduced in whole or in part without the written permission of Celltech Labs Inc.						69 of 77

<b>Test Report Serial No.:</b>	022305KBC-T618-E15W	Issue 1
<b>Test Date(s):</b>	28Jun04 - 29Jul04, 22Oct04	
<b>Test Type(s):</b>	FCC §15.247	IC RSS-210 Issue 5
<b>Lab Registration(s):</b>	FCC #714830	IC Lab File #3874

**G.9. PASS/FAIL**

In reference to the results outlined in G.8 the DUT passes the requirements as stated in the reference standards as follows:  
 FCC 15.247 (d): The peak power spectral density did not exceed +8 dBm in any 3 kHz band.

**G.10. SIGN-OFF**

I attest to the accuracy of the data. All measurements reported herein were performed by me and are correct to the best of my knowledge and belief. I assume full responsibility for the completeness of these measurements.



\_\_\_\_\_  
 Russell Pipe  
 Senior Compliance Technologist  
 Celltech Labs Inc.

04Aug04  
 \_\_\_\_\_  
 Date

## Appendix H - Conducted Powerline Emissions Measurement

H.1. REFERENCES	
<b>Normative Reference Standard</b>	CFR 47 FCC Part 15 §15.207
<b>Procedure Reference</b>	ANSI C63.4

H.2. LIMITS		
<p>§15.207: Compliance with the provisions of this paragraph shall be based on the measurement of the radio frequency voltage between each powerline and ground at the power terminal.</p>		
Frequency of Emission (MHz)	Conducted Limit (dBuV)	
	Quasi-Peak	Average
0.15 – 0.5	66 to 56*	56 to 46*
0.50 – 5.0	56	46
5.0 – 30.0	60	50

\*Decreases logarithmically with frequency.

H.3. ENVIRONMENTAL CONDITIONS	
<b>Temperature</b>	+26 ± 5 °C
<b>Humidity</b>	31 % ± 10% RH
<b>Barometric Pressure</b>	101.4 kpa

H.4. EQUIPMENT LIST					
ASSET NUMBER	MANUFACTURER	MODEL	DESCRIPTION	LAST CAL	CAL DUE
00063	HP	85662A	Spectrum Analyzer Display	na	na
00051	HP	8566B	Spectrum Analyzer RF Section	18May04	18May05
00049	HP	85650A	Quasi-Peak Adapter	18May04	18May05
00047	HP	85685A	Preselector	18May04	18May05
00083	EMCO	3825/2	Line Impedance Stabilization Network	29Apr04	29Apr05
00084	EMCO	3825/2	Line Impedance Stabilization Network	29Apr04	29Apr05

H.5. MEASUREMENT EQUIPMENT SETUP	
<b>MEASUREMENT EQUIPMENT CONNECTIONS</b>	The conducted emissions were measured on each of the two AC powerline leads connected to the DUT's power supply brick. A two line LISN was used to make this measurement. A drawing of the equipment setup is shown in H.7
<b>MEASUREMENT EQUIPMENT SETTINGS</b>	<p>Each of the monitor ports from the 2-line LISN was connected in turn to the spectrum analyzer. The port not connected to the analyzer was terminated in a 50-ohm load. A prescan of the peak emission levels was made of the 150 kHz – 30 MHz range split into 4 equal frequency bands. The following were the spectrum analyzer settings:</p> <p style="margin-left: 40px;">Start Frequency and Stop Frequency set by software for each of the four bands  RBW: 100 kHz  VBW: 300 kHz  Sweep: 500 mS</p> <p>The resulting data from each band was corrected and collected by software and presented in the graphical representations shown in H.9 for the two leads. The frequency points with the highest 10 levels on each lead were used by software to optimize a set of 20 readings for each type of detector (peak, quasi-peak and average). This data was corrected by the software is presented in the tables shown in section H.9.</p>

<b>Test Report Serial No.:</b>	022305KBC-T618-E15W	Issue 1
<b>Test Date(s):</b>	28Jun04 - 29Jul04, 22Oct04	
<b>Test Type(s):</b>	FCC §15.247	IC RSS-210 Issue 5
<b>Lab Registration(s):</b>	FCC #714830	IC Lab File #3874

**H.6. SETUP PHOTOS**

Photograph H-1 - AC Powerline Conducted Emission Configuration



Photograph H-2 - AC Powerline Conducted Emission Cable Placement

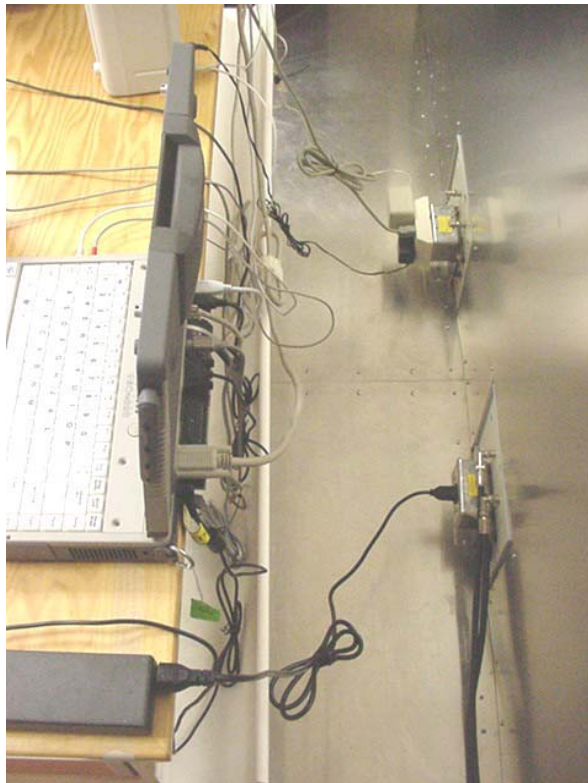

<b>Applicant:</b>	Itronix Corporation	<b>IC ID:</b>	1943A-IX260Pf	<b>FCC ID:</b>	KBCIX260PROA580BT	
<b>Rugged Laptop PC with Intel Pro 2200BG 802.11b/g WLAN Mini-PCI Card</b>				<b>Model:</b>	IX260PROA580BT	
2005 Celltech Labs Inc. This document is not to be reproduced in whole or in part without the written permission of Celltech Labs Inc.						72 of 77

### H.7. SETUP DRAWING

Figure H-1 - Setup Drawing

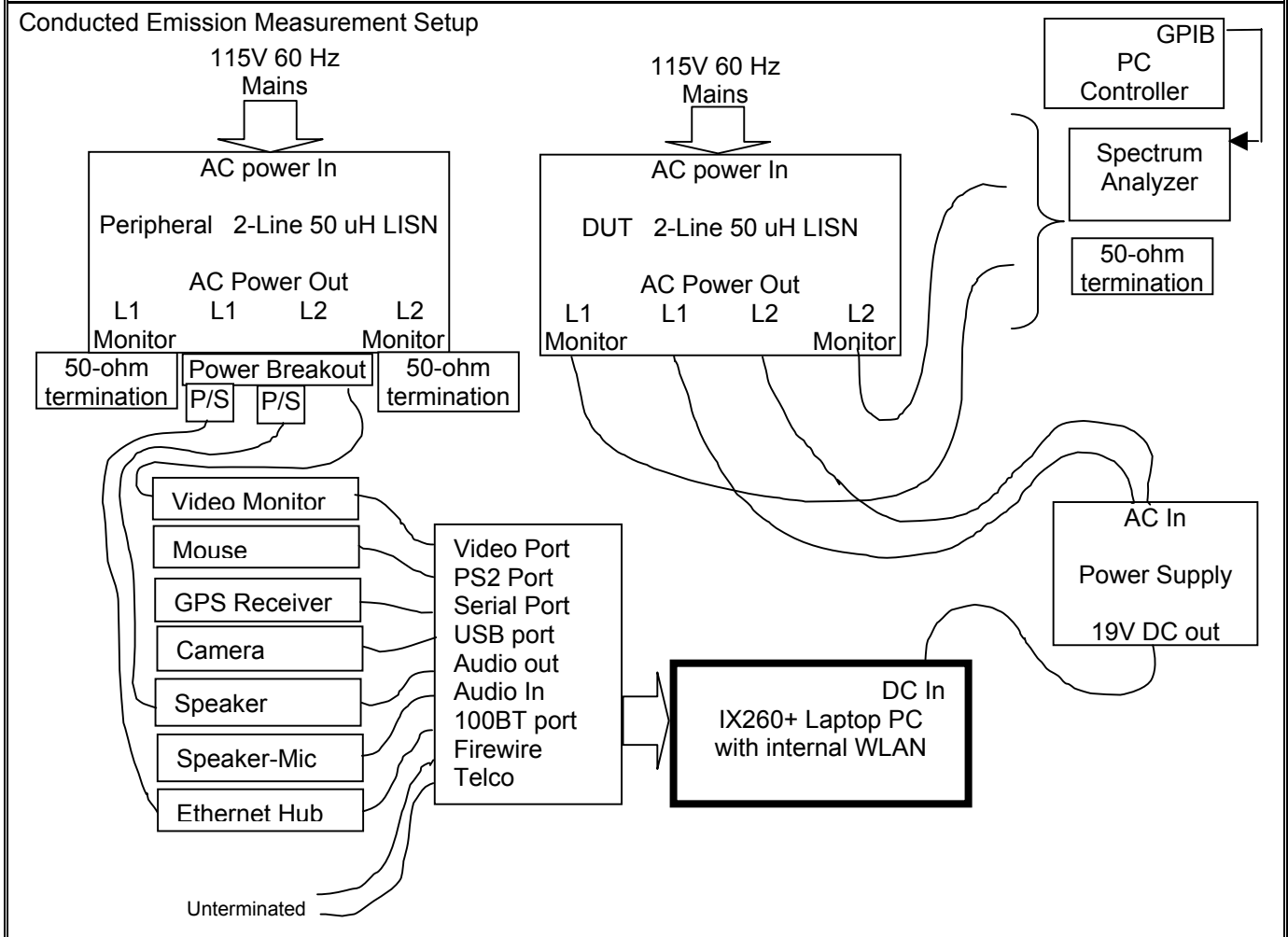

### H.8. DUT OPERATING DESCRIPTION

<b>WLAN:</b>	The WLAN was set to transmit at full power on Channel 1, Mode g 6 Mb/s
<b>PC:</b>	Other than operating the WLAN software and running MS windows, no PC exercising was performed.
<b>Peripherals:</b>	All peripherals were active, but no specific traffic was initiated.

<b>Test Report Serial No.:</b>	022305KBC-T618-E15W	Issue 1
<b>Test Date(s):</b>	28Jun04 - 29Jul04, 22Oct04	
<b>Test Type(s):</b>	FCC §15.247	IC RSS-210 Issue 5
<b>Lab Registration(s):</b>	FCC #714830	IC Lab File #3874

### H.9. TEST RESULTS

	<b>Project Number:</b>	052604-515/516KBC	<b>Standard:</b>	FCC 15.207
	<b>Company:</b>	Itronix	<b>Test Start Date:</b>	29-Jun-04
	<b>Product:</b>	IX260+ with Intel Pro 2200BG WLAN	<b>Test End Date:</b>	5-Jul-04

#### Line 1 Conducted Emissions

Frequency MHz	Uncorrected Reading			Correction Factor dB	Corrected Emission Level			Quasi-Peak Limit dBuV	Quasi-Peak Margin dB	Average Limit dBuV	Average Margin dB	Pass/Fail
	Peak dBuV	Quasi-Peak dBuV	Average dBuV		Peak dBuV	Quasi-Peak dBuV	Average dBuV					
0.150		39.60	37.40	2.13		41.73	39.53	66.00	24.27	56.00	16.47	Pass
2.737		41.80	41.90	0.28		42.08	42.18	56.00	13.92	46.00	3.82	Pass
8.666		40.20	36.60	0.32		40.52	36.92	60.00	19.48	50.00	13.08	Pass
24.575		22.40	20.00	0.43		22.83	20.43	60.00	37.17	50.00	29.57	Pass

Corrected Emission Level (dBuV) = Uncorrected Reading (dBuV) + Correction Factor (dB)  
 Margin (dB) = Limit (dBuV) - Corrected Emission Level (dBuV)

	<b>Project Number:</b>	052604-515/516KBC	<b>Standard:</b>	FCC 15.207
	<b>Company:</b>	Itronix	<b>Test Start Date:</b>	29-Jun-04
	<b>Product:</b>	IX260+ with Intel Pro 2200BG WLAN	<b>Test End Date:</b>	05-Jul-04

#### Line 2 Conducted Emissions

Frequency MHz	Uncorrected Reading			Correction Factor dB	Corrected Emission Level			Quasi-Peak Limit dBuV	Quasi-Peak Margin dB	Average Limit dBuV	Average Margin dB	Pass/Fail
	Peak dBuV	Quasi-Peak dBuV	Average dBuV		Peak dBuV	Quasi-Peak dBuV	Average dBuV					
0.154		43.30	43.10	2.07		45.37	45.17	65.78	20.41	55.78	10.61	Pass
3.191		42.50	42.40	0.29		42.79	42.69	56.00	13.21	46.00	3.31	Pass
8.358		40.30	39.10	0.33		40.63	39.43	60.00	19.37	50.00	10.57	Pass
24.575		23.40	20.20	0.43		23.83	20.63	60.00	36.17	50.00	29.37	Pass

Corrected Emission Level (dBuV) = Uncorrected Reading (dBuV) + Correction Factor (dB)  
 Margin (dB) = Limit (dBuV) - Corrected Emission Level (dBuV)

### Calculations

CF = Correction Factor  
 Emission Level = Measured Level + correction factor  
 Margin = Limit – Emission Level

<b>Applicant:</b>	Itronix Corporation	<b>IC ID:</b>	1943A-IX260Pf	<b>FCC ID:</b>	KBCIX260PROA580BT	
<b>Rugged Laptop PC with Intel Pro 2200BG 802.11b/g WLAN Mini-PCI Card</b>				<b>Model:</b>	IX260PROA580BT	
2005 Celltech Labs Inc. This document is not to be reproduced in whole or in part without the written permission of Celltech Labs Inc.						74 of 77



Test Report Serial No.:	022305KBC-T618-E15W	Issue 1
Test Date(s):	28Jun04 - 29Jul04, 22Oct04	
Test Type(s):	FCC §15.247	IC RSS-210 Issue 5
Lab Registration(s):	FCC #714830	IC Lab File #3874

Plot H-1 - Line 1 Peak Conducted Powerline Emissions

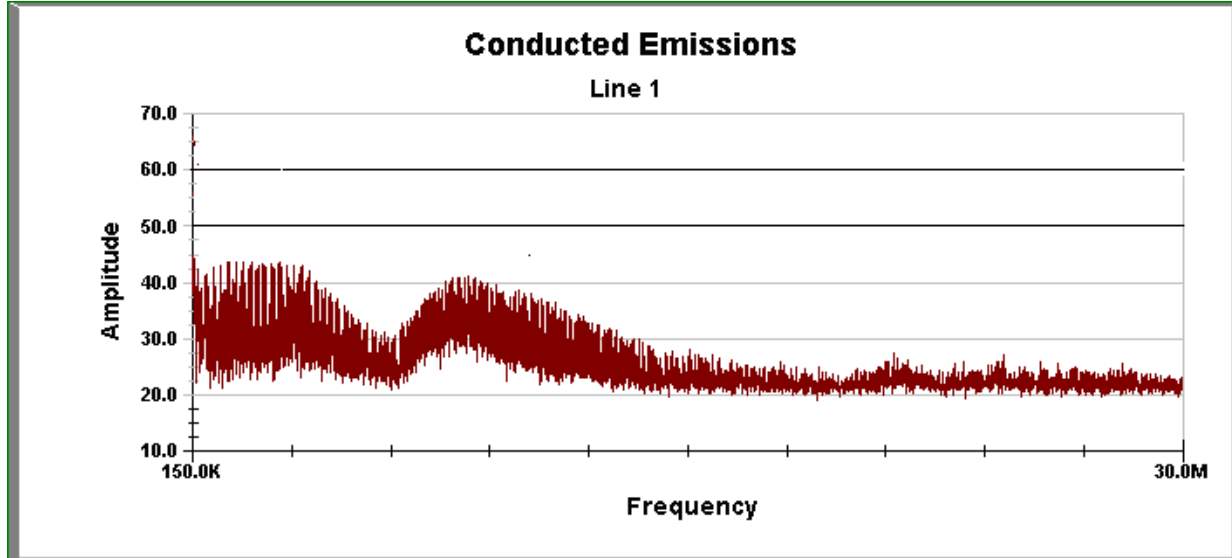

Plot H-2 - Line 2 Peak Conducted Powerline Emissions

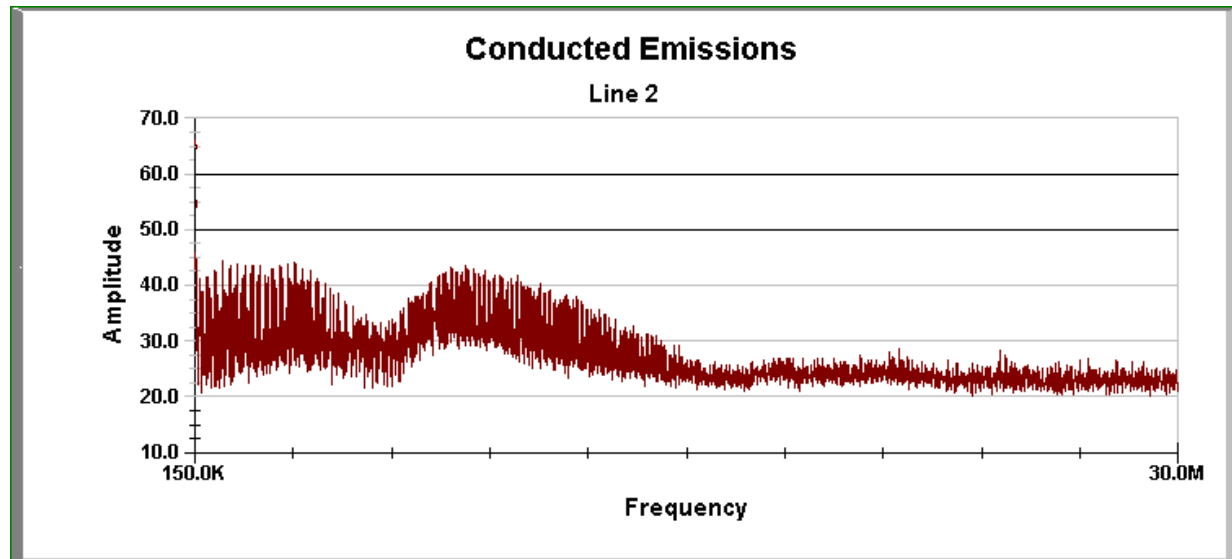

<b>Test Report Serial No.:</b>	022305KBC-T618-E15W	Issue 1
<b>Test Date(s):</b>	28Jun04 - 29Jul04, 22Oct04	
<b>Test Type(s):</b>	FCC §15.247	IC RSS-210 Issue 5
<b>Lab Registration(s):</b>	FCC #714830	IC Lab File #3874

#### H.10. PASS/FAIL

In reference to the results outlined in H.9 the DUT passes the requirements as stated in the reference standards as follows:  
The RF voltage measured in reference to ground on each of the power line conductors does not exceed the limits as outline in FCC 15.207.

#### H.11. SIGN-OFF

I attest to the accuracy of the data. All measurements reported herein were performed by me and are correct to the best of my knowledge and belief. I assume full responsibility for the completeness of these measurements.



\_\_\_\_\_  
Duane M. Friesen, C.E.T.  
EMC Manager  
Celltech Labs Inc.

\_\_\_\_\_  
04Aug04

Date

<b>Applicant:</b>	Itronix Corporation	<b>IC ID:</b>	1943A-IX260Pf	<b>FCC ID:</b>	KBCIX260PROA580BT	
<b>Rugged Laptop PC with Intel Pro 2200BG 802.11b/g WLAN Mini-PCI Card</b>				<b>Model:</b>	IX260PROA580BT	
2005 Celltech Labs Inc. This document is not to be reproduced in whole or in part without the written permission of Celltech Labs Inc.						76 of 77

<b>Test Report Serial No.:</b>	022305KBC-T618-E15W	Issue 1
<b>Test Date(s):</b>	28Jun04 - 29Jul04, 22Oct04	
<b>Test Type(s):</b>	FCC §15.247	IC RSS-210 Issue 5
<b>Lab Registration(s):</b>	FCC #714830	IC Lab File #3874

**END OF DOCUMENT**

<b>Applicant:</b>	Itronix Corporation	<b>IC ID:</b>	1943A-IX260Pf	<b>FCC ID:</b>	KBCIX260PROA580BT	
<b>Rugged Laptop PC with Intel Pro 2200BG 802.11b/g WLAN Mini-PCI Card</b>				<b>Model:</b>	IX260PROA580BT	
2005 Celltech Labs Inc. This document is not to be reproduced in whole or in part without the written permission of Celltech Labs Inc.						77 of 77