

Test Report Serial No.:	022305KBC-T618-E24C	Issue 1
Test Date(s):	30Mar05 - 19Apr05	
Test Standard(s):	FCC §2, §22H, §24E	IC RSS-132/133
Lab Registration(s):	FCC #714830	IC Lab File #3874

EMC TEST REPORT
FOR THE
ITRONIX RUGGED LAPTOP PC MODEL: IX260PROA580BT
WITH THE
SIERRA WIRELESS AIRCARD 580 DUAL-BAND CDMA PCMCIA MODEM
UTILIZING THE
EXTERNAL SWIVEL DIPOLE ANTENNA
AND
VEHICLE-MOUNT ANTENNA WITH CRADLE

TRSN 022305KBC-T618-E24C
Issue 1.0

Celltech Compliance Testing & Engineering Lab
(Celltech Labs Inc.)
1955 Moss Court
Kelowna, BC
Canada
V1Y 9L3

May 09, 2005

Test Report Serial No.:	022305KBC-T618-E24C	Issue 1
Test Date(s):	30Mar05 - 19Apr05	
Test Standard(s):	FCC §2, §22H, §24E	IC RSS-132/133
Lab Registration(s):	FCC #714830	IC Lab File #3874

DECLARATION OF COMPLIANCE

Test Lab		CELLTECH LABS INC. Testing and Engineering Services 1955 Moss Court Kelowna, B.C. Canada V1Y 9L3		Applicant Information		ITRONIX CORPORATION 801 South Stevens Street Spokane, WA 99204 United States	
Phone:		250-448-7047					
Fax:		250-448-7048					
e-mail:		info@celltechlabs.com					
web site:		www.celltechlabs.com					
laboratory Registration No.(s):		FCC:	714830	IC:	IC 3874		
Rule Part(s):	FCC:	Dual Band CDMA	§2; §22H; §24E				
	IC:	Dual Band CDMA	RSS-133 Issue 2 Revision 1, RSS-132 Issue 1 (Provisional)				
Device Classification:	FCC:	Dual Band CDMA	- PCS Licensed Transmitter (PCB)				
		Dual Band CDMA	- 800 MHz Cellular Telephones Employing New Technologies - 2 GHz Personal Communication Services				
Device Identification:	FCC ID:	KBCIX260PROA580BT	IC ID:	1943A-IX260Pf			
DUT Description:							
Model:	IX260PROA580BT						
Device Description:	Rugged Laptop PC (with optional vehicle cradle)						
Internal Transmitter:	Sierra Wireless AirCard 580 Dual-Band CDMA PCMCIA Modem						
Antenna(s) Tested:	Dual Band CDMA	Itronix External Swivel Dipole (Model: IX260+)					
		MaxRad Vehicle-Mount (P/N: WMLPVDB800/1900)					
Tx Frequency Range(s):	Dual Band CDMA	Cellular	824.7 - 848.31 MHz				
		PCS	1851.25 - 1908.75 MHz				
Max. RF Output Power:	Dual Band CDMA	Cellular	+23.61 dBm (Conducted)				
		PCS	+25.07 dBm (Conducted)				
Modulation Type(s):	Dual Band CDMA	QPSK					
Power Source(s):	90 Watt AC Power Adapter (Model: ADP-90AB)						
	11.1 V Lithium-ion Battery, 6.0 Ah (Model: A2121-2)						
	12 V Vehicle Battery (for Vehicle Cradle)						

This wireless mobile device has demonstrated compliance with the applicable technical standards as indicated in the measurement report and was tested in accordance with the measurement procedures specified in FCC 47 CFR Parts 2, 22H, 24E, Industry Canada RSS-132 Issue 1 (Provisional), RSS 133 Issue 2 Revision 1; and ANSI TIA/EIA-603-C-2004.

I attest to the accuracy of the data. All measurements reported herein were performed by me or were under my supervision and are correct to the best of my knowledge and belief. I assume full responsibility for the completeness of these measurements and vouch for the qualifications of all persons taking them.

This test report shall not be reproduced partially, or in full, without the prior written approval of Celltech Labs Inc. The results and statements contained in this report pertain only to the device(s) evaluated.



Russell Pipe
Senior Compliance Technologist
Celltech Labs Inc.

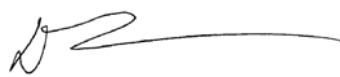

Duane M. Friesen
EMC Manager
Celltech Labs Inc.



Applicant:	Itronix Corporation	FCC ID:	KBCIX260PROA580BT	IC ID:	1943A-IX260Pf	
Rugged Laptop PC with Sierra Wireless AirCard 580 Dual-Band CDMA Modem			Model:	IX260PROA580BT		
2005 Celltech Labs Inc. This document is not to be reproduced in whole or in part without the written permission of Celltech Labs Inc. 2 of 50						

Test Report Serial No.:	022305KBC-T618-E24C	Issue 1
Test Date(s):	30Mar05 - 19Apr05	
Test Standard(s):	FCC §2, §22H, §24E	IC RSS-132/133
Lab Registration(s):	FCC #714830	IC Lab File #3874

TABLE OF CONTENTS

1.0 SCOPE	6
2.0 REFERENCES	6
2.1 Normative References	6
3.0 TERMS AND DEFINITIONS	7
4.0 FACILITIES AND ACCREDITATIONS	8
5.0 GENERAL INFORMATION	8
5.1 Applicant Information	8
5.2 DUT Description	8
5.3 Co-Located Equipment	9
5.4 Cable Descriptions	9
5.5 Support Equipment	10
5.6 Clock Frequencies	10
5.7 Mode(s) of Operation Tested	11
5.8 Configuration Description	12
6.0 PASS/FAIL CRITERIA	12
APPENDICES	13
Appendix A - Photographs	14
Appendix B - CDMA Conducted RF Output Power Measurement	16
Appendix C - Effective Radiated Power Measurement	19
Appendix D - Cellular Radiated Spurious Emissions Measurement	25
Appendix E - Effective Isotropic Radiated Power Measurement	32
Appendix F - PCS Radiated Spurious Emissions Measurement	38
Appendix G - Maximum Permissible Exposure Calculation	46
END OF DOCUMENT	50

Test Report Serial No.:	022305KBC-T618-E24C	Issue 1
Test Date(s):	30Mar05 - 19Apr05	
Test Standard(s):	FCC §2, §22H, §24E	IC RSS-132/133
Lab Registration(s):	FCC #714830	IC Lab File #3874

FIGURES

Figure B.6-1 - Setup Drawing	17
Figure C.6-1 - Field Strength Setup Drawing	20
Figure C.6-2 - Signal Substitution Setup Drawing	20
Figure D.6-1 - Field Strength Setup Drawing	27
Figure D.6-2 - Signal Substitution Setup Drawing	27
Figure E.6-1 - Field Strength Setup Drawing	33
Figure E.6-2 - Substitution Setup Drawing	33
Figure F.6-1 - Field Strength Setup Drawing	40
Figure F.6-2 - Signal Substitution Setup Drawing	40

PHOTOGRAPHS

Photograph A.1-1 - Rugged Laptop PC Open - front	14
Photograph A.1-2 - Rugged Laptop PC Open - right side	14
Photograph A.1-3 - DUT in Vehicle Cradle with Vehicle-Mount Antenna - front	14
Photograph A.1-4 - DUT in Vehicle Cradle with Vehicle-Mount Antenna - back	14
Photograph A.1-5 - Dual-Band CDMA PCMCIA Modem	15
Photograph A.1-6 - CDMA Modem installed in DUT	15
Photograph A.1-7 - AirCard 580 Dual-Band CDMA Modem	15
Photograph C.7-1 - DUT Swivel Dipole Antenna with Horizontal Bilog Receive Antenna Setup	21
Photograph C.7-2 - DUT Vehicle Antenna & Cradle with Vertical Bilog Receive Antenna Setup	21
Photograph C.7-3 - Front of Radiated Emissions Setup with attached swivel dipole antenna	22
Photograph C.7-4 - Front of Radiated Emissions Setup with vehicle-mount antenna and cradle	22
Photograph C.7-5 - Back of Radiated Emissions Setup with attached swivel dipole antenna	22
Photograph C.7-6 - Back of Radiated Emissions Setup with vehicle-mount antenna and cradle	22
Photograph D.7-1 - DUT with Dipole Antenna, Horizontal 3115 Horn and LNA	28
Photograph D.7-2 - DUT with Dipole Antenna, Vertical 3115 Horn and LNA	28
Photograph D.7-3 - Front of Radiated Emission Setup	28
Photograph D.7-4 - Back of Radiated Emission Setup	28
Photograph D.7-5 - Front of Radiated Emission Setup with vehicle-mount antenna and cradle	29
Photograph D.7-6 - Back of Radiated Emission Setup with vehicle-mount antenna and cradle	29
Photograph E.7-1 - DUT Swivel Dipole Antenna with Horizontal Horn Receive Antenna	34
Photograph E.7-2 - DUT Swivel Dipole Antenna with Vertical Horn Receive Antenna	34
Photograph E.7-3 - Front of Radiated Emission Setup with attached swivel dipole antenna	34
Photograph E.7-4 - Front of Radiated Emission Setup with vehicle-mount antenna and cradle	34
Photograph E.7-5 - Back of Radiated Emission Setup with attached swivel dipole antenna	35
Photograph E.7-6 - Back of Radiated Emission Setup with vehicle-mount antenna and cradle	35
Photograph F.7-1 - Horizontal 3115 Horn and LNA DUT with attached swivel dipole antenna	41
Photograph F.7-2 - Vertical 3115 Horn and LNA DUT with attached swivel dipole antenna	41
Photograph F.7-3 - Back of Radiated Emission Setup with attached swivel dipole antenna	41
Photograph F.7-4 - Front of Radiated Emission Setup with vehicle-mount antenna and cradle	41
Photograph F.7-5 - Front of Radiated Emission Setup with vehicle-mount antenna and cradle	42
Photograph F.7-6 - Back of Radiated Emission Setup with vehicle-mount antenna and cradle	42

Test Report Serial No.:	022305KBC-T618-E24C	Issue 1
Test Date(s):	30Mar05 - 19Apr05	
Test Standard(s):	FCC §2, §22H, §24E	IC RSS-132/133
Lab Registration(s):	FCC #714830	IC Lab File #3874

TEST SUMMARY

Referenced Standard: FCC CFR Title 47 Part 2, 22H

Appendix	Test Description	Procedure Reference	Limit Reference	Test Start Date	Test End Date	Result
B	Conducted RF Output Power	ANSI/TIA/EIA-603-C	§22.913	30Mar05	30Mar05	Pass
C	Effective Radiated Power	ANSI/TIA/EIA-603-C	§22.913	11Apr05	11Apr05	Pass
D	Radiated Spurious Emissions	ANSI/TIA/EIA-603-C	§22.917 (b)	1Apr05	19Apr05	Pass
G	Maximum Permissible Exposure	FCC CFR 47 § 2.1091 IEEE Std C95.1-1999	§1.1310 Table 1 (b)	na	na	Pass

Referenced Standard: FCC CFR Title 47 Part 2, 24E

B	Conducted RF Output Power	ANSI/TIA/EIA-603-C	§24.232(b)	30Mar05	30Mar05	Pass
E	Effective Isotropic Radiated Power	ANSI/TIA/EIA-603-C	§24.232(b)	11Apr05	11Apr05	Pass
F	Radiated Spurious Emissions	ANSI/TIA/EIA-603-C	§24.238 (a)	1Apr05	19Apr05	Pass
G	Maximum Permissible Exposure	FCC CFR 47 § 2.1091 IEEE Std C95.1-1999	§1.1310 Table 1 (b)	na	na	Pass

Referenced Standard: IC RSS-132

B	Conducted RF Output Power	ANSI/TIA/EIA-603-C	RSS-132 §4.4	30Mar05	30Mar05	Pass
C	Effective Radiated Power	ANSI/TIA/EIA-603-C	RSS-132 §4.4	11Apr05	11Apr05	Pass
D	Radiated Spurious Emissions	ANSI/TIA/EIA-603-C	RSS-132 §4.4	1Apr05	19Apr05	Pass
G	Maximum Permissible Exposure	FCC CFR 47 § 2.1091 IEEE Std C95.1-1999	§1.1310 Table 1 (b)	na	na	Pass



Referenced Standard: IC RSS-133

B	Conducted RF Output Power	ANSI/TIA/EIA-603-C	RSS-133 §6.2	30Mar05	30Mar05	Pass
E	Effective Isotropic Radiated Power	ANSI/TIA/EIA-603-C	RSS-133 §6.2	11Apr05	11Apr05	Pass
F	Radiated Spurious Emissions	ANSI/TIA/EIA-603-C	RSS-133 §6.3	1Apr05	19Apr05	Pass
G	Maximum Permissible Exposure	FCC CFR 47 § 2.1091 IEEE Std C95.1-1999	§1.1310 Table 1 (b)	na	na	Pass

REVISION LOG

Issue	Description	Implemented By	Implementation Date
1.0	Initial Release	Jon Hughes	09May05

SIGNATORIES

Prepared By:		May 09, 2005
Name/Title	Duane M. Friesen, C.E.T. / EMC Manager	Date
Approved By:		May 09, 2005
Name/Title	Jon Hughes / General Manager	Date

Applicant:	Itronix Corporation	FCC ID:	KBCIX260PROA580BT	IC ID:	1943A-IX260Pf	
Rugged Laptop PC with Sierra Wireless AirCard 580 Dual-Band CDMA Modem			Model:	IX260PROA580BT		
2005 Celltech Labs Inc. This document is not to be reproduced in whole or in part without the written permission of Celltech Labs Inc.						5 of 50

Test Report Serial No.:	022305KBC-T618-E24C	Issue 1
Test Date(s):	30Mar05 - 19Apr05	
Test Standard(s):	FCC §2, §22H, §24E	IC RSS-132/133
Lab Registration(s):	FCC #714830	IC Lab File #3874

1.0 SCOPE

This report outlines the measurements made and results collected during electromagnetic emissions testing of the Itronix Corporation Model: IX260PROA580BT Rugged Laptop PC with the internal Sierra Wireless AirCard 580 Dual-Band CDMA PCMCIA Modem. The Dual-Band CDMA Modem was connected to an external swivel dipole antenna located on the upper right side edge of the LCD display. The Laptop PC also has the option of being mounted in a vehicle cradle utilizing a vehicle-mount antenna. The measurement results were applied against the applicable EMC requirements and limits outlined in the technical rules and regulations set forth in the Federal Communication Commission Code of Federal Regulations Title 47 Parts 2, 22 Subpart H, and 24 Subpart E; and Industry Canada Radio Standards Specifications RSS-132 Issue 1 (Provisional), and RSS-133 Issue 2.

2.0 REFERENCES

2.1 Normative References

ANSI/ISO 17025:1999	General Requirements for competence of testing and calibration laboratories
IEEE/ANSI C63.4:2003	Methods of Measurement of Radio-Noise Emissions from Low-Voltage Electrical and Electronic Equipment in the Range of 9 kHz to 40 GHz
IEEE/ANSI Std C95.1:1999	American National Standard Safety Levels with Respect to Human Exposure to Radio Frequency Electromagnetic Fields
ANSI/TIA/EIA-603-C:2004	Land Mobile FM or PM Communication Equipment Measurement and Performance Standards
CFR Title 47 Part 2:2004	Code of Federal Regulations Title 47: Telecommunication Part 2: Frequency Allocations and Radio Treaty Matters; General Rules and Regulations Part 22: Public Mobile Services Part 24: Personal Communication Services
IC Spectrum Management & Telecommunications Policy	Radio Standards Specification RSS-102 Issue 1 (Provisional) - Evaluation Procedure for Mobile and Portable Radio Transmitters with respect to Health Canada's Safety Code 6 for Exposure of Humans to Radio Frequency Fields RSS-132 Issue 1 (Provisional) - 800 MHz Cellular Telephones Employing New Technologies RSS-133 Issue 2, Revision 1 - Personal Communication Services

Test Report Serial No.:	022305KBC-T618-E24C	Issue 1
Test Date(s):	30Mar05 - 19Apr05	
Test Standard(s):	FCC §2, §22H, §24E	IC RSS-132/133
Lab Registration(s):	FCC #714830	IC Lab File #3874

3.0 TERMS AND DEFINITIONS

AVG	Average
CDMA	Code Division Multiple Access
CFR	Code of Federal Regulations
dB	decibel
dBm	dB referenced to 1 mW
dBuV	dB referenced to 1 uV
DUT	Device under Test
dBc	dB down from carrier
EBW	Emission Bandwidth
EIRP	Effective Isotropic Radiated Power
ERP	Effective Radiated Power
EMC	Electromagnetic Compatibility
FCC	Federal Communication Commission
FHSS	Frequency Hopping Spread Spectrum
HP	Hewlett Packard
HPF	High Pass Filter
Hpol	Horizontal Polarization
Hz	Hertz
IC	Industry Canada
IX260+	Itronix Model IX260PROA580BT Laptop PC
kHz	kilohertz
LNA	Low Noise Amplifier
m	meter
MHz	Megahertz
Mbps	megabits per second
na	not applicable
n/a	not available
PCS	Personal Communication System
PK	Peak
PPSD	Peak Power Spectral Density
QP	Quasi-peak
RBW	Resolution Bandwidth
R&S	Rohde & Schwarz
RSS	Radio Standard Specification
SA	Spectrum Analyzer
VBW	Video Bandwidth
Vpol	Vertical Polarization
WLAN	Wireless Local Area Network

Test Report Serial No.:	022305KBC-T618-E24C	Issue 1
Test Date(s):	30Mar05 - 19Apr05	
Test Standard(s):	FCC §2, §22H, §24E	IC RSS-132/133
Lab Registration(s):	FCC #714830	IC Lab File #3874

4.0 FACILITIES AND ACCREDITATIONS

The facilities used in collecting the test results outlined in this report are located at 1955 Moss Court, Kelowna, British Columbia, Canada, V1Y 9L3. The radiated and conducted emissions sites conform with the requirements set forth in ANSI C63.4 and are filed and listed with the FCC under Registration Number 714830 and Industry Canada under File Number IC 3874.

5.0 GENERAL INFORMATION

5.1 Applicant Information

Company Name:	Itronix Corporation
Address:	801 South Stevens Street Spokane, WA 99204 United States

5.2 DUT Description

The DUT consisted of the IX260PROA580BT Rugged Laptop PC containing a Sierra Wireless AirCard 580 Dual-Band CDMA PCMCIA Modem connected to an External Swivel Dipole Antenna located on the upper right side edge of the LCD display. The Laptop PC also has the option of being mounted in a vehicle cradle utilizing the MaxRad Vehicle-Mount Antenna. Photographs of the DUT placement and construction are shown in Appendix A.

Device:	Rugged Laptop PC		
Model:	IX260PROA580BT		
Serial Number(s):	ZZGEG4196ZZ6480		
Identifier(s):	FCC ID:	KBCIX260PROA580BT	IC ID: 1943A-IX260Pf
Power Source(s):	Delta Electronics 90 Watt AC-DC Power Supply (Model ADP-90AB Rev B)		
	11.1 V Lithium-ion Battery, 6.0 Ah (Model: A2121-2)		
	12 V Vehicle Battery (for Vehicle Cradle)		

Device:	Dual-Band PCS/Cellular CDMA PCMCIA Modem		
Model:	Sierra Wireless AirCard 580		
Serial Number:	60209FB5		
Rule Part(s):	FCC:	§1.1310 Table 1(b); §2.1091; §22.913; §22.917; §24.232(b); §24.238	
	IC:	RSS-132 Issue 1 (Provisional); RSS-133 Issue 2	
Classification(s):	FCC:	PCS Licensed Transmitter (PCB)	
	IC:	800 MHz Cellular Telephones employing New Technologies (RSS-132)	
		2 GHz Personal Communication Services (RSS-133)	
Power Source:	Powered from the internal PC power supply		

Applicant:	Itronix Corporation	FCC ID:	KBCIX260PROA580BT	IC ID:	1943A-IX260Pf	
Rugged Laptop PC with Sierra Wireless AirCard 580 Dual-Band CDMA Modem				Model:	IX260PROA580BT	
2005 Celltech Labs Inc. This document is not to be reproduced in whole or in part without the written permission of Celltech Labs Inc.						8 of 50

Test Report Serial No.:	022305KBC-T618-E24C	Issue 1
Test Date(s):	30Mar05 - 19Apr05	
Test Standard(s):	FCC §2, §22H, §24E	IC RSS-132/133
Lab Registration(s):	FCC #714830	IC Lab File #3874

Device:	External Swivel Dipole Antenna (upper right side edge of LCD display)
Model:	IX260+
Gain:	+2.6 dBi

Device:	IX260+ Vehicle Cradle
Part Number:	60-0103-001
Serial Number:	ZZABQ1288ZZ0006

Device:	MaxRad Vehicle-Mount Antenna (with attached cable)
Part Number:	WMLPVDB800/1900
Gain:	+3 dBi

5.3 Co-Located Equipment

Name:	GPS Receiver Module with attached Antenna (Receive only)
Model:	Leadtek P/N: GPS9547

5.4 Cable Descriptions

ROUTING		Length m	Model	Terminations		Shield Type	Shield Termination		Suppression
From	To			End 1	End 2		End 1	End 2	
PC modem port	Unterminated	1.0	n/a	RJ-11	RJ-11	None	na	na	None
PC Ethernet Port	Ethernet Hub	1.0	n/a	RJ-45	RJ-45	None	na	na	None

Test Report Serial No.:	022305KBC-T618-E24C	Issue 1
Test Date(s):	30Mar05 - 19Apr05	
Test Standard(s):	FCC §2, §22H, §24E	IC RSS-132/133
Lab Registration(s):	FCC #714830	IC Lab File #3874

5.5 Support Equipment

The following equipment was used in support of the DUT.

Co-located Support Equipment List		
Manufacturer	Model	Description
D-Link	DE-809TC/	Ethernet hub
YNG YUH	YP-040	Hub power supply
Polk Audio	n/a	Speakers
Polk Audio	n/a	Speaker-microphone
DeLorme	Tripmate	GPS Receiver
Intel	CS-430	Camera
Logitech	M-S34	Mouse

5.6 Clock Frequencies

5.6.1 DUT Clock Frequencies

Device:	Rugged Laptop PC
Clocks:	1.6 GHz processor
Device:	Dual-Band PCS/Cellular CDMA PCMCIA Modem
Clocks:	n/a
Device:	Vehicle Cradle
Clocks:	None
Device:	Swivel Dipole Antenna
Clocks:	None
Device:	Vehicle-Mount Antenna
Clocks:	None

5.6.2 Co-Located Clock Frequencies

Device:	Peripherals
Clocks:	n/a

Test Report Serial No.:	022305KBC-T618-E24C	Issue 1
Test Date(s):	30Mar05 - 19Apr05	
Test Standard(s):	FCC §2, §22H, §24E	IC RSS-132/133
Lab Registration(s):	FCC #714830	IC Lab File #3874

5.7 Mode(s) of Operation Tested

5.7.1 Dual-Band CDMA Modem

Customer supplied software was used to set the CDMA Modem to the appropriate channel and power level for the specific measurement or a CDMA test set was used to transmit a signal close to the DUT and initiate a call on the appropriate channel. Measurements were made with the CDMA modem set to the low, mid and high channel in each band or on a worst-case channel for the measurement, as determined by prescan evaluations. The following settings were used for each channel.

5.7.1.1 Cellular CDMA

TX Frequency Range:	824.70 - 848.31 MHz Ch. 1013 (824.700 MHz) (low), Ch. 384 (836.52 MHz) (mid) & Ch. 777 (848.310 MHz) (high) measured unless otherwise noted
Software Power Gain Settings:	Set by manufacturer software or CDMA test set communications for "all ups"
Modulation Type(s):	QPSK

5.7.1.2 PCS CDMA

TX Frequency Range:	1851.25 - 1908.75 MHz Ch. 25 (1851.25 MHz) (low), Ch 600 (1880 MHz) (mid) & Ch. 1175 (1908.75 MHz) (high) measured unless otherwise noted
Software Power Gain Settings:	Set by manufacturer software or CDMA test set communications for "all ups"
Modulation Type(s):	QPSK

5.7.2 DUT Exercising Software Description

The DUT was configured and exercised during the RF conducted output power measurements using customer supplied test software "Directed Test Version 2.8", that allowed an operator to place the Dual-Band CDMA modem in an "all ups" mode. The modem manufacturer described this mode as one in which the modem transmitted at its maximum power level. For all radiated testing, the "all ups" mode was initiated with a call being connected with a CDMA test set through an antenna placed near the DUT.

Test Report Serial No.:	022305KBC-T618-E24C	Issue 1
Test Date(s):	30Mar05 - 19Apr05	
Test Standard(s):	FCC §2, §22H, §24E	IC RSS-132/133
Lab Registration(s):	FCC #714830	IC Lab File #3874

5.8 Configuration Description

The DUT was configured, as described by the client as being representative of what would be delivered to a final customer. Because the swivel dipole antenna orientation could be user configured, prescan evaluations were made to determine the configuration that resulted in the highest emissions. A “horizontal, pointing back” orientation was used for both cellular and PCS bands. More specific details may be included in each appendix.

5.8.1 Configuration Justification

The DUT was tested in a configuration described by the client as being typical of normal use. The system could be utilized as a standalone Laptop PC as well as installed in a vehicle cradle utilizing a vehicle-mount antenna. Both configurations were investigated and the results reported herein.

6.0 PASS/FAIL CRITERIA

Unless otherwise noted in the Appendices, the pass/fail criteria is the limit set forth in the reference standards. A DUT is considered to have passed the requirements, if the data collected during the described measurement procedure is within the specified limits as defined. The pass/fail statements made in this report only apply to the unit tested.

Test Report Serial No.:	022305KBC-T618-E24C	Issue 1
Test Date(s):	30Mar05 - 19Apr05	
Test Standard(s):	FCC §2, §22H, §24E	IC RSS-132/133
Lab Registration(s):	FCC #714830	IC Lab File #3874

APPENDICES

Applicant:	Itronix Corporation	FCC ID:	KBCIX260PROA580BT	IC ID:	1943A-IX260Pf	
	Rugged Laptop PC with Sierra Wireless AirCard 580 Dual-Band CDMA Modem	Model:	IX260PROA580BT			
2005 Celltech Labs Inc. This document is not to be reproduced in whole or in part without the written permission of Celltech Labs Inc.						13 of 50

Test Report Serial No.:	022305KBC-T618-E24C	Issue 1
Test Date(s):	30Mar05 - 19Apr05	
Test Standard(s):	FCC §2, §22H, §24E	IC RSS-132/133
Lab Registration(s):	FCC #714830	IC Lab File #3874

Appendix A - Photographs

A.1. DUT PHOTOGRAPHS

Photograph A.1-1 - Rugged Laptop PC Open - front



Photograph A.1-2 - Rugged Laptop PC Open - right side



Photograph A.1-3 - DUT in Vehicle Cradle with Vehicle-Mount Antenna - front



Photograph A.1-4 - DUT in Vehicle Cradle with Vehicle-Mount Antenna - back



Test Report Serial No.:	022305KBC-T618-E24C	Issue 1
Test Date(s):	30Mar05 - 19Apr05	
Test Standard(s):	FCC §2, §22H, §24E	IC RSS-132/133
Lab Registration(s):	FCC #714830	IC Lab File #3874

Photograph A.1-5 - Dual-Band CDMA PCMCIA Modem



Photograph A.1-6 - CDMA Modem installed in DUT



Photograph A.1-7 - AirCard 580 Dual-Band CDMA Modem



Antenna RF Port (note: modem manufacturer's factory antenna is disabled when RF cable is connected to RF port)

Applicant:	Itronix Corporation	FCC ID:	KBCIX260PROA580BT	IC ID:	1943A-IX260Pf	
Rugged Laptop PC with Sierra Wireless AirCard 580 Dual-Band CDMA Modem			Model:	IX260PROA580BT		
2005 Celltech Labs Inc. This document is not to be reproduced in whole or in part without the written permission of Celltech Labs Inc.						15 of 50

Test Report Serial No.:	022305KBC-T618-E24C	Issue 1
Test Date(s):	30Mar05 - 19Apr05	
Test Standard(s):	FCC §2, §22H, §24E	IC RSS-132/133
Lab Registration(s):	FCC #714830	IC Lab File #3874

Appendix B - CDMA Conducted RF Output Power Measurement

B.1. REFERENCES

Normative Reference Standard	FCC CFR 47 §2.1046
Procedure Reference	FCC CFR 47 §2.1046

B.2. LIMITS

FCC CFR 47 §2.1046 (a)	For transmitters other than single sideband, independent sideband and controlled carrier radiotelephone, power output shall be measured at the RF output terminals when the transmitter is adjusted in accordance with the tune-up procedures to give the values of current and voltage on the circuit elements specified in §2.1033(c) (8).
*ERP and EIRP limits are specified in Appendix C and E.	

B.3. ENVIRONMENTAL CONDITIONS

Temperature	25.2 +/- 2 °C
Humidity	35 +/- 2 %
Barometric Pressure	96.34 kPa

B.4. EQUIPMENT LIST

ASSET NUMBER	MANUFACTURER	MODEL	DESCRIPTION	LAST CAL	CAL DUE
00008	Gigatronics	8652A	Power Meter	30Apr04	30Apr05
00011	Gigatronics	80701A	Power Sensor	08Oct04	08Oct05
00107	HP	8491C	Attenuator	n/a	n/a

*Cable and attenuator verified with power meter prior to use

Test Report Serial No.:	022305KBC-T618-E24C	Issue 1
Test Date(s):	30Mar05 - 19Apr05	
Test Standard(s):	FCC §2, §22H, §24E	IC RSS-132/133
Lab Registration(s):	FCC #714830	IC Lab File #3874

B.5. MEASUREMENT EQUIPMENT SETUP

Measurement Equipment Connections	The equipment was connected as shown in the setup drawing in B.6.
Measurement Equipment Settings	Power Meter Settings: Mode - MAP Frequency compensation set for carrier frequency Offset set appropriately to compensate for any attenuator or cable losses
Measurement Procedure	The RF conducted power levels for both PCS and cellular bands were measured at the DUT antenna connector port using a Gigatronics 8652A Universal Power Meter in mean average power mode. An offset was entered into the power meter to correct for the losses of the attenuator and cable installed between the output port and the power sensor input. The DUT test software was used to set it to transmit in the CDMA "always up" power control mode.

B.6. SETUP DRAWING

Figure B.6-1 - Setup Drawing

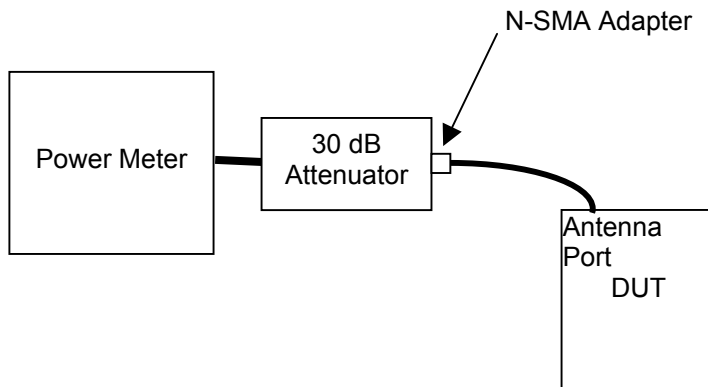

Test Report Serial No.:	022305KBC-T618-E24C	Issue 1
Test Date(s):	30Mar05 - 19Apr05	
Test Standard(s):	FCC §2, §22H, §24E	IC RSS-132/133
Lab Registration(s):	FCC #714830	IC Lab File #3874

B.7. DUT OPERATING DESCRIPTION

Power measurements were made for each channel in both the cellular and PCS bands, with the CDMA modem set appropriately as described in section 5.7.

B.8. TEST RESULTS

Mode	Channel	Frequency	Conducted Power
Cellular CDMA	1013	824.70 MHz	+23.41 dBm
	384	836.52 MHz	+23.39 dBm
	777	848.31 MHz	+23.61 dBm
PCS CDMA	25	1851.25 MHz	+24.41 dBm
	600	1880.00 MHz	+25.07 dBm
	1175	1908.75 MHz	+24.62 dBm

B.9. PASS/FAIL

There is no pass/fail criterion for this measurement. The ERP and EIRP values applied to appropriate regulatory requirements are outlined in Appendix C and E.

B.10. SIGN-OFF

I attest to the accuracy of the data. All measurements reported herein were performed by me and are correct to the best of my knowledge and belief. I assume full responsibility for the completeness of these measurements.



Russell Pipe
Senior Compliance Technologist
Celltech Labs Inc.

30Mar05

Date

Test Report Serial No.:	022305KBC-T618-E24C	Issue 1
Test Date(s):	30Mar05 - 19Apr05	
Test Standard(s):	FCC §2, §22H, §24E	IC RSS-132/133
Lab Registration(s):	FCC #714830	IC Lab File #3874

Appendix C - Effective Radiated Power Measurement

C.1. REFERENCES	
Normative Reference Standard	FCC CFR 47 §22.913 (a)
Procedure Reference	ANSI/TIA/EIA-603-C

C.2. LIMITS	
FCC CFR 47 §22.913 (a)	(a) Maximum ERP. The ERP of mobile transmitters and auxiliary transmitters must not exceed 7 Watts.

C.3. ENVIRONMENTAL CONDITIONS	
Temperature	27.4 +/- 2 °C
Humidity	33 +/- 2 %
Barometric Pressure	96.24 +/- 0.2 kPa

C.4. EQUIPMENT LIST						
RECEIVING EQUIPMENT						
ID	ASSET NUMBER	MANUFACTURER	MODEL	DESCRIPTION	LAST CAL	CAL DUE
1	00072	EMCO	2075	Mini-mast	na	na
2	00073	EMCO	2080	Turn Table	na	na
3	00071	EMCO	2090	Multi-Device Controller	na	na
4	00050	Chase	CBL-6111A	Bilog Antenna	08Feb05	08Feb06
5	00015	Agilent	E4408B	Spectrum Analyzer	24Jan05	24Jan06
6	00120	Celltech	n/a	Microwave Cable (RX)	25Mar05	25Mar06
7	00121	Andrew	FSJ4-50B	Microwave Cable (RX)	25Mar05	25Mar06
8	00130	Andrew	FSJ1-50A	Microwave Cable (RX)	25Mar05	25Mar06
ADDITIONAL SUBSTITUTION EQUIPMENT						
ID	ASSET NUMBER	MANUFACTURER	MODEL	DESCRIPTION	LAST CAL	CAL DUE
9	00059	ETS	3121C	Roberts Dipole	04Dec03	04Dec05
10	00131	Andrew	FSJ1-50A	Microwave Cable (TX)	na	na
11	00127	Andrew	FSJ4-50B	Microwave Cable (TX)	na	na
12	00131	Andrew	FSJ1-50A	Microwave Cable (TX)	na	na
13	00031	HP	E8285A	CDMA Test set	na	na
14	00007	Gigatronics	8652A	Power Meter	18Oct04	18Oct05
15	00011	Gigatronics	80701A	Power Sensor	08Oct04	08Oct05
16	00013	Gigatronics	80701A	Power Sensor	11Oct04	11Oct05
17	00102	Pasternack	PE7015-3110	30 dB attenuator	na*	na*
18	00114	Amplifier Research	DC7154	Directional Coupler	na*	na*

*Attenuation offset in power meter setup

Applicant:	Itronix Corporation	FCC ID:	KBCIX260PROA580BT	IC ID:	1943A-IX260Pf	
Rugged Laptop PC with Sierra Wireless AirCard 580 Dual-Band CDMA Modem				Model:	IX260PROA580BT	
2005 Celltech Labs Inc. This document is not to be reproduced in whole or in part without the written permission of Celltech Labs Inc.						19 of 50

C.5. MEASUREMENT EQUIPMENT SETUP

MEASUREMENT EQUIPMENT CONNECTIONS	The measurement equipment was connected as shown in C.6.			
MEASUREMENT EQUIPMENT SETTINGS	The spectrum analyzer was set to the following settings:			
	Frequency Range	RBW	VBW	Detector
	MHz	kHz	kHz	
	< 1000	100	100	

C.6. SETUP DRAWING

Figure C.6-1 - Field Strength Setup Drawing

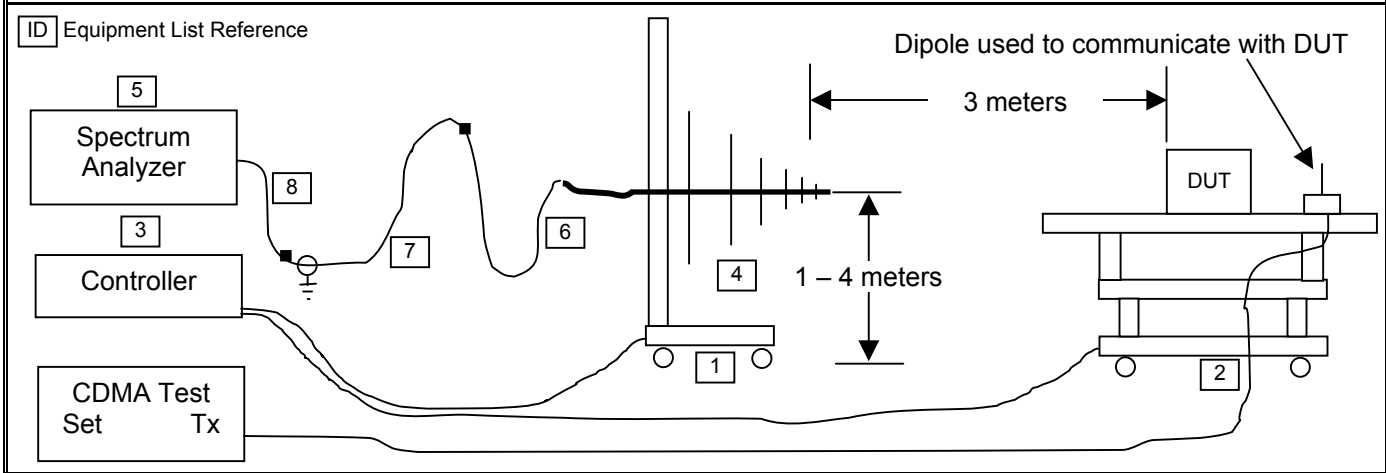
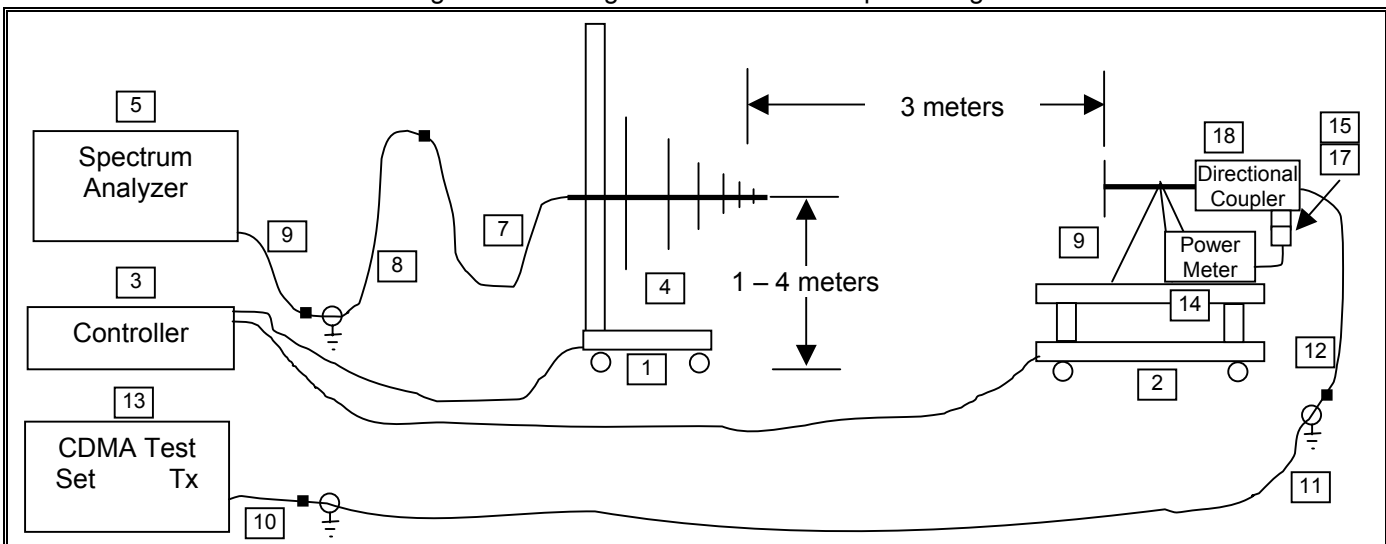

Figure C.6-2 - Signal Substitution Setup Drawing



Test Report Serial No.:	022305KBC-T618-E24C	Issue 1
Test Date(s):	30Mar05 - 19Apr05	
Test Standard(s):	FCC §2, §22H, §24E	IC RSS-132/133
Lab Registration(s):	FCC #714830	IC Lab File #3874

C.7. SETUP PHOTOGRAPHS

Photograph C.7-1 - DUT Swivel Dipole Antenna with Horizontal Bilog Receive Antenna Setup



Photograph C.7-2 - DUT Vehicle Antenna & Cradle with Vertical Bilog Receive Antenna Setup



Applicant:	Itronix Corporation	FCC ID:	KBCIX260PROA580BT	IC ID:	1943A-IX260Pf	
	Rugged Laptop PC with Sierra Wireless AirCard 580 Dual-Band CDMA Modem			Model:	IX260PROA580BT	
2005 Celltech Labs Inc. This document is not to be reproduced in whole or in part without the written permission of Celltech Labs Inc.						21 of 50

Test Report Serial No.:	022305KBC-T618-E24C	Issue 1
Test Date(s):	30Mar05 - 19Apr05	
Test Standard(s):	FCC §2, §22H, §24E	IC RSS-132/133
Lab Registration(s):	FCC #714830	IC Lab File #3874

Photograph C.7-3 - Front of Radiated Emissions Setup with attached swivel dipole antenna



Photograph C.7-4 - Front of Radiated Emissions Setup with vehicle-mount antenna and cradle

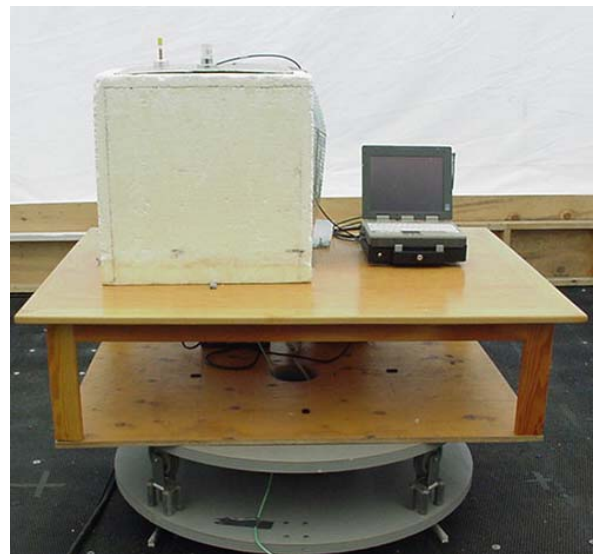

Photograph C.7-5 - Back of Radiated Emissions Setup with attached swivel dipole antenna

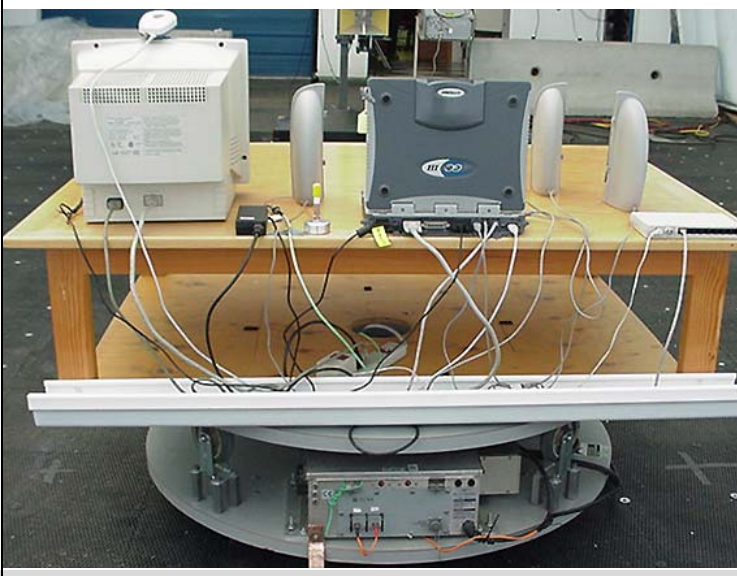

Photograph C.7-6 - Back of Radiated Emissions Setup with vehicle-mount antenna and cradle



C.8. DUT OPERATING DESCRIPTION

Measurements were made for the low, mid and high CDMA channels transmitting in the cellular band at maximum power levels as described in Section 5 of this report. Each antenna configuration (attached swivel dipole and vehicle-mount) was evaluated.

Applicant:	Itronix Corporation	FCC ID:	KBCIX260PROA580BT	IC ID:	1943A-IX260Pf	
	Rugged Laptop PC with Sierra Wireless AirCard 580 Dual-Band CDMA Modem			Model:	IX260PROA580BT	
2005 Celltech Labs Inc. This document is not to be reproduced in whole or in part without the written permission of Celltech Labs Inc.						22 of 50

C.9. TEST RESULTS

C.9.1. Dipole Antenna Carrier Power Levels



Project Number: 022305KBC-T617
Company: Itronix
Product: IX260PNL3AC580

Standard: FCC22.913
Test Start Date: 11-Apr-05
Test End Date: 11-Apr-05

Attached Dipole Antenna

Polarity	Distance m	Substitution Antenna Type	Carrier	Frequency	Corrected Field Strength	Substituted SA Signal Level (uncorrected)	Power Applied to Antenna	Antenna Gain	Carrier ERP Level		ERP Limit		Margin dB	Pass/Fail
				MHz	dBuV/m	dBuV	dBm	dBd	dBm	Watts	dBm	Watts		
H	3	B_3121C	1013	824.70	157.77	132.54	24.37	-0.84	23.53	0.225	38.45	7.00	14.92	PASS
H	3	B_3121C	384	836.52	157.63	131.97	23.70	-0.70	23.00	0.199	38.45	7.00	15.45	PASS
H	3	B_3121C	777	848.31	158.36	132.19	24.66	-0.56	24.10	0.257	38.45	7.00	14.35	PASS
V	3	B_3121C	1013	824.70	153.43	128.20	22.03	-0.84	21.19	0.131	38.45	7.00	17.26	PASS
V	3	B_3121C	384	836.52	152.94	127.28	22.26	-0.70	21.56	0.143	38.45	7.00	16.89	PASS
V	3	B_3121C	777	848.31	154.27	128.10	22.70	-0.56	22.14	0.164	38.45	7.00	16.31	PASS

Note:
Dipole Antenna used for substitution

Formulae:
ERP Level (dBm) = Power applied to Antenna (dBm) + Antenna Gain (dBi) - 2.14
Margin (dB) = Limit (dBm) - Level (dBm)

C.9.2. Vehicle Antenna Carrier Power Levels



Project Number: 022305KBC-T617
Company: Itronix
Product: IX260PNL3AC580

Standard: FCC22.913
Test Start Date: 11-Apr-05
Test End Date: 11-Apr-05

Mobile Antenna

Polarity	Distance m	Substitution Antenna Type	Carrier	Frequency	Corrected Field Strength	Substituted SA Signal Level (uncorrected)	Power Applied to Antenna	Antenna Gain	Carrier ERP Level		ERP Limit		Margin dB	Pass/Fail
				MHz	dBuV/m	dBuV	dBm	dBd	dBm	Watts	dBm	Watts		
H	3	B_3121C	1013	824.70	112.20	86.97	11.93	-0.84	11.09	0.013	38.45	7.00	27.36	PASS
H	3	B_3121C	384	836.52	111.68	86.02	11.71	-0.70	11.01	0.013	38.45	7.00	27.44	PASS
H	3	B_3121C	777	848.31	111.69	85.52	11.75	-0.56	11.19	0.013	38.45	7.00	27.26	PASS
V	3	B_3121C	1013	824.70	119.42	94.19	22.20	-0.84	21.36	0.137	38.45	7.00	17.09	PASS
V	3	B_3121C	384	836.52	119.53	93.87	22.94	-0.70	22.24	0.167	38.45	7.00	16.21	PASS
V	3	B_3121C	777	848.31	120.19	94.02	22.83	-0.56	22.27	0.169	38.45	7.00	16.18	PASS

Note:
Dipole Antenna used for substitution

Formulae:
ERP Level (dBm) = Power applied to Antenna (dBm) + Antenna Gain (dBi) - 2.14
Margin (dB) = Limit (dBm) - Level (dBm)

Test Report Serial No.:	022305KBC-T618-E24C	Issue 1
Test Date(s):	30Mar05 - 19Apr05	
Test Standard(s):	FCC §2, §22H, §24E	IC RSS-132/133
Lab Registration(s):	FCC #714830	IC Lab File #3874

C.10. PASS/FAIL

In reference to the results outlined in C.9, the DUT passes the requirements as stated in the reference standards as follows:

FCC 22.913 (a) Maximum ERP. The ERP of mobile transmitters and auxiliary transmitters must not exceed 7 Watts.

A maximum ERP of 24.10 dBm (0.257 Watts) was measured when Channel 777 was transmitting through the attached swivel dipole antenna. A maximum ERP of 22.27 dBm (0.169 Watts) was measured when Channel 777 was transmitting through the vehicle-mount antenna.

C.11. SIGN-OFF

I attest to the accuracy of the data. All measurements reported herein were performed by me and are correct to the best of my knowledge and belief. I assume full responsibility for the completeness of these measurements.



Russell Pipe
Senior Compliance Technologist
Celltech Labs Inc.

11Apr05

Date

Applicant:	Itronix Corporation	FCC ID:	KBCIX260PROA580BT	IC ID:	1943A-IX260Pf	
	Rugged Laptop PC with Sierra Wireless AirCard 580 Dual-Band CDMA Modem	Model:	IX260PROA580BT			
2005 Celltech Labs Inc. This document is not to be reproduced in whole or in part without the written permission of Celltech Labs Inc.						24 of 50

Test Report Serial No.:	022305KBC-T618-E24C	Issue 1
Test Date(s):	30Mar05 - 19Apr05	
Test Standard(s):	FCC §2, §22H, §24E	IC RSS-132/133
Lab Registration(s):	FCC #714830	IC Lab File #3874

Appendix D - Cellular Radiated Spurious Emissions Measurement

D.1. REFERENCES	
Normative Reference Standard	FCC CFR 47 §22.917(a)
Procedure Reference	ANSI/TIA/EIA-603-C; FCC CFR 47 §22.917(b)

D.2. LIMITS	
FCC CFR 47 §22.917	<i>(e) Out of Band Emissions. The mean power of emissions must be attenuated below the mean power of the unmodulated carrier (P) on any frequency twice or more than twice the fundamental frequency by: at least 43 + 10 log P dB</i>

D.3. ENVIRONMENTAL CONDITIONS	
Temperature	27.4 +/- 2 °C
Humidity	33 +/- 2 %
Barometric Pressure	96.24 +/- 0.2 kPa

D.4. EQUIPMENT LIST						
RECEIVING EQUIPMENT						
ID	ASSET NUMBER	MANUFACTURER	MODEL	DESCRIPTION	LAST CAL	CAL DUE
1	00072	EMCO	2075	Mini-mast	na	na
2	00073	EMCO	2080	Turn Table	na	na
3	00071	EMCO	2090	Multi-Device Controller	na	na
4	00031	HP	E8285A	CDMA Test set	na	na
5	00035	ETS	3115	Horn Antenna (RX)	24Mar04	24Mar06
6	00015	Agilent	E4408B	Spectrum Analyzer	24Jan05	24Jan06
7	00120	Celltech	n/a	Microwave Cable (RX)	25Mar05	25Mar06
8	00121	Andrew	FSJ4-50B	Microwave Cable (RX)	25Mar05	25Mar06
9	00130	Andrew	FSJ1-50A	Microwave Cable (RX)	25Mar05	25Mar06
10	00115	Miteq	JS4-00102600-35-5A	Low Noise Amplifier	28Dec04	28Dec05
11	00093	Microtronics	HPM50111	High Pass Filter	8Jun04	8Jun05
12	00043	Microwave Circuits	H02G18G1	High Pass Filter	8Jun04	8Jun05
13	00119	INMAT	18AH-10	10dB attenuator	8Jun04	8Jun05

Applicant:	Itronix Corporation	FCC ID:	KBCIX260PROA580BT	IC ID:	1943A-IX260Pf	
Rugged Laptop PC with Sierra Wireless AirCard 580 Dual-Band CDMA Modem				Model:	IX260PROA580BT	
2005 Celltech Labs Inc. This document is not to be reproduced in whole or in part without the written permission of Celltech Labs Inc.						25 of 50

Test Report Serial No.:	022305KBC-T618-E24C	Issue 1
Test Date(s):	30Mar05 - 19Apr05	
Test Standard(s):	FCC §2, §22H, §24E	IC RSS-132/133
Lab Registration(s):	FCC #714830	IC Lab File #3874

ADDITIONAL SUBSTITUTION EQUIPMENT						
ID	ASSET NUMBER	MANUFACTURER	MODEL	DESCRIPTION	LAST CAL	CAL DUE
14	00142	HP	8491A	20 dB attenuator	n/a*	n/a*
15	00034	ETS	3115	Horn Antenna (TX)	24Mar04	24Mar06
16	00131	Andrew	FSJ1-50A	Microwave Cable (TX)	n/a	n/a
17	00127	Andrew	FSJ4-50B	Microwave Cable (TX)	n/a	n/a
18	00131	Andrew	FSJ1-50A	Microwave Cable (TX)	n/a	n/a
19	00006	R & S	SMR-20	Signal Generator	30Apr04	30Apr05
20	00007	Gigatronics	8652A	Power Meter	18Oct04	18Oct05
21	00011	Gigatronics	80701A	Power Sensor	08Oct04	08Oct05
22	00013	Gigatronics	80701A	Power Sensor	11Oct04	11Oct05
23	00102	Pasternack	PE7015-3110	30 dB attenuator	n/a*	n/a*
24	00078	Pasternack	PE2214-20	Directional Coupler	n/a*	n/a*

* Attenuation offset in power meter setup

D.5. MEASUREMENT EQUIPMENT SETUP					
MEASUREMENT EQUIPMENT CONNECTIONS	The measurement equipment was connected as shown in D.6. A number of measurement equipment configurations were used to cover the applicable frequency ranges. The configurations for each range are as follows:				
	Frequency Range	LNA Asset #	Filter/Attenuator Asset #	Rx Antenna Asset #	Tx Antenna Asset #
	1 GHz – 2 GHz	00115	00043 & 00119	00035	00034
	2 GHz – 18 GHz	00115	00093	00035	00034
18 GHz – 20 GHz	00115	none	80001	80002	
MEASUREMENT EQUIPMENT SETTINGS	The spectrum analyzer was set to the following settings:				
	Frequency Range	RBW	VBW	Detector	
	MHz	kHz	kHz		
≥ 1000	1000	1000	Peak		

Applicant:	Itronix Corporation	FCC ID:	KBCIX260PROA580BT	IC ID:	1943A-IX260Pf	
Rugged Laptop PC with Sierra Wireless AirCard 580 Dual-Band CDMA Modem				Model:	IX260PROA580BT	
2005 Celltech Labs Inc. This document is not to be reproduced in whole or in part without the written permission of Celltech Labs Inc.						26 of 50

Test Report Serial No.:	022305KBC-T618-E24C	Issue 1
Test Date(s):	30Mar05 - 19Apr05	
Test Standard(s):	FCC §2, §22H, §24E	IC RSS-132/133
Lab Registration(s):	FCC #714830	IC Lab File #3874

D.6. SETUP DRAWING

Figure D.6-1 - Field Strength Setup Drawing

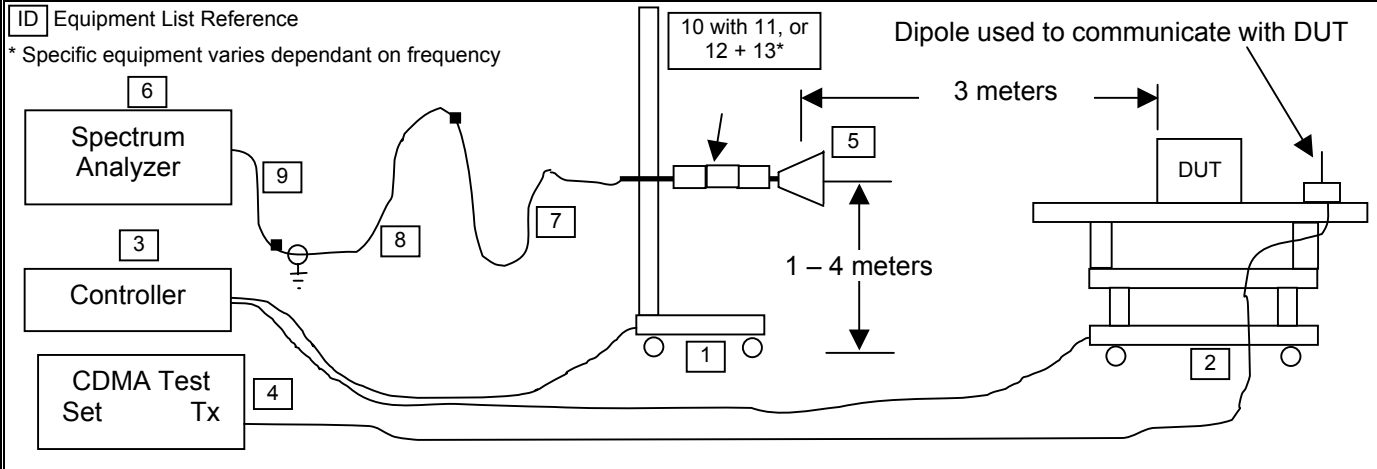
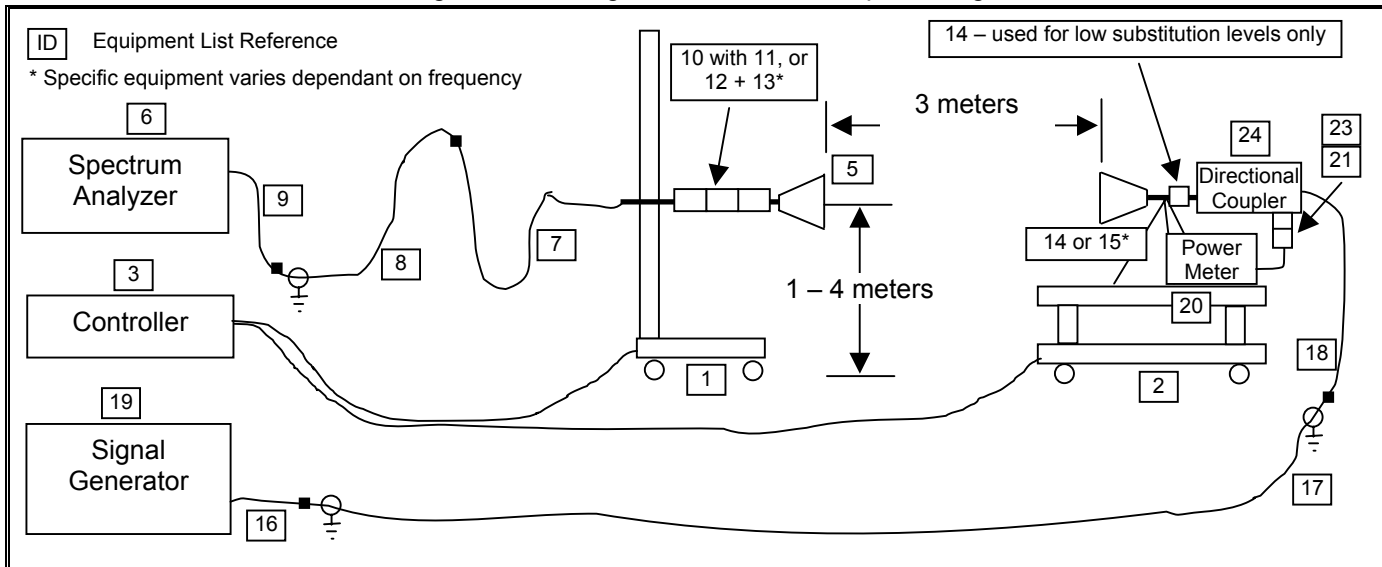

Figure D.6-2 - Signal Substitution Setup Drawing



Test Report Serial No.:	022305KBC-T618-E24C	Issue 1
Test Date(s):	30Mar05 - 19Apr05	
Test Standard(s):	FCC §2, §22H, §24E	IC RSS-132/133
Lab Registration(s):	FCC #714830	IC Lab File #3874

D.7. SETUP PHOTOGRAPHS

Photograph D.7-1 - DUT with Dipole Antenna, Horizontal 3115 Horn and LNA



Photograph D.7-2 - DUT with Dipole Antenna, Vertical 3115 Horn and LNA



Photograph D.7-3 - Front of Radiated Emission Setup



Photograph D.7-4 - Back of Radiated Emission Setup

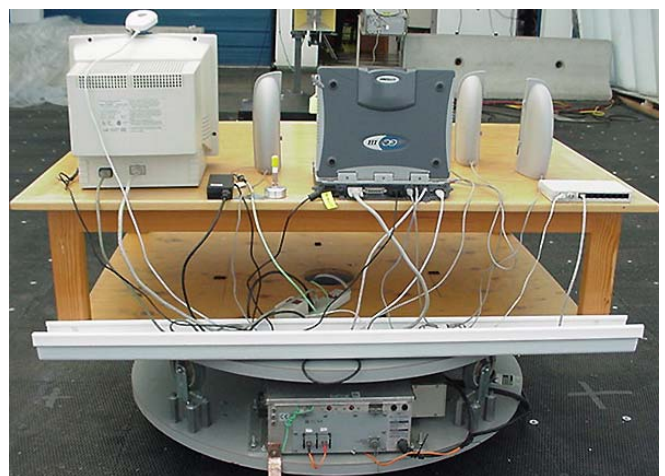

Applicant:	Itronix Corporation	FCC ID:	KBCIX260PROA580BT	IC ID:	1943A-IX260Pf	
Rugged Laptop PC with Sierra Wireless AirCard 580 Dual-Band CDMA Modem				Model:	IX260PROA580BT	
2005 Celltech Labs Inc. This document is not to be reproduced in whole or in part without the written permission of Celltech Labs Inc.						28 of 50

Test Report Serial No.:	022305KBC-T618-E24C	Issue 1
Test Date(s):	30Mar05 - 19Apr05	
Test Standard(s):	FCC §2, §22H, §24E	IC RSS-132/133
Lab Registration(s):	FCC #714830	IC Lab File #3874

Photograph D.7-5 - Front of Radiated Emission Setup with vehicle-mount antenna and cradle



Photograph D.7-6 - Back of Radiated Emission Setup with vehicle-mount antenna and cradle



D.8. DUT OPERATING DESCRIPTION

Measurements were made for the low, mid and high CDMA channels transmitting in the cellular band at maximum power levels as described in Section 5 of this report. Each antenna configuration (attached swivel dipole antenna and vehicle-mount antenna) was evaluated.

Applicant:	Itronix Corporation	FCC ID:	KBCIX260PROA580BT	IC ID:	1943A-IX260Pf	
	Rugged Laptop PC with Sierra Wireless AirCard 580 Dual-Band CDMA Modem			Model:	IX260PROA580BT	
2005 Celltech Labs Inc. This document is not to be reproduced in whole or in part without the written permission of Celltech Labs Inc.						29 of 50

Test Report Serial No.:	022305KBC-T618-E24C	Issue 1
Test Date(s):	30Mar05 - 19Apr05	
Test Standard(s):	FCC §2, §22H, §24E	IC RSS-132/133
Lab Registration(s):	FCC #714830	IC Lab File #3874

D.9. TEST RESULTS

The spurious measurements detailed in this section are referenced to the carrier levels set forth in Appendix C of this report:

D.9.1. Spurious Emissions

D.9.1.1 Spurious Emissions - Swivel Dipole Antenna



Project Number: 022305KBC-T617
Company: Itronix
Product: IX260PNL3AC580

Standard: FCC22.917
Test Start Date: 19-Apr-05
Test End Date: 19-Apr-05

Dipole Antenna Spurious Emissions

Polarity	Distance m	Substitution Antenna Type	Carrier	Frequency	Corrected Field Strength	Substituted SA Signal Level (uncorrected)	Power Applied to Antenna	Antenna Gain	Emission ERP Level	ERP Limit	Margin	Pass/Fail
				MHz	dBuV/m	dBuV	dBm	dBd	dBm	dBm*	dB	
H	3	Horn SN6267	CH1013	1647.50	63.46	31.34	-53.30	4.21	-51.23	-13.00	38.23	PASS
H	3	Horn SN6267	CH1013	1890.00	77.26	43.64	-29.26	4.45	-26.95	-13.00	13.95	PASS
H	3	Horn SN6267	CH1013	1895.00	78.78	45.13	-26.82	4.46	-24.51	-13.00	11.51	PASS
V	3	Horn SN6267	CH1013	1649.74	61.14	29.01	-54.18	4.21	-52.11	-13.00	39.11	PASS
V	3	Horn SN6267	CH1013	1739.29	66.16	33.49	-44.02	4.30	-39.72	-13.00	26.72	PASS
H	3	Horn SN6267	CH384	1670.00	62.86	30.61	-52.87	4.23	-50.78	-13.00	37.78	PASS
H	3	Horn SN6267	CH384	1945.00	65.44	31.55	-47.02	4.51	-42.52	-13.00	29.52	PASS
V	3	Horn SN6267	CH384	1670.00	62.49	30.24	-52.67	4.23	-48.44	-13.00	35.44	PASS
V	3	Horn SN6267	CH384	1762.83	66.09	33.28	-43.93	4.32	-39.61	-13.00	26.61	PASS
V	3	Horn SN6267	CH384	4181.26	58.82	48.28	-44.54	6.11	-38.43	-13.00	25.43	PASS
H	3	Horn SN6267	CH777	1695.00	63.54	31.14	-53.26	4.26	-51.15	-13.00	38.15	PASS
H	3	Horn SN6267	CH777	1897.50	65.17	31.50	-48.64	4.46	-46.32	-13.00	33.32	PASS
H	3	Horn SN6267	CH777	4242.80	59.75	49.24	-43.75	6.20	-37.55	-13.00	24.55	PASS
V	3	Horn SN6267	CH777	1695.00	63.78	31.38	-48.32	4.26	-44.07	-13.00	31.07	PASS
V	3	Horn SN6267	CH777	1786.64	66.79	33.81	-44.04	4.35	-39.69	-13.00	26.69	PASS

Formulae:

ERP Level (dBm) = Power applied to Antenna (dBm) + Antenna Gain (dBd)

Margin (dB) = Limit (dBm) - Level (dBm)

*The emissions reported above represent the highest emissions or noise floor measured within the frequency band of 30MHz and the 10th harmonic of the carrier with field strengths within 20 dB of the theoretical limit. All other emissions attributed to the EUT had field strengths greater than 20 dB below the theoretical limit and substitutions were not made.

Applicant:	Itronix Corporation	FCC ID:	KBCIX260PROA580BT	IC ID:	1943A-IX260Pf	
Rugged Laptop PC with Sierra Wireless AirCard 580 Dual-Band CDMA Modem				Model:	IX260PROA580BT	
2005 Celltech Labs Inc. This document is not to be reproduced in whole or in part without the written permission of Celltech Labs Inc.						30 of 50

Test Report Serial No.:	022305KBC-T618-E24C	Issue 1
Test Date(s):	30Mar05 - 19Apr05	
Test Standard(s):	FCC §2, §22H, §24E	IC RSS-132/133
Lab Registration(s):	FCC #714830	IC Lab File #3874

D.9.1.1 Spurious Emissions - Vehicle Antenna



Project Number: 022305KBC-T617
Company: Itronix
Product: IX260PNL3AC580
Standard: FCC22.917
Test Start Date: 19-Apr-05
Test End Date: 19-Apr-05

Vehicular Antenna Spurious Emissions

Polarity	Distance m	Substitution Antenna Type	Carrier	Frequency	Corrected Field Strength	Substituted SA Signal Level (uncorrected)	Power Applied to Antenna	Antenna Gain	Emission ERP Level	ERP Limit	Margin	Pass/Fail
				MHz	dBuV/m	dBuV	dBm	dBd	dBm	dBm*	dB	
H	3	Horn SN6267	CH1013	1649.40	62.85	30.72	-52.42	6.35	-46.07	-13.00	33.07	PASS
V	3	Horn SN6267	CH1013	1649.40	62.65	30.52	-52.95	6.35	-46.60	-13.00	33.60	PASS
V	3	Horn SN6267	CH1013	5769.38	64.68	50.58	-42.66	8.92	-33.74	-13.00	20.74	PASS
H	3	Horn SN6267	CH384	1670.00	62.78	30.53	-52.95	6.37	-46.58	-13.00	33.58	PASS
V	3	Horn SN6267	CH384	1670.00	62.80	30.55	-52.36	6.37	-45.99	-13.00	32.99	PASS
H	3	Horn SN6267	CH777	1695.00	63.07	30.67	-53.73	6.40	-47.34	-13.00	34.34	PASS
V	3	Horn SN6267	CH777	1695.00	62.95	30.55	-49.15	6.40	-42.76	-13.00	29.76	PASS

Formulae:

ERP Level (dBm) = Power applied to Antenna (dBm) + Antenna Gain (dBd)

Margin (dB) = Limit (dBm) - Level (dBm)

*The emissions reported above represent the highest emissions or noise floor measured within the frequency band of 30MHz and the 10th harmonic of the carrier with field strengths within 20 dB of the theoretical limit. All other emissions attributed to the EUT had field strengths greater than 20 dB below the theoretical limit and substitutions were not made.

D.10. PASS/FAIL

In reference to the results outlined in D.9, the DUT passes the requirements as stated in the reference standards.

FCC CFR 4 §22.917(b) Out of Band Emissions. The mean power of emissions must be attenuated below the mean power of the unmodulated carrier (P) on any frequency twice or more than twice the fundamental frequency by: at least 43 + 10 log P dB.

The results set forth in this section meet the requirement with a margin of at least 11.51 dB for the swivel dipole antenna and at least 20.74 dB for the vehicle-mount antenna configuration.

D.11. SIGN-OFF

I attest to the accuracy of the data. All measurements reported herein were performed by me and are correct to the best of my knowledge and belief. I assume full responsibility for the completeness of these measurements.



Russell Pipe
Senior Compliance Technologist
Celltech Labs Inc.

19Apr05

Date

Applicant:	Itronix Corporation	FCC ID:	KBCIX260PROA580BT	IC ID:	1943A-IX260Pf	
Rugged Laptop PC with Sierra Wireless AirCard 580 Dual-Band CDMA Modem			Model:	IX260PROA580BT		
2005 Celltech Labs Inc. This document is not to be reproduced in whole or in part without the written permission of Celltech Labs Inc. 31 of 50						

Test Report Serial No.:	022305KBC-T618-E24C	Issue 1
Test Date(s):	30Mar05 - 19Apr05	
Test Standard(s):	FCC §2, §22H, §24E	IC RSS-132/133
Lab Registration(s):	FCC #714830	IC Lab File #3874

Appendix E - Effective Isotropic Radiated Power Measurement

E.1. REFERENCES	
Normative Reference Standard	FCC CFR 47 §24.232(b)
Procedure Reference	ANSI/TIA/EIA-603-C

E.2. LIMITS	
FCC CFR 47 §24.232 (b)	<i>(b) Mobile/portable stations are limited to 2 watts e.i.r.p. peak power and the equipment must employ means to limit the power to the minimum necessary for successful communications.</i>

E.3. ENVIRONMENTAL CONDITIONS	
Temperature	27.4 +/- 2 °C
Humidity	33 +/- 2 %
Barometric Pressure	96.24 +/- 0.2 kPa

E.4. EQUIPMENT LIST						
RECEIVING EQUIPMENT						
ID	ASSET NUMBER	MANUFACTURER	MODEL	DESCRIPTION	LAST CAL	CAL DUE
1	00072	EMCO	2075	Mini-mast	na	na
2	00073	EMCO	2080	Turn Table	na	na
3	00071	EMCO	2090	Multi-Device Controller	na	na
4	00035	ETS	3115	Horn Antenna (Rx)	24Mar04	24Mar06
5	00015	Agilent	E4408B	Spectrum Analyzer	24Jan05	24Jan06
6	00120	Celltech	n/a	Microwave Cable (RX)	25Mar05	25Mar06
7	00121	Andrew	FSJ4-50B	Microwave Cable (RX)	25Mar05	25Mar06
8	00130	Andrew	FSJ1-50A	Microwave Cable (RX)	25Mar05	25Mar06
ADDITIONAL SUBSTITUTION EQUIPMENT						
ID	ASSET NUMBER	MANUFACTURER	MODEL	DESCRIPTION	LAST CAL	CAL DUE
9	00034	ETS	3115	Horn Antenna (Tx)	24Mar04	24Mar06
10	00131	Andrew	FSJ1-50A	Microwave Cable (TX)	na	na
11	00127	Andrew	FSJ4-50B	Microwave Cable (TX)	na	na
12	00131	Andrew	FSJ1-50A	Microwave Cable (TX)	na	na
13	00031	HP	E8285A	CDMA Test Set	na	na
14	00007	Gigatronics	8652A	Power Meter	18Oct04	18Oct05
15	00011	Gigatronics	80701A	Power Sensor	08Oct04	08Oct05
16	00013	Gigatronics	80701A	Power Sensor	11Oct04	11Oct05
17	00102	Pasternack	PE7015-3110	30 dB attenuator	na*	na*
18	00078	Pasternack	PE2214-20	Directional Coupler	na*	na*

*Attenuation offset in power meter setup

Applicant:	Itronix Corporation	FCC ID:	KBCIX260PROA580BT	IC ID:	1943A-IX260Pf	
Rugged Laptop PC with Sierra Wireless AirCard 580 Dual-Band CDMA Modem				Model:	IX260PROA580BT	
2005 Celltech Labs Inc. This document is not to be reproduced in whole or in part without the written permission of Celltech Labs Inc.						32 of 50

E.5. MEASUREMENT EQUIPMENT SETUP

MEASUREMENT EQUIPMENT CONNECTIONS	The measurement equipment was connected as shown in E.6.			
MEASUREMENT EQUIPMENT SETTINGS	The spectrum analyzer was set to the following settings:			
	Frequency Range	RBW	VBW	Detector
	MHz	MHz	MHz	
	≥ 1000	1	1	

E.6. SETUP DRAWING

Figure E.6-1 - Field Strength Setup Drawing

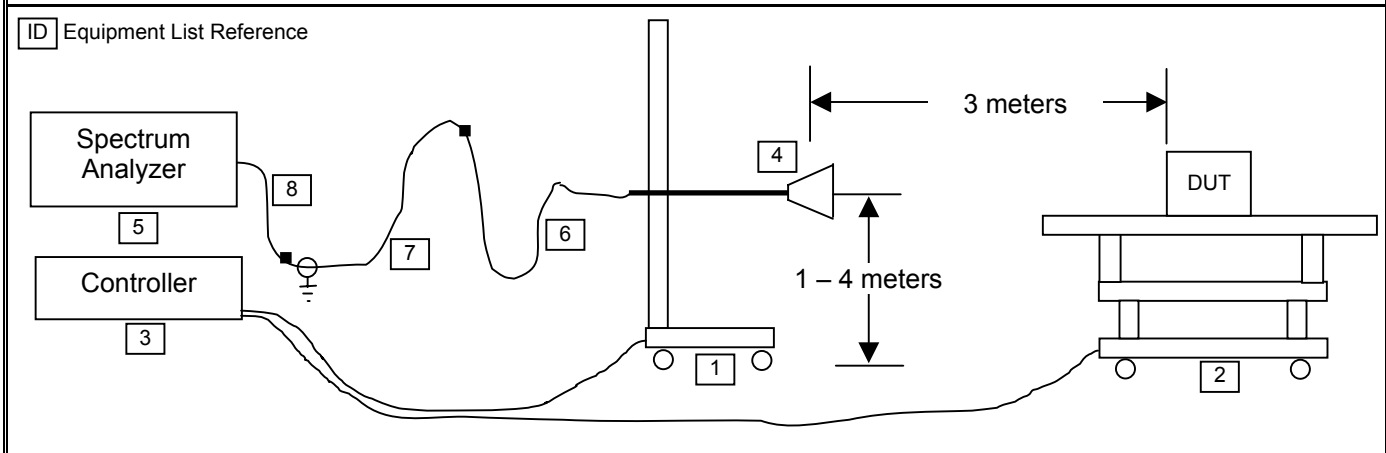
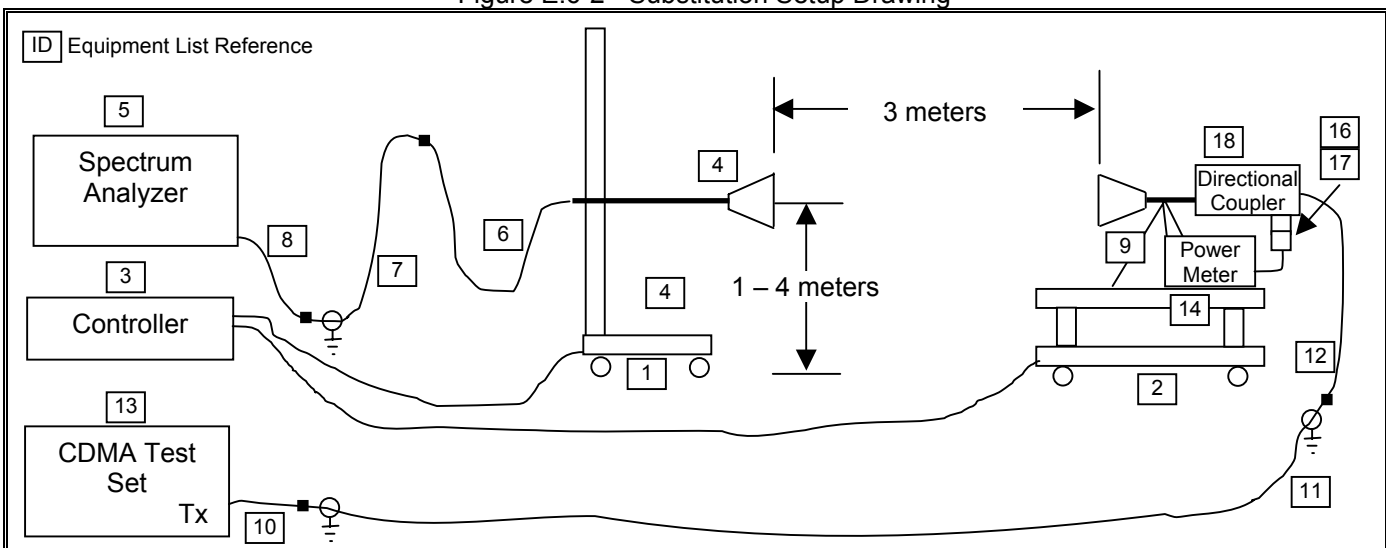

Figure E.6-2 - Substitution Setup Drawing



Test Report Serial No.:	022305KBC-T618-E24C	Issue 1
Test Date(s):	30Mar05 - 19Apr05	
Test Standard(s):	FCC §2, §22H, §24E	IC RSS-132/133
Lab Registration(s):	FCC #714830	IC Lab File #3874

E.7. SETUP PHOTOGRAPHS

Photograph E.7-1 - DUT Swivel Dipole Antenna with Horizontal Horn Receive Antenna



Photograph E.7-2 - DUT Swivel Dipole Antenna with Vertical Horn Receive Antenna

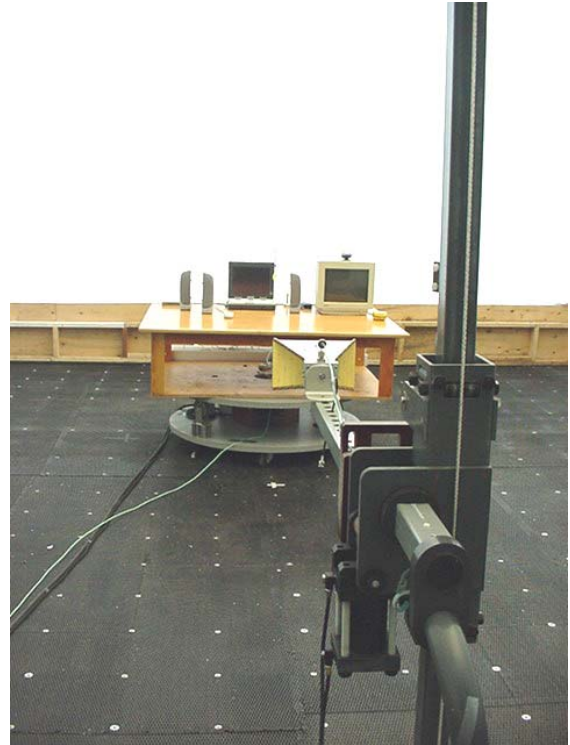

Photograph E.7-3 - Front of Radiated Emission Setup with attached swivel dipole antenna



Photograph E.7-4 - Front of Radiated Emission Setup with vehicle-mount antenna and cradle

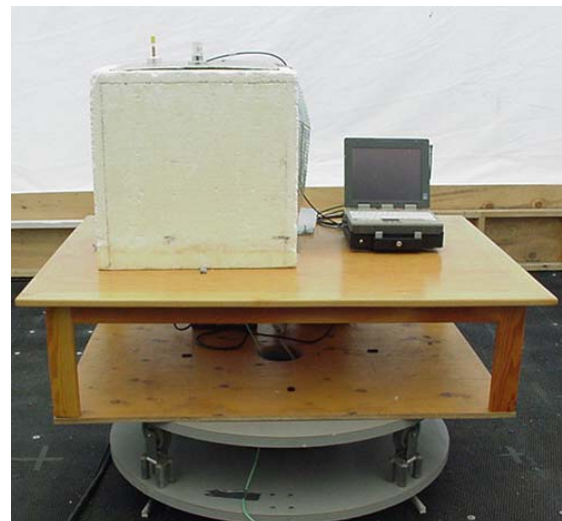

Test Report Serial No.:	022305KBC-T618-E24C	Issue 1
Test Date(s):	30Mar05 - 19Apr05	
Test Standard(s):	FCC §2, §22H, §24E	IC RSS-132/133
Lab Registration(s):	FCC #714830	IC Lab File #3874

Photograph E.7-5 - Back of Radiated Emission Setup with attached swivel dipole antenna



Photograph E.7-6 - Back of Radiated Emission Setup with vehicle-mount antenna and cradle



E.8. DUT OPERATING DESCRIPTION

Measurements were made for the low, mid and high CDMA channels transmitting in the PCS band at maximum power levels as described in Section 5 of this report. Each antenna configuration (attached swivel dipole antenna and vehicle-mount antenna) was evaluated.

Test Report Serial No.:	022305KBC-T618-E24C	Issue 1
Test Date(s):	30Mar05 - 19Apr05	
Test Standard(s):	FCC §2, §22H, §24E	IC RSS-132/133
Lab Registration(s):	FCC #714830	IC Lab File #3874

E.9. TEST RESULTS

E.9.1. Dipole Antenna Carrier Power Levels



Project Number: 022305KBC-T617
Company: Itronix
Product: IX260PNL3AC580

Standard: FCC24.232b
Test Start Date: 11-Apr-05
Test End Date: 11-Apr-05

Portable - Dipole Antenna

Polarity	Distance	Substitution Antenna Type	Carrier	Frequency	Corrected Field Strength	Substituted SA Signal Level (uncorrected)	Power Applied to Antenna	Antenna Gain	Carrier EIRP Level		EIRP Limit		Margin	Pass/Fail
				MHz	dBuV/m	dBuV	dBm	dBi	dBm	Watts	dBm	Watts	dB	
H	3	Horn SN6276	25	1851.25	158.39	125.04	18.98	6.67	25.65	0.367	33.01	2.00	7.36	PASS
H	3	Horn SN6276	600	1880.00	159.41	125.87	20.05	6.68	26.73	0.471	33.01	2.00	6.28	PASS
H	3	Horn SN6276	1175	1908.75	159.64	125.93	20.53	6.68	27.21	0.526	33.01	2.00	5.80	PASS
V	3	Horn SN6276	25	1851.25	154.69	121.34	16.43	6.67	23.10	0.204	33.01	2.00	9.91	PASS
V	3	Horn SN6276	600	1880.00	154.62	121.08	16.33	6.68	23.01	0.200	33.01	2.00	10.00	PASS
V	3	Horn SN6276	1175	1908.75	153.80	120.09	15.45	6.68	22.13	0.163	33.01	2.00	10.88	PASS

Note:
Horn Antenna used for substitution

Formulae:
EIRP Level (dBm) = Power applied to Antenna (dBm) + Antenna Gain (dBi)
Margin (dB) = Limit (dBm) - Level (dBm)

E.9.2. Vehicle Antenna Carrier Power Levels



Project Number: 022305KBC-T617
Company: Itronix
Product: IX260PNL3AC580

Standard: FCC24.232b
Test Start Date: 11-Apr-05
Test End Date: 11-Apr-05

Mobile Antenna Carrier Power Levels

Polarity	Distance	Substitution Antenna Type	Carrier	Frequency	Corrected Field Strength	Substituted SA Signal Level (uncorrected)	Power Applied to Antenna	Antenna Gain	Carrier EIRP Level		EIRP Limit		Margin	Pass/Fail
				MHz	dBuV/m	dBuV	dBm	dBi	dBm	Watts	dBm	Watts	dB	
H	3	Horn SN6276	25	1851.25	108.14	74.79	1.43	6.67	8.10	0.006	33.01	2.00	24.91	PASS
H	3	Horn SN6276	600	1880.00	109.83	76.29	4.20	6.68	10.88	0.012	33.01	2.00	22.13	PASS
H	3	Horn SN6276	1175	1908.75	110.28	76.57	5.16	6.68	11.84	0.015	33.01	2.00	21.17	PASS
V	3	Horn SN6276	25	1851.25	120.40	87.05	15.23	6.67	21.90	0.155	33.01	2.00	11.11	PASS
V	3	Horn SN6276	600	1880.00	120.49	86.95	15.70	6.68	22.38	0.173	33.01	2.00	10.63	PASS
V	3	Horn SN6276	1175	1908.75	120.03	86.32	15.65	6.68	22.33	0.171	33.01	2.00	10.68	PASS

Note:
Horn Antenna used for substitution

Formulae:
EIRP Level (dBm) = Power applied to Antenna (dBm) + Antenna Gain (dBi)
Margin (dB) = Limit (dBm) - Level (dBm)

Test Report Serial No.:	022305KBC-T618-E24C	Issue 1
Test Date(s):	30Mar05 - 19Apr05	
Test Standard(s):	FCC §2, §22H, §24E	IC RSS-132/133
Lab Registration(s):	FCC #714830	IC Lab File #3874

E.10. PASS/FAIL

In reference to the results outlined in E.9, the DUT passes the requirements as stated in the reference standards as follows:

FCC 24.232 (b): Mobile/portable stations are limited to 2 watts e.i.r.p. peak power....

A maximum EIRP of 27.21 dBm (0.526 Watts) was measured when Channel 1175 was transmitting through the attached swivel dipole antenna. A maximum EIRP of 22.38 dBm (0.173 Watts) was measured when Channel 600 was transmitting through the vehicle-mount antenna.

E.11. SIGN-OFF

I attest to the accuracy of the data. All measurements reported herein were performed by me and are correct to the best of my knowledge and belief. I assume full responsibility for the completeness of these measurements.



Russell Pipe
Senior Compliance Technologist
Celltech Labs Inc.

11Apr05

Date

Test Report Serial No.:	022305KBC-T618-E24C	Issue 1
Test Date(s):	30Mar05 - 19Apr05	
Test Standard(s):	FCC §2, §22H, §24E	IC RSS-132/133
Lab Registration(s):	FCC #714830	IC Lab File #3874

Appendix F - PCS Radiated Spurious Emissions Measurement

F.1. REFERENCES	
Normative Reference Standard	FCC CFR 47 §24.238(a)
Procedure Reference	ANSI/TIA/EIA-603-C

F.2. LIMITS	
FCC CFR 47 §24.238	(a) <i>Out of band emissions. The power of any emission outside of the authorized operating frequency ranges must be attenuated below the transmitting power (P) by a factor of at least 43 + 10 log(P) dB.</i>

F.3. ENVIRONMENTAL CONDITIONS	
Temperature	27.4 +/- 2 °C
Humidity	33 +/- 2 %
Barometric Pressure	96.24 +/- 0.2 kPa

F.4. EQUIPMENT LIST						
RECEIVING EQUIPMENT						
ID	ASSET NUMBER	MANUFACTURER	MODEL	DESCRIPTION	LAST CAL	CAL DUE
1	00072	EMCO	2075	Mini-mast	na	na
2	00073	EMCO	2080	Turn Table	na	na
3	00071	EMCO	2090	Multi-Device Controller	na	na
4	00035	ETS	3115	Horn Antenna (Rx)	24Mar04	24Mar06
5	80001	ETS	3160-09	Standard Gain Horn Antenna (Rx)	n/a	n/a
6	00015	Agilent	E4408B	Spectrum Analyzer	24Jan05	24Jan06
7	00120	Celltech	n/a	Microwave Cable (RX)	25Mar05	25Mar06
8	00121	Andrew	FSJ4-50B	Microwave Cable (RX)	25Mar05	25Mar06
9	00130	Andrew	FSJ1-50A	Microwave Cable (RX)	25Mar05	25Mar06
10	00115	Miteq	JS4-00102600-35-5A	Low Noise Amplifier	28Dec04	28Dec05
11	00093	Microtronics	HPM50111	High Pass Filter	8Jun04	8Jun05
12	00043	Microwave Circuits	H02G18G1	High Pass Filter	8Jun04	8Jun05
13	00119	INMAT	18AH-10	10dB attenuator	8Jun04	8Jun05

Applicant:	Itronix Corporation	FCC ID:	KBCIX260PROA580BT	IC ID:	1943A-IX260Pf	
Rugged Laptop PC with Sierra Wireless AirCard 580 Dual-Band CDMA Modem				Model:	IX260PROA580BT	
2005 Celltech Labs Inc. This document is not to be reproduced in whole or in part without the written permission of Celltech Labs Inc.						38 of 50

Test Report Serial No.:	022305KBC-T618-E24C	Issue 1
Test Date(s):	30Mar05 - 19Apr05	
Test Standard(s):	FCC §2, §22H, §24E	IC RSS-132/133
Lab Registration(s):	FCC #714830	IC Lab File #3874

ADDITIONAL SUBSTITUTION EQUIPMENT						
ID	ASSET NUMBER	MANUFACTURER	MODEL	DESCRIPTION	LAST CAL	CAL DUE
14	00034	ETS	3115	Horn Antenna (Tx)	24Mar04	24Mar06
15	80002	ETS	3160-09	Standard Gain Horn Antenna (Tx)	na	na
16	00131	Andrew	FSJ1-50A	Microwave Cable (TX)	na	na
17	00127	Andrew	FSJ4-50B	Microwave Cable (TX)	na	na
18	00131	Andrew	FSJ1-50A	Microwave Cable (TX)	na	na
19	00006	R & S	SMR-20	Signal Generator	30Apr04	30Apr05
20	00007	Gigatronics	8652A	Power Meter	18Oct04	18Oct05
21	00011	Gigatronics	80701A	Power Sensor	08Oct04	08Oct05
22	00013	Gigatronics	80701A	Power Sensor	11Oct04	11Oct05
23	00102	Pasternack	PE7015-3110	30 dB attenuator	na*	na*
24	00078	Pasternack	PE2214-20	Directional Coupler	na*	na*
25	00142	HP	8491A	20 dB attenuator	na*	na*

* Attenuation offset in power meter setup

F.5. MEASUREMENT EQUIPMENT SETUP					
MEASUREMENT EQUIPMENT CONNECTIONS	The measurement equipment was connected as shown in D.6. A number of measurement equipment configurations were used to cover the applicable frequency ranges. The configurations for each range are as follows:				
	Frequency Range	LNA Asset #	Filter/Attenuator Asset #	Rx Antenna Asset #	Tx Antenna Asset #
	1 GHz – 2 GHz	00115	00043 & 00119	00035	00034
	2 GHz – 18 GHz	00115	00093	00035	00034
	18 GHz – 20 GHz	00115	none	80001	80002
MEASUREMENT EQUIPMENT SETTINGS	The spectrum analyzer was set to the following settings:				
	Frequency Range	RBW	VBW	Detector	
	MHz	kHz	kHz		
	≥ 1000	1000	1000	Peak	

Applicant:	Itronix Corporation	FCC ID:	KBCIX260PROA580BT	IC ID:	1943A-IX260Pf	
Rugged Laptop PC with Sierra Wireless AirCard 580 Dual-Band CDMA Modem				Model:	IX260PROA580BT	
2005 Celltech Labs Inc. This document is not to be reproduced in whole or in part without the written permission of Celltech Labs Inc.						39 of 50

Test Report Serial No.:	022305KBC-T618-E24C	Issue 1
Test Date(s):	30Mar05 - 19Apr05	
Test Standard(s):	FCC §2, §22H, §24E	IC RSS-132/133
Lab Registration(s):	FCC #714830	IC Lab File #3874

F.6. SETUP DRAWING

Figure F.6-1 - Field Strength Setup Drawing

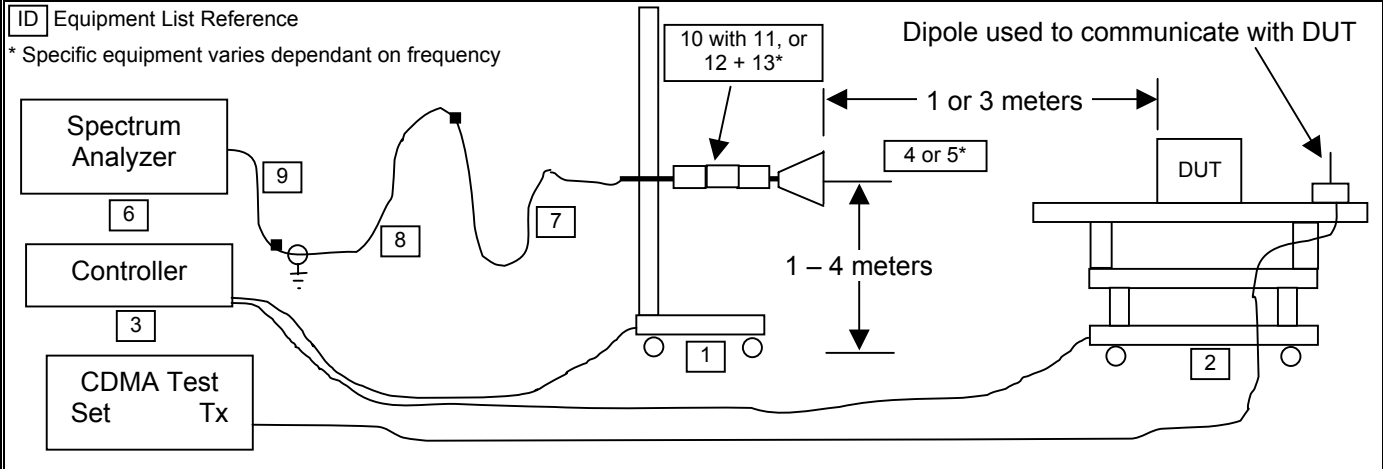
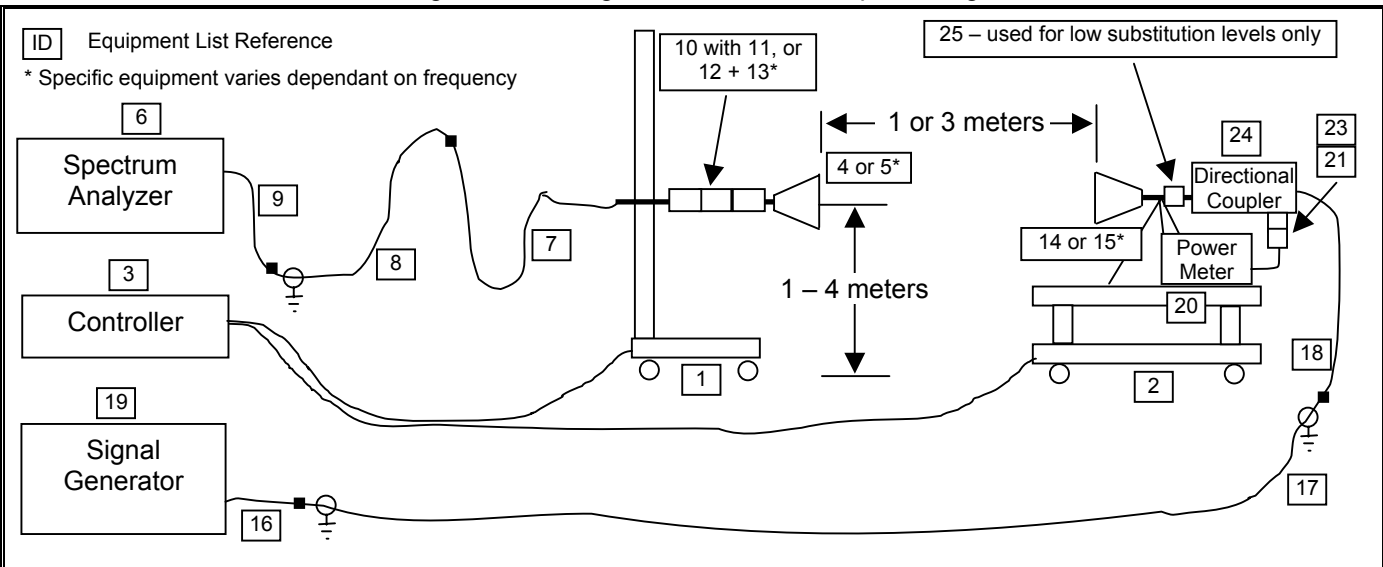

Figure F.6-2 - Signal Substitution Setup Drawing



Test Report Serial No.:	022305KBC-T618-E24C	Issue 1
Test Date(s):	30Mar05 - 19Apr05	
Test Standard(s):	FCC §2, §22H, §24E	IC RSS-132/133
Lab Registration(s):	FCC #714830	IC Lab File #3874

F.7. SETUP PHOTOGRAPHS

Photograph F.7-1 - Horizontal 3115 Horn and LNA DUT with attached swivel dipole antenna



Photograph F.7-2 - Vertical 3115 Horn and LNA DUT with attached swivel dipole antenna



Photograph F.7-3 - Back of Radiated Emission Setup with attached swivel dipole antenna

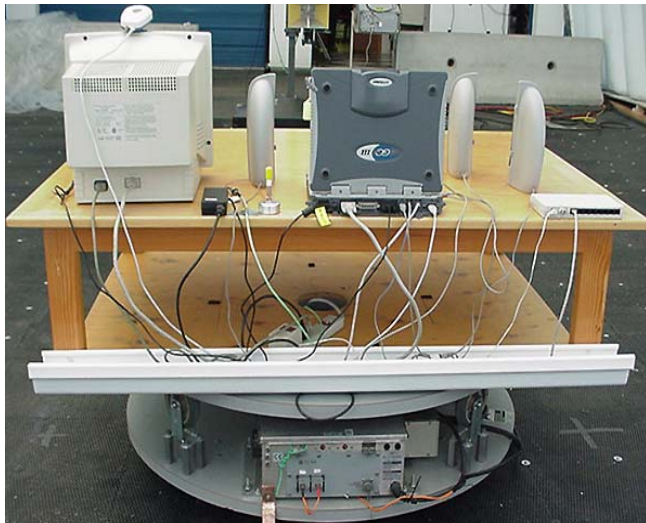

Photograph F.7-4 - Front of Radiated Emission Setup with vehicle-mount antenna and cradle



Applicant:	Itronix Corporation	FCC ID:	KBCIX260PROA580BT	IC ID:	1943A-IX260Pf	
Rugged Laptop PC with Sierra Wireless AirCard 580 Dual-Band CDMA Modem				Model:	IX260PROA580BT	
2005 Celltech Labs Inc. This document is not to be reproduced in whole or in part without the written permission of Celltech Labs Inc.						41 of 50

Test Report Serial No.:	022305KBC-T618-E24C	Issue 1
Test Date(s):	30Mar05 - 19Apr05	
Test Standard(s):	FCC §2, §22H, §24E	IC RSS-132/133
Lab Registration(s):	FCC #714830	IC Lab File #3874

Photograph F.7-5 - Front of Radiated Emission Setup with vehicle-mount antenna and cradle



Photograph F.7-6 - Back of Radiated Emission Setup with vehicle-mount antenna and cradle



F.8. DUT OPERATING DESCRIPTION

Measurements were made for the low, mid and high CDMA channels transmitting in the PCS band at maximum power levels as described in Section 5 of this report. Each antenna configuration (attached swivel dipole antenna and vehicle-mount antenna) was evaluated.

Applicant:	Itronix Corporation	FCC ID:	KBCIX260PROA580BT	IC ID:	1943A-IX260Pf	
	Rugged Laptop PC with Sierra Wireless AirCard 580 Dual-Band CDMA Modem			Model:	IX260PROA580BT	
2005 Celltech Labs Inc. This document is not to be reproduced in whole or in part without the written permission of Celltech Labs Inc.						42 of 50

Test Report Serial No.:	022305KBC-T618-E24C	Issue 1
Test Date(s):	30Mar05 - 19Apr05	
Test Standard(s):	FCC §2, §22H, §24E	IC RSS-132/133
Lab Registration(s):	FCC #714830	IC Lab File #3874

F.9. TEST RESULTS

The spurious measurements detailed in this section are referenced to the carrier levels set forth in Appendix E of this report:

F.9.1. Spurious Emissions

F.9.1.1 Spurious Emissions - Swivel Dipole Antenna



Project Number: 022305KBC-T617
Company: Itronix
Product: IX260PNL3AC580

Standard: FCC24.238
Test Start Date: 19-Apr-05
Test End Date: 19-Apr-05

Dipole Antenna Spurious Emissions

Polarity	Distance m	Substitution Antenna Type	Carrier	Frequency	Corrected Field Strength	Substituted SA Signal Level (uncorrected)	Power Applied to Antenna	Antenna Gain	Emission EIRP Level	EIRP Limit	Margin	Pass/Fail
				MHz	dBuV/m	dBuV	dBm	dBi	dBm	dBm*	dB	
H	3	Horn SN6267	CH25	1870.20	75.95	42.47	-31.49	6.57	-24.92	-13.00	11.92	PASS
H	3	Horn SN6267	CH25	3701.75	61.18	52.02	-42.93	8.06	-34.87	-13.00	21.87	PASS
H	3	Horn SN6267	CH25	5553.55	56.39	42.59	-43.96	8.66	-35.30	-13.00	22.30	PASS
H	3	Horn SN6267	CH25	7405.20	59.41	41.80	-43.82	8.98	-34.84	-13.00	21.84	PASS
H	1	Horn SN6267	CH25	15559.10	87.42	32.63	-66.27	13.56	-52.71	-13.00	39.71	PASS
V	3	Horn SN6267	CH25	1870.40	71.22	37.74	-40.02	6.57	-33.45	-13.00	20.45	PASS
V	3	Horn SN6267	CH25	3702.80	62.88	53.71	-42.80	8.06	-34.74	-13.00	21.74	PASS
V	3	Horn SN6267	CH25	5553.20	59.12	45.32	-44.81	8.66	-36.15	-13.00	23.15	PASS
V	3	Horn SN6267	CH25	7405.20	58.07	40.46	-44.59	8.98	-37.75	-13.00	24.75	PASS
V	1	Horn SN6267	CH25	15560.80	87.79	33.09	-61.06	13.56	-47.50	-13.00	34.50	PASS
H	3	Horn SN6267	CH600	1861.00	77.40	43.98	-30.06	6.56	-23.50	-13.00	10.50	PASS
H	3	Horn SN6267	CH600	1899.00	74.85	41.17	-31.46	6.60	-24.86	-13.00	11.86	PASS
H	3	Horn SN6267	CH600	7520.90	60.73	42.81	-43.65	8.92	-34.73	-13.00	21.73	PASS
V	3	Horn SN6267	CH600	1898.80	70.12	36.44	-39.27	6.60	-32.67	-13.00	19.67	PASS
V	3	Horn SN6267	CH600	7520.00	60.43	42.50	-44.36	8.92	-37.58	-13.00	24.58	PASS
V	1	Horn SN6267	CH600	15557.50	87.67	33.10	-48.04	13.56	-34.48	-13.00	21.48	PASS
H	3	Horn SN6267	CH1175	3817.65	63.19	53.59	-42.55	8.04	-34.51	-13.00	21.51	PASS
H	3	Horn SN6267	CH1175	5727.00	62.15	48.15	-43.11	8.87	-34.24	-13.00	21.24	PASS
H	3	Horn SN6267	CH1175	7634.10	61.53	43.48	-43.09	9.01	-34.08	-13.00	21.08	PASS
H	1	Horn SN6267	CH1175	15557.60	88.07	33.49	-57.01	13.56	-43.45	-13.00	30.45	PASS
V	3	Horn SN6267	CH1175	3817.50	62.56	52.96	-39.51	8.04	-31.47	-13.00	18.47	PASS
V	3	Horn SN6267	CH1175	5725.70	61.97	47.98	-44.08	8.87	-35.21	-13.00	22.21	PASS
V	3	Horn SN6267	CH1175	7634.20	62.84	44.79	-43.72	9.01	-34.71	-13.00	21.71	PASS
V	1	Horn SN6267	CH1175	15559.50	88.75	33.90	-60.59	13.56	-47.03	-13.00	34.03	PASS

Formulae:

EIRP Level (dBm) = Power applied to Antenna (dBm) + Antenna Gain (dBi)

Margin (dB) = Limit (dBm) - Level (dBm)

*The emissions reported above represent the highest emissions or noise floor measured within the frequency band of 30MHz and the 10th harmonic of the carrier with field strengths within 20 dB of the theoretical limit. All other emissions attributed to the EUT had field strengths greater than 20 dB below the theoretical limit and substitutions were not made.

Applicant:	Itronix Corporation	FCC ID:	KBCIX260PROA580BT	IC ID:	1943A-IX260Pf	
Rugged Laptop PC with Sierra Wireless AirCard 580 Dual-Band CDMA Modem			Model:	IX260PROA580BT		
2005 Celltech Labs Inc. This document is not to be reproduced in whole or in part without the written permission of Celltech Labs Inc. 43 of 50						

Test Report Serial No.:	022305KBC-T618-E24C	Issue 1
Test Date(s):	30Mar05 - 19Apr05	
Test Standard(s):	FCC §2, §22H, §24E	IC RSS-132/133
Lab Registration(s):	FCC #714830	IC Lab File #3874

F.9.1.1 Spurious Emissions - Vehicle Antenna



Project Number: 022305KBC-T617
Company: Itronix
Product: IX260PNL3AC580
Standard: FCC24.238
Test Start Date: 19-Apr-05
Test End Date: 19-Apr-05

Vehicular Antenna Spurious Emissions

Polarity	Distance m	Substitution Antenna Type	Carrier	Frequency	Corrected Field Strength	Substituted SA Signal Level (uncorrected)	Power Applied to Antenna	Antenna Gain	Emission EIRP Level	EIRP Limit	Margin	Pass/Fail
				MHz	dBuV/m	dBuV	dBm	dBi	dBm	dBm*	dB	
H	3	Horn SN6267	CH25	1868.00	64.34	30.88	-53.84	6.57	-47.27	-13.00	34.27	PASS
H	3	Horn SN6267	CH25	1887.00	63.78	30.19	-54.05	6.59	-47.46	-13.00	34.46	PASS
H	1	Horn SN6267	CH25	15559.10	87.45	32.66	-66.30	13.56	-52.74	-13.00	39.74	PASS
V	3	Horn SN6267	CH25	1870.00	69.73	36.25	-43.00	6.57	-36.43	-13.00	23.43	PASS
V	3	Horn SN6267	CH25	1889.00	64.88	31.27	-50.09	6.59	-43.50	-13.00	30.50	PASS
V	3	Horn SN6267	CH25	3701.90	62.31	53.15	-43.05	8.06	-34.99	-13.00	21.99	PASS
V	1	Horn SN6267	CH25	15559.10	87.45	32.66	-59.75	13.56	-46.19	-13.00	33.19	PASS
H	3	Horn SN6267	CH600	1909.00	64.17	30.46	-51.70	6.61	-45.09	-13.00	32.09	PASS
H	1	Horn SN6267	CH600	15557.50	92.55	37.98	-43.13	13.56	-29.57	-13.00	16.57	PASS
V	3	Horn SN6267	CH600	1899.00	68.45	34.77	-42.37	6.60	-35.77	-13.00	22.77	PASS
V	3	Horn SN6267	CH600	2750.00	67.34	53.19	-39.25	7.80	-31.45	-13.00	18.45	PASS
V	1	Horn SN6267	CH600	15557.50	92.73	38.16	-42.98	13.56	-29.42	-13.00	16.42	PASS
H	3	Horn SN6267	CH1175	1987.50	65.65	31.48	-46.90	6.69	-40.21	-13.00	27.21	PASS
H	3	Horn SN6267	CH1175	15561.60	123.64	37.81	-41.66	13.56	-28.10	-13.00	15.10	PASS
V	3	Horn SN6267	CH1175	2003.00	43.12	31.45	-55.31	6.71	-48.60	-13.00	35.60	PASS
V	3	Horn SN6267	CH1175	3818.00	72.50	62.90	-30.12	8.04	-22.08	-13.00	9.08	PASS
V	1	Horn SN6267	CH1175	15553.40	92.40	38.41	-42.39	13.55	-28.84	-13.00	15.84	PASS

Formulae:

EIRP Level (dBm) = Power applied to Antenna (dBm) + Antenna Gain (dBi)

Margin (dB) = Limit (dBm) - Level (dBm)

*The emissions reported above represent the highest emissions or noise floor measured within the frequency band of 30MHz and to 10th harmonic of the carrier with field strengths within 20 dB of the theoretical limit. All other emissions attributed to the EUT had field strengths greater than 20 dB below the theoretical limit and substitutions were not made.

Test Report Serial No.:	022305KBC-T618-E24C	Issue 1
Test Date(s):	30Mar05 - 19Apr05	
Test Standard(s):	FCC §2, §22H, §24E	IC RSS-132/133
Lab Registration(s):	FCC #714830	IC Lab File #3874

F.10. PASS/FAIL

In reference to the results outlined in F.9, the DUT passes the requirements as stated in the reference standards.

FCC CFR 4 §24.238 (a) Out of band emissions. The power of any emission outside of the authorized operating frequency ranges must be attenuated below the transmitting power (P) by a factor of at least $43 + 10 \log(P)$ dB.

The results set forth in this section meet the requirement with a margin of at least 10.50 dB for the attached swivel dipole antenna and at least 9.08 dB for the vehicle-mount antenna.

F.11. SIGN-OFF

I attest to the accuracy of the data. All measurements reported herein were performed by me and are correct to the best of my knowledge and belief. I assume full responsibility for the completeness of these measurements.



Russell Pipe
Senior Compliance Technologist
Celltech Labs Inc.

19Apr05

Date

Test Report Serial No.:	022305KBC-T618-E24C	Issue 1
Test Date(s):	30Mar05 - 19Apr05	
Test Standard(s):	FCC §2, §22H, §24E	IC RSS-132/133
Lab Registration(s):	FCC #714830	IC Lab File #3874

Appendix G - Maximum Permissible Exposure Calculation

G.1. REFERENCES

Normative Reference Standard	FCC CFR 47§1.1310 IEEE Std C95.1-1999
Procedure Reference	FCC CFR 47§2.1091

G.2. LIMITS

FCC CFR 47§1.1310 Table 1(b)	Frequency	Power Density
	300 – 1500 MHz	f/1500 mW/cm ²
	1500 – 100,000 MHz	1.0 mW/cm ²

G.3. ENVIRONMENTAL CONDITIONS

Temperature	na
Humidity	na
Barometric Pressure	na

G.4. EQUIPMENT LIST

ASSET NUMBER	MANUFACTURER	MODEL	DESCRIPTION	LAST CAL	CAL DUE
na					

G.5. MEASUREMENT EQUIPMENT SETUP

MEASUREMENT EQUIPMENT CONNECTIONS	The results described herein were determined by calculations, so no measurement equipment was used. The power measurements for each radio used in these calculations were made with the system transmitting as described in Appendix C and E of this report.
MEASUREMENT EQUIPMENT SETTINGS	na

G.6. SETUP PHOTOS

na

G.7. SETUP DRAWINGS

na

G.8. DUT OPERATING DESCRIPTION

Dual-Band CDMA	Power Measurement: The Dual-Band CDMA modem was set to transmit on the channel with the highest conducted output power in each band with power settings equivalent to that described in Section B.8 of this test report.
----------------	--------------------------------------------------------------------------------------------------------------------------------------------------------------------------------------------------------------------------

Test Report Serial No.:	022305KBC-T618-E24C	Issue 1
Test Date(s):	30Mar05 - 19Apr05	
Test Standard(s):	FCC §2, §22H, §24E	IC RSS-132/133
Lab Registration(s):	FCC #714830	IC Lab File #3874

G.9. TEST RESULTS

G.9.1. DUT with Attached Swivel Dipole Antenna Calculations:

External Swivel Dipole Antenna (Highest Power Cellular CDMA Channel):

Ratio of Time on vs Total TX Time **1.00**

Tx Frequency:	848.31	(MHz)
RF Output Power at Antenna Input Terminal:	23.61	(dBm)
Source-Based Time -Average Factor:	0.00	(dB)
Source-Based Time-Averaged RF Output Power at Antenna Input Terminal:	23.61	(dBm)
Antenna gain:	2.60	(dBi)

S = **0.57** (mW/cm²)
P = **229.6149** (mW)
G = **1.82** (numeric)

R = 7.67 (cm)

S at 20cm: **0.083034652** (mW/cm²)

External Swivel Dipole Antenna (Highest Power PCS CDMA Channel):

Ratio of Time on vs Total TX Time **1.00**

Tx Frequency:	1880.00	(MHz)
RF Output Power at Antenna Input Terminal:	25.07	(dBm)
Source-Based Time -Average Factor:	0.00	(dB)
Source-Based Time-Averaged RF Output Power at Antenna Input Terminal:	25.07	(dBm)
Antenna gain:	2.60	(dBi)

S = **1.00** (mW/cm²)
P = **321.3661** (mW)
G = **1.82** (numeric)

R = 6.82 (cm)

S at 20cm: **0.116214246** (mW/cm²)

Formulae:

$$S = \frac{PG}{4\pi R^2}$$

where: S = Power Density Limit
P = Power Applied to the Antenna
G = Numeric Antenna Gain
R = Distance from Antenna

$$R = \sqrt{\frac{P}{4\pi S}}$$

Test Report Serial No.:	022305KBC-T618-E24C	Issue 1
Test Date(s):	30Mar05 - 19Apr05	
Test Standard(s):	FCC §2, §22H, §24E	IC RSS-132/133
Lab Registration(s):	FCC #714830	IC Lab File #3874

G.9.2. DUT with Vehicle-Mount Antenna Calculations:

Vehicle-Mount Antenna (Highest Power Cellular CDMA Channel):

Ratio of Time on vs Total TX Time **1.00**

Tx Frequency:	848.31	(MHz)
RF Output Power at Antenna Input Terminal:	23.61	(dBm)
Source-Based Time -Average Factor:	0.00	(dB)
Source-Based Time-Averaged RF Output Power at Antenna Input Terminal:	23.61	(dBm)
Antenna gain:	3.00	(dBi)

S= 0.57 (mW/cm²)
P= 229.6149 (mW)
G= 2.00 (numeric)

R = 8.03 (cm)

S at 20cm: 0.091045685 (mW/cm²)

Vehicle-Mount Antenna (Highest Power PCS CDMA Channel):

Ratio of Time on vs Total TX Time **1.00**

Tx Frequency:	1880.00	(MHz)
RF Output Power at Antenna Input Terminal:	25.07	(dBm)
Source-Based Time -Average Factor:	0.00	(dB)
Source-Based Time-Averaged RF Output Power at Antenna Input Terminal:	25.07	(dBm)
Antenna gain:	3.00	(dBi)

S= 1.00 (mW/cm²)
P= 321.3661 (mW)
G= 2.00 (numeric)

R = 7.14 (cm)

S at 20cm: 0.127426386 (mW/cm²)

Formulae:

$$S = \frac{PG}{4\pi R^2}$$

$$R = \sqrt{\frac{P}{4\pi S}}$$

where: S = Power Density Limit
P = Power Applied to the Antenna
G = Numeric Antenna Gain
R = Distance from Antenna

Test Report Serial No.:	022305KBC-T618-E24C	Issue 1
Test Date(s):	30Mar05 - 19Apr05	
Test Standard(s):	FCC §2, §22H, §24E	IC RSS-132/133
Lab Registration(s):	FCC #714830	IC Lab File #3874

Results:

Band / Mode	Power Density Limit	RF Conducted Output Power	Antenna Gain	MPE Distance	Power Density at 20 cm
	mW/cm ²	dBm	dBi	cm	mW/cm ²
Dipole Antenna					
Cellular - CDMA	0.57	23.61	2.6	7.67	0.08303
PCS - CDMA	1.00	25.07	2.6	6.82	0.1162
Vehicle Antenna					
Cellular - CDMA	0.57	23.61	3.0	8.03	0.09104
PCS - CDMA	1.00	25.07	3.0	7.14	0.1274

G.10. PASS/FAIL

In reference to the results outlined in G.9 the DUT passes the requirements as stated in the reference standards as follows:

FCC CFR 47§1.1310 Table 1(b) 1) The DUT must comply with the minimum spacing requirement of 20 cm to ensure an exposure of not more than f/1500 (0.57) mW/cm² for frequencies between 300 and 1500 MHz and 1 mW/cm² for frequencies between 1500 and 100,000 MHz.

The calculated power density at a 20 cm distance for the cellular band is 0.08303 mW/cm² for the attached swivel dipole antenna configuration, and 0.09104 mW/cm² for the vehicle-mount antenna configuration. The calculated power density at a 20 cm distance for the PCS band is 0.1162 mW/cm² for the swivel dipole antenna configuration, and 0.1274 mW/cm² for the vehicle-mount antenna configuration.

G.11. SIGN-OFF

I attest to the accuracy of the data. All measurements reported herein were performed by me and are correct to the best of my knowledge and belief. I assume full responsibility for the completeness of these measurements.



Duane M. Friesen, C.E.T.
EMC Manager
Celltech Labs Inc.

21Apr05
Date

Applicant:	Itronix Corporation	FCC ID:	KBCIX260PROA580BT	IC ID:	1943A-IX260Pf	
Rugged Laptop PC with Sierra Wireless AirCard 580 Dual-Band CDMA Modem				Model:	IX260PROA580BT	
2005 Celltech Labs Inc. This document is not to be reproduced in whole or in part without the written permission of Celltech Labs Inc.						49 of 50

Test Report Serial No.:	022305KBC-T618-E24C	Issue 1
Test Date(s):	30Mar05 - 19Apr05	
Test Standard(s):	FCC §2, §22H, §24E	IC RSS-132/133
Lab Registration(s):	FCC #714830	IC Lab File #3874

END OF DOCUMENT

Applicant:	Itronix Corporation	FCC ID:	KBCIX260PROA580BT	IC ID:	1943A-IX260Pf	
Rugged Laptop PC with Sierra Wireless AirCard 580 Dual-Band CDMA Modem				Model:	IX260PROA580BT	
2005 Celltech Labs Inc. This document is not to be reproduced in whole or in part without the written permission of Celltech Labs Inc.						50 of 50