

Test Report S/N:	090104KBC-T555-E24C/E15B	
Test Date(s):	01Nov04 - 23Novt04	
Test Type:	FCC §2, §15.247, §22H, §24E	IC RSS-210/132/133
Lab Registration(s):	FCC #714830	IC Lab File #3874

SUPPLEMENTARY EMC TEST REPORT
FOR THE
ITRONIX RUGGED LAPTOP PC MODEL: IX260PROA555BT
WITH THE
INTERNAL CIRRONET BT2022 BLUETOOTH TRANSMITTER
UTILIZING THE
INTERNAL RANGESTAR SURFACE-MOUNT ANTENNA
(INSTALLED IN THE UPPER LEFT SIDE EDGE OF LCD DISPLAY)
CO-TRANSMITTING WITH THE
SIERRA WIRELESS AIRCARD 555/550 DUAL-BAND CDMA PCMCIA MODEM
UTILIZING THE
EXTERNAL SWIVEL DIPOLE ANTENNA

TRSN 090104KBC-T555-E24C/E15B
Issue 1.0

Celltech Compliance Testing & Engineering Lab
(Celltech Labs Inc.)
1955 Moss Court
Kelowna, BC
Canada
V1Y 9L3

November 24, 2004

Test Report S/N:	090104KBC-T555-E24C/E15B		
Test Date(s):	01Nov04 - 23Nov04		
Test Type:	FCC §2, §15.247, §22H, §24E	IC RSS-210/132/133	
Lab Registration(s):	FCC #714830	IC Lab File #3874	

DECLARATION OF COMPLIANCE

Test Lab		CELLTECH LABS INC. Testing and Engineering Services 1955 Moss Court Kelowna, B.C. Canada V1Y 9L3		Applicant Information		ITRONIX CORPORATION 801 South Stevens Street Spokane, WA 99204 United States		
Phone:	250-448-7047							
Fax:	250-448-7048							
e-mail:	info@celltechlabs.com							
web site:	www.celltechlabs.com							
Laboratory Registration No.(s):		FCC:	714830	IC:	IC 3874			
Rule Part(s):	FCC:	Dual Band CDMA	§2 ; §22H; §24E					
		Bluetooth - FHSS	§15.247; §2.1091; §1.1310					
Device Classification:	FCC:	Dual Band CDMA	- PCS Licensed Transmitter (PCB)					
		Bluetooth - FHSS	- Part 15 Spread Spectrum Transmitter (DSS)					
Device Identification:	FCC ID:	KBCIX260PROA555BT	IC ID:	1943A-IX260Pb				
DUT Description:								
Model:	IX260PROA555BT							
Device Description:	Rugged Laptop PC with internal Cirronet BT2022 Bluetooth Transmitter and internal RangeStar surface-mount antenna, co-transmitting with Sierra Wireless AirCard 555/550 Dual-Band CDMA PCMCIA Modem and External Swivel Dipole Antenna, Vehicle-Mount Antenna, & Vehicle Cradle							
Tx Frequency Range(s):	Dual Band CDMA	Cellular	824.7 - 848.31 MHz					
		PCS	1851.25 - 1908.75 MHz					
	Bluetooth	2402 - 2480 MHz						
Max. RF Output Power:	Dual Band CDMA	Cellular	+22.99 dBm Peak Conducted					
		PCS	+23.06 dBm Peak Conducted					
		Bluetooth	+15.46 dBm Peak Conducted					
Modulation Type(s):	Bluetooth	GFSK 1 Mbps 0.5 BT Gaussian						
	Dual Band CDMA	QPSK						
Antenna Type(s):	Bluetooth	RangeStar P/N: 100929 Internal Surface-Mount						
	Dual Band CDMA	Itronix IX260+ External Swivel Dipole						
Power Supply:	90 Watt AC Power Adapter, 11.1 V Lithium-ion Battery, 6.0 Ah (Model: A2121-2), 12 V Vehicle Battery (for Vehicle Cradle)							

This wireless mobile device has demonstrated compliance with the applicable technical standards as indicated in the measurement report and was tested in accordance with the measurement procedures specified in FCC 47 CFR Parts 2, 15.247, 22H, 24E, Industry Canada RSS 133 Issue 2, RSS-132 Issue 1 (Provisional), RSS-210 Issue 5; and ANSI TIA/EIA-603-A-2002.

I attest to the accuracy of the data. All measurements reported herein were performed by me or were under my supervision and are correct to the best of my knowledge and belief. I assume full responsibility for the completeness of these measurements and vouch for the qualifications of all persons taking them.

This test report shall not be reproduced partially, or in full, without the prior written approval of Celltech Labs Inc. The results and statements contained in this report pertain only to the device(s) evaluated.



Russell Pipe
Senior Compliance Technologist
Celltech Labs Inc.

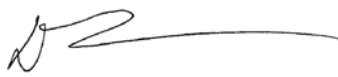

Duane M. Friesen
EMC Manager
Celltech Labs Inc.



Applicant:	Itronix Corporation	Model:	IX260PROA555BT	FCC ID:	KBCIX260PROA555BT	IC ID:	1943A-IX260Pb
Rugged Laptop PC with internal Sierra Wireless AirCard 555/550 Dual-Band CDMA Modem & Cirronet BT2022 Bluetooth							
2004 Celltech Labs Inc	This document is not to be reproduced in whole or in part without the written permission of Celltech Labs Inc.						2 of 53

Test Report S/N:	090104KBC-T555-E24C/E15B		
Test Date(s):	01Nov04 - 23Nov04		
Test Type:	FCC §2, §15.247, §22H, §24E	IC RSS-210/132/133	
Lab Registration(s):	FCC #714830	IC Lab File #3874	

TABLE OF CONTENTS

1.0 SCOPE	6
2.0 REFERENCES	7
2.1 Normative References	7
3.0 TERMS AND DEFINITIONS	8
4.0 FACILITIES AND ACCREDITATIONS	9
5.0 GENERAL INFORMATION	9
5.1 Applicant Information	9
5.2 DUT Description	9
5.3 Co-Located Equipment	10
5.4 Cable Descriptions	10
5.5 Support Equipment	11
5.6 Clock Frequencies	11
5.7 Mode(s) of Operation Tested	12
5.8 Configuration Description	13
6.0 PASS/FAIL CRITERIA	13
APPENDIX	14
Appendix A - DUT Photographs	15
Appendix B - Conducted Powerline Emissions Measurement	17
Appendix C – Bluetooth Peak Conducted RF Output Power Measurement	24
Appendix D - Radiated Spurious Emissions Measurement	27
Appendix E - Restricted Band Emissions Measurement	32
Appendix F - Maximum Permissible Exposure Calculation	42
Appendix G – CDMA Conducted RF Output Power Measurement	45
Appendix H – Radiated Spurious Emissions Measurement	48
END OF DOCUMENT	53

Test Report S/N:	090104KBC-T555-E24C/E15B		
Test Date(s):	01Nov04 - 23Nov04		
Test Type:	FCC §2, §15.247, §22H, §24E	IC RSS-210/132/133	
Lab Registration(s):	FCC #714830	IC Lab File #3874	

FIGURES

Figure B-1 – Setup Drawing	20
Figure C-1 – Setup Drawing	25
Figure D-1 – Setup Drawing	28
Figure E-1 – Setup Drawing	34
Figure G-1 – Setup Drawing	46
Figure H-1 – Setup Drawing	49

PHOTOGRAPHS

Photograph B-1 – AC Powerline Conducted Emission Configuration	19
Photograph B-2 – AC Powerline Conducted Emission Cable Placement	19
Photograph D-1 – 3115 Horn Antenna	29
Photograph E-1 – 3115 Vertical Polarization (10 GHz – 18 GHz)	35
Photograph E-2 - Front of Radiated Emission Configuration	35
Photograph E-3 - Back of Radiated Emission Configuration	35
Photograph H-1 – 3115 Vertical Polarization	50
Photograph H-2 - Front of Radiated Emission Configuration	50
Photograph H-3 - Back of Radiated Emission Configuration	50

Test Report S/N:	090104KBC-T555-E24C/E15B		
Test Date(s):	01Nov04 - 23Nov04		
Test Type:	FCC §2, §15.247, §22H, §24E	IC RSS-210/132/133	
Lab Registration(s):	FCC #714830	IC Lab File #3874	

TEST SUMMARY

Referenced Standard: FCC CFR Title 47 Parts 2 & 15

Appendix	Test Description	Procedure Reference	Limit Reference	Test Start Date	Test End Date	Result
B	Powerline Conducted Emissions	ANSI C63.4	§15.207	18Nov04	18Nov04	Pass
C	Conducted RF Output Power	FCC 97-114	§15.247(b) (3)	18Nov04	18Nov04	Pass
D	Radiated Spurious Emissions	FCC 97-114	§15.247(c)	01Nov04	23Nov04	Pass
E	Restricted Band Emissions	FCC 97-114	§15.205 (a), (b) §15.209 (a)	01Nov04	23Nov04	Pass
F	Maximum Permissible Exposure	FCC CFR 47 § 2.1091 IEEE Std C95.1-1999	§1.1310 Table 1 (b)	17Nov04	17Nov04	Pass

Referenced Standard: FCC CFR Title 47 Part 2, 22H & 24E

Appendix	Test Description	Procedure Reference	Limit Reference	Test Start Date	Test End Date	Result
G	Conducted RF Output Power	ANSI/TIA/EIA-603-A	§22.913, §24.232(b)	18Nov04	18Nov04	Pass
H	Radiated Spurious Emissions	ANSI/TIA/EIA-603-A	§22.917 (e), §24.238 (a)	01Nov04	23Nov04	Pass

Referenced Standard: IC RSS-210 Issue 5

B	Powerline Conducted Emissions	RSS-212, ANSI C63.4	RSS-210 §6.6	18Nov04	18Nov04	Pass
C	Conducted RF Output Power	RSS-210 § 10	RSS-210 A1 §(l)(iv) RSS-210 §6.2.2 (o)(b)	18Nov04	18Nov04	Pass
D	Radiated Spurious Emissions	RSS-212, ANSI C63.4	RSS-210 §6.2.2 (e1)	01Nov04	23Nov04	Pass
E	Restricted Band Emissions	RSS-212, ANSI C63.4	RSS-210 §6.3	01Nov04	23Nov04	Pass
F	Maximum Permissible Exposure	RSS-102	RSS-210 §14 Safety Code 6 2.2.1(a) Table 5	17Nov04	17Nov04	Pass



Referenced Standard: IC RSS-132, RSS-133

G	Conducted RF Output Power	ANSI/TIA/EIA-603-A	RSS-132 §4.4 RSS-133 §6.2	18Nov04	18Nov04	Pass
H	Radiated Spurious Emissions	ANSI/TIA/EIA-603-A	RSS-132 §4.4 RSS-133 §6.3	01Nov04	23Nov04	Pass

REVISION LOG

Issue	Description	Implemented By	Implementation Date
1.0	Initial Release	Jon Hughes	24Nov04

SIGNATORIES

Prepared By:		Nov. 24, 2004
Name/Title	Duane M. Friesen, C.E.T. / EMC Manager	Date
Approved By:		Nov. 24, 2004
Name/Title	Jon Hughes / General Manager	Date

Applicant:	Itronix Corporation	Model:	IX260PROA555BT	FCC ID:	KBCIX260PROA555BT	IC ID:	1943A-IX260Pb	
Rugged Laptop PC with internal Sierra Wireless AirCard 555/550 Dual-Band CDMA Modem & Cirronet BT2022 Bluetooth								
2004 Celltech Labs Inc		This document is not to be reproduced in whole or in part without the written permission of Celltech Labs Inc.					5 of 53	

Test Report S/N:	090104KBC-T555-E24C/E15B		
Test Date(s):	01Nov04 - 23Nov04		
Test Type:	FCC §2, §15.247, §22H, §24E	IC RSS-210/132/133	
Lab Registration(s):	FCC #714830	IC Lab File #3874	

1.0 SCOPE

This report outlines the measurements made and results collected during electromagnetic emissions testing of the Itronix Corporation IX260+ Rugged Laptop PC with internal Cirronet BT2022 Bluetooth Transmitter co-transmitting with the Sierra Wireless AirCard 555/550 Dual-Band CDMA PCMCIA Modem. The Bluetooth transmitter was connected to the Rangestar internal surface-mount antenna located in the upper left side edge of the LCD display. The Dual-Band CDMA Modem was connected to an external swivel dipole antenna located on the upper right side edge of the LCD display. The IX260+ also has the option of being mounted in a vehicle cradle, with the Dual-Band CDMA Modem utilizing a vehicle-mount antenna. The vehicle antenna option was not considered to be worst case when investigating the co-transmitting effects, and therefore was not used in obtaining the data presented in this report. This report describes the results obtained when inter-modulation product and related measurements were made with both transmitters installed in the IX260+ Rugged Laptop PC as described, and transmitting simultaneously. The measurement results were applied against the applicable EMC requirements and limits outlined in the technical rules and regulations set forth in the Federal Communication Commission Code of Federal Regulations Title 47 Part 2, 15 subpart C, 22 subpart H and 24 subpart E.

Applicant:	Itronix Corporation	Model:	IX260PROA555BT	FCC ID:	KBCIX260PROA555BT	IC ID:	1943A-IX260Pb	
Rugged Laptop PC with internal Sierra Wireless AirCard 555/550 Dual-Band CDMA Modem & Cirronet BT2022 Bluetooth								
2004 Celltech Labs Inc		This document is not to be reproduced in whole or in part without the written permission of Celltech Labs Inc.					6 of 53	

Test Report S/N:	090104KBC-T555-E24C/E15B		
Test Date(s):	01Nov04 - 23Nov04		
Test Type:	FCC §2, §15.247, §22H, §24E	IC RSS-210/132/133	
Lab Registration(s):	FCC #714830	IC Lab File #3874	

2.0 REFERENCES

2.1 Normative References

ANSI/ISO 17025:1999	General Requirements for competence of testing and calibration laboratories
IEEE/ANSI C63.4:2003	Methods of Measurement of Radio-Noise Emissions from Low-Voltage Electrical and Electronic Equipment in the Range of 9 kHz to 40 GHz
IEEE/ANSI Std C95.1:1999	American National Standard Safety Levels with Respect to Human Exposure to Radio Frequency Electromagnetic Fields
ANSI/TIA/EIA-603-A:2002	Land Mobile FM or PM Communication Equipment Measurement and Performance Standards
CFR Title 47 Part 2:2003	Code of Federal Regulations Title 47: Telecommunication Part 2: Frequency Allocations and Radio Treaty Matters; General Rules and Regulations
CFR Title 47 Part 15:2003	Code of Federal Regulations Title 47: Telecommunication Part 15: Radio Frequency Devices
CFR Title 47 Part 22:2003	Code of Federal Regulations Title 47: Telecommunication Part 22: Public Mobile Services
CFR Title 47 Part 24:2003	Code of Federal Regulations Title 47: Telecommunication Part 24: Personal Communication Services
IC Spectrum Management & Telecommunications Policy	Radio Standards Specification RSS-102 Issue 1 (Provisional) - Evaluation Procedure for Mobile and Portable Radio Transmitters with respect to Health Canada's Safety Code 6 for Exposure of Humans to Radio Frequency Fields RSS-132 Issue 1 (Provisional) 800 MHz Cellular Telephones Employing New Technologies RSS-133 Issue 2, Revision 1 Personal Communication Services RSS-212 Issue 1 (Provisional) - Test Facilities & Test Methods for Radio Equipment RSS-210 Issue 5 - Low Power Licence-Exempt Radiocommunication Devices
Celltech Labs Test Report	EMC Test Report For the Model IX260+ Rugged Laptop PC with Sierra Wireless AirCard 555/550 Dual-Band CDMA PCMCIA Modem Test Report Serial Number 090104KBC-T555-E24C Date: August 23, 2004
Celltech Labs Test Report	EMC Test Report For the Model IX260+ Rugged Laptop PC with Cirronet BT2022 Bluetooth Transmitter and Internal Antenna Test Report Serial Number 090104KBC-T555-E15B Date: October 22, 2004

Test Report S/N:	090104KBC-T555-E24C/E15B		
Test Date(s):	01Nov04 - 23Nov04		
Test Type:	FCC §2, §15.247, §22H, §24E	IC RSS-210/132/133	
Lab Registration(s):	FCC #714830	IC Lab File #3874	

3.0 TERMS AND DEFINITIONS

AVG	Average
CDMA	Code Division Multiple Access
CFR	Code of Federal Regulations
dB	decibel
dBm	dB referenced to 1 mW
dBuV	dB referenced to 1 uV
DUT	Device under Test
dBc	dB down from carrier
EBW	Emission Bandwidth
EMC	Electromagnetic Compatibility
FCC	Federal Communication Commission
FHSS	Frequency Hopping Spread Spectrum
HP	Hewlett Packard
HPF	High Pass Filter
Hpol	Horizontal Polarization
Hz	Hertz
IC	Industry Canada
kHz	kilohertz
LNA	Low Noise Amplifier
m	meter
MHz	Megahertz
Mbps	megabits per second
na	not applicable
n/a	not available
PK	Peak
PPSD	Peak Power Spectral Density
QP	Quasi-peak
RBW	Resolution Bandwidth
R&S	Rohde & Schwarz
RSS	Radio Standard Specification
SA	Spectrum Analyzer
VBW	Video Bandwidth
Vpol	Vertical Polarization
WLAN	Wireless Local Area Network

Test Report S/N:	090104KBC-T555-E24C/E15B		
Test Date(s):	01Nov04 - 23Nov04		
Test Type:	FCC §2, §15.247, §22H, §24E	IC RSS-210/132/133	
Lab Registration(s):	FCC #714830	IC Lab File #3874	

4.0 FACILITIES AND ACCREDITATIONS

The facilities used in collecting the test results outlined in this report are located at 1955 Moss Court, Kelowna, British Columbia, Canada, V1Y 9L3. The radiated and conducted emissions sites conform with the requirements set forth in ANSI C63.4 and are filed and listed with the FCC under Registration Number 714830 and Industry Canada under File Number IC 3874.

5.0 GENERAL INFORMATION

5.1 Applicant Information

Company Name:	Itronix Corporation
Address:	801 South Stevens Street Spokane, WA 99204 United States

5.2 DUT Description

The DUT consisted of the IX260+ Rugged Laptop PC containing a Cirronet BT2022 Bluetooth Transmitter connected to an Internal Surface-Mount Antenna installed in the upper left side edge of the LCD display. Co-located in the IX260+ Rugged Laptop PC was a Sierra Wireless AirCard 555/550 Dual-Band CDMA PCMCIA Modem connected to an External Swivel Dipole Antenna located on the upper right side edge of the LCD display. The IX260+ has the option of being mounted in a vehicle cradle with the Dual-Band CDMA Modem utilizing a vehicle-mount antenna. The vehicle antenna option was not considered to be worst case, and therefore was not used in obtaining the data presented in this report. Photographs of the DUT placement and construction are shown in Appendix A.

Device:	IX260+ Rugged Laptop PC			
Model:	IX260PROA555BT			
Serial Number(s):	ZZGEG4196ZZ6473			
Identifier(s):	FCC ID:	KBCIX260PROA555BT	IC ID:	1943A-IX260Pb
Power Source:	Delta Electronics Model ADP-90AB Rev B 90 Watt AC-DC power supply			

Device:	Dual-Band CDMA PCMCIA Modem			
Model:	Sierra Wireless AirCard 555/550			
Serial Number:	63013A85			
Identifier(s):	FCC ID:	N7NACRD555	IC ID:	2417292170A
Rule Part(s):	FCC:	§2.1091; §22.913, §22.917; §24.232(b), §24.238		
	IC:	RSS-133 Issue 2; RSS-132 Issue 1 (Provisional)		
Classification:	FCC:	PCS Licensed Transmitter (PCB)		
	IC:	800 MHz Cellular Telephones employing New Technologies (RSS-132)		
		2 GHz Personal Communication Services (RSS-133)		
Power Source:	Powered from the internal PC power supply			

Applicant:	Itronix Corporation	Model:	IX260PROA555BT	FCC ID:	KBCIX260PROA555BT	IC ID:	1943A-IX260Pb
Rugged Laptop PC with internal Sierra Wireless AirCard 555/550 Dual-Band CDMA Modem & Cirronet BT2022 Bluetooth							
2004 Celltech Labs Inc	This document is not to be reproduced in whole or in part without the written permission of Celltech Labs Inc.						9 of 53

Test Report S/N:	090104KBC-T555-E24C/E15B		
Test Date(s):	01Nov04 - 23Nov04		
Test Type:	FCC §2, §15.247, §22H, §24E	IC RSS-210/132/133	
Lab Registration(s):	FCC #714830	IC Lab File #3874	

Device:	2.4GHz FHSS Bluetooth Transmitter		
Model:	Cirronet BT2022		
Serial Number:	n/a		
Identifier:	FCC ID:	HSW-BT2022M	IC: 4492A-BT2022M
Rule Part(s):	FCC:	§15.247; §2.1091; §1.1310	IC: RSS-210 Issue 5 - A1. 11/30/02
Classification:	FCC:	Spread Spectrum Transmitter (DSS)	IC: Low Power Licence-Exempt Transmitter
Power Source:	Powered from the internal PC power supply		

Name:	External Mounted Swivel Dipole Antenna (CDMA - upper right side edge of LCD display)		
Model:	IX260+		
Gain:	2.6 dBi		

Device:	Internal Surface-Mount Antenna (Bluetooth - upper left side edge of LCD display)		
Model:	RangeStar P/N: 100929		
Gain:	4.5 dBi		

5.3 Co-Located Equipment

Name:	GPS Receiver Module with attached Antenna		
Model:	Leadtek P/N GPS9547		

5.4 Cable Descriptions

ROUTING		Length m	Model	Terminations		Shield Type	Shield Termination		Suppression
From	To			End 1	End 2		End 1	End 2	
PC Fire Wire Port	Unterminated	1.0	Copartner E119932	IEEE-1528	Fire wire	n/a	n/a	n/a	None
PC modem port	Unterminated	1.0	n/a	RJ-11	RJ-11	None	na	na	None
PC Ethernet Port	Ethernet Hub	1.0	n/a	RJ-45	RJ-45	None	na	na	None

Applicant:	Itronix Corporation	Model:	IX260PROA555BT	FCC ID:	KBCIX260PROA555BT	IC ID:	1943A-IX260Pb	
Rugged Laptop PC with internal Sierra Wireless AirCard 555/550 Dual-Band CDMA Modem & Cirronet BT2022 Bluetooth								
2004 Celltech Labs Inc		This document is not to be reproduced in whole or in part without the written permission of Celltech Labs Inc.					10 of 53	

Test Report S/N:	090104KBC-T555-E24C/E15B		
Test Date(s):	01Nov04 - 23Nov04		
Test Type:	FCC §2, §15.247, §22H, §24E	IC RSS-210/132/133	
Lab Registration(s):	FCC #714830	IC Lab File #3874	

5.5 Support Equipment

The following equipment was used in support of the DUT.

Co-located Support Equipment List		
Manufacturer	Model	Description
D-Link	DE-809TC/	Ethernet hub
YNG YUH	YP-040	Hub power supply
MLi	699	Speakers
Polk Audio	n/a	Speaker-microphone
DeLorme	Tripmate	GPS Receiver
Intel	CS-430	Camera
Logitech	M-S34	Mouse

5.6 Clock Frequencies

5.6.1 DUT Clock Frequencies

Device:	Rugged Laptop PC
Clocks:	1.6 GHz processor
Device:	2.4GHz FHSS Cirronet Bluetooth
Clocks:	n/a
Device:	Dual-Band CDMA Modem
Clocks:	n/a
Device:	External Swivel Dipole Antenna
Clocks:	None
Device:	Internal Surface-Mount Antenna
Clocks:	None

5.6.2 Co-Located Clock Frequencies

Device:	Peripherals
Clocks:	n/a

Test Report S/N:	090104KBC-T555-E24C/E15B		
Test Date(s):	01Nov04 - 23Nov04		
Test Type:	FCC §2, §15.247, §22H, §24E	IC RSS-210/132/133	
Lab Registration(s):	FCC #714830	IC Lab File #3874	

5.7 Mode(s) of Operation Tested

5.7.1 Dual-Band CDMA Modem

Customer supplied software was used to set the CDMA Modem to the appropriate channel and power level for the specific measurement. Measurements were made with the CDMA modem set to each extreme channel, in each band while the Bluetooth was co-transmitting. The following settings were used for each channel.

5.7.1.1 Cellular CDMA

TX Frequency Range:	824.7 – 848.31 MHz Ch. 1013 (824.700 MHz) & Ch. 777 (848.310 MHz) measured unless otherwise noted
Software Power Gain Settings:	Ch. 1013 – 234 Ch. 777 - 237
RF Peak Conducted Output Power Tested:	Ch. 1013 - +22.92 dBm Ch 777 - +22.99 dBm
Battery Type(s):	11.1V Lithium-ion, 6.0Ah (Model: A2121-2)
Modulation Type:	QPSK

5.7.1.2 PCS CDMA

TX Frequency Range:	1851.25 – 1908.75 MHz Ch. 25 (1851.25 MHz) & Ch. 1175 (1908.75 MHz) measured unless otherwise noted
Software Power Gain Settings:	Ch. 25 - 250 Ch. 1175 - 250
RF Peak Conducted Output Power Tested:	Ch. 25 - +23.06 dBm Ch 1175 - +22.67 dBm
Battery Type(s):	11.1V Lithium-ion, 6.0Ah (Model: A2121-2)
Modulation Type:	QPSK

5.7.2 Bluetooth Transmitter

Customer supplied software was used to set the Bluetooth transmitter to the appropriate mode, power level and modulation for the specific measurement. During the co-transmission testing, the Bluetooth transmitter was placed in hopping mode with the following settings:

TX Frequency Range:	2402 – 2480 MHz
Software Power Gain Settings:	220 /45
RF Peak Conducted Output Power Tested:	Ch. 0 - +14.84 dBm (same settings as single transmit), +16.28 with 220/45 gain settings* Ch. 39 - +15.46 dBm (same settings as single transmit), +15.84 with 220/45 gain settings* Ch. 78 - +15.09 dBm (same settings as single transmit), +15.15 with 220/45 gain settings* *gain settings used during hopping mode
Modulation Type(s):	GFSK 0.5 BT Gaussian

Test Report S/N:	090104KBC-T555-E24C/E15B		
Test Date(s):	01Nov04 - 23Nov04		
Test Type:	FCC §2, §15.247, §22H, §24E	IC RSS-210/132/133	
Lab Registration(s):	FCC #714830	IC Lab File #3874	

5.7.3 DUT Exercising Software Description

The DUT was configured and exercised using customer supplied test software that allowed an operator to set the parameters of the Bluetooth transmitter and Dual-Band CDMA modem operation. The settings used are described in each appendix. More specific information on the configuration and exercising can be found in the referenced single-transmit test reports.

5.8 Configuration Description

The DUT was configured, as described by the client as being representative of what would be delivered to a final customer. Because the swivel dipole antenna orientation can be user configured, prescan evaluations were made to determine the configuration that resulted in the highest emissions. A “horizontal, pointing back” orientation was used for the cellular band, “vertical, pointing up” was used for the PCS band. More specific details may be included in each appendix.

5.8.1 Configuration Justification

The DUT was tested in a configuration described by the client as being worse case but typical of normal use. The system is available for use while installed in a mobile cradle, using a vehicular mounted dipole antenna and the resulting measurements using this configuration were investigated and reported in the single transmitting report. Given that the use of the mobile antenna resulted in greater separation in transmit antennas and lower dominant transmit power, only the worse case configuration using the swivel dipole antenna was used to investigate the co-transmission effects reported herein.

6.0 PASS/FAIL CRITERIA

Unless otherwise noted in the Appendices, the pass/fail criteria is the limit set forth in the reference standards. A DUT is considered to have passed the requirements, if the data collected during the described measurement procedure is no greater than the specified limits as defined. The pass/fail statements made in this report only apply to the unit tested.

Applicant:	Itronix Corporation	Model:	IX260PROA555BT	FCC ID:	KBCIX260PROA555BT	IC ID:	1943A-IX260Pb
Rugged Laptop PC with internal Sierra Wireless AirCard 555/550 Dual-Band CDMA Modem & Cirronet BT2022 Bluetooth							
2004 Celltech Labs Inc	This document is not to be reproduced in whole or in part without the written permission of Celltech Labs Inc.						13 of 53

Test Report S/N:	090104KBC-T555-E24C/E15B		
Test Date(s):	01Nov04 - 23Nov04		
Test Type:	FCC §2, §15.247, §22H, §24E	IC RSS-210/132/133	
Lab Registration(s):	FCC #714830	IC Lab File #3874	

APPENDIX

Applicant:	Itronix Corporation	Model:	IX260PROA555BT	FCC ID:	KBCIX260PROA555BT	IC ID:	1943A-IX260Pb	
Rugged Laptop PC with internal Sierra Wireless AirCard 555/550 Dual-Band CDMA Modem & Cirronet BT2022 Bluetooth								
2004 Celltech Labs Inc	This document is not to be reproduced in whole or in part without the written permission of Celltech Labs Inc.						14 of 53	

Test Report S/N:	090104KBC-T555-E24C/E15B		
Test Date(s):	01Nov04 - 23Nov04		
Test Type:	FCC §2, §15.247, §22H, §24E	IC RSS-210/132/133	
Lab Registration(s):	FCC #714830	IC Lab File #3874	

Appendix A - DUT Photographs

Photograph A-1 – Front of Open IX260+ Laptop PC



Photograph A-2 – Side of Open IX260+ Laptop PC



Photograph A-3 – Dual-Band CDMA Location



Dual-Band CDMA Modem PCMCIA Card

Photograph A-4 – Bluetooth Transmitter Location



Bluetooth Location

Applicant:	Itronix Corporation	Model:	IX260PROA555BT	FCC ID:	KBCIX260PROA555BT	IC ID:	1943A-IX260Pb	
Rugged Laptop PC with internal Sierra Wireless AirCard 555/550 Dual-Band CDMA Modem & Cirronet BT2022 Bluetooth								
2004 Celltech Labs Inc	This document is not to be reproduced in whole or in part without the written permission of Celltech Labs Inc.						15 of 53	

Test Report S/N:	090104KBC-T555-E24C/E15B		
Test Date(s):	01Nov04 - 23Nov04		
Test Type:	FCC §2, §15.247, §22H, §24E	IC RSS-210/132/133	
Lab Registration(s):	FCC #714830	IC Lab File #3874	

Photograph A-5 – Dual-Band CDMA Modem PCMCIA Card

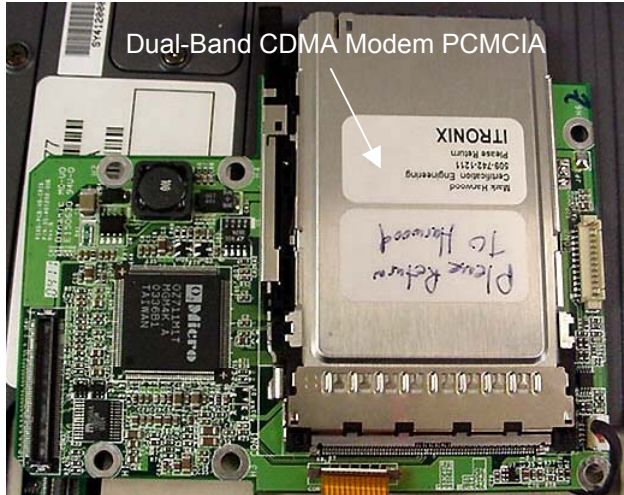

Photograph A-6 – Bluetooth Transmitter

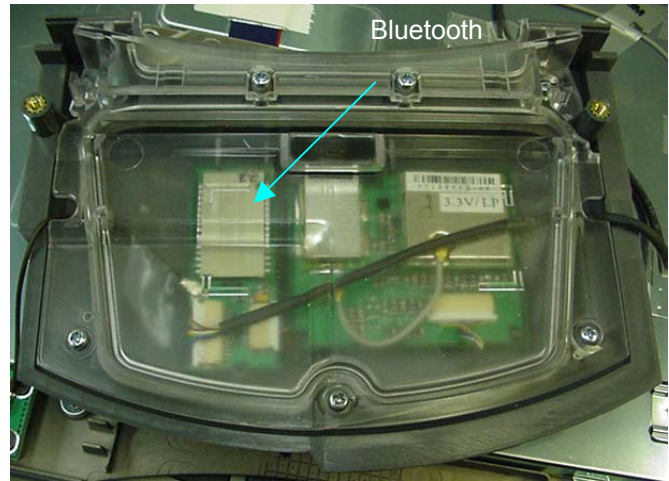

Photograph A-7 – Surface-Mount Antenna Placement



Applicant:	Itronix Corporation	Model:	IX260PROA555BT	FCC ID:	KBCIX260PROA555BT	IC ID:	1943A-IX260Pb	
Rugged Laptop PC with internal Sierra Wireless AirCard 555/550 Dual-Band CDMA Modem & Cirronet BT2022 Bluetooth								
2004 Celltech Labs Inc	This document is not to be reproduced in whole or in part without the written permission of Celltech Labs Inc.						16 of 53	

Test Report S/N:	090104KBC-T555-E24C/E15B		
Test Date(s):	01Nov04 - 23Nov04		
Test Type:	FCC §2, §15.247, §22H, §24E	IC RSS-210/132/133	
Lab Registration(s):	FCC #714830	IC Lab File #3874	

Appendix B - Conducted Powerline Emissions Measurement

B.1. REFERENCES

Normative Reference Standard	CFR 47 FCC Part 15 §15.207
Procedure Reference	ANSI C63.4

B.2. LIMITS

§15.207: Compliance with the provisions of this paragraph shall be based on the measurement of the radio frequency voltage between each powerline and ground at the power terminal.

Frequency of Emission (MHz)	Conducted Limit (dBuV)	
	Quasi-Peak	Average
0.15 – 0.5	66 to 56*	56 to 46*
0.50 – 5.0	56	46
5.0 – 30.0	60	50

*Decrease with the logarithm of the frequency

B.3. ENVIRONMENTAL CONDITIONS

Temperature	+26 ± 5 °C
Humidity	31 % ± 10% RH
Barometric Pressure	101.4 kpa

B.4. EQUIPMENT LIST

ASSET NUMBER	MANUFACTURER	MODEL	DESCRIPTION	LAST CAL	CAL DUE
00063	HP	85662A	Spectrum Analyzer Display	na	na
00051	HP	8566B	Spectrum Analyzer RF Section	18May04	18May05
00049	HP	85650A	Quasi-Peak Adapter	18May04	18May05
00047	HP	85685A	Preselector	18May04	18May05
00083	EMCO	3825/2	Line Impedance Stabilization Network	29Apr04	29Apr05
00084	EMCO	3825/2	Line Impedance Stabilization Network	29Apr04	29Apr05

Test Report S/N:	090104KBC-T555-E24C/E15B		
Test Date(s):	01Nov04 - 23Nov04		
Test Type:	FCC §2, §15.247, §22H, §24E	IC RSS-210/132/133	
Lab Registration(s):	FCC #714830	IC Lab File #3874	

B.5. MEASUREMENT EQUIPMENT SETUP

MEASUREMENT EQUIPMENT CONNECTIONS	The conducted emissions were measured on each of the two AC powerline leads connected to the DUT's power supply brick. A two line LISN was used to make this measurement. A drawing of the equipment setup is shown in B.7
MEASUREMENT EQUIPMENT SETTINGS	<p>Each of the monitor ports from the 2-line LISN was connected in turn to the spectrum analyzer. The port not connected to the analyzer was terminated in a 50-ohm load. A pre-scan of the peak emission levels was made of the 150 kHz – 30 MHz range split into 4 equal frequency bands. The following were the instrumentation settings:</p> <p>Spectrum Analyzer: Start Frequency and Stop Frequency set by software for each of the four bands RBW: 100 kHz VBW: 300 kHz Sweep: 500 mS</p> <p>Quasi-Peak Adapter: Normal - Automatic Bandwidth Setting: 9 kHz</p> <p>The resulting data from each band was corrected and collected by software and presented in the graphical representations shown in B.9 for the two leads.</p> <p>A defined set of frequency points of interest on each lead were used by software to optimize a set of readings for each type of detector (peak, quasi-peak and average). This data was corrected by the software is presented in the tables shown in section B.9.</p>

Test Report S/N:	090104KBC-T555-E24C/E15B		
Test Date(s):	01Nov04 - 23Nov04		
Test Type:	FCC §2, §15.247, §22H, §24E	IC RSS-210/132/133	
Lab Registration(s):	FCC #714830	IC Lab File #3874	

B.6. SETUP PHOTOS

Photograph B-1 – AC Powerline Conducted Emission Configuration

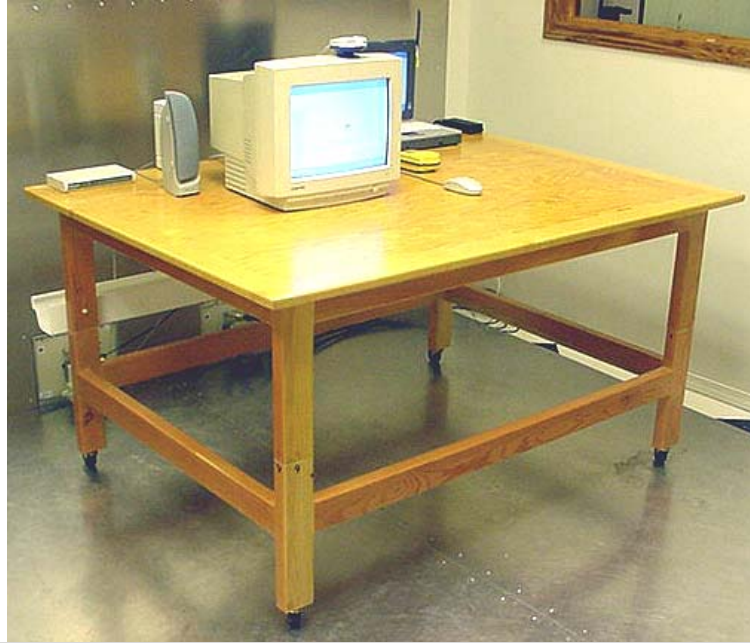

Photograph B-2 – AC Powerline Conducted Emission Cable Placement

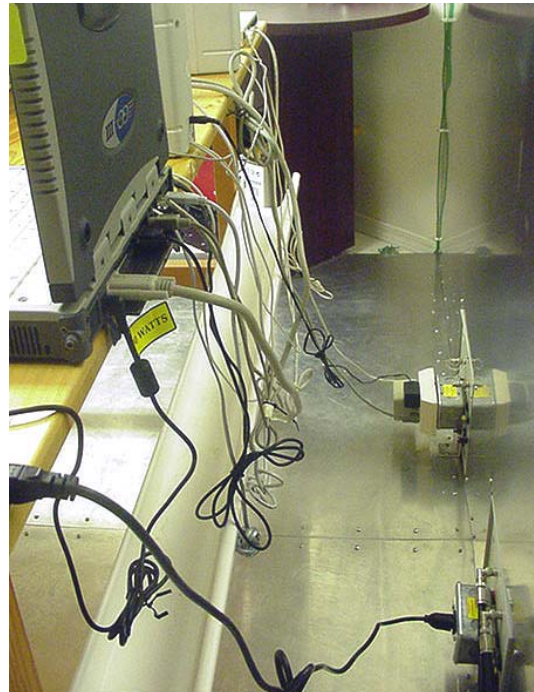

Applicant:	Itronix Corporation	Model:	IX260PROA555BT	FCC ID:	KBCIX260PROA555BT	IC ID:	1943A-IX260Pb	
Rugged Laptop PC with internal Sierra Wireless AirCard 555/550 Dual-Band CDMA Modem & Cirronet BT2022 Bluetooth								
2004 Celltech Labs Inc	This document is not to be reproduced in whole or in part without the written permission of Celltech Labs Inc.						19 of 53	

Test Report S/N:	090104KBC-T555-E24C/E15B		
Test Date(s):	01Nov04 - 23Nov04		
Test Type:	FCC §2, §15.247, §22H, §24E	IC RSS-210/132/133	
Lab Registration(s):	FCC #714830	IC Lab File #3874	

B.7. SETUP DRAWING

Figure B-1 – Setup Drawing

Conducted Emission Measurement Setup

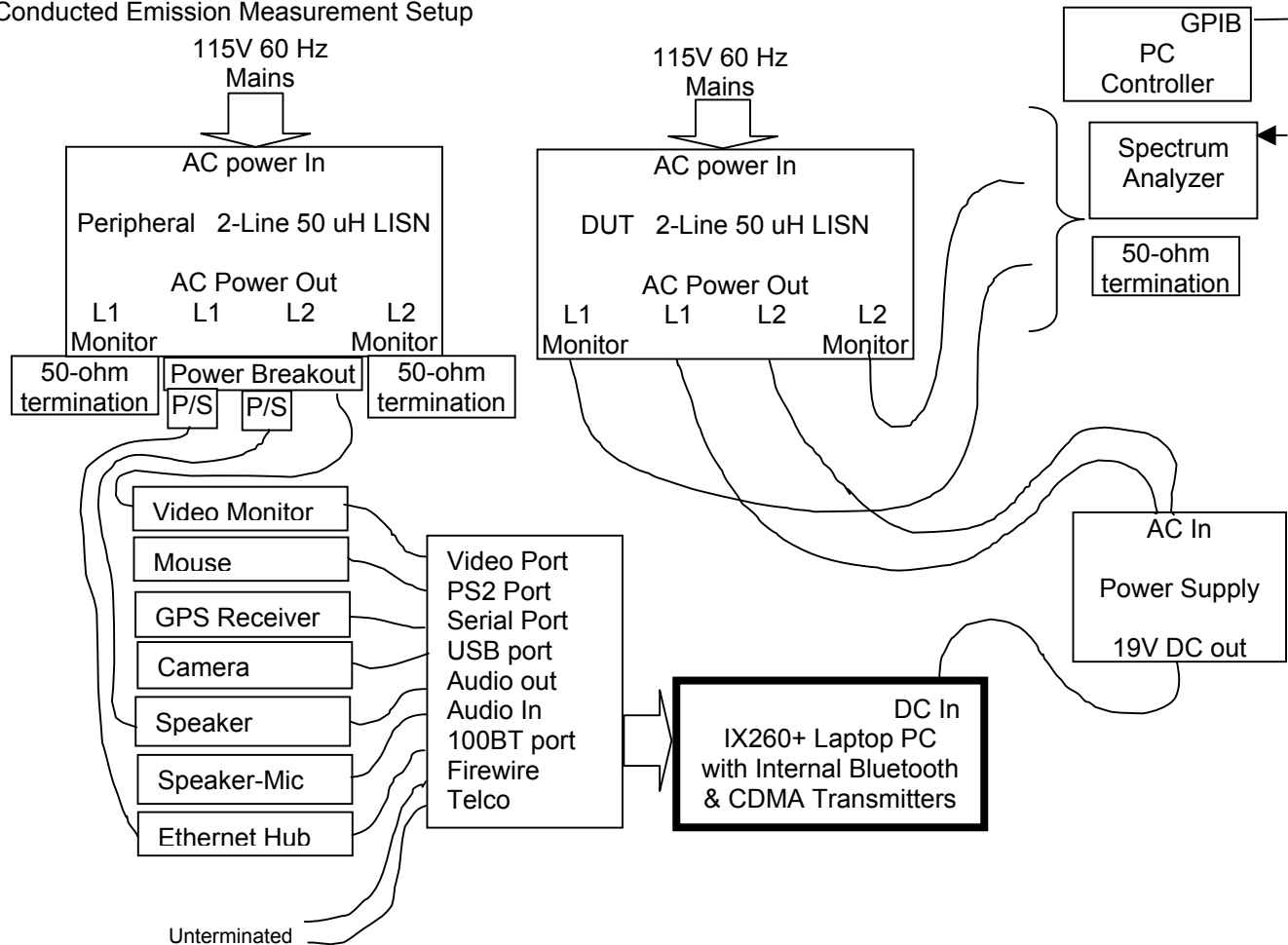

B.8. DUT OPERATING DESCRIPTION

Bluetooth	While hopping channels, the Bluetooth transmitter was set to transmit a data stream with a max. power setting equivalent to that described in the referenced single-transmit test report.
Dual-Band CDMA	The Dual-Band CDMA modem was set to transmit on the channel with the highest radiated power (Ch 1013) with power settings equivalent to that described in the referenced single-transmit test report.
PC	Other than operating the Bluetooth software and running MS windows, no PC exercising was performed.
Peripherals	All peripherals were active, but no specific traffic was initiated.

Applicant:	Itronix Corporation	Model:	IX260PROA555BT	FCC ID:	KBCIX260PROA555BT	IC ID:	1943A-IX260Pb	
Rugged Laptop PC with internal Sierra Wireless AirCard 555/550 Dual-Band CDMA Modem & Cirronet BT2022 Bluetooth								
2004 Celltech Labs Inc		This document is not to be reproduced in whole or in part without the written permission of Celltech Labs Inc.					20 of 53	

Test Report S/N:	090104KBC-T556-E24C/E15B		
Test Date(s):	01Nov04 - 23Nov04		
Test Type:	FCC §2, §15.247, §22H, §24E	IC RSS-210/132/133	
Lab Registration(s):	FCC #714830	IC Lab File #3874	

B.9. TEST RESULTS

Following are peak emission plots and tabular data describing the peak, quasi-peak and average measurements made of the DUT.

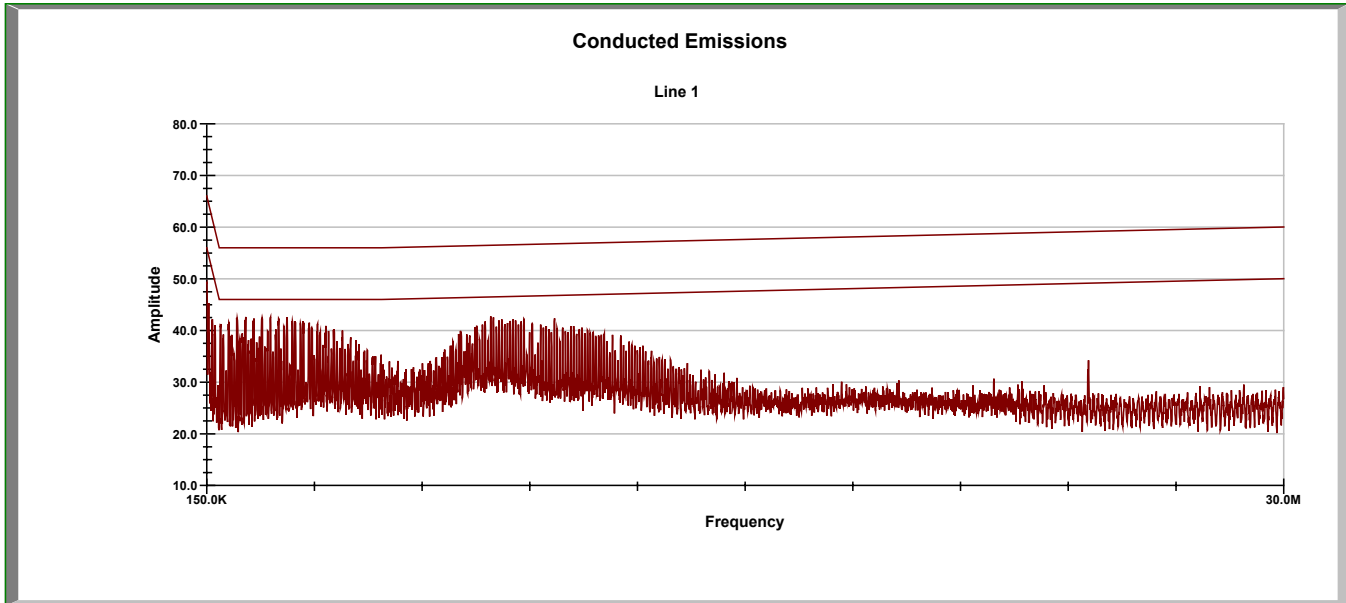

Project Number: 090104KBC-T556-E24C/E15B
Company: Itronix
Product: IX260+ with Cirronet BT2022 with AC555

Standard: FCC 15.207
Test Start Date: 18-Nov-04
Test End Date: 18-Nov-04

Line 1 Conducted Emissions

Frequency MHz	Uncorrected Reading			Correction Factor dB	Corrected Emission Level			Quasi-Peak Limit dBuV	Quasi-Peak Margin dB	Average Limit dBuV	Average Margin dB	Pass/Fail
	Peak dBuV	Quasi-Peak dBuV	Average dBuV		Peak dBuV	Quasi-Peak dBuV	Average dBuV					
0.202	45.60	42.90	33.11	1.40	47.00	44.30	34.51	63.54	19.24	53.54	19.04	Pass
1.223	42.90	42.31	42.27	0.11	43.01	42.42	42.38	56.00	13.59	46.00	3.63	Pass
1.910	42.90	42.27	42.20	0.29	43.19	42.56	42.49	56.00	13.44	46.00	3.51	Pass
2.367	42.80	42.03	41.80	0.29	43.09	42.32	42.09	56.00	13.68	46.00	3.91	Pass
8.014	42.90	41.66	39.72	0.32	43.22	41.98	40.04	60.00	18.02	50.00	9.96	Pass
8.931	42.90	40.59	35.33	0.32	43.22	40.91	35.65	60.00	19.09	50.00	14.35	Pass
9.769	41.90	41.01	37.19	0.00	41.90	41.01	37.19	60.00	18.99	50.00	12.82	Pass
24.579	34.80	31.55	29.23	0.43	35.23	31.98	29.66	60.00	28.02	50.00	20.35	Pass

Corrected Emission Level (dBuV) = Uncorrected Reading (dBuV) + Correction Factor (dB)
Margin (dB) = Limit (dBuV) - Corrected Emission Level (dBuV)

Test Report S/N:	090104KBC-T555-E24C/E15B		
Test Date(s):	01Nov04 - 23Nov04		
Test Type:	FCC §2, §15.247, §22H, §24E	IC RSS-210/132/133	
Lab Registration(s):	FCC #714830	IC Lab File #3874	

Conducted Emissions

Line 2

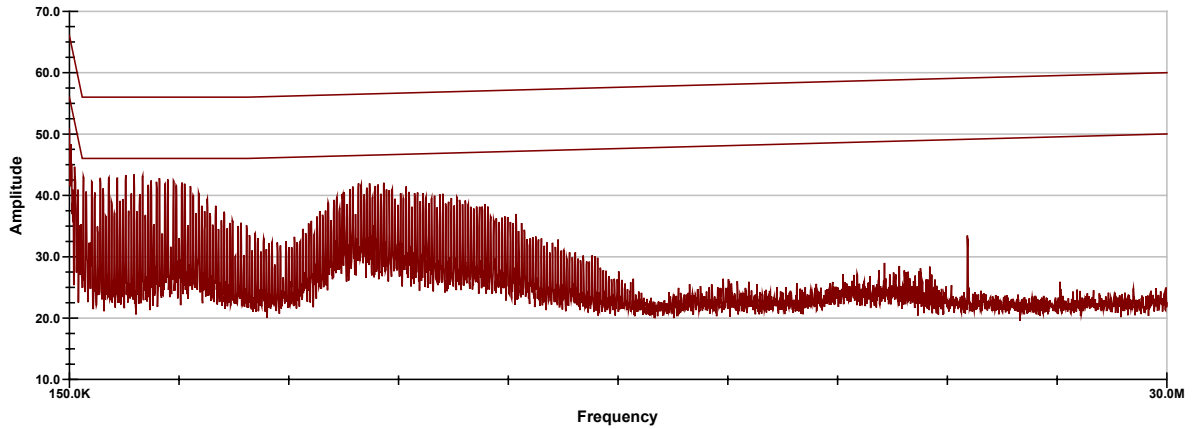

Project Number: 090104KBC-T555-E24C/E15B
Company: Itronix
Product: IX260+ with Cirronet BT2022 with AC555

Standard: FCC 15.207
Test Start Date: 18-Nov-04
Test End Date: 18-Nov-04

Line 2 Conducted Emissions

Frequency MHz	Uncorrected Reading			Correction Factor dB	Corrected Emission Level			Quasi-Peak Limit dBuV	Quasi-Peak Margin dB	Average Limit dBuV	Average Margin dB	Pass/Fail
	Peak dBuV	Quasi-Peak dBuV	Average dBuV		Peak dBuV	Quasi-Peak dBuV	Average dBuV					
0.293	42.10	38.49	19.72	0.86	42.96	39.35	20.58	60.43	21.09	50.43	29.86	Pass
1.678	43.40	42.71	42.79	0.30	43.70	43.01	43.09	56.00	12.99	46.00	2.91	Pass
1.903	43.40	42.53	42.49	0.29	43.69	42.82	42.78	56.00	13.18	46.00	3.22	Pass
8.004	42.00	40.85	39.24	0.34	42.34	41.19	39.57	60.00	18.81	50.00	10.43	Pass
8.691	42.50	40.94	39.50	0.33	42.83	41.27	39.82	60.00	18.73	50.00	10.18	Pass
9.301	40.90	39.83	34.66	0.34	41.24	40.17	35.00	60.00	19.83	50.00	15.00	Pass
24.576	33.70	31.43	29.86	0.43	34.13	31.86	30.29	60.00	28.14	50.00	19.71	Pass

Corrected Emission Level (dBuV) = Uncorrected Reading (dBuV) + Correction Factor (dB)
Margin (dB) = Limit (dBuV) - Corrected Emission Level (dBuV)

Applicant: Itronix Corporation	Model: IX260PROA555BT	FCC ID: KBCIX260PROA555BT	IC ID: 1943A-IX260Pb
Rugged Laptop PC with internal Sierra Wireless AirCard 555/550 Dual-Band CDMA Modem & Cirronet BT2022 Bluetooth			
2004 Celltech Labs Inc	This document is not to be reproduced in whole or in part without the written permission of Celltech Labs Inc.		22 of 53

Test Report S/N:	090104KBC-T555-E24C/E15B		
Test Date(s):	01Nov04 - 23Nov04		
Test Type:	FCC §2, §15.247, §22H, §24E	IC RSS-210/132/133	
Lab Registration(s):	FCC #714830	IC Lab File #3874	

B.10. PASS/FAIL

In reference to the results outlined in B.9 the DUT passes the requirements as stated in the reference standards as follows:
 The RF voltage measured in reference to ground on each of the power line conductors does not exceed the limits as outline in FCC 15.207.

B.11. SIGN-OFF

I attest to the accuracy of the data. All measurements reported herein were performed by me and are correct to the best of my knowledge and belief. I assume full responsibility for the completeness of these measurements.



 Russell Pipe
 Senior Compliance Technologist
 Celltech Labs Inc.

 18Nov04
 Date

Test Report S/N:	090104KBC-T555-E24C/E15B		
Test Date(s):	01Nov04 - 23Nov04		
Test Type:	FCC §2, §15.247, §22H, §24E	IC RSS-210/132/133	
Lab Registration(s):	FCC #714830	IC Lab File #3874	

Appendix C – Bluetooth Peak Conducted RF Output Power Measurement

C.1. REFERENCES

Normative Reference Standard	FCC CFR 47 §15.247(b) (3)
Procedure Reference	FCC 97-114

C.2. LIMITS

C.2.1. FCC CFR

§15.247(b): The maximum peak output power of the intentional radiator shall not exceed the following:
 §15.247(b) (3) For system using digital modulation in the 902 – 928 MHz, 2400 – 2483.5 MHz, and 5725 – 5850 MHz bands: 1 Watt.

*This measurement was made as a reference to determine the effects the co-transmission of the CDMA Modem made to the output RF power of the Bluetooth transmitter. The single transmit RF conducted output power levels where reported as:

Channel	Frequency	Peak Conducted Power	
		dBm	Watts
	MHz		
0	2402	15.40	.0347
39	2441	15.61	.0364
78	2480	15.34	.0342

C.3. ENVIRONMENTAL CONDITIONS

Temperature	25.2 +/- 2 °C
Humidity	35 +/- 2 %
Barometric Pressure	96.34 kPa

C.4. EQUIPMENT LIST

ASSET NUMBER	MANUFACTURER	MODEL	DESCRIPTION	LAST CAL	CAL DUE
00015	Agilent	E4408B	Spectrum Analyzer	29Dec03	29Dec04
00075	Alpha Wire-J	9223	2ft. RG223/U RF Cable	08Jul04*	24Jun05
00076	Pasternack	PE7014-30	30dB 2 Watt Attenuator	08Jul04*	24Jun05

*Cable and attenuator verified with power meter prior to use

Test Report S/N:	090104KBC-T555-E24C/E15B		
Test Date(s):	01Nov04 - 23Nov04		
Test Type:	FCC §2, §15.247, §22H, §24E	IC RSS-210/132/133	
Lab Registration(s):	FCC #714830	IC Lab File #3874	

C.5. MEASUREMENT EQUIPMENT SETUP

Measurement Equipment Connections	The equipment was connected as shown in the setup drawing in C.6.
Measurement Equipment Settings	<p>To evaluate the maximum peak power, the 26 dB bandwidth needs to be determined. This is performed with the spectrum analyzer using the following setting:</p> <p>RBW – 300 kHz VBW – 1MHz Span – 50 MHz Detector – Peak Average – Power Trace Average – 100</p> <p>Once the 26 dB bandwidth is determined, the channel power is measured within the band with the following spectrum analyzer settings:</p> <p>RBW – 1 MHz VBW – 3 MHz Detector – Peak Average – Power Integrate BW – equal to specific -26 dB EBW</p>

C.6. SETUP DRAWING

Figure C-1 – Setup Drawing

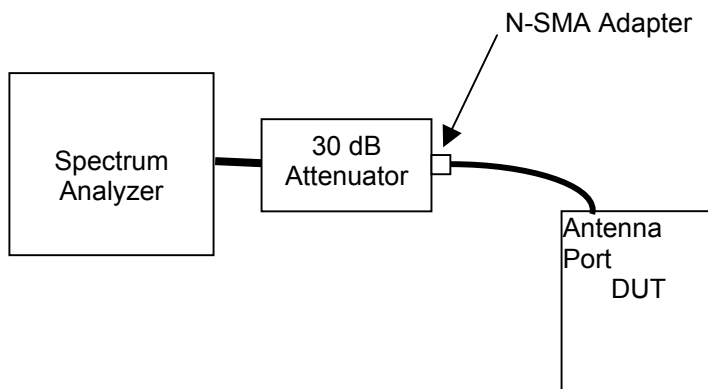

C.7. DUT OPERATING DESCRIPTION

Measurements were made at three channels throughout the band, Low Channel (0) (2402 MHz), Mid Channel (39) (2441 MHz), High Channel (78) (2480 MHz).

Applicant:	Itronix Corporation	Model:	IX260PROA555BT	FCC ID:	KBCIX260PROA555BT	IC ID:	1943A-IX260Pb	
Rugged Laptop PC with internal Sierra Wireless AirCard 555/550 Dual-Band CDMA Modem & Cirronet BT2022 Bluetooth								
2004 Celltech Labs Inc	This document is not to be reproduced in whole or in part without the written permission of Celltech Labs Inc.						25 of 53	

Test Report S/N:	090104KBC-T555-E24C/E15B		
Test Date(s):	01Nov04 - 23Nov04		
Test Type:	FCC §2, §15.247, §22H, §24E	IC RSS-210/132/133	
Lab Registration(s):	FCC #714830	IC Lab File #3874	

C.8. TEST RESULTS				
Channel	Frequency	Peak Conducted Power		Limit
	MHz	dBm	Watts	Watts
0 (Low)	2402	14.84	.03048	1
39 (Mid)	2441	15.46	.03516	1
79 (High)	2480	15.09	.03229	1

C.9. PASS/FAIL

In reference to the results outlined in C.8, the DUT passes the requirements as stated in the reference standards as follows: FCC 15.247 (b) (3): The peak power did not exceed 1 Watt.

As a reference with the single transmit configuration, the conducted power levels are reduced by a maximum 0.56 dB (15.40 vs 14.84 dBm) when the CDMA transmitter is active.

C.10. SIGN-OFF

I attest to the accuracy of the data. All measurements reported herein were performed by me and are correct to the best of my knowledge and belief. I assume full responsibility for the completeness of these measurements.



Russell Pipe
Senior Compliance Technologist
Celltech Labs Inc.

18Nov04
Date

Applicant:	Itronix Corporation	Model:	IX260PROA555BT	FCC ID:	KBCIX260PROA555BT	IC ID:	1943A-IX260Pb	
Rugged Laptop PC with internal Sierra Wireless AirCard 555/550 Dual-Band CDMA Modem & Cirronet BT2022 Bluetooth								
2004 Celltech Labs Inc	This document is not to be reproduced in whole or in part without the written permission of Celltech Labs Inc.						26 of 53	

Test Report S/N:	090104KBC-T555-E24C/E15B		
Test Date(s):	01Nov04 - 23Nov04		
Test Type:	FCC §2, §15.247, §22H, §24E	IC RSS-210/132/133	
Lab Registration(s):	FCC #714830	IC Lab File #3874	

Appendix D - Radiated Spurious Emissions Measurement

D.1. REFERENCES

Normative Reference Standard	FCC CFR 47 §15.247(c)
Procedure Reference	ANSI C63.4; FCC 97-114

D.2. LIMITS

D.2.1. FCC CFR 47

§15.247 (c): In any 100 kHz bandwidth outside the frequency band in which the spread spectrum or digitally modulated intentional radiator is operating, the radio frequency power that is produced by the intentional radiator shall be at least 20 dB below that in the 100 kHz bandwidth within the band that contains the highest level of desired power, based on either an RF conducted or a radiated measurement. Attenuation below the general limits specified in 15.209 (a) is not required.

Note: Spurious emissions within the restricted bands are reported in Appendix E.

D.3. ENVIRONMENTAL CONDITIONS

Temperature	27.4 +/- 2 °C
Humidity	33 +/- 2 %
Barometric Pressure	96.24 +/- 0.2 kPa

D.4. EQUIPMENT LIST

ASSET NUMBER	MANUFACTURER	MODEL	DESCRIPTION	LAST CAL	CAL DUE
00072	EMCO	2075	Mini-mast	n/a	n/a
00073	EMCO	2080	Turn Table	n/a	n/a
00071	EMCO	2090	Multi-Device Controller	n/a	n/a
00050	EMCO	3121C	Dipole Antenna	30Apr04	30Apr05
00035	ETS	3115	Double Ridged Guide Horn	24Mar04	24Mar05
00202	ETS	3160-09	Small Horn Antenna	27May04	27Jun05
00015	Agilent	E4408B	Spectrum Analyzer	29Dec03	29Dec04
00049	HP	8566B	Spectrum Analyzer RF Section	18May04	18May05
00049	HP	85650A	Quasi-peak Adapter	18May04	18May05
00047	HP	85685A	RF Preselector	18May04	18May05
00048	Gore	65474	Microwave Cable	20May04	20May05
00030	HP	83017A	LNA	20May04	20May05

Test Report S/N:	090104KBC-T555-E24C/E15B		
Test Date(s):	01Nov04 - 23Nov04		
Test Type:	FCC §2, §15.247, §22H, §24E	IC RSS-210/132/133	
Lab Registration(s):	FCC #714830	IC Lab File #3874	

D.5. MEASUREMENT EQUIPMENT SETUP

MEASUREMENT EQUIPMENT CONNECTIONS	The measurement equipment was connected as shown in D.6. A number of antennas were used to cover the applicable frequency range tested ¹ . The ranges in which each antenna was used are as follows:			
	Frequency Range		Antenna	
	30 MHz – 1GHz		Dipole	
	1 GHz – 18 GHz		ETS 3115 Horn	
MEASUREMENT EQUIPMENT SETTINGS	For the spurious out-of-band emissions, the spectrum analyzer was set to the following settings:			
	Frequency Range	RBW	VBW	Detector
	MHz	kHz	kHz	
	<1000	100	300	Peak ²
	> 1000	1000*	1000	Peak ²
	Note 1: Only ranges where inter-modulation products might occur were investigated.			
Note 2: As a worse case measurement, the average limit was applied to measurements made with a peak detector using a RBW of 1 MHz (vs the specified 100 kHz), when possible.				
For the Bluetooth band-edge delta-marker radiated measurements, the spectrum analyzer was set for 30 kHz RBW and VBW and the delta marker applied to radiated carrier levels measured at a 3-meter distance with the resolutions as defined above.				

D.6. SETUP DRAWING

Figure D-1 – Setup Drawing

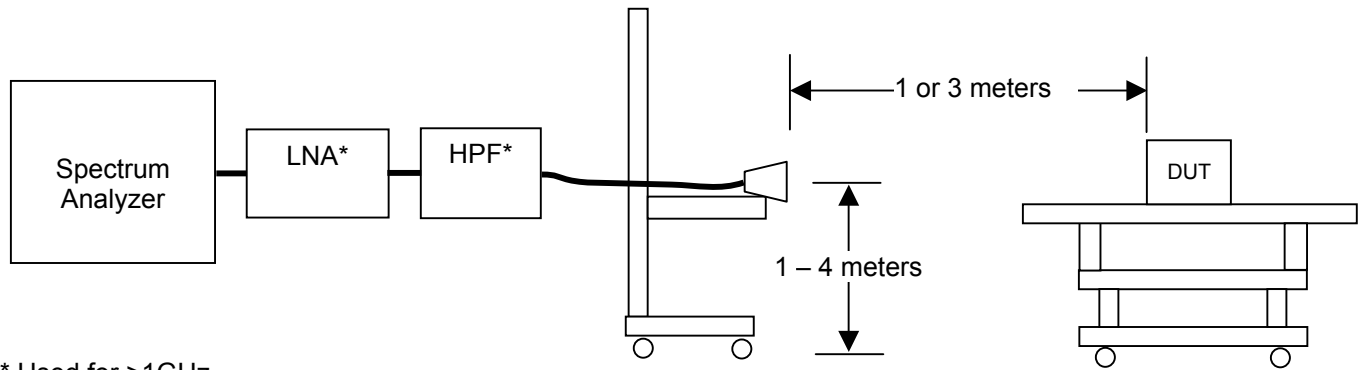

* Used for >1GHz

Test Report S/N:	090104KBC-T555-E24C/E15B		
Test Date(s):	01Nov04 - 23Nov04		
Test Type:	FCC §2, §15.247, §22H, §24E	IC RSS-210/132/133	
Lab Registration(s):	FCC #714830	IC Lab File #3874	

D.7. SETUP PHOTOGRAPHS

Photograph D-1 – 3115 Horn Antenna



D.8. DUT OPERATING DESCRIPTION

Measurements were made of the bands that may contain inter-modulation products with both the Bluetooth and CDMA radios transmitting. Measurements were made for each combination of low and high CDMA channel transmitting while the Bluetooth was in hopping mode. The Bluetooth power setting was set to worst case (highest recorded conducted power) with CDMA power settings equivalent to those described in the referenced single-transmit test reports.

D.9. TEST RESULTS

With the exception of the Cellular and PCS CDMA block-edge and Bluetooth band-edge measurements not adjacent to restricted bands, all significant inter-modulations products or representative noise floor levels were measured as they related to the restricted band limit. This comparison was worst-case (versus an out of band emission limit comparison) and is described in Appendix E of this report. The band-edge as described above is presented in the following tables. The CDMA block-edge is presented in Appendix H. All other spurious emissions are described in the appropriate sections in the individual reports referenced.

Applicant:	Itronix Corporation	Model:	IX260PROA555BT	FCC ID:	KBCIX260PROA555BT	IC ID:	1943A-IX260Pb	
Rugged Laptop PC with internal Sierra Wireless AirCard 555/550 Dual-Band CDMA Modem & Cirronet BT2022 Bluetooth								
2004 Celltech Labs Inc	This document is not to be reproduced in whole or in part without the written permission of Celltech Labs Inc.						29 of 53	

Test Report S/N:	090104KBC-T556-E24C/E15B		
Test Date(s):	01Nov04 - 23Nov04		
Test Type:	FCC §2, §15.247, §22H, §24E	IC RSS-210/132/133	
Lab Registration(s):	FCC #714830	IC Lab File #3874	

D.9.1. Bluetooth Band-edge Spurious Field Strength (co-transmitting with Cellular CDMA)

		Project Number: 090104KBC-T556-E24C/E15B	Standard: FCC15.247
		Company: Itronix	Test Start Date: 01Nov04
		Product: IX260+ with AC555 & Bluetooth	Test End Date: 23Nov04

Bluetooth with AC555 Cellular CDMA (CH1013)													
Channel	Polarity	Distance	Frequency	Carrier Radiated Field Strength	Marker-Delta	Detector	Calculated Band-edge Field Strength	Limit Distance	Duty Cycle Correction	Corrected Calculated Band-edge Field Strength	Specified Limit	Margin	Pass/Fail
		m	MHz	dBuV/m	dBuV		dBuV/m	m	dB	dBuV/m	dBuV/m	dB	
0	H	3	2400.00	117.52	47.19	PK	70.33	3.00	-20.00	50.33	97.52	47.19	Pass
0	H	3	2400.00	117.52	47.19	AV	70.33	3.00	-20.00	50.33	97.52	47.19	Pass
0	V	3	2400.00	112.72	48.88	PK	63.84	3.00	-20.00	43.84	97.52	53.68	Pass
0	V	3	2400.00	112.76	48.88	AV	63.88	3.00	-20.00	43.88	97.52	53.64	Pass

Bluetooth with AC555 Cellular CDMA (CH777)													
Channel	Polarity	Distance	Frequency	Carrier Radiated Field Strength	Marker-Delta	Detector	Calculated Band-edge Field Strength	Limit Distance	Duty Cycle Correction	Corrected Calculated Band-edge Field Strength	Specified Limit	Margin	Pass/Fail
		m	MHz	dBuV/m	dBuV		dBuV/m	m	dB	dBuV/m	dBuV/m	dB	
0	H	3	2400.00	117.52	43.75	PK	73.77	3.00	-20.00	53.77	97.52	43.75	Pass
0	H	3	2400.00	117.52	43.75	AV	73.77	3.00	-20.00	53.77	97.52	43.75	Pass
0	V	3	2400.00	112.72	47.62	PK	65.10	3.00	-20.00	45.10	97.52	52.42	Pass
0	V	3	2400.00	112.76	47.62	AV	65.14	3.00	-20.00	45.14	97.52	52.38	Pass

Formulae:
 Total CF (dB) = Antenna Factor (dB) + Cable Factor (dB) + Other Factor (Amplifier Gain, Filter Loss, etc) (dB)
 Field Strength (dBuV/m) = SA Reading (dBuV) + Total CF (dB/m)
 Limit (dBuV/m) = Published Limit (dBuV/m) + Limit Distance Correction (dB)
 Margin (dB) = Limit (dBuV/m) - Field Strength (dBuV/m)
 Duty Cycle Correction (dB) = 20 * log (max time transmitting in 100 mS (mS) / 100 mS)
 Corrected Calculated Band-edge Field Strength (dBuV/m) = Calculated Band-edge Field Strength (dBuV/m) + Duty Cycle Correction (dB)

*band-edge measurements of edges adjacent to restricted bands are outlined in Appendix E of this report.

D.9.2. Bluetooth Band-edge Spurious Field Strength (co-transmitting with PCS CDMA)

		Project Number: 090104KBC-T556-E24C/E15B	Standard: FCC15.247
		Company: Itronix	Test Start Date: 01Nov04
		Product: IX260+ with AC555 & Bluetooth	Test End Date: 23Nov04

Bluetooth with AC555 PCS CDMA (CH25)													
Channel	Polarity	Distance	Frequency	Carrier Radiated Field Strength	Marker-Delta	Detector	Calculated Band-edge Field Strength	Limit Distance	Duty Cycle Correction	Corrected Calculated Band-edge Field Strength	Specified Limit	Margin	Pass/Fail
		m	MHz	dBuV/m	dBuV		dBuV/m	m	dB	dBuV/m	dBuV/m	dB	
0	H	3	2400.00	117.52	45.02	PK	72.50	3.00	-20.00	52.50	97.52	45.02	Pass
0	H	3	2400.00	117.52	45.02	AV	72.50	3.00	-20.00	52.50	97.52	45.02	Pass
0	V	3	2400.00	112.72	52.16	PK	60.56	3.00	-20.00	40.56	97.52	56.96	Pass
0	V	3	2400.00	112.76	52.16	AV	60.60	3.00	-20.00	40.60	97.52	56.92	Pass

Bluetooth with AC555 PCS CDMA (CH1175)													
Channel	Polarity	Distance	Frequency	Carrier Radiated Field Strength	Marker-Delta	Detector	Calculated Band-edge Field Strength	Limit Distance	Duty Cycle Correction	Corrected Calculated Band-edge Field Strength	Specified Limit	Margin	Pass/Fail
		m	MHz	dBuV/m	dBuV		dBuV/m	m	dB	dBuV/m	dBuV/m	dB	
0	H	3	2400.00	117.52	44.35	PK	73.17	3.00	-20.00	53.17	97.52	44.35	Pass
0	H	3	2400.00	117.52	44.35	AV	73.17	3.00	-20.00	53.17	97.52	44.35	Pass
0	V	3	2400.00	112.72	52.93	PK	59.79	3.00	-20.00	39.79	97.52	57.73	Pass
0	V	3	2400.00	112.76	52.93	AV	59.83	3.00	-20.00	39.83	97.52	57.69	Pass

Formulae:
 Total CF (dB) = Antenna Factor (dB) + Cable Factor (dB) + Other Factor (Amplifier Gain, Filter Loss, etc) (dB)
 Field Strength (dBuV/m) = SA Reading (dBuV) + Total CF (dB/m)
 Limit (dBuV/m) = Published Limit (dBuV/m) + Limit Distance Correction (dB)
 Margin (dB) = Limit (dBuV/m) - Field Strength (dBuV/m)
 Duty Cycle Correction (dB) = 20 * log (max time transmitting in 100 mS (mS) / 100 mS)
 Corrected Calculated Band-edge Field Strength (dBuV/m) = Calculated Band-edge Field Strength (dBuV/m) + Duty Cycle Correction (dB)

*band-edge measurements of edges adjacent to restricted bands are outlined in Appendix E of this report.

Applicant: Itronix Corporation	Model: IX260PROA555BT	FCC ID: KBCIX260PROA555BT	IC ID: 1943A-IX260Pb
Rugged Laptop PC with internal Sierra Wireless AirCard 555/550 Dual-Band CDMA Modem & Cirronet BT2022 Bluetooth			
2004 Celltech Labs Inc	This document is not to be reproduced in whole or in part without the written permission of Celltech Labs Inc.		30 of 53

Test Report S/N:	090104KBC-T555-E24C/E15B		
Test Date(s):	01Nov04 - 23Nov04		
Test Type:	FCC §2, §15.247, §22H, §24E	IC RSS-210/132/133	
Lab Registration(s):	FCC #714830	IC Lab File #3874	

D.10. PASS/FAIL

In reference to the results outlined in D.9 & E.9, the DUT passes the requirements as stated in the reference standards as follows:

FCC 15.247 (c): All emissions within any 100kHz bandwidth outside the operating frequency band are greater than 20 dB below the maximum 100 kHz bandwidth signal within the operating band.

D.11. SIGN-OFF

I attest to the accuracy of the data. All measurements reported herein were performed by me and are correct to the best of my knowledge and belief. I assume full responsibility for the completeness of these measurements.



Russell Pipe
Senior Compliance Technologist
Celltech Labs Inc.

23Nov04

Date

Applicant:	Itronix Corporation	Model:	IX260PROA555BT	FCC ID:	KBCIX260PROA555BT	IC ID:	1943A-IX260Pb	
Rugged Laptop PC with internal Sierra Wireless AirCard 555/550 Dual-Band CDMA Modem & Cirronet BT2022 Bluetooth								
2004 Celltech Labs Inc		This document is not to be reproduced in whole or in part without the written permission of Celltech Labs Inc.					31 of 53	

Test Report S/N:	090104KBC-T555-E24C/E15B		
Test Date(s):	01Nov04 - 23Nov04		
Test Type:	FCC §2, §15.247, §22H, §24E	IC RSS-210/132/133	
Lab Registration(s):	FCC #714830	IC Lab File #3874	

Appendix E - Restricted Band Emissions Measurement

E.1. REFERENCES

Normative Reference Standard	FCC CFR 47 §15.205 (a) (b), FCC CFR 47 §15.209 (a)
Procedure Reference	FCC 97-114

E.2. LIMITS

FCC CFR 47 §15.205 (a) Except as shown in paragraph (d) of this section, only spurious emissions are permitted in any of the frequency bands listed below:

MHz	MHz	MHz	GHz
0.090-0.110	16.42-16.423	399.9-410	4.5-5.15
10.495-0.505	16.69475-16.69525	608-614	5.35-5.46
2.1735-2.1905	16.80425-16.80475	960-1240	7.25-7.75
4.125-4.128	25.5-25.67	1300-1427	8.025-8.5
4.17725-4.17775	37.5-38.25	1435-1626.5	9.0-9.2
4.20725-4.20775	73-74.6	1645.5-1646.5	9.3-9.5
6.215-6.218	74.8-75.2	1660-1710	10.6-12.7
6.26775-6.26825	108-121.94	1718.8-1722.2	13.25-13.4
6.31175-6.31225	123-138	2200-2300	14.47-14.5
8.291-8.294	149.9-150.05	2310-2390	15.35-16.2
8.362-8.366	156.52475-156.52525	2483.5-2500	17.7-21.4
8.37625-8.38675	156.7-156.9	2655-2900	22.01-23.12
8.41425-8.41475	162.0125-167.17	3260-3267	23.6-24.0
12.29-12.293	167.72-173.2	3332-3339	31.2-31.8
12.51975-12.52025	240-285	3345.8-3358	36.43-36.5
12.57675-12.57725	322-335.4	3600-4400	(2)
13.36-13.41			

¹ Until February 1, 1999, this restricted band shall be 0.490-0.510 MHz.

² Above 38.6

(b) Except as provided in paragraphs (d) and (e), the field strength of emissions appearing within these frequency bands shall not exceed the limits shown in 15.209. At frequencies equal to or less than 1000 MHz, compliance with the limits in Section 15.209 shall be demonstrated using measurement instrumentation employing a CISPR quasi-peak detector. Above 1000 MHz, compliance with the emission limits in Section 15.209 shall be demonstrated based on the average value of the measured emissions. The provisions of 15.35 apply to these measurements.

FCC CFR 47 §15.209 (a) Except as provided elsewhere in this Subpart, the emissions from an intentional radiator shall not exceed the field strength levels specified in the following table:

Frequency	Field Strength	Measurement Distance
MHz	uV/m	Meters
.009 - 0.490	2400/F(kHz)	300
0.490 - 1.705	24000/F(kHz)	30
1.705 - 30.0	30	30
30 - 88	100	3
88 - 216	150	3
216 - 960	200	3
Above 960	500	3

(b) In the emission table above, the tighter limit applies at the band edges.

Test Report S/N:	090104KBC-T555-E24C/E15B		
Test Date(s):	01Nov04 - 23Nov04		
Test Type:	FCC §2, §15.247, §22H, §24E	IC RSS-210/132/133	
Lab Registration(s):	FCC #714830	IC Lab File #3874	

E.3. ENVIRONMENTAL CONDITIONS

Temperature	27.4 +/- 2 °C
Humidity	33 +/- 2 %
Barometric Pressure	96.24 +/- 0.2 kPa

E.4. EQUIPMENT LIST

ASSET NUMBER	MANUFACTURER	MODEL	DESCRIPTION	LAST CAL	CAL DUE
00072	EMCO	2075	Mini-mast	n/a	n/a
00073	EMCO	2080	Turn Table	n/a	n/a
00071	EMCO	2090	Multi-Device Controller	n/a	n/a
00035	ETS	3115	Double Ridged Guide Horn	24Mar04	24Mar05
00202	ETS	3160-09	Small Horn Antenna	27May04	27Jun05
00015	Agilent	E4408B	Spectrum Analyzer	29Dec03	29Dec04
00049	HP	8566B	Spectrum Analyzer RF Section	18May04	18May05
00049	HP	85650A	Quasi-peak Adapter	18May04	18May05
00047	HP	85685A	RF Preselector	18May04	18May05
00048	Gore	65474	Microwave Cable	20May04	20May05
00030	HP	83017A	LNA	20May04	20May05

Applicant:	Itronix Corporation	Model:	IX260PROA555BT	FCC ID:	KBCIX260PROA555BT	IC ID:	1943A-IX260Pb
Rugged Laptop PC with internal Sierra Wireless AirCard 555/550 Dual-Band CDMA Modem & Cirronet BT2022 Bluetooth							
2004 Celltech Labs Inc	This document is not to be reproduced in whole or in part without the written permission of Celltech Labs Inc.						33 of 53

Test Report S/N:	090104KBC-T555-E24C/E15B		
Test Date(s):	01Nov04 - 23Nov04		
Test Type:	FCC §2, §15.247, §22H, §24E	IC RSS-210/132/133	
Lab Registration(s):	FCC #714830	IC Lab File #3874	

E.5. MEASUREMENT EQUIPMENT SETUP

MEASUREMENT EQUIPMENT CONNECTIONS	The measurement equipment was connected as shown in E.6. A number of antennas were used to cover the applicable frequency range test ¹ . The ranges in which each antenna was used are as follows:			
	Frequency Range		Antenna	
	1 GHz – 18 GHz		ETS 3115 Horn	
MEASUREMENT EQUIPMENT SETTINGS	The spectrum analyzer was set to the following settings:			
	Frequency Range	RBW	VBW	Detector
	MHz	kHz	kHz	
	> 1000	1000*	1000	
	Note 1: Only ranges where inter-modulation products might occur were investigated.			
Note 2: As a worse case measurement, the average limits were applied to measurements made with a peak detector when acceptable margin existed.				

E.6. SETUP DRAWING

Figure E-1 – Setup Drawing

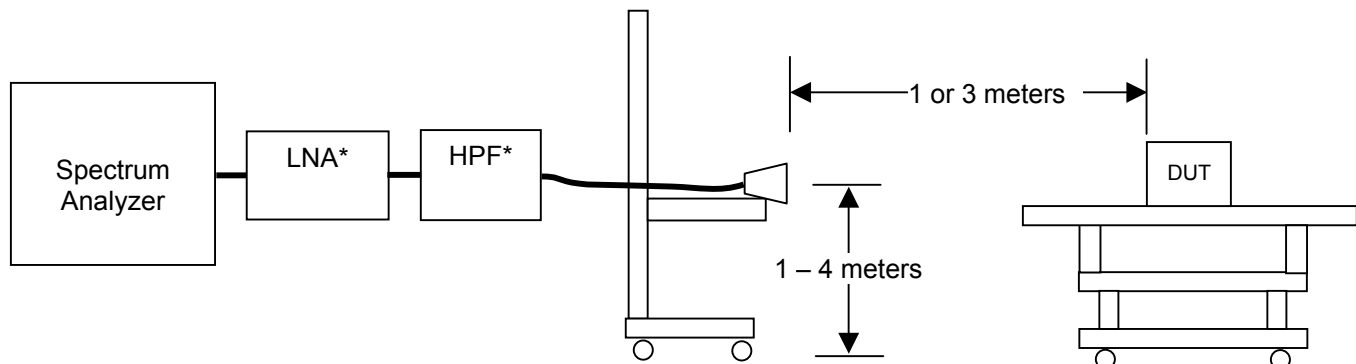

* Used for >1GHz

Test Report S/N:	090104KBC-T555-E24C/E15B		
Test Date(s):	01Nov04 - 23Nov04		
Test Type:	FCC §2, §15.247, §22H, §24E	IC RSS-210/132/133	
Lab Registration(s):	FCC #714830	IC Lab File #3874	

E.7. SETUP PHOTOGRAPHS

Photograph E-1 – 3115 Vertical Polarization (10 GHz – 18 GHz)



Photograph E-2 - Front of Radiated Emission Configuration



Photograph E-3 - Back of Radiated Emission Configuration

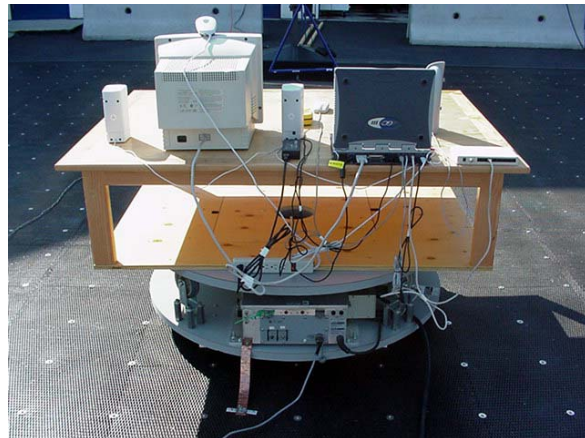

E.8. DUT OPERATING DESCRIPTION

Measurements were made of the bands that may contain inter-modulation products with both the Bluetooth and CDMA radios transmitting. Measurements were made for each combination of low and high CDMA channel transmitting while the bluetooth was in hopping mode. The bluetooth power setting was set to worst case (highest recorded conducted power) with CDMA power settings equivalent to those described in the referenced single-transmit test reports.

Applicant:	Itronix Corporation	Model:	IX260PROA555BT	FCC ID:	KBCIX260PROA555BT	IC ID:	1943A-IX260Pb	
Rugged Laptop PC with internal Sierra Wireless AirCard 555/550 Dual-Band CDMA Modem & Cirronet BT2022 Bluetooth								
2004 Celltech Labs Inc	This document is not to be reproduced in whole or in part without the written permission of Celltech Labs Inc.						35 of 53	

Test Report S/N:	090104KBC-T555-E24C/E15B		
Test Date(s):	01Nov04 - 23Nov04		
Test Type:	FCC §2, §15.247, §22H, §24E	IC RSS-210/132/133	
Lab Registration(s):	FCC #714830	IC Lab File #3874	

E.9. TEST RESULTS

E.9.1. Bluetooth Band-edge Spurious Field Strength (adjacent to restricted bands & co-transmitting with Cellular CDMA)



Project Number: 090104KBC-T556-E24C/E15B
Company: Itronix
Product: IX260+ with AC555 & Bluetooth

Standard: FCC15.247
Test Start Date: 01Nov04
Test End Date: 23Nov04

Bluetooth with AC555 Cellular CDMA (CH1013)													
Channel	Polarity	Distance	Frequency	Carrier Radiated Field Strength	Marker-Delta	Detector	Calculated Band-edge Field Strength	Limit Distance	Duty Cycle Correction	Corrected Calculated Band-edge Field Strength	Specified Limit	Margin	Pass/Fail
0	H	3	2390.00	117.22	60.29	PK	56.93	3.00	-20.00	36.93	73.98	37.05	Pass
0	H	3	2390.00	117.22	60.29	AV	56.93	3.00	-20.00	36.93	53.98	17.05	Pass
0	V	3	2390.00	112.38	48.88	PK	63.50	3.00	-20.00	43.50	73.98	30.48	Pass
0	V	3	2390.00	112.30	48.88	AV	63.42	3.00	-20.00	43.42	53.98	10.56	Pass
79	H	3	2483.50	115.38	55.27	PK	60.11	3.00	-20.00	40.11	73.98	33.87	Pass
79	H	3	2483.50	115.38	55.27	AV	60.11	3.00	-20.00	40.11	53.98	13.87	Pass
79	V	3	2483.50	109.64	57.85	PK	51.79	3.00	-20.00	31.79	73.98	42.19	Pass
79	V	3	2483.50	109.56	57.85	AV	51.71	3.00	-20.00	31.71	53.98	22.27	Pass

Bluetooth with AC555 Cellular CDMA (CH777)													
Channel	Polarity	Distance	Frequency	Carrier Radiated Field Strength	Marker-Delta	Detector	Calculated Band-edge Field Strength	Limit Distance	Duty Cycle Correction	Corrected Calculated Band-edge Field Strength	Specified Limit	Margin	Pass/Fail
0	H	3	2390.00	117.22	60.14	PK	57.08	3.00	-20.00	37.08	73.98	36.90	Pass
0	H	3	2390.00	117.22	60.14	AV	57.08	3.00	-20.00	37.08	53.98	16.90	Pass
0	V	3	2390.00	112.38	47.62	PK	64.76	3.00	-20.00	44.76	73.98	29.22	Pass
0	V	3	2390.00	112.30	47.62	AV	64.68	3.00	-20.00	44.68	53.98	9.30	Pass
79	H	3	2483.50	115.38	55.42	PK	59.96	3.00	-20.00	39.96	73.98	34.02	Pass
79	H	3	2483.50	115.38	55.42	AV	59.96	3.00	-20.00	39.96	53.98	14.02	Pass
79	V	3	2483.50	109.64	56.67	PK	52.97	3.00	-20.00	32.97	73.98	41.01	Pass
79	V	3	2483.50	109.56	56.67	AV	52.89	3.00	-20.00	32.89	53.98	21.09	Pass

Formulae:

- Total CF (dB) = Antenna Factor (dB) + Cable Factor (dB) + Other Factor (Amplifier Gain, Filter Loss, etc) (dB)
- Field Strength (dBuV/m) = SA Reading (dBuV) + Total CF (dB/m)
- Limit (dBuV/m) = Published Limit (dBuV/m) + Limit Distance Correction (dB)
- Margin (dB) = Limit (dBuV/m) - Field Strength (dBuV/m)
- Duty Cycle Correction (dB) = 20 * log (max time transmitting in 100 mS (mS) / 100 mS)
- Corrected Calculated Band-edge Field Strength (dBuV/m) = Calculated Band-edge Field Strength (dBuV/m) + Duty Cycle Correction (dB)

* Duty cycle correction based on a maximum transmit time of 10 mS in any 100 mS time slice.

Test Report S/N:	090104KBC-T555-E24C/E15B		
Test Date(s):	01Nov04 - 23Nov04		
Test Type:	FCC §2, §15.247, §22H, §24E	IC RSS-210/132/133	
Lab Registration(s):	FCC #714830	IC Lab File #3874	

E.9.2. Bluetooth Band-edge Spurious Field Strength (adjacent to restricted bands & co-transmitting with PCS CDMA)



Project Number: 090104KBC-T556-E24C/E15B
Company: Itronix
Product: IX260+ with AC555 & Bluetooth

Standard: FCC15.247
Test Start Date: 01Nov04
Test End Date: 23Nov04

Bluetooth with AC555 PCS CDMA (CH25)													
Channel	Polarity	Distance	Frequency	Carrier Radiated Field Strength	Marker-Delta	Detector	Calculated Band-edge Field Strength	Limit Distance	Duty Cycle Correction	Corrected Calculated Band-edge Field Strength	Specified Limit	Margin	Pass/Fail
0	H	3	2390.00	117.22	61.37	PK	55.85	3.00	-20.00	35.85	73.98	38.13	Pass
0	H	3	2390.00	117.22	61.37	AV	55.85	3.00	-20.00	35.85	53.98	18.13	Pass
0	V	3	2390.00	112.38	52.16	PK	60.22	3.00	-20.00	40.22	73.98	33.76	Pass
0	V	3	2390.00	112.30	52.16	AV	60.14	3.00	-20.00	40.14	53.98	13.84	Pass
79	H	3	2483.50	115.38	55.36	PK	60.02	3.00	-20.00	40.02	73.98	33.96	Pass
79	H	3	2483.50	115.38	55.36	AV	60.02	3.00	-20.00	40.02	53.98	13.96	Pass
79	V	3	2483.50	109.64	53.76	PK	55.88	3.00	-20.00	35.88	73.98	38.10	Pass
79	V	3	2483.50	109.56	53.76	AV	55.80	3.00	-20.00	35.80	53.98	18.18	Pass

Bluetooth with AC555 PCS CDMA (CH1175)													
Channel	Polarity	Distance	Frequency	Carrier Radiated Field Strength	Marker-Delta	Detector	Calculated Band-edge Field Strength	Limit Distance	Duty Cycle Correction	Corrected Calculated Band-edge Field Strength	Specified Limit	Margin	Pass/Fail
0	H	3	2390.00	117.22	57.70	PK	59.52	3.00	-20.00	39.52	73.98	34.46	Pass
0	H	3	2390.00	117.22	57.70	AV	59.52	3.00	-20.00	39.52	53.98	14.46	Pass
0	V	3	2390.00	112.38	52.93	PK	59.45	3.00	-20.00	39.45	73.98	34.53	Pass
0	V	3	2390.00	112.30	52.93	AV	59.37	3.00	-20.00	39.37	53.98	14.61	Pass
79	H	3	2483.50	115.38	56.69	PK	58.69	3.00	-20.00	38.69	73.98	35.29	Pass
79	H	3	2483.50	115.38	56.69	AV	58.69	3.00	-20.00	38.69	53.98	15.29	Pass
79	V	3	2483.50	109.64	53.17	PK	56.47	3.00	-20.00	36.47	73.98	37.51	Pass
79	V	3	2483.50	109.56	53.17	AV	56.39	3.00	-20.00	36.39	53.98	17.59	Pass

Formulae:

- Total CF (dB) = Antenna Factor (dB)+ Cable Factor (dB) + Other Factor (Amplifier Gain, Filter Loss, etc) (dB)
- Field Strength (dBuV/m) = SA Reading (dBuV) + Total CF (dB/m)
- Limit (dBuV/m) = Published Limit (dBuV/m) + Limit Distance Correction (dB)
- Margin (dB) = Limit (dBuV/m) - Field Strength (dBuV/m)
- Duty Cycle Correction (dB) = 20 * log (max time transmitting in 100 mS (mS) / 100 mS)
- Corrected Calculated Band-edge Field Strength (dBuV/m)= Calculated Band-edge Field Strength (dBuV/m) + Duty Cycle Correction (dB)

* Duty cycle correction based on a maximum transmit time of 10 mS in any 100 mS time slice.

Test Report S/N:	090104KBC-T556-E24C/E15B		
Test Date(s):	01Nov04 - 23Nov04		
Test Type:	FCC §2, §15.247, §22H, §24E	IC RSS-210/132/133	
Lab Registration(s):	FCC #714830	IC Lab File #3874	

E.9.3. Spurious Field Strength @ Specified Distance (Cellular CDMA Low Channel with Bluetooth Hopping)

		Project Number: 090104KBC-T556-E24C/E15B	Standard: FCC15.209
		Company: Itronix	Test Start Date: 01Nov04
		Product: IX260+ with BT2200 Bluetooth & AC555 CDMA Modem	Test End Date: 18Nov04

Cellular CDMA Channel 1013 (824.7 MHz) with Bluetooth Hopping																		
Channel	Polarity	Distance	Rx Antenna	Frequency	SA Level	Noise Floor	Rx AF	Rx CL	Other Rx	Total Rx CF	Field Strength	Detector	Limit Distance	Limit Distance Correction	Calculated Limit	Lower Limit	Margin	Pass/Fail
		m		MHz	dBuV		dB/m	dB	dB	dB/m	dBuV/m	PK/QP/AV	m	dB	dBuV/m		dB	
1013	H	3	Horn SN6276	3979.30	41.80	x	34.64	4.54	-34.00	5.19	46.99	PK	3.00	0.00	53.98	*	6.99	PASS
1013	H	3	Horn SN6276	4135.30	41.70	x	34.70	4.64	-34.01	5.33	47.03	PK	3.00	0.00	53.98	*	6.95	PASS
1013	H	3	Horn SN6276	3259.00	41.20	x	32.67	4.07	-34.00	2.74	43.94	PK	3.00	0.00	53.98	*	10.04	PASS
1013	V	3	Horn SN6276	1577.30	38.21	x	27.57	2.82	0.00	30.39	68.60	PK	3.00	0.00	73.98		5.38	PASS
1013	V	3	Horn SN6276	1577.30	22.61	x	27.57	2.82	0.00	30.39	53.00	AV	3.00	0.00	53.98		0.98	PASS
1013	V	3	Horn SN6276	3979.30	41.60	x	34.64	4.54	-34.00	5.19	46.79	PK	3.00	0.00	53.98	*	7.19	PASS
1013	V	3	Horn SN6276	4855.00	41.90	x	35.41	5.01	-34.09	6.33	48.23	PK	3.00	0.00	53.98	*	5.74	PASS
1013	V	3	Horn SN6276	4954.75	42.40	x	35.61	5.06	-34.10	6.57	48.97	PK	3.00	0.00	53.98	*	5.01	PASS
1013	V	3	Horn SN6276	4135.30	41.10	x	34.70	4.64	-34.01	5.33	46.43	PK	3.00	0.00	53.98	*	7.55	PASS

E.9.4. Spurious Field Strength @ Specified Distance (Cellular CDMA High Channel with Bluetooth Hopping)

		Project Number: 090104KBC-T556-E24C/E15B	Standard: FCC15.209
		Company: Itronix	Test Start Date: 01Nov04
		Product: IX260+ with BT2200 Bluetooth & AC555 CDMA Modem	Test End Date: 18Nov04

Cellular CDMA Channel 777 (848.3 MHz) with Bluetooth Hopping																		
Channel	Polarity	Distance	Rx Antenna	Frequency	SA Level	Noise Floor	Rx AF	Rx CL	Other Rx	Total Rx CF	Field Strength	Detector	Limit Distance	Limit Distance Correction	Calculated Limit	Lower Limit	Margin	Pass/Fail
		m		MHz	dBuV		dB/m	dB	dB	dB/m	dBuV/m	PK/QP/AV	m	dB	dBuV/m		dB	
777	H	3	Horn SN6276	1553.69	34.21	x	27.46	2.82	0.00	30.28	64.49	PK	3.00	0.00	73.98		9.49	PASS
777	H	3	Horn SN6276	1553.69	18.83	x	27.46	2.82	0.00	30.28	49.11	AV	3.00	0.00	53.98		4.87	PASS
777	H	3	Horn SN6276	1581.00	33.65	x	27.59	2.82	0.00	30.41	64.06	PK	3.00	0.00	73.98		9.92	PASS
777	H	3	Horn SN6276	1581.00	19.75	x	27.59	2.82	0.00	30.41	50.16	AV	3.00	0.00	53.98		3.82	PASS
777	H	3	Horn SN6276	1697.00	41.25		28.15	2.90	0.00	31.04	72.29	PK	3.00	0.00	73.98		1.69	PASS
777	H	3	Horn SN6276	1697.00	20.01		28.15	2.90	0.00	31.04	51.05	AV	3.00	0.00	53.98		2.93	PASS
777	H	3	Horn SN6276	3275.00	41.50	x	32.72	4.08	-34.00	2.79	44.29	PK	3.00	0.00	53.98	*	9.69	PASS
777	H	3	Horn SN6276	3955.69	40.30	x	34.58	4.56	-34.00	5.14	45.44	PK	3.00	0.00	53.98	*	8.54	PASS
777	H	3	Horn SN6276	4111.69	41.80	x	34.70	4.60	-34.01	5.29	47.09	PK	3.00	0.00	53.98	*	6.89	PASS
777	V	3	Horn SN6276	1553.69	34.43	x	27.46	2.82	0.00	30.28	64.71	PK	3.00	0.00	73.98		9.27	PASS
777	V	3	Horn SN6276	1553.69	19.30	x	27.46	2.82	0.00	30.28	49.58	AV	3.00	0.00	53.98		4.40	PASS
777	V	3	Horn SN6276	1612.00	34.02	x	27.74	2.82	0.00	30.56	64.58	PK	3.00	0.00	73.98		9.40	PASS
777	V	3	Horn SN6276	1612.00	19.64	x	27.74	2.82	0.00	30.56	50.20	AV	3.00	0.00	53.98		3.78	PASS
777	V	3	Horn SN6276	1698.00	34.23		28.15	2.90	0.00	31.05	65.28	PK	3.00	0.00	73.98		8.70	PASS
777	V	3	Horn SN6276	1698.00	20.74		28.15	2.90	0.00	31.05	51.79	AV	3.00	0.00	53.98		2.19	PASS
777	V	3	Horn SN6276	3955.69	40.70	x	34.58	4.56	-34.00	5.14	45.84	PK	3.00	0.00	53.98	*	8.14	PASS
777	V	3	Horn SN6276	4111.69	40.50	x	34.70	4.60	-34.01	5.29	45.79	PK	3.00	0.00	53.98	*	8.19	PASS
777	V	3	Horn SN6276	3275.00	40.60	x	32.72	4.08	-34.00	2.79	43.39	PK	3.00	0.00	53.98	*	10.59	PASS

Formulae:
 Total CF (dB) = Antenna Factor (dB) + Cable Factor (dB) + Other Factor (Amplifier Gain, Filter Loss, etc) (dB)
 Field Strength (dBuV/m) = SA Reading (dBuV) + Total CF (dB/m)
 Limit Distance Correction (dB) = 40 * log(d1/d2) for f < 30 MHz, 20*log(d1/d2) for f > 30 MHz; where d1 is the measurement distance and d2 is the published limit distance
 Limit (dBuV/m) = Published Limit (dBuV/m) + Limit Distance Correction (dB)
 Margin (dB) = Limit (dBuV/m) - Field Strength (dBuV/m)

*Where there is acceptable margin between the peak emission reported and the average limit stated, the average limit is referenced. Where the average limit is exceeded by the peak emission or the margin unacceptable, the peak limit is referenced and an average measurement made and referenced to the average limit.

The frequency points reported describe the highest local emission measured and are used to describe the measured inter-modulation product or band-edge of interest. No out-of-band emissions were measured above the levels noted.

Applicant: Itronix Corporation	Model: IX260PROA555BT	FCC ID: KBCIX260PROA555BT	IC ID: 1943A-IX260Pb
Rugged Laptop PC with internal Sierra Wireless AirCard 555/550 Dual-Band CDMA Modem & Cirronet BT2022 Bluetooth			
2004 Celltech Labs Inc		This document is not to be reproduced in whole or in part without the written permission of Celltech Labs Inc.	
			38 of 53

Test Report S/N:	090104KBC-T556-E24C/E15B		
Test Date(s):	01Nov04 - 23Nov04		
Test Type:	FCC §2, §15.247, §22H, §24E	IC RSS-210/132/133	
Lab Registration(s):	FCC #714830	IC Lab File #3874	

E.9.5. Spurious Field Strength @ Specified Distance (PCS CDMA Low Channel with Bluetooth Hopping)



Project Number: 090104KBC-T556-E24C/E15B
Company: Itronix
Product: IX260+ with BT2200 Bluetooth & AC555 CDMA Modem

Standard: FCC15.209
Test Start Date: 01Nov04
Test End Date: 18Nov04

PCS CDMA Channel 25 (1851.25 MHz) with Bluetooth Hopping

Channel	Polarity	Distance	Rx Antenna	Frequency	SA Level	Noise Floor	Rx AF	Rx CL	Other Rx	Total Rx CF	Field Strength	Detector	Limit Distance	Limit Distance Correction	Calculated Limit	Lower Limit	Margin	Pass/Fail
		m		MHz	dBuV		dB/m	dB	dB	dB/m	dBuV/m	PK/QP/AV	m	dB	dBuV/m		dB	
25	H	3	Horn SN6276	1222.50	36.92	x	26.81	2.45	0.00	29.26	66.18	PK	3.00	0.00	73.98		7.80	PASS
25	H	3	Horn SN6276	1222.50	19.92	x	26.81	2.45	0.00	29.26	49.18	AV	3.00	0.00	53.98		4.80	PASS
25	H	3	Horn SN6276	1300.50	18.83	x	26.92	2.54	0.00	29.46	48.29	PK	3.00	0.00	53.98	*	5.69	PASS
25	H	3	Horn SN6276	3703.50	40.40	x	33.87	4.46	-34.00	4.33	44.73	PK	3.00	0.00	53.98	*	9.25	PASS
25	H	3	Horn SN6276	4253.25	40.00	x	34.70	4.67	-34.03	5.35	45.35	PK	3.00	0.00	53.98	*	8.63	PASS
25	H	3	Horn SN6276	4331.25	40.70	x	34.70	4.71	-34.03	5.37	46.07	PK	3.00	0.00	53.98	*	7.91	PASS
25	H	3	Horn SN6276	4907.50	41.80	x	35.52	5.05	-34.09	6.48	48.28	PK	3.00	0.00	53.98	*	5.70	PASS
25	H	3	Horn SN6276	7249.00	47.80	x	38.25	6.31	-34.32	10.24	58.04	PK	3.00	0.00	73.98		15.94	PASS
25	H	3	Horn SN6276	7249.00	38.20	x	38.25	6.31	-34.32	10.24	48.44	AV	3.00	0.00	53.98		5.54	PASS
25	H	3	Horn SN6276	8374.00	47.70	x	39.32	6.79	-34.29	11.83	59.53	PK	3.00	0.00	73.98		14.45	PASS
25	H	3	Horn SN6276	8374.25	37.10	x	39.32	6.79	-34.29	11.83	48.93	AV	3.00	0.00	53.98		5.05	PASS
25	V	3	Horn SN6276	1222.50	19.11	x	26.81	2.45	0.00	29.26	48.37	PK	3.00	0.00	53.98	*	5.61	PASS
25	V	3	Horn SN6276	1300.50	36.73	x	26.92	2.54	0.00	29.46	66.19	PK	3.00	0.00	73.98		7.79	PASS
25	V	3	Horn SN6276	1300.50	19.29	x	26.92	2.54	0.00	29.46	48.75	AV	3.00	0.00	53.98		5.23	PASS
25	V	3	Horn SN6276	2727.00	49.00		31.13	3.68	-19.96	14.84	63.84	PK	3.00	0.00	73.98		10.14	PASS
25	V	3	Horn SN6276	2727.00	35.80		31.13	3.68	-19.96	14.84	50.64	AV	3.00	0.00	53.98		3.34	PASS
25	V	3	Horn SN6276	2784.00	32.00	x	31.31	3.72	-19.93	15.10	47.10	PK	3.00	0.00	73.98		26.88	PASS
25	V	3	Horn SN6276	2784.00	21.00	x	31.31	3.72	-19.93	15.10	36.10	AV	3.00	0.00	53.98		17.88	PASS
25	V	3	Horn SN6276	3703.50	40.20	x	33.87	4.46	-34.00	4.33	44.53	PK	3.00	0.00	53.98	*	9.45	PASS
25	V	3	Horn SN6276	4253.25	40.70	x	34.70	4.67	-34.03	5.35	46.05	PK	3.00	0.00	53.98	*	7.93	PASS
25	V	3	Horn SN6276	4331.25	40.40	x	34.70	4.71	-34.03	5.37	45.77	PK	3.00	0.00	53.98	*	8.21	PASS
25	V	3	Horn SN6276	4860.25	41.50	x	35.42	5.02	-34.09	6.35	47.85	PK	3.00	0.00	53.98	*	6.13	PASS
25	V	3	Horn SN6276	7355.75	48.10	x	38.44	6.33	-34.32	10.45	58.55	PK	3.00	0.00	73.98		15.43	PASS
25	V	3	Horn SN6276	7355.00	38.00	x	38.44	6.33	-34.32	10.45	48.45	AV	3.00	0.00	53.98		5.53	PASS
25	V	3	Horn SN6276	8372.50	47.20	x	39.32	6.79	-34.29	11.83	59.03	PK	3.00	0.00	73.98		14.95	PASS
25	V	3	Horn SN6276	8372.50	37.20	x	39.32	6.79	-34.29	11.83	49.03	AV	3.00	0.00	53.98		4.95	PASS

Formulae:

Total CF (dB) = Antenna Factor (dB) + Cable Factor (dB) + Other Factor (Amplifier Gain, Filter Loss, etc) (dB)
 Field Strength (dBuV/m) = SA Reading (dBuV) + Total CF (dB/m)
 Limit Distance Correction (dB) = 40 * log(d1/d2) for f < 30 MHz, 20*log(d1/d2) for f > 30 MHz; where d1 is the measurement distance and d2 is the published limit distance
 Limit (dBuV/m) = Published Limit (dBuV/m) + Limit Distance Correction (dB)
 Margin (dB) = Limit (dBuV/m) - Field Strength (dBuV/m)

*The frequency points reported describe the highest local emission measured and are used to describe the measured inter-modulation product or band-edge of interest. No out-of-band emissions were measured above the levels noted.

Where there is acceptable margin between the peak emission reported and the average limit stated, the average limit is referenced. Where the average limit is exceeded by the peak emission or the margin unacceptable, the peak limit is referenced and an average measurement made and referenced to the average limit.

Test Report S/N:	090104KBC-T555-E24C/E15B		
Test Date(s):	01Nov04 - 23Nov04		
Test Type:	FCC §2, §15.247, §22H, §24E	IC RSS-210/132/133	
Lab Registration(s):	FCC #714830	IC Lab File #3874	

E.9.6. Spurious Field Strength @ Specified Distance (PCS CDMA High Channel with Bluetooth Hopping)



Project Number: 090104KBC-T555-E24C/E15B
Company: Itronix
Product: IX260+ with BT2200 Bluetooth & AC555 CDMA Modem

Standard: FCC15.209
Test Start Date: 01Nov04
Test End Date: 18Nov04

PCS CDMA Channel 1175 (1908.75 MHz) with Bluetooth Hopping

Channel	Polarity	Distance	Rx Antenna	Frequency	SA Level	Noise Floor	Rx AF	Rx CL	Other Rx	Total Rx CF	Field Strength	Detector	Limit Distance	Limit Distance Correction	Calculated Limit	Lower Limit	Margin	Pass/Fail
		m		MHz	dBuV		dB/m	dB	dB	dB/m	dBuV/m	(PK/QP/AV)	m	dB	dBuV/m		dB	
1175	H	3	Horn SN6276	1337.50	32.14	x	26.97	2.57	0.00	29.54	61.68	PK	3.00	0.00	73.98		12.29	PASS
1175	H	3	Horn SN6276	1337.50	18.31	x	26.97	2.57	0.00	29.54	47.85	AV	3.00	0.00	53.98		6.12	PASS
1175	H	3	Horn SN6276	1415.50	33.16	x	27.08	2.64	0.00	29.72	62.88	PK	3.00	0.00	73.98		11.10	PASS
1175	H	3	Horn SN6276	1415.50	18.16	x	27.08	2.64	0.00	29.72	47.88	AV	3.00	0.00	53.98		6.10	PASS
1175	H	3	Horn SN6276	2895.25	31.90	x	31.66	3.79	-19.87	15.58	47.48	PK	3.00	0.00	53.98	*	6.49	PASS
1175	H	3	Horn SN6276	4361.50	41.20	x	34.70	4.72	-34.04	5.38	46.58	PK	3.00	0.00	73.98		27.40	PASS
1175	H	3	Horn SN6276	4361.50	30.70	x	34.70	4.72	-34.04	5.38	36.08	AV	3.00	0.00	53.98		17.90	PASS
1175	H	3	Horn SN6276	4310.75	42.00	x	34.70	4.70	-34.03	5.36	47.36	PK	3.00	0.00	73.98		26.61	PASS
1175	H	3	Horn SN6276	4310.75	31.40	x	34.70	4.70	-34.03	5.36	36.76	PK	3.00	0.00	53.98	*	17.21	PASS
1175	H	3	Horn SN6276	4388.75	41.80	x	34.70	4.72	-34.04	5.39	47.19	PK	3.00	0.00	73.98		26.79	PASS
1175	H	3	Horn SN6276	4388.75	30.90	x	34.70	4.72	-34.04	5.39	36.29	PK	3.00	0.00	53.98	*	17.69	PASS
1175	V	3	Horn SN6276	1337.50	37.22	x	26.97	2.57	0.00	29.54	66.76	PK	3.00	0.00	73.98		7.21	PASS
1175	V	3	Horn SN6276	1337.50	19.92	x	26.97	2.57	0.00	29.54	49.46	AV	3.00	0.00	53.98		4.51	PASS
1175	V	3	Horn SN6276	1415.50	35.73	x	27.08	2.64	0.00	29.72	65.45	PK	3.00	0.00	73.98		8.53	PASS
1175	V	3	Horn SN6276	1415.50	19.77	x	27.08	2.64	0.00	29.72	49.49	AV	3.00	0.00	53.98		4.49	PASS
1175	V	3	Horn SN6276	2895.25	31.40	x	31.66	3.79	-19.87	15.58	46.98	PK	3.00	0.00	53.98	*	6.99	PASS
1175	V	3	Horn SN6276	3817.25	61.40	x	34.19	4.44	-34.00	4.62	66.02	PK	3.00	0.00	73.98		7.96	PASS
1175	V	3	Horn SN6276	3817.25	48.70	x	34.19	4.44	-34.00	4.62	53.32	AV	3.00	0.00	53.98		0.66	PASS
1175	V	3	Horn SN6276	3817.25	46.10	x	34.19	4.44	-34.00	4.62	50.72	PK	3.00	0.00	73.98		23.26	PASS
1175	V	3	Horn SN6276	3817.25	34.40	x	34.19	4.44	-34.00	4.62	39.02	AV	3.00	0.00	53.98		14.96	PASS
1175	V	3	Horn SN6276	4337.00	42.60	x	34.70	4.71	-34.03	5.38	47.98	PK	3.00	0.00	73.98		26.00	PASS
1175	V	3	Horn SN6276	4337.00	31.30	x	34.70	4.71	-34.03	5.38	36.68	AV	3.00	0.00	53.98		17.30	PASS
1175	V	3	Horn SN6276	4388.75	41.90	x	34.70	4.72	-34.04	5.39	47.29	PK	3.00	0.00	73.98		26.69	PASS
1175	V	3	Horn SN6276	4388.75	31.10	x	34.70	4.72	-34.04	5.39	36.49	AV	3.00	0.00	53.98		17.49	PASS

Formulae:
 Total CF (dB) = Antenna Factor (dB) + Cable Factor (dB) + Other Factor (Amplifier Gain, Filter Loss, etc) (dB)
 Field Strength (dBuV/m) = SA Reading (dBuV) + Total CF (dB/m)
 Limit Distance Correction (dB) = 40 * log(d1/d2) for f < 30 MHz, 20*log(d1/d2) for f > 30 MHz; where d1 is the measurement distance and d2 is the published limit distance
 Limit (dBuV/m) = Published Limit (dBuV/m) + Limit Distance Correction (dB)
 Margin (dB) = Limit (dBuV/m) - Field Strength (dBuV/m)

*The frequency points reported describe the highest local emission measured and are used to describe the measured inter-modulation product or band-edge of interest. No out-of-band emissions were measured above the levels noted.

Where there is acceptable margin between the peak emission reported and the average limit stated, the average limit is referenced. Where the average limit is exceeded by the peak emission or the margin unacceptable, the peak limit is referenced and an average measurement made and referenced to the average limit.

Test Report S/N:	090104KBC-T555-E24C/E15B		
Test Date(s):	01Nov04 - 23Nov04		
Test Type:	FCC §2, §15.247, §22H, §24E	IC RSS-210/132/133	
Lab Registration(s):	FCC #714830	IC Lab File #3874	

E.10. PASS/FAIL

In reference to the results outlined in E.9, the DUT passes the requirements as stated in the reference standards as follows:
 FCC 15.205 (a) (b) and 15.209 (a): No emissions were measured within the restricted bands as outlined in 15.205 that exceeded the limits stated in 15.209.

E.11. SIGN-OFF

I attest to the accuracy of the data. All measurements reported herein were performed by me and are correct to the best of my knowledge and belief. I assume full responsibility for the completeness of these measurements.



 Russell Pipe
 Senior Compliance Technologist
 Celltech Labs Inc.

 23Nov04
 Date

Test Report S/N:	090104KBC-T555-E24C/E15B		
Test Date(s):	01Nov04 - 23Nov04		
Test Type:	FCC §2, §15.247, §22H, §24E	IC RSS-210/132/133	
Lab Registration(s):	FCC #714830	IC Lab File #3874	

Appendix F - Maximum Permissible Exposure Calculation

F.1. REFERENCES

Normative Reference Standard	FCC CFR 47§1.1310 IEEE Std C95.1-1999
Procedure Reference	FCC CFR 47§2.1091

F.2. LIMITS

FCC CFR 47§1.1310 Table 1(b)	Frequency	Power Density
	300 – 1500 MHz	f/1500 mW/cm ²
	1500 – 100,000 MHz	1.0 mW/cm ²

F.3. ENVIRONMENTAL CONDITIONS

Temperature	na
Humidity	na
Barometric Pressure	na

F.4. EQUIPMENT LIST

ASSET NUMBER	MANUFACTURER	MODEL	DESCRIPTION	LAST CAL	CAL DUE
na					

F.5. MEASUREMENT EQUIPMENT SETUP

MEASUREMENT EQUIPMENT CONNECTIONS	The results described herein were determined by calculations, so no measurement equipment was used. The power measurements for each radio used in these calculations were made with the system co-transmitting as described in Appendix C and G of this report.
MEASUREMENT EQUIPMENT SETTINGS	na

F.6. SETUP PHOTOS

na

F.7. SETUP DRAWINGS

na

F.8. DUT OPERATING DESCRIPTION

Bluetooth	Power Measurement: While hopping channels, the Bluetooth transmitter was set to transmit a data stream with a max. power setting equivalent to that described in the referenced single-transmit test report (220/45).
Dual-Band CDMA	Power Measurement: The Dual-Band CDMA modem was set to transmit on the channel with the highest radiated power in each band with power settings equivalent to that described in the referenced single-transmit test report.

Test Report S/N:	090104KBC-T555-E24C/E15B		
Test Date(s):	01Nov04 - 23Nov04		
Test Type:	FCC §2, §15.247, §22H, §24E	IC RSS-210/132/133	
Lab Registration(s):	FCC #714830	IC Lab File #3874	

F.9. TEST RESULTS

F.9.1. Individual Transmitter Calculations:

Rangestar Internal Antenna (Highest Power Bluetooth Channel):

Tx Frequency: 2402 (MHz)
 RF Output Power at Antenna Input Terminal: 15.46 (dBm)
 Antenna gain: 4.50 (dBi)

S = 1.00 (mW/cm²)
 P = 35.1560 (mW)
 G = 2.82 (numeric)

R = 2.81 (cm)

S at 20cm: 0.019690619 (mW/cm²)

External Swivel Dipole Antenna (Highest Power Cellular CDMA Channel):

Tx Frequency: 848 (MHz)
 RF Output Power at Antenna Input Terminal: 22.99 (dBm)
 Antenna gain: 2.60 (dBi)

S = 0.57 (mW/cm²)
 P = 199.0673 (mW)
 G = 1.82 (numeric)

R = 7.14 (cm)

S at 20cm: 0.071987877 (mW/cm²)

External Swivel Dipole Antenna (Highest Power PCS CDMA Channel):

Tx Frequency: 1851 (MHz)
 RF Output Power at Antenna Input Terminal: 23.06 (dBm)
 Antenna gain: 2.60 (dBi)

S = 1.00 (mW/cm²)
 P = 202.3019 (mW)
 G = 1.82 (numeric)

R = 5.41 (cm)

S at 20cm: 0.073157586 (mW/cm²)

Formulae:

$$S = \frac{PG}{4\pi R^2}$$

where: S = Power Density Limit
 P = Power Applied to the Antenna
 G = Numeric Antenna Gain
 R = Distance from Antenna

$$R = \sqrt{\frac{P}{4\pi S}}$$

Applicant:	Itronix Corporation	Model:	IX260PROA555BT	FCC ID:	KBCIX260PROA555BT	IC ID:	1943A-IX260Pb	
Rugged Laptop PC with internal Sierra Wireless AirCard 555/550 Dual-Band CDMA Modem & Cirronet BT2022 Bluetooth								
2004 Celltech Labs Inc	This document is not to be reproduced in whole or in part without the written permission of Celltech Labs Inc.						43 of 53	

Test Report S/N:	090104KBC-T555-E24C/E15B		
Test Date(s):	01Nov04 - 23Nov04		
Test Type:	FCC §2, §15.247, §22H, §24E	IC RSS-210/132/133	
Lab Registration(s):	FCC #714830	IC Lab File #3874	

Results:

Mode	Power Density Limit	RF Conducted Output Power	Antenna Gain	MPE Distance	Power Density at 20 cm
	mW/cm ²	dBm	dBi	cm	mW/cm ²
Bluetooth (CH39)	1.0	15.46	4.5	2.81	0.0197
Cellular - CDMA	0.57	22.99	2.6	7.14	0.0720
PCS - CDMA	1.0	23.06	2.6	5.41	0.0732

F.9.2. Co-Transmit MPE Calculations

Radio	20 cm Power Density	Ratio	Limit
	mW/cm ²	(S/Limit)	mW/cm ²
Cellular - CDMA	0.0720	0.1263	0.57
Bluetooth	0.0197	0.0197	1
Sum =		0.1460	0.57

Radio	20 cm Power Density	Ratio	Limit
	mW/cm ²	(S/Limit)	mW/cm ²
PCS - CDMA	0.0732	0.0732	1
Bluetooth	0.0197	0.0197	1
Sum =		0.0929	1

F.10. PASS/FAIL

In reference to the results outlined in F.9 the DUT passes the requirements as stated in the reference standards as follows:
 1) The DUT must comply with the minimum spacing requirement of 20 cm to ensure an exposure of not more than f/1500 (0.57) mW/cm² for frequencies between 300 and 1500 MHz and 1 mW/cm² for frequencies between 1500 and 100,000 MHz.

F.11. SIGN-OFF

I attest to the accuracy of the data. All measurements reported herein were performed by me and are correct to the best of my knowledge and belief. I assume full responsibility for the completeness of these measurements.



Duane M. Friesen, C.E.T.
 EMC Manager
 Celltech Labs Inc.

17Nov04
 Date

Test Report S/N:	090104KBC-T555-E24C/E15B		
Test Date(s):	01Nov04 - 23Nov04		
Test Type:	FCC §2, §15.247, §22H, §24E	IC RSS-210/132/133	
Lab Registration(s):	FCC #714830	IC Lab File #3874	

Appendix G – CDMA Conducted RF Output Power Measurement

G.1. REFERENCES

Normative Reference Standard	FCC CFR 47 §2.1046
Procedure Reference	FCC CFR 47 §2.1046

G.2. LIMITS

For reference only to compare the effect the bluetooth transmitter co-transmitting had on the CDMA transmitter power. Single transmit conducted powers:

Mode	Channel	Frequency	Conducted Power
Cellular CDMA	1013	824.7 MHz	+23.0 dBm
	363	835.89 MHz	+23.0 dBm
	777	848.31 MHz	+23.0 dBm
PCS CDMA	25	1851.25 MHz	+23.0 dBm
	600	1880.00 MHz	+23.0 dBm
	1175	1908.75 MHz	+23.0 dBm

G.3. ENVIRONMENTAL CONDITIONS

Temperature	25.2 +/- 2 °C
Humidity	35 +/- 2 %
Barometric Pressure	96.34 kPa

G.4. EQUIPMENT LIST

ASSET NUMBER	MANUFACTURER	MODEL	DESCRIPTION	LAST CAL	CAL DUE
00008	Gigatronics	8652A	Power Meter	30Apr04	30Apr05
00010	Gigatronics	80701A	Power Sensor	30Apr04	30Apr05
00012	Gigatronics	80701A	Power Sensor	30Apr04	30Apr05
00107	HP	8491C	Attenuator	n/a	n/a

*Cable and attenuator verified with power meter prior to use

Test Report S/N:	090104KBC-T555-E24C/E15B		
Test Date(s):	01Nov04 - 23Nov04		
Test Type:	FCC §2, §15.247, §22H, §24E	IC RSS-210/132/133	
Lab Registration(s):	FCC #714830	IC Lab File #3874	

G.5. MEASUREMENT EQUIPMENT SETUP

Measurement Equipment Connections	The equipment was connected as shown in the setup drawing in G.6.
Measurement Equipment Settings	Power Meter Settings: Mode – MAP Frequency compensation set for carrier frequency Offset set appropriately for carrier frequency and attenuator characteristics
Measurement Procedure	The RF conducted power levels for both PCS and cellular bands were measured at the DUT antenna connector port using a Gigatronics 8652A Universal Power Meter in mean average power mode. An offset was entered into the power meter to correct for the losses of the attenuator and cable installed between the transmitter output port and the power sensor input. The DUT test software was used to set it to transmit in the CDMA “always up” power control mode. All subsequent tests were performed using the same power measurement procedures.

G.6. SETUP DRAWING

Figure G-1 – Setup Drawing

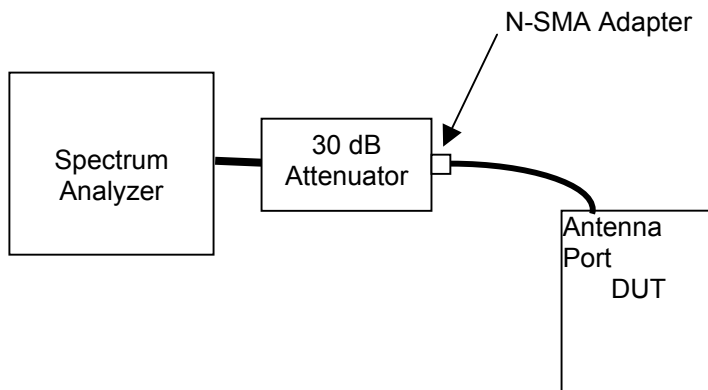

Test Report S/N:	090104KBC-T555-E24C/E15B		
Test Date(s):	01Nov04 - 23Nov04		
Test Type:	FCC §2, §15.247, §22H, §24E	IC RSS-210/132/133	
Lab Registration(s):	FCC #714830	IC Lab File #3874	

G.7. DUT OPERATING DESCRIPTION

During this evaluation, the Bluetooth transmitter was set to co-transmit in a hopping mode as described in section 5.7.2. Power measurements were then made of each channel in both the cellular and PCS bands, with the CDMA modem set appropriately as described in section 5.7.1.

G.8. TEST RESULTS

Mode	Channel	Frequency	Conducted Power
Cellular CDMA	1013	824.7 MHz	+22.92 dBm
	363	835.89 MHz	+22.96 dBm
	777	848.31 MHz	+22.99 dBm
PCS CDMA	25	1851.25 MHz	+23.06 dBm
	600	1880.00 MHz	+22.87 dBm
	1175	1908.75 MHz	+22.67 dBm

G.9. PASS/FAIL

As a reference with the single transmit conducted RF power levels, the output of the CDMA transmitter was reduced by a maximum of 0.33 dB when co-transmitting with the Bluetooth transmitter.

G.10. SIGN-OFF

I attest to the accuracy of the data. All measurements reported herein were performed by me and are correct to the best of my knowledge and belief. I assume full responsibility for the completeness of these measurements.



Russell Pipe
Senior Compliance Technologist
Celltech Labs Inc.

18Nov04

Date

Applicant:	Itronix Corporation	Model:	IX260PROA555BT	FCC ID:	KBCIX260PROA555BT	IC ID:	1943A-IX260Pb	
Rugged Laptop PC with internal Sierra Wireless AirCard 555/550 Dual-Band CDMA Modem & Cirronet BT2022 Bluetooth								
2004 Celltech Labs Inc	This document is not to be reproduced in whole or in part without the written permission of Celltech Labs Inc.						47 of 53	

Test Report S/N:	090104KBC-T555-E24C/E15B		
Test Date(s):	01Nov04 - 23Nov04		
Test Type:	FCC §2, §15.247, §22H, §24E	IC RSS-210/132/133	
Lab Registration(s):	FCC #714830	IC Lab File #3874	

Appendix H – Radiated Spurious Emissions Measurement

H.1. REFERENCES	
Normative Reference Standard	FCC CFR 47 §22.917 (e), FCC CFR 47 §24.238 (a)
Procedure Reference	ANSI/TIA/EIA-603-A

H.2. LIMITS	
FCC CFR 47 §22.917	<i>(e) Out of Band Emissions. The mean power of emissions must be attenuated below the mean power of the unmodulated carrier (P) on any frequency twice or more than twice the fundamental frequency by: at least 43 + 10 log P dB</i>
FCC CFR 47 §24.238	<i>(a) Out of band emissions. The power of any emission outside of the authorized operating frequency ranges must be attenuated below the transmitting power (P) by a factor of at least 43 + 10 log(P) dB.</i>

* The Part 15.205, 209 & 15.247 limits will be applied since the emissions being investigated are inter-modulation products with the Bluetooth and these limits are lower.

H.3. ENVIRONMENTAL CONDITIONS	
Temperature	27.4 +/- 2 °C
Humidity	33 +/- 2 %
Barometric Pressure	96.24 +/- 0.2 kPa

H.4. EQUIPMENT LIST					
ASSET NUMBER	MANUFACTURER	MODEL	DESCRIPTION	LAST CAL	CAL DUE
00072	EMCO	2075	Mini-mast	n/a	n/a
00073	EMCO	2080	Turn Table	n/a	n/a
00071	EMCO	2090	Multi-Device Controller	n/a	n/a
00035	ETS	3115	Double Ridged Guide Horn	24Mar04	24Mar05
00015	Agilent	E4408B	Spectrum Analyzer	29Dec03	29Dec04
00049	HP	8566B	Spectrum Analyzer RF Section	18May04	18May05
00049	HP	85650A	Quasi-peak Adapter	18May04	18May05
00047	HP	85685A	RF Preselector	18May04	18May05
00048	Gore	65474	Microwave Cable	20May04	20May05
00030	HP	83017A	LNA	20May04	20May05

Test Report S/N:	090104KBC-T555-E24C/E15B		
Test Date(s):	01Nov04 - 23Nov04		
Test Type:	FCC §2, §15.247, §22H, §24E	IC RSS-210/132/133	
Lab Registration(s):	FCC #714830	IC Lab File #3874	

H.5. MEASUREMENT EQUIPMENT SETUP

MEASUREMENT EQUIPMENT CONNECTIONS	The measurement equipment was connected as shown in E.6. A number of antennas were used to cover the applicable frequency range test ¹ . The ranges in which each antenna was used are as follows:			
	Frequency Range		Antenna	
	1 GHz – 18 GHz		ETS 3115 Horn	
MEASUREMENT EQUIPMENT SETTINGS	The spectrum analyzer was set to the following settings:			
	Frequency Range	RBW	VBW	Detector
	MHz	kHz	kHz	
	> 1000	1000*	1000	
	Note 1: Only ranges where inter-modulation products might occur were investigated.			
Note 2: As a worse case measurement, the average/quasi-peak limits were applied to measurements made with a peak detector.				

H.6. SETUP DRAWING

Figure H-1 – Setup Drawing

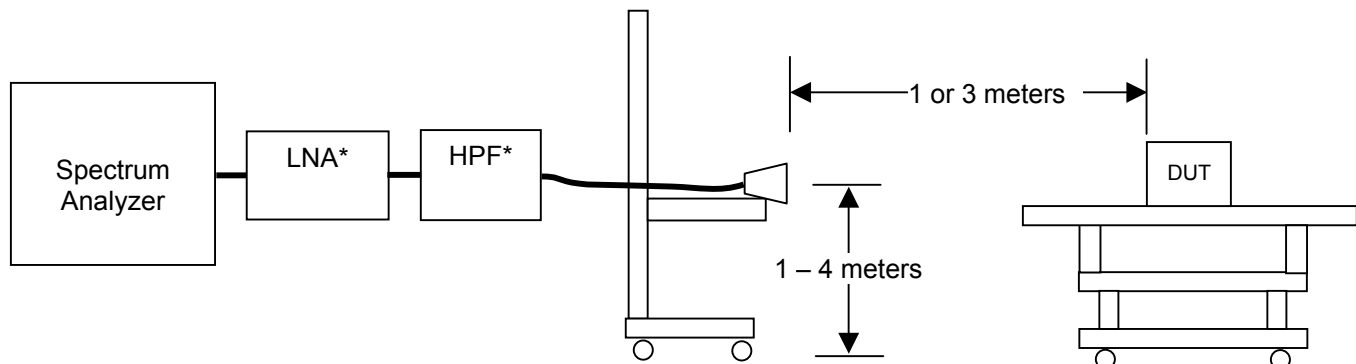

* Used for >1GHz

Test Report S/N:	090104KBC-T555-E24C/E15B		
Test Date(s):	01Nov04 - 23Nov04		
Test Type:	FCC §2, §15.247, §22H, §24E	IC RSS-210/132/133	
Lab Registration(s):	FCC #714830	IC Lab File #3874	

H.7. SETUP PHOTOGRAPHS

Photograph H-1 – 3115 Vertical Polarization

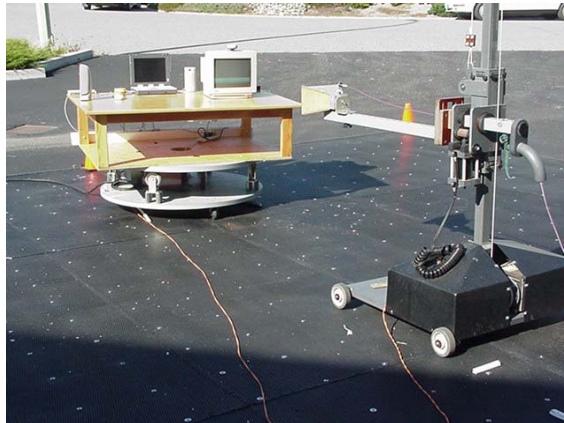

Photograph H-2 - Front of Radiated Emission Configuration



Photograph H-3 - Back of Radiated Emission Configuration

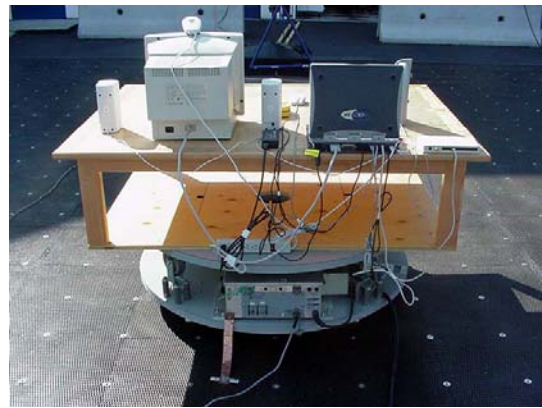

H.8. DUT OPERATING DESCRIPTION

Measurements were made of the bands that may contain inter-modulation products with both the Bluetooth and CDMA radios transmitting. Measurements were made for each combination of low and high CDMA channel transmitting while the Bluetooth was in hopping mode. The bluetooth power setting was set to worse case (highest recorded conducted power) with CDMA power settings equivalent to those described in the referenced single-transmit test reports.

H.9. TEST RESULTS

With the exception of the block-edge measurements, all significant inter-modulations products or representative noise floor levels were measured as they related to the FCC 15.205/209 restricted band limit. This comparison was worst-case (versus an out-of-band emission limit comparison) and is described in Appendix E of this report. The CDMA block-edge measurements are presented in the tables below. All other spurious emissions are described in the appropriate sections in the individual reports referenced.

Applicant:	Itronix Corporation	Model:	IX260PROA555BT	FCC ID:	KBCIX260PROA555BT	IC ID:	1943A-IX260Pb	
Rugged Laptop PC with internal Sierra Wireless AirCard 555/550 Dual-Band CDMA Modem & Cirronet BT2022 Bluetooth								
2004 Celltech Labs Inc	This document is not to be reproduced in whole or in part without the written permission of Celltech Labs Inc.						50 of 53	

Test Report S/N:	090104KBC-T556-E24C/E15B		
Test Date(s):	01Nov04 - 23Nov04		
Test Type:	FCC §2, §15.247, §22H, §24E	IC RSS-210/132/133	
Lab Registration(s):	FCC #714830	IC Lab File #3874	

H.9.1. CDMA Carrier Power Levels

	Project Number: 090104KBC-T556-E24C/E15B	Standard: FCC22.913/FCC24.232
	Company: Itronix	Test Start Date: 1-Nov-04
	Product: IX260+ with AC555 & Bluetooth	Test End Date: 23-Nov-04

AC555 Cellular CDMA Carrier Power Co-transmitting with Bluetooth Hopping														
Polarity	Distance	Substitution Antenna Type	Carrier	Frequency	Corrected Field Strength	Substituted SA Signal Level (uncorrected)	Power Applied to Antenna	Antenna Gain	Carrier ERP Level		ERP Limit		Margin	Pass/Fail
				MHz	dBuV/m	dBuV	dBm	dBi	dBm	Watts	dBm	Watts	dB	
H	3	B_3121C	1013	824.70	118.15	88.90	15.94	1.30	15.10	0.032	38.45	7.00	23.35	PASS
V	3	B_3121C	1013	824.70	109.25	80.00	9.13	1.30	8.29	0.007	38.45	7.00	30.16	PASS
H	3	B_3121C	777	848.31	116.79	87.60	15.76	1.58	15.20	0.033	38.45	7.00	23.25	PASS
V	3	B_3121C	777	848.31	107.29	78.10	6.10	1.58	5.54	0.004	38.45	7.00	32.91	PASS

AC555 PCS CDMA Carrier Power Co-transmitting with Bluetooth Hopping														
Polarity	Distance	Substitution Antenna Type	Carrier	Frequency	Corrected Field Strength	Substituted SA Signal Level (uncorrected)	Power Applied to Antenna	Antenna Gain	Carrier EIRP Level		EIRP Limit		Margin	Pass/Fail
				MHz	dBuV/m	dBuV	dBm	dBi	dBm	Watts	dBm	Watts	dB	
H	3	Horn SN6276	25	1851.25	118.65	86.70	9.59	6.67	14.12	0.026	33.01	2.000	18.89	PASS
V	3	Horn SN6276	25	1851.25	116.35	84.40	7.98	6.67	12.51	0.018	33.01	2.000	20.50	PASS
H	3	Horn SN6276	1175	1908.75	116.24	84.00	8.16	6.68	12.70	0.019	33.01	2.000	20.31	PASS
V	3	Horn SN6276	1175	1908.75	113.74	81.50	6.26	6.68	10.80	0.012	33.01	2.000	22.21	PASS

Note:
Dipole Antenna used for substitution below 1GHz, Horn Antenna used for substitution above 1G

Formulae:
ERP=Power applied to Antenna (dBm) + Antenna Gain (dBi) - 2.14, EIRP Level (dBm) = Power applied to Antenna (dBm) + Antenna Gain (dBi)
Margin (dB) = Limit (dBm) - Level (dBm)

H.9.2. CDMA Block-edge Power Levels

	Project Number: 090104KBC-T556-E24C/E15B	Standard: FCC22.917/FCC24.238
	Company: Itronix	Test Start Date: 1-Nov-04
	Product: IX260+ with AC555 & Bluetooth	Test End Date: 23-Nov-04

AC555 Cellular CDMA Block-edge Power Co-transmitting with Bluetooth Hopping												
Polarity	Distance	Substitution Antenna Type	Carrier Channel	Frequency	Corrected Field Strength	Substituted SA Signal Level (uncorrected)	Power Applied to Antenna	Antenna Gain	Emission ERP Level	ERP Limit	Margin	Pass/Fail
				MHz	dBuV/m	dBuV	dBm	dBi	dBm	dBm	dB	
H	3	B_3121C	1013	824.00	75.45	46.20	-21.40	1.28	-22.26	-13.00	9.26	PASS
V	3	B_3121C	1013	824.00	71.75	42.50	-21.98	1.28	-22.84	-13.00	9.84	PASS
H	3	B_3121C	777	849.00	81.79	52.60	-17.40	1.59	-17.95	-13.00	4.95	PASS
V	3	B_3121C	777	849.00	70.69	41.50	-22.30	1.59	-22.85	-13.00	9.85	PASS

AC555 PCS CDMA Block-edge Power Co-transmitting with Bluetooth Hopping												
Polarity	Distance	Substitution Antenna Type	Carrier Channel	Frequency	Corrected Field Strength	Substituted SA Signal Level (uncorrected)	Power Applied to Antenna	Antenna Gain	Emission EIRP Level	EIRP Limit	Margin	Pass/Fail
				MHz	dBuV/m	dBuV	dBm	dBi	dBm	dBm	dB	
H	3	Horn SN6267	25	1850.00	85.15	53.20	-20.35	6.55	-15.94	-13.00	2.94	PASS
V	3	Horn SN6267	25	1850.00	83.25	51.30	-20.62	6.55	-16.21	-13.00	3.21	PASS
H	3	Horn SN6267	1175	1910.00	84.85	52.60	-20.01	6.61	-15.54	-13.00	2.54	PASS
V	3	Horn SN6267	1175	1910.00	82.85	50.60	-20.64	6.61	-16.17	-13.00	3.17	PASS

Note:
Dipole Antenna used for substitution below 1GHz, Horn Antenna used for substitution above 1G

Formulae:
ERP=Power applied to Antenna (dBm) + Antenna Gain (dBi) - 2.14, EIRP Level (dBm) = Power applied to Antenna (dBm) + Antenna Gain (dBi)
Margin (dB) = Limit (dBm) - Level (dBm)

Applicant: Itronix Corporation	Model: IX260PROA555BT	FCC ID: KBCIX260PROA555BT	IC ID: 1943A-IX260Pb
Rugged Laptop PC with internal Sierra Wireless AirCard 555/550 Dual-Band CDMA Modem & Cirronet BT2022 Bluetooth			
2004 Celltech Labs Inc	This document is not to be reproduced in whole or in part without the written permission of Celltech Labs Inc.		51 of 53

Test Report S/N:	090104KBC-T555-E24C/E15B		
Test Date(s):	01Nov04 - 23Nov04		
Test Type:	FCC §2, §15.247, §22H, §24E	IC RSS-210/132/133	
Lab Registration(s):	FCC #714830	IC Lab File #3874	

H.10. PASS/FAIL

In reference to the results outlined in E.9 and H.9, the DUT passes the requirements as stated in the reference standards*

* With the exception of the block-edge measurements, the Part 15.205 & 209 limits will be applied since the emissions being investigated are inter-modulation products with the Bluetooth and these limits are lower than those defined in Part 22 and 24.

H.11. SIGN-OFF

I attest to the accuracy of the data. All measurements reported herein were performed by me and are correct to the best of my knowledge and belief. I assume full responsibility for the completeness of these measurements.



Russell Pipe
Senior Compliance Technologist
Celltech Labs Inc.

23Nov04
Date

Applicant:	Itronix Corporation	Model:	IX260PROA555BT	FCC ID:	KBCIX260PROA555BT	IC ID:	1943A-IX260Pb	
Rugged Laptop PC with internal Sierra Wireless AirCard 555/550 Dual-Band CDMA Modem & Cirronet BT2022 Bluetooth								
2004 Celltech Labs Inc		This document is not to be reproduced in whole or in part without the written permission of Celltech Labs Inc.					52 of 53	

Test Report S/N:	090104KBC-T555-E24C/E15B		
Test Date(s):	01Nov04 - 23Nov04		
Test Type:	FCC §2, §15.247, §22H, §24E	IC RSS-210/132/133	
Lab Registration(s):	FCC #714830	IC Lab File #3874	

END OF DOCUMENT

Applicant:	Itronix Corporation	Model:	IX260PROA555BT	FCC ID:	KBCIX260PROA555BT	IC ID:	1943A-IX260Pb
Rugged Laptop PC with internal Sierra Wireless AirCard 555/550 Dual-Band CDMA Modem & Cirronet BT2022 Bluetooth							
2004 Celltech Labs Inc	This document is not to be reproduced in whole or in part without the written permission of Celltech Labs Inc.						53 of 53