

Test Report S/N:	100504KBC-T565-E15W/E15B	
Test Date(s):	01Nov04 - 06Dec04	
Test Type(s):	FCC §15.247	IC RSS-210 Issue 5
Lab Registration(s):	FCC #714830	IC Lab File #3874

PART 15.247 SUPPLEMENTARY EMC TEST REPORT
FOR THE
ITRONIX RUGGED LAPTOP PC MODEL: IX260PNL3054BT
WITH THE
INTERNAL CIRRONET BT2022 BLUETOOTH TRANSMITTER
UTILIZING THE
INTERNAL RANGESTAR SURFACE-MOUNT ANTENNA
(INSTALLED IN THE UPPER LEFT SIDE REAR OF LCD DISPLAY)
CO-TRANSMITTING WITH THE
SENAO NL-3054MP 802.11B/G 2.4 GHz DSSS WLAN MINI-PCI CARD
UTILIZING THE
INTERNAL RANGESTAR SURFACE-MOUNT ANTENNA
(INSTALLED IN THE UPPER RIGHT SIDE REAR OF LCD DISPLAY)

TRSN 100504KBC-T565-E15W/E15B
Issue 1.0

Celltech Compliance Testing & Engineering Lab
(Celltech Labs Inc.)
1955 Moss Court
Kelowna, BC
Canada
V1Y 9L3

December 7, 2004

Test Report S/N:	100504KBC-T565-E15W/E15B	
Test Date(s):	01Nov04 - 06Dec04	
Test Type(s):	FCC §15.247	IC RSS-210 Issue 5
Lab Registration(s):	FCC #714830	IC Lab File #3874

DECLARATION OF COMPLIANCE

Test Lab		Applicant Information	
CELLTECH LABS INC. Testing and Engineering Services 1955 Moss Court Kelowna, B.C. Canada V1Y 9L3 Phone: 250-448-7047 Fax: 250-448-7048 e-mail: info@celltechlabs.com web site: www.celltechlabs.com		ITRONIX CORPORATION 801 South Stevens Street Spokane, WA 99204 United States	
Laboratory Registration No.(s):	FCC: 714830	IC: IC 3874	
Rule Part(s):	FCC: §15.247; §2.1091; §1.1310	IC: RSS-210 Issue 5	
Device Classification:	FCC: WLAN - DSSS	- Digital Transmission System (DTS)	
	Bluetooth - FHSS	- Part 15 Spread Spectrum Transmitter (DSS)	
Device Identification:	FCC ID: KBCIX260PNL3054BT	IC: 1943A-IX260Pa	
DUT Description:			
Model(s):	IX260PNL3054BT		
Device Description:	Rugged Laptop PC with internal Cirronet BT2022 Bluetooth Transmitter and internal RangeStar surface-mount antenna (upper left side rear of LCD display), co-transmitting with the internal Senao NL-3054MP 802.11b/g 2.4 GHz DSSS WLAN Mini-PCI Card and internal RangeStar surface-mount antenna (upper right side rear of LCD display)		
Tx Frequency Range(s):	Bluetooth	2402 - 2480 MHz	
	WLAN	2412 - 2462 MHz	
Max. RF Output Power:	Bluetooth	+16.56 dBm Peak Conducted	
	WLAN	+20.43 dBm Peak Conducted (Mode b)	
		+20.21 dBm Peak Conducted (Mode g)	
Modulation Type(s):	Bluetooth	GFSK 1 Mbps 0.5 BT Gaussian	
	WLAN	DBPSK, DQPSK, CCK	
Antenna Type(s):	RangeStar P/N: 100929 Dual Internal Surface-Mount		
Power Supply:	90 Watt AC Power Adapter		

This mobile transmitting device has demonstrated compliance with the applicable technical standards as indicated in the measurement report and was tested in accordance with the measurement procedures specified in FCC 47 CFR Part 15.247 and Industry Canada RSS-210 Issue 5.

I attest to the accuracy of the data. All measurements reported herein were performed by me or were under my supervision and are correct to the best of my knowledge and belief. I assume full responsibility for the completeness of these measurements and vouch for the qualifications of all persons taking them.

This test report shall not be reproduced partially, or in full, without the prior written approval of Celltech Labs Inc. The results and statements contained in this report pertain only to the device(s) evaluated.



Russell Pipe
Senior Compliance Technologist
Celltech Labs Inc.



Duane M. Friesen
EMC Manager
Celltech Labs Inc.



Applicant: Itronix Corporation	Model: IX260PNL3054BT	IC ID: 1943A-IX260Pa	FCC ID: KBCIX260PNL3054BT
Rugged Laptop PC with internal Senao NL-3054MP 802.11b/g WLAN and Cirronet BT2022 Bluetooth			
2004 Celltech Labs Inc	This document is not to be reproduced in whole or in part without the written permission of Celltech Labs Inc.		2 of 45

Test Report S/N:	100504KBC-T565-E15W/E15B	
Test Date(s):	01Nov04 - 06Dec04	
Test Type(s):	FCC §15.247	IC RSS-210 Issue 5
Lab Registration(s):	FCC #714830	IC Lab File #3874

TABLE OF CONTENTS

1.0 SCOPE	5
2.0 REFERENCES	5
2.1 Normative References	5
3.0 TERMS AND DEFINITIONS	6
4.0 FACILITIES AND ACCREDITATIONS	7
5.0 GENERAL INFORMATION	7
5.1 Applicant Information	7
5.2 DUT Description	7
5.3 Co-Located Equipment	8
5.4 Cable Descriptions	8
5.5 Support Equipment	9
5.6 Clock Frequencies	9
5.7 Mode(s) of Operation Tested	10
5.8 Configuration Description	11
6.0 PASS/FAIL CRITERIA	11
APPENDIX	12
Appendix A - DUT Photographs	13
Appendix B - Conducted Powerline Emissions Measurement	15
Appendix C - Bluetooth Peak Conducted RF Power Measurement	22
Appendix D - WLAN Peak Conducted RF Power Measurement	25
Appendix E - Radiated Spurious Emissions Measurement	28
Appendix F - Restricted Band Emissions Measurement	33
Appendix G - Maximum Permissible Exposure Calculation	41
END OF DOCUMENT	45

FIGURES

Figure B-1 - Setup Drawing	18
Figure C-1 - Setup Drawing	23
Figure D-1 - Setup Drawing	26
Figure E-1 - Setup Drawing	29
Figure F-1 - Setup Drawing	35

PHOTOGRAPHS

Photograph A-1 - Front of Open IX260+ Laptop PC	13
Photograph A-2 - Side of Open IX260+ Laptop PC	13
Photograph A-3 - WLAN Mini-PCI Card Location	13
Photograph A-4 - Bluetooth Transmitter Location	13
Photograph A-5 - WLAN Mini-PCI Card	14
Photograph A-6 - Bluetooth Transmitter	14
Photograph A-7 - Surface Mount Antenna Placement	14
Photograph E-1 - 3115 Horn Antenna	30
Photograph F-1 - 3115 Horn Antenna	36
Photograph F-2 - Front of Radiated Emission Configuration	36
Photograph F-3 - Back of Radiated Emission Configuration	36

Applicant: Itronix Corporation	Model: IX260PNL3054BT	IC ID: 1943A-IX260Pa	FCC ID: KBCIX260PNL3054BT
Rugged Laptop PC with internal Senao NL-3054MP 802.11b/g WLAN and Cirronet BT2022 Bluetooth			
2004 Celltech Labs Inc	This document is not to be reproduced in whole or in part without the written permission of Celltech Labs Inc.		3 of 45



Test Report S/N:	100504KBC-T565-E15W/E15B	
Test Date(s):	01Nov04 - 06Dec04	
Test Type(s):	FCC §15.247	IC RSS-210 Issue 5
Lab Registration(s):	FCC #714830	IC Lab File #3874

TEST SUMMARY						
Referenced Standard: FCC CFR Title 47 Part 15						
Appendix	Test Description	Procedure Reference	Limit Reference	Test Start Date	Test End Date	Result
B	Powerline Conducted Emissions	ANSI C63.4	§15.207	30Nov04	30Nov04	Pass
C	Bluetooth Peak Conducted RF Power	FCC 97-114	§15.247(b) (3)	06Dec04	06Dec04	Pass
D	WLAN Peak Conducted RF Power	FCC 97-114	§15.247(b) (3)	01Dec04	01Dec04	Pass
E	Radiated Spurious Emissions	FCC 97-114	§15.247(c)	01Nov04	06Dec04	Pass
F	Restricted Band Emissions	FCC 97-114	§15.205 (a), (b) §15.209 (a)	01Nov04	06Dec04	Pass
G	Maximum Permissible Exposure	FCC CFR 47 § 2.1091 IEEE Std C95.1-1999	§1.1310 Table 1 (b)	06Dec04	06Dec04	Pass
Referenced Standard: IC RSS-210 Issue 5						
B	Powerline Conducted Emissions	RSS-212, ANSI C63.4	RSS-210 §6.6	30Nov04	30Nov04	Pass
C	WLAN Conducted Peak RF Power	FCC 97-114	§15.247(b) (3)	06Dec04	06Dec04	Pass
D	WLAN Conducted Peak RF Power	FCC 97-114	§15.247(b) (3)	01Dec04	01Dec04	Pass
E	Radiated Spurious Emissions	RSS-212, ANSI C63.4	RSS-210 §6.2.2 (e1)	01Nov04	06Dec04	Pass
F	Restricted Band Emissions	RSS-212, ANSI C63.4	RSS-210 §6.3	01Nov04	06Dec04	Pass
G	Maximum Permissible Exposure	RSS-102	RSS-210 §14 Safety Code 6 2.2.1(a) Table 5	06Dec04	06Dec04	Pass

REVISION LOG

Issue	Description	Implemented By	Implementation Date
1.0	Initial Release	Jon Hughes	07Dec04

SIGNATORIES

Prepared By		Dec. 7, 2004
Name/Title	Duane M. Friesen, C.E.T. / EMC Manager	Date
Reviewed By		Dec. 7, 2004
Name/Title	Jon Hughes / General Manager	Date

Applicant:	Itronix Corporation	Model:	IX260PNL3054BT	IC ID:	1943A-IX260Pa	FCC ID:	KBCIX260PNL3054BT
Rugged Laptop PC with internal Senao NL-3054MP 802.11b/g WLAN and Cirronet BT2022 Bluetooth							
2004 Celltech Labs Inc		This document is not to be reproduced in whole or in part without the written permission of Celltech Labs Inc.					4 of 45

Test Report S/N:	100504KBC-T565-E15W/E15B	
Test Date(s):	01Nov04 - 06Dec04	
Test Type(s):	FCC §15.247	IC RSS-210 Issue 5
Lab Registration(s):	FCC #714830	IC Lab File #3874

1.0 SCOPE

This report outlines the measurements made and results collected during electromagnetic emissions testing of the Itronix Corporation IX260+ Rugged Laptop PC with internal Cirronet BT2022 Bluetooth Transmitter co-transmitting with the Senao NL-3054MP 802.11b/g 2.4 GHz DSSS WLAN Mini-PCI Card, each connected to separate RangeStar internal surface-mount antennas. This report describes the results obtained when inter-modulation product measurements were made with both transmitters installed in the IX260+ Rugged Laptop PC as described, and transmitting simultaneously. The measurement results were applied against the EMC requirements and limits outlined in the technical rules and regulations set forth in the Federal Communication Commission Code of Federal Regulations Title 47 Part 15 subpart C, and Industry Canada Radio Standards Specification RSS-210 Issue 5.

2.0 REFERENCES

2.1 Normative References

ANSI/ISO 17025:1999	General Requirements for competence of testing and calibration laboratories
IEEE/ANSI C63.4-2003	Methods of Measurement of Radio-Noise Emissions from Low-Voltage Electrical and Electronic Equipment in the Range of 9 kHz to 40 GHz
IEEE/ANSI Std C95.1-1999	American National Standard Safety Levels with Respect to Human Exposure to Radio Frequency Electromagnetic Fields
CFR Title 47 Part 2:2003	Code of Federal Regulations Title 47: Telecommunication Part 2: Frequency Allocations and Radio Treaty Matters; General Rules and Regulations
CFR Title 47 Part 15:2003	Code of Federal Regulations Title 47: Telecommunication Part 15: Radio Frequency Devices
IC Spectrum Management & Telecommunications Policy	Radio Standards Specification RSS-212 Issue 1 (Provisional) - Test Facilities & Test Methods for Radio Equipment RSS-210 Issue 5 - Low Power Licence-Exempt Radiocommunication Devices RSS-102 Issue 1 (Provisional) - Evaluation Procedure for Mobile and Portable Radio Transmitters with respect to Health Canada's Safety Code 6 for Exposure of Humans to Radio Frequency Fields
Celltech Labs Test Report	EMC Test Report For the Model IX260+ Rugged Laptop PC with Senao NL-3054MP 2.4 GHz DSSS WLAN Mini-PCI Card and Internal Antenna Test Report Serial Number 100504KBC-T565-E15W Date: November 11, 2004
Celltech Labs Test Report	EMC Test Report For the Model IX260+ Rugged Laptop PC with Cirronet BT2022 Bluetooth Transmitter and Internal Antenna Test Report Serial Number 100504KBC-T565-E15B Date: October 22, 2004

Applicant:	Itronix Corporation	Model:	IX260PNL3054BT	IC ID:	1943A-IX260Pa	FCC ID:	KBCIX260PNL3054BT
Rugged Laptop PC with internal Senao NL-3054MP 802.11b/g WLAN and Cirronet BT2022 Bluetooth							
2004 Celltech Labs Inc	This document is not to be reproduced in whole or in part without the written permission of Celltech Labs Inc.						5 of 45

Test Report S/N:	100504KBC-T565-E15W/E15B		
Test Date(s):	01Nov04 - 06Dec04		
Test Type(s):	FCC §15.247	IC RSS-210 Issue 5	
Lab Registration(s):	FCC #714830	IC Lab File #3874	

3.0 TERMS AND DEFINITIONS

AVG	Average
CFR	Code of Federal Regulations
dB	decibel
dBm	dB referenced to 1 mW
dBuV	dB referenced to 1 uV
DUT	Device under Test
dBc	dB down from carrier
EBW	Emission Bandwidth
EMC	Electromagnetic Compatibility
FCC	Federal Communication Commission
FHSS	Frequency Hopping Spread Spectrum
HP	Hewlett Packard
HPF	High Pass Filter
Hpol	Horizontal Polarization
Hz	Hertz
IC	Industry Canada
kHz	kilohertz
LNA	Low Noise Amplifier
m	meter
MHz	Megahertz
Mbps	megabits per second
na	not applicable
n/a	not available
PK	Peak
PPSD	Peak Power Spectral Density
QP	Quasi-peak
RBW	Resolution Bandwidth
R&S	Rohde & Schwarz
RSS	Radio Standard Specification
SA	Spectrum Analyzer
VBW	Video Bandwidth
Vpol	Vertical Polarization
WLAN	Wireless Local Area Network

Test Report S/N:	100504KBC-T565-E15W/E15B		
Test Date(s):	01Nov04 - 06Dec04		
Test Type(s):	FCC §15.247	IC RSS-210 Issue 5	
Lab Registration(s):	FCC #714830	IC Lab File #3874	

4.0 FACILITIES AND ACCREDITATIONS

The facilities used in collecting the test results outlined in this report are located at 1955 Moss Court, Kelowna, British Columbia, Canada, V1Y 9L3. The radiated and conducted emissions sites conform with the requirements set forth in ANSI C63.4 and are filed and listed with the FCC under Registration Number 714830 and Industry Canada under File Number IC 3874.

5.0 GENERAL INFORMATION

5.1 Applicant Information

Company Name:	Itronix Corporation
Address:	801 South Stevens Street Spokane, WA 99204 United States

5.2 DUT Description

The DUT consisted of the IX260+ Rugged Laptop PC containing a Cirronet BT2022 Bluetooth Transmitter connected to an Internal RangeStar Surface-Mount Antenna installed in the upper left side rear edge of the LCD display. Co-located within the IX260+ Rugged Laptop PC was a Senao NL-3054MP 802.11b/g WLAN Mini-PCI Card connected to a second Internal RangeStar Surface-Mount Antenna installed in the upper right side rear edge of the LCD display. Photographs of the DUT placement and construction are shown in Appendix A.

Device:	Rugged Laptop PC			
Model:	IX260PNL3054BT			
Serial Number:	ZZGEG4196ZZ6494			
Identifier(s):	FCC ID:	KBCIX260PNL3054BT	IC:	1943A-IX260Pa
Power Source:	Delta Electronics Model ADP-90AB Rev B 90 Watt AC-DC power supply			

Device:	2.4GHz FHSS Bluetooth Transmitter			
Model:	Cirronet BT2022			
Serial Number:	n/a			
Rule Part(s):	FCC:	§15.247; §2.1091; §1.1310	IC:	RSS-210 Issue 5
Classification:	FCC:	Spread Spectrum Transmitter (DSS)	IC:	Low Power Licence-Exempt Transmitter
Power Source:	Powered from the internal PC power supply			

Test Report S/N:	100504KBC-T565-E15W/E15B		
Test Date(s):	01Nov04 - 06Dec04		
Test Type(s):	FCC §15.247	IC RSS-210 Issue 5	
Lab Registration(s):	FCC #714830	IC Lab File #3874	

Device:	2.4GHz 802.11b/g DSSS WLAN Mini-PCI Card		
Model:	Senao NL-3054MP		
Serial Number:	048253621		
Rule Part(s):	FCC:	§15.247; §2.1091; §1.1310	IC: RSS-210 Issue 5
Device Classification:	FCC:	Digital Transmission System (DTS)	IC: Low Power Licence-Exempt Transmitter
Power Source:	Powered from the internal PC power supply		

Device:	Internal Surface-Mount Antenna (Bluetooth - upper left side rear edge of the LCD display)		
Model:	RangeStar P/N: 100929		
Gain:	4.5 dBi		

Device:	Internal Dual Surface-Mount Antenna (WLAN - upper right side rear edge of the LCD display)		
Model:	RangeStar P/N: 100929		
Gain:	4.5 dBi		

5.3 Co-Located Equipment

Device:	GPS Receiver Module with attached Antenna (Receive only)		
Model:	Leadtek P/N GPS9547		

5.4 Cable Descriptions

ROUTING		Length m	Model	Terminations		Shield Type	Shield Termination		Suppression
From	To			End 1	End 2		End 1	End 2	
PC Fire Wire Port	Unterminated	1.0	Copartner E119932	IEEE-1528	Fire wire	n/a	n/a	n/a	None
PC modem port	Unterminated	1.0	n/a	RJ-11	RJ-11	None	na	na	None
PC Ethernet Port	Ethernet Hub	1.0	n/a	RJ-45	RJ-45	None	na	na	None

Applicant:	Itronix Corporation	Model:	IX260PNL3054BT	IC ID:	1943A-IX260Pa	FCC ID:	KBCIX260PNL3054BT
Rugged Laptop PC with internal Senao NL-3054MP 802.11b/g WLAN and Cirronet BT2022 Bluetooth							
2004 Celltech Labs Inc	This document is not to be reproduced in whole or in part without the written permission of Celltech Labs Inc.						8 of 45

Test Report S/N:	100504KBC-T565-E15W/E15B	
Test Date(s):	01Nov04 - 06Dec04	
Test Type(s):	FCC §15.247	IC RSS-210 Issue 5
Lab Registration(s):	FCC #714830	IC Lab File #3874

5.5 Support Equipment

The following equipment was used in support of the DUT.

CO-LOCATED SUPPORT EQUIPMENT LIST		
MANUFACTURER	MODEL	DESCRIPTION
D-Link	DE-809TC/	Ethernet hub
YNG YUH	YP-040	Hub power supply
MLi	699	Speakers
Polk Audio	n/a	Speaker-microphone
DeLorme	Tripmate	GPS Receiver
Intel	CS-430	Camera
Logitech	M-S34	Mouse

5.6 Clock Frequencies

5.6.1 DUT Clock Frequencies

Device:	Rugged Laptop PC
Clocks:	1.6 GHz processor
Device:	2.4GHz FHSS Cirronet Bluetooth Transmitter
Clocks:	n/a
Device:	2.4GHz DSSS WLAN Mini-PCI Card (802.11b/g)
Clocks:	n/a
Device:	Internal Dual Surface-Mount Antenna
Clocks:	None

5.6.2 Co-Located Clock Frequencies

Device:	Peripherals
Clocks:	n/a

Test Report S/N:	100504KBC-T565-E15W/E15B	
Test Date(s):	01Nov04 - 06Dec04	
Test Type(s):	FCC §15.247	IC RSS-210 Issue 5
Lab Registration(s):	FCC #714830	IC Lab File #3874

5.7 Mode(s) of Operation Tested

5.7.1 Bluetooth Transmitter

Customer supplied software was used to place the Bluetooth Transmitter at the appropriate channel with the power level and modulation for the specific measurement. During the co-transmission testing, the Bluetooth transmitter was set in its hopping mode with the following settings:

TX Frequency Range:	2402 - 2480 MHz
Software Power Gain Settings:	220 /45
RF Peak Conducted Output Power Tested:	Ch. 0 - +16.56 dBm Ch. 39 - +16.09 dBm Ch. 78 - +15.32 dBm
Modulation Type(s):	GFSK 0.5 BT Gaussian
Battery Type(s):	11.1V Lithium-Ion, 6.0Ah (Model: A2121-2)

5.7.2 WLAN Mini-PCI Card

TX Frequency Range:	2412 - 2462 MHz Ch. 1 (2412 MHz), Ch. 6 (2437 MHz) & Ch. 11 (2462 MHz) measured unless otherwise noted	
Software Power Gain Settings:	802.11b set to power setting of 17.5 with xpdGain at 6 802.11g set to power setting of 18.5 with xpdGain at 12	
RF Peak Conducted Output Power Tested:	802.11b 2412 MHz(1 Mbps) = 20.43 dBm 802.11b 2437 MHz(1 Mbps) = 20.33 dBm 802.11b 2462 MHz(1 Mbps) = 20.29 dBm	802.11g 2412 MHz(6 Mbps) = 20.10 dBm 802.11g 2437 MHz(6 Mbps) = 20.21 dBm 802.11g 2462 MHz(6 Mbps) = 20.17 dBm
Modes / Data Rates Tested*:	802.11b (1, 5.5, 11 Mbps checked in prescan) (1 Mbps determined to be worse case and used unless otherwise noted)	
	802.11g (6, 36, 54 Mbps checked in prescan) (6 Mbps determined to be worse case and used unless otherwise noted)	
Modulation Type(s):	OFDM with BPSK, QPSK, 16QAM, 64QAM, DBPSK, DQPSK, CCK	
Battery Type(s):	11.1V Lithium-ion, 6.0Ah (Model: A2121-2)	

5.7.3 DUT Exercising Software Description

The DUT was configured and exercised using customer supplied test software that allowed an operator to set the parameters of the Bluetooth transmitter and WLAN Mini-PCI Card operation. The settings used are described in each appendix. More specific information on the configuration and exercising can be found in the referenced single-transmit test reports.

Applicant:	Itronix Corporation	Model:	IX260PNL3054BT	IC ID:	1943A-IX260Pa	FCC ID:	KBCIX260PNL3054BT
Rugged Laptop PC with internal Senao NL-3054MP 802.11b/g WLAN and Cirronet BT2022 Bluetooth							
2004 Celltech Labs Inc	This document is not to be reproduced in whole or in part without the written permission of Celltech Labs Inc.						10 of 45

Test Report S/N:	100504KBC-T565-E15W/E15B		
Test Date(s):	01Nov04 - 06Dec04		
Test Type(s):	FCC §15.247	IC RSS-210 Issue 5	
Lab Registration(s):	FCC #714830	IC Lab File #3874	

5.8 Configuration Description

The DUT was configured, as described by the client as being representative of what would be delivered to a final customer. More specific details may be included in each appendix.

5.8.1 Configuration Justification

The DUT was tested in a configuration described by the client as being worse case but typical of normal use.

6.0 PASS/FAIL CRITERIA

Unless otherwise noted in the Appendices, the pass/fail criteria is the limit set forth in the reference standards. A DUT is considered to have passed the requirements, if the data collected during the described measurement procedure is no greater than the specified limits as defined. The pass/fail statements made in this report only apply to the unit tested.

Applicant:	Itronix Corporation	Model:	IX260PNL3054BT	IC ID:	1943A-IX260Pa	FCC ID:	KBCIX260PNL3054BT
Rugged Laptop PC with internal Senao NL-3054MP 802.11b/g WLAN and Cirronet BT2022 Bluetooth							
2004 Celltech Labs Inc	This document is not to be reproduced in whole or in part without the written permission of Celltech Labs Inc.						11 of 45

Test Report S/N:	100504KBC-T565-E15W/E15B		
Test Date(s):	01Nov04 - 06Dec04		
Test Type(s):	FCC §15.247	IC RSS-210 Issue 5	
Lab Registration(s):	FCC #714830	IC Lab File #3874	

APPENDIX

Applicant:	Itronix Corporation	Model:	IX260PNL3054BT	IC ID:	1943A-IX260Pa	FCC ID:	KBCIX260PNL3054BT
Rugged Laptop PC with internal Senao NL-3054MP 802.11b/g WLAN and Cirronet BT2022 Bluetooth							
2004 Celltech Labs Inc	This document is not to be reproduced in whole or in part without the written permission of Celltech Labs Inc.						12 of 45

Test Report S/N:	100504KBC-T565-E15W/E15B	
Test Date(s):	01Nov04 - 06Dec04	
Test Type(s):	FCC §15.247	IC RSS-210 Issue 5
Lab Registration(s):	FCC #714830	IC Lab File #3874

Appendix A - DUT Photographs

Photograph A-1 - Front of Open IX260+ Laptop PC



Photograph A-2 - Side of Open IX260+ Laptop PC



Photograph A-3 - WLAN Mini-PCI Card Location

Senao NL-3054MP
802.11b/g WLAN



Photograph A-4 - Bluetooth Transmitter Location

Bluetooth



Applicant:	Itronix Corporation	Model:	IX260PNL3054BT	IC ID:	1943A-IX260Pa	FCC ID:	KBCIX260PNL3054BT	
Rugged Laptop PC with internal Senao NL-3054MP 802.11b/g WLAN and Cirronet BT2022 Bluetooth								
2004 Celltech Labs Inc	This document is not to be reproduced in whole or in part without the written permission of Celltech Labs Inc.						13 of 45	

Test Report S/N:	100504KBC-T565-E15W/E15B	
Test Date(s):	01Nov04 - 06Dec04	
Test Type(s):	FCC §15.247	IC RSS-210 Issue 5
Lab Registration(s):	FCC #714830	IC Lab File #3874

Photograph A-5 - WLAN Mini-PCI Card



Photograph A-6 - Bluetooth Transmitter

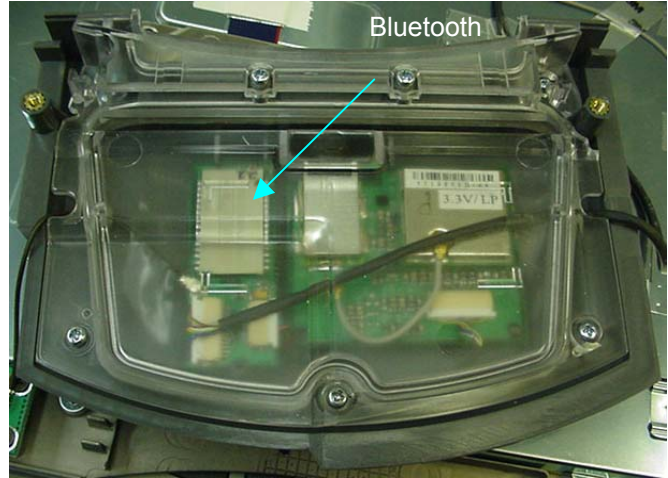

Photograph A-7 - Surface Mount Antenna Placement



Applicant:	Itronix Corporation	Model:	IX260PNL3054BT	IC ID:	1943A-IX260Pa	FCC ID:	KBCIX260PNL3054BT	
Rugged Laptop PC with internal Senao NL-3054MP 802.11b/g WLAN and Cirronet BT2022 Bluetooth								
2004 Celltech Labs Inc	This document is not to be reproduced in whole or in part without the written permission of Celltech Labs Inc.						14 of 45	

Test Report S/N:	100504KBC-T565-E15W/E15B	
Test Date(s):	01Nov04 - 06Dec04	
Test Type(s):	FCC §15.247	IC RSS-210 Issue 5
Lab Registration(s):	FCC #714830	IC Lab File #3874

Appendix B - Conducted Powerline Emissions Measurement

B.1. REFERENCES

Normative Reference Standard	CFR 47 FCC Part 15 §15.207
Procedure Reference	ANSI C63.4

B.2. LIMITS

§15.207: Compliance with the provisions of this paragraph shall be based on the measurement of the radio frequency voltage between each powerline and ground at the power terminal.

Frequency of Emission (MHz)	Conducted Limit (dBuV)	
	Quasi-Peak	Average
0.15 – 0.5	66 to 56*	56 to 46*
0.50 – 5.0	56	46
5.0 – 30.0	60	50

*Decrease with the logarithm of the frequency

B.3. ENVIRONMENTAL CONDITIONS

Temperature	+26 ± 5 °C
Humidity	31 % ± 10% RH
Barometric Pressure	101.4 kpa

B.4. EQUIPMENT LIST

ASSET NUMBER	MANUFACTURER	MODEL	DESCRIPTION	LAST CAL	CAL DUE
00063	HP	85662A	Spectrum Analyzer Display	na	na
00051	HP	8566B	Spectrum Analyzer RF Section	18May04	18May05
00049	HP	85650A	Quasi-Peak Adapter	18May04	18May05
00047	HP	85685A	Preselector	18May04	18May05
00083	EMCO	3825/2	Line Impedance Stabilization Network	29Apr04	29Apr05
00084	EMCO	3825/2	Line Impedance Stabilization Network	29Apr04	29Apr05

Applicant:	Itronix Corporation	Model:	IX260PNL3054BT	IC ID:	1943A-IX260Pa	FCC ID:	KBCIX260PNL3054BT
Rugged Laptop PC with internal Senao NL-3054MP 802.11b/g WLAN and Cirronet BT2022 Bluetooth							
2004 Celltech Labs Inc	This document is not to be reproduced in whole or in part without the written permission of Celltech Labs Inc.						15 of 45

Test Report S/N:	100504KBC-T565-E15W/E15B	
Test Date(s):	01Nov04 - 06Dec04	
Test Type(s):	FCC §15.247	IC RSS-210 Issue 5
Lab Registration(s):	FCC #714830	IC Lab File #3874

B.5. MEASUREMENT EQUIPMENT SETUP

MEASUREMENT EQUIPMENT CONNECTIONS	The conducted emissions were measured on each of the two AC powerline leads connected to the DUT's power supply brick. A two line LISN was used to make this measurement. A drawing of the equipment setup is shown in B.7
MEASUREMENT EQUIPMENT SETTINGS	<p>Each of the monitor ports from the 2-line LISN was connected in turn to the spectrum analyzer. The port not connected to the analyzer was terminated in a 50-ohm load. A pre-scan of the peak emission levels was made of the 150 kHz – 30 MHz range split into 4 equal frequency bands. The following were the instrumentation settings:</p> <p>Spectrum Analyzer: Start Frequency and Stop Frequency set by software for each of the four bands RBW: 100 kHz VBW: 300 kHz Sweep: 500 mS</p> <p>Quasi-Peak Adapter: Normal - Automatic Bandwidth Setting: 9 kHz</p> <p>The resulting data from each band was corrected and collected by software and presented in the graphical representations shown in B.9 for the two leads.</p> <p>A defined set of frequency points of interest on each lead were used by software to optimize a set of readings for each type of detector (peak, quasi-peak and average). This data was corrected by the software is presented in the tables shown in section B.9.</p>

Test Report S/N:	100504KBC-T565-E15W/E15B	
Test Date(s):	01Nov04 - 06Dec04	
Test Type(s):	FCC §15.247	IC RSS-210 Issue 5
Lab Registration(s):	FCC #714830	IC Lab File #3874

B.6. SETUP PHOTOS

Photograph B-1 - AC Powerline Conducted Emission Configuration



Photograph B-2 - AC Powerline Conducted Emission Cable Placement



Applicant:	Itronix Corporation	Model:	IX260PNL3054BT	IC ID:	1943A-IX260Pa	FCC ID:	KBCIX260PNL3054BT	
Rugged Laptop PC with internal Senao NL-3054MP 802.11b/g WLAN and Cirronet BT2022 Bluetooth								
2004 Celltech Labs Inc		This document is not to be reproduced in whole or in part without the written permission of Celltech Labs Inc.					17 of 45	

Test Report S/N:	100504KBC-T565-E15W/E15B	
Test Date(s):	01Nov04 - 06Dec04	
Test Type(s):	FCC §15.247	IC RSS-210 Issue 5
Lab Registration(s):	FCC #714830	IC Lab File #3874

B.7. SETUP DRAWING

Figure B-1 - Setup Drawing

Conducted Emission Measurement Setup

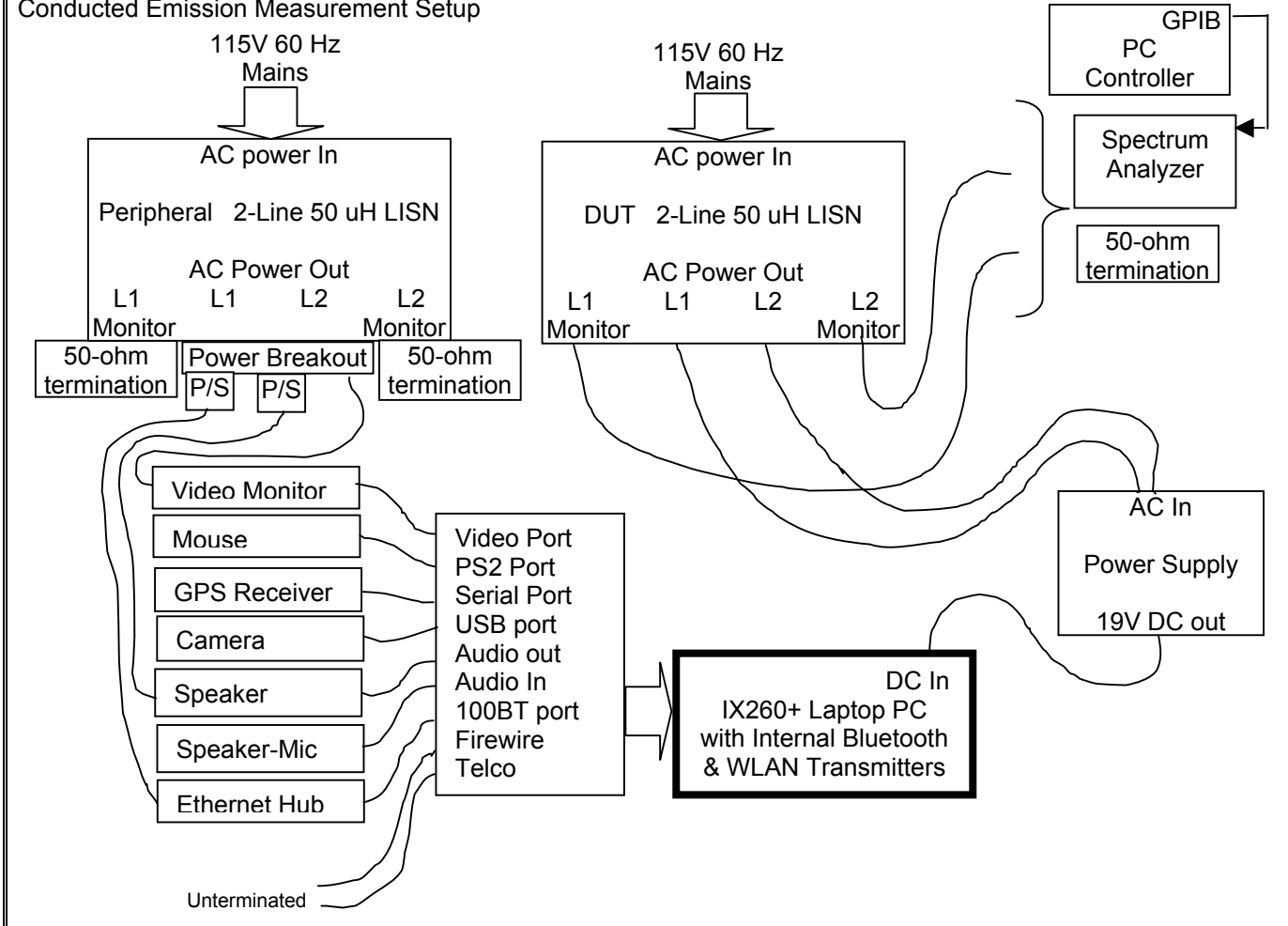

B.8. DUT OPERATING DESCRIPTION

Bluetooth	While hopping channels, the Bluetooth transmitter was set to transmit a data stream with a max. power setting.
WLAN	The WLAN transmitter was set to transmit with a max. power setting for 2462 MHz in Mode b.
PC	Other than operating the Bluetooth software and running MS windows, no PC exercising was performed.
Peripherals	All peripherals were active, but no specific traffic was initiated.

Test Report S/N:	100504KBC-T565-E15W/E15B		
Test Date(s):	01Nov04 - 06Dec04		
Test Type(s):	FCC §15.247	IC RSS-210 Issue 5	
Lab Registration(s):	FCC #714830	IC Lab File #3874	

B.9. TEST RESULTS

Following are peak emission plots and tabular data describing the peak, quasi-peak and average measurements made of the DUT.

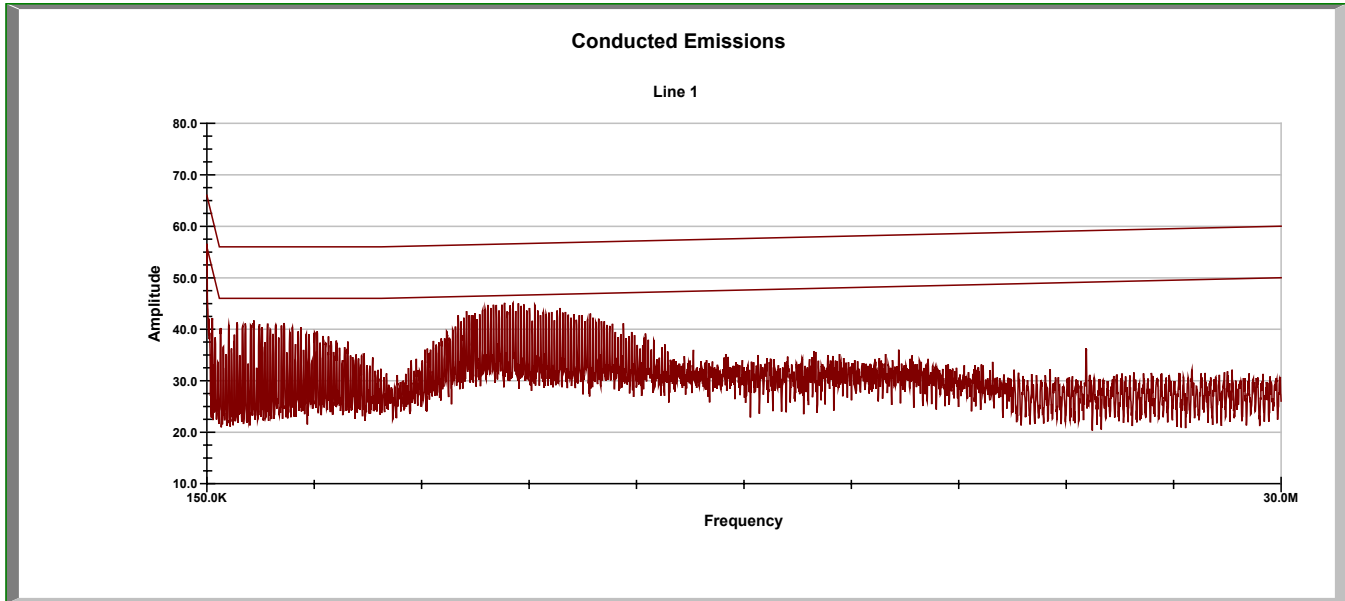

Project Number: 100504KBC-T565-E15W/E15B
 Company: Itronix
 Product: IX260+ with NL-3054MP WLAN & BT2022 Bluetooth

Standard: FCC 15.207
 Test Start Date: 30-Nov-04
 Test End Date: 30-Nov-04

Line 1 Conducted Emissions												
Frequency MHz	Uncorrected Reading			Correction Factor dB	Corrected Emission Level			Quasi-Peak Limit dBuV	Quasi-Peak Margin dB	Average Limit dBuV	Average Margin dB	Pass/Fail
	Peak dBuV	Quasi-Peak dBuV	Average dBuV		Peak dBuV	Quasi-Peak dBuV	Average dBuV					
0.302	43.80	42.20	42.16	0.81	44.61	43.01	42.97	60.18	17.17	50.18	7.21	Pass
1.449	42.30	41.49	40.46	0.30	42.60	41.79	40.76	56.00	14.21	46.00	5.24	Pass
2.283	42.40	32.83	31.52	0.29	42.69	33.12	31.81	56.00	22.88	46.00	14.19	Pass
3.204	40.40	39.11	35.21	0.30	40.70	39.41	35.51	56.00	16.60	46.00	10.50	Pass
8.359	46.10	30.83	19.00	0.32	46.42	31.15	19.32	60.00	28.85	50.00	30.68	Pass
8.578	45.70	30.75	18.65	0.32	46.02	31.07	18.97	60.00	28.93	50.00	31.03	Pass
9.308	45.60	44.55	37.63	0.32	45.93	44.88	37.95	60.00	15.13	50.00	12.05	Pass
17.010	38.40	34.25	22.48	0.37	38.77	34.62	22.85	60.00	25.38	50.00	27.15	Pass

Corrected Emission Level (dBuV) = Uncorrected Reading (dBuV) + Correction Factor (dB)
 Margin (dB) = Limit (dBuV) - Corrected Emission Level (dBuV)

Test Report S/N:	100504KBC-T565-E15W/E15B		
Test Date(s):	01Nov04 - 06Dec04		
Test Type(s):	FCC §15.247	IC RSS-210 Issue 5	
Lab Registration(s):	FCC #714830	IC Lab File #3874	

Conducted Emissions

Line 2

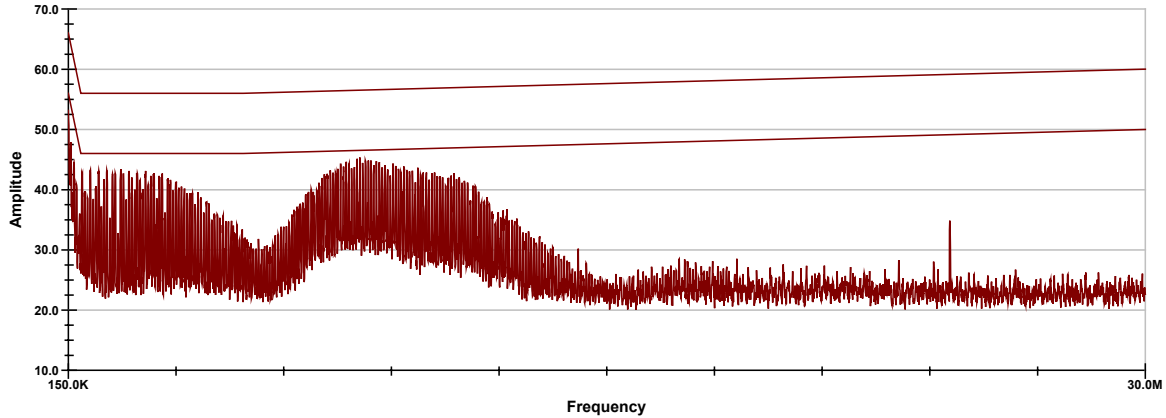

Project Number: 100504KBC-T565-E15W/E15B
 Company: Itronix
 Product: IX260+ with NL-3054MP WLAN & BT2022 Bluetooth

Standard: FCC 15.207
 Test Start Date: 30-Nov-04
 Test End Date: 30-Nov-04

Line 2 Conducted Emissions

Frequency MHz	Uncorrected Reading			Correction Factor	Corrected Emission Level			Quasi-Peak Limit	Quasi-Peak Margin	Average Limit	Average Margin	Pass/Fail
	Peak dBuV	Quasi-Peak dBuV	Average dBuV		Peak dBuV	Quasi-Peak dBuV	Average dBuV					
0.216	56.80	44.71	28.75	1.30	58.10	46.01	30.04	62.98	16.98	52.98	22.94	Pass
0.990	43.60	42.86	42.86	0.33	43.93	43.19	43.19	56.00	12.81	46.00	2.81	Pass
1.596	43.70	42.57	41.93	0.30	44.00	42.87	42.23	56.00	13.13	46.00	3.77	Pass
2.282	43.30	42.43	42.12	0.29	43.59	42.72	42.41	56.00	13.28	46.00	3.59	Pass
7.844	44.60	43.22	38.74	0.32	44.92	43.54	39.06	60.00	16.46	50.00	10.94	Pass
8.226	45.50	41.25	34.80	0.33	45.83	41.58	35.13	60.00	18.42	50.00	14.87	Pass
9.822	43.60	42.36	39.57	0.33	43.93	42.69	39.90	60.00	17.31	50.00	10.10	Pass
14.234	29.60	25.33	20.99	0.40	30.00	25.73	21.39	60.00	34.27	50.00	28.61	Pass

Corrected Emission Level (dBuV) = Uncorrected Reading (dBuV) + Correction Factor (dB)
 Margin (dB) = Limit (dBuV) - Corrected Emission Level (dBuV)

Applicant:	Itronix Corporation	Model:	IX260PNL3054BT	IC ID:	1943A-IX260Pa	FCC ID:	KBCIX260PNL3054BT
------------	---------------------	--------	----------------	--------	---------------	---------	-------------------

Rugged Laptop PC with internal Senao NL-3054MP 802.11b/g WLAN and Cirronet BT2022 Bluetooth



Test Report S/N:	100504KBC-T565-E15W/E15B	
Test Date(s):	01Nov04 - 06Dec04	
Test Type(s):	FCC §15.247	IC RSS-210 Issue 5
Lab Registration(s):	FCC #714830	IC Lab File #3874

B.10. PASS/FAIL

In reference to the results outlined in B.9 the DUT passes the requirements as stated in the reference standards as follows:
The RF voltage measured in reference to ground on each of the power line conductors does not exceed the limits as outlined in FCC 15.207.

B.11. SIGN-OFF

I attest to the accuracy of the data. All measurements reported herein were performed by me and are correct to the best of my knowledge and belief. I assume full responsibility for the completeness of these measurements.



Russell Pipe
Senior Compliance Technologist
Celltech Labs Inc

30Nov04
Date

Applicant:	Itronix Corporation	Model:	IX260PNL3054BT	IC ID:	1943A-IX260Pa	FCC ID:	KBCIX260PNL3054BT
Rugged Laptop PC with internal Senao NL-3054MP 802.11b/g WLAN and Cirronet BT2022 Bluetooth							
2004 Celltech Labs Inc	This document is not to be reproduced in whole or in part without the written permission of Celltech Labs Inc.						21 of 45

Test Report S/N:	100504KBC-T565-E15W/E15B		
Test Date(s):	01Nov04 - 06Dec04		
Test Type(s):	FCC §15.247	IC RSS-210 Issue 5	
Lab Registration(s):	FCC #714830	IC Lab File #3874	

Appendix C - Bluetooth Peak Conducted RF Power Measurement

C.1. REFERENCES

Normative Reference Standard	FCC CFR 47 §15.247(b) (3)
Procedure Reference	FCC 97-114

C.2. LIMITS

C.2.1. FCC CFR

§15.247(b): The maximum peak output power of the intentional radiator shall not exceed the following:
 §15.247(b) (3) For system using digital modulation in the 902 – 928 MHz, 2400 – 2483.5 MHz, and 5725 – 5850 MHz bands: 1 Watt.

*This measurement was made as a reference to determine the effects the co-transmission of the WLAN had on the output RF power of the Bluetooth transmitter. The single transmit conducted power measured with the same settings was:

Channel	Frequency MHz	Peak Conducted Power	
		dBm	Watts
0	2402	16.76	0.047
39	2441	16.22	0.042
78	2480	15.36	0.034

C.3. ENVIRONMENTAL CONDITIONS

Temperature	25.2 +/- 2 °C
Humidity	35 +/- 2 %
Barometric Pressure	96.34 kPa

C.4. EQUIPMENT LIST

ASSET NUMBER	MANUFACTURER	MODEL	DESCRIPTION	LAST CAL	CAL DUE
00007	Gigatronics	8652A	Power Meter	18Oct04	18Oct05
00013	Gigatronics	80701A	Power Sensor	11Oct04	11Oct05
00075	Alpha Wire-J	9223	2ft. RG223/U RF Cable	08Jul04*	24Jun05
00076	Pasternack	PE7014-30	30dB 2 Watt Attenuator	08Jul04*	24Jun05

*Cable and attenuator verified with power meter prior to use

Applicant:	Itronix Corporation	Model:	IX260PNL3054BT	IC ID:	1943A-IX260Pa	FCC ID:	KBCIX260PNL3054BT
Rugged Laptop PC with internal Senao NL-3054MP 802.11b/g WLAN and Cirronet BT2022 Bluetooth							
2004 Celltech Labs Inc	This document is not to be reproduced in whole or in part without the written permission of Celltech Labs Inc.						22 of 45

Test Report S/N:	100504KBC-T565-E15W/E15B	
Test Date(s):	01Nov04 - 06Dec04	
Test Type(s):	FCC §15.247	IC RSS-210 Issue 5
Lab Registration(s):	FCC #714830	IC Lab File #3874

C.5. MEASUREMENT EQUIPMENT SETUP

Measurement Equipment Connections	The equipment was connected as shown in the setup drawing in C.6.
Measurement Equipment Settings	To evaluate the maximum peak power, the power meter was set using the following setting: Mode: MAP

C.6. SETUP DRAWING

Figure C-1 - Setup Drawing

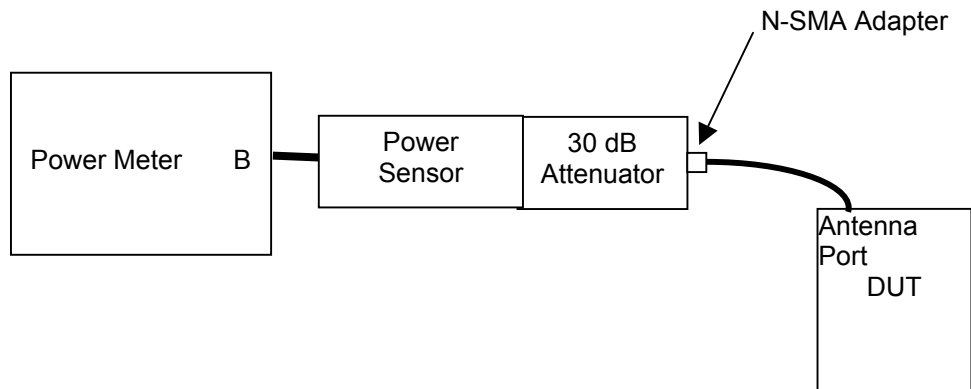

C.7. DUT OPERATING DESCRIPTION

Measurements were made at three channels throughout the band, Low Channel (2402 MHz), Mid Channel (2441 MHz), High Channel (2480 MHz).

Applicant:	Itronix Corporation	Model:	IX260PNL3054BT	IC ID:	1943A-IX260Pa	FCC ID:	KBCIX260PNL3054BT
Rugged Laptop PC with internal Senao NL-3054MP 802.11b/g WLAN and Cirronet BT2022 Bluetooth							
2004 Celltech Labs Inc	This document is not to be reproduced in whole or in part without the written permission of Celltech Labs Inc.						23 of 45

Test Report S/N:	100504KBC-T565-E15W/E15B		
Test Date(s):	01Nov04 - 06Dec04		
Test Type(s):	FCC §15.247	IC RSS-210 Issue 5	
Lab Registration(s):	FCC #714830	IC Lab File #3874	

C.8. TEST RESULTS				
Channel	Frequency	Peak Conducted Power		Limit
		MHz	dBm	Watts
0 (Low)	2402	16.56	0.045	1
39 (Mid)	2441	16.09	0.041	1
79 (High)	2480	15.32	0.034	1

C.9. PASS/FAIL

In reference to the results outlined in C.8, the DUT passes the requirements as stated in the reference standards as follows: FCC 15.247 (b) (3): The peak power did not exceed 1 Watt.

As a reference with the single transmit configuration, the conducted power levels are reduced by a maximum 0.20 dB (16.76 dBm vs 16.56 dBm) when the WLAN transmitter is active.

C.10. SIGN-OFF

I attest to the accuracy of the data. All measurements reported herein were performed by me and are correct to the best of my knowledge and belief. I assume full responsibility for the completeness of these measurements.



Russell Pipe
Senior Compliance Technologist
Celltech Labs Inc.

6Dec04
Date

Applicant:	Itronix Corporation	Model:	IX260PNL3054BT	IC ID:	1943A-IX260Pa	FCC ID:	KBCIX260PNL3054BT
Rugged Laptop PC with internal Senao NL-3054MP 802.11b/g WLAN and Cirronet BT2022 Bluetooth							
2004 Celltech Labs Inc	This document is not to be reproduced in whole or in part without the written permission of Celltech Labs Inc.						24 of 45

Test Report S/N:	100504KBC-T565-E15W/E15B		
Test Date(s):	01Nov04 - 06Dec04		
Test Type(s):	FCC §15.247	IC RSS-210 Issue 5	
Lab Registration(s):	FCC #714830	IC Lab File #3874	

Appendix D - WLAN Peak Conducted RF Power Measurement

D.1. REFERENCES

Normative Reference Standard	FCC CFR 47 §15.247(b) (3)
Procedure Reference	FCC 97-114

D.2. LIMITS

D.2.1. FCC CFR

§15.247(b): The maximum peak output power of the intentional radiator shall not exceed the following:
 §15.247(b) (3) For system using digital modulation in the 902 – 928 MHz, 2400 – 2483.5 MHz, and 5725 – 5850 MHz bands: 1 Watt.

*This measurement was made as a reference to determine the effects the co-transmission of the Bluetooth module had on the output RF power of the WLAN card. The single transmit conducted power levels were:

Channel	Frequency	802.11b				802.11g			
		Peak Conducted Power		Limit	-26 dB EBW	Peak Conducted Power		Limit	-26 dB EBW
	MHz	dBm	Watts	Watts	MHz	dBm	Watts	Watts	MHz
Low	2412	20.42	0.110	1	19.2	20.11	0.103	1	29.59
Mid	2437	20.28	0.107	1	19.2	20.13	0.103	1	29.70
High	2462	20.35	0.108	1	19.2	20.07	0.102	1	30.56

D.3. ENVIRONMENTAL CONDITIONS

Temperature	25.2 +/- 2 °C
Humidity	35 +/- 2 %
Barometric Pressure	96.34 kPa

D.4. EQUIPMENT LIST

ASSET NUMBER	MANUFACTURER	MODEL	DESCRIPTION	LAST CAL	CAL DUE
00015	Agilent	E4408B	Spectrum Analyzer	29Dec03	29Dec04
00075	Alpha Wire-J	9223	2ft. RG223/U RF Cable	08Jul04*	24Jun05
00076	Pasternack	PE7014-30	30dB 2 Watt Attenuator	08Jul04*	24Jun05

*Cable and attenuator verified with power meter prior to use

Applicant:	Itronix Corporation	Model:	IX260PNL3054BT	IC ID:	1943A-IX260Pa	FCC ID:	KBCIX260PNL3054BT
Rugged Laptop PC with internal Senao NL-3054MP 802.11b/g WLAN and Cirronet BT2022 Bluetooth							
2004 Celltech Labs Inc	This document is not to be reproduced in whole or in part without the written permission of Celltech Labs Inc.						25 of 45

Test Report S/N:	100504KBC-T565-E15W/E15B	
Test Date(s):	01Nov04 - 06Dec04	
Test Type(s):	FCC §15.247	IC RSS-210 Issue 5
Lab Registration(s):	FCC #714830	IC Lab File #3874

D.5. MEASUREMENT EQUIPMENT SETUP

Measurement Equipment Connections	The equipment was connected as shown in the setup drawing in D.6.
Measurement Equipment Settings	<p>To evaluate the maximum peak power, the 26 dB bandwidth needs to be determined. This is performed with the spectrum analyzer using the following setting:</p> <p>RBW – 300 kHz VBW – 1MHz Span – 50 MHz Detector – Peak Average – Power Trace Average – 100</p> <p>Once the 26 dB bandwidth is determined, the channel power is measured within the band with the following spectrum analyzer settings:</p> <p>RBW – 1 MHz VBW – 3 MHz Detector – Peak Average – Power Integrate BW – equal to specific -26 dB EBW</p>

D.6. SETUP DRAWING

Figure D-1 - Setup Drawing

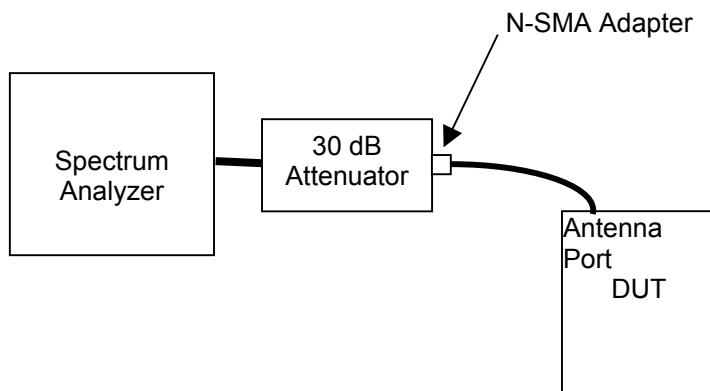

D.7. DUT OPERATING DESCRIPTION

The worst-case configuration was determined from prescan investigations. Measurements were made at three channels throughout the band, Low Channel (2412 MHz), Mid Channel (2437 MHz), High Channel (2462 MHz) and for both Modes b and g.

Applicant:	Itronix Corporation	Model:	IX260PNL3054BT	IC ID:	1943A-IX260Pa	FCC ID:	KBCIX260PNL3054BT	
Rugged Laptop PC with internal Senao NL-3054MP 802.11b/g WLAN and Cirronet BT2022 Bluetooth								
2004 Celltech Labs Inc	This document is not to be reproduced in whole or in part without the written permission of Celltech Labs Inc.						26 of 45	

Test Report S/N:	100504KBC-T565-E15W/E15B		
Test Date(s):	01Nov04 - 06Dec04		
Test Type(s):	FCC §15.247	IC RSS-210 Issue 5	
Lab Registration(s):	FCC #714830	IC Lab File #3874	

D.8. TEST RESULTS

Channel	Frequency	802.11b				802.11g			
		Peak Conducted Power		Limit	-26 dB EBW	Peak Conducted Power		Limit	-26 dB EBW
	MHz	dBm	Watts	Watts	MHz	dBm	Watts	Watts	MHz
Low	2412	20.43	0.110	1	19.2	20.10	0.102	1	29.59
Mid	2437	20.33	0.108	1	19.2	20.21	0.105	1	29.70
High	2462	20.29	0.107	1	19.2	20.17	0.104	1	30.56

D.9. PASS/FAIL

In reference to the results outlined in D.8 the DUT passes the requirements as stated in the reference standards as follows: FCC 15.247 (b) (3): The peak power did not exceed 1 Watt and the effect of the Bluetooth co-transmitting had no significant effect on the conducted power of the WLAN.

D.10. SIGN-OFF

I attest to the accuracy of the data. All measurements reported herein were performed by me and are correct to the best of my knowledge and belief. I assume full responsibility for the completeness of these measurements.



 Duane M. Friesen, C.E.T.
 EMC Manager
 Celltech Labs Inc

 1Dec04

Date

Applicant:	Itronix Corporation	Model:	IX260PNL3054BT	IC ID:	1943A-IX260Pa	FCC ID:	KBCIX260PNL3054BT	
Rugged Laptop PC with internal Senao NL-3054MP 802.11b/g WLAN and Cirronet BT2022 Bluetooth								
2004 Celltech Labs Inc	This document is not to be reproduced in whole or in part without the written permission of Celltech Labs Inc.						27 of 45	

Test Report S/N:	100504KBC-T565-E15W/E15B	
Test Date(s):	01Nov04 - 06Dec04	
Test Type(s):	FCC §15.247	IC RSS-210 Issue 5
Lab Registration(s):	FCC #714830	IC Lab File #3874

Appendix E - Radiated Spurious Emissions Measurement

E.1. REFERENCES

Normative Reference Standard	FCC CFR 47 §15.247(c)
Procedure Reference	ANSI C63.4; FCC 97-114

E.2. LIMITS

E.2.1. FCC CFR 47

§15.247 (c): In any 100 kHz bandwidth outside the frequency band in which the spread spectrum or digitally modulated intentional radiator is operating, the radio frequency power that is produced by the intentional radiator shall be at least 20 dB below that in the 100 kHz bandwidth within the band that contains the highest level of desired power, based on either an RF conducted or a radiated measurement. Attenuation below the general limits specified in 15.209 (a) is not required.

Note: Spurious emissions within the restricted bands are reported in Appendix F.

E.3. ENVIRONMENTAL CONDITIONS

Temperature	27.4 +/- 2 °C
Humidity	33 +/- 2 %
Barometric Pressure	96.24 +/- 0.2 kPa

E.4. EQUIPMENT LIST

ASSET NUMBER	MANUFACTURER	MODEL	DESCRIPTION	LAST CAL	CAL DUE
00072	EMCO	2075	Mini-mast	n/a	n/a
00073	EMCO	2080	Turn Table	n/a	n/a
00071	EMCO	2090	Multi-Device Controller	n/a	n/a
00035	ETS	3115	Double Ridged Guide Horn	24Mar04	24Mar05
00015	Agilent	E4408B	Spectrum Analyzer	29Dec03	29Dec04
00049	HP	8566B	Spectrum Analyzer RF Section	18May04	18May05
00047	HP	85685A	RF Preselector	18May04	18May05
00048	Gore	65474	Microwave Cable	20May04	20May05
00030	HP	83017A	LNA	20May04	20May05

Applicant:	Itronix Corporation	Model:	IX260PNL3054BT	IC ID:	1943A-IX260Pa	FCC ID:	KBCIX260PNL3054BT
Rugged Laptop PC with internal Senao NL-3054MP 802.11b/g WLAN and Cirronet BT2022 Bluetooth							
2004 Celltech Labs Inc	This document is not to be reproduced in whole or in part without the written permission of Celltech Labs Inc.						28 of 45

Test Report S/N:	100504KBC-T565-E15W/E15B	
Test Date(s):	01Nov04 - 06Dec04	
Test Type(s):	FCC §15.247	IC RSS-210 Issue 5
Lab Registration(s):	FCC #714830	IC Lab File #3874

E.5. MEASUREMENT EQUIPMENT SETUP

MEASUREMENT EQUIPMENT CONNECTIONS	The measurement equipment was connected as shown in E.6. A number of antennas were used to cover the applicable frequency range test. The ranges in which each antenna was used are as follows:			
	Frequency Range		Antenna	
	1 GHz – 18 GHz		ETS 3115 Horn	
MEASUREMENT EQUIPMENT SETTINGS	The spectrum analyzer was set to the following settings:			
	Frequency Range	RBW	VBW	Detector
	MHz	kHz	kHz	
	> 1000	1000*	1000	Peak*
*As a worst case measurement, the average limit was applied to measurements made with a peak detector using a RBW of 1 MHz (vs the specified 100 kHz), when possible.				

E.6. SETUP DRAWING

Figure E-1 - Setup Drawing

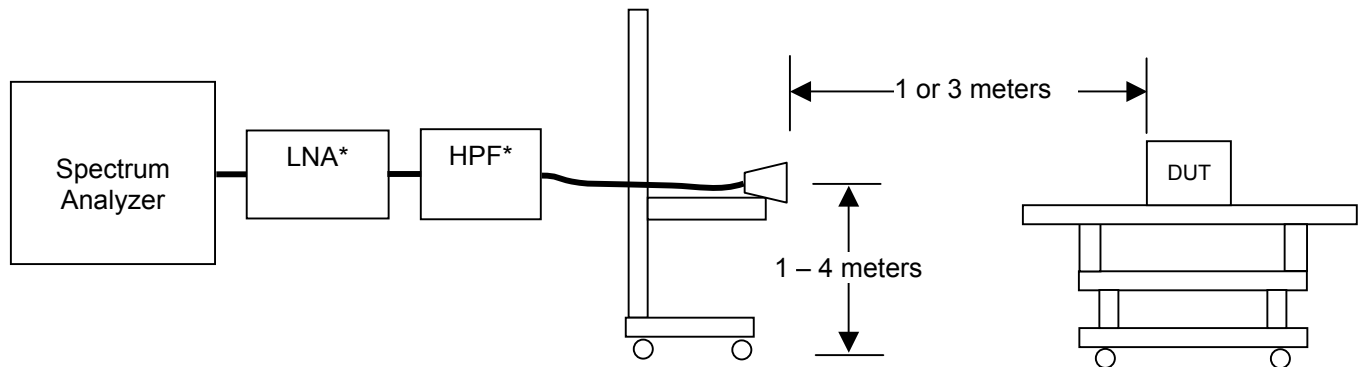

* Used for >1GHz

Applicant:	Itronix Corporation	Model:	IX260PNL3054BT	IC ID:	1943A-IX260Pa	FCC ID:	KBCIX260PNL3054BT
Rugged Laptop PC with internal Senao NL-3054MP 802.11b/g WLAN and Cirronet BT2022 Bluetooth							
2004 Celltech Labs Inc	This document is not to be reproduced in whole or in part without the written permission of Celltech Labs Inc.						29 of 45

Test Report S/N:	100504KBC-T565-E15W/E15B	
Test Date(s):	01Nov04 - 06Dec04	
Test Type(s):	FCC §15.247	IC RSS-210 Issue 5
Lab Registration(s):	FCC #714830	IC Lab File #3874

E.7. SETUP PHOTOGRAPHS

Photograph E-1 - 3115 Horn Antenna



E.8. DUT OPERATING DESCRIPTION

Measurements were made of the bands that may contain inter-modulation products with both the Bluetooth and WLAN radios transmitting. Measurements were made for each combination of WLAN channels and Modes (low and high, Mode b and g) with the Bluetooth transmitter hopping or on a worse case channel when defined.

Applicant:	Itronix Corporation	Model:	IX260PNL3054BT	IC ID:	1943A-IX260Pa	FCC ID:	KBCIX260PNL3054BT
Rugged Laptop PC with internal Senao NL-3054MP 802.11b/g WLAN and Cirronet BT2022 Bluetooth							
2004 Celltech Labs Inc	This document is not to be reproduced in whole or in part without the written permission of Celltech Labs Inc.						30 of 45

Test Report S/N:	100504KBC-T565-E15W/E15B		
Test Date(s):	01Nov04 - 06Dec04		
Test Type(s):	FCC §15.247	IC RSS-210 Issue 5	
Lab Registration(s):	FCC #714830	IC Lab File #3874	

E.9. TEST RESULTS

E.9.1. Band-edge Spurious Field Strength not in a Restricted Band (WLAN Mode b co-transmitting with Bluetooth)



Project Number: 100504KBC-T565-E15W/E15B Standard: FCC15.247
 Company: Itronix Test Start Date: 01Nov04
 Product: IX260+ with Senao WLAN & Bluetooth Test End Date: 06Dec04

Senao WLAN Mode b with Bluetooth CH0													
WLAN Channel	Polarity	Distance	Frequency	Carrier Radiated Field Strength	Delta-Marker	Detector	Calculated Band-edge Field Strength	Limit Distance	Duty Cycle Correction	Corrected Calculated Band-edge Field Strength	Specified Limit	Margin	Pass/Fail
		m	MHz	dBuV/m	dB		dBuV/m	m	dB	dBuV/m	dBuV/m	dB	
1	H	3	2400.00	102.48	39.28	PK	63.20	3.00	-20.00	43.20	82.48	39.28	Pass
1	H	3	2400.00	95.68	39.28	AV	56.40	3.00	-20.00	36.40	75.68	39.28	Pass
1	V	3	2400.00	96.58	43.87	PK	52.71	3.00	-20.00	32.71	82.48	49.77	Pass
1	V	3	2400.00	89.28	43.87	AV	45.41	3.00	-20.00	25.41	75.68	50.27	Pass

Formulae:

Total CF (dB) = Antenna Factor (dB) + Cable Factor (dB) + Other Factor (Amplifier Gain, Filter Loss, etc) (dB)
 Field Strength (dBuV/m) = SA Reading (dBuV) + Total CF (dB/m)
 Limit (dBuV/m) = Published Limit (dBuV/m) + Limit Distance Correction (dB)
 Calculated Band-edge Field Strength (dBuV/m) = Carrier Radiated Field Strength (dBuV/m) - Delta-Marker (dB)
 Margin (dB) = Limit (dBuV/m) - Field Strength (dBuV/m)
 Duty Cycle Correction (dB) = 20 * log (max time transmitting in 100 mS (mS) / 100 mS)
 Corrected Calculated Band-edge Field Strength (dBuV/m) = Calculated Band-edge Field Strength (dBuV/m) + Duty Cycle Correction (dB)

Note: Measurements and calculation reference the Marker-Delta Method Described in FCC Public Notice DA 00-705

E.9.2. Band-edge Spurious Field Strength not in a Restricted Band (WLAN Mode g co-transmitting with Bluetooth)



Project Number: 100504KBC-T565-E15W/E15B Standard: FCC15.247
 Company: Itronix Test Start Date: 01Nov04
 Product: IX260+ with Senao WLAN & Bluetooth Test End Date: 06Dec04

Senao WLAN Mode g with Bluetooth CH0													
WLAN Channel	Polarity	Distance	Frequency	Carrier Radiated Field Strength	Delta-Marker	Detector	Calculated Band-edge Field Strength	Limit Distance	Duty Cycle Correction	Corrected Calculated Band-edge Field Strength	Specified Limit	Margin	Pass/Fail
		m	MHz	dBuV/m	dB		dBuV/m	m	dB	dBuV/m	dBuV/m	dB	
1	H	3	2400.00	103.48	28.39	PK	75.09	3.00	-20.00	55.09	83.48	28.39	Pass
1	H	3	2400.00	98.58	28.39	AV	70.19	3.00	-20.00	50.19	83.48	33.29	Pass
1	V	3	2400.00	96.18	29.10	PK	67.08	3.00	-20.00	47.08	83.48	36.40	Pass
1	V	3	2400.00	90.88	29.10	AV	61.78	3.00	-20.00	41.78	83.48	41.70	Pass

Formulae:

Total CF (dB) = Antenna Factor (dB) + Cable Factor (dB) + Other Factor (Amplifier Gain, Filter Loss, etc) (dB)
 Field Strength (dBuV/m) = SA Reading (dBuV) + Total CF (dB/m)
 Limit (dBuV/m) = Published Limit (dBuV/m) + Limit Distance Correction (dB)
 Calculated Band-edge Field Strength (dBuV/m) = Carrier Radiated Field Strength (dBuV/m) - Delta-Marker (dB)
 Margin (dB) = Limit (dBuV/m) - Field Strength (dBuV/m)
 Duty Cycle Correction (dB) = 20 * log (max time transmitting in 100 mS (mS) / 100 mS)
 Corrected Calculated Band-edge Field Strength (dBuV/m) = Calculated Band-edge Field Strength (dBuV/m) + Duty Cycle Correction (dB)

Note: Measurements and calculation reference the Marker-Delta Method Described in FCC Public Notice DA 00-705

Applicant:	Itronix Corporation	Model:	IX260PNL3054BT	IC ID:	1943A-IX260Pa	FCC ID:	KBCIX260PNL3054BT	
Rugged Laptop PC with internal Senao NL-3054MP 802.11b/g WLAN and Cirronet BT2022 Bluetooth								
2004 Celltech Labs Inc		This document is not to be reproduced in whole or in part without the written permission of Celltech Labs Inc.						31 of 45

Test Report S/N:	100504KBC-T565-E15W/E15B	
Test Date(s):	01Nov04 - 06Dec04	
Test Type(s):	FCC §15.247	IC RSS-210 Issue 5
Lab Registration(s):	FCC #714830	IC Lab File #3874

E.9.3. Out-of-Band Spurious Field Strength not in a Restricted Band (WLAN Mode b co-transmitting with Bluetooth)

No emissions that could be attributed to the WLAN and Bluetooth co-transmitting were measured within 20 dB of the limit.

E.9.4. Out-of-Band Spurious Field Strength not in a Restricted Band (WLAN Mode g co-transmitting with Bluetooth)

No emissions that could be attributed to the WLAN and Bluetooth co-transmitting were measured within 20 dB of the limit.

E.10. PASS/FAIL

In reference to the results outlined in E.9, the DUT passes the requirements as stated in the reference standards as follows: FCC 15.247 (c): All emissions within any 100kHz bandwidth outside the operating frequency band are greater than 20 dB below the maximum 100 kHz bandwidth signal within the operating band.

E.11. SIGN-OFF

I attest to the accuracy of the data. All measurements reported herein were performed by me and are correct to the best of my knowledge and belief. I assume full responsibility for the completeness of these measurements.



Russell Pipe
Senior Compliance Technologist
Celltech Labs Inc.

26Nov04

Date

Applicant:	Itronix Corporation	Model:	IX260PNL3054BT	IC ID:	1943A-IX260Pa	FCC ID:	KBCIX260PNL3054BT
Rugged Laptop PC with internal Senao NL-3054MP 802.11b/g WLAN and Cirronet BT2022 Bluetooth							
2004 Celltech Labs Inc		This document is not to be reproduced in whole or in part without the written permission of Celltech Labs Inc.					32 of 45

Test Report S/N:	100504KBC-T565-E15W/E15B	
Test Date(s):	01Nov04 - 06Dec04	
Test Type(s):	FCC §15.247	IC RSS-210 Issue 5
Lab Registration(s):	FCC #714830	IC Lab File #3874

Appendix F - Restricted Band Emissions Measurement

F.1. REFERENCES	
Normative Reference Standard	FCC CFR 47 §15.205 (a) (b), FCC CFR 47 §15.209 (a)
Procedure Reference	FCC 97-114

F.2. LIMITS																																																																									
FCC CFR 47 §15.205	(a) Except as shown in paragraph (d) of this section, only spurious emissions are permitted in any of the frequency bands listed below:																																																																								
	<table border="1"> <thead> <tr> <th>MHz</th> <th>MHz</th> <th>MHz</th> <th>GHz</th> </tr> </thead> <tbody> <tr><td>0.090-0.110</td><td>16.42-16.423</td><td>399.9-410</td><td>4.5-5.15</td></tr> <tr><td>10.495-0.505</td><td>16.69475-16.69525</td><td>608-614</td><td>5.35-5.46</td></tr> <tr><td>2.1735-2.1905</td><td>16.80425-16.80475</td><td>960-1240</td><td>7.25-7.75</td></tr> <tr><td>4.125-4.128</td><td>25.5-25.67</td><td>1300-1427</td><td>8.025-8.5</td></tr> <tr><td>4.17725-4.17775</td><td>37.5-38.25</td><td>1435-1626.5</td><td>9.0-9.2</td></tr> <tr><td>4.20725-4.20775</td><td>73-74.6</td><td>1645.5-1646.5</td><td>9.3-9.5</td></tr> <tr><td>6.215-6.218</td><td>74.8-75.2</td><td>1660-1710</td><td>10.6-12.7</td></tr> <tr><td>6.26775-6.26825</td><td>108-121.94</td><td>1718.8-1722.2</td><td>13.25-13.4</td></tr> <tr><td>6.31175-6.31225</td><td>123-138</td><td>2200-2300</td><td>14.47-14.5</td></tr> <tr><td>8.291-8.294</td><td>149.9-150.05</td><td>2310-2390</td><td>15.35-16.2</td></tr> <tr><td>8.362-8.366</td><td>156.52475-156.52525</td><td>2483.5-2500</td><td>17.7-21.4</td></tr> <tr><td>8.37625-8.38675</td><td>156.7-156.9</td><td>2655-2900</td><td>22.01-23.12</td></tr> <tr><td>8.41425-8.41475</td><td>162.0125-167.17</td><td>3260-3267</td><td>23.6-24.0</td></tr> <tr><td>12.29-12.293</td><td>167.72-173.2</td><td>3332-3339</td><td>31.2-31.8</td></tr> <tr><td>12.51975-12.52025</td><td>240-285</td><td>3345.8-3358</td><td>36.43-36.5</td></tr> <tr><td>12.57675-12.57725</td><td>322-335.4</td><td>3600-4400</td><td>(2)</td></tr> <tr><td>13.36-13.41</td><td></td><td></td><td></td></tr> </tbody> </table> <p>¹Until February 1, 1999, this restricted band shall be 0.490-0.510 MHz. ²Above 38.6</p>	MHz	MHz	MHz	GHz	0.090-0.110	16.42-16.423	399.9-410	4.5-5.15	10.495-0.505	16.69475-16.69525	608-614	5.35-5.46	2.1735-2.1905	16.80425-16.80475	960-1240	7.25-7.75	4.125-4.128	25.5-25.67	1300-1427	8.025-8.5	4.17725-4.17775	37.5-38.25	1435-1626.5	9.0-9.2	4.20725-4.20775	73-74.6	1645.5-1646.5	9.3-9.5	6.215-6.218	74.8-75.2	1660-1710	10.6-12.7	6.26775-6.26825	108-121.94	1718.8-1722.2	13.25-13.4	6.31175-6.31225	123-138	2200-2300	14.47-14.5	8.291-8.294	149.9-150.05	2310-2390	15.35-16.2	8.362-8.366	156.52475-156.52525	2483.5-2500	17.7-21.4	8.37625-8.38675	156.7-156.9	2655-2900	22.01-23.12	8.41425-8.41475	162.0125-167.17	3260-3267	23.6-24.0	12.29-12.293	167.72-173.2	3332-3339	31.2-31.8	12.51975-12.52025	240-285	3345.8-3358	36.43-36.5	12.57675-12.57725	322-335.4	3600-4400	(2)	13.36-13.41			
MHz	MHz	MHz	GHz																																																																						
0.090-0.110	16.42-16.423	399.9-410	4.5-5.15																																																																						
10.495-0.505	16.69475-16.69525	608-614	5.35-5.46																																																																						
2.1735-2.1905	16.80425-16.80475	960-1240	7.25-7.75																																																																						
4.125-4.128	25.5-25.67	1300-1427	8.025-8.5																																																																						
4.17725-4.17775	37.5-38.25	1435-1626.5	9.0-9.2																																																																						
4.20725-4.20775	73-74.6	1645.5-1646.5	9.3-9.5																																																																						
6.215-6.218	74.8-75.2	1660-1710	10.6-12.7																																																																						
6.26775-6.26825	108-121.94	1718.8-1722.2	13.25-13.4																																																																						
6.31175-6.31225	123-138	2200-2300	14.47-14.5																																																																						
8.291-8.294	149.9-150.05	2310-2390	15.35-16.2																																																																						
8.362-8.366	156.52475-156.52525	2483.5-2500	17.7-21.4																																																																						
8.37625-8.38675	156.7-156.9	2655-2900	22.01-23.12																																																																						
8.41425-8.41475	162.0125-167.17	3260-3267	23.6-24.0																																																																						
12.29-12.293	167.72-173.2	3332-3339	31.2-31.8																																																																						
12.51975-12.52025	240-285	3345.8-3358	36.43-36.5																																																																						
12.57675-12.57725	322-335.4	3600-4400	(2)																																																																						
13.36-13.41																																																																									
	(b) Except as provided in paragraphs (d) and (e), the field strength of emissions appearing within these frequency bands shall not exceed the limits shown in 15.209. At frequencies equal to or less than 1000 MHz, compliance with the limits in Section 15.209 shall be demonstrated using measurement instrumentation employing a CISPR quasi-peak detector. Above 1000 MHz, compliance with the emission limits in Section 15.209 shall be demonstrated based on the average value of the measured emissions. The provisions of 15.35 apply to these measurements.																																																																								
FCC CFR 47 §15.209	(a) Except as provided elsewhere in this Subpart, the emissions from an intentional radiator shall not exceed the field strength levels specified in the following table:																																																																								
	<table border="1"> <thead> <tr> <th>Frequency</th> <th>Field Strength</th> <th>Measurement Distance</th> </tr> <tr> <th>MHz</th> <th>uV/m</th> <th>Meters</th> </tr> </thead> <tbody> <tr><td>.009 - 0.490</td><td>2400/F(kHz)</td><td>300</td></tr> <tr><td>0.490 - 1.705</td><td>24000/F(kHz)</td><td>30</td></tr> <tr><td>1.705 - 30.0</td><td>30</td><td>30</td></tr> <tr><td>30 - 88</td><td>100</td><td>3</td></tr> <tr><td>88 - 216</td><td>150</td><td>3</td></tr> <tr><td>216 - 960</td><td>200</td><td>3</td></tr> <tr><td>Above 960</td><td>500</td><td>3</td></tr> </tbody> </table>	Frequency	Field Strength	Measurement Distance	MHz	uV/m	Meters	.009 - 0.490	2400/F(kHz)	300	0.490 - 1.705	24000/F(kHz)	30	1.705 - 30.0	30	30	30 - 88	100	3	88 - 216	150	3	216 - 960	200	3	Above 960	500	3																																													
Frequency	Field Strength	Measurement Distance																																																																							
MHz	uV/m	Meters																																																																							
.009 - 0.490	2400/F(kHz)	300																																																																							
0.490 - 1.705	24000/F(kHz)	30																																																																							
1.705 - 30.0	30	30																																																																							
30 - 88	100	3																																																																							
88 - 216	150	3																																																																							
216 - 960	200	3																																																																							
Above 960	500	3																																																																							
	(b) In the emission table above, the tighter limit applies at the band edges.																																																																								

Test Report S/N:	100504KBC-T565-E15W/E15B		
Test Date(s):	01Nov04 - 06Dec04		
Test Type(s):	FCC §15.247	IC RSS-210 Issue 5	
Lab Registration(s):	FCC #714830	IC Lab File #3874	

F.3. ENVIRONMENTAL CONDITIONS

Temperature	27.4 +/- 2 °C
Humidity	33 +/- 2 %
Barometric Pressure	96.24 +/- 0.2 kPa

F.4. EQUIPMENT LIST

ASSET NUMBER	MANUFACTURER	MODEL	DESCRIPTION	LAST CAL	CAL DUE
00072	EMCO	2075	Mini-mast	n/a	n/a
00073	EMCO	2080	Turn Table	n/a	n/a
00071	EMCO	2090	Multi-Device Controller	n/a	n/a
00035	ETS	3115	Double Ridged Guide Horn	24Mar04	24Mar05
00015	Agilent	E4408B	Spectrum Analyzer	29Dec03	29Dec04
00049	HP	8566B	Spectrum Analyzer RF Section	18May04	18May05
00047	HP	85685A	RF Preselector	18May04	18May05
00048	Gore	65474	Microwave Cable	20May04	20May05
00030	HP	83017A	LNA	20May04	20May05

Applicant:	Itronix Corporation	Model:	IX260PNL3054BT	IC ID:	1943A-IX260Pa	FCC ID:	KBCIX260PNL3054BT
Rugged Laptop PC with internal Senao NL-3054MP 802.11b/g WLAN and Cirronet BT2022 Bluetooth							
2004 Celltech Labs Inc	This document is not to be reproduced in whole or in part without the written permission of Celltech Labs Inc.						34 of 45

Test Report S/N:	100504KBC-T565-E15W/E15B	
Test Date(s):	01Nov04 - 06Dec04	
Test Type(s):	FCC §15.247	IC RSS-210 Issue 5
Lab Registration(s):	FCC #714830	IC Lab File #3874

F.5. MEASUREMENT EQUIPMENT SETUP

MEASUREMENT EQUIPMENT CONNECTIONS	The measurement equipment was connected as shown in F.6. A number of antennas were used to cover the applicable frequency range test. The ranges in which each antenna was used are as follows:			
	Frequency Range		Antenna	
	1 GHz – 18 GHz		ETS 3115 Horn	
MEASUREMENT EQUIPMENT SETTINGS	The spectrum analyzer was set to the following settings:			
	Frequency Range	RBW	VBW	Detector
	MHz	kHz	kHz	
	> 1000	1000*	1000	
	*As a worse case measurement, the average/quasi-peak limits were applied to measurements made with a peak detector.			

F.6. SETUP DRAWING

Figure F-1 - Setup Drawing

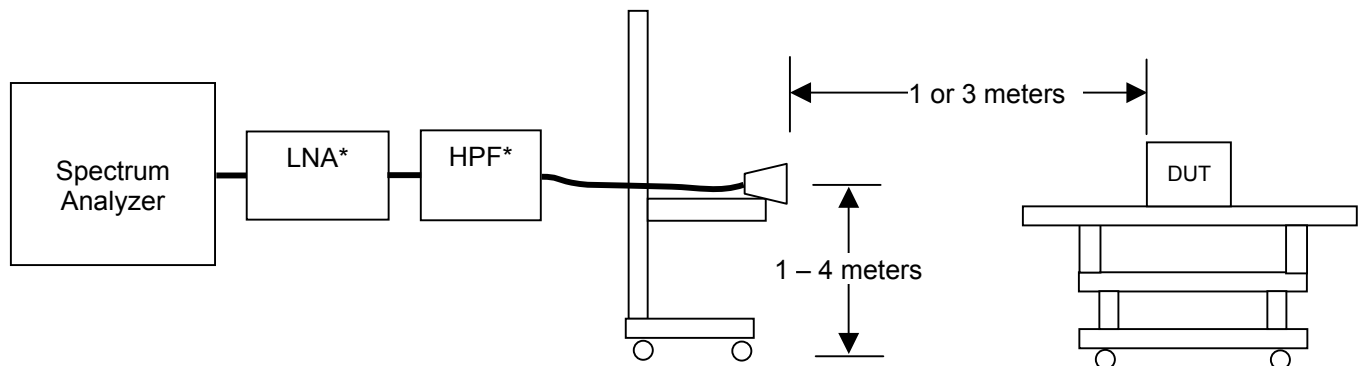

* Used for >1GHz

Test Report S/N:	100504KBC-T565-E15W/E15B	
Test Date(s):	01Nov04 - 06Dec04	
Test Type(s):	FCC §15.247	IC RSS-210 Issue 5
Lab Registration(s):	FCC #714830	IC Lab File #3874

F.7. SETUP PHOTOGRAPHS

Photograph F-1 - 3115 Horn Antenna

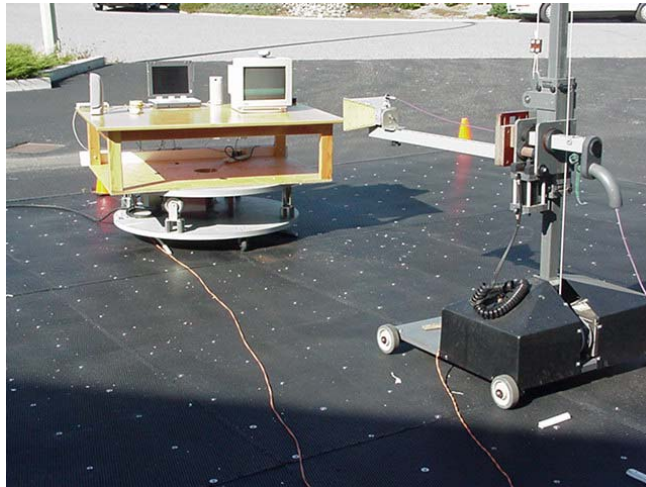

Photograph F-2 - Front of Radiated Emission Configuration



Photograph F-3 - Back of Radiated Emission Configuration

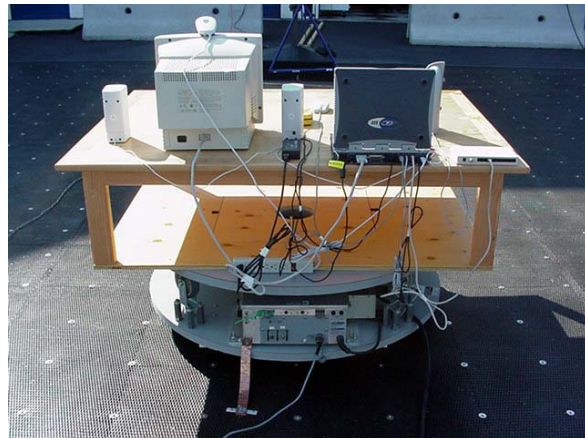

F.8. DUT OPERATING DESCRIPTION

Measurements were made of the bands that may contain inter-modulation products with both the Bluetooth and WLAN radios transmitting. Measurements were made for each combination of WLAN channels and Modes (low and high, Mode b and g) with the Bluetooth transmitter hopping or on a worse case channel when defined.

Applicant:	Itronix Corporation	Model:	IX260PNL3054BT	IC ID:	1943A-IX260Pa	FCC ID:	KBCIX260PNL3054BT
Rugged Laptop PC with internal Senao NL-3054MP 802.11b/g WLAN and Cirronet BT2022 Bluetooth							
2004 Celltech Labs Inc	This document is not to be reproduced in whole or in part without the written permission of Celltech Labs Inc.						36 of 45

Test Report S/N:	100504KBC-T565-E15W/E15B		
Test Date(s):	01Nov04 - 06Dec04		
Test Type(s):	FCC §15.247	IC RSS-210 Issue 5	
Lab Registration(s):	FCC #714830	IC Lab File #3874	

F.9. TEST RESULTS

F.9.1. Band-edge Spurious Field Strength adjacent a Restricted Band (WLAN Mode b co-transmitting with Bluetooth)



Project Number: 100504KBC-T565-E15W/E15B Standard: FCC15.247
 Company: Itronix Test Start Date: 01Nov04
 Product: IX260+ with Senao WLAN & Bluetooth Test End Date: 06Dec04

Senao WLAN Mode b with Bluetooth CH78													
WLAN Channel	Polarity	Distance	Frequency	Carrier Radiated Field Strength	Delta-Marker	Detector	Calculated Band-edge Field Strength	Limit Distance	Duty Cycle Correction	Corrected Calculated Band-edge Field Strength	Specified Limit	Margin	Pass/Fail
		m	MHz	dBuV/m	dB		dBuV/m	m	dB	dBuV/m	dBuV/m	dB	
11	H	3	2483.50	106.27	41.97	PK	64.30	3.00	-20.00	44.30	73.98	29.68	Pass
11	H	3	2483.50	98.27	41.97	AV	56.30	3.00	-20.00	36.30	53.98	17.68	Pass
11	V	3	2483.50	97.77	49.07	PK	48.70	3.00	-20.00	28.70	73.98	45.28	Pass
11	V	3	2483.50	89.67	49.07	AV	40.60	3.00	-20.00	20.60	53.98	33.38	Pass

Formulae:

Total CF (dB) = Antenna Factor (dB) + Cable Factor (dB) + Other Factor (Amplifier Gain, Filter Loss, etc) (dB)

Field Strength (dBuV/m) = SA Reading (dBuV) + Total CF (dB/m)

Limit (dBuV/m) = Published Limit (dBuV/m) + Limit Distance Correction (dB)

Calculated Band-edge Field Strength (dBuV/m) = Carrier Radiated Field Strength (dBuV/m) - Delta-Marker (dB)

Margin (dB) = Limit (dBuV/m) - Field Strength (dBuV/m)

Duty Cycle Correction (dB) = $20 \cdot \log(\text{max time transmitting in } 100 \text{ mS} / 100 \text{ mS})$

Corrected Calculated Band-edge Field Strength (dBuV/m) = Calculated Band-edge Field Strength (dBuV/m) + Duty Cycle Correction (dB)

Note: Measurements and calculation reference the Marker-Delta Method Described in FCC Public Notice DA 00-705

F.9.2. Band-edge Spurious Field Strength adjacent a Restricted Band (WLAN Mode g co-transmitting with Bluetooth)



Project Number: 100504KBC-T565-E15W/E15B Standard: FCC15.247
 Company: Itronix Test Start Date: 01Nov04
 Product: IX260+ with Senao WLAN & Bluetooth Test End Date: 06Dec04

Senao WLAN Mode g with Bluetooth CH78													
WLAN Channel	Polarity	Distance	Frequency	Carrier Radiated Field Strength	Delta-Marker	Detector	Calculated Band-edge Field Strength	Limit Distance	Duty Cycle Correction	Corrected Calculated Band-edge Field Strength	Specified Limit	Margin	Pass/Fail
		m	MHz	dBuV/m	dB		dBuV/m	m	dB	dBuV/m	dBuV/m	dB	
11	H	3	2483.50	111.57	46.22	PK	65.35	3.00	-20.00	45.35	73.98	28.63	Pass
11	H	3	2483.50	102.07	46.22	AV	55.85	3.00	-20.00	35.85	53.98	18.13	Pass
11	V	3	2483.50	105.87	48.07	PK	57.80	3.00	-20.00	37.80	73.98	36.18	Pass
11	V	3	2483.50	96.67	48.07	AV	48.60	3.00	-20.00	28.60	53.98	25.38	Pass

Formulae:

Total CF (dB) = Antenna Factor (dB) + Cable Factor (dB) + Other Factor (Amplifier Gain, Filter Loss, etc) (dB)

Field Strength (dBuV/m) = SA Reading (dBuV) + Total CF (dB/m)

Limit (dBuV/m) = Published Limit (dBuV/m) + Limit Distance Correction (dB)

Calculated Band-edge Field Strength (dBuV/m) = Carrier Radiated Field Strength (dBuV/m) - Delta-Marker (dB)

Margin (dB) = Limit (dBuV/m) - Field Strength (dBuV/m)

Duty Cycle Correction (dB) = $20 \cdot \log(\text{max time transmitting in } 100 \text{ mS} / 100 \text{ mS})$

Corrected Calculated Band-edge Field Strength (dBuV/m) = Calculated Band-edge Field Strength (dBuV/m) + Duty Cycle Correction (dB)

Note: Measurements and calculation reference the Marker-Delta Method Described in FCC Public Notice DA 00-705

Applicant:	Itronix Corporation	Model:	IX260PNL3054BT	IC ID:	1943A-IX260Pa	FCC ID:	KBCIX260PNL3054BT
------------	---------------------	--------	----------------	--------	---------------	---------	-------------------

Rugged Laptop PC with internal Senao NL-3054MP 802.11b/g WLAN and Cirronet BT2022 Bluetooth



Test Report S/N:	100504KBC-T565-E15W/E15B		
Test Date(s):	01Nov04 - 06Dec04		
Test Type(s):	FCC §15.247	IC RSS-210 Issue 5	
Lab Registration(s):	FCC #714830	IC Lab File #3874	

F.9.3. Out-of-Band Spurious Field Strength within a Restricted Band (WLAN Mode b co-transmitting with Bluetooth)



Project Number: 100504KBC-T565-E15W/E15B
 Company: Itronix
 Product: IX260+ with WLAN and Bluetooth

Standard: FCC15.209
 Test Start Date: 01Nov04
 Test End Date: 06Dec04

WLAN Mode b with Bluetooth Hopping																				
Channel	Polarity	Distance	Rx Antenna	Frequency	SA Level	Noise Floor	Rx AF	Rx CL	Other Rx	Total Rx CF	Field Strength	Duty Cycle Correction	Corrected Field Strength	Detector	Limit Distance	Limit Distance Correction	Calculated Limit	Lower Limit	Margin	Pass/Fail
		m		MHz	dBuV		dB/m	dB	dB	dB/m	dBuV/m	dB	dBuV/m	(PK/QP/AV)	m	dB	dBuV/m		dB	
1	H	3	Hom SN6276	2390.00	55.60	30.22	3.47	-27.40	6.29	61.89	-20.00	41.89	PK	3.00	0.00	53.98	*	12.09	PASS	
1	H	3	Hom SN6276	7404.75	56.50	38.53	6.35	-34.32	10.56	67.06	-20.00	47.06	PK	3.00	0.00	73.98		26.92	PASS	
1	H	3	Hom SN6276	7404.75	43.10	38.53	6.35	-34.32	10.56	53.66	-20.00	33.66	AV	3.00	0.00	53.98		20.32	PASS	
1	H	3	Hom SN6276	2390.00	50.80	30.22	3.47	-27.40	6.29	57.09	-20.00	37.09	PK	3.00	0.00	53.98	*	16.89	PASS	
1	V	3	Hom SN6276	4802.50	53.10	35.31	4.96	-34.08	6.18	59.28	-20.00	39.28	PK	3.00	0.00	53.98	*	14.70	PASS	
1	V	3	Hom SN6276	7408.25	57.20	38.53	6.36	-34.32	10.57	67.77	-20.00	47.77	PK	3.00	0.00	73.98		26.20	PASS	
1	V	3	Hom SN6276	7408.25	43.20	38.53	6.36	-34.32	10.57	53.77	-20.00	33.77	AV	3.00	0.00	53.98		20.20	PASS	
11	H	3	Hom SN6276	2688.90	50.10	31.00	3.65	-26.98	7.68	57.78	-20.00	37.78	PK	3.00	0.00	53.98	*	16.20	PASS	
11	H	3	Hom SN6276	7427.50	55.00	38.57	6.40	-34.32	10.65	65.65	-20.00	45.65	PK	3.00	0.00	73.98		28.33	PASS	
11	H	3	Hom SN6276	7427.50	42.90	38.57	6.40	-34.32	10.65	53.55	-20.00	33.55	AV	3.00	0.00	53.98		20.43	PASS	
11	V	3	Hom SN6276	4802.50	53.10	35.31	4.96	-34.08	6.18	59.28	-20.00	39.28	PK	3.00	0.00	53.98	*	14.70	PASS	
11	V	3	Hom SN6276	7355.76	57.10	38.44	6.33	-34.32	10.45	67.55	-20.00	47.55	PK	3.00	0.00	73.98		26.43	PASS	
11	V	3	Hom SN6276	7355.76	34.30	38.44	6.33	-34.32	10.45	44.75	-20.00	24.75	AV	3.00	0.00	53.98		29.23	PASS	

Formulae:

Total CF (dB) = Antenna Factor (dB) + Cable Factor (dB) + Other Factor (Amplifier Gain, Filter Loss, etc) (dB)
 Field Strength (dBuV/m) = SA Reading (dBuV) + Total CF (dB/m)
 Limit Distance Correction (dB) = 40 * log(d1/d2) for f < 30 MHz, 20*log(d1/d2) for f > 30 MHz; where d1 is the measurement distance and d2 is the published limit distance
 Limit (dBuV/m) = Published Limit (dBuV/m) + Limit Distance Correction (dB)
 Margin (dB) = Limit (dBuV/m) - Field Strength (dBuV/m)

*The frequency points reported describe the highest local emission measured and are used to describe the measured inter-modulation product. No out-of-band emissions were measured above the levels noted.

Where there is acceptable margin between the peak emission reported and the average limit stated, the average limit is referenced. Where the average limit is exceeded by the peak emission or the margin unacceptable, the peak limit is referenced and an average measurement made and referenced to the average limit.

Applicant:	Itronix Corporation	Model:	IX260PNL3054BT	IC ID:	1943A-IX260Pa	FCC ID:	KBCIX260PNL3054BT	
Rugged Laptop PC with internal Senao NL-3054MP 802.11b/g WLAN and Cirronet BT2022 Bluetooth								
2004 Celltech Labs Inc	This document is not to be reproduced in whole or in part without the written permission of Celltech Labs Inc.						38 of 45	

Test Report S/N:	100504KBC-T565-E15W/E15B		
Test Date(s):	01Nov04 - 06Dec04		
Test Type(s):	FCC §15.247	IC RSS-210 Issue 5	
Lab Registration(s):	FCC #714830	IC Lab File #3874	

F.9.4. Out-of-Band Spurious Field Strength within a Restricted Band (WLAN Mode g co-transmitting with Bluetooth)



Project Number: 100504KBC-T565-E15W/E15B
 Company: Itronix
 Product: IX260+ with WLAN and Bluetooth

Standard: FCC15.209
 Test Start Date: 01Nov04
 Test End Date: 06Dec04

WLAN Mode g with Bluetooth Hopping																				
Channel	Polarity	Distance	Rx Antenna	Frequency	SA Level	Noise Floor	Rx AF	Rx CL	Other Rx	Total Rx CF	Field Strength	Duty Cycle Correction	Corrected Field Strength	Detector	Limit Distance	Limit Distance Correction	Calculated Limit	Lower Limit	Margin	Pass/Fail
		m		MHz	dBuV	dBm	dB	dB	dB	dB/m	dBuV/m	dB	dBuV/m	PK/QP/AV	m	dB	dBuV/m		dB	
1	H	3	Horn SN6276	2390.00	86.80	30.22	3.47	-37.40	-3.71	83.09	-20.00	63.09	PK	3.00	0.00	73.98		10.89	PASS	
1	H	3	Horn SN6276	2390.00	67.80	30.22	3.47	-37.40	-3.71	64.09	-20.00	44.09	AV	3.00	0.00	53.98		9.89	PASS	
1	H	3	Horn SN6276	2688.00	50.90	31.00	3.65	-26.98	7.67	58.57	-20.00	38.57	PK	3.00	0.00	53.98	*	15.41	PASS	
1	H	3	Horn SN6276	7275.25	57.30	38.30	6.31	-34.32	10.28	67.58	-20.00	47.58	PK	3.00	0.00	73.98		26.39	PASS	
1	H	3	Horn SN6276	7275.25	43.40	38.30	6.31	-34.32	10.28	53.68	-20.00	33.68	AV	3.00	0.00	53.98		20.29	PASS	
1	V	3	Horn SN6276	2390.00	66.70	30.22	3.47	-37.40	-3.71	62.99	-20.00	42.99	PK	3.00	0.00	53.98	*	10.99	PASS	
1	V	3	Horn SN6276	2687.90	52.90	31.00	3.65	-26.98	7.67	60.57	-20.00	40.57	PK	3.00	0.00	53.98	*	13.41	PASS	
1	V	3	Horn SN6276	7275.25	57.90	38.30	6.31	-34.32	10.28	68.18	-20.00	48.18	PK	3.00	0.00	73.98		25.79	PASS	
1	V	3	Horn SN6276	7275.25	43.40	38.30	6.31	-34.32	10.28	53.68	-20.00	33.68	AV	3.00	0.00	53.98		20.29	PASS	
11	H	3	Horn SN6276	2688.00	51.90	31.00	3.65	-20.76	13.89	65.79	-20.00	45.79	PK	3.00	0.00	73.98		28.19	PASS	
11	H	3	Horn SN6276	2688.00	39.00	31.00	3.65	-20.76	13.89	52.89	-20.00	32.89	AV	3.00	0.00	53.98		21.09	PASS	
11	H	3	Horn SN6276	4949.50	48.90	35.60	5.05	-26.03	14.62	63.52	-20.00	43.52	PK	3.00	0.00	53.98	*	10.46	PASS	
11	H	3	Horn SN6276	7368.00	55.20	38.46	6.33	-34.32	10.48	65.68	-20.00	45.68	PK	3.00	0.00	73.98		28.30	PASS	
11	H	3	Horn SN6276	7368.00	43.10	38.46	6.33	-34.32	10.48	53.58	-20.00	33.58	AV	3.00	0.00	53.98		20.40	PASS	
11	V	3	Horn SN6276	4949.50	50.10	35.60	5.05	-34.09	6.56	56.66	-20.00	36.66	PK	3.00	0.00	53.98	*	17.32	PASS	

Formulae:
 Total CF (dB) = Antenna Factor (dB) + Cable Factor (dB) + Other Factor (Amplifier Gain, Filter Loss, etc) (dB)
 Field Strength (dBuV/m) = SA Reading (dBuV) + Total CF (dB/m)
 Limit Distance Correction (dB) = 40 * log(d1/d2) for f < 30 MHz, 20*log(d1/d2) for f > 30 MHz; where d1 is the measurement distance and d2 is the published limit distance
 Limit (dBuV/m) = Published Limit (dBuV/m) + Limit Distance Correction (dB)
 Margin (dB) = Limit (dBuV/m) - Field Strength (dBuV/m)

*The frequency points reported describe the highest local emission measured and are used to describe the measured inter-modulation product of interest. No out-of-band emissions were measured above the levels noted.

Where there is acceptable margin between the peak emission reported and the average limit stated, the average limit is referenced. Where the average limit is exceeded by the peak emission or the margin unacceptable, the peak limit is referenced and an average measurement made and referenced to the average limit.

Applicant:	Itronix Corporation	Model:	IX260PNL3054BT	IC ID:	1943A-IX260Pa	FCC ID:	KBCIX260PNL3054BT	
Rugged Laptop PC with internal Senao NL-3054MP 802.11b/g WLAN and Cirronet BT2022 Bluetooth								
2004 Celltech Labs Inc		This document is not to be reproduced in whole or in part without the written permission of Celltech Labs Inc.					39 of 45	

Test Report S/N:	100504KBC-T565-E15W/E15B	
Test Date(s):	01Nov04 - 06Dec04	
Test Type(s):	FCC §15.247	IC RSS-210 Issue 5
Lab Registration(s):	FCC #714830	IC Lab File #3874

F.10. PASS/FAIL

In reference to the results outlined in F.9, the DUT passes the requirements as stated in the reference standards as follows: FCC 15.205 (a) (b) and 15.209 (a): No emissions were measured within the restricted bands as outlined in 15.205 that exceeded the limits stated in 15.209.

F.11. SIGN-OFF

I attest to the accuracy of the data. All measurements reported herein were performed by me and are correct to the best of my knowledge and belief. I assume full responsibility for the completeness of these measurements.



Russell Pipe
Senior Compliance Technologist
Celltech Labs Inc.

26Nov04
Date

Applicant:	Itronix Corporation	Model:	IX260PNL3054BT	IC ID:	1943A-IX260Pa	FCC ID:	KBCIX260PNL3054BT
Rugged Laptop PC with internal Senao NL-3054MP 802.11b/g WLAN and Cirronet BT2022 Bluetooth							
2004 Celltech Labs Inc	This document is not to be reproduced in whole or in part without the written permission of Celltech Labs Inc.						40 of 45

Test Report S/N:	100504KBC-T565-E15W/E15B	
Test Date(s):	01Nov04 - 06Dec04	
Test Type(s):	FCC §15.247	IC RSS-210 Issue 5
Lab Registration(s):	FCC #714830	IC Lab File #3874

Appendix G - Maximum Permissible Exposure Calculation

G.1. REFERENCES

Normative Reference Standard	FCC CFR 47§1.1310 IEEE Std C95.1-1999
Procedure Reference	FCC CFR 47§2.1091

G.2. LIMITS

FCC CFR 47§1.1310 Table 1(b)	1.0 mW/cm ²
------------------------------	------------------------

G.3. ENVIRONMENTAL CONDITIONS

Temperature	na
Humidity	na
Barometric Pressure	na

G.4. EQUIPMENT LIST

ASSET NUMBER	MANUFACTURER	MODEL	DESCRIPTION	LAST CAL	CAL DUE
na					

G.5. MEASUREMENT EQUIPMENT SETUP

MEASUREMENT EQUIPMENT CONNECTIONS	The results described herein were determined by the calculation, so no measurement equipment was used.
MEASUREMENT EQUIPMENT SETTINGS	na

G.6. SETUP PHOTOS

na

G.7. SETUP DRAWINGS

na

G.8. DUT OPERATING DESCRIPTION

Bluetooth	The maximum Bluetooth conducted power used for these calculations was measured on Channel 0, with a power setting of 220/45 while the WLAN was transmitting on Channel 1 Mode b with a power setting of 17.5 and xpdGain at 6.
WLAN	The maximum WLAN conducted powers used for these calculations were measured on Channel 1 for Mode b with a power setting of 17.5 and xpdGain at 6, and Channel 6 for Mode g with a power setting of 18.5 and xpdGain at 12, while the Bluetooth transmitter was transmitting a data stream with a max. power setting (220/45).

Applicant:	Itronix Corporation	Model:	IX260PNL3054BT	IC ID:	1943A-IX260Pa	FCC ID:	KBCIX260PNL3054BT
Rugged Laptop PC with internal Senao NL-3054MP 802.11b/g WLAN and Cirronet BT2022 Bluetooth							
2004 Celltech Labs Inc	This document is not to be reproduced in whole or in part without the written permission of Celltech Labs Inc.						41 of 45

Test Report S/N:	100504KBC-T565-E15W/E15B	
Test Date(s):	01Nov04 - 06Dec04	
Test Type(s):	FCC §15.247	IC RSS-210 Issue 5
Lab Registration(s):	FCC #714830	IC Lab File #3874

G.9. TEST RESULTS

G.9.1. Single-Transmit Calculations:

Rangestar Internal Antenna (WLAN 802.11b mode):

Tx Frequency: 2412 (MHz)
 RF Output Power at Antenna Input Terminal: 20.43 (dBm)
 Antenna gain: 4.50 (dBi)

S= 1.00 (mW/cm²)
 P= 110.4079 (mW)
 G= 2.82 (numeric)

R = 4.98 (cm)

S at 20cm: 0.06183856 (mW/cm²)

Rangestar Internal Antenna (WLAN 802.11g mode):

Tx Frequency: 2437 (MHz)
 RF Output Power at Antenna Input Terminal: 20.21 (dBm)
 Antenna gain: 4.50 (dBi)

S= 1.00 (mW/cm²)
 P= 104.9542 (mW)
 G= 2.82 (numeric)

R = 4.85 (cm)

S at 20cm: 0.058784032 (mW/cm²)

Test Report S/N:	100504KBC-T565-E15W/E15B	
Test Date(s):	01Nov04 - 06Dec04	
Test Type(s):	FCC §15.247	IC RSS-210 Issue 5
Lab Registration(s):	FCC #714830	IC Lab File #3874

Rangestar Internal Antenna (Bluetooth):

Tx Frequency: **2402** (MHz)
 RF Output Power at Antenna Input Terminal: **16.56** (dBm)
 Antenna gain: **4.50** (dBi)

S= **1.00** (mW/cm²)
 P= **45.2898** (mW)
 G= **2.82** (numeric)

R = 3.19 (cm)

S at 20cm: **0.025366431** (mW/cm²)

Formulae:

$$S = \frac{PG}{4\pi R^2}$$

$$R = \sqrt{\frac{P}{4\pi S}}$$
 where: S = Power Density Limit
 P = Power Applied to the Antenna
 G = Numeric Antenna Gain
 R = Distance from Antenna

Results:

Mode	Power Density Limit	RF Conducted Output Power	Antenna Gain	MPE Distance	Power Density at 20 cm
	mW/cm ²	dBm	dBi	cm	mW/cm ²
WLAN (802.11b)	1.0	20.43	4.5	4.98	0.062
WLAN (802.11g)	1.0	20.21	4.5	4.85	0.059
Bluetooth (CH0)	1.0	16.56	4.5	3.19	0.025

G.9.2. Co-Transmit MPE Calculations

Radio	20 cm Power Density	Ratio	Limit
	mW/cm ²	(S/Limit)	mW/cm ²
Highest WLAN	0.062	0.062	1
Bluetooth	0.025	0.025	1
	Sum =	0.087	1

Test Report S/N:	100504KBC-T565-E15W/E15B	
Test Date(s):	01Nov04 - 06Dec04	
Test Type(s):	FCC §15.247	IC RSS-210 Issue 5
Lab Registration(s):	FCC #714830	IC Lab File #3874

G.10. PASS/FAIL

In reference to the results outlined in G.9 the DUT passes the requirements as stated in the reference standards as follows:
 1) The DUT must comply with the minimum spacing requirement of 20 cm to ensure an exposure of not more than 1 mW/cm².

G.11. SIGN-OFF

I attest to the accuracy of the data. All measurements reported herein were performed by me and are correct to the best of my knowledge and belief. I assume full responsibility for the completeness of these measurements.



 Duane M. Friesen, C.E.T.
 EMC Manager
 Celltech Labs Inc.

 06Dec04

Date

Applicant:	Itronix Corporation	Model:	IX260PNL3054BT	IC ID:	1943A-IX260Pa	FCC ID:	KBCIX260PNL3054BT
Rugged Laptop PC with internal Senao NL-3054MP 802.11b/g WLAN and Cirronet BT2022 Bluetooth							
2004 Celltech Labs Inc	This document is not to be reproduced in whole or in part without the written permission of Celltech Labs Inc.						44 of 45

Test Report S/N:	100504KBC-T565-E15W/E15B		
Test Date(s):	01Nov04 - 06Dec04		
Test Type(s):	FCC §15.247	IC RSS-210 Issue 5	
Lab Registration(s):	FCC #714830	IC Lab File #3874	

END OF DOCUMENT

Applicant:	Itronix Corporation	Model:	IX260PNL3054BT	IC ID:	1943A-IX260Pa	FCC ID:	KBCIX260PNL3054BT
Rugged Laptop PC with internal Senao NL-3054MP 802.11b/g WLAN and Cirronet BT2022 Bluetooth							
2004 Celltech Labs Inc	This document is not to be reproduced in whole or in part without the written permission of Celltech Labs Inc.						45 of 45