

Test Report S/N:	100504KBC-T562-E15W	
Test Date(s):	25Oct04 - 05Nov04	
Test Type(s):	FCC §15.247	IC RSS-210 Issue 5
Lab Registration(s):	FCC #714830	IC Lab File #3874

FCC PART 15.247 EMC TEST REPORT
FOR THE
ITRONIX RUGGED LAPTOP PC MODEL: IX260PLUSNL305
INCLUDING THE
SENAO NL-3054MP 802.11B/G 2.4 GHz DSSS WLAN MINI-PCI CARD
WITH THE
RANGESTAR INTERNAL SURFACE-MOUNT ANTENNA

TRSN 100504KBC-T562-E15W
Issue 2.0

Celltech Compliance Testing & Engineering Lab
(Celltech Labs Inc.)
1955 Moss Court
Kelowna, BC
Canada
V1Y 9L3

November 11, 2004

Test Report S/N:	100504KBC-T562-E15W	
Test Date(s):	25Oct04 - 05Nov04	
Test Type(s):	FCC §15.247	IC RSS-210 Issue 5
Lab Registration(s):	FCC #714830	IC Lab File #3874

DECLARATION OF COMPLIANCE

Test Lab		CELLTECH LABS INC. Testing and Engineering Services 1955 Moss Court Kelowna, B.C. Canada V1Y 9L3		Applicant		ITRONIX CORPORATION 801 South Stevens Street Spokane, WA 99204 United States		
Phone:	250-448-7047							
Fax:	250-448-7048							
e-mail:	info@celltechlabs.com							
web site:	www.celltechlabs.com							
Lab Registration No.(s):	FCC:	714830	IC:	IC 3874				
Rule Part(s):	FCC:	§15.247; §2.1091; §1.1310						
Device Classification:	FCC:	Digital Transmission System (DTS)						
Device Identification:	FCC ID:	KBCIX260PLUSNL305						
DUT Description:								
Model:	x260PLUSNL305							
Device Description:	Rugged Laptop PC with Senao NL3054MP 802.11b/g 2.4 GHz DSSS WLAN Mini-PCI Card							
TX Frequency Range:	412 - 2462 MHz							
Max. RF Output Power:	0.056 Watts - 17.46 dBm - Peak Conducted - 802.11b 0.100 Watts - 20.00 dBm - Peak Conducted - 802.11g							
Modulation(s):	802.11b/g: DSSS, DQPSK, CCK							
Antenna Type(s):	RangeStar P/N: 100929 Dual Internal Surface-Mount Primary Transmit & Receive - upper right side edge of LCD Display Auxiliary Receive only - upper left side edge of LCD Display							
Power Supply:	Stationary: 90 Watt AC Power Adapter / 11.1V Lithium-ion Battery, 6.0Ah (Model: A2121-2)							

This wireless mobile device has demonstrated compliance with the applicable technical standards as indicated in the measurement report and was tested in accordance with the measurement procedures specified in FCC 47 CFR §15.247.

I attest to the accuracy of the data. All measurements reported herein were performed by me or were under my supervision and are correct to the best of my knowledge and belief. I assume full responsibility for the completeness of these measurements and vouch for the qualifications of all persons taking them.

This test report shall not be reproduced partially, or in full, without the prior written approval of Celltech Labs Inc. The results and statements contained in this report pertain only to the device(s) evaluated.



Russell Pipe
Senior Compliance Technologist
Celltech Labs Inc.



Duane M. Friesen
EMC Manager
Celltech Labs Inc.



Applicant:	Itronix Corporation	Model:	IX260PLUSNL305	FCC ID:	KBCIX260PLUSNL305
Rugged Laptop PC with internal Senao NL-3054MP WLAN (802.11b/g) and internal surface-mount antenna					
2004 Celltech Labs Inc. This document is not to be reproduced in whole or in part without the written permission of Celltech Labs Inc.					2 of 49

Test Report S/N:	100504KBC-T562-E15W	
Test Date(s):	25Oct04 - 05Nov04	
Test Type(s):	FCC §15.247	IC RSS-210 Issue 5
Lab Registration(s):	FCC #714830	IC Lab File #3874

TABLE OF CONTENTS

1.0 SCOPE	6
2.0 REFERENCES	6
2.1 Normative References	6
3.0 TERMS AND DEFINITIONS	7
4.0 FACILITIES AND ACCREDITATIONS	8
5.0 GENERAL INFORMATION	8
5.1 Applicant Information	8
5.2 DUT Description.....	8
5.3 Co-Located Equipment	9
5.4 Cable Descriptions.....	9
5.5 Support Equipment	9
5.6 Clock Frequencies	10
5.7 Mode(s) of Operation Tested	10
5.8 Configuration Description	11
6.0 PASS/FAIL CRITERIA.....	11
APPENDIX.....	12
Appendix A - DUT Photographs	13
Appendix B - 6 dB Bandwidth Measurement.....	14
Appendix C - Peak Conducted Power Measurement.....	15
Appendix D - Maximum Permissible Exposure Calculation.....	18
Appendix E - Radiated Spurious Emissions Measurement.....	21
Appendix F - Restricted Band Emissions Measurement	30
Appendix G - Peak Power Spectral Density Measurement.....	42
Appendix H - Conducted Powerline Emissions Measurement	43
END OF DOCUMENT.....	49

FIGURES

Figure C-1 – Setup Drawing	16
Figure E-1 – Setup Drawing.....	22
Figure F-1 – Setup Drawing.....	32
Figure H-1 – Setup Drawing	45

Test Report S/N:	100504KBC-T562-E15W	
Test Date(s):	25Oct04 - 05Nov04	
Test Type(s):	FCC §15.247	IC RSS-210 Issue 5
Lab Registration(s):	FCC #714830	IC Lab File #3874

PHOTOGRAPHS

Photograph A-1 - Front of Open IX260+ Laptop PC.....	13
Photograph A-2 - Back of Open IX260+ Laptop PC.....	13
Photograph A-3 - Left Side of Open IX260+ Laptop PC.....	13
Photograph A-4 - Right Side of Open IX260+ Laptop PC.....	13
Photograph E-1 - Vertical Polarization (1-18 GHz).....	23
Photograph E-2 - Vertical Polarization (18-26 GHz).....	23
Photograph E-3 - Front of Radiated Emission Configuration.....	23
Photograph E-4 - Back of Radiated Emission Configuration.....	23
Photograph F-1 - Horizontal Polarization (30MHz - 1 GHz).....	33
Photograph F-2 - Vertical Polarization (1-18 GHz).....	33
Photograph F-3 - Front of Radiated Emission Configuration.....	33
Photograph F-4 - Back of Radiated Emission Configuration.....	33
Photograph H-1 – AC Powerline Conducted Emission Configuration.....	44
Photograph H-2 – AC Powerline Conducted Emission Cable Placement.....	44

Applicant:	Itronix Corporation	Model:	IX260PLUSNL305	FCC ID:	KBCIX260PLUSNL305
Rugged Laptop PC with internal Senao NL-3054MP WLAN (802.11b/g) and internal surface-mount antenna					
2004 Celltech Labs Inc. This document is not to be reproduced in whole or in part without the written permission of Celltech Labs Inc.					4 of 49

Test Report S/N:	100504KBC-T562-E15W	
Test Date(s):	25Oct04 - 05Nov04	
Test Type(s):	FCC §15.247	IC RSS-210 Issue 5
Lab Registration(s):	FCC #714830	IC Lab File #3874



TEST SUMMARY						
Appendix	Test Description	Procedure Reference	Limit Reference	Test Start Date	Test End Date	Result
Referenced Standard: FCC CFR Title 47 Part 15						
B	6 dB Bandwidth	FCC 97-114	§15.247(2)	na	na	Pass*
C	Peak Conducted Power	FCC 97-114	§15.247 (b) (3)	27Oct04	27Oct04	Pass
D	Maximum Permissible Exposure	FCC CFR 47 § 2.1091 IEEE Std C95.1-1992	§1.1310 Table 1 (b)	3Nov04	3Nov04	Pass
E	Radiated Spurious Emissions	FCC 97-114	§15.247(c)	25Oct04	4Nov04	Pass
F	Restricted Band Emissions	FCC 97-114	§15.205 (a), (b) §15.209 (a)	25Oct04	4Nov04	Pass
G	Peak Power Spectral Density	FCC 97-114	§15.247(d)	na	na	Pass*
H	Powerline Conducted Emissions	ANSI C63.4	§15.207	5Nov04	5Nov04	Pass
Referenced Standard: IC RSS-210 Issue 5						
B	6 dB Bandwidth	RSS-210 § 10	RSS-210 A1 §(l)(iv)	na	na	Pass*
C	Peak Conducted Power	RSS-210 § 10	RSS-210 A1 §(l)(iv) RSS-210 §6.2.2 (o)(b)	27Oct04	27Oct04	Pass
D	Maximum Permissible Exposure	RSS-102	RSS-210 §14 Safety Code 6 2.2.1(a) Table 5	3Nov04	3Nov04	Pass
E	Radiated Spurious Emissions	RSS-212, ANSI C63.4	RSS-210 §6.2.2 (o)(e1)	25Oct04	4Nov04	Pass
F	Restricted Band Emissions	RSS-212, ANSI C63.4	RSS-210 §6.3	25Oct04	4Nov04	Pass
G	Peak Power Spectral Density	RSS-210 § 10	RSS-210 §6.2.2 (o)(b)	na	na	Pass*
H	Powerline Conducted Emissions	RSS-212, ANSI C63.4	RSS-210 §6.6	5Nov04	5Nov04	Pass

* Pass based on results outlined in reference module report.

REVISION LOG

Issue	Description	Implemented By	Implementation Date
1.0	Initial Release	Jon Hughes	5Nov04
2.0	Move restricted band data pg 26, 27, 28 to section F	D. Friesen	11Nov04

SIGNATORIES

Prepared By		Nov. 11, 2004
Name/Title	Duane M. Friesen, C.E.T. / EMC Manager	Date
Reviewed By		Nov. 11, 2004
Name/Title	Jon Hughes / General Manager	Date

Applicant:	Itronix Corporation	Model:	IX260PLUSNL305	FCC ID:	KBCIX260PLUSNL305
Rugged Laptop PC with internal Senao NL-3054MP WLAN (802.11b/g) and internal surface-mount antenna					
2004 Celltech Labs Inc. This document is not to be reproduced in whole or in part without the written permission of Celltech Labs Inc.					5 of 49

Test Report S/N:	100504KBC-T562-E15W	
Test Date(s):	25Oct04 - 05Nov04	
Test Type(s):	FCC §15.247	IC RSS-210 Issue 5
Lab Registration(s):	FCC #714830	IC Lab File #3874

1.0 SCOPE

This report outlines the measurements made and results collected during the electromagnetic emissions testing of the Itronix Corporation Rugged Laptop PC with internal Senao NL-3054MP 802.11b/g 2.4 GHz DSSS WLAN Mini-PCI Card and internal Rangestar surface-mount antenna. The results were applied against the EMC requirements and limits outlined in the technical rules and regulations set forth in the Federal Communication Commission Code of Federal Regulations Title 47 Part 15 subpart C.

2.0 REFERENCES

2.1 Normative References

ANSI/ISO 17025:1999	General Requirements for competence of testing and calibration laboratories
IEEE/ANSI C63.4-2003	Methods of Measurement of Radio-Noise Emissions from Low-Voltage Electrical and Electronic Equipment in the Range of 9 kHz to 40 GHz
IEEE/ANSI Std C95.1-1992	American National Standard Safety Levels with Respect to Human Exposure to Radio Frequency Electromagnetic Fields
CFR Title 47 Part 2:2003	Code of Federal Regulations Title 47: Telecommunication Part 2: Frequency Allocations and Radio Treaty Matters; General Rules and Regulations
CFR Title 47 Part 15:2003	Code of Federal Regulations Title 47: Telecommunication Part 15: Radio Frequency Devices
IC Spectrum Management & Telecommunications Policy	Radio Standards Specification RSS-212 Issue 1 (Provisional) - Test Facilities & Test Methods for Radio Equipment RSS-210 Issue 5 - Low Power Licence-Exempt Radiocommunication Devices: Amendment November 30, 2002 RSS-102 Issue 1 (Provisional) - Evaluation Procedure for Mobile and Portable Radio Transmitters with respect to Health Canada's Safety Code 6 for Exposure of Humans to Radio Frequency Fields
ADT Corp Test Report	FCC Part 15.247 Test Report Reference No: RF921215R02 Date: December 25, 2003

Applicant:	Itronix Corporation	Model:	IX260PLUSNL305	FCC ID:	KBCIX260PLUSNL305
Rugged Laptop PC with internal Senao NL-3054MP WLAN (802.11b/g) and internal surface-mount antenna					
2004 Celltech Labs Inc. This document is not to be reproduced in whole or in part without the written permission of Celltech Labs Inc.					6 of 49

Test Report S/N:	100504KBC-T562-E15W	
Test Date(s):	25Oct04 - 05Nov04	
Test Type(s):	FCC §15.247	IC RSS-210 Issue 5
Lab Registration(s):	FCC #714830	IC Lab File #3874

3.0 TERMS AND DEFINITIONS

AVG	Average
CFR	Code of Federal Regulations
dB	decibel
dBm	dB referenced to 1 mW
dBuV	dB referenced to 1 uV
DUT	Device under Test
dBc	dB down from carrier
EBW	Emission Bandwidth
EMC	Electromagnetic Compatibility
FCC	Federal Communication Commission
HP	Hewlett Packard
HPF	High Pass Filter
Hpol	Horizontal Polarization
IC	Industry Canada
kHz	kilohertz
LNA	Low Noise Amplifier
m	meter
MHz	Megahertz
Mbps	megabits per second
na	not applicable
n/a	not available
PK	Peak
PPSD	Peak Power Spectral Density
QP	Quasi-peak
RBW	Resolution Bandwidth
R&S	Rohde & Schwarz
RSS	Radio Standard Specification
SA	Spectrum Analyzer
VBW	Video Bandwidth
Vpol	Vertical Polarization
WLAN	Wireless Local Area Network

Applicant:	Itronix Corporation	Model:	IX260PLUSNL305	FCC ID:	KBCIX260PLUSNL305
Rugged Laptop PC with internal Senao NL-3054MP WLAN (802.11b/g) and internal surface-mount antenna					
2004 Celltech Labs Inc. This document is not to be reproduced in whole or in part without the written permission of Celltech Labs Inc.					7 of 49

Test Report S/N:	100504KBC-T562-E15W	
Test Date(s):	25Oct04 - 05Nov04	
Test Type(s):	FCC §15.247	IC RSS-210 Issue 5
Lab Registration(s):	FCC #714830	IC Lab File #3874

4.0 FACILITIES AND ACCREDITATIONS

The facilities used in collecting the test results outlined in this report are located at 1955 Moss Court, Kelowna, British Columbia, Canada, V1Y 9L3. The radiated and conducted emissions sites conform with the requirements set forth in ANSI C63.4 and are filed and are listed with the FCC under Registration Number 714830 and Industry Canada under File Number IC 3874.

5.0 GENERAL INFORMATION

5.1 Applicant Information

Company Name:	Itronix Corporation
Address:	801 South Stevens Street Spokane, WA 99204 United States

5.2 DUT Description

The DUT consisted of the IX260+ Rugged Laptop PC with Senao NL3054MP 802.11b/g 2.4 GHz DSSS WLAN Mini-PCI Card installed in the Mini-PCI slot, and Internal Surface-Mount Antenna installed in the LCD display. Photographs of the DUT placement and construction are shown in Appendix A.

Device:	Rugged Laptop PC		
Model:	IX260PLUSNL305		
Serial Number:	ZZGEG4196ZZ6479		
Identifier:	FCC ID:	KBCIX260PLUSNL305	
Power Source:	Delta Electronics Model ADP-90AB Rev B 90 Watt AC-DC power supply		

Device:	2.4GHz DSSS WLAN Mini-PCI Card (802.11b/g)		
Model:	Senao NL3054MP PLUS ARIES (F) 1.00		
Serial Number:	048253621		
Identifier:	FCC ID:	NI3-AT30V216	
Rule Part(s):	FCC:	§15.247; §2.1091; §1.1310	
Classification:	FCC:	Digital Transmission System (DTS)	
Power Source:	Powered from the internal PC power supply		

Device:	Primary Internal Surface-Mount Antenna (Transmit and Receive)		
Model:	RangeStar P/N: 100929		
Gain:	4.5 dBi		

Applicant:	Itronix Corporation	Model:	IX260PLUSNL305	FCC ID:	KBCIX260PLUSNL305
Rugged Laptop PC with internal Senao NL-3054MP WLAN (802.11b/g) and internal surface-mount antenna					
2004 Celltech Labs Inc. This document is not to be reproduced in whole or in part without the written permission of Celltech Labs Inc.					8 of 49

Test Report S/N:	100504KBC-T562-E15W	
Test Date(s):	25Oct04 - 05Nov04	
Test Type(s):	FCC §15.247	IC RSS-210 Issue 5
Lab Registration(s):	FCC #714830	IC Lab File #3874

Device:	Auxiliary Internal Surface-Mount Antenna (diversity antenna for Receive only)
Model:	RangeStar P/N: 100929
Gain:	4.5 dBi

5.3 Co-Located Equipment

Device:	GPS Receiver Module
Model:	Leadtek P/N GPS9547

5.4 Cable Descriptions

ROUTING		Length m	Model	Terminations		Shield Type	Shield Termination		Suppression
From	To			End 1	End 2		End 1	End 2	
PC modem port	Unterminated	1.0	n/a	RJ-11	RJ-11	None	na	na	None

5.5 Support Equipment

The following equipment was used in support of the DUT.

SUPPORT EQUIPMENT LIST		
MANUFACTURER	MODEL	DESCRIPTION
D-Link	DE-809TC/	Ethernet hub
YNG YUH	YP-040	Hub power supply
MLi	699	Speakers
Polk Audio	n/a	Speaker-microphone
DeLorme	Tripmate	GPS Receiver
Intel	CS-430	Camera
Logitech	M-S34	Mouse

Applicant:	Itronix Corporation	Model:	IX260PLUSNL305	FCC ID:	KBCIX260PLUSNL305
Rugged Laptop PC with internal Senao NL-3054MP WLAN (802.11b/g) and internal surface-mount antenna					
2004 Celltech Labs Inc. This document is not to be reproduced in whole or in part without the written permission of Celltech Labs Inc.					9 of 49

Test Report S/N:	100504KBC-T562-E15W	
Test Date(s):	25Oct04 - 05Nov04	
Test Type(s):	FCC §15.247	IC RSS-210 Issue 5
Lab Registration(s):	FCC #714830	IC Lab File #3874

5.6 Clock Frequencies

5.6.1 DUT Clock Frequencies

Device:	Rugged Laptop PC
Clocks:	1.6 GHz processor
Name:	2.4GHz DSSS WLAN Mini-PCI Card
Clocks:	n/a
Name:	Internal Surface-Mount Antenna (WLAN)
Clocks:	None

5.6.2 Co-Located Clock Frequencies

Device:	Peripherals
Clocks:	n/a

5.7 Mode(s) of Operation Tested

Customer supplied software was used to place the WLAN card in the appropriate mode, channel, and power level for the specific measurement.

TX Frequency Range:	2412 – 2462 MHz Ch. 1 (2412 MHz), Ch. 6 (2437 MHz) & Ch. 11 (2462 MHz) measured unless otherwise noted	
Software Power Gain Settings:	802.11b set to 0,1 for Channel 1; 0,5 for Channel 6; 0,7 for Channel 11 802.11g set to 0,8 for Channel 1; 0,10 for Channel 6; 0,12 for Channel 11 (x,y setting x = rfgain_l y = PN9 gain)	
RF Peak Conducted Output Power Tested:	802.11b 2412 MHz(1 Mbps) = 16.99 dBm 802.11b 2437 MHz(1 Mbps) = 17.46 dBm 802.11b 2462 MHz(1 Mbps) = 17.35 dBm	802.11g 2412 MHz(6 Mbps) = 20.00 dBm 802.11g 2437 MHz(6 Mbps) = 19.52 dBm 802.11g 2462 MHz(6 Mbps) = 19.49 dBm
Modes / Data Rates Tested*:	802.11b (1, 5.5, 11 Mbps checked in prescan) (1 Mbps determined to be worse case and used unless otherwise noted)	
	802.11g (6, 36, 54 Mbps checked in prescan) (6 Mbps determined to be worse case and used unless otherwise noted)	
Modulation Type(s):	OFDM with BPSK, QPSK, 16QAM, 64QAM, DBPSK, DQPSK, CCK	
Battery Type(s):	11.1V Lithium-ion, 6.0Ah (Model: A2121-2)	

* Turbo mode available at module level but not enabled when installed in DUT

Applicant:	Itronix Corporation	Model:	IX260PLUSNL305	FCC ID:	KBCIX260PLUSNL305
Rugged Laptop PC with internal Senao NL-3054MP WLAN (802.11b/g) and internal surface-mount antenna					
2004 Celltech Labs Inc. This document is not to be reproduced in whole or in part without the written permission of Celltech Labs Inc.					10 of 49

Test Report S/N:	100504KBC-T562-E15W	
Test Date(s):	25Oct04 - 05Nov04	
Test Type(s):	FCC §15.247	IC RSS-210 Issue 5
Lab Registration(s):	FCC #714830	IC Lab File #3874

5.7.1 DUT Exercising Software Description

The DUT was configured and exercised using customer supplied test software that allowed an operator to set the parameters of the WLAN operation. The settings used are described in each appendix. Unless otherwise noted the power gain settings were set as described in section 5.6 with the worse case data rate as described in the same section.

5.8 Configuration Description

The DUT was configured, as described by the client as being representative of what would be delivered to a final customer. This configuration included the WLAN and internal antenna as described in section 5.2 installed in a typical manner. More specific details may be included in each appendix.

5.8.1 Configuration Justification

The DUT was tested in a configuration described by the client as being worse case but typical of normal use.

Prescan measurements were made with the WLAN in each of the two available modes (b & g), lowest and highest bit rates and each of the lowest, highest and mid-band frequencies. From this preliminary data, it was determined that Mode b Rate 1 Mbps resulted in the highest spurious emissions. When a measurement of Mode g was required, its data rate was set for a worse case setting of 6 Mbps. Unless otherwise specified in the applicable appendices, these settings were used for the measurements described in this report.

6.0 PASS/FAIL CRITERIA

Unless otherwise noted in the Appendices, the pass/fail criteria is the limit set forth in the reference standards. A DUT is considered to have passed the requirements, if the data collected during the described measurement procedure is less than or equal to the specified limits as defined. The pass/fail statements made in this report only apply to the unit tested.

Applicant:	Itronix Corporation	Model:	IX260PLUSNL305	FCC ID:	KBCIX260PLUSNL305
Rugged Laptop PC with internal Senao NL-3054MP WLAN (802.11b/g) and internal surface-mount antenna					
2004 Celltech Labs Inc. This document is not to be reproduced in whole or in part without the written permission of Celltech Labs Inc.					11 of 49

Test Report S/N:	100504KBC-T562-E15W	
Test Date(s):	25Oct04 - 05Nov04	
Test Type(s):	FCC §15.247	IC RSS-210 Issue 5
Lab Registration(s):	FCC #714830	IC Lab File #3874

APPENDIX

Applicant:	Itronix Corporation	Model:	IX260PLUSNL305	FCC ID:	KBCIX260PLUSNL305
Rugged Laptop PC with internal Senao NL-3054MP WLAN (802.11b/g) and internal surface-mount antenna					
2004 Celltech Labs Inc. This document is not to be reproduced in whole or in part without the written permission of Celltech Labs Inc.					12 of 49

Test Report S/N:	100504KBC-T562-E15W	
Test Date(s):	25Oct04 - 05Nov04	
Test Type(s):	FCC §15.247	IC RSS-210 Issue 5
Lab Registration(s):	FCC #714830	IC Lab File #3874

Appendix A - DUT Photographs

Photograph A-1 - Front of Open IX260+ Laptop PC



Photograph A-2 - Back of Open IX260+ Laptop PC



Photograph A-3 - Left Side of Open IX260+ Laptop PC



Photograph A-4 - Right Side of Open IX260+ Laptop PC



Applicant:	Itronix Corporation	Model:	IX260PLUSNL305	FCC ID:	KBCIX260PLUSNL305
Rugged Laptop PC with internal Senao NL-3054MP WLAN (802.11b/g) and internal surface-mount antenna					
2004 Celltech Labs Inc. This document is not to be reproduced in whole or in part without the written permission of Celltech Labs Inc.					13 of 49

Test Report S/N:	100504KBC-T562-E15W	
Test Date(s):	25Oct04 - 05Nov04	
Test Type(s):	FCC §15.247	IC RSS-210 Issue 5
Lab Registration(s):	FCC #714830	IC Lab File #3874

Appendix B - 6 dB Bandwidth Measurement

B.1. REFERENCES

Normative Reference Standard	FCC CFR 47 §15.247 (2)
Procedure Reference	FCC 97-114

B.2. LIMITS

B.2.1. FCC CFR 47

FCC CFR 47 §15.247 (2) *Systems using digital modulation techniques may operate in the 902-928 MHz, 2400-2483.5 MHz, and 5725-5850 MHz bands. The minimum 6 dB bandwidth shall be at least 500 kHz*

B.3. TEST PROCEDURE

The test method used is outlined in the ADT Corp reference test report no. RF921215R02, section 4.3

B.4. TEST RESULTS

The results used to show compliance to the applicable parts are outlined in the ADT Corp. reference test report no. RF921215R02, section 4.3.

As shown in section 4.3.7, the following are the outlined results for Mode b:

Channel	Channel Frequency (MHz)	6 dB Bandwidth (MHz)	Minimum Limit (MHz)	Pass/Fail
1	2412	11.48	0.5	PASS
6	2437	11.48	0.5	PASS
11	2462	11.08	0.5	PASS

As shown in section 4.3.7, the following are the outlined results for Mode g:

Channel	Channel Frequency (MHz)	6 dB Bandwidth (MHz)	Minimum Limit (MHz)	Pass/Fail
1	2412	16.52	0.5	PASS
6	2437	16.56	0.5	PASS
11	2462	16.40	0.5	PASS

B.5. PASS/FAIL

In reference to the results outlined in B.4 and stated in the ADT Corp reference report, the DUT passes the requirements as stated in the reference standards as follows:

FCC 15.247 (2): The 6 dB bandwidth as measured meets the minimum 500 kHz bandwidth requirement.

Applicant:	Itronix Corporation	Model:	IX260PLUSNL305	FCC ID:	KBCIX260PLUSNL305
Rugged Laptop PC with internal Senao NL-3054MP WLAN (802.11b/g) and internal surface-mount antenna					
2004 Celltech Labs Inc. This document is not to be reproduced in whole or in part without the written permission of Celltech Labs Inc.					14 of 49

Test Report S/N:	100504KBC-T562-E15W	
Test Date(s):	25Oct04 - 05Nov04	
Test Type(s):	FCC §15.247	IC RSS-210 Issue 5
Lab Registration(s):	FCC #714830	IC Lab File #3874

Appendix C - Peak Conducted Power Measurement

C.1. REFERENCES	
Normative Reference Standard	FCC CFR 47 §15.247(b) (3)
Procedure Reference	FCC 97-114

C.2. LIMITS	
C.2.1. FCC CFR	
<p>§15.247(b): The maximum peak output power of the intentional radiator shall not exceed the following: §15.247(b) (3) For system using digital modulation in the 902 – 928 MHz, 2400 – 2483.5 MHz, and 5725 – 5850 MHz bands: 1 Watt.</p>	

C.3. ENVIRONMENTAL CONDITIONS	
Temperature	25.2 +/- 2 °C
Humidity	35 +/- 2 %
Barometric Pressure	96.34 kPa

C.4. EQUIPMENT LIST					
ASSET NUMBER	MANUFACTURER	MODEL	DESCRIPTION	LAST CAL	CAL DUE
00015	Agilent	E4408B	Spectrum Analyzer	29Dec03	29Dec04
00075	Alpha Wire-J	9223	2ft. RG223/U RF Cable	08Jul04*	24Jun05
00076	Pasternack	PE7014-30	30dB 2 Watt Attenuator	08Jul04*	24Jun05

*Cable and attenuator verified with power meter prior to use

C.5. MEASUREMENT EQUIPMENT SETUP	
Measurement Equipment Connections	The equipment was connected as shown in the setup drawing in C.6.
Measurement Equipment Settings	<p>To evaluate the maximum peak power, the 26 dB bandwidth needs to be determined. This is performed with the spectrum analyzer using the following setting:</p> <p>RBW – 300 kHz VBW – 1MHz Span – 50 MHz Detector – Peak Average – Power Trace Average – 100</p> <p>Once the 26 dB bandwidth is determined, the channel power is measured within the band with the following spectrum analyzer settings:</p> <p>RBW – 1 MHz VBW – 3 MHz Detector – Peak Average – Power Integrate BW – equal to specific -26 dB EBW</p>

Applicant:	Itronix Corporation	Model:	IX260PLUSNL305	FCC ID:	KBCIX260PLUSNL305
Rugged Laptop PC with internal Senao NL-3054MP WLAN (802.11b/g) and internal surface-mount antenna					
2004 Celltech Labs Inc. This document is not to be reproduced in whole or in part without the written permission of Celltech Labs Inc.					15 of 49

C.6. SETUP DRAWING

Figure C-1 – Setup Drawing

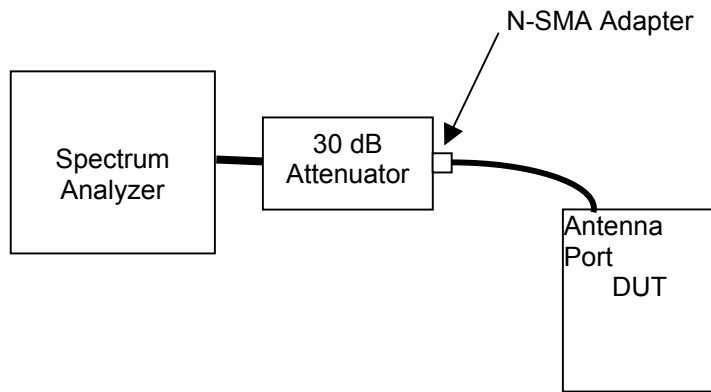

C.7. DUT OPERATING DESCRIPTION

The worst-case data rate was determined from prescan investigations. Measurements were made at three channels throughout the band, Low Channel (2412 MHz), Mid Channel (2437 MHz), High Channel (2462 MHz) and for both Modes b and g.

C.8. TEST RESULTS

Channel	Frequency	802.11b				802.11g			
		Peak Conducted Power		Limit	-26 dB EBW	Peak Conducted Power		Limit	-26 dB EBW
	MHz	dBm	Watts	Watts	MHz	dBm	Watts	Watts	MHz
Low	2412	16.99	0.050	1	19.2	20.00	0.100	1	29.59
Mid	2437	17.46	0.056	1	19.2	19.52	0.090	1	29.70
High	2462	17.35	0.054	1	19.2	19.49	0.089	1	30.56

Test Report S/N:	100504KBC-T562-E15W	
Test Date(s):	25Oct04 - 05Nov04	
Test Type(s):	FCC §15.247	IC RSS-210 Issue 5
Lab Registration(s):	FCC #714830	IC Lab File #3874

C.9. PASS/FAIL

In reference to the results outlined in C.8 the DUT passes the requirements as stated in the reference standards as follows:
 FCC 15.247 (b) (3): The peak power did not exceed 1 Watt.

C.10. SIGN-OFF

I attest to the accuracy of the data. All measurements reported herein were performed by me and are correct to the best of my knowledge and belief. I assume full responsibility for the completeness of these measurements.



 Russell Pipe
 Senior Compliance Technologist
 Celltech Labs Inc.

 3Nov04

Date

Applicant:	Itronix Corporation	Model:	IX260PLUSNL305	FCC ID:	KBCIX260PLUSNL305
Rugged Laptop PC with internal Senao NL-3054MP WLAN (802.11b/g) and internal surface-mount antenna					
2004 Celltech Labs Inc. This document is not to be reproduced in whole or in part without the written permission of Celltech Labs Inc.					17 of 49

Test Report S/N:	100504KBC-T562-E15W	
Test Date(s):	25Oct04 - 05Nov04	
Test Type(s):	FCC §15.247	IC RSS-210 Issue 5
Lab Registration(s):	FCC #714830	IC Lab File #3874

Appendix D - Maximum Permissible Exposure Calculation

D.1. REFERENCES	
Normative Reference Standard	FCC CFR 47§1.1310 IEEE Std C95.1-1992
Procedure Reference	FCC CFR 47§2.1091

D.2. LIMITS	
FCC CFR 47§1.1310 Table 1(b)	1.0 mW/cm ²

D.3. ENVIRONMENTAL CONDITIONS	
Temperature	na
Humidity	na
Barometric Pressure	na

D.4. EQUIPMENT LIST					
ASSET NUMBER	MANUFACTURER	MODEL	DESCRIPTION	LAST CAL	CAL DUE
na					

D.5. MEASUREMENT EQUIPMENT SETUP	
MEASUREMENT EQUIPMENT CONNECTIONS	The results described herein were determined by the following calculation, so no measurement equipment was used.
MEASUREMENT EQUIPMENT SETTINGS	na

D.6. SETUP PHOTOS	
na	

D.7. SETUP DRAWINGS	
na	

D.8. DUT OPERATING DESCRIPTION	
na	

Applicant:	Itronix Corporation	Model:	IX260PLUSNL305	FCC ID:	KBCIX260PLUSNL305
Rugged Laptop PC with internal Senao NL-3054MP WLAN (802.11b/g) and internal surface-mount antenna					
2004 Celltech Labs Inc. This document is not to be reproduced in whole or in part without the written permission of Celltech Labs Inc.					18 of 49

Test Report S/N:	100504KBC-T562-E15W	
Test Date(s):	25Oct04 - 05Nov04	
Test Type(s):	FCC §15.247	IC RSS-210 Issue 5
Lab Registration(s):	FCC #714830	IC Lab File #3874

D.9. TEST RESULTS

Calculation:

Rangestar Internal Antenna (802.11b mode):

Tx Frequency: 2437 (MHz)
 RF Output Power at Antenna Input Terminal: 17.46 (dBm)
 Antenna gain: 4.50 (dBi)

S = $\frac{1.00}{4\pi R^2}$ (mW/cm²)
 P = 55.7186 (mW)
 G = 2.82 (numeric)

R = 3.54 (cm)

S at 20cm: 0.031207528 (mW/cm²)

Rangestar Internal Antenna (802.11g mode):

Tx Frequency: 2412 (MHz)
 RF Output Power at Antenna Input Terminal: 20.00 (dBm)
 Antenna gain: 4.50 (dBi)

S = $\frac{1.00}{4\pi R^2}$ (mW/cm²)
 P = 100.0000 (mW)
 G = 2.82 (numeric)

R = 4.74 (cm)

S at 20cm: 0.0560092 (mW/cm²)

Formulae:

$S = \frac{PG}{4\pi R^2}$ where: S = Power Density Limit
 $R = \sqrt{\frac{P}{4\pi S}}$ P = Power Applied to the Antenna
 G = Numeric Antenna Gain
 R = Distance from Antenna

Results:

Mode	Power Density Limit	RF Conducted Output Power	Antenna Gain	MPE Distance	Power Density at 20 cm
	mW/cm ²	dBm	dBi	cm	mW/cm ²
802.11b	1.0	17.46	4.5	3.54	0.031
802.11g	1.0	20.00	4.5	4.74	0.056

Applicant:	Itronix Corporation	Model:	IX260PLUSNL305	FCC ID:	KBCIX260PLUSNL305
Rugged Laptop PC with internal Senao NL-3054MP WLAN (802.11b/g) and internal surface-mount antenna					
2004 Celltech Labs Inc. This document is not to be reproduced in whole or in part without the written permission of Celltech Labs Inc.					19 of 49

Test Report S/N:	100504KBC-T562-E15W	
Test Date(s):	25Oct04 - 05Nov04	
Test Type(s):	FCC §15.247	IC RSS-210 Issue 5
Lab Registration(s):	FCC #714830	IC Lab File #3874

D.10. PASS/FAIL

In reference to the results outlined in D.9 the DUT passes the requirements as stated in the reference standards as follows:
 1) The DUT must comply with the minimum spacing requirement of 20 cm to ensure an exposure of not more than 1 mW/cm².

D.11. SIGN-OFF

I attest to the accuracy of the data. All measurements reported herein were performed by me and are correct to the best of my knowledge and belief. I assume full responsibility for the completeness of these measurements.



 Duane M. Friesen, C.E.T.
 EMC Manager
 Celltech Labs Inc.

 03Nov04

Date

Applicant:	Itronix Corporation	Model:	IX260PLUSNL305	FCC ID:	KBCIX260PLUSNL305
Rugged Laptop PC with internal Senao NL-3054MP WLAN (802.11b/g) and internal surface-mount antenna					
2004 Celltech Labs Inc. This document is not to be reproduced in whole or in part without the written permission of Celltech Labs Inc.					20 of 49

Test Report S/N:	100504KBC-T562-E15W	
Test Date(s):	25Oct04 - 05Nov04	
Test Type(s):	FCC §15.247	IC RSS-210 Issue 5
Lab Registration(s):	FCC #714830	IC Lab File #3874

Appendix E - Radiated Spurious Emissions Measurement

E.1. REFERENCES	
Normative Reference Standard	FCC CFR 47 §15.247(c)
Procedure Reference	ANSI C63.4; FCC 97-114

E.2. LIMITS	
E.2.1. FCC CFR 47	
<p>§15.247 (c): <i>In any 100 kHz bandwidth outside the frequency band in which the spread spectrum or digitally modulated intentional radiator is operating, the radio frequency power that is produced by the intentional radiator shall be at least 20 dB below that in the 100 kHz bandwidth within the band that contains the highest level of desired power, based on either an RF conducted or a radiated measurement. Attenuation below the general limits specified in 15.209 (a) is not required.</i></p>	
<p>Note: Spurious emissions within the restricted bands are reported in Appendix F.</p>	

E.3. ENVIRONMENTAL CONDITIONS	
Temperature	27.4 +/- 2 °C
Humidity	33 +/- 2 %
Barometric Pressure	96.24 +/- 0.2 kPa

E.4. EQUIPMENT LIST					
ASSET NUMBER	MANUFACTURER	MODEL	DESCRIPTION	LAST CAL	CAL DUE
00072	EMCO	2075	Mini-mast	n/a	n/a
00073	EMCO	2080	Turn Table	n/a	n/a
00071	EMCO	2090	Multi-Device Controller	n/a	n/a
00050	Chase	CBL-6111A	Bilog Antenna	30Apr04	30Apr05
00035	ETS	3115	Double Ridged Guide Horn	24Mar04	24Mar05
00202	ETS	3160-09	Small Horn Antenna	27May04	27Jun05
00015	Agilent	E4408B	Spectrum Analyzer	29Dec03	29Dec04
00049	HP	8566B	Spectrum Analyzer RF Section	18May04	18May05
00049	HP	85650A	Quasi-peak Adapter	18May04	18May05
00047	HP	85685A	RF Preselector	18May04	18May05
00048	Gore	65474	Microwave Cable	20May04	20May05
00030	HP	83017A	LNA	20May04	20May05

Applicant:	Itronix Corporation	Model:	IX260PLUSNL305	FCC ID:	KBCIX260PLUSNL305
Rugged Laptop PC with internal Senao NL-3054MP WLAN (802.11b/g) and internal surface-mount antenna					
2004 Celltech Labs Inc. This document is not to be reproduced in whole or in part without the written permission of Celltech Labs Inc.					21 of 49

Test Report S/N:	100504KBC-T562-E15W	
Test Date(s):	25Oct04 - 05Nov04	
Test Type(s):	FCC §15.247	IC RSS-210 Issue 5
Lab Registration(s):	FCC #714830	IC Lab File #3874

E.5. MEASUREMENT EQUIPMENT SETUP				
MEASUREMENT EQUIPMENT CONNECTIONS	The measurement equipment was connected as shown in the E.6. A number of antennas were used to cover the applicable frequency range test. The ranges in which each antenna was used are as follows:			
	Frequency Range	Antenna		
	30 MHz – 1 GHz	CBL-6111A Bilog		
	1 GHz – 18 GHz	ETS 3115 Horn		
	18 GHz – 26 GHz	ETS 3160-09 Horn		
MEASUREMENT EQUIPMENT SETTINGS	The spectrum analyzer was set to the following settings:			
	Frequency Range	RBW	VBW	Detector
	MHz	kHz	kHz	
	30 – 1000	100	300	Peak*
	> 1000	1000*	1000	Peak*
*As a worse case measurement, the average limit was applied to measurements made with a peak detector using a RBW of 1 MHz (vs the specified 100 kHz), when possible.				

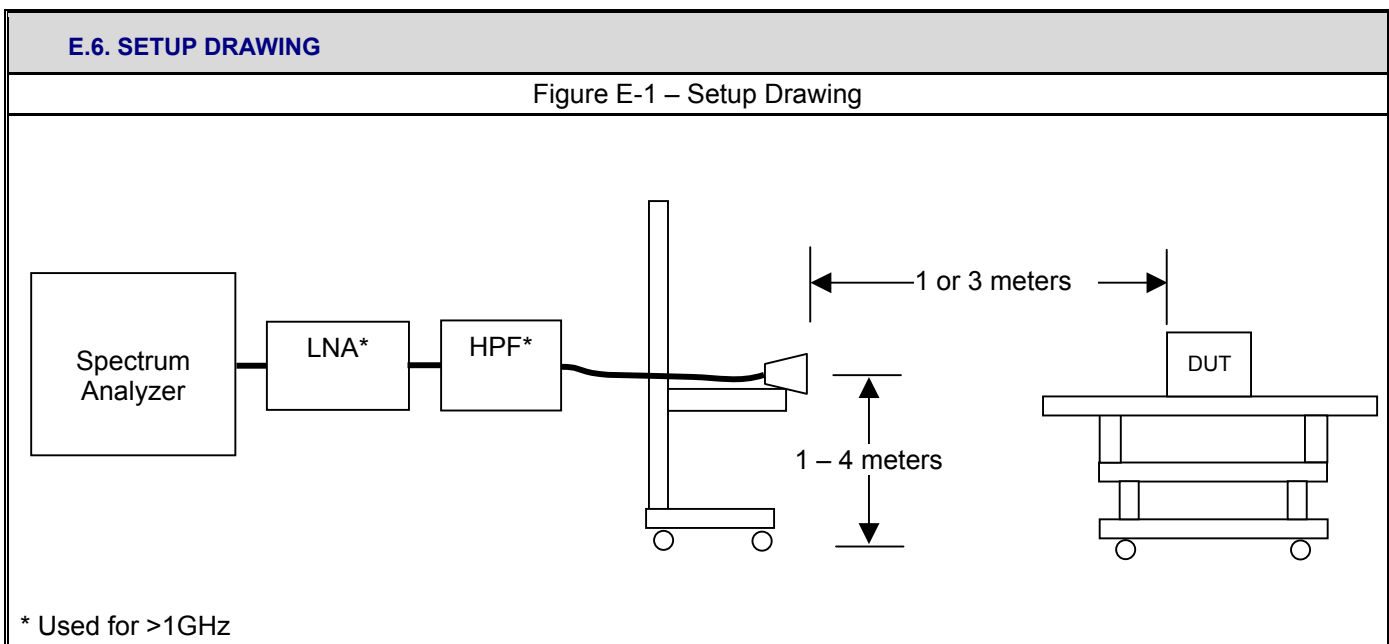

Applicant:	Itronix Corporation	Model:	IX260PLUSNL305	FCC ID:	KBCIX260PLUSNL305
Rugged Laptop PC with internal Senao NL-3054MP WLAN (802.11b/g) and internal surface-mount antenna					
2004 Celltech Labs Inc. This document is not to be reproduced in whole or in part without the written permission of Celltech Labs Inc.					22 of 49

Test Report S/N:	100504KBC-T562-E15W	
Test Date(s):	25Oct04 - 05Nov04	
Test Type(s):	FCC §15.247	IC RSS-210 Issue 5
Lab Registration(s):	FCC #714830	IC Lab File #3874

E.7. SETUP PHOTOGRAPHS

Photograph E-1 - Vertical Polarization (1-18 GHz)



Photograph E-2 - Vertical Polarization (18-26 GHz)



Photograph E-3 - Front of Radiated Emission Configuration



Photograph E-4 - Back of Radiated Emission Configuration

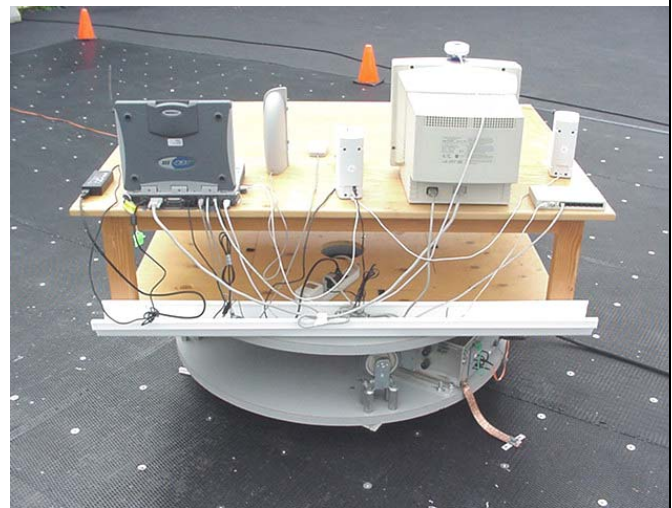

E.8. DUT OPERATING DESCRIPTION

The worst-case data rate was determined from prescan investigations. Measurements were made at three channels throughout the band, Low Channel (2412 MHz), Mid Channel (2437 MHz), High Channel (2462 MHz) and for both Modes b and g for the band-edge measurements and for Mode b for the remaining measurements. The configuration used for all other measurements was Mode b, 1 mbps with a gain setting of 0,1.

Applicant:	Itronix Corporation	Model:	IX260PLUSNL305	FCC ID:	KBCIX260PLUSNL305
Rugged Laptop PC with internal Senao NL-3054MP WLAN (802.11b/g) and internal surface-mount antenna					
2004 Celltech Labs Inc. This document is not to be reproduced in whole or in part without the written permission of Celltech Labs Inc.					23 of 49

Test Report S/N:	100504KBC-T562-E15W	
Test Date(s):	25Oct04 - 05Nov04	
Test Type(s):	FCC §15.247	IC RSS-210 Issue 5
Lab Registration(s):	FCC #714830	IC Lab File #3874

E.9. TEST RESULTS

E.9.1. Mode b - Fundamental Field Strengths @ Specified Distance

Project Number: 100504KBC-T562-E15W **Standard:** FCC15.247a
Company: Itronix **Test Start Date:** 25Oct04
Product: IX260+ with Senao NL-3054MP Plus Aries2 WLAN **Test End Date:** 03Nov04

Mode b Carrier Field Strengths																	
Channel	Polarity	Measurement Distance	Antenna	Frequency	SA Level	Noise Floor	AF	CL	Other	Total CF	Field Strength	Detector	Limit Distance	Limit Distance Correction	Calculated Limit	Margin	Pass/Fail
							dB/m	dB	dB	dB/m	dBuV/m		m	dB	dBuV/m	dB	
1	H	3	Horn SN6276	2412.00	74.44		30.26	3.49	0.00	33.75	108.19	PK	3	0.00	116.20	8.01	PASS
6	H	3	Horn SN6276	2437.00	74.58		30.30	3.51	0.00	33.81	108.39	PK	3	0.00	116.20	7.81	PASS
11	H	3	Horn SN6276	2462.00	73.48		30.34	3.52	0.00	33.86	107.34	PK	3	0.00	116.20	8.86	PASS
1	V	3	Horn SN6276	2412.00	67.66		30.26	3.49	0.00	33.75	101.41	PK	3	0.00	116.20	14.79	PASS
6	V	3	Horn SN6276	2437.00	68.53		30.30	3.51	0.00	33.81	102.34	PK	3	0.00	116.20	13.86	PASS
11	V	3	Horn SN6276	2462.00	67.05		30.34	3.52	0.00	33.86	100.91	PK	3	0.00	116.20	15.29	PASS

E.9.2. Mode g - Fundamental Field Strengths @ Specified Distance

Project Number: 100504KBC-T562-E15W **Standard:** FCC15.247a
Company: Itronix **Test Start Date:** 25Oct04
Product: IX260+ with Senao NL-3054MP Plus Aries2 WLAN **Test End Date:** 03Nov04

Mode g Carrier Field Strengths																	
Channel	Polarity	Measurement Distance	Antenna	Frequency	SA Level	Noise Floor	AF	CL	Other	Total CF	Field Strength	Detector	Limit Distance	Limit Distance Correction	Calculated Limit	Margin	Pass/Fail
							dB/m	dB	dB	dB/m	dBuV/m		m	dB	dBuV/m	dB	
1	H	3	Horn SN6276	2412.00	73.32		30.26	3.49	0.00	33.75	107.07	PK	3	0.00	116.20	9.13	PASS
6	H	3	Horn SN6276	2437.00	71.68		30.30	3.51	0.00	33.81	105.49	PK	3	0.00	116.20	10.71	PASS
11	H	3	Horn SN6276	2462.00	70.70		30.34	3.52	0.00	33.86	104.56	PK	3	0.00	116.20	11.64	PASS
1	V	3	Horn SN6276	2412.00	66.81		30.26	3.49	0.00	33.75	100.56	PK	3	0.00	116.20	15.64	PASS
6	V	3	Horn SN6276	2437.00	66.31		30.30	3.51	0.00	33.81	100.12	PK	3	0.00	116.20	16.08	PASS
11	V	3	Horn SN6276	2462.00	64.89		30.34	3.52	0.00	33.86	98.75	PK	3	0.00	116.20	17.45	PASS

Formulae:

Total CF = Antenna Factor + Cable Factor + Other Factor (Amplifier Gain, filter loss, etc)
 Field Strength = SA Reading + Total CF
 Limit Distance Correction = 40*log(d1/d2) for F<30 MHz, 20*log(d1/d2) for F> 30 MHz :
 where d1 is the measurement distance
 Limit = Specified Limit + Limit Distance Correction
 Margin = Limit - Field Strength
 Calculated Limit (-20 dBc) = Field Strength -20

*Calculated Limit used for spurious emission evaluation, levels measured with 100 kHz RBW

Applicant:	Itronix Corporation	Model:	IX260PLUSNL305	FCC ID:	KBCIX260PLUSNL305
Rugged Laptop PC with internal Senao NL-3054MP WLAN (802.11b/g) and internal surface-mount antenna					
2004 Celltech Labs Inc. This document is not to be reproduced in whole or in part without the written permission of Celltech Labs Inc.					24 of 49

Test Report S/N:	100504KBC-T562-E15W	
Test Date(s):	25Oct04 - 05Nov04	
Test Type(s):	FCC §15.247	IC RSS-210 Issue 5
Lab Registration(s):	FCC #714830	IC Lab File #3874

E.9.3. Lower Band-edge Emission Field Strengths @ Specified Distance

Note: (Upper Band-edge (Restricted Band) is in Appendix F)

Channel 1 Mode b - Conducted Band-edge Plots

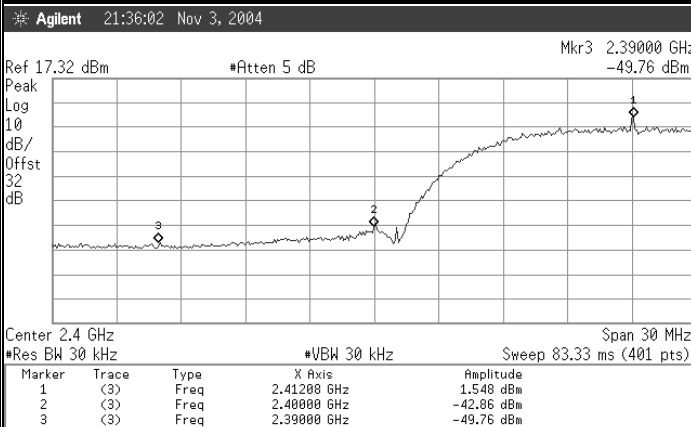

Channel 1 Mode g - Conducted Band-edge Plots

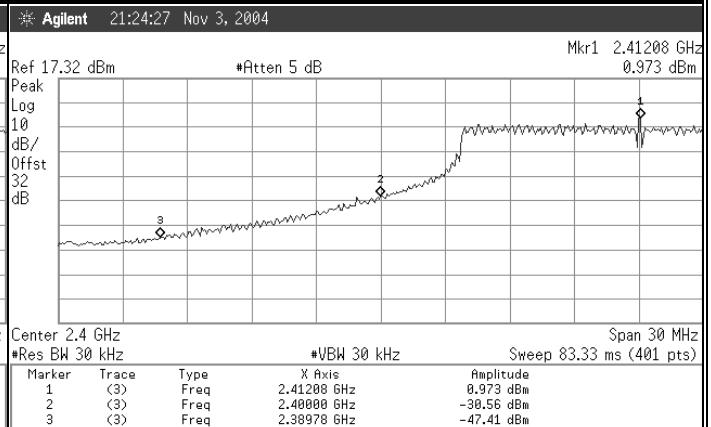

Channel 1 Mode b - Radiated Carrier Field Strengths

Mode b												
Channel	Polarity	Measurement Distance	Antenna	Frequency	SA Level	Noise Floor	AF	CL	Other	Total CF	Field Strength	Detector
		m		MHz	dBuV		dB/m	dB	dB	dBm	dBuV/m	(PK/QP/AVG)
1	H	3	Horn SN6276	2412.00	74.44		30.26	3.49	0.00	33.75	108.19	PK
1	H	3	Horn SN6276	2412.00	67.88		30.26	3.49	0.00	33.75	101.63	AV
1	V	3	Horn SN6276	2412.00	67.66		30.26	3.49	0.00	33.75	101.41	PK
1	V	3	Horn SN6276	2412.00	60.88		30.26	3.49	0.00	33.75	94.63	AV

Channel 1 Mode g - Radiated Carrier Field Strengths

Mode g												
Channel	Polarity	Measurement Distance	Antenna	Frequency	SA Level	Noise Floor	AF	CL	Other	Total CF	Field Strength	Detector
		m		MHz	dBuV		dB/m	dB	dB	dBm	dBuV/m	(PK/QP/AVG)
1	H	3	Horn SN6276	2412.00	73.32		30.26	3.49	0.00	33.75	107.07	PK
1	H	3	Horn SN6276	2412.00	71.38		30.26	3.49	0.00	33.75	105.13	AV
1	V	3	Horn SN6276	2412.00	66.81		30.26	3.49	0.00	33.75	100.56	PK
1	V	3	Horn SN6276	2412.00	64.84		30.26	3.49	0.00	33.75	98.59	AV

Channel 1 - Calculated Band-edge (Out-of-Band) Field Strengths

Mode b												
Channel	Polarity	Measurement Distance	Frequency	Carrier Radiated Field Strength	Marker-Delta	Detector	Calculated Band-edge Field Strength	Limit Distance	Limit Distance Correction	Specified Limit	Margin	Pass/Fail
		m	MHz	dBuV/m	dBuV		dBuV/m	m	dB	dBuV/m	dB	
1	H	3	2400.00	108.19	44.41	PK	63.78	3.00	0.00	88.19	24.41	Pass
1	H	3	2400.00	101.63	44.41	AV	57.22	3.00	0.00	81.63	24.41	Pass
1	V	3	2400.00	101.41	44.41	PK	57.00	3.00	0.00	88.19	31.19	Pass
1	V	3	2400.00	94.63	44.41	AV	50.22	3.00	0.00	81.63	31.41	Pass

Channel 1 g - Calculated Band-edge (Out-of-Band) Field Strengths

Mode g												
Channel	Polarity	Measurement Distance	Frequency	Carrier Radiated Field Strength	Marker-Delta	Detector	Calculated Band-edge Field Strength	Limit Distance	Limit Distance Correction	Specified Limit	Margin	Pass/Fail
		m	MHz	dBuV/m	dBuV		dBuV/m	m	dB	dBuV/m	dB	
1	H	3	2400.00	107.07	31.53	PK	75.53	3.00	0.00	87.07	11.53	Pass
1	H	3	2400.00	105.13	31.53	AV	73.59	3.00	0.00	85.13	11.53	Pass
1	V	3	2400.00	100.56	31.53	PK	69.02	3.00	0.00	87.07	18.04	Pass
1	V	3	2400.00	98.59	31.53	AV	67.05	3.00	0.00	85.13	18.07	Pass

Formulae:

Total CF (dB) = Antenna Factor (dB) + Cable Factor (dB) + Other Factor (Amplifier Gain, Filter Loss, etc) (dB)

Field Strength (dBuV/m) = SA Reading (dBuV) + Total CF (dB/m)

Limit Distance Correction (dB) = 40 * log(d1/d2) for f < 30 MHz, 20*log(d1/d2) for f > 30 MHz, where d1 is the measurement distance and d2 is the published limit

Limit (dBuV/m) = Published Limit (dBuV/m) + Limit Distance Correction (dB)

Margin (dB) = Limit (dBuV/m) - Field Strength (dBuV/m)

Note: Measurements and calculation reference the Marker-Delta Method Described in FCC Public Notice DA 00-705

Applicant:	Itronix Corporation	Model:	IX260PLUSNL305	FCC ID:	KBCIX260PLUSNL305
Rugged Laptop PC with internal Senao NL-3054MP WLAN (802.11b/g) and internal surface-mount antenna					
2004 Celltech Labs Inc. This document is not to be reproduced in whole or in part without the written permission of Celltech Labs Inc.					25 of 49

Test Report S/N:	100504KBC-T562-E15W	
Test Date(s):	25Oct04 - 05Nov04	
Test Type(s):	FCC §15.247	IC RSS-210 Issue 5
Lab Registration(s):	FCC #714830	IC Lab File #3874

E.9.4. Channel 1 Out-of-Band Spurious Emission Field Strengths @ Specified Distance (not within restricted bands)



Company: 100504KBC-T562-E15W
Product: Itronix
 IX260+ with Senao NL-3054MP Plus Aries2 WLAN

Standard: FCC15.247c
Test Start Date: 25Oct04
Test End Date: 03Nov04

Mode b																		
Channel	Polarity	Distance	Rx Antenna	Frequency	SA Level	Noise Floor	Rx AF	Rx CL	Other Rx	Total Rx CF	Field Strength	Detector	Limit Distance	Limit Distance Correction	Calculated Limit	Lower Limit	Margin	Pass/Fail
		m		MHz	dBuV		dB/m	dB	dB	dB/m	dBuV/m	PK/QP/AV	m	dB	dBuV/m		dB	
CH1	H	3	Horn SN6276	4441.56	49.57		34.70	4.78	-34.04	5.43	55.00	PK	3.00	0.00	88.39	*	33.38	PASS
CH1	H	1	Horn SN6276	13155.80	46.30		41.72	9.46	-34.15	17.03	63.33	PK	3.00	9.54	97.93	*	34.60	PASS
CH1	V	3	Horn SN6276	1889.00	24.70		29.07	3.07	0.00	32.14	56.84	PK	3.00	0.00	82.34	*	25.50	PASS
CH1	V	3	Horn SN6276	2565.00	47.50		30.61	3.58	-20.13	14.06	61.56	PK	3.00	0.00	82.34	*	20.78	PASS
CH1	V	3	Horn SN6276	5272.81	53.55		36.14	5.24	-34.38	7.00	60.55	PK	3.00	0.00	82.34	*	21.79	PASS
CH1	V	3	Horn SN6276	8803.44	46.61		39.89	6.88	-34.28	12.49	59.10	PK	3.00	0.00	82.34	*	23.24	PASS
CH1	V	3	Horn SN6276	9531.88	45.80		40.30	7.28	-34.26	13.32	59.12	PK	3.00	0.00	82.34	*	23.22	PASS
CH1	V	1	Horn SN6276	16428.50	44.30		41.71	10.15	-33.10	18.77	63.07	PK	3.00	9.54	91.88	*	28.81	PASS

E.9.5. Channel 1 Harmonic Emission Field Strengths @ Specified Distance (not within restricted bands)



Company: 100504KBC-T562-E15W
Product: Itronix
 IX260+ with Senao NL-3054MP Plus Aries2 WLAN

Standard: FCC15.247c
Test Start Date: 25Oct04
Test End Date: 03Nov04

Mode b																		
Channel	Polarity	Distance	Rx Antenna	Frequency	SA Level	Noise Floor	Rx AF	Rx CL	Other Rx	Total Rx CF	Field Strength	Detector	Limit Distance	Limit Distance Correction	Calculated Limit	Lower Limit	Margin	Pass/Fail
		m		MHz	dBuV		dB/m	dB	dB	dB/m	dBuV/m	PK/QP/AV	m	dB	dBuV/m		dB	
CH1	H	3	Horn SN6276	7236.00	44.50		38.22	6.28	-34.32	10.19	54.69	PK	3.00	0.00	88.39	*	33.70	PASS
CH1	H	3	Horn SN6276	9648.00	50.06		40.30	7.37	-34.25	13.41	63.47	PK	3.00	0.00	88.39	*	24.91	PASS
CH1	H	1	Horn SN6276	16884.00	36.50	x	42.74	10.36	-36.68	16.42	52.92	PK	3.00	9.54	97.93	*	45.01	PASS
CH1	V	3	Horn SN6276	7236.00	45.72		38.22	6.28	-34.32	10.19	55.91	PK	3.00	0.00	82.34	*	26.43	PASS
CH1	V	3	Horn SN6276	9648.00	49.38		40.30	7.37	-34.25	13.41	62.79	PK	3.00	0.00	82.34	*	19.54	PASS
CH1	V	1	Horn SN6276	16884.00	36.90	x	42.74	10.36	-36.68	16.42	53.32	PK	3.00	9.54	91.88	*	38.56	PASS

Formulae:

Total CF = Antenna Factor + Cable Factor + Other Factor (Amplifier Gain, filter loss, etc)

Field Strength = SA Reading + Total CF

Limit Distance Correction = 40*log(d1/d2) for F<30 MHz, 20*log(d1/d2) for F> 30 MHz:

where d1 is the measurement distance, d2 is the published limit distance

Limit = Specified Limit + Limit Distance Correction

Margin = Limit - Field Strength

*Where applicable the QP or Average Limits where applied to the peak emission

No emissions levels were measured above those reported

Applicant:	Itronix Corporation	Model:	IX260PLUSNL305	FCC ID:	KBCIX260PLUSNL305
Rugged Laptop PC with internal Senao NL-3054MP WLAN (802.11b/g) and internal surface-mount antenna					
2004 Celltech Labs Inc. This document is not to be reproduced in whole or in part without the written permission of Celltech Labs Inc.					26 of 49

Test Report S/N:	100504KBC-T562-E15W	
Test Date(s):	25Oct04 - 05Nov04	
Test Type(s):	FCC §15.247	IC RSS-210 Issue 5
Lab Registration(s):	FCC #714830	IC Lab File #3874

E.9.6. Channel 6 Out-of-Band Spurious Emission Field Strengths @ Specified Distance (not within restricted bands)



Company: 100504KBC-T562-E15W
Product: Itronix
 IX260+ with Senao NL-3054MP Plus Aries2 WLAN

Standard: FCC15.247c
Test Start Date: 25Oct04
Test End Date: 03Nov04

Mode b																		
Channel	Polarity	Distance	Rx Antenna	Frequency	SA Level	Noise Floor	Rx AF	Rx CL	Other Rx	Total Rx CF	Field Strength	Detector	Limit Distance	Limit Distance Correction	Calculated Limit	Lower Limit	Margin	Pass/Fail
		m		MHz	dBuV		dB/m	dB	dB	dB/m	dBuV/m	(PK/QP/AV)	m	dB	#REF!		dB	
CH6	H	3	Horn SN6276	1892.00	22.10		29.08	3.07	0.00	32.15	54.25	PK	3.00	0.00	88.39	*	34.13	PASS
CH6	V	3	Horn SN6276	1887.00	31.10		29.06	3.07	0.00	32.13	63.23	PK	3.00	0.00	82.34	*	19.11	PASS
CH6	V	1	Horn SN6276	17641.50	39.90		44.82	10.48	-36.59	18.72	58.62	PK	3.00	9.54	91.88	*	33.26	PASS

E.9.7. Channel 6 Harmonic Emission Field Strengths @ Specified Distance (not within restricted bands)



Company: 100504KBC-T562-E15W
Product: Itronix
 IX260+ with Senao NL-3054MP Plus Aries2 WLAN

Standard: FCC15.247c
Test Start Date: 25Oct04
Test End Date: 03Nov04

Mode b																		
Channel	Polarity	Distance	Rx Antenna	Frequency	SA Level	Noise Floor	Rx AF	Rx CL	Other Rx	Total Rx CF	Field Strength	Detector	Limit Distance	Limit Distance Correction	Calculated Limit	Lower Limit	Margin	Pass/Fail
		m		MHz	dBuV		dB/m	dB	dB	dB/m	dBuV/m	(PK/QP/AV)	m	dB	#REF!		dB	
CH6	H	3	Horn SN6276	9748.00	47.32	x	40.30	7.39	-34.25	13.44	60.76	PK	3.00	0.00	88.39	*	27.63	PASS
CH6	H	1	Horn SN6276	17059.00	38.50	x	43.17	10.40	-36.66	16.91	55.41	PK	3.00	9.54	97.93	*	42.52	PASS
CH6	H	1	3160-09	21933.00	47.81	x	40.30	11.99	-37.96	14.33	62.14	PK	3.00	9.54	97.93	*	35.79	PASS
CH6	V	3	Horn SN6276	9748.00	49.37	x	40.30	7.39	-34.25	13.44	62.81	PK	3.00	0.00	82.34	*	19.53	PASS
CH6	V	1	Horn SN6276	17059.00	36.70	x	43.17	10.40	-36.66	16.91	53.61	PK	3.00	9.54	91.88	*	38.27	PASS
CH6	V	1	3160-09	21933.00	48.67		40.30	11.99	-37.96	14.33	63.00	PK	3.00	9.54	91.88	*	28.88	PASS

Formulae:

Total CF = Antenna Factor + Cable Factor + Other Factor (Amplifier Gain, filter loss, etc)
 Field Strength = SA Reading + Total CF
 Limit Distance Correction = 40*log(d1/d2) for F<30 MHz, 20*log(d1/d2) for F> 30 MHz:
 where d1 is the measurement distance, d2 is the published limit distance
 Limit = Specified Limit + Limit Distance Correction
 Margin = Limit - Field Strength

*Where applicable the QP or Average Limits were applied to the peak emission

No emissions levels were measured above those reported

Applicant:	Itronix Corporation	Model:	IX260PLUSNL305	FCC ID:	KBCIX260PLUSNL305
Rugged Laptop PC with internal Senao NL-3054MP WLAN (802.11b/g) and internal surface-mount antenna					
2004 Celltech Labs Inc. This document is not to be reproduced in whole or in part without the written permission of Celltech Labs Inc.					27 of 49

Test Report S/N:	100504KBC-T562-E15W	
Test Date(s):	25Oct04 - 05Nov04	
Test Type(s):	FCC §15.247	IC RSS-210 Issue 5
Lab Registration(s):	FCC #714830	IC Lab File #3874

E.9.8. Channel 11 Out-of-Band Spurious Emission Field Strengths @ Specified Distance (not within restricted bands)



Company: 100504KBC-T562-E15W
Product: Itronix
 IX260+ with Senao NL-3054MP Plus Aries2 WLAN

Standard: FCC15.247c
Test Start Date: 25Oct04
Test End Date: 03Nov04

Mode b																		
Channel	Polarity	Distance	Rx Antenna	Frequency	SA Level	Noise Floor	Rx AF	Rx CL	Other Rx	Total Rx CF	Field Strength	Detector	Limit Distance	Limit Distance Correction	Calculated Limit	Lower Limit	Margin	Pass/Fail
		m		MHz	dBuV		dB/m	dB	dB	dB/m	dBuV/m	(PK/QP/AV)	m	dB	#REF!		dB	
CH11	H	3	Horn SN6276	4441.56	49.57		34.70	4.78	-34.04	5.43	55.00	PK	3.00	0.00	88.39	*	33.38	PASS
CH11	H	3	Horn SN6276	9647.81	50.06		40.30	7.37	-34.25	13.41	63.47	PK	3.00	0.00	88.39	*	24.91	PASS
CH11	H	1	Horn SN6276	16498.40	44.50		41.90	10.28	-33.05	19.12	63.62	PK	3.00	9.54	97.93	*	34.31	PASS
CH11	V	3	Horn SN6276	9647.81	49.38		40.30	7.37	-34.25	13.41	62.79	PK	3.00	0.00	82.34	*	19.54	PASS
CH11	V	1	Horn SN6276	16422.00	45.30		41.70	10.14	-33.10	18.73	64.03	PK	3.00	9.54	91.88	*	27.85	PASS

E.9.9. Channel 11 Harmonic Emission Field Strengths @ Specified Distance (not within restricted bands)



Company: 100504KBC-T562-E15W
Product: Itronix
 IX260+ with Senao NL-3054MP Plus Aries2 WLAN

Standard: FCC15.247c
Test Start Date: 25Oct04
Test End Date: 03Nov04

Mode b																		
Channel	Polarity	Distance	Rx Antenna	Frequency	SA Level	Noise Floor	Rx AF	Rx CL	Other Rx	Total Rx CF	Field Strength	Detector	Limit Distance	Limit Distance Correction	Calculated Limit	Lower Limit	Margin	Pass/Fail
		m		MHz	dBuV		dB/m	dB	dB	dB/m	dBuV/m	(PK/QP/AV)	m	dB	dBuV/m		dB	
CH11	H	3	Horn SN6276	9848.00	44.51	x	40.30	7.41	-34.25	13.46	57.97	PK	3.00	0.00	88.39	*	30.41	PASS
CH11	V	3	Horn SN6276	9848.00	44.43	x	40.30	7.41	-34.25	13.46	57.89	PK	3.00	0.00	82.34	*	24.44	PASS

Formulae:

Total CF = Antenna Factor + Cable Factor + Other Factor (Amplifier Gain, filter loss, etc)
 Field Strength = SA Reading + Total CF
 Limit Distance Correction = 40*log(d1/d2) for F<30 MHz, 20*log(d1/d2) for F> 30 MHz:
 where d1 is the measurement distance, d2 is the published limit distance
 Limit = Specified Limit + Limit Distance Correction
 Margin = Limit - Field Strength

*Where applicable the QP or Average Limits where applied to the peak emission

No emissions levels were measured above those reported

Applicant:	Itronix Corporation	Model:	IX260PLUSNL305	FCC ID:	KBCIX260PLUSNL305
Rugged Laptop PC with internal Senao NL-3054MP WLAN (802.11b/g) and internal surface-mount antenna					
2004 Celltech Labs Inc. This document is not to be reproduced in whole or in part without the written permission of Celltech Labs Inc.					28 of 49

Test Report S/N:	100504KBC-T562-E15W	
Test Date(s):	25Oct04 - 05Nov04	
Test Type(s):	FCC §15.247	IC RSS-210 Issue 5
Lab Registration(s):	FCC #714830	IC Lab File #3874

E.10. PASS/FAIL

In reference to the results outlined in E.9, the DUT passes the requirements as stated in the reference standards as follows:
 FCC 15.247 (c): All emissions within any 100 kHz bandwidth outside the operating frequency band are greater than 20 dB below the maximum 100 kHz bandwidth signal within the operating band.

E.11. SIGN-OFF

I attest to the accuracy of the data. All measurements reported herein were performed by me and are correct to the best of my knowledge and belief. I assume full responsibility for the completeness of these measurements.



Russell Pipe
 Senior Compliance Technologist
 Celltech Labs Inc.

04Nov04
 Date

Applicant:	Itronix Corporation	Model:	IX260PLUSNL305	FCC ID:	KBCIX260PLUSNL305
Rugged Laptop PC with internal Senao NL-3054MP WLAN (802.11b/g) and internal surface-mount antenna					
2004 Celltech Labs Inc. This document is not to be reproduced in whole or in part without the written permission of Celltech Labs Inc.					29 of 49

Test Report S/N:	100504KBC-T562-E15W	
Test Date(s):	25Oct04 - 05Nov04	
Test Type(s):	FCC §15.247	IC RSS-210 Issue 5
Lab Registration(s):	FCC #714830	IC Lab File #3874

Appendix F - Restricted Band Emissions Measurement

F.1. REFERENCES	
Normative Reference Standard	FCC CFR 47 §15.205 (a) (b), FCC CFR 47 §15.209 (a)
Procedure Reference	FCC 97-114

F.2. LIMITS																																																																									
FCC CFR 47 §15.205	(a) Except as shown in paragraph (d) of this section, only spurious emissions are permitted in any of the frequency bands listed below:																																																																								
	<table border="1"> <thead> <tr> <th>MHz</th> <th>MHz</th> <th>MHz</th> <th>GHz</th> </tr> </thead> <tbody> <tr><td>0.090-0.110</td><td>16.42-16.423</td><td>399.9-410</td><td>4.5-5.15</td></tr> <tr><td>10.495-0.505</td><td>16.69475-16.69525</td><td>608-614</td><td>5.35-5.46</td></tr> <tr><td>2.1735-2.1905</td><td>16.80425-16.80475</td><td>960-1240</td><td>7.25-7.75</td></tr> <tr><td>4.125-4.128</td><td>25.5-25.67</td><td>1300-1427</td><td>8.025-8.5</td></tr> <tr><td>4.17725-4.17775</td><td>37.5-38.25</td><td>1435-1626.5</td><td>9.0-9.2</td></tr> <tr><td>4.20725-4.20775</td><td>73-74.6</td><td>1645.5-1646.5</td><td>9.3-9.5</td></tr> <tr><td>6.215-6.218</td><td>74.8-75.2</td><td>1660-1710</td><td>10.6-12.7</td></tr> <tr><td>6.26775-6.26825</td><td>108-121.94</td><td>1718.8-1722.2</td><td>13.25-13.4</td></tr> <tr><td>6.31175-6.31225</td><td>123-138</td><td>2200-2300</td><td>14.47-14.5</td></tr> <tr><td>8.291-8.294</td><td>149.9-150.05</td><td>2310-2390</td><td>15.35-16.2</td></tr> <tr><td>8.362-8.366</td><td>156.52475-156.52525</td><td>2483.5-2500</td><td>17.7-21.4</td></tr> <tr><td>8.37625-8.38675</td><td>156.7-156.9</td><td>2655-2900</td><td>22.01-23.12</td></tr> <tr><td>8.41425-8.41475</td><td>162.0125-167.17</td><td>3260-3267</td><td>23.6-24.0</td></tr> <tr><td>12.29-12.293</td><td>167.72-173.2</td><td>3332-3339</td><td>31.2-31.8</td></tr> <tr><td>12.51975-12.52025</td><td>240-285</td><td>3345.8-3358</td><td>36.43-36.5</td></tr> <tr><td>12.57675-12.57725</td><td>322-335.4</td><td>3600-4400</td><td>(²)</td></tr> <tr><td>13.36-13.41</td><td></td><td></td><td></td></tr> </tbody> </table> <p>¹Until February 1, 1999, this restricted band shall be 0.490-0.510 MHz. ²Above 38.6</p>	MHz	MHz	MHz	GHz	0.090-0.110	16.42-16.423	399.9-410	4.5-5.15	10.495-0.505	16.69475-16.69525	608-614	5.35-5.46	2.1735-2.1905	16.80425-16.80475	960-1240	7.25-7.75	4.125-4.128	25.5-25.67	1300-1427	8.025-8.5	4.17725-4.17775	37.5-38.25	1435-1626.5	9.0-9.2	4.20725-4.20775	73-74.6	1645.5-1646.5	9.3-9.5	6.215-6.218	74.8-75.2	1660-1710	10.6-12.7	6.26775-6.26825	108-121.94	1718.8-1722.2	13.25-13.4	6.31175-6.31225	123-138	2200-2300	14.47-14.5	8.291-8.294	149.9-150.05	2310-2390	15.35-16.2	8.362-8.366	156.52475-156.52525	2483.5-2500	17.7-21.4	8.37625-8.38675	156.7-156.9	2655-2900	22.01-23.12	8.41425-8.41475	162.0125-167.17	3260-3267	23.6-24.0	12.29-12.293	167.72-173.2	3332-3339	31.2-31.8	12.51975-12.52025	240-285	3345.8-3358	36.43-36.5	12.57675-12.57725	322-335.4	3600-4400	(²)	13.36-13.41			
MHz	MHz	MHz	GHz																																																																						
0.090-0.110	16.42-16.423	399.9-410	4.5-5.15																																																																						
10.495-0.505	16.69475-16.69525	608-614	5.35-5.46																																																																						
2.1735-2.1905	16.80425-16.80475	960-1240	7.25-7.75																																																																						
4.125-4.128	25.5-25.67	1300-1427	8.025-8.5																																																																						
4.17725-4.17775	37.5-38.25	1435-1626.5	9.0-9.2																																																																						
4.20725-4.20775	73-74.6	1645.5-1646.5	9.3-9.5																																																																						
6.215-6.218	74.8-75.2	1660-1710	10.6-12.7																																																																						
6.26775-6.26825	108-121.94	1718.8-1722.2	13.25-13.4																																																																						
6.31175-6.31225	123-138	2200-2300	14.47-14.5																																																																						
8.291-8.294	149.9-150.05	2310-2390	15.35-16.2																																																																						
8.362-8.366	156.52475-156.52525	2483.5-2500	17.7-21.4																																																																						
8.37625-8.38675	156.7-156.9	2655-2900	22.01-23.12																																																																						
8.41425-8.41475	162.0125-167.17	3260-3267	23.6-24.0																																																																						
12.29-12.293	167.72-173.2	3332-3339	31.2-31.8																																																																						
12.51975-12.52025	240-285	3345.8-3358	36.43-36.5																																																																						
12.57675-12.57725	322-335.4	3600-4400	(²)																																																																						
13.36-13.41																																																																									
	(b) Except as provided in paragraphs (d) and (e), the field strength of emissions appearing within these frequency bands shall not exceed the limits shown in 15.209. At frequencies equal to or less than 1000 MHz, compliance with the limits in Section 15.209 shall be demonstrated using measurement instrumentation employing a CISPR quasi-peak detector. Above 1000 MHz, compliance with the emission limits in Section 15.209 shall be demonstrated based on the average value of the measured emissions. The provisions of 15.35 apply to these measurements.																																																																								
FCC CFR 47 §15.209	(a) Except as provided elsewhere in this Subpart, the emissions from an intentional radiator shall not exceed the field strength levels specified in the following table:																																																																								
	<table border="1"> <thead> <tr> <th rowspan="2">Frequency</th> <th colspan="2">Field Strength</th> <th rowspan="2">Measurement Distance</th> </tr> <tr> <th>MHz</th> <th>uV/m</th> <th>Meters</th> </tr> </thead> <tbody> <tr> <td>.009 - 0.490</td> <td>2400/F(kHz)</td> <td>48.52 - 13.80</td> <td>300</td> </tr> <tr> <td>0.490 - 1.705</td> <td>24000/F(kHz)</td> <td>33.80 - 22.97</td> <td>30</td> </tr> <tr> <td>1.705 - 30.0</td> <td>30</td> <td>29.54</td> <td>30</td> </tr> <tr> <td>30 - 88</td> <td>100</td> <td>40.00</td> <td>3</td> </tr> <tr> <td>88 - 216</td> <td>150</td> <td>43.52</td> <td>3</td> </tr> <tr> <td>216 - 960</td> <td>200</td> <td>46.02</td> <td>3</td> </tr> <tr> <td>Above 960</td> <td>500</td> <td>53.98</td> <td>3</td> </tr> </tbody> </table>	Frequency	Field Strength		Measurement Distance	MHz	uV/m	Meters	.009 - 0.490	2400/F(kHz)	48.52 - 13.80	300	0.490 - 1.705	24000/F(kHz)	33.80 - 22.97	30	1.705 - 30.0	30	29.54	30	30 - 88	100	40.00	3	88 - 216	150	43.52	3	216 - 960	200	46.02	3	Above 960	500	53.98	3																																					
Frequency	Field Strength		Measurement Distance																																																																						
	MHz	uV/m		Meters																																																																					
.009 - 0.490	2400/F(kHz)	48.52 - 13.80	300																																																																						
0.490 - 1.705	24000/F(kHz)	33.80 - 22.97	30																																																																						
1.705 - 30.0	30	29.54	30																																																																						
30 - 88	100	40.00	3																																																																						
88 - 216	150	43.52	3																																																																						
216 - 960	200	46.02	3																																																																						
Above 960	500	53.98	3																																																																						
	(b) In the emission table above, the tighter limit applies at the band edges.																																																																								

Applicant:	Itronix Corporation	Model:	IX260PLUSNL305	FCC ID:	KBCIX260PLUSNL305
Rugged Laptop PC with internal Senao NL-3054MP WLAN (802.11b/g) and internal surface-mount antenna					
2004 Celltech Labs Inc. This document is not to be reproduced in whole or in part without the written permission of Celltech Labs Inc.					30 of 49

Test Report S/N:	100504KBC-T562-E15W	
Test Date(s):	25Oct04 - 05Nov04	
Test Type(s):	FCC §15.247	IC RSS-210 Issue 5
Lab Registration(s):	FCC #714830	IC Lab File #3874

F.3. ENVIRONMENTAL CONDITIONS	
Temperature	27.4 +/- 2 °C
Humidity	33 +/- 2 %
Barometric Pressure	96.24 +/- 0.2 kPa

F.4. EQUIPMENT LIST					
ASSET NUMBER	MANUFACTURER	MODEL	DESCRIPTION	LAST CAL	CAL DUE
00072	EMCO	2075	Mini-mast	n/a	n/a
00073	EMCO	2080	Turn Table	n/a	n/a
00071	EMCO	2090	Multi-Device Controller	n/a	n/a
00200	Empire	LG-105	Large Loop Antenna	30Apr04	30Apr05
00201	Empire	LC-105	Small Loop Antenna	30Apr04	30Apr05
00050	Chase	CBL-6111A	Bilog Antenna	30Apr04	30Apr05
00035	ETS	3115	Double Ridged Guide Horn	24Mar04	24Mar05
00202	ETS	3160-09	Small Horn Antenna	27May04	27Jun05
00015	Agilent	E4408B	Spectrum Analyzer	29Dec03	29Dec04
00049	HP	8566B	Spectrum Analyzer RF Section	18May04	18May05
00049	HP	85650A	Quasi-peak Adapter	18May04	18May05
00047	HP	85685A	RF Preselector	18May04	18May05
00048	Gore	65474	Microwave Cable	20May04	20May05
00030	HP	83017A	LNA	20May04	20May05

Applicant:	Itronix Corporation	Model:	IX260PLUSNL305	FCC ID:	KBCIX260PLUSNL305
Rugged Laptop PC with internal Senao NL-3054MP WLAN (802.11b/g) and internal surface-mount antenna					
2004 Celltech Labs Inc. This document is not to be reproduced in whole or in part without the written permission of Celltech Labs Inc.					31 of 49

Test Report S/N:	100504KBC-T562-E15W	
Test Date(s):	25Oct04 - 05Nov04	
Test Type(s):	FCC §15.247	IC RSS-210 Issue 5
Lab Registration(s):	FCC #714830	IC Lab File #3874

F.5. MEASUREMENT EQUIPMENT SETUP

MEASUREMENT EQUIPMENT CONNECTIONS	The measurement equipment was connected as shown in the F.6. A number of antennas were used to cover the applicable frequency range test. The ranges in which each antenna was used are as follows:			
	Frequency Range	Antenna		
	9 kHz – 150 kHz	LP-105 Loop		
	150 kHz – 30 MHz	LG-105 Loop		
	30 MHz – 1 GHz	CBL-6111A Bilog		
	1 GHz – 18 GHz	ETS 3115 Horn		
	18 GHz– 26GHz	ETS 3160-09 Horn		
MEASUREMENT EQUIPMENT SETTINGS	The spectrum analyzer was set to the following settings:			
	Frequency Range	RBW	VBW	Detector
	MHz	kHz	kHz	
	0.009 - 0.150	0.200	10	Peak*
	0.150 - 30	9	30	Peak*
	30 – 1000	100	300	Peak*
> 1000	1000*	1000	Peak*	
*As a worse case measurement, the average/quasi-peak limits were applied to measurements made with a peak detector.				

F.6. SETUP DRAWING

Figure F-1 – Setup Drawing

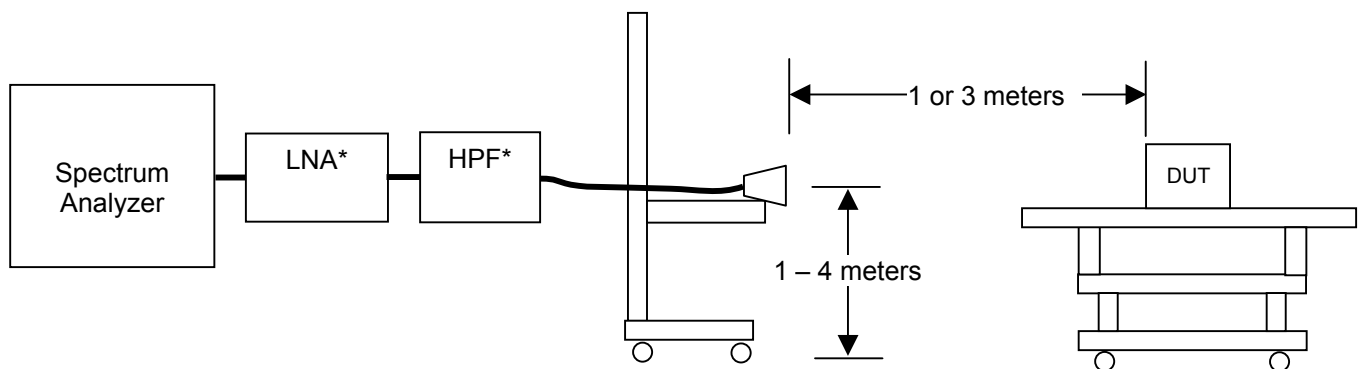

* Used for >1GHz

Test Report S/N:	100504KBC-T562-E15W	
Test Date(s):	25Oct04 - 05Nov04	
Test Type(s):	FCC §15.247	IC RSS-210 Issue 5
Lab Registration(s):	FCC #714830	IC Lab File #3874

F.7. SETUP PHOTOGRAPHS

Photograph F-1 - Horizontal Polarization (30MHz - 1 GHz)



Photograph F-2 - Vertical Polarization (1-18 GHz)



Photograph F-3 - Front of Radiated Emission Configuration



Photograph F-4 - Back of Radiated Emission Configuration

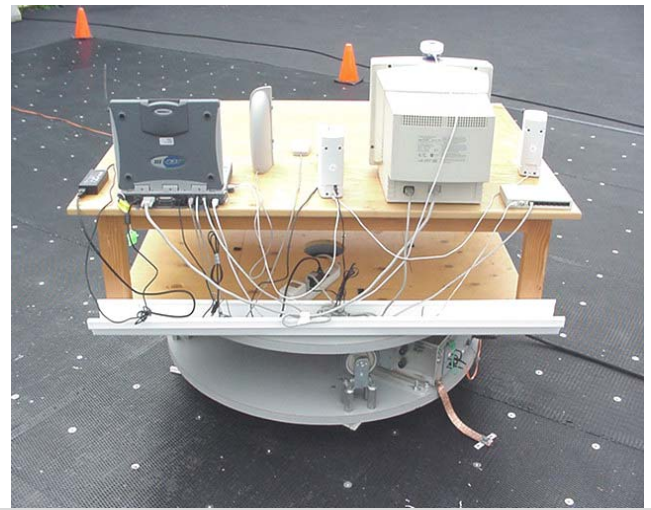

F.8. DUT OPERATING DESCRIPTION

The worst-case data rate was determined from prescan investigations. Measurements were made at three channels throughout the band, Low Channel (2412 MHz), Mid Channel (2437 MHz), High Channel (2462 MHz) and for both Modes b and g for the band-edge measurements and for Mode b for the remaining measurements.

Applicant:	Itronix Corporation	Model:	IX260PLUSNL305	FCC ID:	KBCIX260PLUSNL305
Rugged Laptop PC with internal Senao NL-3054MP WLAN (802.11b/g) and internal surface-mount antenna					
2004 Celltech Labs Inc. This document is not to be reproduced in whole or in part without the written permission of Celltech Labs Inc.					33 of 49

Test Report S/N:	100504KBC-T562-E15W		
Test Date(s):	25Oct04 - 05Nov04		
Test Type(s):	FCC §15.247	IC RSS-210 Issue 5	
Lab Registration(s):	FCC #714830	IC Lab File #3874	

F.9. TEST RESULTS

F.9.1. Upper Band-edge Emission Field Strengths @ Specified Distance

Note: (Lower Band-edge (Out-of-Band) is in Appendix E)

Channel 11 Mode b - Conducted Band-edge Plots

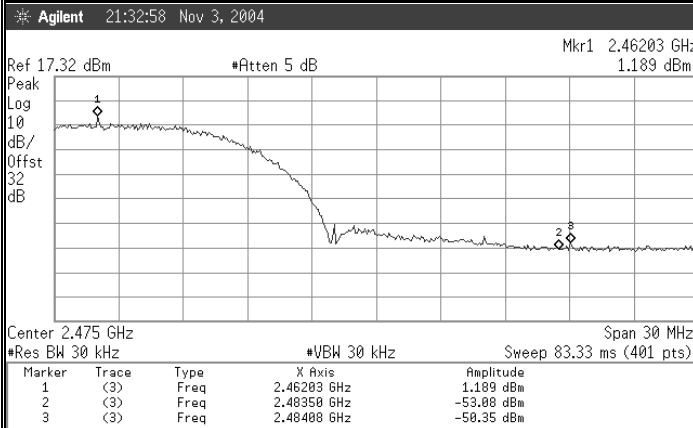

Channel 11 Mode g - Conducted Band-edge Plots

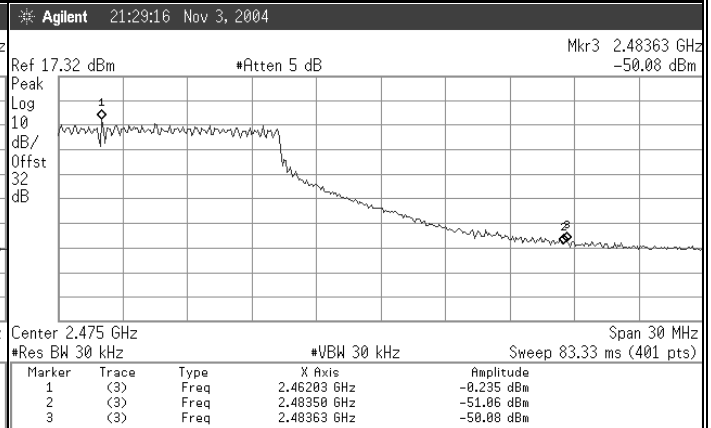

Channel 11 Mode b - Radiated Carrier Field Strengths

Channel	Polarity	Measurement Distance	Antenna	Frequency	SA Level	Mode b				Field Strength	Detector	
						Nose Floor	AF	CL	Other			Total CF
11	H	3	Horn SN6276	2462.00	80.01		30.34	3.52	0.00	33.86	113.87	PK
11	H	3	Horn SN6276	2462.00	71.00		30.34	3.52	0.00	33.86	104.86	AV
11	V	3	Horn SN6276	2462.00	74.17		30.34	3.52	0.00	33.86	108.03	PK
11	V	3	Horn SN6276	2462.00	65.24		30.34	3.52	0.00	33.86	99.10	AV

Channel 11 Mode g - Radiated Carrier Field Strengths

Channel	Polarity	Measurement Distance	Antenna	Frequency	SA Level	Mode g				Field Strength	Detector	
						Nose Floor	AF	CL	Other			Total CF
11	H	3	Horn SN6276	2462.00	77.70		30.34	3.52	0.00	33.86	111.56	PK
11	H	3	Horn SN6276	2462.00	69.10		30.34	3.52	0.00	33.86	102.96	AV
11	V	3	Horn SN6276	2462.00	73.86		30.34	3.52	0.00	33.86	107.72	PK
11	V	3	Horn SN6276	2462.00	64.80		30.34	3.52	0.00	33.86	98.66	AV

Channel 11 b - Calculated Band-edge (Restricted) Field Strengths

Channel	Polarity	Distance	Frequency	Carrier Radiated Field Strength	Marker-Delta	Detector	Mode b				Margin	Pass/Fail
							Calculated Band-edge Field Strength	Limit Distance	Limit Distance Correction	Specified Limit		
11	H	3	2483.50	113.87	51.64	PK	62.33	3.00	0.00	73.98	11.65	Pass
11	H	3	2483.50	104.86	51.64	AV	53.32	3.00	0.00	53.98	0.66	Pass
11	V	3	2483.50	108.03	51.64	PK	56.49	3.00	0.00	73.98	17.49	Pass
11	V	3	2483.50	99.10	51.64	AV	47.56	3.00	0.00	53.98	6.42	Pass

Channel 11 g - Calculated Band-edge (Restricted) Field Strengths

Channel	Polarity	Distance	Frequency	Carrier Radiated Field Strength	Marker-Delta	Detector	Mode g				Margin	Pass/Fail
							Calculated Band-edge Field Strength	Limit Distance	Limit Distance Correction	Specified Limit		
11	H	3	2483.50	111.56	49.85	PK	61.71	3.00	0.00	73.98	12.27	Pass
11	H	3	2483.50	102.96	49.85	AV	53.11	3.00	0.00	53.98	0.87	Pass
11	V	3	2483.50	107.72	49.85	PK	57.87	3.00	0.00	73.98	16.11	Pass
11	V	3	2483.50	98.66	49.85	AV	48.81	3.00	0.00	53.98	5.17	Pass

Formulae:

Total CF (dB) = Antenna Factor (dB) + Cable Factor (dB) + Other Factor (Amplifier Gain, Filter Loss, etc) (dB)

Field Strength (dBuV/m) = SA Reading (dBuV) + Total CF (dB/m)

Limit Distance Correction (dB) = 40 * log(d1/d2) for f < 30 MHz, 20*log(d1/d2) for f > 30 MHz; where d1 is the measurement distance and d2 is the published limit

Limit (dBuV/m) = Published Limit (dBuV/m) + Limit Distance Correction (dB)

Margin (dB) = Limit (dBuV/m) - Field Strength (dBuV/m)

Note: Measurements and calculation reference the Marker-Delta Method described in FCC Public Notice DA 00-705

Applicant:	Itronix Corporation	Model:	IX260PLUSNL305	FCC ID:	KBCIX260PLUSNL305
Rugged Laptop PC with internal Senao NL-3054MP WLAN (802.11b/g) and internal surface-mount antenna					
2004 Celltech Labs Inc. This document is not to be reproduced in whole or in part without the written permission of Celltech Labs Inc.					34 of 49

Test Report S/N:	100504KBC-T562-E15W	
Test Date(s):	25Oct04 - 05Nov04	
Test Type(s):	FCC §15.247	IC RSS-210 Issue 5
Lab Registration(s):	FCC #714830	IC Lab File #3874

F.9.2. Channel 1 Out-of-Band Spurious Emission Field Strengths @ Specified Distance (within restricted bands)



Company: 100504KBC-T562-E15W
Product: Itronix
 IX260+ with Senao NL-3054MP Plus Aries2 WLAN

Standard: FCC15.209
Test Start Date: 25Oct04
Test End Date: 03Nov04

Mode b																		
Channel	Polarity	Distance	Rx Antenna	Frequency	SA Level	Noise Floor	Rx AF	Rx CL	Other Rx	Total Rx CF	Field Strength	Detector	Limit Distance	Limit Distance Correction	Calculated Limit	Lower Limit	Margin	Pass/Fail
		m		MHz	dBuV		dB/m	dB	dB	dB/m	dBuV/m	PK/QP/AV	m	dB	dBuV/m		dB	
CH1	H	3	Hom SN6276	2688.00	51.40		31.00	3.65	-19.98	14.67	66.07	PK	3.00	0.00	73.98		7.91	PASS
CH1	H	3	Hom SN6276	2688.00	28.80		31.00	3.65	-19.98	14.67	43.47	AV	3.00	0.00	53.98		10.51	PASS
CH1	H	3	Hom SN6276	2768.00	51.40		31.26	3.71	-19.94	15.03	66.43	PK	3.00	0.00	73.98		7.55	PASS
CH1	H	3	Hom SN6276	2768.00	27.40		31.26	3.71	-19.94	15.03	42.43	AV	3.00	0.00	53.98		11.55	PASS
CH1	H	3	Hom SN6276	7541.25	56.96		38.73	6.43	-34.31	10.85	67.81	PK	3.00	0.00	73.98		6.17	PASS
CH1	H	3	Hom SN6276	7541.25	38.80		38.73	6.43	-34.31	10.85	49.65	AV	3.00	0.00	53.98		4.33	PASS
CH1	H	3	Hom SN6276	9035.31	38.70		40.21	7.02	-34.27	12.96	51.66	PK	3.00	0.00	73.98		22.32	PASS
CH1	H	3	Hom SN6276	9035.00	34.10		40.21	7.02	-34.27	12.96	47.06	AV	3.00	0.00	53.98		6.92	PASS
CH1	H	1	Hom SN6276	13159.79	50.30		41.73	9.45	-34.15	17.03	67.33	PK	3.00	9.54	83.52		16.19	PASS
CH1	H	1	Hom SN6276	13155.80	37.80		41.72	9.46	-34.15	17.03	54.83	AV	3.00	9.54	63.52		8.69	PASS
CH1	H	1	Hom SN6276	16138.89	52.90		40.96	10.01	-33.30	17.67	70.57	PK	3.00	9.54	83.52		12.96	PASS
CH1	H	1	Hom SN6276	16138.89	39.70		40.96	10.01	-33.30	17.67	57.37	AV	3.00	9.54	63.52		6.16	PASS
CH1	H	1	Hom SN6276	17991.00	52.50		45.87	10.45	-36.54	19.78	72.28	PK	3.00	9.54	83.52		11.25	PASS
CH1	H	1	Hom SN6276	17991.00	39.90		45.87	10.45	-36.54	19.78	59.68	AV	3.00	9.54	63.52		3.85	PASS
CH1	V	3	Hom SN6276	1089.00	39.30		26.62	2.31	0.00	28.93	68.23	PK	3.00	0.00	73.98		5.74	PASS
CH1	V	3	Hom SN6276	1089.00	24.20		26.62	2.31	0.00	28.93	53.13	AV	3.00	0.00	53.98		0.84	PASS
CH1	V	3	Hom SN6276	2486.00	51.60		30.38	3.51	-20.25	13.64	65.24	PK	3.00	0.00	73.98		8.74	PASS
CH1	V	3	Hom SN6276	2486.00	37.30		30.38	3.51	-20.25	13.64	50.94	AV	3.00	0.00	53.98		3.04	PASS
CH1	V	3	Hom SN6276	2734.00	51.10		31.15	3.68	-19.96	14.87	65.97	PK	3.00	0.00	73.98		8.01	PASS
CH1	V	3	Hom SN6276	2734.00	27.20		31.15	3.68	-19.96	14.87	42.07	AV	3.00	0.00	53.98		11.91	PASS
CH1	V	3	Hom SN6276	2844.00	50.40		31.50	3.77	-19.90	15.37	65.77	PK	3.00	0.00	73.98		8.21	PASS
CH1	V	3	Hom SN6276	2844.00	27.40		31.50	3.77	-19.90	15.37	42.77	AV	3.00	0.00	53.98		11.21	PASS
CH1	V	3	Hom SN6276	7541.25	48.00		38.73	6.43	-34.31	10.85	58.85	PK	3.00	0.00	73.98		15.13	PASS
CH1	V	3	Hom SN6276	7541.25	37.30		38.73	6.43	-34.31	10.85	48.15	AV	3.00	0.00	53.98		5.83	PASS
CH1	V	3	Hom SN6276	9363.44	46.20		40.27	7.23	-34.26	13.24	59.44	PK	3.00	0.00	73.98		14.54	PASS
CH1	V	3	Hom SN6276	9363.44	33.30		40.27	7.23	-34.26	13.24	46.54	AV	3.00	0.00	53.98		7.44	PASS
CH1	V	1	Hom SN6276	16428.00	53.20		41.71	10.15	-33.10	18.76	71.96	PK	3.00	9.54	83.52		11.56	PASS
CH1	V	1	Hom SN6276	16429.93	39.40		41.72	10.16	-33.10	18.78	58.18	AV	3.00	9.54	63.52		5.35	PASS
CH1	V	1	Hom SN6276	17974.50	53.60		45.82	10.38	-36.55	19.66	73.26	PK	3.00	9.54	83.52		10.26	PASS
CH1	V	1	Hom SN6276	17974.50	39.90		45.82	10.38	-36.55	19.66	59.56	AV	3.00	9.54	63.52		3.96	PASS
CH1	V	1	3160-09	19770.00	55.00	x	40.30	11.39	-36.32	15.36	70.36	PK	3.00	9.54	83.52		13.16	PASS
CH1	V	1	3160-09	19770.00	42.40	x	40.30	11.39	-36.32	15.36	57.76	AV	3.00	9.54	63.52		5.76	PASS

Formulae:

Total CF = Antenna Factor + Cable Factor + Other Factor (Amplifier Gain, filter loss, etc)

Field Strength = SA Reading + Total CF

Limit Distance Correction = 40*log(d1/d2) for F<30 MHz, 20*log(d1/d2) for F> 30 MHz:

where d1 is the measurement distance, d2 is the published limit distance

Limit = Specified Limit + Limit Distance Correction

Margin = Limit - Field Strength

*Where applicable the QP or Average Limits where applied to the peak emission

The frequency points reported describe the highest emission measured in each of the ranges tested and are used to describe the measured spectrum as a whole. It is shown that the highest emissions measured within the spectrum pass the appropriate restricted limits; therefore all emissions within the restricted bands would also meet the requirements. No out-of-band emissions were measured above the levels noted.

Applicant:	Itronix Corporation	Model:	IX260PLUSNL305	FCC ID:	KBCIX260PLUSNL305
Rugged Laptop PC with internal Senao NL-3054MP WLAN (802.11b/g) and internal surface-mount antenna					
2004 Celltech Labs Inc. This document is not to be reproduced in whole or in part without the written permission of Celltech Labs Inc.					35 of 49

Test Report S/N:	100504KBC-T562-E15W	
Test Date(s):	25Oct04 - 05Nov04	
Test Type(s):	FCC §15.247	IC RSS-210 Issue 5
Lab Registration(s):	FCC #714830	IC Lab File #3874

F.9.3. Channel 1 Harmonic Emission Field Strengths @ Specified Distance (within restricted bands)



Company: 100504KBC-T562-E15W
Product: Itronix
 IX260+ with Senao NL-3054MP Plus Aries2 WLAN

Standard: FCC15.209
Test Start Date: 25Oct04
Test End Date: 03Nov04

Mode b																		
Channel	Polarity	Distance	Rx Antenna	Frequency	SA Level	Noise Floor	Rx AF	Rx CL	Other Rx	Total Rx CF	Field Strength	Detector	Limit Distance	Limit Distance Correction	Calculated Limit	Lower Limit	Margin	Pass/Fail
		m		MHz	dBuV		dB/m	dB	dB	dB/m	dBuV/m	(PK/QP/AV)	m	dB	dBuV/m		dB	
CH1	H	3	Horn SN6276	4824.00	42.40		35.35	4.98	-34.08	6.24	48.64	PK	3.00	0.00	73.98		25.34	PASS
CH1	H	3	Horn SN6276	4824.00	28.90		35.35	4.98	-34.08	6.24	35.14	AV	3.00	0.00	53.98		18.84	PASS
CH1	H	1	Horn SN6276	12060.00	36.10	x	40.58	8.54	-34.18	14.94	51.04	PK	3.00	9.54	63.52	*	12.49	PASS
CH1	H	1	Horn SN6276	14472.00	42.50	x	42.57	9.28	-34.12	17.74	60.24	PK	3.00	9.54	63.52	*	3.28	PASS
CH1	H	1	3160-09	19926.00	55.80	x	40.30	11.75	-36.30	15.75	71.55	PK	3.00	9.54	83.52		11.97	PASS
CH1	H	1	3160-09	19926.00	42.50	x	40.30	11.75	-36.30	15.75	58.25	AV	3.00	9.54	63.52		5.27	PASS
CH1	H	1	3160-09	21708.00	48.56	x	40.30	11.91	-38.05	14.15	62.71	PK	3.00	9.54	83.52		20.81	PASS
CH1	H	1	3160-09	21708.00	35.21	x	40.30	11.91	-38.05	14.15	49.36	AV	3.00	9.54	63.52		14.16	PASS
CH1	V	3	Horn SN6276	4824.00	44.40		35.35	4.98	-34.08	6.24	50.64	PK	3.00	0.00	73.98		23.34	PASS
CH1	V	3	Horn SN6276	4824.00	31.90		35.35	4.98	-34.08	6.24	38.14	AV	3.00	0.00	53.98		15.84	PASS
CH1	V	1	Horn SN6276	12060.00	36.10	x	40.58	8.54	-34.18	14.94	51.04	PK	3.00	9.54	63.52	*	12.49	PASS
CH1	V	1	Horn SN6276	14472.00	42.30	x	42.57	9.28	-34.12	17.74	60.04	PK	3.00	9.54	63.52	*	3.48	PASS
CH1	V	1	3160-09	19926.00	42.90	x	40.30	11.75	-36.30	15.75	58.65	PK	3.00	9.54	63.52	*	4.87	PASS
CH1	V	1	3160-09	21708.00	48.67	x	40.30	11.91	-38.05	14.15	62.82	PK	3.00	9.54	83.52		20.70	PASS
CH1	V	1	3160-09	21708.00	34.47	x	40.30	11.91	-38.05	14.15	48.62	AV	3.00	9.54	63.52		14.90	PASS

Formulae:

Total CF = Antenna Factor + Cable Factor + Other Factor (Amplifier Gain, filter loss, etc)

Field Strength = SA Reading + Total CF

Limit Distance Correction = $40 \cdot \log(d1/d2)$ for $F < 30$ MHz, $20 \cdot \log(d1/d2)$ for $F > 30$ MHz:

where d1 is the measurement distance, d2 is the published limit distance

Limit = Specified Limit + Limit Distance Correction

Margin = Limit - Field Strength

*Where applicable the QP or Average Limits where applied to the peak emission

The frequency points reported describe the highest emission measured in each of the ranges tested and are used to describe the measured spectrum as a whole. It is shown that the highest emissions measured within the spectrum pass the appropriate restricted limits; therefore all emissions within the restricted bands would also meet the requirements. No out-of-band emissions were measured above the levels noted.

Applicant:	Itronix Corporation	Model:	IX260PLUSNL305	FCC ID:	KBCIX260PLUSNL305
Rugged Laptop PC with internal Senao NL-3054MP WLAN (802.11b/g) and internal surface-mount antenna					
2004 Celltech Labs Inc. This document is not to be reproduced in whole or in part without the written permission of Celltech Labs Inc.					36 of 49

Test Report S/N:	100504KBC-T562-E15W	
Test Date(s):	25Oct04 - 05Nov04	
Test Type(s):	FCC §15.247	IC RSS-210 Issue 5
Lab Registration(s):	FCC #714830	IC Lab File #3874

F.9.4. Channel 6 Out-of-Band Spurious Emission Field Strengths @ Specified Distance (within restricted bands)



Company: 100504KBC-T562-E15W
Product: Itronix
 IX260+ with Senao NL-3054MP Plus Aries2 WLAN

Standard: FCC15.209
Test Start Date: 25Oct04
Test End Date: 03Nov04

Mode b																		
Channel	Polarity	Distance	Rx Antenna	Frequency	SA Level	Noise Floor	Rx AF	Rx CL	Other Rx	Total Rx CF	Field Strength	Detector	Limit Distance	Limit Distance Correction	Calculated Limit	Lower Limit	Margin	Pass/Fail
		m		MHz	dBuV		dB/m	dB	dB	dB/m	dBuV/m	(PK/QP/AV)	m	dB	#REF!		dB	
CH6	H	3	Horn SN6276	4284.06	42.40		34.70	4.68	-34.03	5.36	47.76	PK	3.00	0.00	73.98		26.22	PASS
CH6	H	3	Horn SN6276	4284.06	29.60		34.70	4.68	-34.03	5.36	34.96	AV	3.00	0.00	53.98		19.02	PASS
CH6	H	3	Horn SN6276	4319.06	43.50		34.70	4.70	-34.03	5.37	48.87	PK	3.00	0.00	73.98		25.11	PASS
CH6	H	3	Horn SN6276	4319.06	30.40		34.70	4.70	-34.03	5.37	35.77	AV	3.00	0.00	53.98		18.21	PASS
CH6	H	1	Horn SN6276	16430.10	52.10		41.72	10.16	-33.10	18.78	70.88	PK	3.00	9.54	83.52		12.64	PASS
CH6	H	1	Horn SN6276	16430.10	39.40		41.72	10.16	-33.10	18.78	58.18	AV	3.00	9.54	63.52		5.34	PASS
CH6	H	1	Horn SN6276	17925.00	52.60		45.68	10.28	-36.55	19.40	72.00	PK	3.00	9.54	83.52		11.52	PASS
CH6	H	1	Horn SN6276	17925.00	39.90		45.68	10.28	-36.55	19.40	59.30	AV	3.00	9.54	63.52		4.22	PASS
CH6	H	1	3160-09	19920.00	55.40		40.30	11.74	-36.30	15.74	71.14	PK	3.00	9.54	83.52		12.38	PASS
CH6	H	1	3160-09	19920.00	42.50		40.30	11.74	-36.30	15.74	58.24	AV	3.00	9.54	63.52		5.28	PASS
CH6	V	3	Horn SN6276	1081.00	36.40		26.61	2.30	0.00	28.91	65.31	PK	3.00	0.00	73.98		8.67	PASS
CH6	V	3	Horn SN6276	1081.00	24.20		26.61	2.30	0.00	28.91	53.11	AV	3.00	0.00	53.98		0.87	PASS
CH6	V	3	Horn SN6276	1109.00	34.50		26.65	2.33	0.00	28.98	63.48	PK	3.00	0.00	73.98		10.50	PASS
CH6	V	3	Horn SN6276	1109.00	23.10		26.65	2.33	0.00	28.98	52.08	AV	3.00	0.00	53.98		1.90	PASS
CH6	V	3	Horn SN6276	1887.00	35.30		29.06	3.07	0.00	32.13	67.43	PK	3.00	0.00	73.98		6.55	PASS
CH6	V	3	Horn SN6276	1887.00	25.20		29.06	3.07	0.00	32.13	57.33	AV	3.00	0.00	73.98	*	16.65	PASS
CH6	V	3	Horn SN6276	4316.88	44.40		34.70	4.70	-34.03	5.37	49.77	PK	3.00	0.00	73.98		24.21	PASS
CH6	V	3	Horn SN6276	4316.88	31.10		34.70	4.70	-34.03	5.37	36.47	AV	3.00	0.00	53.98		17.51	PASS
CH6	V	1	Horn SN6276	14777.50	51.80		42.54	9.29	-34.11	17.73	69.53	PK	3.00	9.54	83.52		13.99	PASS
CH6	V	1	Horn SN6276	14777.50	39.00		42.54	9.29	-34.11	17.73	56.73	AV	3.00	9.54	63.52		6.79	PASS
CH6	V	1	Horn SN6276	16462.60	52.50		41.80	10.23	-33.08	18.96	71.46	PK	3.00	9.54	83.52		12.07	PASS
CH6	V	1	Horn SN6276	16462.60	39.10		41.80	10.23	-33.08	18.96	58.06	AV	3.00	9.54	63.52		5.47	PASS
CH6	V	1	Horn SN6276	17641.50	39.90		44.82	10.48	-36.59	18.72	58.62	PK	3.00	9.54	63.52	*	4.91	PASS
CH6	V	1	3160-09	19986.00	55.20		40.30	11.77	-36.30	15.77	70.97	PK	3.00	9.54	83.52		12.55	PASS
CH6	V	1	3160-09	19986.00	42.40		40.30	11.77	-36.30	15.77	58.17	AV	3.00	9.54	63.52		5.35	PASS

Formulae:

Total CF = Antenna Factor + Cable Factor + Other Factor (Amplifier Gain, filter loss, etc)

Field Strength = SA Reading + Total CF

Limit Distance Correction = 40*log(d1/d2) for F<30 MHz, 20*log(d1/d2) for F> 30 MHz:

where d1 is the measurement distance, d2 is the published limit distance

Limit = Specified Limit + Limit Distance Correction

Margin = Limit - Field Strength

*Where applicable the QP or Average Limits where applied to the peak emission

The frequency points reported describe the highest emission measured in each of the ranges tested and are used to describe the measured spectrum as a whole. It is shown that the highest emissions measured within the spectrum pass the appropriate restricted limits; therefore all emissions within the restricted bands would also meet the requirements. No out-of-band emissions were measured above the levels noted.

Applicant:	Itronix Corporation	Model:	IX260PLUSNL305	FCC ID:	KBCIX260PLUSNL305
Rugged Laptop PC with internal Senao NL-3054MP WLAN (802.11b/g) and internal surface-mount antenna					
2004 Celltech Labs Inc. This document is not to be reproduced in whole or in part without the written permission of Celltech Labs Inc.					37 of 49

Test Report S/N:	100504KBC-T562-E15W	
Test Date(s):	25Oct04 - 05Nov04	
Test Type(s):	FCC §15.247	IC RSS-210 Issue 5
Lab Registration(s):	FCC #714830	IC Lab File #3874

F.9.5. Channel 6 Harmonic Emission Field Strengths @ Specified Distance (within restricted bands)



Company: 100504KBC-T562-E15W
Product: Itronix IX260+ with Senao NL-3054MP Plus Aries2 WLAN

Standard: FCC15.209
Test Start Date: 25Oct04
Test End Date: 03Nov04

Mode b																		
Channel	Polarity	Distance	Rx Antenna	Frequency	SA Level	Noise Floor	Rx AF	Rx CL	Other Rx	Total Rx CF	Field Strength	Detector	Limit Distance	Limit Distance Correction	Calculated Limit	Lower Limit	Margin	Pass/Fail
		m		MHz	dBuV		dB/m	dB	dB	dB/m	dBuV/m	PK/QP/AV	m	dB	#REF!		dB	
CH6	H	3	Horn SN6276	4874.00	43.40		35.45	5.03	-34.09	6.39	49.79	PK	3.00	0.00	73.98		24.19	PASS
CH6	H	3	Horn SN6276	4874.00	30.20		35.45	5.03	-34.09	6.39	36.59	AV	3.00	0.00	53.98		17.39	PASS
CH6	H	3	Horn SN6276	7311.00	47.32	x	38.36	6.31	-34.32	10.35	57.67	PK	3.00	0.00	73.98		16.31	PASS
CH6	H	3	Horn SN6276	7311.00	32.20	x	38.36	6.31	-34.32	10.35	42.55	AV	3.00	0.00	53.98		11.43	PASS
CH6	H	1	Horn SN6276	14622.00	51.90	x	42.58	9.35	-34.11	17.82	69.72	PK	3.00	9.54	83.52		13.80	PASS
CH6	H	1	Horn SN6276	14622.00	38.90	x	42.58	9.35	-34.11	17.82	56.72	AV	3.00	9.54	63.52		6.80	PASS
CH6	H	1	3160-09	19496.00	54.90	x	40.30	11.28	-36.36	15.22	70.12	PK	3.00	9.54	83.52		13.40	PASS
CH6	H	1	3160-09	19496.00	42.20	x	40.30	11.28	-36.36	15.22	57.42	AV	3.00	9.54	63.52		6.10	PASS
CH6	H	1	3160-09	24370.00	51.62	x	40.40	12.90	-36.92	16.38	68.00	PK	3.00	9.54	83.52		15.52	PASS
CH6	H	1	3160-09	24370.00	41.40	x	40.40	12.90	-36.92	16.38	57.78	AV	3.00	9.54	63.52		5.74	PASS
CH6	V	3	Horn SN6276	4874.69	43.20		35.45	5.03	-34.09	6.39	49.59	PK	3.00	0.00	73.98		24.39	PASS
CH6	V	3	Horn SN6276	4874.69	30.40		35.45	5.03	-34.09	6.39	36.79	AV	3.00	0.00	53.98		17.19	PASS
CH6	V	3	Horn SN6276	7311.00	44.09	x	38.36	6.31	-34.32	10.35	54.44	PK	3.00	0.00	73.98		19.54	PASS
CH6	V	3	Horn SN6276	7311.00	32.20	x	38.36	6.31	-34.32	10.35	42.55	AV	3.00	0.00	53.98		11.43	PASS
CH6	V	1	Horn SN6276	14622.00	51.70	x	42.58	9.35	-34.11	17.82	69.52	PK	3.00	9.54	83.52		14.00	PASS
CH6	V	1	Horn SN6276	14622.00	38.80	x	42.58	9.35	-34.11	17.82	56.62	AV	3.00	9.54	63.52		6.90	PASS
CH6	V	1	3160-09	19496.00	54.80	x	40.30	11.28	-36.36	15.22	70.02	PK	3.00	9.54	83.52		13.50	PASS
CH6	V	1	3160-09	19496.00	42.20	x	40.30	11.28	-36.36	15.22	57.42	AV	3.00	9.54	63.52		6.10	PASS
CH6	V	1	3160-09	24370.00	51.54	x	40.40	12.90	-36.92	16.38	67.92	PK	3.00	9.54	83.52		15.60	PASS
CH6	V	1	3160-09	24370.00	37.09	x	40.40	12.90	-36.92	16.38	53.47	AV	3.00	9.54	63.52		10.05	PASS

Formulae:

Total CF = Antenna Factor + Cable Factor + Other Factor (Amplifier Gain, filter loss, etc)

Field Strength = SA Reading + Total CF

Limit Distance Correction = 40*log(d1/d2) for F<30 MHz, 20*log(d1/d2) for F> 30 MHz:

where d1 is the measurement distance, d2 is the published limit distance

Limit = Specified Limit + Limit Distance Correction

Margin = Limit - Field Strength

*Where applicable the QP or Average Limits were applied to the peak emission

The frequency points reported describe the highest emission measured in each of the ranges tested and are used to describe the measured spectrum as a whole. It is shown that the highest emissions measured within the spectrum pass the appropriate restricted limits; therefore all emissions within the restricted bands would also meet the requirements. No out-of-band emissions were measured above the levels noted.

Applicant:	Itronix Corporation	Model:	IX260PLUSNL305	FCC ID:	KBCIX260PLUSNL305
Rugged Laptop PC with internal Senao NL-3054MP WLAN (802.11b/g) and internal surface-mount antenna					
2004 Celltech Labs Inc. This document is not to be reproduced in whole or in part without the written permission of Celltech Labs Inc.					38 of 49

Test Report S/N:	100504KBC-T562-E15W	
Test Date(s):	25Oct04 - 05Nov04	
Test Type(s):	FCC §15.247	IC RSS-210 Issue 5
Lab Registration(s):	FCC #714830	IC Lab File #3874

F.9.6. Channel 11 Out-of-Band Spurious Emission Field Strengths @ Specified Distance (within restricted bands)



Company: 100504KBC-T562-E15W
Product: Itronix
 IX260+ with Senao NL-3054MP Plus Aries2 WLAN

Standard: FCC15.209
Test Start Date: 25Oct04
Test End Date: 03Nov04

Mode b																		
Channel	Polarity	Distance	Rx Antenna	Frequency	SA Level	Noise Floor	Rx AF	Rx CL	Other Rx	Total Rx CF	Field Strength	Detector	Limit Distance	Limit Distance Correction	Calculated Limit	Lower Limit	Margin	Pass/Fail
CH11	H	3	Horn SN6276	4826.53	40.50		35.35	4.98	-34.08	6.25	46.75	PK	3.00	0.00	73.98		27.23	PASS
CH11	H	3	Horn SN6276	4826.53	27.80		35.35	4.98	-34.08	6.25	34.05	AV	3.00	0.00	53.98		19.93	PASS
CH11	H	3	Horn SN6276	9350.13	41.50		40.27	7.23	-34.26	13.24	54.74	PK	3.00	0.00	73.98		19.24	PASS
CH11	H	3	Horn SN6276	9350.13	28.50		40.27	7.23	-34.26	13.24	41.74	AV	3.00	0.00	53.98		12.24	PASS
CH11	H	1	3160-09	19907.86	55.20	x	40.30	11.73	-36.31	15.72	70.92	PK	3.00	9.54	83.52		12.60	PASS
CH11	H	1	3160-09	19907.86	42.40	x	40.30	11.73	-36.31	15.72	58.12	AV	3.00	9.54	63.52		5.40	PASS
CH11	H	1	3160-09	24616.31	50.61	x	40.40	13.00	-36.82	16.58	67.19	PK	3.00	9.54	83.52		16.33	PASS
CH11	H	1	3160-09	24616.31	36.75	x	40.40	13.00	-36.82	16.58	53.33	AV	3.00	9.54	63.52		10.19	PASS
CH11	V	3	Horn SN6276	4826.81	42.50		35.35	4.98	-34.08	6.25	48.75	PK	3.00	0.00	73.98		25.23	PASS
CH11	V	3	Horn SN6276	4826.81	29.80		35.35	4.98	-34.08	6.25	36.05	AV	3.00	0.00	53.98		17.93	PASS
CH11	V	3	Horn SN6276	7540.54	47.80		38.73	6.43	-34.31	10.85	58.65	PK	3.00	0.00	73.98		15.33	PASS
CH11	V	3	Horn SN6276	7540.54	41.20		38.73	6.43	-34.31	10.85	52.05	AV	3.00	0.00	53.98		1.93	PASS
CH11	V	3	Horn SN6276	9365.09	40.50		40.27	7.23	-34.26	13.24	53.74	PK	3.00	0.00	73.98		20.24	PASS
CH11	V	3	Horn SN6276	9365.09	27.50		40.27	7.23	-34.26	13.24	40.74	AV	3.00	0.00	53.98		13.24	PASS
CH11	V	1	3160-09	19920.45	55.20	x	40.30	11.75	-36.30	15.74	70.94	PK	3.00	9.54	83.52		12.58	PASS
CH11	V	1	3160-09	19920.45	42.40	x	40.30	11.74	-36.30	15.74	58.14	AV	3.00	9.54	63.52		5.38	PASS
CH11	V	1	3160-09	24621.69	50.88	x	40.40	13.00	-36.82	16.58	67.46	PK	3.00	9.54	83.52		16.06	PASS
CH11	V	1	3160-09	24621.69	36.73	x	40.40	13.00	-36.82	16.58	53.31	AV	3.00	9.54	63.52		10.21	PASS

Formulae:

Total CF = Antenna Factor + Cable Factor + Other Factor (Amplifier Gain, filter loss, etc)

Field Strength = SA Reading + Total CF

Limit Distance Correction = 40*log(d1/d2) for F<30 MHz, 20*log(d1/d2) for F> 30 MHz:

where d1 is the measurement distance, d2 is the published limit distance

Limit = Specified Limit + Limit Distance Correction

Margin = Limit - Field Strength

*Where applicable the QP or Average Limits were applied to the peak emission

The frequency points reported describe the highest emission measured in each of the ranges tested and are used to describe the measured spectrum as a whole. It is shown that the highest emissions measured within the spectrum pass the appropriate restricted limits; therefore all emissions within the restricted bands would also meet the requirements. No out-of-band emissions were measured above the levels noted.

Applicant:	Itronix Corporation	Model:	IX260PLUSNL305	FCC ID:	KBCIX260PLUSNL305
Rugged Laptop PC with internal Senao NL-3054MP WLAN (802.11b/g) and internal surface-mount antenna					
2004 Celltech Labs Inc. This document is not to be reproduced in whole or in part without the written permission of Celltech Labs Inc.					39 of 49

Test Report S/N:	100504KBC-T562-E15W	
Test Date(s):	25Oct04 - 05Nov04	
Test Type(s):	FCC §15.247	IC RSS-210 Issue 5
Lab Registration(s):	FCC #714830	IC Lab File #3874

F.9.7. Channel 11 Harmonic Emission Field Strengths @ Specified Distance (within restricted bands)



Company: 100504KBC-T562-E15W
Product: Itronix
 IX260+ with Senao NL-3054MP Plus Aries2 WLAN

Standard: FCC15.209
Test Start Date: 25Oct04
Test End Date: 03Nov04

Mode b																		
Channel	Polarity	Distance	Rx Antenna	Frequency	SA Level	Noise Floor	Rx AF	Rx CL	Other Rx	Total Rx CF	Field Strength	Detector	Limit Distance	Limit Distance Correction	Calculated Limit	Lower Limit	Margin	Pass/Fail
CH11	H	3	Horn SN6276	4924.00	41.20		35.55	5.05	-34.09	6.51	47.71	PK	3.00	0.00	73.98		26.27	PASS
CH11	H	3	Horn SN6276	4924.00	28.80		35.55	5.05	-34.09	6.51	35.31	AV	3.00	0.00	53.98		18.67	PASS
CH11	H	3	Horn SN6276	7386.00	44.50		38.49	6.34	-34.32	10.51	55.01	PK	3.00	0.00	73.98		18.97	PASS
CH11	H	3	Horn SN6276	7386.00	31.70		38.49	6.34	-34.32	10.51	42.21	AV	3.00	0.00	53.98		11.77	PASS
CH11	H	1	Horn SN6276	12310.00	36.30	x	40.93	8.69	-34.18	15.45	51.75	PK	3.00	9.54	63.52	*	11.78	PASS
CH11	H	1	Horn SN6276	14772.00	51.90	x	42.55	9.29	-34.11	17.73	69.63	PK	3.00	9.54	83.52		13.89	PASS
CH11	H	1	Horn SN6276	14772.00	39.00	x	42.55	9.29	-34.11	17.73	56.73	AV	3.00	9.54	63.52		6.79	PASS
CH11	H	1	3160-09	19696.00	54.90	x	40.30	11.42	-36.33	15.39	70.29	PK	3.00	9.54	83.52		13.24	PASS
CH11	H	1	3160-09	19696.00	42.30	x	40.30	11.42	-36.33	15.39	57.69	AV	3.00	9.54	63.52		5.84	PASS
CH11	H	1	3160-09	22158.00	49.49	x	40.33	12.08	-37.86	14.54	64.03	PK	3.00	9.54	83.52		19.49	PASS
CH11	H	1	3160-09	22158.00	35.19	x	40.33	12.08	-37.86	14.54	49.73	AV	3.00	9.54	63.52		13.79	PASS
CH11	V	3	Horn SN6276	4924.00	46.60		35.55	5.05	-34.09	6.51	53.11	PK	3.00	0.00	73.98		20.87	PASS
CH11	V	3	Horn SN6276	4924.00	40.10		35.55	5.05	-34.09	6.51	46.61	AV	3.00	0.00	53.98		7.37	PASS
CH11	V	3	Horn SN6276	7386.00	43.60		38.49	6.34	-34.32	10.51	54.11	PK	3.00	0.00	73.98		19.87	PASS
CH11	V	3	Horn SN6276	7386.00	31.10		38.49	6.34	-34.32	10.51	41.61	AV	3.00	0.00	53.98		12.37	PASS
CH11	V	1	Horn SN6276	12310.00	36.90		40.93	8.69	-34.18	15.45	52.35	PK	3.00	9.54	63.52	*	11.18	PASS
CH11	V	1	Horn SN6276	14772.00	51.30	x	42.55	9.29	-34.11	17.73	69.03	PK	3.00	9.54	83.52		14.49	PASS
CH11	V	1	Horn SN6276	14772.00	39.06	x	42.55	9.29	-34.11	17.73	56.79	AV	3.00	9.54	63.52		6.73	PASS
CH11	V	1	3160-09	19696.00	55.50	x	40.30	11.42	-36.33	15.39	70.89	PK	3.00	9.54	83.52		12.64	PASS
CH11	V	1	3160-09	19696.00	42.30	x	40.30	11.42	-36.33	15.39	57.69	AV	3.00	9.54	63.52		5.84	PASS
CH11	V	1	3160-09	22158.00	49.48	x	40.33	12.08	-37.86	14.54	64.02	PK	3.00	9.54	83.52		19.50	PASS
CH11	V	1	3160-09	22158.00	35.46	x	40.33	12.08	-37.86	14.54	50.00	AV	3.00	9.54	63.52		13.52	PASS

Formulae:

Total CF = Antenna Factor + Cable Factor + Other Factor (Amplifier Gain, filter loss, etc)
 Field Strength = SA Reading + Total CF
 Limit Distance Correction = 40*log(d1/d2) for F<30 MHz, 20*log(d1/d2) for F> 30 MHz:
 where d1 is the measurement distance, d2 is the published limit distance
 Limit = Specified Limit + Limit Distance Correction
 Margin = Limit - Field Strength

*Where applicable the QP or Average Limits where applied to the peak emission

The frequency points reported describe the highest emission measured in each of the ranges tested and are used to describe the measured spectrum as a whole. It is shown that the highest emissions measured within the spectrum pass the appropriate restricted limits; therefore all emissions within the restricted bands would also meet the requirements. No out-of-band emissions were measured above the levels noted.

Applicant:	Itronix Corporation	Model:	IX260PLUSNL305	FCC ID:	KBCIX260PLUSNL305
Rugged Laptop PC with internal Senao NL-3054MP WLAN (802.11b/g) and internal surface-mount antenna					
2004 Celltech Labs Inc. This document is not to be reproduced in whole or in part without the written permission of Celltech Labs Inc.					40 of 49

Test Report S/N:	100504KBC-T562-E15W	
Test Date(s):	25Oct04 - 05Nov04	
Test Type(s):	FCC §15.247	IC RSS-210 Issue 5
Lab Registration(s):	FCC #714830	IC Lab File #3874

F.10. PASS/FAIL

In reference to the results outlined in F.9, the DUT passes the requirements as stated in the reference standards as follows: FCC 15.205 (a) (b) and 15.209 (a): No emissions were measured within the restricted bands as outlined in 15.205 that exceeded the limits stated in 15.209.

F.11. SIGN-OFF

I attest to the accuracy of the data. All measurements reported herein were performed by me and are correct to the best of my knowledge and belief. I assume full responsibility for the completeness of these measurements.



Russell Pipe
Senior Compliance Technologist
Celltech Labs Inc.

04Nov04
Date

Applicant:	Itronix Corporation	Model:	IX260PLUSNL305	FCC ID:	KBCIX260PLUSNL305
Rugged Laptop PC with internal Senao NL-3054MP WLAN (802.11b/g) and internal surface-mount antenna					
2004 Celltech Labs Inc. This document is not to be reproduced in whole or in part without the written permission of Celltech Labs Inc.					41 of 49

Test Report S/N:	100504KBC-T562-E15W	
Test Date(s):	25Oct04 - 05Nov04	
Test Type(s):	FCC §15.247	IC RSS-210 Issue 5
Lab Registration(s):	FCC #714830	IC Lab File #3874

Appendix G - Peak Power Spectral Density Measurement

G.1. REFERENCES

Normative Reference Standard	FCC CFR 47 §15.247(d)
Procedure Reference	FCC 97-114

G.2. LIMITS

G.2.1. FCC CFR

§15.247(d): For digitally modulated systems, the peak power spectral density conducted from the intentional radiator to the antenna shall not be greater than +8 dBm in any 3 kHz band during any time interval of continuous transmission.

G.3. TEST PROCEDURE

The test method used is outlined in the ADT Corp reference test report no. RF921215R02, section 4.5

G.4. TEST RESULTS

The results used to show compliance to the applicable parts are outlined in the ADT Corp reference test report no. RF921215R02, section 4.5.

Channel	802.11b			802.11g		
	Frequency (GHz)	PPSD (dBm)	Data Rate Mb/s	Frequency (GHz)	PPSD (dBm)	Data Rate Mb/s
Low	2.412	-1.13	11	2.412	-10.79	6
Mid	2.437	5.44	11	2.437	-7.58	6
High	2.462	4.44	11	2.462	-11.99	6

G.5. PASS/FAIL

In reference to the results outlined in G.4 and stated in the ADT Corp reference report, the DUT passes the requirements as stated in the reference standards as follows:

FCC 15.247 (d): The peak power spectral density did not exceed +8 dBm in any 3 kHz band.

Applicant:	Itronix Corporation	Model:	IX260PLUSNL305	FCC ID:	KBCIX260PLUSNL305
Rugged Laptop PC with internal Senao NL-3054MP WLAN (802.11b/g) and internal surface-mount antenna					
2004 Celltech Labs Inc. This document is not to be reproduced in whole or in part without the written permission of Celltech Labs Inc.					42 of 49

Test Report S/N:	100504KBC-T562-E15W	
Test Date(s):	25Oct04 - 05Nov04	
Test Type(s):	FCC §15.247	IC RSS-210 Issue 5
Lab Registration(s):	FCC #714830	IC Lab File #3874

Appendix H - Conducted Powerline Emissions Measurement

H.1. REFERENCES	
Normative Reference Standard	CFR 47 FCC Part 15 §15.207
Procedure Reference	ANSI C63.4

H.2. LIMITS		
<p>§15.207: Compliance with the provisions of this paragraph shall be based on the measurement of the radio frequency voltage between each powerline and ground at the power terminal.</p>		
Frequency of Emission (MHz)	Conducted Limit (dBuV)	
	Quasi-Peak	Average
0.15 – 0.5	66 to 56*	56 to 46*
0.50 – 5.0	56	46
5.0 – 30.0	60	50

*Decreases logarithmically with frequency.

H.3. ENVIRONMENTAL CONDITIONS	
Temperature	+26 ± 5 °C
Humidity	31 % ± 10% RH
Barometric Pressure	101.4 kpa

H.4. EQUIPMENT LIST					
ASSET NUMBER	MANUFACTURER	MODEL	DESCRIPTION	LAST CAL	CAL DUE
00063	HP	85662A	Spectrum Analyzer Display	na	na
00051	HP	8566B	Spectrum Analyzer RF Section	18May04	18May05
00049	HP	85650A	Quasi-Peak Adapter	18May04	18May05
00047	HP	85685A	Preselector	18May04	18May05
00083	EMCO	3825/2	Line Impedance Stabilization Network	29Apr04	29Apr05
00084	EMCO	3825/2	Line Impedance Stabilization Network	29Apr04	29Apr05

H.5. MEASUREMENT EQUIPMENT SETUP	
MEASUREMENT EQUIPMENT CONNECTIONS	The conducted emissions were measured on each of the two AC powerline leads connected to the DUT's power supply brick. A two line LISN was used to make this measurement. A drawing of the equipment setup is shown in H.7
MEASUREMENT EQUIPMENT SETTINGS	<p>Each of the monitor ports from the 2-line LISN was connected in turn to the spectrum analyzer. The port not connected to the analyzer was terminated in a 50-ohm load. A prescan of the peak emission levels was made of the 150 kHz – 30 MHz range split into 4 equal frequency bands. The following were the spectrum analyzer settings:</p> <ul style="list-style-type: none"> Start Frequency and Stop Frequency set by software for each of the four bands RBW: 100 kHz VBW: 300 kHz Sweep: 500 mS <p>The resulting data from each band was corrected and collected by software and presented in the graphical representations shown in H.9 for the two leads. The frequency points with the highest 10 levels on each lead were used by software to optimize a set of 20 readings for each type of detector (peak, quasi-peak and average). This data was corrected by the software is presented in the tables shown in section H.9.</p>

Applicant:	Itronix Corporation	Model:	IX260PLUSNL305	FCC ID:	KBCIX260PLUSNL305
Rugged Laptop PC with internal Senao NL-3054MP WLAN (802.11b/g) and internal surface-mount antenna					
2004 Celltech Labs Inc. This document is not to be reproduced in whole or in part without the written permission of Celltech Labs Inc.					43 of 49

Test Report S/N:	100504KBC-T562-E15W	
Test Date(s):	25Oct04 - 05Nov04	
Test Type(s):	FCC §15.247	IC RSS-210 Issue 5
Lab Registration(s):	FCC #714830	IC Lab File #3874

H.6. SETUP PHOTOS

Photograph H-1 – AC Powerline Conducted Emission Configuration



Photograph H-2 – AC Powerline Conducted Emission Cable Placement



Applicant:	Itronix Corporation	Model:	IX260PLUSNL305	FCC ID:	KBCIX260PLUSNL305
Rugged Laptop PC with internal Senao NL-3054MP WLAN (802.11b/g) and internal surface-mount antenna					
2004 Celltech Labs Inc. This document is not to be reproduced in whole or in part without the written permission of Celltech Labs Inc.					44 of 49

H.7. SETUP DRAWING

Figure H-1 – Setup Drawing

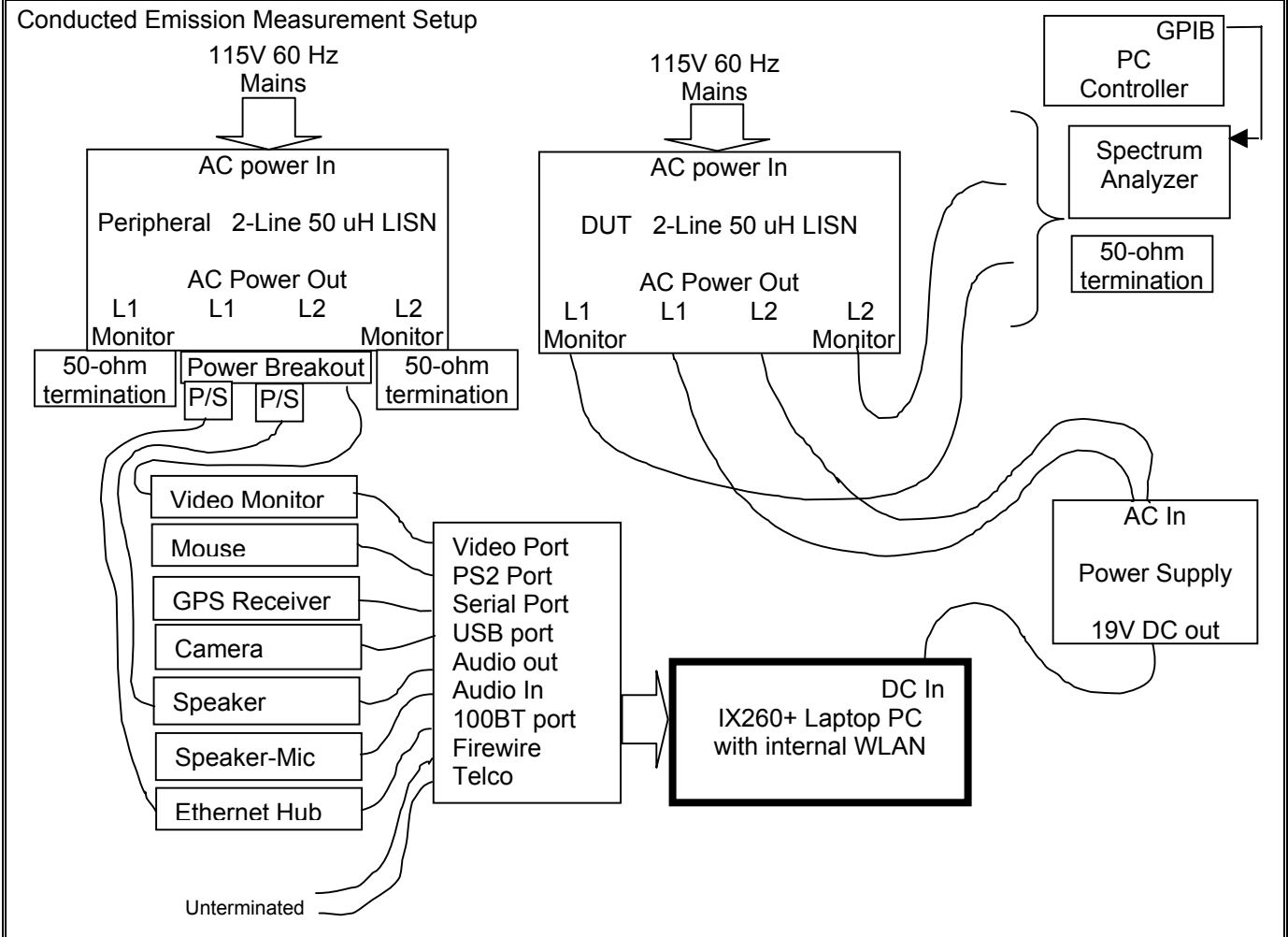

H.8. DUT OPERATING DESCRIPTION

WLAN:	The WLAN was set to transmit at full power on Channel 1, Mode b 1 Mb/s
PC:	Other than operating the WLAN software and running MS windows, no PC exercising was performed.
Peripherals:	All peripherals were active, but no specific traffic was initiated.

Test Report S/N:	100504KBC-T562-E15W	
Test Date(s):	25Oct04 - 05Nov04	
Test Type(s):	FCC §15.247	IC RSS-210 Issue 5
Lab Registration(s):	FCC #714830	IC Lab File #3874

H.9. TEST RESULTS

H.9.1. Line 1 Conducted Emissions

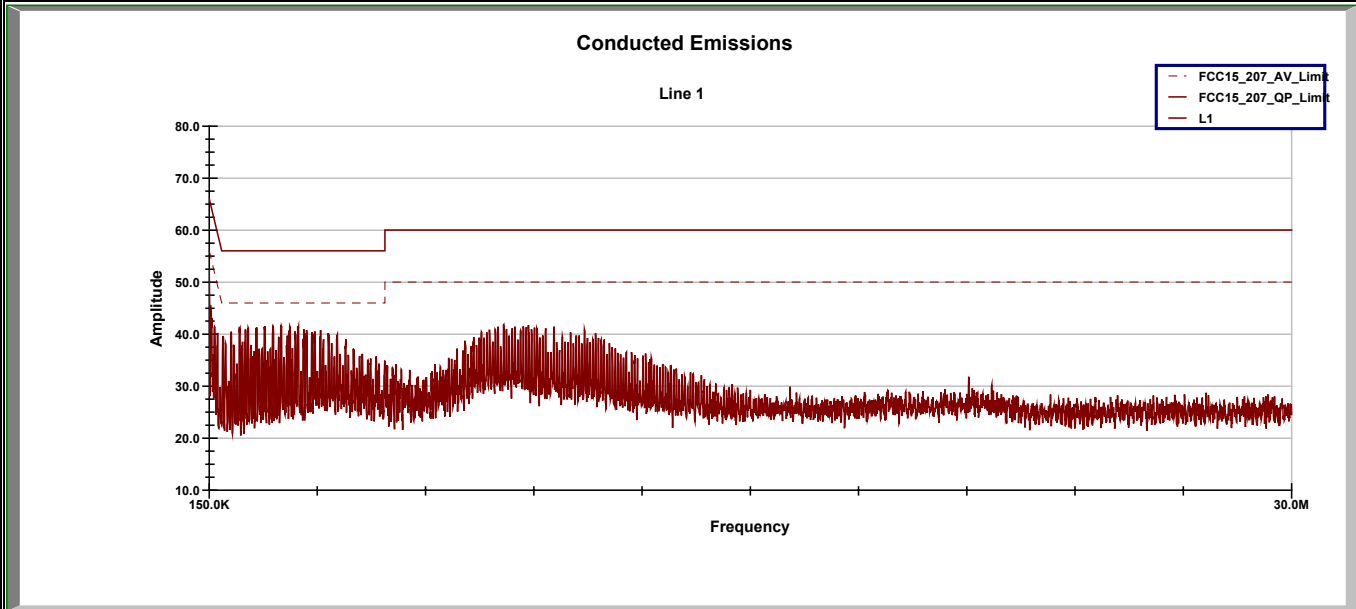

Project Number: 072804KBC-T543-E15B
Company: Itronix
Product: IX260+ with Cirronet BT2022 Bluetooth

Standard: FCC 15.207
Test Start Date: 14-Oct-04
Test End Date: 14-Oct-04

Line 1 Conducted Emissions

Frequency MHz	Uncorrected Reading			Correction Factor dB	Corrected Emission Level			Quasi-Peak Limit dBuV	Quasi-Peak Margin dB	Average Limit dBuV	Average Margin dB	Pass/Fail
	Peak dBuV	Quasi-Peak dBuV	Average dBuV		Peak dBuV	Quasi-Peak dBuV	Average dBuV					
0.186	46.50	42.69	25.92	1.57	48.07	44.26	27.49	64.23	19.97	54.23	26.74	Pass
0.992	39.70	38.89	38.44	0.32	40.03	39.22	38.77	56.00	16.79	46.00	7.24	Pass
1.895	43.00	31.49	29.85	0.29	43.29	31.78	30.13	56.00	24.22	46.00	15.87	Pass
2.126	43.10	41.67	41.32	0.29	43.39	41.96	41.61	56.00	14.04	46.00	4.39	Pass
8.290	42.80	41.50	38.55	0.32	43.12	41.82	38.87	60.00	18.18	50.00	11.13	Pass
8.975	42.40	40.92	36.32	0.33	42.73	41.25	36.65	60.00	18.75	50.00	13.35	Pass
9.654	41.40	39.08	33.94	0.33	41.73	39.41	34.27	60.00	20.59	50.00	15.73	Pass
16.301	30.00	23.10	15.72	0.37	30.37	23.47	16.09	60.00	36.53	50.00	33.91	Pass

Calculations

CF = Correction Factor
Emission Level = Measured Level + correction factor
Margin = Limit – Emission Level

Applicant:	Itronix Corporation	Model:	IX260PLUSNL305	FCC ID:	KBCIX260PLUSNL305
Rugged Laptop PC with internal Senao NL-3054MP WLAN (802.11b/g) and internal surface-mount antenna					
2004 Celltech Labs Inc. This document is not to be reproduced in whole or in part without the written permission of Celltech Labs Inc.					46 of 49

Test Report S/N:	100504KBC-T562-E15W	
Test Date(s):	25Oct04 - 05Nov04	
Test Type(s):	FCC §15.247	IC RSS-210 Issue 5
Lab Registration(s):	FCC #714830	IC Lab File #3874

H.9.2. Line 2 Conducted Emissions

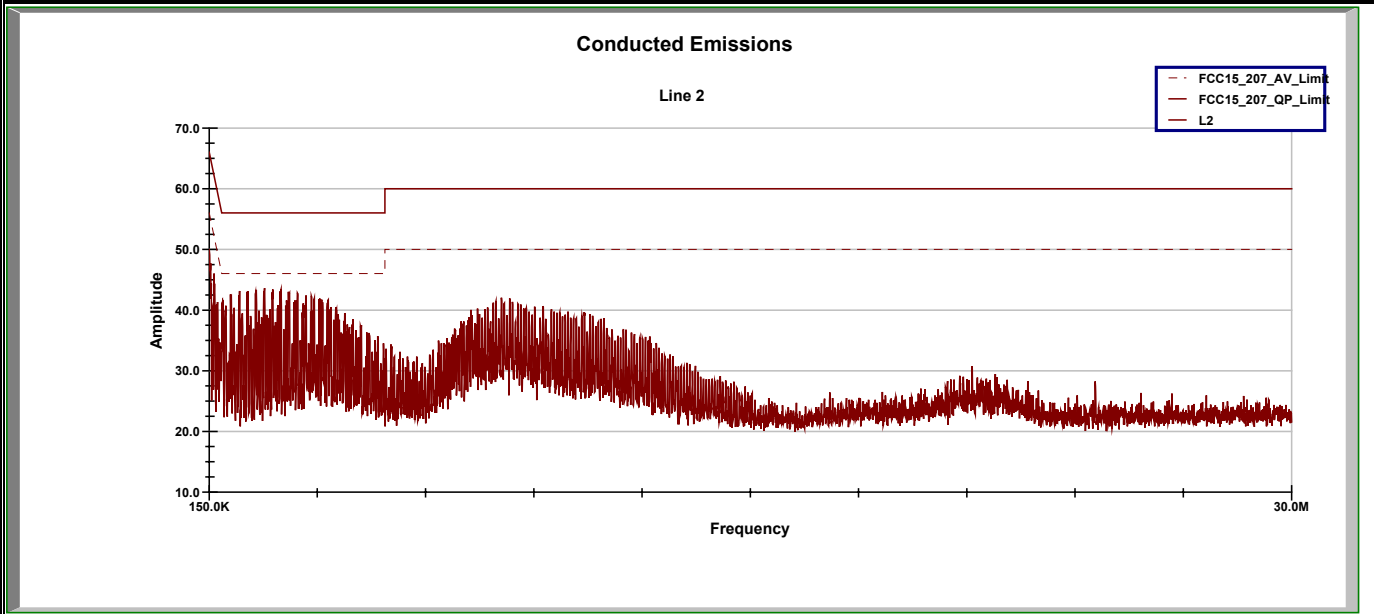

Project Number: 072804KBC-T543-E15B
Company: Itronix
Product: IX260+ with Cirronet BT2022 Bluetooth

Standard: FCC 15.207
Test Start Date: 14-Oct-04
Test End Date: 14-Oct-04

Line 2 Conducted Emissions

Frequency MHz	Uncorrected Reading			Correction Factor dB	Corrected Emission Level			Quasi-Peak Limit dBuV	Quasi-Peak Margin dB	Average Limit dBuV	Average Margin dB	Pass/Fail
	Peak dBuV	Quasi-Peak dBuV	Average dBuV		Peak dBuV	Quasi-Peak dBuV	Average dBuV					
0.193	48.10	44.67	28.79	1.51	49.61	46.18	30.30	63.91	17.72	53.91	23.61	Pass
0.284	42.00	38.75	19.10	0.89	42.89	39.64	20.00	60.71	21.06	50.71	30.71	Pass
1.670	43.20	42.67	42.72	0.30	43.50	42.97	43.02	56.00	13.03	46.00	2.98	Pass
1.900	43.40	42.75	42.79	0.29	43.69	43.04	43.09	56.00	12.96	46.00	2.91	Pass
8.209	41.90	40.79	37.84	0.33	42.23	41.12	38.17	60.00	18.88	50.00	11.83	Pass
8.437	41.90	40.93	38.24	0.33	42.23	41.26	38.57	60.00	18.74	50.00	11.43	Pass
10.488	39.90	38.66	35.90	0.33	40.23	38.99	36.24	60.00	21.01	50.00	13.77	Pass
21.024	31.50	27.26	22.42	0.99	32.49	28.25	23.41	60.00	31.75	50.00	26.59	Pass

Calculations

CF = Correction Factor
 Emission Level = Measured Level + correction factor
 Margin = Limit – Emission Level

Applicant:	Itronix Corporation	Model:	IX260PLUSNL305	FCC ID:	KBCIX260PLUSNL305
Rugged Laptop PC with internal Senao NL-3054MP WLAN (802.11b/g) and internal surface-mount antenna					
2004 Celltech Labs Inc. This document is not to be reproduced in whole or in part without the written permission of Celltech Labs Inc.					47 of 49

Test Report S/N:	100504KBC-T562-E15W	
Test Date(s):	25Oct04 - 05Nov04	
Test Type(s):	FCC §15.247	IC RSS-210 Issue 5
Lab Registration(s):	FCC #714830	IC Lab File #3874

H.10. PASS/FAIL

In reference to the results outlined in H.9 the DUT passes the requirements as stated in the reference standards as follows:
The RF voltage measured in reference to ground on each of the power line conductors does not exceed the limits as outline in FCC 15.207.

H.11. SIGN-OFF

I attest to the accuracy of the data. All measurements reported herein were performed by me and are correct to the best of my knowledge and belief. I assume full responsibility for the completeness of these measurements.



Russell Pipe
Senior Compliance Technologist
Celltech Labs Inc.

05Aug04

Date

Applicant:	Itronix Corporation	Model:	IX260PLUSNL305	FCC ID:	KBCIX260PLUSNL305
Rugged Laptop PC with internal Senao NL-3054MP WLAN (802.11b/g) and internal surface-mount antenna					
2004 Celltech Labs Inc. This document is not to be reproduced in whole or in part without the written permission of Celltech Labs Inc.					48 of 49

Test Report S/N:	100504KBC-T562-E15W	
Test Date(s):	25Oct04 - 05Nov04	
Test Type(s):	FCC §15.247	IC RSS-210 Issue 5
Lab Registration(s):	FCC #714830	IC Lab File #3874

END OF DOCUMENT

Applicant:	Itronix Corporation	Model:	IX260PLUSNL305	FCC ID:	KBCIX260PLUSNL305
Rugged Laptop PC with internal Senao NL-3054MP WLAN (802.11b/g) and internal surface-mount antenna					
2004 Celltech Labs Inc. This document is not to be reproduced in whole or in part without the written permission of Celltech Labs Inc.					49 of 49