

8 Frequency Stability Versus Temperature

FCC 2.1055

8.1 Summary of Results

The AC755 Frequency Stability versus temperature meets the requirement of being within ± 0.1 ppm of the received base station frequency.

8.2 Test Procedure

The AC755 was placed inside the temperature chamber. The transmitting frequency error is measured at 25 degrees C, then the temperature is set to +60 degrees C and allowed to stabilize. After sufficient soak time, the transmitting frequency error is measured. The temperature is decreased by 10 degrees, allowed to stabilize and soak, then the measurement is repeated. This is repeated until -20 degrees C is completed. The process is then repeated back up to +60 degrees C. Frequency metering included internal averaging of the CMU200 to stabilize the reading. Reference power supply voltage for these tests is 5.0 volts.

Test Setup

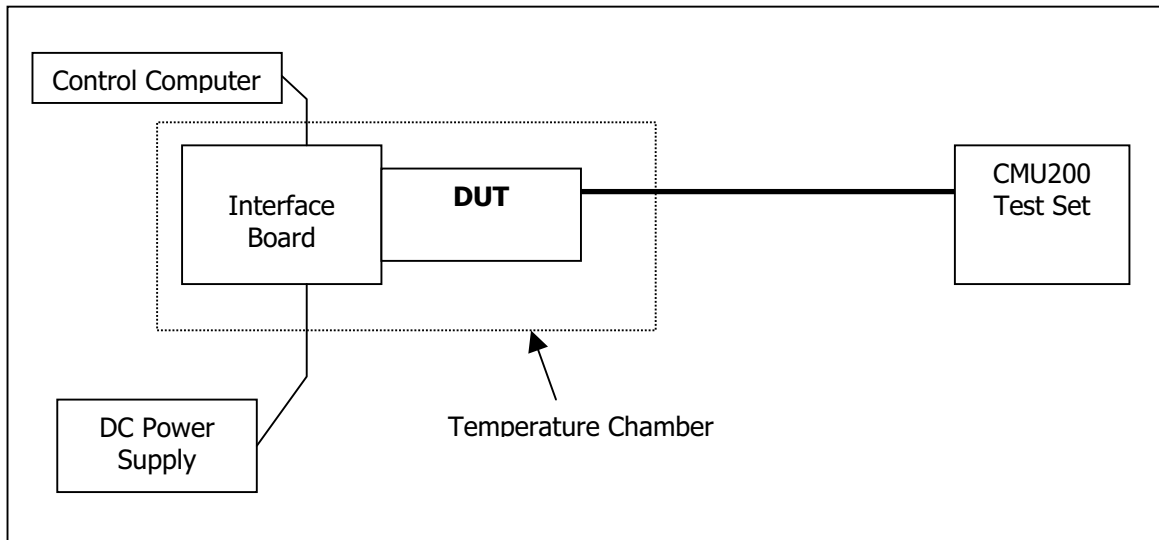

8.3 Test Equipment

EQUIPMENT	MANUFACTURER	MODEL NO.	SERIAL NO.	CAL. DATE
Control Computer	TC	Generic PC	100488	N/A
Wireless Test Set	Rohde & Schwarz	CMU200	836766/030	N/A
Spectrum Analyzer	Rohde & Schwarz	FSP 30GHz	US41421268	Sept. 12, 2003
DC Power Supply	HP	E3631A	100060	N/A
Interface Board	Shop built	Minnow	N/A	N/A

8.4 Test Results

High to Low Temperature Frequency Error

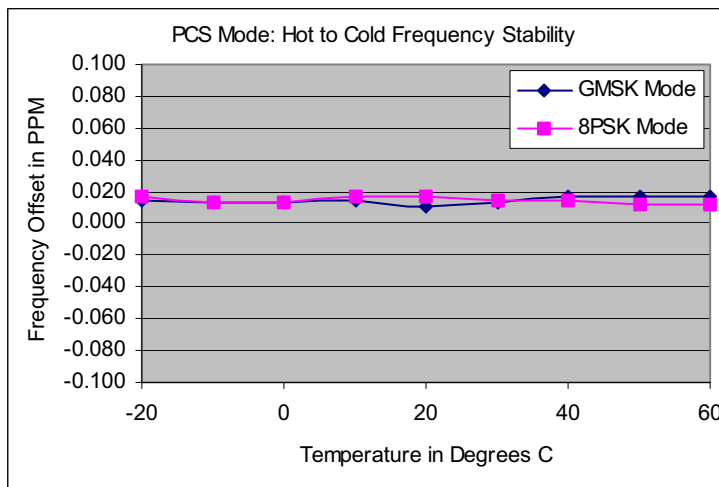
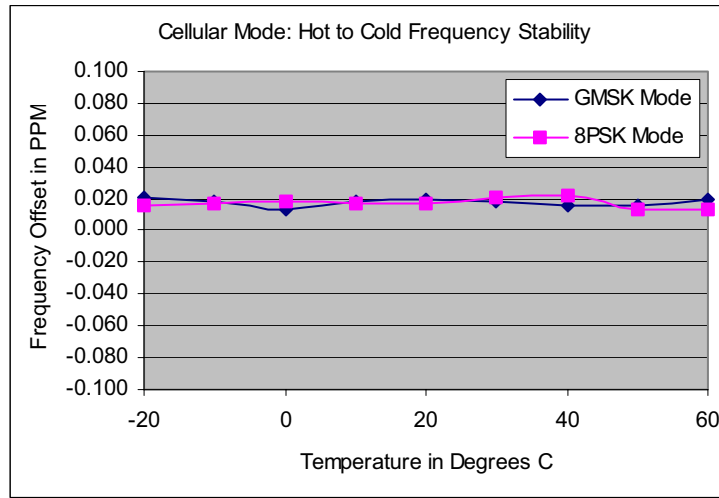

High to Low Temperature Tabular Readings

Temp.(C)	Cellular Mode: 824MHz to 848MHz				PCS Mode: 1850MHz to 1909MHz			
	GMSK Mode		8-PSK Mode		GMSK Mode		8-PSK Mode	
	Offset (Hz)	Offset (ppm)	Offset (Hz)	Offset (ppm)	Offset (Hz)	Offset (ppm)	Offset (Hz)	Offset (ppm)
60	16	0.019	11	0.013	24	0.013	27	0.014
50	13	0.016	11	0.013	21	0.011	32	0.017
40	13	0.016	18	0.022	22	0.012	21	0.011
30	15	0.018	17	0.020	30	0.016	21	0.011
20	16	0.019	14	0.017	25	0.013	23	0.012
10	15	0.018	14	0.017	26	0.014	27	0.014
0	11	0.013	15	0.018	21	0.011	26	0.014
-10	15	0.018	14	0.017	21	0.011	34	0.018
-20	17	0.020	13	0.016	28	0.015	33	0.018

SIERRA WIRELESS, INC.

Low to High Temperature Frequency Error

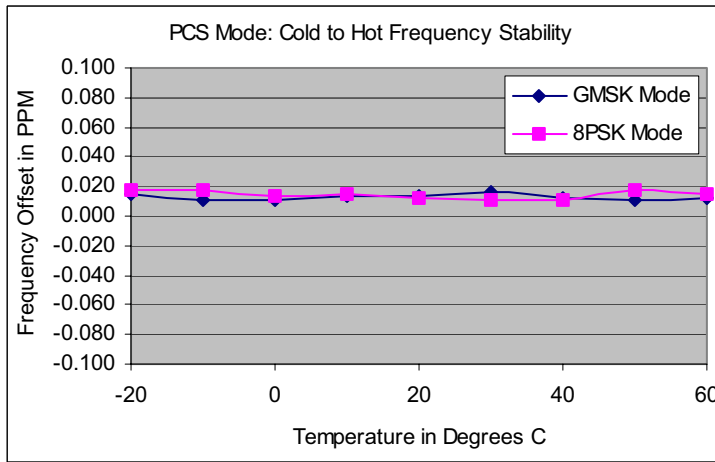
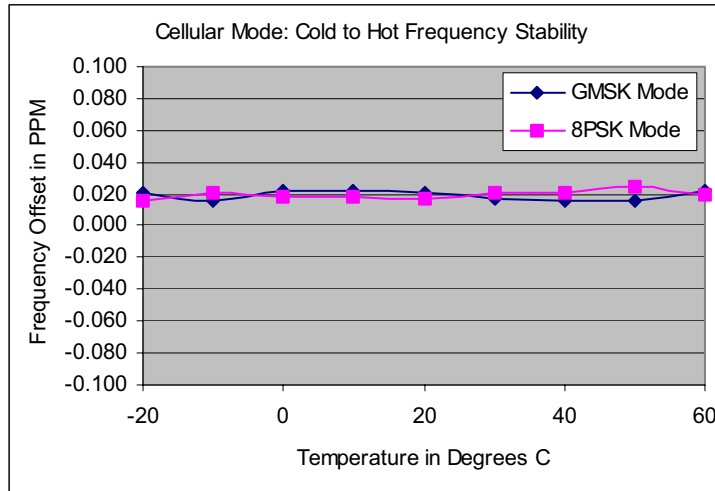

Low to High Temperature Tabular Readings

Temp.(C)	Cellular Mode: 824MHz to 848MHz				PCS Mode: 1850MHz to 1909MHz			
	GMSK Mode		8-PSK Mode		GMSK Mode		8-PSK Mode	
	Offset (Hz)	Offset (ppm)	Offset (Hz)	Offset (ppm)	Offset (Hz)	Offset (ppm)	Offset (Hz)	Offset (ppm)
-20	17	0.020	13	0.016	28	0.015	33	0.018
-10	13	0.016	17	0.020	25	0.013	24	0.013
0	18	0.022	15	0.018	25	0.013	24	0.013
10	18	0.022	15	0.018	28	0.015	33	0.018
20	17	0.020	14	0.017	20	0.011	31	0.016
30	14	0.017	17	0.020	25	0.013	28	0.015
40	13	0.016	17	0.020	33	0.018	28	0.015
50	13	0.016	21	0.025	33	0.018	23	0.012
60	18	0.022	16	0.019	31	0.016	22	0.012

9 Frequency Stability Versus Voltage

FCC 2.1055

9.1 Summary of Results

The unit meets the limit of less than 0.1ppm of frequency offset from center for 85% and 115% of the supply voltage for 5.0 volts.

9.2 Test Procedure

The AC755 was connected to a DC Power Supply and a GSM test set (CMU 200) with frequency error measurement capability. The power supply output is adjusted to the test voltage as measured at the input terminals to the module while transmitting. A voltmeter was used to confirm the terminal voltage. The peak frequency error is recorded (worst case).

The test voltages are 4.25 volts to 5.75 volts.

Test Setup

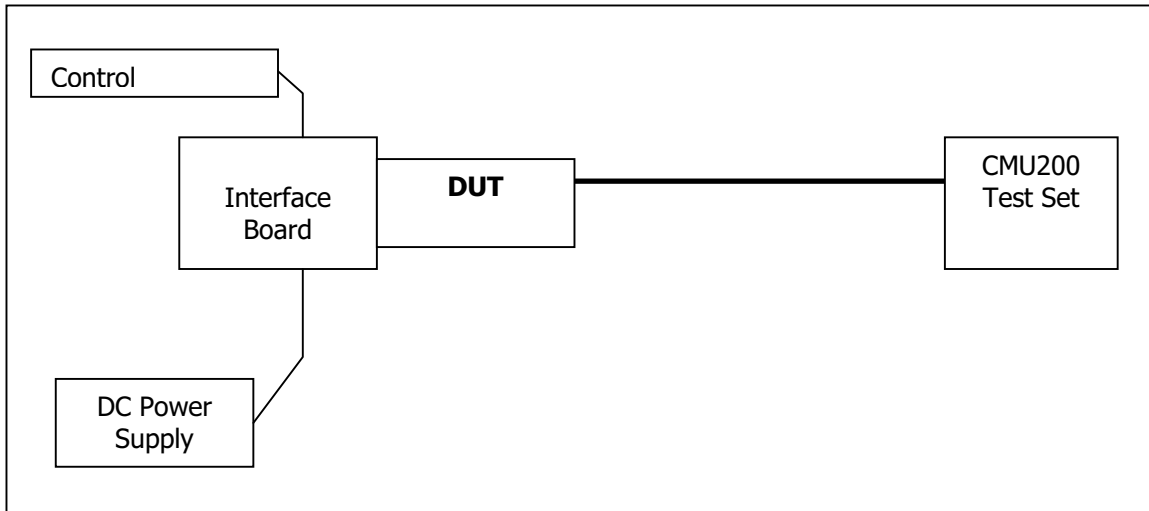

9.3 Test Equipment

EQUIPMENT	MANUFACTURER	MODEL NO.	SERIAL NO.	CAL. DATE
Control Computer	TC	Generic PC	100488	N/A
Wireless Test Set	Rohde & Schwarz	CMU200	836766/030	N/A
Spectrum Analyzer	Rohde & Schwarz	FSP 30GHz	US41421268	Sept. 12, 2003
DC Power Supply	HP	E3631A	100060	N/A
Interface Board	Shop built	Minnow	N/A	N/A

9.4 Test Results

85% to 115% of 5 Volts Frequency Error

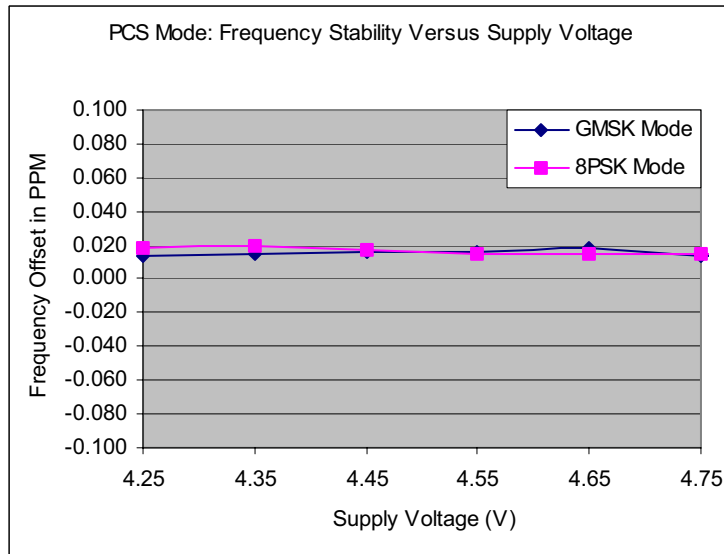
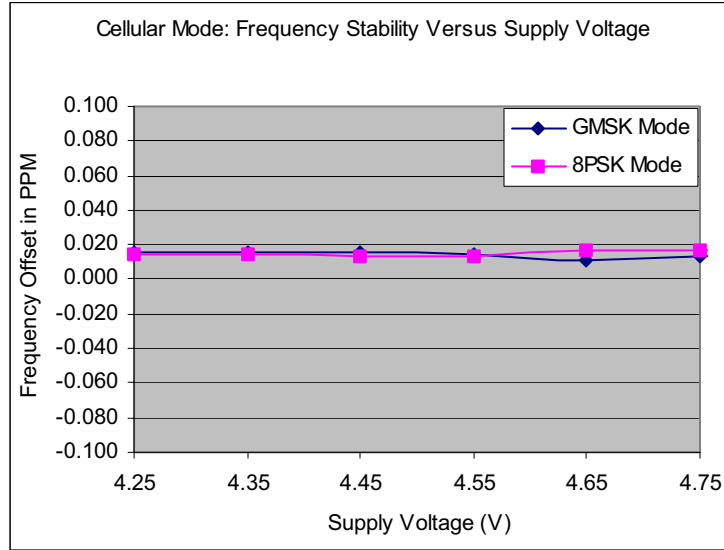

SIERRA WIRELESS, INC.

85% to 115% of 5 Volts Frequency Error, Tabular Data

Supply (V)	Cellular Mode: 824MHz to 848MHz				PCS Mode: 1850MHz to 1909MHz			
	GMSK Mode		8-PSK Mode		GMSK Mode		8-PSK Mode	
	Offset (Hz)	Offset (ppm)	Offset (Hz)	Offset (ppm)	Offset (Hz)	Offset (ppm)	Offset (Hz)	Offset (ppm)
4.25	13	0.016	12	0.014	26	0.014	34	0.018
4.35	13	0.016	12	0.014	28	0.015	37	0.020
4.45	13	0.016	11	0.013	31	0.016	33	0.018
4.55	12	0.014	11	0.013	31	0.016	28	0.015
4.65	9	0.011	14	0.017	34	0.018	27	0.014
4.75	11	0.013	14	0.017	26	0.014	27	0.014
4.85	13	0.016	13	0.016	25	0.013	28	0.015
4.95	13	0.016	13	0.016	24	0.013	29	0.015
5.05	12	0.014	13	0.016	27	0.014	31	0.016
5.15	12	0.014	10	0.012	28	0.015	31	0.016
5.25	12	0.014	9	0.011	27	0.014	30	0.016
5.35	12	0.014	9	0.011	29	0.015	31	0.016
5.45	14	0.017	12	0.014	31	0.016	31	0.016
5.55	14	0.017	13	0.016	31	0.016	24	0.013
5.65	13	0.016	11	0.013	28	0.015	25	0.013
5.75	12	0.014	11	0.013	24	0.013	27	0.014