

Test Report Serial No.:	050405KBC-T635-E24C/E15B	Issue 1
Test Date(s):	30th March - 19th April, 2005	
Test Type(s):	FCC §2, §15.247, §22H, §24E	IC RSS-210/132/133
Lab Registration(s):	FCC #714830	IC Lab File #3874

SUPPLEMENTARY EMC TEST REPORT
FOR THE
ITRONIX RUGGED LAPTOP PC MODEL: IX260P-AC580BT
WITH THE
INTERNAL CIRRONET BT2022 BLUETOOTH TRANSMITTER
UTILIZING THE
INTERNAL RANGESTAR SURFACE-MOUNT ANTENNA
(INSTALLED IN THE UPPER LEFT SIDE EDGE OF LCD DISPLAY)
CO-TRANSMITTING WITH THE
SIERRA WIRELESS AIRCARD 580 DUAL-BAND CDMA PCMCIA MODEM
UTILIZING THE
EXTERNAL SWIVEL DIPOLE ANTENNA

TRSN 050405KBC-T635-E24C/E15B
Issue 1.0

Celltech Compliance Testing & Engineering Lab
(Celltech Labs Inc.)
1955 Moss Court
Kelowna, BC
Canada
V1Y 9L3

May 13, 2005

Test Report Serial No.:	050405KBC-T635-E24C/E15B	Issue 1
Test Date(s):	30th March - 19th April, 2005	
Test Type(s):	FCC §2, §15.247, §22H, §24E	IC RSS-210/132/133
Lab Registration(s):	FCC #714830	IC Lab File #3874

DECLARATION OF COMPLIANCE

Test Lab		CELLTECH LABS INC. Testing and Engineering Services 1955 Moss Court Kelowna, B.C. Canada V1Y 9L3 Phone: 250-448-7047 Fax: 250-448-7048 e-mail: info@celltechlabs.com web site: www.celltechlabs.com		Applicant Information		ITRONIX CORPORATION 801 South Stevens Street Spokane, WA 99204 United States	
Laboratory Registration No.(s):		FCC:	714830	IC:	IC 3874		
Rule Part(s):		FCC:	Dual Band CDMA	§2; §22H; §24E			
			Bluetooth - FHSS	§15.247; §2.1091; §1.1310			
Device Classification:		FCC:	Dual Band CDMA	- PCS Licensed Transmitter (PCB)			
			Bluetooth - FHSS	- Part 15 Spread Spectrum Transmitter (DSS)			
Device Identification:		FCC ID:	KBCIX260P-AC580BT	IC ID:	1943A-IX260Pf		
DUT Description:							
Model:		IX260P-AC580BT					
Device Description:		Rugged Laptop PC with internal co-located transmitters (simultaneous transmit)					
Internal Transmitter(s):		Sierra Wireless AirCard 580 Dual-Band PCS/Cellular CDMA PCMCIA Modem Cirronet BT2022 Bluetooth					
Tx Frequency Range(s):		CDMA	Cellular	824.70 - 848.31 MHz			
			PCS	1851.25 - 1908.75 MHz			
		Bluetooth	FHSS	2402 - 2480 MHz			
Max. RF Output Power:		Bluetooth	FHSS	+15.41 dBm	0.0348 Watts	Peak Conducted	
		CDMA	Cellular	+23.58 dBm	0.228 Watts	Conducted	
			PCS	+25.01 dBm	0.317 Watts	Conducted	
Modulation Type(s):		Bluetooth	GFSK 1 Mbps 0.5 BT Gaussian				
		CDMA	QPSK				
Antenna Type(s):		Bluetooth	RangeStar P/N: 100929 Internal Surface-Mount (upper left side rear of LCD display)				
		CDMA	Itronix IX260+ External Swivel Dipole (upper right side edge of LCD display)				
Power Source(s):		90 Watt AC Power Adapter (Model: ADP-90AB)					
		11.1 V Lithium-ion Battery, 6.0 Ah (Model: A2121-2)					
		12 V Vehicle Battery (for Vehicle Cradle)					

This wireless mobile device has demonstrated compliance with the applicable technical standards as indicated in the measurement report and was tested in accordance with the measurement procedures specified in FCC 47 CFR Parts 2, 15.247, 22H, 24E, Industry Canada RSS 133 Issue 2 Revision 1, RSS-132 Issue 1 (Provisional), RSS-210 Issue 5; and ANSI TIA/EIA-603-C-2004.

I attest to the accuracy of the data. All measurements reported herein were performed by me or were under my supervision and are correct to the best of my knowledge and belief. I assume full responsibility for the completeness of these measurements and vouch for the qualifications of all persons taking them.

This test report shall not be reproduced partially, or in full, without the prior written approval of Celltech Labs Inc. The results and statements contained in this report pertain only to the device(s) evaluated.



Russell Pipe
Senior Compliance Technologist
Celltech Labs Inc.



Duane M. Friesen
EMC Manager
Celltech Labs Inc.



Applicant:	Itronix Corporation	Model:	IX260P-AC580BT	FCC ID:	KBCIX260P-AC580BT	IC ID:	1943A-IX260Pf
Rugged Laptop PC with Sierra Wireless AirCard 580 Dual-Band CDMA Modem and Cirronet BT2022 Bluetooth							
2005 Celltech Labs Inc. This document is not to be reproduced in whole or in part without the written permission of Celltech Labs Inc.							2 of 51

Test Report Serial No.:	050405KBC-T635-E24C/E15B	Issue 1
Test Date(s):	30th March - 19th April, 2005	
Test Type(s):	FCC §2, §15.247, §22H, §24E	IC RSS-210/132/133
Lab Registration(s):	FCC #714830	IC Lab File #3874

TABLE OF CONTENTS

1.0 SCOPE	7
2.0 REFERENCES	8
2.1 Normative References	8
3.0 TERMS AND DEFINITIONS	9
4.0 FACILITIES AND ACCREDITATIONS	10
5.0 GENERAL INFORMATION	10
5.1 Applicant Information	10
5.2 DUT Description	10
5.3 Co-Located Equipment	11
5.4 Cable Descriptions	12
5.5 Support Equipment	12
5.6 Clock Frequencies	13
5.7 Mode(s) of Operation Tested	13
5.8 Configuration Description	15
6.0 PASS/FAIL CRITERIA	15
APPENDICES	16
Appendix A - Photographs	17
Appendix B - CDMA Conducted RF Output Power Measurement	19
Appendix C - Cellular Effective Radiated Power Measurement	22
Appendix D - Cellular Radiated Spurious Emissions Measurement	27
Appendix E - Effective Isotropic Radiated Power Measurement	33
Appendix F - PCS Radiated Spurious Emissions Measurement	38
Appendix G - Maximum Permissible Exposure Calculation	44
Appendix H - Bluetooth Conducted RF Output Power Measurement	48
END OF DOCUMENT	51

Test Report Serial No.:	050405KBC-T635-E24C/E15B	Issue 1
Test Date(s):	30th March - 19th April, 2005	
Test Type(s):	FCC §2, §15.247, §22H, §24E	IC RSS-210/132/133
Lab Registration(s):	FCC #714830	IC Lab File #3874

FIGURES

Figure B.6-1 - Setup Drawing	20
Figure C.6-1 - Field Strength Setup Drawing	23
Figure C.6-2 - Signal Substitution Setup Drawing	23
Figure D.6-1 - Field Strength Setup Drawing	29
Figure D.6-2 - Signal Substitution Setup Drawing	29
Figure E.6-1 - Field Strength Setup Drawing	34
Figure E.6-2 - Substitution Setup Drawing	34
Figure F.6-1 - Field Strength Setup Drawing	40
Figure F.6-2 - Signal Substitution Setup Drawing	40
Figure H.6-1 - Setup Drawing	49

PHOTOGRAPHS

Photograph A.1-1 - Open IX260+ Laptop PC - front	17
Photograph A.1-2 - Open IX260+ Laptop PC - side	17
Photograph A.1-3 - Bluetooth Location	17
Photograph A.1-4 - Bluetooth Transmitter	17
Photograph A.1-5 - CDMA and Bluetooth Antenna Locations	18
Photograph A.1-6 - AirCard 580 CDMA Modem	18
Photograph A.1-7 - CDMA Modem installed in PC	18
Photograph A.1-8 - Dual-Band CDMA PCMCIA Modem Card	18
Photograph C.7-1 - Horizontal Bilog Receive Antenna with DUT	24
Photograph C.7-2 - Front of Radiated Emission Setup	24
Photograph C.7-3 - Back of Radiated Emission Setup	24
Photograph D.7-1 - Horizontal 3115 Horn & LNA with DUT	30
Photograph D.7-2 - Vertical 3115 Horn & LNA with DUT	30
Photograph D.7-3 - Front of Radiated Emission Setup	30
Photograph D.7-4 - Back of Radiated Emission Setup	30
Photograph E.7-1 - Horizontal Horn Receive Antenna with DUT	35
Photograph E.7-2 - Vertical Horn Receive Antenna with DUT	35
Photograph E.7-3 - Front of Radiated Emission Setup	35
Photograph E.7-4 - Back of Radiated Emission Setup	35
Photograph F.7-1 - Horizontal 3115 Horn & LNA with DUT	41
Photograph F.7-2 - Vertical 3115 Horn & LNA with DUT	41
Photograph F.7-3 - Front of Radiated Emission Setup	41
Photograph F.7-4 - Back of Radiated Emission Setup	41

Test Report Serial No.:	050405KBC-T635-E24C/E15B	Issue 1
Test Date(s):	30th March - 19th April, 2005	
Test Type(s):	FCC §2, §15.247, §22H, §24E	IC RSS-210/132/133
Lab Registration(s):	FCC #714830	IC Lab File #3874

TEST SUMMARY

Referenced Standard: FCC CFR Title 47 Part 2, 15C, 22H

Appendix	Test Description	Procedure Reference	Limit Reference	Test Start Date	Test End Date	Result
B	Conducted RF Output Power	ANSI/TIA/EIA-603-C, §2.1046 (a)	none	30Mar05	30Mar05	Pass
C	Effective Radiated Power	ANSI/TIA/EIA-603-C	§22.913 (a)	11Apr05	11Apr05	Pass
D	Radiated Spurious Emissions	ANSI/TIA/EIA-603-C, §2.1053, §22.917 (b)	§22.917 (a)	1Apr05	19Apr05	Pass
G	Maximum Permissible Exposure	FCC CFR 47 § 2.1091 IEEE Std C95.1-1999	FCC CFR 47 §1.1310 Table 1 (b)	na	na	Pass
H	Bluetooth Peak Conducted RF Output Power	FCC 97-114	§15.247(b) (3)	30Mar05	30Mar05	Pass

Referenced Standard: FCC CFR Title 47 Part 2, 15C, 24E

B	Conducted RF Output Power	ANSI/TIA/EIA-603-C	§24.232(b)	30Mar05	30Mar05	Pass
E	Effective Isotropic Radiated Power	ANSI/TIA/EIA-603-C	§24.232(b)	11Apr05	11Apr05	Pass
F	Radiated Spurious Emissions	ANSI/TIA/EIA-603-C, §2.1053, §24.238 (b)	§24.238(a)	1Apr05	19Apr05	Pass
G	Maximum Permissible Exposure	FCC CFR 47 § 2.1091 IEEE Std C95.1-1999	FCC CFR 47 §1.1310 Table 1 (b)	na	na	Pass
H	Bluetooth Peak Conducted RF Output Power	ANSI/TIA/EIA-603-C FCC 97-114, §2.1046 (a)	§15.247(b) (3)	30Mar05	30Mar05	Pass

Referenced Standard: IC RSS-132

B	Conducted RF Output Power	ANSI/TIA/EIA-603-C, SRSP-503 §5.1.3	SRSP-503 §5.1.3, §4.4	30Mar05	30Mar05	Pass
C	Effective Radiated Power	ANSI/TIA/EIA-603-C, SRSP-503 §5.1.3	SRSP-503 §5.1.3, §4.4	11Apr05	11Apr05	Pass
D	Radiated Spurious Emissions	ANSI/TIA/EIA-603-C	§4.5	1Apr05	19Apr05	Pass
G	Maximum Permissible Exposure	FCC CFR 47 § 2.1091 IEEE Std C95.1-1999	FCC CFR 47 §1.1310 Table 1 (b)	na	na	Pass
H	Bluetooth Peak Conducted RF Output Power	RSS-210 § 10	RSS-210 A1 §(I)(iv) RSS-210 §6.2.2 (o)(b)	30Mar05	30Mar05	Pass

Referenced Standard: IC RSS-133

B	Conducted RF Output Power	ANSI/TIA/EIA-603-C	§6.2	30Mar05	30Mar05	Pass
E	Effective Isotropic Radiated Power	ANSI/TIA/EIA-603-C	§6.2	11Apr05	11Apr05	Pass
F	Radiated Spurious Emissions	ANSI/TIA/EIA-603-C	§6.3	1Apr05	19Apr05	Pass
G	Maximum Permissible Exposure	FCC CFR 47 § 2.1091 IEEE Std C95.1-1999	FCC CFR 47 §1.1310 Table 1 (b)	na	na	Pass
H	Bluetooth Peak Conducted RF Output Power	RSS-210 § 10	RSS-210 A1 §(I)(iv) RSS-210 §6.2.2 (o)(b)	30Mar05	30Mar05	Pass



Applicant:	Itronix Corporation	Model:	IX260P-AC580BT	FCC ID:	KBCIX260P-AC580BT	IC ID:	1943A-IX260Pf
Rugged Laptop PC with Sierra Wireless AirCard 580 Dual-Band CDMA Modem and Cirronet BT2022 Bluetooth							
2005 Celltech Labs Inc. This document is not to be reproduced in whole or in part without the written permission of Celltech Labs Inc.							5 of 51

Test Report Serial No.:	050405KBC-T635-E24C/E15B	Issue 1
Test Date(s):	30th March - 19th April, 2005	
Test Type(s):	FCC §2, §15.247, §22H, §24E	IC RSS-210/132/133
Lab Registration(s):	FCC #714830	IC Lab File #3874

REVISION LOG

Issue	Description	Implemented By	Implementation Date
1.0	Initial Release	Jon Hughes	13May05

SIGNATORIES

Prepared By:		May 13, 2005
Name/Title	Duane M. Friesen, C.E.T. / EMC Manager	Date
Approved By:		May 13, 2005
Name/Title	Jon Hughes / General Manager	Date

Test Report Serial No.:	050405KBC-T635-E24C/E15B	Issue 1
Test Date(s):	30th March - 19th April, 2005	
Test Type(s):	FCC §2, §15.247, §22H, §24E	IC RSS-210/132/133
Lab Registration(s):	FCC #714830	IC Lab File #3874

1.0 SCOPE

This report outlines the measurements made and results collected during electromagnetic emissions testing of the Itronix Corporation Model: IX260P-AC580BT Rugged Laptop PC with internal Cirronet BT2022 Bluetooth Transmitter co-transmitting with the Sierra Wireless AirCard 580 Dual-Band CDMA PCMCIA Modem. The purpose of this investigation was to determine the co-transmitting effects such as inter-modulation products due to the transmitters transmitting simultaneously.

The Bluetooth transmitter was connected to an internal RangeStar surface-mount antenna installed at the top left side rear of the LCD display. The Dual-Band CDMA Modem was connected to an external swivel dipole antenna located on the upper right side edge of the LCD display. The Laptop PC also has the option of being mounted in a vehicle cradle, with the Dual-Band CDMA Modem utilizing a vehicle-mount antenna. Because of the large antenna separations and low Bluetooth power, the vehicle antenna option was not considered to be worst-case when investigating the co-transmitting effects, and therefore was not used in obtaining the data presented in this report.

The measurement results were applied against the applicable EMC requirements and limits outlined in the technical rules and regulations set forth for the dominant transmitter in the Federal Communication Commission Code of Federal Regulations Title 47 Part 2, Part 15 Subpart C, Part 22 Subpart H, and Part 24 Subpart E; and Industry Canada Radio Standards Specifications RSS-132 Issue 1 (Provisional) and RSS-133 Issue 2, RSS-210 Issue 5.

Applicant:	Itronix Corporation	Model:	IX260P-AC580BT	FCC ID:	KBCIX260P-AC580BT	IC ID:	1943A-IX260Pf
Rugged Laptop PC with Sierra Wireless AirCard 580 Dual-Band CDMA Modem and Cirronet BT2022 Bluetooth							
2005 Celltech Labs Inc. This document is not to be reproduced in whole or in part without the written permission of Celltech Labs Inc.							7 of 51

Test Report Serial No.:	050405KBC-T635-E24C/E15B	Issue 1
Test Date(s):	30th March - 19th April, 2005	
Test Type(s):	FCC §2, §15.247, §22H, §24E	IC RSS-210/132/133
Lab Registration(s):	FCC #714830	IC Lab File #3874

2.0 REFERENCES

2.1 Normative References

ANSI/ISO 17025:1999	General Requirements for competence of testing and calibration laboratories
IEEE/ANSI C63.4:2003	Methods of Measurement of Radio-Noise Emissions from Low-Voltage Electrical and Electronic Equipment in the Range of 9 kHz to 40 GHz
IEEE/ANSI Std C95.1:1999	American National Standard Safety Levels with Respect to Human Exposure to Radio Frequency Electromagnetic Fields
ANSI/TIA/EIA-603-C:2004	Land Mobile FM or PM Communication Equipment Measurement and Performance Standards
CFR Title 47 Part 2:2004	Code of Federal Regulations Title 47: Telecommunication Part 2: Frequency Allocations and Radio Treaty Matters; General Rules and Regulations Part 15: Radio Frequency Devices Part 22: Public Mobile Services Part 24: Personal Communication Services
IC Spectrum Management & Telecommunications Policy	Radio Standards Specification RSS-102 Issue 1 (Provisional) - Evaluation Procedure for Mobile and Portable Radio Transmitters with respect to Health Canada's Safety Code 6 for Exposure of Humans to Radio Frequency Fields RSS-132 Issue 1 (Provisional) - 800 MHz Cellular Telephones Employing New Technologies RSS-133 Issue 2, Revision 1 - Personal Communication Services RSS-210 Issue 5 - Low Power Licence-Exempt Radiocommunication Devices RSS-212 Issue 1 (Provisional) - Test Facilities & Test Methods for Radio Equipment
Celltech Labs Test Report	EMC Test Report For the Model: IX260P-AC580BT Rugged Laptop PC with Sierra Wireless Dual Band CDMA PCMCIA Modem utilizing an External Swivel Dipole Antenna or Vehicle Antenna Test Report Serial Number (TRSN) 022305KBC -T618-E24C Issue 1 Date: May 09, 2005
Celltech Labs Test Report	EMC Test Report For the Model: IX260P-AC580BT Rugged Laptop PC with Cirronet BT2022 Bluetooth Transmitter and Internal Antenna Test Report Serial Number (TRSN) 022305KBC -T618-E15B Issue 1 Date: May 09, 2005

Test Report Serial No.:	050405KBC-T635-E24C/E15B	Issue 1
Test Date(s):	30th March - 19th April, 2005	
Test Type(s):	FCC §2, §15.247, §22H, §24E	IC RSS-210/132/133
Lab Registration(s):	FCC #714830	IC Lab File #3874

3.0 TERMS AND DEFINITIONS

AVG	Average
BT	Bluetooth Transmitter
CDMA	Code Division Multiple Access
CFR	Code of Federal Regulations
dB	decibel
dBm	dB referenced to 1 mW
dBuV	dB referenced to 1 uV
DUT	Device under Test
dBc	dB down from carrier
EBW	Emission Bandwidth
EIRP	Effective Isotropic Radiated Power
ERP	Effective Radiated Power
EMC	Electromagnetic Compatibility
FCC	Federal Communication Commission
FHSS	Frequency Hopping Spread Spectrum
HP	Hewlett Packard
HPF	High Pass Filter
Hpol	Horizontal Polarization
Hz	Hertz
IC	Industry Canada
IX260+	Itronix Model IX260P-AC580BT Laptop PC
kHz	kilohertz
LNA	Low Noise Amplifier
m	meter
MHz	Megahertz
Mbps	megabits per second
na	not applicable
n/a	not available
PCS	Personal Communication System
PK	Peak
PPSD	Peak Power Spectral Density
QP	Quasi-peak
RBW	Resolution Bandwidth
R&S	Rohde & Schwarz
RSS	Radio Standard Specification
SA	Spectrum Analyzer
VBW	Video Bandwidth
Vpol	Vertical Polarization
WLAN	Wireless Local Area Network

Test Report Serial No.:	050405KBC-T635-E24C/E15B	Issue 1
Test Date(s):	30th March - 19th April, 2005	
Test Type(s):	FCC §2, §15.247, §22H, §24E	IC RSS-210/132/133
Lab Registration(s):	FCC #714830	IC Lab File #3874

4.0 FACILITIES AND ACCREDITATIONS

The facilities used in collecting the test results outlined in this report are located at 1955 Moss Court, Kelowna, British Columbia, Canada, V1Y 9L3. The radiated and conducted emissions sites conform with the requirements set forth in ANSI C63.4 and are filed and listed with the FCC under Registration Number 714830 and Industry Canada under File Number IC 3874.

5.0 GENERAL INFORMATION

5.1 Applicant Information

Company Name:	Itronix Corporation
Address:	801 South Stevens Street Spokane, WA 99204 United States

5.2 DUT Description

The DUT consisted of the IX260+ Rugged Laptop PC containing a Cirronet BT2022 Bluetooth Transmitter connected to an Internal Surface-Mount Antenna installed in the upper left side rear edge of the LCD display. Co-located in the IX260+ Rugged Laptop PC was a Sierra Wireless AirCard 580 Dual-Band CDMA PCMCIA Modem connected to an External Swivel Dipole Antenna located on the upper right side edge of the LCD display. The DUT has the option of being mounted in a vehicle cradle with the Dual-Band CDMA Modem utilizing a vehicle-mount antenna. The vehicle antenna option was not considered to be worst case, and therefore was not used in obtaining the data presented in this report. Photographs of the DUT placement and construction are shown in Appendix A.

Device:	Rugged Laptop PC			
Model:	IX260P-AC580BT			
Serial Number(s):	ZZGEG4196ZZ6480			
Identifier(s):	FCC ID:	KBCIX260P-AC580BT	IC ID:	1943A-IX260Pf
Power Source:	Delta Electronics Model ADP-90AB Rev B 90 Watt AC-DC power supply			

Device:	Dual-Band PCS/Cellular CDMA PCMCIA Modem			
Model:	Sierra Wireless AirCard 580			
Serial Number:	60209FB5			
Rule Part(s):	FCC:	§1.1310 Table 1(b); §2.1091; §22.913; §22.917; §24.232(b); §24.238		
	IC:	RSS-132 Issue 1 (Provisional); RSS-133 Issue 2		
Classification(s):	FCC:	PCS Licensed Transmitter (PCB)		
	IC:	800 MHz Cellular Telephones employing New Technologies (RSS-132) 2 GHz Personal Communication Services (RSS-133)		
Power Source:	Powered from the internal PC power supply			

Applicant:	Itronix Corporation	Model:	IX260P-AC580BT	FCC ID:	KBCIX260P-AC580BT	IC ID:	1943A-IX260Pf
Rugged Laptop PC with Sierra Wireless AirCard 580 Dual-Band CDMA Modem and Cirronet BT2022 Bluetooth							
2005 Celltech Labs Inc. This document is not to be reproduced in whole or in part without the written permission of Celltech Labs Inc.							10 of 51

Test Report Serial No.:	050405KBC-T635-E24C/E15B	Issue 1
Test Date(s):	30th March - 19th April, 2005	
Test Type(s):	FCC §2, §15.247, §22H, §24E	IC RSS-210/132/133
Lab Registration(s):	FCC #714830	IC Lab File #3874

Device:	2.4GHz FHSS Bluetooth Transmitter	
Model:	Cirronet BT2022	
Serial Number:	n/a	
Rule Part(s):	FCC:	§15.247; §2.1091; §1.1310
	IC:	RSS-210 Issue 5
Classification(s):	FCC:	Part 15 Spread Spectrum Transmitter (DSS)
	IC:	Low Power Licence-Exempt Radiocommunication Device
Power Source:	Powered from the internal PC power supply	

Name:	External Mounted Swivel Dipole Antenna (CDMA - upper right side edge of LCD display)	
Model:	IX260+	
Gain:	+2.6 dBi	

Device:	Internal Surface-Mount Antenna (Bluetooth - upper left side rear edge of the LCD display)	
Model:	RangeStar P/N: 100929	
Gain:	+ 4.5 dBi	

5.3 Co-Located Equipment

Name:	GPS Receiver Module with attached Antenna (Receive only)	
Model:	Leadtek P/N: GPS9547	

Test Report Serial No.:	050405KBC-T635-E24C/E15B	Issue 1
Test Date(s):	30th March - 19th April, 2005	
Test Type(s):	FCC §2, §15.247, §22H, §24E	IC RSS-210/132/133
Lab Registration(s):	FCC #714830	IC Lab File #3874

5.4 Cable Descriptions

ROUTING		Length m	Model	Terminations		Shield Type	Shield Termination		Suppression
From	To			End 1	End 2		End 1	End 2	
PC modem port	Unterminated	1.0	n/a	RJ-11	RJ-11	None	na	na	None
PC Ethernet Port	Ethernet Hub	1.0	n/a	RJ-45	RJ-45	None	na	na	None

5.5 Support Equipment

The following equipment was used in support of the DUT.

Co-located Support Equipment List		
Manufacturer	Model	Description
D-Link	DE-809TC/	Ethernet hub
YNG YUH	YP-040	Hub power supply
Polk Audio	n/a	Speakers
Polk Audio	n/a	Speaker-microphone
DeLorme	Tripmate	GPS Receiver
Intel	CS-430	Camera
Logitech	M-S34	Mouse

Test Report Serial No.:	050405KBC-T635-E24C/E15B	Issue 1
Test Date(s):	30th March - 19th April, 2005	
Test Type(s):	FCC §2, §15.247, §22H, §24E	IC RSS-210/132/133
Lab Registration(s):	FCC #714830	IC Lab File #3874

5.6 Clock Frequencies

5.6.1 DUT Clock Frequencies

Device:	Rugged Laptop PC
Clocks:	1.6 GHz processor
Device:	Dual-Band PCS/Cellular CDMA Modem
Clocks:	n/a
Device:	2.4GHz FHSS Cirronet Bluetooth Transmitter
Clocks:	n/a
Device:	Vehicle Cradle
Clocks:	None
Device:	External Swivel Dipole Antenna
Clocks:	None
Device:	Internal Surface-Mount Antenna
Clocks:	None
Device:	Vehicle-Mount Antenna
Clocks:	None

5.6.2 Co-Located Clock Frequencies

Device:	Peripherals
Clocks:	n/a

5.7 Mode(s) of Operation Tested

5.7.1 Dual-Band CDMA Modem

Customer supplied software was used to set the CDMA Modem to the appropriate channel and power level for the specific measurement or a CDMA test set was used to transmit a signal close to the DUT and initiate an "all ups" call on the appropriate channel. Measurements were made with the CDMA modem set to the low, mid, and high channels, in each band or on the worst-case channel (1013 or 25) for the measurement as required by the specific test. Worst-case co-transmitting conditions/channels were determined during prescan evaluations. The following settings were used for each channel.

5.7.1.1 Cellular CDMA

TX Frequency Range:	824.70 - 848.31 MHz Ch. 1013 (824.700 MHz) (low), Ch. 384 (836.52 MHz) (mid)& Ch. 777 (848.310 MHz) (high) measured unless otherwise noted
Software Power Gain Settings:	Set by manufacturer software or CDMA test set communications for "all ups"
Modulation Type(s):	QPSK

Test Report Serial No.:	050405KBC-T635-E24C/E15B	Issue 1
Test Date(s):	30th March - 19th April, 2005	
Test Type(s):	FCC §2, §15.247, §22H, §24E	IC RSS-210/132/133
Lab Registration(s):	FCC #714830	IC Lab File #3874

5.7.1.2 PCS CDMA

TX Frequency Range:	1851.25 - 1908.75 MHz Ch. 25 (1851.25 MHz) (low), Ch 600 (1880 MHz) (mid) & Ch. 1175 (1908.75 MHz) (high) measured unless otherwise noted
Software Power Gain Settings:	Set by manufacturer software or CDMA test set communications for "all ups"
Modulation Type(s):	QPSK

5.7.1.3 CDMA Modem Exercising Software Description

The DUT was configured and exercised during conducted testing using customer supplied test software, Directed Test Version 2.8, that allowed an operator to place the Dual-Band CDMA modem in an "all ups" mode. The modem manufacturer described this mode as one in which the modem transmitted at its maximum power level. For all radiated testing, the "all ups" mode was initiated with a call being connected with a CDMA test set through an antenna placed near the DUT.

5.7.2 Bluetooth Transmitter

Customer supplied software was used to set the Bluetooth transmitter to the appropriate channel and power level for the specific measurement. Measurements were made with the Bluetooth transmitter set to each of lowest, mid-band and highest channel or on the worst-case channel (78) for the measurement as required by the specific test. Worst-case co-transmitting conditions/channels were determined during prescan evaluations. The following settings were used for each channel.

TX Frequency Range:	2402 - 2480 MHz Ch. 0 (2402 MHz), Ch. 39 (2441 MHz) & Ch. 78 (2480 MHz) measured unless otherwise noted)
Software Power Gain Settings:	Ch. 0 - 220/45 Ch. 39 - 220/45 Ch. 78 - 220/45
Modulation Type(s):	GFSK 0.5 BT Gaussian
Modulation Frequency:	1000

5.7.3 Bluetooth Exercising Software Description

The DUT was configured and exercised using customer supplied Blue Core 01 test software that allowed an operator to set the parameters of the Bluetooth transmitter operation.

Test Report Serial No.:	050405KBC-T635-E24C/E15B	Issue 1
Test Date(s):	30th March - 19th April, 2005	
Test Type(s):	FCC §2, §15.247, §22H, §24E	IC RSS-210/132/133
Lab Registration(s):	FCC #714830	IC Lab File #3874

5.8 Configuration Description

The DUT was configured, as described by the client as being representative of what would be delivered to a final customer. Because the swivel dipole antenna orientation could be user configured, prescan evaluations were made to determine the configuration that resulted in the highest spurious emissions. A “horizontal, pointing back” orientation was used for the both cellular and PCS bands. More specific details may be included in each appendix.

5.8.1 Configuration Justification

The DUT was tested in a configuration described by the client as being worst-case but typical of normal use. The system is available for use while installed in a vehicle cradle, utilizing a vehicle-mounted dipole antenna and the resulting measurements using this configuration were investigated and reported in the single transmitting report. Given that the vehicle antenna is a greater distance from the co-transmit antenna and has a lower dominant transmit power than the swivel dipole antenna, only the worst-case configuration using the swivel dipole antenna was used to investigate the co-transmission effects reported herein.

6.0 PASS/FAIL CRITERIA

Unless otherwise noted in the Appendices, the pass/fail criteria is the limit set forth in the reference standards. A DUT is considered to have passed the requirements, if the data collected during the described measurement procedure is within the specified limits as defined. The pass/fail statements made in this report only apply to the unit tested.

Applicant:	Itronix Corporation	Model:	IX260P-AC580BT	FCC ID:	KBCIX260P-AC580BT	IC ID:	1943A-IX260Pf
Rugged Laptop PC with Sierra Wireless AirCard 580 Dual-Band CDMA Modem and Cirronet BT2022 Bluetooth							
2005 Celltech Labs Inc. This document is not to be reproduced in whole or in part without the written permission of Celltech Labs Inc.							15 of 51

Test Report Serial No.:	050405KBC-T635-E24C/E15B	Issue 1
Test Date(s):	30th March - 19th April, 2005	
Test Type(s):	FCC §2, §15.247, §22H, §24E	IC RSS-210/132/133
Lab Registration(s):	FCC #714830	IC Lab File #3874

APPENDICES

Applicant:	Itronix Corporation	Model:	IX260P-AC580BT	FCC ID:	KBCIX260P-AC580BT	IC ID:	1943A-IX260Pf
Rugged Laptop PC with Sierra Wireless AirCard 580 Dual-Band CDMA Modem and Cirronet BT2022 Bluetooth							
2005 Celltech Labs Inc. This document is not to be reproduced in whole or in part without the written permission of Celltech Labs Inc.							16 of 51

Test Report Serial No.:	050405KBC-T635-E24C/E15B	Issue 1
Test Date(s):	30th March - 19th April, 2005	
Test Type(s):	FCC §2, §15.247, §22H, §24E	IC RSS-210/132/133
Lab Registration(s):	FCC #714830	IC Lab File #3874

Appendix A - Photographs

A.1. DUT PHOTOGRAPHS

Photograph A.1-1 - Open IX260+ Laptop PC - front



Photograph A.1-2 - Open IX260+ Laptop PC - side





Photograph A.1-3 - Bluetooth Location

Bluetooth Transmitter Location

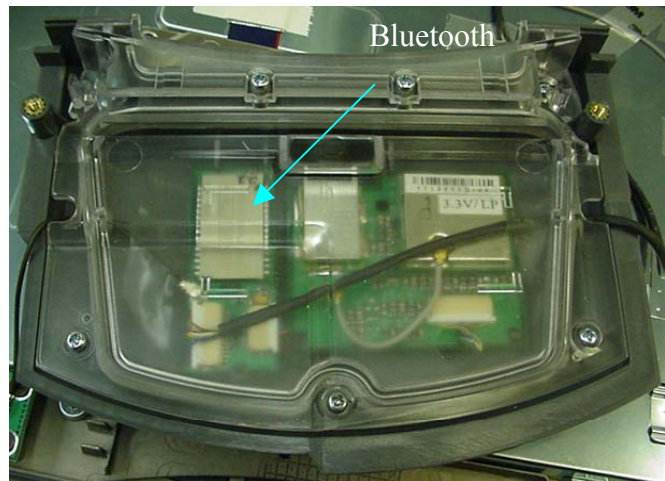

Photograph A.1-4 - Bluetooth Transmitter



Applicant:	Itronix Corporation	Model:	IX260P-AC580BT	FCC ID:	KBCIX260P-AC580BT	IC ID:	1943A-IX260Pf	
Rugged Laptop PC with Sierra Wireless AirCard 580 Dual-Band CDMA Modem and Cirronet BT2022 Bluetooth								
2005 Celltech Labs Inc. This document is not to be reproduced in whole or in part without the written permission of Celltech Labs Inc.							17 of 51	

Test Report Serial No.:	050405KBC-T635-E24C/E15B	Issue 1
Test Date(s):	30th March - 19th April, 2005	
Test Type(s):	FCC §2, §15.247, §22H, §24E	IC RSS-210/132/133
Lab Registration(s):	FCC #714830	IC Lab File #3874

Photograph A.1-5 - CDMA and Bluetooth Antenna Locations



Photograph A.1-6 - AirCard 580 CDMA Modem



Photograph A.1-7 - CDMA Modem installed in PC



Photograph A.1-8 - Dual-Band CDMA PCMCIA Modem Card



Applicant:	Itronix Corporation	Model:	IX260P-AC580BT	FCC ID:	KBCIX260P-AC580BT	IC ID:	1943A-IX260Pf	
Rugged Laptop PC with Sierra Wireless AirCard 580 Dual-Band CDMA Modem and Cirronet BT2022 Bluetooth								
2005 Celltech Labs Inc.		This document is not to be reproduced in whole or in part without the written permission of Celltech Labs Inc.					18 of 51	

Test Report Serial No.:	050405KBC-T635-E24C/E15B	Issue 1
Test Date(s):	30th March - 19th April, 2005	
Test Type(s):	FCC §2, §15.247, §22H, §24E	IC RSS-210/132/133
Lab Registration(s):	FCC #714830	IC Lab File #3874

Appendix B - CDMA Conducted RF Output Power Measurement

B.1. REFERENCES

Normative Reference Standard	None*
Procedure Reference	ANSI/TIA/EIA-603-C, §2.1046(a)

B.2. LIMITS

*Used for reference, no limit to apply. See Appendix C and E for application of the ERP/EIRP limits.

The single transmit RF conducted output power levels were reported as follows:

	<i>Channel</i>	<i>Frequency</i>	<i>Peak Conducted Power</i>
		<i>MHz</i>	<i>dBm</i>
<i>Cellular CDMA</i>	1013	824.70	+23.41
	384	836.52	+23.39
	777	848.31	+23.61
<i>PCS CDMA</i>	25	1851.25	+24.41
	600	1880.00	+25.07
	1175	1908.75	+24.62

*This is presented as a reference to determine the effects the co-transmission the Bluetooth transmitter made to the output RF power of the CDMA modem.

*ERP and EIRP limits are specified in Appendix C and E.

B.3. ENVIRONMENTAL CONDITIONS

Temperature	25.2 +/- 2 °C
Humidity	35 +/- 2 %
Barometric Pressure	96.34 kPa

B.4. EQUIPMENT LIST

ASSET NUMBER	MANUFACTURER	MODEL	DESCRIPTION	LAST CAL	CAL DUE
00008	Gigatronics	8652A	Power Meter	30Apr04	30Apr05
00011	Gigatronics	80701A	Power Sensor	08Oct04	08Oct05
00107	HP	8491C	Attenuator	n/a	n/a

*Cable and attenuator verified with power meter prior to use

Test Report Serial No.:	050405KBC-T635-E24C/E15B	Issue 1
Test Date(s):	30th March - 19th April, 2005	
Test Type(s):	FCC §2, §15.247, §22H, §24E	IC RSS-210/132/133
Lab Registration(s):	FCC #714830	IC Lab File #3874

B.5. MEASUREMENT EQUIPMENT SETUP

Measurement Equipment Connections	The equipment was connected as shown in the setup drawing in B.6.
Measurement Equipment Settings	Power Meter Settings: Mode - MAP Frequency compensation set for carrier frequency Offset set appropriately to compensate for any attenuator or cable losses
Measurement Procedure	The RF conducted power levels for both PCS and cellular bands were measured at the DUT antenna connector port using a Gigatronics 8652A Universal Power Meter in mean average power mode. An offset was entered into the power meter to correct for the losses of the attenuator and cable installed between the output port and the power sensor input. The DUT test software was used to set the CDMA to transmit in the CDMA "always up" power control mode and at the same time the Bluetooth transmitter was set to transmit at its max. power mode and channel.

B.6. SETUP DRAWING

Figure B.6-1 - Setup Drawing

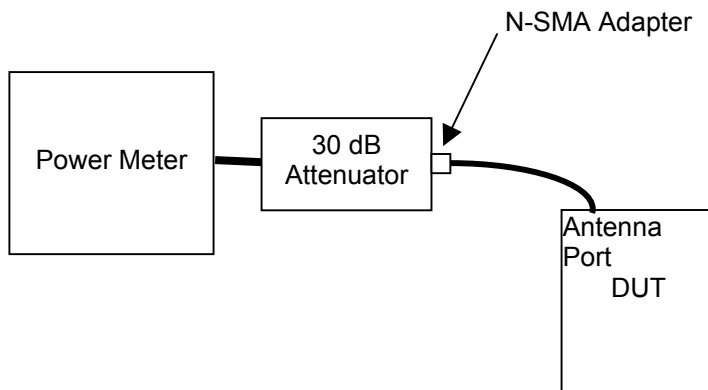

Test Report Serial No.:	050405KBC-T635-E24C/E15B	Issue 1
Test Date(s):	30th March - 19th April, 2005	
Test Type(s):	FCC §2, §15.247, §22H, §24E	IC RSS-210/132/133
Lab Registration(s):	FCC #714830	IC Lab File #3874

B.7. DUT OPERATING DESCRIPTION

Power measurements were made of each channel in both the cellular and PCS bands, with the CDMA modem and Bluetooth transmitter set appropriately as described in section 5.7. An exception to this setup was that the Bluetooth transmitter mode was set for "TXData1" which transmitted a data string, rather than a 1000 Hz tone.

B.8. TEST RESULTS

Mode	Channel	Frequency	Conducted Power
Cellular CDMA	1013	824.70 MHz	+23.32 dBm
	384	836.52 MHz	+23.38 dBm
	777	848.31 MHz	+23.58 dBm
PCS CDMA	25	1851.25 MHz	+24.40 dBm
	600	1880.00 MHz	+25.01 dBm
	1175	1908.75 MHz	+24.60 dBm

B.9. PASS/FAIL

There is no pass/fail criterion for this measurement. The ERP and EIRP levels applied to appropriate regulatory requirements are outlined in Appendix C and E. The most significant Cellular CDMA output power change was measured on Channel 1013, with the power dropping by 0.06 dB when the Bluetooth transmitter was set to transmit. The most significant PCS CDMA output power change was measured on Channel 600, with the power dropping by 0.09 dB when the Bluetooth transmitter was set to transmit on Channel 78.

B.10. SIGN-OFF

I attest to the accuracy of the data. All measurements reported herein were performed by me and are correct to the best of my knowledge and belief. I assume full responsibility for the completeness of these measurements.



Russell Pipe
Senior Compliance Technologist
Celltech Labs Inc.

30Mar05
Date

Applicant:	Itronix Corporation	Model:	IX260P-AC580BT	FCC ID:	KBCIX260P-AC580BT	IC ID:	1943A-IX260Pf
Rugged Laptop PC with Sierra Wireless AirCard 580 Dual-Band CDMA Modem and Cirronet BT2022 Bluetooth							
2005 Celltech Labs Inc. This document is not to be reproduced in whole or in part without the written permission of Celltech Labs Inc.							21 of 51

Test Report Serial No.:	050405KBC-T635-E24C/E15B	Issue 1
Test Date(s):	30th March - 19th April, 2005	
Test Type(s):	FCC §2, §15.247, §22H, §24E	IC RSS-210/132/133
Lab Registration(s):	FCC #714830	IC Lab File #3874

Appendix C - Cellular Effective Radiated Power Measurement

C.1. REFERENCES	
Normative Reference Standard	FCC CFR 47 §22.913 (a)
Procedure Reference	ANSI/TIA/EIA-603-C

C.2. LIMITS	
FCC CFR 47 §22.913	(a) Maximum ERP. The ERP of mobile transmitters and auxiliary transmitters must not exceed 7 Watts.

C.3. ENVIRONMENTAL CONDITIONS	
Temperature	27.4 +/- 2 °C
Humidity	33 +/- 2 %
Barometric Pressure	96.24 +/- 0.2 kPa

C.4. EQUIPMENT LIST						
RECEIVING EQUIPMENT						
ID	ASSET NUMBER	MANUFACTURER	MODEL	DESCRIPTION	LAST CAL	CAL DUE
1	00072	EMCO	2075	Mini-mast	na	na
2	00073	EMCO	2080	Turn Table	na	na
3	00071	EMCO	2090	Multi-Device Controller	na	na
4	00050	Chase	CBL-6111A	Bilog Antenna	08Feb05	08Feb06
5	00015	Agilent	E4408B	Spectrum Analyzer	24Jan05	24Jan06
6	00120	Celltech	n/a	Microwave Cable (RX)	25Mar05	25Mar06
7	00121	Andrew	FSJ4-50B	Microwave Cable (RX)	25Mar05	25Mar06
8	00130	Andrew	FSJ1-50A	Microwave Cable (RX)	25Mar05	25Mar06
ADDITIONAL SUBSTITUTION EQUIPMENT						
ID	ASSET NUMBER	MANUFACTURER	MODEL	DESCRIPTION	LAST CAL	CAL DUE
9	00059	ETS	3121C	Roberts Dipole	04Dec03	04Dec05
10	00131	Andrew	FSJ1-50A	Microwave Cable (TX)	na	na
11	00127	Andrew	FSJ4-50B	Microwave Cable (TX)	na	na
12	00131	Andrew	FSJ1-50A	Microwave Cable (TX)	na	na
13	00031	HP	E8285A	CDMA Test set	na	na
14	00007	Gigatronics	8652A	Power Meter	18Oct04	18Oct05
15	00011	Gigatronics	80701A	Power Sensor	08Ocr04	08Oct05
16	00013	Gigatronics	80701A	Power Sensor	11Oct04	11Oct05
17	00102	Pasternack	PE7015-3110	30 dB attenuator	na*	na*
18	00114	Amplifier Research	DC7154	Directional Coupler	na*	na*

*Attenuation offset in power meter setup

Applicant:	Itronix Corporation	Model:	IX260P-AC580BT	FCC ID:	KBCIX260P-AC580BT	IC ID:	1943A-IX260Pf
Rugged Laptop PC with Sierra Wireless AirCard 580 Dual-Band CDMA Modem and Cirronet BT2022 Bluetooth							
2005 Celltech Labs Inc. This document is not to be reproduced in whole or in part without the written permission of Celltech Labs Inc.							22 of 51

C.5. MEASUREMENT EQUIPMENT SETUP

MEASUREMENT EQUIPMENT CONNECTIONS	The measurement equipment was connected as shown in C.6.			
MEASUREMENT EQUIPMENT SETTINGS	The spectrum analyzer was set to the following settings:			
	Frequency Range	RBW	VBW	Detector
	MHz	kHz	kHz	
	< 1000	100	100	

C.6. SETUP DRAWING

Figure C.6-1 - Field Strength Setup Drawing

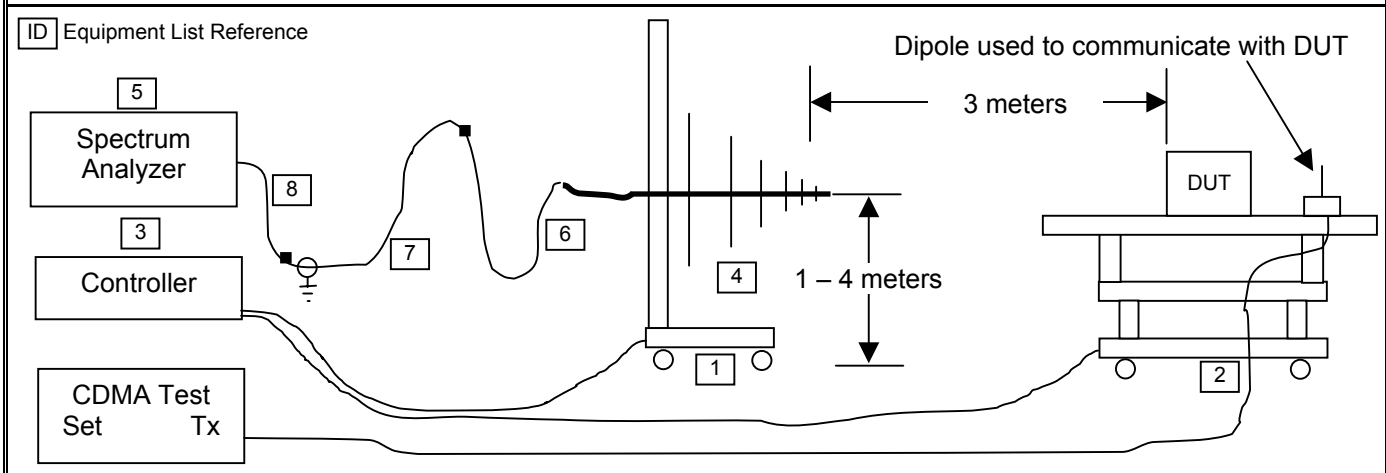
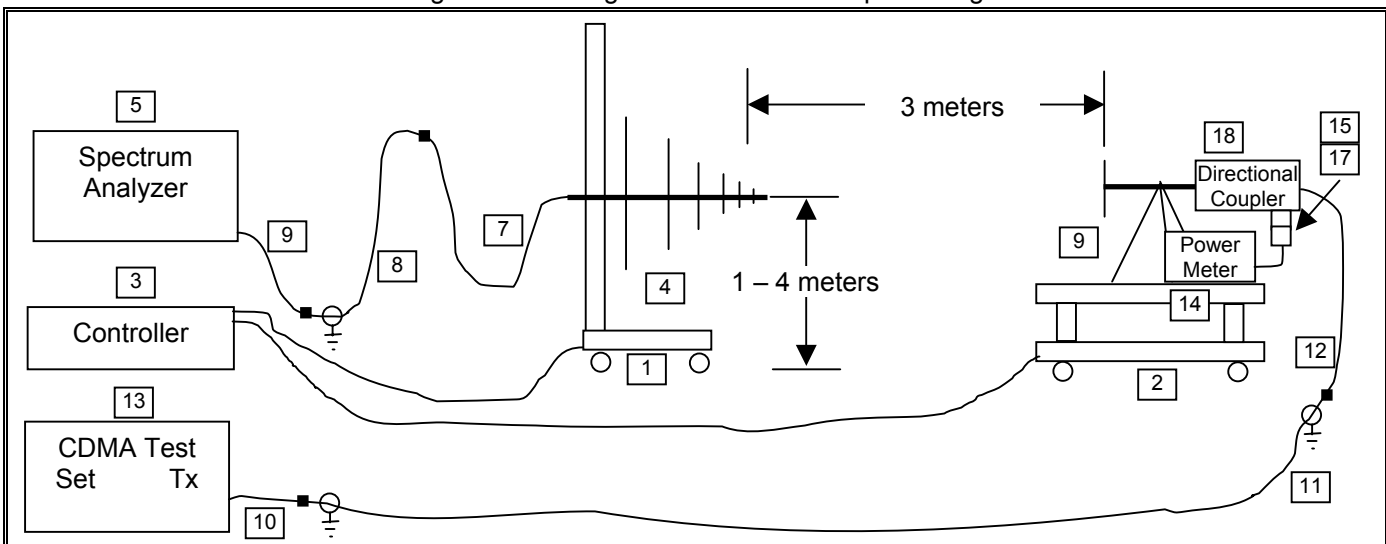

Figure C.6-2 - Signal Substitution Setup Drawing



Test Report Serial No.:	050405KBC-T635-E24C/E15B	Issue 1
Test Date(s):	30th March - 19th April, 2005	
Test Type(s):	FCC §2, §15.247, §22H, §24E	IC RSS-210/132/133
Lab Registration(s):	FCC #714830	IC Lab File #3874

C.7. SETUP PHOTOGRAPHS

Photograph C.7-1 - Horizontal Bilog Receive Antenna with DUT



Photograph C.7-2 - Front of Radiated Emission Setup

Photograph C.7-3 - Back of Radiated Emission Setup

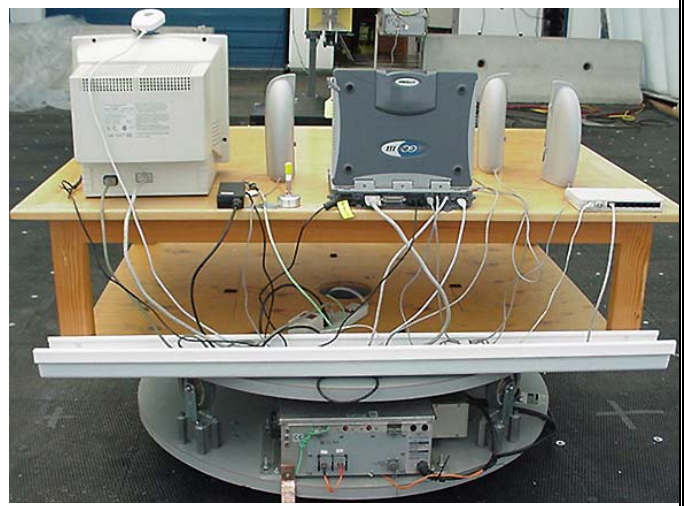

Applicant:	Itronix Corporation	Model:	IX260P-AC580BT	FCC ID:	KBCIX260P-AC580BT	IC ID:	1943A-IX260Pf
Rugged Laptop PC with Sierra Wireless AirCard 580 Dual-Band CDMA Modem and Cirronet BT2022 Bluetooth							
2005 Celltech Labs Inc. This document is not to be reproduced in whole or in part without the written permission of Celltech Labs Inc.							24 of 51

Test Report Serial No.:	050405KBC-T635-E24C/E15B	Issue 1
Test Date(s):	30th March - 19th April, 2005	
Test Type(s):	FCC §2, §15.247, §22H, §24E	IC RSS-210/132/133
Lab Registration(s):	FCC #714830	IC Lab File #3874

C.8. DUT OPERATING DESCRIPTION

Measurements were made for the low, mid and high CDMA channels co-transmitting in the cellular band at maximum power levels with the Bluetooth transmitter transmitting on Channel 78 as described in Section 5 of this report.

C.9. TEST RESULTS

C.9.1. Carrier Power Levels



Project Number: 022305KBC-T617
Company: Itronix
Product: IX260PNLA580BT

Standard: FCC22.913
Test Start Date: 11-Apr-05
Test End Date: 11-Apr-05

Attached Dipole Antenna CoTx with Bluetooth Channel 78

Polarity	Distance m	Substitution Antenna Type	Carrier	Frequency	Corrected Field Strength	Substituted SA Signal Level (uncorrected)	Power Applied to Antenna	Antenna Gain	Carrier ERP Level		ERP Limit		Margin	Pass/Fail
				MHz	dBuV/m	dBuV	dBm	dBd	dBm	Watts	dBm	Watts	dB	
H	3	B_3121C	1013	824.70	157.91	132.68	24.49	-0.84	23.65	0.231	38.45	7.00	14.80	PASS
H	3	B_3121C	384	836.52	157.66	132.00	23.74	-0.70	23.04	0.201	38.45	7.00	15.41	PASS
H	3	B_3121C	777	848.31	158.36	132.19	24.67	-0.56	24.11	0.258	38.45	7.00	14.34	PASS
V	3	B_3121C	1013	824.70	153.20	127.97	21.80	-0.84	20.96	0.125	38.45	7.00	17.49	PASS
V	3	B_3121C	384	836.52	153.25	127.59	22.56	-0.70	21.86	0.153	38.45	7.00	16.59	PASS
V	3	B_3121C	777	848.31	154.39	128.22	22.81	-0.56	22.25	0.168	38.45	7.00	16.20	PASS

Note:
Dipole Antenna used for substitution

Formulae:
ERP Level (dBm) = Power applied to Antenna (dBm) + Antenna Gain (dBi) - 2.14
Margin (dB) = Limit (dBm) - Level (dBm)

Applicant:	Itronix Corporation	Model:	IX260P-AC580BT	FCC ID:	KBCIX260P-AC580BT	IC ID:	1943A-IX260Pf
Rugged Laptop PC with Sierra Wireless AirCard 580 Dual-Band CDMA Modem and Cirronet BT2022 Bluetooth							
2005 Celltech Labs Inc. This document is not to be reproduced in whole or in part without the written permission of Celltech Labs Inc.							25 of 51

Test Report Serial No.:	050405KBC-T635-E24C/E15B	Issue 1
Test Date(s):	30th March - 19th April, 2005	
Test Type(s):	FCC §2, §15.247, §22H, §24E	IC RSS-210/132/133
Lab Registration(s):	FCC #714830	IC Lab File #3874

C.10. PASS/FAIL

In reference to the results outlined in C.9, the DUT passes the requirements as stated in the reference standards as follows:

FCC 22.913 (a) Maximum ERP. The ERP of mobile transmitters and auxiliary transmitters must not exceed 7 Watts.

A maximum ERP of 24.11 dBm (0.258 Watts) was measured when Channel 777 was co-transmitting with the Bluetooth.

C.11. SIGN-OFF

I attest to the accuracy of the data. All measurements reported herein were performed by me and are correct to the best of my knowledge and belief. I assume full responsibility for the completeness of these measurements.



Russell Pipe
Senior Compliance Technologist
Celltech Labs Inc.

11Apr05

Date

Applicant:	Itronix Corporation	Model:	IX260P-AC580BT	FCC ID:	KBCIX260P-AC580BT	IC ID:	1943A-IX260Pf
Rugged Laptop PC with Sierra Wireless AirCard 580 Dual-Band CDMA Modem and Cirronet BT2022 Bluetooth							
2005 Celltech Labs Inc. This document is not to be reproduced in whole or in part without the written permission of Celltech Labs Inc.							26 of 51

Test Report Serial No.:	050405KBC-T635-E24C/E15B	Issue 1
Test Date(s):	30th March - 19th April, 2005	
Test Type(s):	FCC §2, §15.247, §22H, §24E	IC RSS-210/132/133
Lab Registration(s):	FCC #714830	IC Lab File #3874

Appendix D - Cellular Radiated Spurious Emissions Measurement

D.1. REFERENCES

Normative Reference Standard	FCC CFR 47 §22.917(a)
Procedure Reference	ANSI/TIA/EIA-603-C

D.2. LIMITS

FCC CFR 47 §22.917	<i>(a) Out of Band Emissions. The mean power of emissions must be attenuated below the mean power of the unmodulated carrier (P) on any frequency twice or more than twice the fundamental frequency by: at least 43 + 10 log P dB</i>
--------------------	--

D.3. ENVIRONMENTAL CONDITIONS

Temperature	27.4 +/- 2 °C
Humidity	33 +/- 2 %
Barometric Pressure	96.24 +/- 0.2 kPa

D.4. EQUIPMENT LIST

RECEIVING EQUIPMENT

ID	ASSET NUMBER	MANUFACTURER	MODEL	DESCRIPTION	LAST CAL	CAL DUE
1	00072	EMCO	2075	Mini-mast	na	na
2	00073	EMCO	2080	Turn Table	na	na
3	00071	EMCO	2090	Multi-Device Controller	na	na
4	00031	HP	E8285A	CDMA Test set	na	na
5	00035	ETS	3115	Horn Antenna (Rx)	24Mar04	24Mar06
6	00015	Agilent	E4408B	Spectrum Analyzer	24Jan05	24Jan06
7	00120	Celltech	n/a	Microwave Cable (RX)	25Mar05	25Mar06
8	00121	Andrew	FSJ4-50B	Microwave Cable (RX)	25Mar05	25Mar06
9	00130	Andrew	FSJ1-50A	Microwave Cable (RX)	25Mar05	25Mar06
10	00115	Miteq	JS4-00102600-35-5A	Low Noise Amplifier	28Dec04	28Dec05
11	00093	Microtronics	HPM50111	High Pass Filter	8Jun04	8Jun05
12	00043	Microwave Circuits	H02G18G1	High Pass Filter	8Jun04	8Jun05
13	00119	INMAT	18AH-10	10dB attenuator	8Jun04	8Jun05

Applicant:	Itronix Corporation	Model:	IX260P-AC580BT	FCC ID:	KBCIX260P-AC580BT	IC ID:	1943A-IX260Pf
Rugged Laptop PC with Sierra Wireless AirCard 580 Dual-Band CDMA Modem and Cirronet BT2022 Bluetooth							
2005 Celltech Labs Inc. This document is not to be reproduced in whole or in part without the written permission of Celltech Labs Inc.							27 of 51

Test Report Serial No.:	050405KBC-T635-E24C/E15B	Issue 1
Test Date(s):	30th March - 19th April, 2005	
Test Type(s):	FCC §2, §15.247, §22H, §24E	IC RSS-210/132/133
Lab Registration(s):	FCC #714830	IC Lab File #3874

ADDITIONAL SUBSTITUTION EQUIPMENT						
ID	ASSET NUMBER	MANUFACTURER	MODEL	DESCRIPTION	LAST CAL	CAL DUE
14	00142	HP	8491A	20 dB attenuator	n/a*	n/a*
15	00034	ETS	3115	Horn Antenna (Tx)	24Mar04	24Mar06
16	00131	Andrew	FSJ1-50A	Microwave Cable (TX)	n/a	n/a
17	00127	Andrew	FSJ4-50B	Microwave Cable (TX)	n/a	n/a
18	00131	Andrew	FSJ1-50A	Microwave Cable (TX)	n/a	n/a
19	00006	R & S	SMR-20	Signal Generator	30Apr04	30Apr05
20	00007	Gigatronics	8652A	Power Meter	18Oct04	18Oct05
21	00011	Gigatronics	80701A	Power Sensor	08Oct04	08Oct05
22	00013	Gigatronics	80701A	Power Sensor	11Oct04	11Oct05
23	00102	Pasternack	PE7015-3110	30 dB attenuator	n/a*	n/a*
24	00078	Pasternack	PE2214-20	Directional Coupler	n/a*	n/a*

* Attenuation offset in power meter setup

D.5. MEASUREMENT EQUIPMENT SETUP					
MEASUREMENT EQUIPMENT CONNECTIONS	The measurement equipment was connected as shown in D.6. A number of measurement equipment configurations were used to cover the applicable frequency ranges. The configurations for each range are as follows:				
	Frequency Range	LNA Asset #	Filter/Attenuator Asset #	Rx Antenna Asset #	Tx Antenna Asset #
	1 GHz – 2 GHz	00115	00043 & 00119	00035	00034
	2 GHz – 18 GHz	00115	00093	00035	00034
	18 GHz – 10 GHz	00115	none	80001	80002
MEASUREMENT EQUIPMENT SETTINGS	The spectrum analyzer was set to the following settings:				
	Frequency Range	RBW	VBW	Detector	
	MHz	kHz	kHz		
	≥ 1000	1000	1000	Peak	

Test Report Serial No.:	050405KBC-T635-E24C/E15B	Issue 1
Test Date(s):	30th March - 19th April, 2005	
Test Type(s):	FCC §2, §15.247, §22H, §24E	IC RSS-210/132/133
Lab Registration(s):	FCC #714830	IC Lab File #3874

D.6. SETUP DRAWING

Figure D.6-1 - Field Strength Setup Drawing

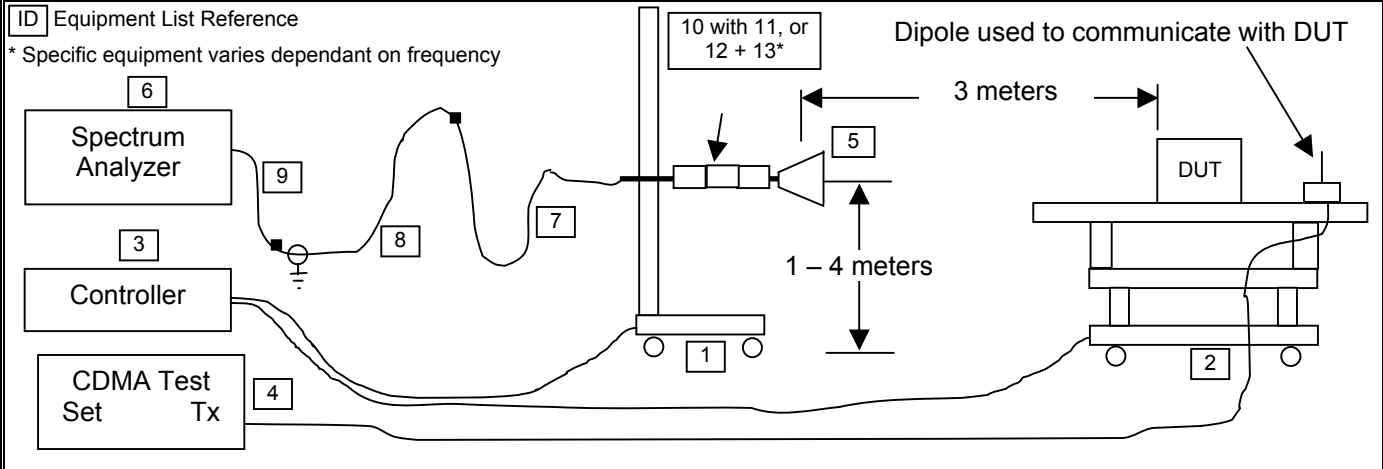
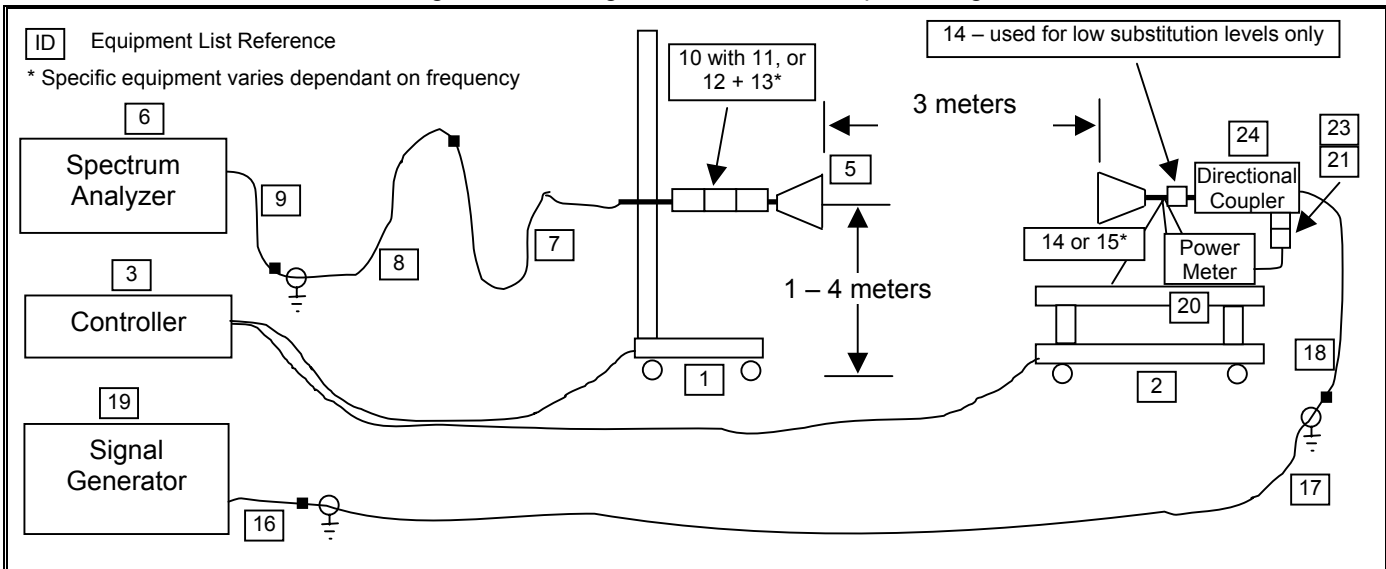

Figure D.6-2 - Signal Substitution Setup Drawing



Test Report Serial No.:	050405KBC-T635-E24C/E15B	Issue 1
Test Date(s):	30th March - 19th April, 2005	
Test Type(s):	FCC §2, §15.247, §22H, §24E	IC RSS-210/132/133
Lab Registration(s):	FCC #714830	IC Lab File #3874

D.7. SETUP PHOTOGRAPHS

Photograph D.7-1 - Horizontal 3115 Horn & LNA with DUT



Photograph D.7-2 - Vertical 3115 Horn & LNA with DUT



Photograph D.7-3 - Front of Radiated Emission Setup



Photograph D.7-4 - Back of Radiated Emission Setup

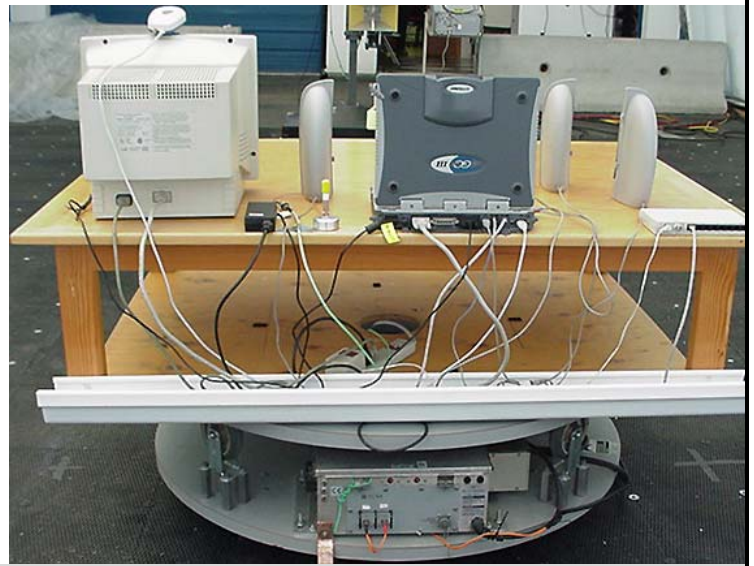

Applicant:	Itronix Corporation	Model:	IX260P-AC580BT	FCC ID:	KBCIX260P-AC580BT	IC ID:	1943A-IX260Pf	
Rugged Laptop PC with Sierra Wireless AirCard 580 Dual-Band CDMA Modem and Cirronet BT2022 Bluetooth								
2005 Celltech Labs Inc. This document is not to be reproduced in whole or in part without the written permission of Celltech Labs Inc.							30 of 51	

Test Report Serial No.:	050405KBC-T635-E24C/E15B	Issue 1
Test Date(s):	30th March - 19th April, 2005	
Test Type(s):	FCC §2, §15.247, §22H, §24E	IC RSS-210/132/133
Lab Registration(s):	FCC #714830	IC Lab File #3874

D.8. DUT OPERATING DESCRIPTION

Measurements were made for the Cellular CDMA Channel 1013 co-transmitting with Bluetooth Channel 78 (worst-case configuration) at their maximum power level as described in Section 5 of this report.

D.9. TEST RESULTS

The spurious measurements detailed in this section are referenced to the carrier levels set forth in Appendix C of this report:

D.9.1. Spurious Emissions

D.9.1.1 Spurious Emissions - Attached Dipole Antenna

	Project Number:	022305KBC-T617	Standard:	FCC22.917
	Company:	Itronix	Test Start Date:	19-Apr-05
	Product:	IX260PNLA580BT	Test End Date:	19-Apr-05

Dipole Antenna Spurious Emissions

Polarity	Distance m	Substitution Antenna Type	Carrier	Frequency	Corrected Field Strength	Substituted SA Signal Level (uncorrected)	Power Applied to Antenna	Antenna Gain	Emission ERP Level	ERP Limit	Margin	Pass/Fail
				MHz	dBuV/m	dBuV	dBm	dBd	dBm	dBm*	dB	
H	3	Horn SN6267	CH1013/CH78	1655.30	63.03	30.86	-53.46	4.22	-51.38	-13.00	38.38	PASS
H	3	Horn SN6267	CH1013/CH78	3304.40	53.51						30.86*	na
H	3	Horn SN6267	CH1013/CH78	4135.30	55.29						29.08*	na
V	3	Horn SN6267	CH1013/CH78	1655.30	64.22	32.05	-43.99	4.22	-41.91	-13.00	28.91	PASS
V	3	Horn SN6267	CH1013/CH78	3304.40	54.16						30.21*	na
V	3	Horn SN6267	CH1013/CH78	4135.30	55.98						28.39*	na

Note: Intermod product field strength & theoretical margin presented for reference only.

Formulae:

ERP Level (dBm) = Power applied to Antenna (dBm) + Antenna Gain (dBd)

Margin (dB) = Limit (dBm) - Level (dBm)

*The emissions reported above represent the highest emissions or noise floor measured at or near the inter-modulation product frequencies within the frequency band of 30MHz and the 10th harmonic of the carrier with field strengths within 20 dB of the theoretical limit. All other spurious emissions attributed to the EUT had field strengths greater than 20 dB below the theoretical limit or were presented in the single reports and substitutions were not made.

Applicant:	Itronix Corporation	Model:	IX260P-AC580BT	FCC ID:	KBCIX260P-AC580BT	IC ID:	1943A-IX260Pf
Rugged Laptop PC with Sierra Wireless AirCard 580 Dual-Band CDMA Modem and Cirronet BT2022 Bluetooth							
2005 Celltech Labs Inc. This document is not to be reproduced in whole or in part without the written permission of Celltech Labs Inc.							31 of 51

Test Report Serial No.:	050405KBC-T635-E24C/E15B	Issue 1
Test Date(s):	30th March - 19th April, 2005	
Test Type(s):	FCC §2, §15.247, §22H, §24E	IC RSS-210/132/133
Lab Registration(s):	FCC #714830	IC Lab File #3874

D.10. PASS/FAIL

In reference to the results outlined in D.9, the DUT passes the requirements as stated in the reference standards.

FCC CFR 4 §22.917(e) Out of Band Emissions. The mean power of emissions must be attenuated below the mean power of the unmodulated carrier (P) on any frequency twice or more than twice the fundamental frequency by: at least $43 + 10 \log P$ dB.

The results set forth in this section meet the requirement with a margin of at least 28.91 dB.

D.11. SIGN-OFF

I attest to the accuracy of the data. All measurements reported herein were performed by me and are correct to the best of my knowledge and belief. I assume full responsibility for the completeness of these measurements.



Russell Pipe
Senior Compliance Technologist
Celltech Labs Inc.

19Apr05

Date

Applicant:	Itronix Corporation	Model:	IX260P-AC580BT	FCC ID:	KBCIX260P-AC580BT	IC ID:	1943A-IX260Pf
Rugged Laptop PC with Sierra Wireless AirCard 580 Dual-Band CDMA Modem and Cirronet BT2022 Bluetooth							
2005 Celltech Labs Inc. This document is not to be reproduced in whole or in part without the written permission of Celltech Labs Inc.							32 of 51

Test Report Serial No.:	050405KBC-T635-E24C/E15B	Issue 1
Test Date(s):	30th March - 19th April, 2005	
Test Type(s):	FCC §2, §15.247, §22H, §24E	IC RSS-210/132/133
Lab Registration(s):	FCC #714830	IC Lab File #3874

Appendix E - Effective Isotropic Radiated Power Measurement

E.1. REFERENCES	
Normative Reference Standard	FCC CFR 47 §24.232(b)
Procedure Reference	ANSI/TIA/EIA-603-C

E.2. LIMITS	
FCC CFR 47 §24.232 (b)	<i>(b) Mobile/portable stations are limited to 2 watts e.i.r.p. peak power and the equipment must employ means to limit the power to the minimum necessary for successful communications.</i>

E.3. ENVIRONMENTAL CONDITIONS	
Temperature	27.4 +/- 2 °C
Humidity	33 +/- 2 %
Barometric Pressure	96.24 +/- 0.2 kPa

E.4. EQUIPMENT LIST						
RECEIVING EQUIPMENT						
ID	ASSET NUMBER	MANUFACTURER	MODEL	DESCRIPTION	LAST CAL	CAL DUE
1	00072	EMCO	2075	Mini-mast	na	na
2	00073	EMCO	2080	Turn Table	na	na
3	00071	EMCO	2090	Multi-Device Controller	na	na
4	00035	ETS	3115	Horn Antenna (Rx)	24Mar04	24Mar06
5	00015	Agilent	E4408B	Spectrum Analyzer	24Jan05	24Jan06
6	00120	Celltech	n/a	Microwave Cable (RX)	25Mar05	25Mar06
7	00121	Andrew	FSJ4-50B	Microwave Cable (RX)	25Mar05	25Mar06
8	00130	Andrew	FSJ1-50A	Microwave Cable (RX)	25Mar05	25Mar06
ADDITIONAL SUBSTITUTION EQUIPMENT						
ID	ASSET NUMBER	MANUFACTURER	MODEL	DESCRIPTION	LAST CAL	CAL DUE
9	00034	ETS	3115	Horn Antenna (Tx)	24Mar04	24Mar06
10	00131	Andrew	FSJ1-50A	Microwave Cable (TX)	na	na
11	00127	Andrew	FSJ4-50B	Microwave Cable (TX)	na	na
12	00131	Andrew	FSJ1-50A	Microwave Cable (TX)	na	na
13	00031	HP	E8285A	CDMA Test set	na	na
14	00007	Gigatronics	8652A	Power Meter	18Oct04	18Oct05
15	00011	Gigatronics	80701A	Power Sensor	08Oct04	08Oct05
16	00013	Gigatronics	80701A	Power Sensor	11Oct04	11Oct05
17	00102	Pasternack	PE7015-3110	30 dB attenuator	na*	na*
18	00078	Pasternack	PE2214-20	Directional Coupler	na*	na*

*Attenuation offset in power meter setup

Applicant:	Itronix Corporation	Model:	IX260P-AC580BT	FCC ID:	KBCIX260P-AC580BT	IC ID:	1943A-IX260Pf
Rugged Laptop PC with Sierra Wireless AirCard 580 Dual-Band CDMA Modem and Cirronet BT2022 Bluetooth							
2005 Celltech Labs Inc. This document is not to be reproduced in whole or in part without the written permission of Celltech Labs Inc.							33 of 51

E.5. MEASUREMENT EQUIPMENT SETUP

MEASUREMENT EQUIPMENT CONNECTIONS	The measurement equipment was connected as shown in E.6.			
MEASUREMENT EQUIPMENT SETTINGS	The spectrum analyzer was set to the following settings:			
	Frequency Range	RBW	VBW	Detector
	MHz	MHz	MHz	
≥ 1000	1	1	Peak	

E.6. SETUP DRAWING

Figure E.6-1 - Field Strength Setup Drawing

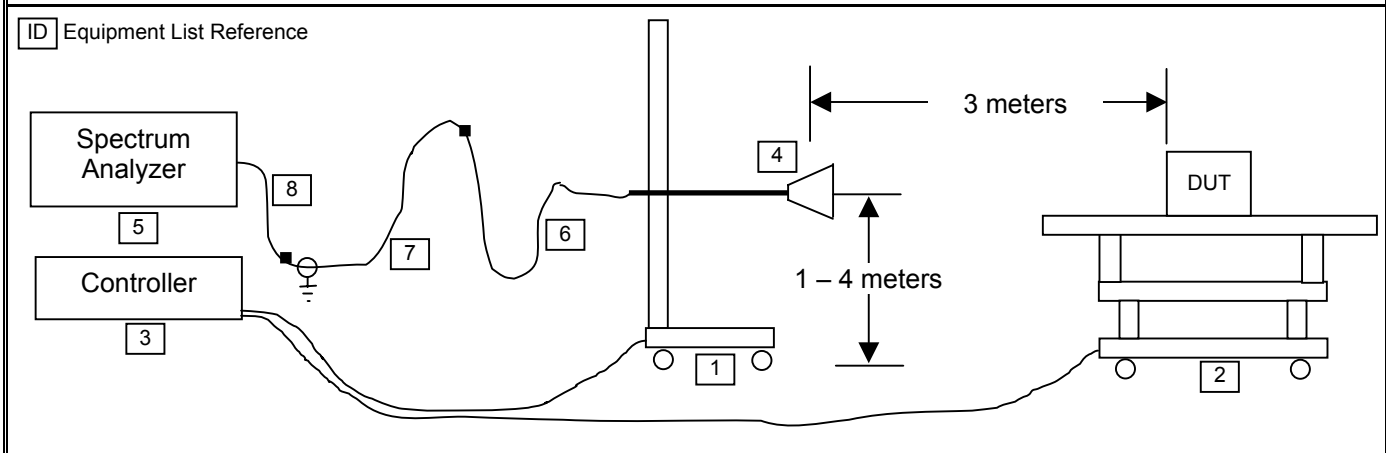
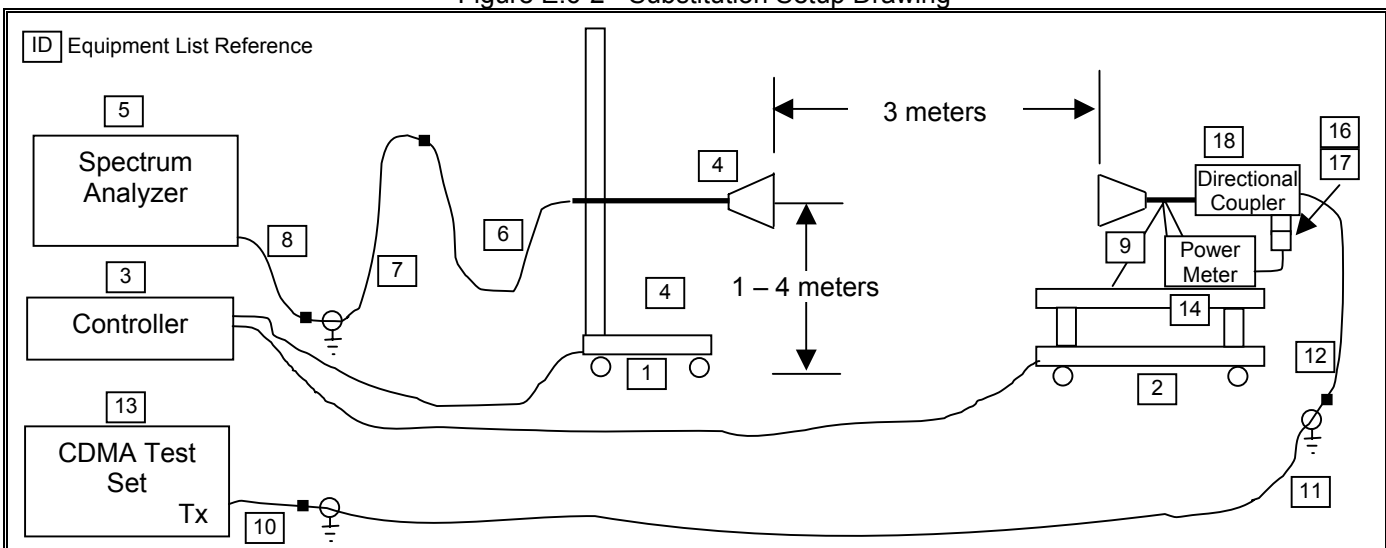

Figure E.6-2 - Substitution Setup Drawing



Test Report Serial No.:	050405KBC-T635-E24C/E15B	Issue 1
Test Date(s):	30th March - 19th April, 2005	
Test Type(s):	FCC §2, §15.247, §22H, §24E	IC RSS-210/132/133
Lab Registration(s):	FCC #714830	IC Lab File #3874

E.7. SETUP PHOTOGRAPHS

Photograph E.7-1 - Horizontal Horn Receive Antenna with DUT



Photograph E.7-2 - Vertical Horn Receive Antenna with DUT

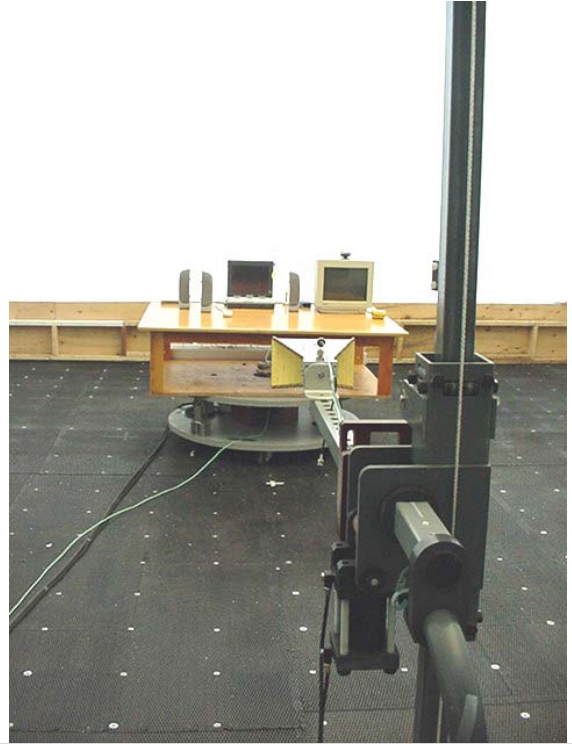

Photograph E.7-3 - Front of Radiated Emission Setup



Photograph E.7-4 - Back of Radiated Emission Setup



Applicant:	Itronix Corporation	Model:	IX260P-AC580BT	FCC ID:	KBCIX260P-AC580BT	IC ID:	1943A-IX260Pf	
Rugged Laptop PC with Sierra Wireless AirCard 580 Dual-Band CDMA Modem and Cirronet BT2022 Bluetooth								
2005 Celltech Labs Inc.		This document is not to be reproduced in whole or in part without the written permission of Celltech Labs Inc.					35 of 51	

Test Report Serial No.:	050405KBC-T635-E24C/E15B	Issue 1
Test Date(s):	30th March - 19th April, 2005	
Test Type(s):	FCC §2, §15.247, §22H, §24E	IC RSS-210/132/133
Lab Registration(s):	FCC #714830	IC Lab File #3874

E.8. DUT OPERATING DESCRIPTION

Measurements were made for the low, mid and high CDMA channels co-transmitting in the PCS band at maximum power levels with the Bluetooth transmitter transmitting on Channel 78 as described in Section 5 of this report

E.9. TEST RESULTS

E.9.1. Carrier Power Levels



Project Number: 022305KBC-T617
Company: Itronix
Product: IX260PNLA580BT

Standard: FCC24.232b
Test Start Date: 11-Apr-05
Test End Date: 11-Apr-05

Attached Dipole Antenna CoTx with Bluetooth Channel 78

Polarity	Distance m	Substitution Antenna Type	Carrier	Frequency	Corrected Field Strength	Substituted SA Signal Level (uncorrected)	Power Applied to Antenna	Antenna Gain	Carrier EIRP Level		EIRP Limit		Margin	Pass/Fail
				MHz	dBuV/m	dBuV	dBm	dBi	dBm	Watts	dBm	Watts	dB	
H	3	Horn SN6276	25	1851.25	158.41	125.06	18.99	6.67	25.66	0.368	33.01	2.00	7.35	PASS
H	3	Horn SN6276	600	1880.00	158.85	125.31	19.59	6.68	26.27	0.423	33.01	2.00	6.74	PASS
H	3	Horn SN6276	1175	1908.75	159.20	125.49	20.08	6.68	26.76	0.474	33.01	2.00	6.25	PASS
V	3	Horn SN6276	25	1851.25	154.77	121.42	16.51	6.67	23.18	0.208	33.01	2.00	9.83	PASS
V	3	Horn SN6276	600	1880.00	154.61	121.07	16.32	6.68	23.00	0.199	33.01	2.00	10.01	PASS
V	3	Horn SN6276	1175	1908.75	154.17	120.46	15.73	6.68	22.41	0.174	33.01	2.00	10.60	PASS

Note:
Horn Antenna used for substitution

Formulae:
EIRP Level (dBm) = Power applied to Antenna (dBm) + Antenna Gain (dBi)
Margin (dB) = Limit (dBm) - Level (dBm)

Applicant:	Itronix Corporation	Model:	IX260P-AC580BT	FCC ID:	KBCIX260P-AC580BT	IC ID:	1943A-IX260Pf
Rugged Laptop PC with Sierra Wireless AirCard 580 Dual-Band CDMA Modem and Cirronet BT2022 Bluetooth							
2005 Celltech Labs Inc. This document is not to be reproduced in whole or in part without the written permission of Celltech Labs Inc.							36 of 51

Test Report Serial No.:	050405KBC-T635-E24C/E15B	Issue 1
Test Date(s):	30th March - 19th April, 2005	
Test Type(s):	FCC §2, §15.247, §22H, §24E	IC RSS-210/132/133
Lab Registration(s):	FCC #714830	IC Lab File #3874

E.10. PASS/FAIL

In reference to the results outlined in E.9, the DUT passes the requirements as stated in the reference standards as follows:

FCC 24.232 (b): Mobile/portable stations are limited to 2 watts e.i.r.p. peak power....

A maximum EIRP of 26.76 dBm (0.474 Watts) was measured when Channel 1175 was co-transmitting with the Bluetooth.

E.11. SIGN-OFF

I attest to the accuracy of the data. All measurements reported herein were performed by me and are correct to the best of my knowledge and belief. I assume full responsibility for the completeness of these measurements.



Russell Pipe
Senior Compliance Technologist
Celltech Labs Inc.

11Apr05

Date

Test Report Serial No.:	050405KBC-T635-E24C/E15B	Issue 1
Test Date(s):	30th March - 19th April, 2005	
Test Type(s):	FCC §2, §15.247, §22H, §24E	IC RSS-210/132/133
Lab Registration(s):	FCC #714830	IC Lab File #3874

Appendix F - PCS Radiated Spurious Emissions Measurement

F.1. REFERENCES

Normative Reference Standard	FCC CFR 47 §24.238(a)
Procedure Reference	ANSI/TIA/EIA-603-C, §2.1053, §24.238 (b)

F.2. LIMITS

FCC CFR 47 §24.238	(a) <i>Out of band emissions. The power of any emission outside of the authorized operating frequency ranges must be attenuated below the transmitting power (P) by a factor of at least 43 + 10 log(P) dB.</i>
--------------------	---

F.3. ENVIRONMENTAL CONDITIONS

Temperature	27.4 +/- 2 °C
Humidity	33 +/- 2 %
Barometric Pressure	96.24 +/- 0.2 kPa

F.4. EQUIPMENT LIST

RECEIVING EQUIPMENT

ID	ASSET NUMBER	MANUFACTURER	MODEL	DESCRIPTION	LAST CAL	CAL DUE
1	00072	EMCO	2075	Mini-mast	na	na
2	00073	EMCO	2080	Turn Table	na	na
3	00071	EMCO	2090	Multi-Device Controller	na	na
4	00050	Chase	CBL-6111A	Bilog Antenna	08Feb05	08Feb06
5	00035	ETS	3115	Horn Antenna (Rx)	24Mar04	24Mar06
6	80001	ETS	3160-09	Standard Gain Horn Antenna (Rx)	n/a	n/a
7	00015	Agilent	E4408B	Spectrum Analyzer	24Jan05	24Jan06
8	00120	Celltech	n/a	Microwave Cable (RX)	25Mar05	25Mar06
9	00121	Andrew	FSJ4-50B	Microwave Cable (RX)	25Mar05	25Mar06
10	00130	Andrew	FSJ1-50A	Microwave Cable (RX)	25Mar05	25Mar06
11	00115	Miteq	JS4-00102600-35-5A	Low Noise Amplifier	28Dec04	28Dec05
12	00093	Microtronics	HPM50111	High Pass Filter	8Jun04	8Jun05
13	00043	Microwave Circuits	H02G18G1	High Pass Filter	8Jun04	8Jun05
14	00119	INMAT	18AH-10	10dB attenuator	8Jun04	8Jun05

Applicant:	Itronix Corporation	Model:	IX260P-AC580BT	FCC ID:	KBCIX260P-AC580BT	IC ID:	1943A-IX260Pf
Rugged Laptop PC with Sierra Wireless AirCard 580 Dual-Band CDMA Modem and Cirronet BT2022 Bluetooth							
2005 Celltech Labs Inc. This document is not to be reproduced in whole or in part without the written permission of Celltech Labs Inc.							38 of 51

Test Report Serial No.:	050405KBC-T635-E24C/E15B	Issue 1
Test Date(s):	30th March - 19th April, 2005	
Test Type(s):	FCC §2, §15.247, §22H, §24E	IC RSS-210/132/133
Lab Registration(s):	FCC #714830	IC Lab File #3874

ADDITIONAL SUBSTITUTION EQUIPMENT						
ID	ASSET NUMBER	MANUFACTURER	MODEL	DESCRIPTION	LAST CAL	CAL DUE
15	00034	ETS	3115	Horn Antenna (Tx)	24Mar04	24Mar06
16	80002	ETS	3160-09	Standard Gain Horn Antenna (Tx)	na	na
17	00131	Andrew	FSJ1-50A	Microwave Cable (TX)	na	na
18	00127	Andrew	FSJ4-50B	Microwave Cable (TX)	na	na
19	00131	Andrew	FSJ1-50A	Microwave Cable (TX)	na	na
20	00006	R & S	SMR-20	Signal Generator	30Apr04	30Apr05
21	00007	Gigatronics	8652A	Power Meter	18Oct04	18Oct05
22	00011	Gigatronics	80701A	Power Sensor	08Oct04	08Oct05
23	00013	Gigatronics	80701A	Power Sensor	11Oct04	11Oct05
24	00102	Pasternack	PE7015-3110	30 dB attenuator	na*	na*
25	00078	Pasternack	PE2214-20	Directional Coupler	na*	na*
26	00142	HP	8491A	20 dB attenuator	na*	na*

* Attenuation offset in power meter setup

F.5. MEASUREMENT EQUIPMENT SETUP					
MEASUREMENT EQUIPMENT CONNECTIONS	The measurement equipment was connected as shown in F.6. A number of measurement equipment configurations were used to cover the applicable frequency ranges. The configurations for each range are as follows:				
	Frequency Range	LNA Asset #	Filter/Attenuator Asset #	Rx Antenna Asset #	Tx Antenna Asset #
	30 MHz – 1 GHz	None	none	00050	na
	1 GHz – 2 GHz	00115	00043 & 00119	00035	00034
	2 GHz – 18 GHz	00115	00093	00035	00034
18 GHz – 20 GHz	00115	none	80001	80002	
MEASUREMENT EQUIPMENT SETTINGS	The spectrum analyzer was set to the following settings:				
	Frequency Range	RBW	VBW	Detector	
	MHz	kHz	kHz		
	< 1000	100	100	Peak	
≥ 1000	1000	1000	Peak		

Applicant:	Itronix Corporation	Model:	IX260P-AC580BT	FCC ID:	KBCIX260P-AC580BT	IC ID:	1943A-IX260Pf
Rugged Laptop PC with Sierra Wireless AirCard 580 Dual-Band CDMA Modem and Cirronet BT2022 Bluetooth							
2005 Celltech Labs Inc. This document is not to be reproduced in whole or in part without the written permission of Celltech Labs Inc.							39 of 51

Test Report Serial No.:	050405KBC-T635-E24C/E15B	Issue 1
Test Date(s):	30th March - 19th April, 2005	
Test Type(s):	FCC §2, §15.247, §22H, §24E	IC RSS-210/132/133
Lab Registration(s):	FCC #714830	IC Lab File #3874

F.6. SETUP DRAWING

Figure F.6-1 - Field Strength Setup Drawing

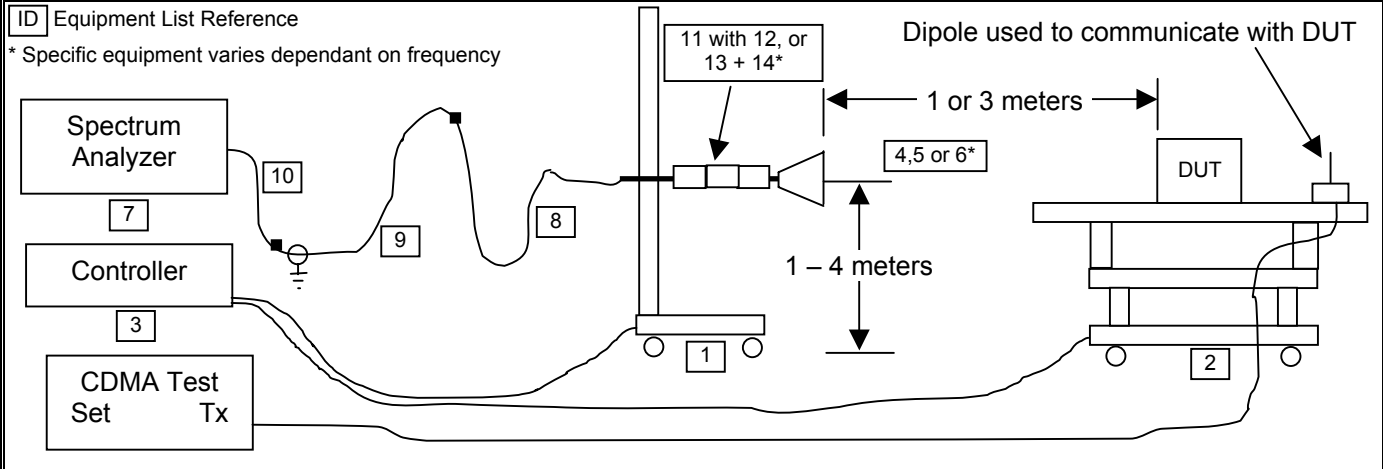
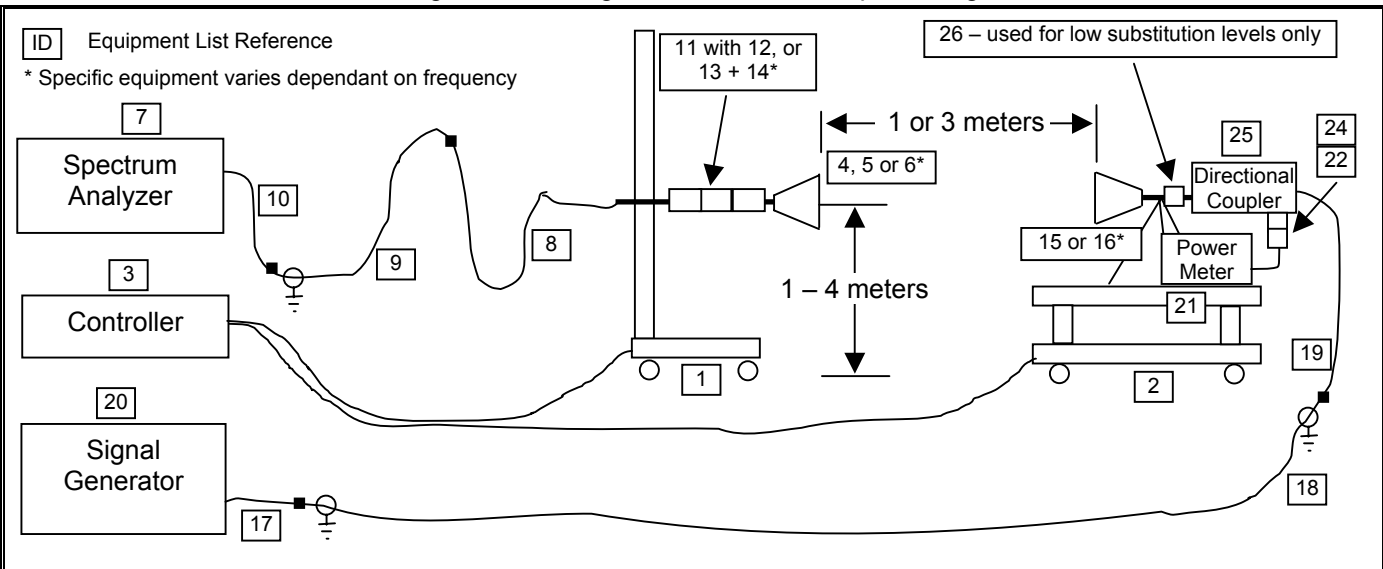

Figure F.6-2 - Signal Substitution Setup Drawing



Test Report Serial No.:	050405KBC-T635-E24C/E15B	Issue 1
Test Date(s):	30th March - 19th April, 2005	
Test Type(s):	FCC §2, §15.247, §22H, §24E	IC RSS-210/132/133
Lab Registration(s):	FCC #714830	IC Lab File #3874

F.7. SETUP PHOTOGRAPHS

Photograph F.7-1 - Horizontal 3115 Horn & LNA with DUT



Photograph F.7-2 - Vertical 3115 Horn & LNA with DUT



Photograph F.7-3 - Front of Radiated Emission Setup



Photograph F.7-4 - Back of Radiated Emission Setup

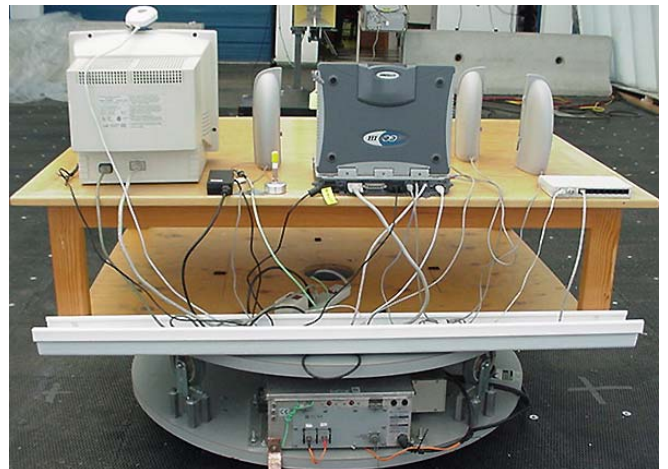

Applicant:	Itronix Corporation	Model:	IX260P-AC580BT	FCC ID:	KBCIX260P-AC580BT	IC ID:	1943A-IX260Pf
Rugged Laptop PC with Sierra Wireless AirCard 580 Dual-Band CDMA Modem and Cirronet BT2022 Bluetooth							
2005 Celltech Labs Inc. This document is not to be reproduced in whole or in part without the written permission of Celltech Labs Inc.							41 of 51

Test Report Serial No.:	050405KBC-T635-E24C/E15B	Issue 1
Test Date(s):	30th March - 19th April, 2005	
Test Type(s):	FCC §2, §15.247, §22H, §24E	IC RSS-210/132/133
Lab Registration(s):	FCC #714830	IC Lab File #3874

F.8. DUT OPERATING DESCRIPTION

Measurements were made for the PCS CDMA Channel 25 co-transmitting with Bluetooth Channel 78 (worst-case configuration) at their maximum power level as described in Section 5 of this report.

F.9. TEST RESULTS

The spurious measurements detailed in this section are referenced to the carrier levels set forth in Appendix E of this report:

F.9.1. Spurious Emissions

F.9.1.1 Spurious Emissions - Attached Dipole Antenna



Project Number: 022305KBC-T617
Company: Itronix
Product: IX260PNLA580BT

Standard: FCC24.238
Test Start Date: 19-Apr-05
Test End Date: 19-Apr-05

Dipole Antenna Spurious Emissions

Polarity	Distance m	Substitution Antenna Type	Carrier	Frequency	Corrected Field Strength	Substituted SA Signal Level (uncorrected)	Power Applied to Antenna	Antenna Gain	Emission EIRP Level	EIRP Limit	Margin	Pass/Fail
				MHz	dBuV/m	dBuV	dBm	dBi	dBm	dBm*	dB	
H	3	B_3121C	CH25/CH78	628.75	42.00						42.37*	na
H	3	Horn SN6267	CH25/CH78	1222.50	59.29	28.86	-55.02	4.81	-50.21	-13.00	37.21	PASS
H	3	Horn SN6267	CH25/CH78	3108.75	68.88	61.93	-32.23	7.87	-24.36	-13.00	11.36	PASS
H	3	Horn SN6267	CH25/CH78	4331.25	64.25	53.61	-42.52	8.46	-34.06	-13.00	21.06	PASS
V	3	B_3121C	CH25/CH78	628.75	42.10						42.27*	na
V	3	Horn SN6267	CH25/CH78	1222.50	59.57						24.80*	na
V	3	Horn SN6267	CH25/CH78	3108.75	78.46	63.40	-35.71	7.87	-27.84	-13.00	14.84	PASS
V	3	Horn SN6267	CH25/CH78	4331.25	66.83	48.08	-43.75	8.46	-37.43	-13.00	24.43	PASS

Note: Intermod product field strength & theoretical margin presented for reference only.

Formulae:

EIRP Level (dBm) = Power applied to Antenna (dBm) + Antenna Gain (dBi)

Margin (dB) = Limit (dBm) - Level (dBm)

*The emissions reported above represent the highest emissions or noise floor measured at or near the inter-modulation product frequencies within the frequency band of 30MHz and the 10th harmonic of the carrier with field strengths within 20 dB of the theoretical limit. All other spurious emissions attributed to the EUT had field strengths greater than 20 dB below the theoretical limit or were presented in the single reports and substitutions were not made.

Applicant:	Itronix Corporation	Model:	IX260P-AC580BT	FCC ID:	KBCIX260P-AC580BT	IC ID:	1943A-IX260Pf
Rugged Laptop PC with Sierra Wireless AirCard 580 Dual-Band CDMA Modem and Cirronet BT2022 Bluetooth							
2005 Celltech Labs Inc. This document is not to be reproduced in whole or in part without the written permission of Celltech Labs Inc.							42 of 51

Test Report Serial No.:	050405KBC-T635-E24C/E15B	Issue 1
Test Date(s):	30th March - 19th April, 2005	
Test Type(s):	FCC §2, §15.247, §22H, §24E	IC RSS-210/132/133
Lab Registration(s):	FCC #714830	IC Lab File #3874

F.10. PASS/FAIL

In reference to the results outlined in F.9, the DUT passes the requirements as stated in the reference standards.

FCC CFR 4 §24.238 (a) Out of band emissions. The power of any emission outside of the authorized operating frequency ranges must be attenuated below the transmitting power (P) by a factor of at least $43 + 10 \log(P)$ dB.

The results set forth in this section meet the requirement with a margin of at least 11.36 dB.

F.11. SIGN-OFF

I attest to the accuracy of the data. All measurements reported herein were performed by me and are correct to the best of my knowledge and belief. I assume full responsibility for the completeness of these measurements.



Russell Pipe
Senior Compliance Technologist
Celltech Labs Inc.

19Apr05

Date

Applicant:	Itronix Corporation	Model:	IX260P-AC580BT	FCC ID:	KBCIX260P-AC580BT	IC ID:	1943A-IX260Pf
Rugged Laptop PC with Sierra Wireless AirCard 580 Dual-Band CDMA Modem and Cirronet BT2022 Bluetooth							
2005 Celltech Labs Inc. This document is not to be reproduced in whole or in part without the written permission of Celltech Labs Inc.							43 of 51

Test Report Serial No.:	050405KBC-T635-E24C/E15B	Issue 1
Test Date(s):	30th March - 19th April, 2005	
Test Type(s):	FCC §2, §15.247, §22H, §24E	IC RSS-210/132/133
Lab Registration(s):	FCC #714830	IC Lab File #3874

Appendix G - Maximum Permissible Exposure Calculation

G.1. REFERENCES

Normative Reference Standard	FCC CFR 47§1.1310
Procedure Reference	FCC CFR 47§2.1091, IEEE Std C95.1-1999

G.2. LIMITS

FCC CFR 47§1.1310 Table 1(b)	Frequency	Power Density
	300 – 1500 MHz	f/1500 mW/cm ²
	1500 – 100,000 MHz	1.0 mW/cm ²

G.3. ENVIRONMENTAL CONDITIONS

Temperature	na
Humidity	na
Barometric Pressure	na

G.4. EQUIPMENT LIST

ASSET NUMBER	MANUFACTURER	MODEL	DESCRIPTION	LAST CAL	CAL DUE
na					

G.5. MEASUREMENT EQUIPMENT SETUP

MEASUREMENT EQUIPMENT CONNECTIONS	The results described herein were determined by calculations, so no measurement equipment was used. The power measurements for each radio used in these calculations were made with the system transmitting as described in Appendix C and E of this report.
MEASUREMENT EQUIPMENT SETTINGS	na

G.6. SETUP PHOTOS

na

G.7. SETUP DRAWINGS

na

G.8. DUT OPERATING DESCRIPTION

Dual-Band CDMA	Power Measurement: The Dual-Band CDMA modem was set to transmit on the channel with the highest conducted output power level in each band with power settings equivalent to that described in Section 5 of this test report.
-----------------------	--

Test Report Serial No.:	050405KBC-T635-E24C/E15B	Issue 1
Test Date(s):	30th March - 19th April, 2005	
Test Type(s):	FCC §2, §15.247, §22H, §24E	IC RSS-210/132/133
Lab Registration(s):	FCC #714830	IC Lab File #3874

G.9. TEST RESULTS

G.9.1. Transmitter Calculations:

External Swivel Dipole Antenna (Highest Power Cellular CDMA Channel):

Ratio of Time on vs Total TX Time **1.00**

Tx Frequency:	848.31	(MHz)
RF Output Power at Antenna Input Terminal:	23.58	(dBm)
Source-Based Time -Average Factor	0.00	(dB)
Source-Based Time-Averaged RF Output Power at Antenna Input Terminal:	23.58	(dBm)
Antenna gain:	2.60	(dBi)

S= 0.57 (mW/cm²)
P= 228.0342 (mW)
G= 1.82 (numeric)

R = 7.64 (cm)

S at 20cm: 0.082463045 (mW/cm²)

External Swivel Dipole Antenna (Highest Power PCS CDMA Channel):

Ratio of Time on vs Total TX Time **1.00**

Tx Frequency:	1880.00	(MHz)
RF Output Power at Antenna Input Terminal:	25.01	(dBm)
Source-Based Time -Average Factor	0.00	(dB)
Source-Based Time-Averaged RF Output Power at Antenna Input Terminal:	25.01	(dBm)
Antenna gain:	2.60	(dBi)

S= 1.00 (mW/cm²)
P= 316.9567 (mW)
G= 1.82 (numeric)

R = 6.77 (cm)

S at 20cm: 0.114619726 (mW/cm²)

Formulae:

$$S = \frac{PG}{4\pi R^2}$$

$$R = \sqrt{\frac{P}{4\pi S}}$$

where: S = Power Density Limit
P = Power Applied to the Antenna
G = Numeric Antenna Gain
R = Distance from Antenna

Applicant:	Itronix Corporation	Model:	IX260P-AC580BT	FCC ID:	KBCIX260P-AC580BT	IC ID:	1943A-IX260Pf	
Rugged Laptop PC with Sierra Wireless AirCard 580 Dual-Band CDMA Modem and Cirronet BT2022 Bluetooth								
2005 Celltech Labs Inc. This document is not to be reproduced in whole or in part without the written permission of Celltech Labs Inc.							45 of 51	

Test Report Serial No.:	050405KBC-T635-E24C/E15B	Issue 1
Test Date(s):	30th March - 19th April, 2005	
Test Type(s):	FCC §2, §15.247, §22H, §24E	IC RSS-210/132/133
Lab Registration(s):	FCC #714830	IC Lab File #3874

Bluetooth (Highest Power Channel):

Ratio of Time on vs Total TX Time **1.00**

Tx Frequency: **2402.00** (MHz)
 RF Output Power at Antenna Input Terminal: **15.41** (dBm)
 Source-Based Time -Average Factor: **0.00** (dB)
 Source-Based Time-Averaged RF Output Power at Antenna Input Terminal: **15.41** (dBm)
 Antenna gain: **4.50** (dBi)

S = $\frac{1.00}{4\pi R^2}$ (mW/cm²)
 P = **34.7536** (mW)
 G = **2.82** (numeric)

R = 2.79 (cm)

S at 20cm: **0.019465222** (mW/cm²)

Formulae:

$S = \frac{PG}{4\pi R^2}$ where: S = Power Density Limit
 P = Power Applied to the Antenna
 G = Numeric Antenna Gain
 R = Distance from Antenna

$R = \sqrt{\frac{P}{4\pi S}}$

Results:

Mode	RF Conducted Output Power	Antenna Gain	MPE Distance	Power Density at 20 cm	Power Density Limit
	dBm	dBi	cm	mW/cm ²	mW/cm ²
Cellular - CDMA	23.58	2.6	7.64	0.0825	0.57
PCS - CDMA	25.01	2.6	6.77	0.1146	1.0
Bluetooth (CH0)	15.41	4.5	2.79	0.0195	1.0

G.9.2. Co-Transmit MPE Calculations

Radio	Power Density at 20 cm	Ratio	Power Density Limit
	mW/cm ²	(S / Limit)	mW/cm ²
Cellular - CDMA	0.0825	0.1458	0.5655
Bluetooth	0.0195	0.0195	1
Sum =		0.1653	1
PCS - CDMA	0.1146	0.1146	1
Bluetooth	0.0195	0.0195	1
Sum =		0.1341	1

Test Report Serial No.:	050405KBC-T635-E24C/E15B	Issue 1
Test Date(s):	30th March - 19th April, 2005	
Test Type(s):	FCC §2, §15.247, §22H, §24E	IC RSS-210/132/133
Lab Registration(s):	FCC #714830	IC Lab File #3874

G.10. PASS/FAIL

In reference to the results outlined in G.9 the DUT passes the requirements as stated in the reference standards as follows:

FCC CFR 47§1.1310 Table 1(b) 1) The DUT must comply with the minimum spacing requirement of 20 cm to ensure an exposure of not more than $f/1500$ (0.57) mW/cm^2 for frequencies between 300 and 1500 MHz and 1 mW/cm^2 for frequencies between 1500 and 100.000 MHz.

The sum of the combined ratios for the Cellular CDMA co-transmitting with Bluetooth is 0.1653. The sum of the combined ratios for the PCS CDMA co-transmitting with Bluetooth is 0.1341.

G.11. SIGN-OFF

I attest to the accuracy of the data. All measurements reported herein were performed by me and are correct to the best of my knowledge and belief. I assume full responsibility for the completeness of these measurements.



Duane M. Friesen, C.E.T.
EMC Manager
Celltech Labs Inc.

21Apr05

Date

Applicant:	Itronix Corporation	Model:	IX260P-AC580BT	FCC ID:	KBCIX260P-AC580BT	IC ID:	1943A-IX260Pf
Rugged Laptop PC with Sierra Wireless AirCard 580 Dual-Band CDMA Modem and Cirronet BT2022 Bluetooth							
2005 Celltech Labs Inc. This document is not to be reproduced in whole or in part without the written permission of Celltech Labs Inc.							47 of 51

Test Report Serial No.:	050405KBC-T635-E24C/E15B	Issue 1
Test Date(s):	30th March - 19th April, 2005	
Test Type(s):	FCC §2, §15.247, §22H, §24E	IC RSS-210/132/133
Lab Registration(s):	FCC #714830	IC Lab File #3874

Appendix H - Bluetooth Conducted RF Output Power Measurement

H.1. REFERENCES

Normative Reference Standard	§15.247 (b) (3)
Procedure Reference	ANSI/TIA/EIA-603-C, FCC 97-114, §2.1046 (a)

H.2. LIMITS

FCC CFR 47 §15.247	(b): The maximum peak output power of the intentional radiator shall not exceed the following: (b) (3) For system using digital modulation in the 902 - 928 MHz, 2400 - 2483.5 MHz, and 5725 - 5850 MHz bands: 1 Watt.		
The single transmit RF conducted output power levels were reported as:			
Transmitter	Channel	Frequency	Peak Conducted Power
		MHz	dBm
Bluetooth	0	2402	+15.68
	39	2441	+15.51
	78	2480	+15.05
*This is presented as a reference to determine the effects the co-transmission the CDMA modem made to the output RF power of the Bluetooth transmitter.			

H.3. ENVIRONMENTAL CONDITIONS

Temperature	25.2 +/- 2 °C
Humidity	35 +/- 2 %
Barometric Pressure	96.34 kPa

H.4. EQUIPMENT LIST

ASSET NUMBER	MANUFACTURER	MODEL	DESCRIPTION	LAST CAL	CAL DUE
00008	Gigatronics	8652A	Power Meter	30Apr04	30Apr05
00011	Gigatronics	80701A	Power Sensor	08Oct04	08Oct05
00107	HP	8491C	Attenuator	n/a	n/a

*Cable and attenuator verified with power meter prior to use

Test Report Serial No.:	050405KBC-T635-E24C/E15B	Issue 1
Test Date(s):	30th March - 19th April, 2005	
Test Type(s):	FCC §2, §15.247, §22H, §24E	IC RSS-210/132/133
Lab Registration(s):	FCC #714830	IC Lab File #3874

H.5. MEASUREMENT EQUIPMENT SETUP

Measurement Equipment Connections	The equipment was connected as shown in the setup drawing in I.6.
Measurement Equipment Settings	Power Meter Settings: Mode - MAP Frequency compensation set for carrier frequency Offset set appropriately to compensate for any attenuator or cable losses
Measurement Procedure	The Bluetooth transmitter RF conducted peak output power levels were measured at the DUT antenna connector port using a Gigatronics 8652A Universal Power Meter in mean average power mode. An offset was entered into the power meter to correct for the losses of the attenuator and cable installed between the output port and the power sensor input. The DUT test software was used to set the power and channel and at the same time the CDMA Modem was set to transmit at its max. power and channel for each band.

H.6. SETUP DRAWING

Figure H.6-1 - Setup Drawing

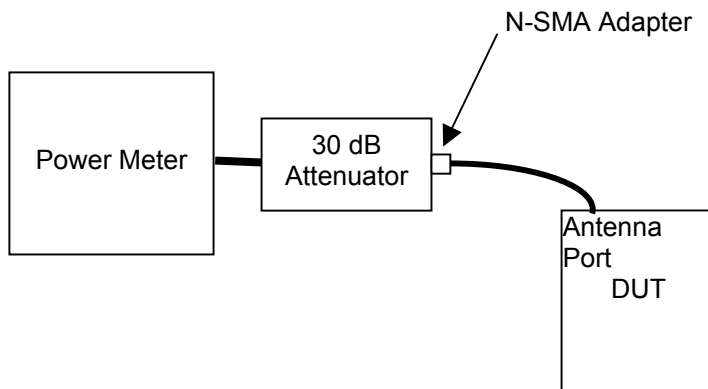

Test Report Serial No.:	050405KBC-T635-E24C/E15B	Issue 1
Test Date(s):	30th March - 19th April, 2005	
Test Type(s):	FCC §2, §15.247, §22H, §24E	IC RSS-210/132/133
Lab Registration(s):	FCC #714830	IC Lab File #3874

H.7. DUT OPERATING DESCRIPTION

Power measurements were made of each channel, with the CDMA modem and Bluetooth transmitter set appropriately as described in section 5.7 using the test software.

H.8. TEST RESULTS

Mode	Channel	Frequency	Peak Conducted Power
Co-transmitting with Channel 1013	0	2402 MHz	+15.41 dBm
	38	2441 MHz	+15.27 dBm
	79	2480 MHz	+14.85 dBm
Co-transmitting with Channel 25	0	2402 MHz	+15.38 dBm
	38	2441 MHz	+15.25 dBm
	79	2480 MHz	+14.81 dBm

H.9. PASS/FAIL

In reference to the results outlined in H.9, the DUT passes the requirements as stated in the reference standards as follows:

FCC 15.247 (b): The maximum peak output power of the intentional radiator shall not exceed the following:

(b) (3) For system using digital modulation in the 902 - 928 MHz, 2400 - 2483.5 MHz, and 5725 - 5850 MHz bands:
1 Watt.

A maximum conducted RF power of +15.41 dBm (0.035 Watts) was measured when Channel 0 was co-transmitting with the Cellular CDMA Channel 1013. The most significant output power change was measured in this configuration, with the power dropping by 0.3 dB from that measured with the Bluetooth in a single-transmit state.

H.10. SIGN-OFF

I attest to the accuracy of the data. All measurements reported herein were performed by me and are correct to the best of my knowledge and belief. I assume full responsibility for the completeness of these measurements.



Russell Pipe
Senior Compliance Technologist
Celltech Labs Inc.

30Mar05
Date

Applicant:	Itronix Corporation	Model:	IX260P-AC580BT	FCC ID:	KBCIX260P-AC580BT	IC ID:	1943A-IX260Pf
Rugged Laptop PC with Sierra Wireless AirCard 580 Dual-Band CDMA Modem and Cirronet BT2022 Bluetooth							
2005 Celltech Labs Inc. This document is not to be reproduced in whole or in part without the written permission of Celltech Labs Inc.							50 of 51

Test Report Serial No.:	050405KBC-T635-E24C/E15B	Issue 1
Test Date(s):	30th March - 19th April, 2005	
Test Type(s):	FCC §2, §15.247, §22H, §24E	IC RSS-210/132/133
Lab Registration(s):	FCC #714830	IC Lab File #3874

END OF DOCUMENT