

<b>Test Report S/N:</b>	050405KBC-T635-E15B	Issue 1
<b>Test Date(s):</b>	21Sept04 - 14Oct04, 22Oct04	
<b>Test Type(s):</b>	FCC §15.247	IC RSS-210 Issue 5
<b>Lab Registration(s):</b>	FCC #714830	IC Lab File #3874

**EMC TEST REPORT**  
FOR THE  
**ITRONIX RUGGED LAPTOP PC MODEL: IX260P-AC580BT**  
WITH  
**CIRRONET BT2022 BLUETOOTH TRANSMITTER**  
AND  
**INTERNAL RANGESTAR SURFACE-MOUNT ANTENNA**  
CO-LOCATED WITH  
**SIERRA WIRELESS DUAL-BAND CDMA PCMCIA MODEM**  
AND EXTERNAL SWIVEL DIPOLE ANTENNA

TRSN 050405KBC-T635-E15B  
Issue 1.0

**Celltech Compliance Testing & Engineering Lab**  
**(Celltech Labs Inc.)**  
**1955 Moss Court**  
**Kelowna, BC**  
**Canada**  
**V1Y 9L3**

**May 13, 2005**

<b>Test Report S/N:</b>	050405KBC-T635-E15B	Issue 1
<b>Test Date(s):</b>	21Sept04 - 14Oct04, 22Oct04	
<b>Test Type(s):</b>	FCC §15.247	IC RSS-210 Issue 5
<b>Lab Registration(s):</b>	FCC #714830	IC Lab File #3874

## DECLARATION OF COMPLIANCE

<b>Test Lab</b>		<b>Applicant Information</b>	
<b>CELLTECH LABS INC.</b> Testing and Engineering Services 1955 Moss Court Kelowna, B.C. Canada V1Y 9L3  <b>Phone:</b> 250-448-7047 <b>Fax:</b> 250-448-7048 <b>e-mail:</b> info@celltechlabs.com <b>web site:</b> www.celltechlabs.com		<b>ITRONIX CORPORATION</b> 801 South Stevens Street Spokane, WA 99204 United States	
<b>Laboratory Registration No.(s):</b>	FCC: 714830	IC: IC 3874	
<b>Rule Part(s):</b>	FCC: §15.247; §2.1091; §1.1310	IC: RSS-210 Issue 5 - A1. 11/30/02	
<b>Device Classification:</b>	FCC: Spread Spectrum Transmitter (DSS)	IC: Low Power Licence-Exempt Transmitter	
<b>Device Identification:</b>	FCC ID: KBCIX260P-AC580BT	IC: 1943A-IX260Pf	
<b>DUT Description:</b>			
<b>Model:</b>	IX260P-AC580BT		
<b>Device Description:</b>	Rugged Laptop PC		
<b>Internal Transmitter:</b>	Cirronet BT2022 Bluetooth		
<b>Co-located Transmitter(s):</b>	Sierra Wireless Dual-Band PCS/Cellular CDMA PCMCIA Modem		
<b>Tx Frequency Range:</b>	2402 - 2480 MHz		
<b>Max. RF Output Power:</b>	0.0364 Watts / 15.61 dBm (Peak Conducted)		
<b>Mode(s) of Operation:</b>	Frequency Hopping Spread Spectrum (FHSS)		
<b>Modulation(s):</b>	GFSK 1 Mbps 0.5 BT Gaussian		
<b>Antenna Type(s):</b>	Bluetooth: RangeStar P/N: 100929 Internal Surface-Mount (upper left side edge of LCD Display) Dual-Band CDMA: Itronix IX260+ External Swivel Dipole (upper right side edge of LCD Display)		
<b>Power Source(s):</b>	11.1 V Lithium-ion Battery, 6.0 Ah (Model: A2121-2) 90 Watt AC Power Adapter (Model: ADP-90AB)		

This wireless mobile device has demonstrated compliance with the applicable technical standards as indicated in the measurement report and was tested in accordance with the measurement procedures specified in FCC 47 CFR Part 15(C), Industry Canada RSS-210 Issue 5, and ANSI TIA/EIA-603-C-2004.

I attest to the accuracy of the data. All measurements reported herein were performed by me or were under my supervision and are correct to the best of my knowledge and belief. I assume full responsibility for the completeness of these measurements and vouch for the qualifications of all persons taking them.

This test report shall not be reproduced partially, or in full, without the prior written approval of Celltech Labs Inc. The results and statements contained in this report pertain only to the device(s) evaluated.



**Russell Pipe**  
Senior Compliance Technologist  
Celltech Labs Inc.



**Duane M. Friesen**  
EMC Manager  
Celltech Labs Inc.



<b>Applicant:</b> Itronix Corporation	<b>Model:</b> IX260P-AC580BT	<b>FCC ID:</b> KBCIX260P-AC580BT	<b>IC ID:</b> 1943A-IX260Pf
<b>Rugged Laptop PC with Cirronet BT2022 Bluetooth and co-located Sierra Wireless Dual-Band CDMA</b>			
2005 Celltech Labs Inc. This document is not to be reproduced in whole or in part without the written permission of Celltech Labs Inc.			2 of 45

<b>Test Report S/N:</b>	050405KBC-T635-E15B	Issue 1
<b>Test Date(s):</b>	21Sept04 - 14Oct04, 22Oct04	
<b>Test Type(s):</b>	FCC §15.247	IC RSS-210 Issue 5
<b>Lab Registration(s):</b>	FCC #714830	IC Lab File #3874

## TABLE OF CONTENTS

1.0 SCOPE .....	6
2.0 REFERENCES .....	6
2.1 Normative References .....	6
3.0 TERMS AND DEFINITIONS .....	7
4.0 FACILITIES AND ACCREDITATIONS .....	8
5.0 GENERAL INFORMATION .....	8
5.1 Applicant Information .....	8
5.2 DUT Description.....	8
5.3 Co-Located Equipment .....	9
5.4 Cable Descriptions.....	9
5.5 Support Equipment .....	9
5.6 Clock Frequencies .....	10
5.7 Mode(s) of Operation Tested .....	10
5.8 Configuration Description .....	11
6.0 PASS/FAIL CRITERIA.....	11
APPENDICES.....	12
Appendix A - DUT Photographs .....	13
Appendix B - Conducted Powerline Emissions Measurement .....	14
Appendix C - Peak Conducted RF Output Power Measurement .....	21
Appendix D - Adjacent Channel Separation .....	24
Appendix E - Number of Hopping Channels.....	25
Appendix F - Channel Dwell Time .....	26
Appendix G - 20 dB Bandwidth Measurement.....	27
Appendix H - Radiated Spurious Emissions Measurement.....	28
Appendix I - Restricted Band Emissions Measurement .....	34
Appendix J - Maximum Permissible Exposure Calculation .....	42
END OF DOCUMENT.....	45

<b>Test Report S/N:</b>	050405KBC-T635-E15B	Issue 1
<b>Test Date(s):</b>	21Sept04 - 14Oct04, 22Oct04	
<b>Test Type(s):</b>	FCC §15.247	IC RSS-210 Issue 5
<b>Lab Registration(s):</b>	FCC #714830	IC Lab File #3874

## FIGURES

Figure B-1 - Setup Drawing .....	17
Figure C-1 - Setup Drawing .....	22
Figure H-1 - Setup Drawing .....	29
Figure I-1 - Setup Drawing.....	36

## PHOTOGRAPHS

Photograph A-1 - Front of Open IX260+ Laptop PC.....	13
Photograph A-2 - Back of Open IX260+ Laptop PC.....	13
Photograph A-3 - Left Side of Open IX260+ Laptop PC.....	13
Photograph A-4 - Right Side of Open IX260+ Laptop PC .....	13
Photograph B-1 - AC Powerline Conducted Emission Configuration.....	16
Photograph B-2 - AC Powerline Conducted Emission Cable Placement.....	16
Photograph H-1 - 3115 Horn Antenna (1-18GHz).....	30
Photograph H-2 - 3160-09 Horn Antenna (18-26GHz).....	30
Photograph I-1 - Loop Antenna (10kHz -30MHz).....	37
Photograph I-2 - Bilog Antenna (30MHz - 1 GHz).....	37
Photograph I-3 - Horizontal Polarization (30MHz - 1 GHz).....	37
Photograph I-4 - Vertical Polarization (30MHz - 1 GHz) .....	37
Photograph I-5 - Front of Radiated Emission Configuration .....	38
Photograph I-6 - Back of Radiated Emission Configuration.....	38

<b>Test Report S/N:</b>	050405KBC-T635-E15B	Issue 1
<b>Test Date(s):</b>	21Sept04 - 14Oct04, 22Oct04	
<b>Test Type(s):</b>	FCC §15.247	IC RSS-210 Issue 5
<b>Lab Registration(s):</b>	FCC #714830	IC Lab File #3874

### TEST SUMMARY

#### Referenced Standard: FCC CFR Title 47 Part 15

Appendix	Test Description	Procedure Reference	Limit Reference	Test Start Date	Test End Date	Result
B	Powerline Conducted Emissions	ANSI C63.4	§15.207	14Oct04	14Oct04	Pass
C	Peak Conducted RF Power	FCC 97-114	§15.247 (b) (1)	21Sep04	21Sep04	Pass
D	Adjacent Channel Separation	Note 1	§15.247 (a) (1)	Note 1	Note 1	Pass
E	Number of Hopping Channels	Note 1	§15.247 (a) (1) (iii)	Note 1	Note 1	Pass
F	Channel Dwell Time	Note 1	§15.247 (a) (1) §15.247 (a) (1) (iii)	Note 1	Note 1	Pass
G	20 dB Bandwidth	Note 1	§15.247 (a) (1) (iii)	Note 1	Note 1	Pass
H	Radiated Spurious Emissions	FCC 97-114	§15.247(c)	22Sep04	01Oct04 22Oct04	Pass
I	Restricted Band Emissions	FCC 97-114	§15.205 (a), (b) §15.209 (a)	22Sep04	01Oct04 22Oct04	Pass
J	Maximum Permissible Exposure	FCC CFR 47 § 2.1091 IEEE Std C95.1-1992	§1.1310 Table 1 (b)	na	na	Pass

#### Referenced Standard: IC RSS-210 Issue 5



B	Powerline Conducted Emissions	RSS-212, ANSI C63.4	RSS-210 §6.6	14Oct04	14Oct04	Pass
C	Peak Conducted RF Power	RSS-210 § 10	RSS-210 §6.2.2 (o)(a3)	21Sep04	21Sep04	Pass
D	Adjacent Channel Separation	RSS-210 § 10	RSS-210 A1 §I (ii)	Note 1	Note 1	Pass
E	Number of Hopping Channels	RSS-210 § 10	RSS-210 A1 §I (ii)	Note 1	Note 1	Pass
F	Channel Dwell Time	RSS-210 § 10	RSS-210 A1 §I (ii)	Note 1	Note 1	Pass
G	20 dB Bandwidth	RSS-210 § 10	RSS-210 A1 §I (ii)	Note 1	Note 1	Pass
H	Radiated Spurious Emissions	RSS-212, ANSI C63.4	RSS-210 §6.2.2 (o)(e1)	22Sep04	01Oct04 22Oct04	Pass
I	Restricted Band Emissions	RSS-212, ANSI C63.4	RSS-210 §6.3	22Sep04	01Oct04 22Oct04	Pass
J	Maximum Permissible Exposure	RSS-102	RSS-210 §14 Safety Code 6 2.2.1(a) Table 5	na	na	Pass

Note 1: The test procedures used and the results obtained are referenced to the ACS Test Report Number 03-0193-15BC.

### REVISION LOG

Issue	Description	Implemented By	Implementation Date
1.0	Initial Release	Jon Hughes	13May05

### SIGNATORIES

Prepared By		May 13, 2005
Name/Title	Duane M. Friesen, C.E.T. / EMC Manager	Date
Approved By		May 13, 2005
Name/Title	Jon Hughes / General Manager	Date

<b>Applicant:</b>	Itronix Corporation	<b>Model:</b>	IX260P-AC580BT	<b>FCC ID:</b>	KBCIX260P-AC580BT	<b>IC ID:</b>	1943A-IX260Pf
<b>Rugged Laptop PC with Cirronet BT2022 Bluetooth and co-located Sierra Wireless Dual-Band CDMA</b>							
2005 Celltech Labs Inc This document is not to be reproduced in whole or in part without the written permission of Celltech Labs Inc.							5 of 45

<b>Test Report S/N:</b>	050405KBC-T635-E15B	Issue 1
<b>Test Date(s):</b>	21Sept04 - 14Oct04, 22Oct04	
<b>Test Type(s):</b>	FCC §15.247	IC RSS-210 Issue 5
<b>Lab Registration(s):</b>	FCC #714830	IC Lab File #3874

## 1.0 SCOPE

This report outlines the measurements made and results collected during electromagnetic emissions testing of the Itronix Corporation IX260+ Rugged Laptop PC with internal Cirronet BT2022 Bluetooth Transmitter and RangeStar internal surface-mount antenna, co-located with internal Sierra Wireless Dual-Band CDMA PCMCIA Modem and external swivel dipole antenna. **The Cirronet BT2022 Bluetooth transmitter and Sierra Wireless Dual-Band CDMA Modem can transmit simultaneously. The Sierra Wireless Dual-Band CDMA PCMCIA Modem was disabled during the Cirronet BT2022 Bluetooth single-transmit measurements referenced in this report. Please refer to the Supplementary EMC test report for simultaneous transmit measurement data.** The results were applied against the EMC requirements and limits outlined in the technical rules and regulations set forth in the Federal Communication Commission Code of Federal Regulations Title 47 Part 15 Subpart C, and Industry Canada Radio Standards Specification RSS-210 Issue 5.

## 2.0 REFERENCES

### 2.1 Normative References

ANSI/ISO 17025:1999	General Requirements for competence of testing and calibration laboratories
IEEE/ANSI C63.4-2003	Methods of Measurement of Radio-Noise Emissions from Low-Voltage Electrical and Electronic Equipment in the Range of 9 kHz to 40 GHz
IEEE/ANSI Std C95.1-1999	American National Standard Safety Levels with Respect to Human Exposure to Radio Frequency Electromagnetic Fields
CFR Title 47 Part 2:2003	Code of Federal Regulations Title 47: Telecommunication Part 2: Frequency Allocations and Radio Treaty Matters; General Rules and Regulations
CFR Title 47 Part 15:2003	Code of Federal Regulations Title 47: Telecommunication Part 15: Radio Frequency Devices
IC Spectrum Management & Telecommunications Policy	Radio Standards Specification RSS-212 Issue 1 (Provisional) - Test Facilities & Test Methods for Radio Equipment RSS-210 Issue 5 - Low Power Licence-Exempt Radiocommunication Devices: November 2001 & Amendment November 30, 2002 RSS-102 Issue 1 (Provisional) - Evaluation Procedure for Mobile and Portable Radio Transmitters with respect to Health Canada's Safety Code 6 for Exposure of Humans to Radio Frequency Fields
ACS Test Report	FCC Part 15 Certification Test Report 2.4 GHz Frequency Hopping Spread Spectrum (Modular Approval) ACS Report Number 03-0193-15BC Issue Date: January 5, 2004

<b>Applicant:</b>	Itronix Corporation	<b>Model:</b>	IX260P-AC580BT	<b>FCC ID:</b>	KBCIX260P-AC580BT	<b>IC ID:</b>	1943A-IX260Pf
<b>Rugged Laptop PC with Cirronet BT2022 Bluetooth and co-located Sierra Wireless Dual-Band CDMA</b>							
2005 Celltech Labs Inc This document is not to be reproduced in whole or in part without the written permission of Celltech Labs Inc.							6 of 45

<b>Test Report S/N:</b>	050405KBC-T635-E15B	Issue 1
<b>Test Date(s):</b>	21Sept04 - 14Oct04, 22Oct04	
<b>Test Type(s):</b>	FCC §15.247	IC RSS-210 Issue 5
<b>Lab Registration(s):</b>	FCC #714830	IC Lab File #3874

### 3.0 TERMS AND DEFINITIONS

AVG	Average
CFR	Code of Federal Regulations
dB	decibel
dBm	dB referenced to 1 mW
dBuV	dB referenced to 1 uV
DUT	Device under Test
dBc	dB down from carrier
EBW	Emission Bandwidth
EMC	Electromagnetic Compatibility
FCC	Federal Communication Commission
FHSS	Frequency Hopping Spread Spectrum
HP	Hewlett Packard
HPF	High Pass Filter
Hpol	Horizontal Polarization
Hz	Hertz
IC	Industry Canada
kHz	kilohertz
LNA	Low Noise Amplifier
m	meter
MHz	Megahertz
Mbps	megabits per second
na	not applicable
n/a	not available
PK	Peak
PPSD	Peak Power Spectral Density
QP	Quasi-peak
RBW	Resolution Bandwidth
R&S	Rohde & Schwarz
RSS	Radio Standard Specification
SA	Spectrum Analyzer
VBW	Video Bandwidth
Vpol	Vertical Polarization
WLAN	Wireless Local Area Network

<b>Applicant:</b>	<b>Itronix Corporation</b>	<b>Model:</b>	<b>IX260P-AC580BT</b>	<b>FCC ID:</b>	<b>KBCIX260P-AC580BT</b>	<b>IC ID:</b>	<b>1943A-IX260Pf</b>
<b>Rugged Laptop PC with Cirronet BT2022 Bluetooth and co-located Sierra Wireless Dual-Band CDMA</b>							
2005 Celltech Labs Inc This document is not to be reproduced in whole or in part without the written permission of Celltech Labs Inc.							7 of 45

#### 4.0 FACILITIES AND ACCREDITATIONS

The facilities used in collecting the test results outlined in this report are located at 1955 Moss Court, Kelowna, British Columbia, Canada, V1Y 9L3. The radiated and conducted emissions sites conform with the requirements set forth in ANSI C63.4 and are filed and listed with the FCC under Registration Number 714830 and Industry Canada under File Number IC 3874.

#### 5.0 GENERAL INFORMATION

##### 5.1 Applicant Information

<b>Company Name:</b>	<b>Itronix Corporation</b>
<b>Address:</b>	801 South Stevens Street Spokane, WA 99204 United States

##### 5.2 DUT Description

The DUT consisted of the IX260+ Rugged Laptop PC with the Cirronet BT2022 Bluetooth Transmitter connected to the RangeStar Internal Surface-Mount Antenna installed in the upper left side rear of the LCD display. The IX260+ Rugged Laptop PC also included a co-located Sierra Wireless Dual-Band CDMA PCMCIA Modem and external swivel dipole antenna installed on the upper right side edge of the LCD display. Photographs of the DUT placement and construction are shown in Appendix A.

<b>Device:</b>	IX260+ Rugged Laptop PC		
<b>Model:</b>	IX260P-AC580BT		
<b>Serial Number:</b>	ZZGEG4196ZZ6473		
<b>Identifier(s):</b>	<b>FCC ID:</b>	KBCIX260P-AC580BT	<b>IC:</b> 1943A-IX260Pf
<b>Power Source(s):</b>	Delta Electronics 90 Watt AC-DC Power Supply (Model ADP-90AB Rev B) 11.1 V Lithium-ion Battery, 6.0 Ah (Model: A2121-2)		

<b>Device:</b>	2.4GHz FHSS Bluetooth Transmitter		
<b>Model:</b>	Cirronet BT2022		
<b>Serial Number:</b>	n/a		
<b>Rule Part(s):</b>	<b>FCC:</b>	§15.247; §2.1091; §1.1310	<b>IC:</b> RSS-210 Issue 5 - A1. 11/30/02
<b>Classification:</b>	<b>FCC:</b>	Spread Spectrum Transmitter (DSS)	<b>IC:</b> Low Power Licence-Exempt Transmitter
<b>Power Source:</b>	Powered from the internal PC power supply		

<b>Device:</b>	Internal Surface-Mount Antenna (upper left side edge of LCD display)		
<b>Model:</b>	RangeStar P/N: 100929		
<b>Gain:</b>	+4.5 dBi		



<b>Test Report S/N:</b>	050405KBC-T635-E15B	Issue 1
<b>Test Date(s):</b>	21Sept04 - 14Oct04, 22Oct04	
<b>Test Type(s):</b>	FCC §15.247	IC RSS-210 Issue 5
<b>Lab Registration(s):</b>	FCC #714830	IC Lab File #3874

### 5.3 Co-Located Equipment

<b>Device:</b>	Dual-Band PCS/Cellular CDMA PCMCIA Modem		
<b>Model:</b>	Sierra Wireless AirCard		
<b>Rule Part(s):</b>	<b>FCC:</b>	§2; §22(H), §24(E)	<b>IC:</b> RSS-133 Issue 2; RSS-132 Issue 1 (Provisional)
<b>Power Source:</b>	Powered from the internal PC power supply		
<b>Antenna Type:</b>	External Mounted Swivel Dipole (upper right side edge of LCD display)		
<b>Model:</b>	IX260+		
<b>Gain:</b>	+2.6 dBi		

<b>Device:</b>	GPS Receiver Module and Antenna (Receive only)		
<b>Model:</b>	Leadtek P/N GPS9547		

### 5.4 Cable Descriptions

ROUTING		Length m	Model	Terminations		Shield Type	Shield Termination		Suppression
From	To			End 1	End 2		End 1	End 2	
PC Fire Wire Port	Unterminated	1.0	Copartner E119932	IEEE-1528	Fire wire	n/a	n/a	n/a	None
PC modem port	Unterminated	1.0	n/a	RJ-11	RJ-11	None	na	na	None
PC Ethernet Port	Ethernet Hub	1.0	N/a	RJ-45	RJ-45	None	na	na	None

### 5.5 Support Equipment

The following equipment was used in support of the DUT.

CO-LOCATED SUPPORT EQUIPMENT LIST		
MANUFACTURER	MODEL	DESCRIPTION
D-Link	DE-809TC/	Ethernet hub
YNG YUH	YP-040	Hub power supply
MLi	699	Speakers
Polk Audio	n/a	Speaker-microphone
DeLorme	Tripmate	GPS Receiver
Intel	CS-430	Camera
Logitech	M-S34	Mouse

<b>Applicant:</b>	Itronix Corporation	<b>Model:</b>	IX260P-AC580BT	<b>FCC ID:</b>	KBCIX260P-AC580BT	<b>IC ID:</b>	1943A-IX260Pf
<b>Rugged Laptop PC with Cirronet BT2022 Bluetooth and co-located Sierra Wireless Dual-Band CDMA</b>							
2005 Celltech Labs Inc This document is not to be reproduced in whole or in part without the written permission of Celltech Labs Inc.							9 of 45

## 5.6 Clock Frequencies

### 5.6.1 DUT Clock Frequencies

<b>Device:</b>	Rugged Laptop PC
<b>Clocks:</b>	1.6 GHz processor
<b>Device:</b>	2.4GHz FHSS Cirronet Bluetooth
<b>Clocks:</b>	n/a
<b>Device:</b>	Dual-Band CDMA Modem
<b>Clocks:</b>	n/a
<b>Device:</b>	External Swivel Dipole Antenna
<b>Clocks:</b>	None
<b>Device:</b>	Internal Surface-Mount Antenna
<b>Clocks:</b>	None

### 5.6.2 Co-Located Clock Frequencies

<b>Device:</b>	Peripherals
<b>Clocks:</b>	n/a

## 5.7 Mode(s) of Operation Tested

Customer supplied software was used to place the Bluetooth transmitter at the appropriate channel with the power level and modulation for the specific measurement.

<b>TX Frequency Range</b>	2402 - 2480 MHz Ch. 0 (2402 MHz), Ch. 39 (2441 MHz) & Ch. 78 (2480 MHz) measured unless otherwise noted)
<b>Software Power Gain Settings</b>	Ch. 0 - 250 / 40 Ch. 39 - 250 / 44 Ch. 78 - 220 / 45
<b>RF Peak Conducted Output Power Tested</b>	Ch. 0 - +15.40 dBm Ch. 39 - +15.61 dBm Ch. 78 - +15.34 dBm
<b>Modulation Type</b>	GFSK 0.5 BT Gaussian
<b>Modulation Frequency</b>	1000
<b>Battery Type(s)</b>	11.1V Lithium-Ion, 6.0Ah (Model: A2121-2)

### 5.7.1 DUT Exercising Software Description

The DUT was configured and exercised using customer supplied test software that allowed an operator to set the parameters of the Bluetooth transmitter's operation. The settings used are described in each appendix.

<b>Applicant:</b>	Itronix Corporation	<b>Model:</b>	IX260P-AC580BT	<b>FCC ID:</b>	KBCIX260P-AC580BT	<b>IC ID:</b>	1943A-IX260Pf
<b>Rugged Laptop PC with Cirronet BT2022 Bluetooth and co-located Sierra Wireless Dual-Band CDMA</b>							
2005 Celltech Labs Inc This document is not to be reproduced in whole or in part without the written permission of Celltech Labs Inc.							10 of 45

<b>Test Report S/N:</b>	050405KBC-T635-E15B	Issue 1
<b>Test Date(s):</b>	21Sept04 - 14Oct04, 22Oct04	
<b>Test Type(s):</b>	FCC §15.247	IC RSS-210 Issue 5
<b>Lab Registration(s):</b>	FCC #714830	IC Lab File #3874

## 5.8 Configuration Description

The DUT was configured, as described by the client as being representative of what would be delivered to a final customer. More specific details may be included in each appendix.

### 5.8.1 Configuration Justification

The DUT was tested in a configuration described by the client as being worse case but typical of normal use.

Prescan measurements were made with the Bluetooth transmitter set at each of three frequencies describing the frequency band of operation; low (2402 MHz), mid (2441 MHz) and high (2480 MHz) to determine the highest emission present in each band. The transmit power setting for each of these frequencies was set to closely match that defined in the modular certification. A representative modulation of 1000 was applied when applicable. Unless otherwise specified in the applicable appendices, these settings were used for the measurements described in this report.

## 6.0 PASS/FAIL CRITERIA

Unless otherwise noted in the Appendices, the pass/fail criteria is the limit set forth in the reference standards. A DUT is considered to have passed the requirements, if the data collected during the described measurement procedure is no greater than the specified limits as defined. The pass/fail statements made in this report only apply to the unit tested.

<b>Applicant:</b>	Itronix Corporation	<b>Model:</b>	IX260P-AC580BT	<b>FCC ID:</b>	KBCIX260P-AC580BT	<b>IC ID:</b>	1943A-IX260Pf
<b>Rugged Laptop PC with Cirronet BT2022 Bluetooth and co-located Sierra Wireless Dual-Band CDMA</b>							
2005 Celltech Labs Inc This document is not to be reproduced in whole or in part without the written permission of Celltech Labs Inc.							11 of 45

<b>Test Report S/N:</b>	050405KBC-T635-E15B	Issue 1
<b>Test Date(s):</b>	21Sept04 - 14Oct04, 22Oct04	
<b>Test Type(s):</b>	FCC §15.247	IC RSS-210 Issue 5
<b>Lab Registration(s):</b>	FCC #714830	IC Lab File #3874

## APPENDICES

<b>Applicant:</b>	Itronix Corporation	<b>Model:</b>	IX260P-AC580BT	<b>FCC ID:</b>	KBCIX260P-AC580BT	<b>IC ID:</b>	1943A-IX260Pf
<b>Rugged Laptop PC with Cirronet BT2022 Bluetooth and co-located Sierra Wireless Dual-Band CDMA</b>							
2005 Celltech Labs Inc This document is not to be reproduced in whole or in part without the written permission of Celltech Labs Inc.							12 of 45

<b>Test Report S/N:</b>	050405KBC-T635-E15B	Issue 1
<b>Test Date(s):</b>	21Sept04 - 14Oct04, 22Oct04	
<b>Test Type(s):</b>	FCC §15.247	IC RSS-210 Issue 5
<b>Lab Registration(s):</b>	FCC #714830	IC Lab File #3874

### Appendix A - DUT Photographs

Photograph A-1 - Front of Open IX260+ Laptop PC



Photograph A-2 - Back of Open IX260+ Laptop PC



Photograph A-3 - Left Side of Open IX260+ Laptop PC



Photograph A-4 - Right Side of Open IX260+ Laptop PC



<b>Applicant:</b>	Itronix Corporation	<b>Model:</b>	IX260P-AC580BT	<b>FCC ID:</b>	KBCIX260P-AC580BT	<b>IC ID:</b>	1943A-IX260Pf
<b>Rugged Laptop PC with Cirronet BT2022 Bluetooth and co-located Sierra Wireless Dual-Band CDMA</b>							
2005 Celltech Labs Inc This document is not to be reproduced in whole or in part without the written permission of Celltech Labs Inc.							13 of 45

## Appendix B - Conducted Powerline Emissions Measurement

B.1. REFERENCES	
Normative Reference Standard	CFR 47 FCC Part 15 §15.207
Procedure Reference	ANSI C63.4

B.2. LIMITS		
§15.207: Compliance with the provisions of this paragraph shall be based on the measurement of the radio frequency voltage between each powerline and ground at the power terminal.		
Frequency of Emission (MHz)	Conducted Limit (dBuV)	
	Quasi-Peak	Average
0.15 – 0.5	66 to 56*	56 to 46*
0.50 – 5.0	56	46
5.0 – 30.0	60	50

\*Decreases with the logarithm of the frequency

B.3. ENVIRONMENTAL CONDITIONS	
Temperature	+26 ± 5 °C
Humidity	31 % ± 10% RH
Barometric Pressure	101.4 kpa

B.4. EQUIPMENT LIST					
ASSET NUMBER	MANUFACTURER	MODEL	DESCRIPTION	LAST CAL	CAL DUE
00063	HP	85662A	Spectrum Analyzer Display	na	na
00051	HP	8566B	Spectrum Analyzer RF Section	18May04	18May05
00049	HP	85650A	Quasi-Peak Adapter	18May04	18May05
00047	HP	85685A	Preselector	18May04	18May05
00083	EMCO	3825/2	Line Impedance Stabilization Network	29Apr04	29Apr05
00084	EMCO	3825/2	Line Impedance Stabilization Network	29Apr04	29Apr05

<b>Test Report S/N:</b>	050405KBC-T635-E15B	Issue 1
<b>Test Date(s):</b>	21Sept04 - 14Oct04, 22Oct04	
<b>Test Type(s):</b>	FCC §15.247	IC RSS-210 Issue 5
<b>Lab Registration(s):</b>	FCC #714830	IC Lab File #3874

<b>B.5. MEASUREMENT EQUIPMENT SETUP</b>	
<b>MEASUREMENT EQUIPMENT CONNECTIONS</b>	The conducted emissions were measured on each of the two AC powerline leads connected to the DUT's power supply brick. A two line LISN was used to make this measurement. A drawing of the equipment setup is shown in B.7
<b>MEASUREMENT EQUIPMENT SETTINGS</b>	<p>Each of the monitor ports from the 2-line LISN was connected in turn to the spectrum analyzer. The port not connected to the analyzer was terminated in a 50-ohm load. A pre-scan of the peak emission levels was made of the 150 kHz – 30 MHz range split into 4 equal frequency bands. The following were the instrumentation settings:</p> <p>Spectrum Analyzer:            Start Frequency and Stop Frequency set by software for each of the four bands            RBW: 100 kHz            VBW: 300 kHz            Sweep: 500 mS</p> <p>Quasi-Peak Adapter:            Normal - Automatic Bandwidth Setting: 9 kHz</p> <p>The resulting data from each band was corrected and collected by software and presented in the graphical representations shown in B.9 for the two leads.</p> <p>A defined set of frequency points of interest on each lead were used by software to optimize a set of readings for each type of detector (peak, quasi-peak and average). This data was corrected by the software and is presented in the tables shown in section B.9.</p>

<b>Applicant:</b>	Itronix Corporation	<b>Model:</b>	IX260P-AC580BT	<b>FCC ID:</b>	KBCIX260P-AC580BT	<b>IC ID:</b>	1943A-IX260Pf
<b>Rugged Laptop PC with Cirronet BT2022 Bluetooth and co-located Sierra Wireless Dual-Band CDMA</b>							
2005 Celltech Labs Inc This document is not to be reproduced in whole or in part without the written permission of Celltech Labs Inc.							15 of 45



<b>Test Report S/N:</b>	050405KBC-T635-E15B	Issue 1
<b>Test Date(s):</b>	21Sept04 - 14Oct04, 22Oct04	
<b>Test Type(s):</b>	FCC §15.247	IC RSS-210 Issue 5
<b>Lab Registration(s):</b>	FCC #714830	IC Lab File #3874

**B.6. SETUP PHOTOS**

Photograph B-1 - AC Powerline Conducted Emission Configuration



Photograph B-2 - AC Powerline Conducted Emission Cable Placement



<b>Applicant:</b>	Itronix Corporation	<b>Model:</b>	IX260P-AC580BT	<b>FCC ID:</b>	KBCIX260P-AC580BT	<b>IC ID:</b>	1943A-IX260Pf
<b>Rugged Laptop PC with Cirronet BT2022 Bluetooth and co-located Sierra Wireless Dual-Band CDMA</b>							
2005 Celltech Labs Inc This document is not to be reproduced in whole or in part without the written permission of Celltech Labs Inc.							16 of 45



### B.7. SETUP DRAWING

Figure B-1 - Setup Drawing

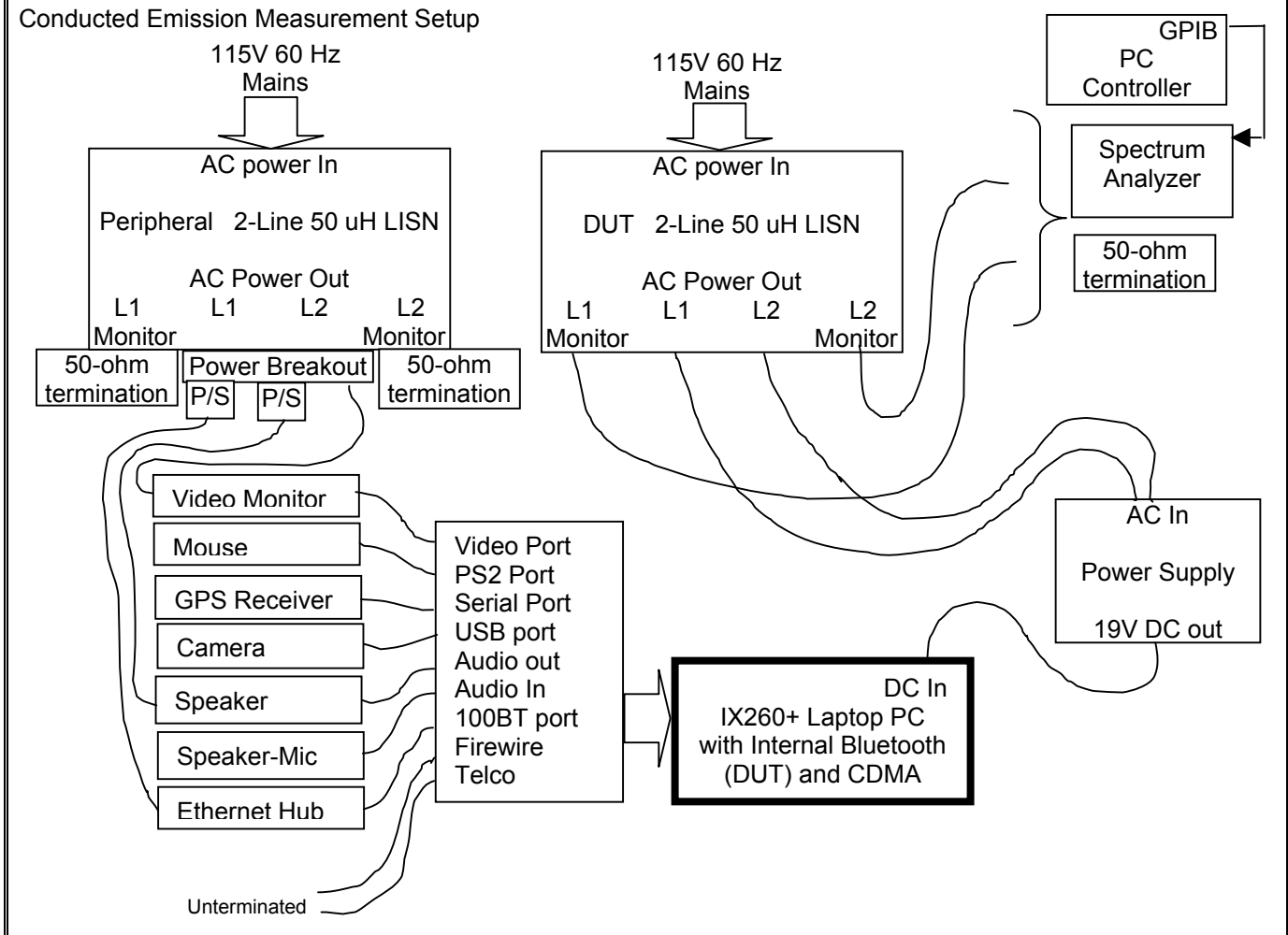



### B.8. DUT OPERATING DESCRIPTION

<b>Bluetooth</b>	The Bluetooth transmitter was set to transmit at full power on Channel 39 (2441 MHz) with a 1000 modulation setting.
<b>PC</b>	Other than operating the Bluetooth software and running MS windows, no PC exercising was performed.
<b>Peripherals</b>	All peripherals were active, but no specific traffic was initiated.

### B.9. TEST RESULTS

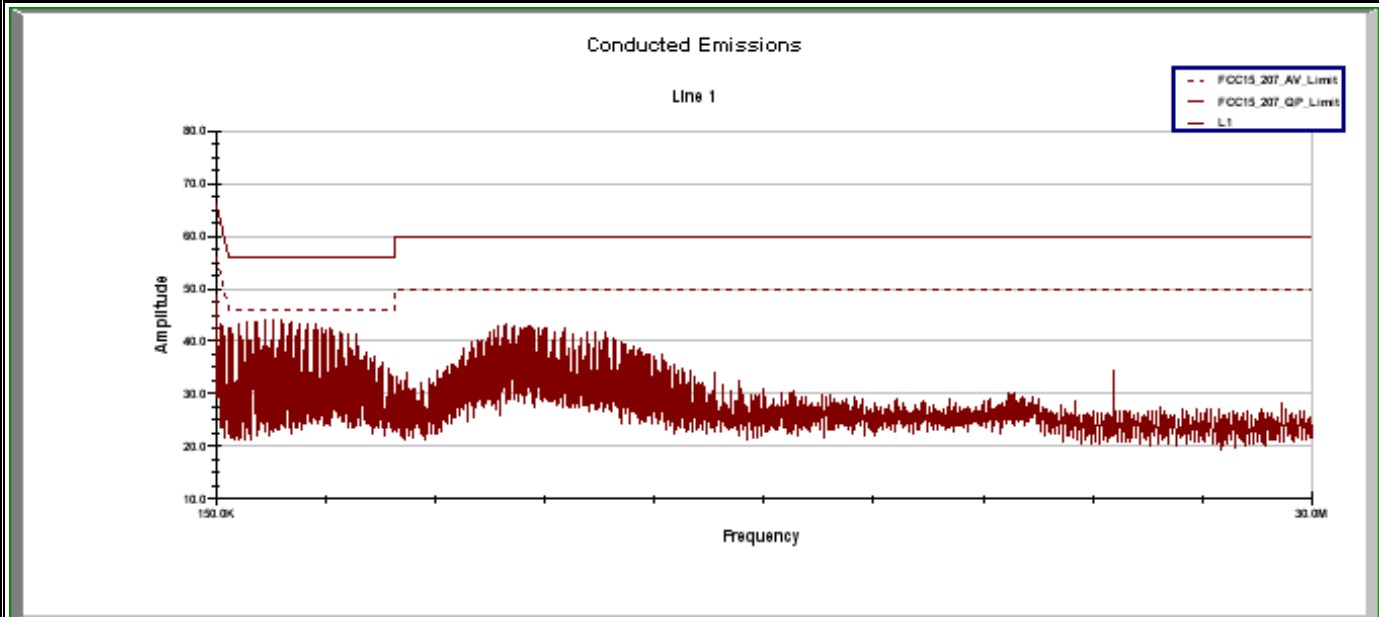
Following are peak emission plots and tabular data describing the peak, quasi-peak and average measurements made of the DUT.



	<b>Project Number:</b>	072804KBC-T543-E15B	<b>Standard:</b>	FCC 15.207
	<b>Company:</b>	Itronix	<b>Test Start Date:</b>	14-Oct-04
	<b>Product:</b>	IX260+ with Cirronet BT2022 Bluetooth	<b>Test End Date:</b>	14-Oct-04

Line 1 Conducted Emissions												
Frequency MHz	Uncorrected Reading			Correction Factor dB	Corrected Emission Level			Quasi-Peak Limit dBuV	Quasi-Peak Margin dB	Average Limit dBuV	Average Margin dB	Pass/Fail
	Peak dBuV	Quasi-Peak dBuV	Average dBuV		Peak dBuV	Quasi-Peak dBuV	Average dBuV					
0.159	50.40	47.24	45.54	1.98	52.38	49.22	47.52	65.53	16.31	55.53	8.01	Pass
1.251	43.60	43.04	43.15	0.31	43.91	43.35	43.46	56.00	12.66	46.00	2.55	Pass
1.252	43.80	43.14	43.29	0.30	44.10	43.44	43.59	56.00	12.56	46.00	2.41	Pass
1.486	44.00	43.19	43.32	0.29	44.29	43.48	43.61	56.00	12.52	46.00	2.39	Pass
1.718	43.80	43.15	43.18	0.29	44.09	43.44	43.47	56.00	12.57	46.00	2.54	Pass
1.722	44.00	43.34	43.50	0.28	44.29	43.63	43.78	56.00	12.38	46.00	2.22	Pass
1.957	44.10	43.25	43.34	0.28	44.38	43.53	43.62	56.00	12.47	46.00	2.38	Pass
8.055	43.40	41.99	39.94	0.32	43.72	42.31	40.26	60.00	17.69	50.00	9.74	Pass

Corrected Emission Level (dBuV) = Uncorrected Reading (dBuV) + Correction Factor (dB)  
Margin (dB) = Limit (dBuV) - Corrected Emission Level (dBuV)

<b>Test Report S/N:</b>	050405KBC-T635-E15B	Issue 1
<b>Test Date(s):</b>	21Sept04 - 14Oct04, 22Oct04	
<b>Test Type(s):</b>	FCC §15.247	IC RSS-210 Issue 5
<b>Lab Registration(s):</b>	FCC #714830	IC Lab File #3874

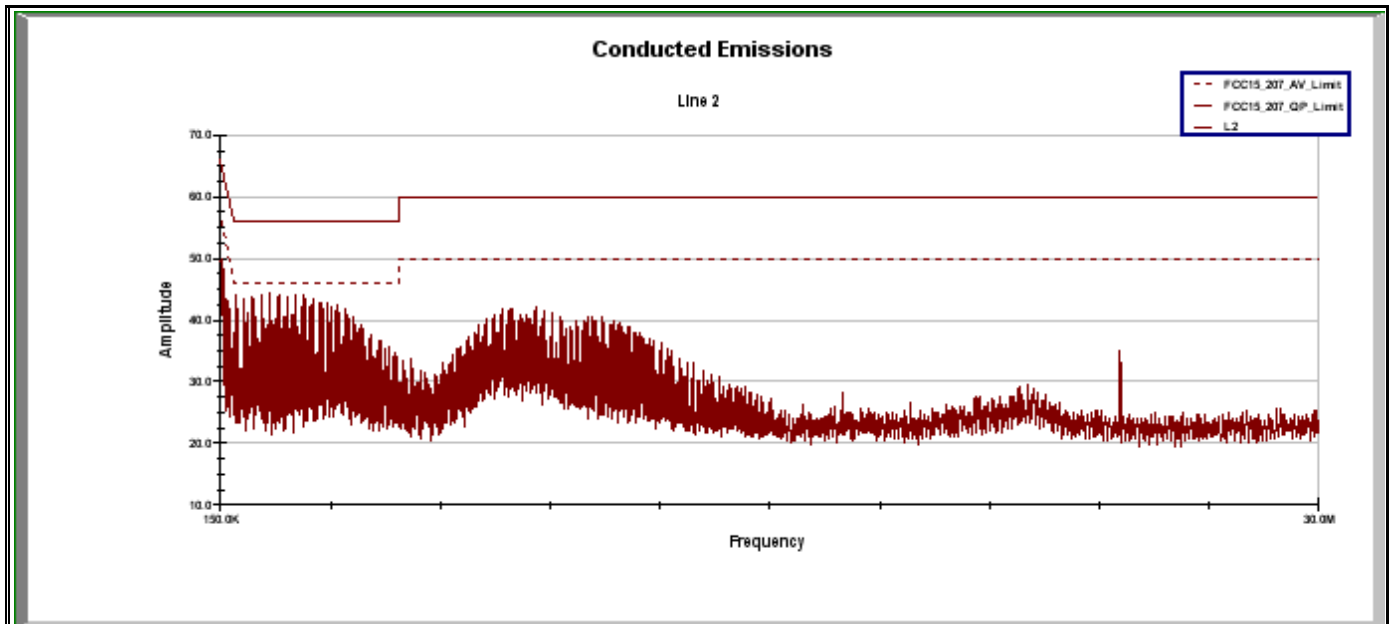

	<b>Project Number:</b>	072804KBC-T543-E15B	<b>Standard:</b>	FCC 15.207								
	<b>Company:</b>	Itronix	<b>Test Start Date:</b>	14-Oct-04								
	<b>Product:</b>	IX260+ with Cirronet BT2022 Bluetooth	<b>Test End Date:</b>	14-Oct-04								
<b>Line 2 Conducted Emissions</b>												
Frequency MHz	Uncorrected Reading			Correction Factor dB	Corrected Emission Level			Quasi-Peak Limit dBuV	Quasi-Peak Margin dB	Average Limit dBuV	Average Margin dB	Pass/Fail
	Peak dBuV	Quasi-Peak dBuV	Average dBuV		Peak dBuV	Quasi-Peak dBuV	Average dBuV					
0.158	51.50	48.10	47.43	1.98	53.48	50.08	49.41	65.55	15.47	55.55	6.14	Pass
0.215	47.50	45.05	36.85	1.28	48.78	46.33	38.13	63.00	16.67	53.00	14.87	Pass
0.500	47.09	45.17	39.25	0.47	47.56	45.64	39.72	56.00	10.36	46.00	6.28	Pass
1.253	44.00	43.50	43.59	0.30	44.30	43.80	43.89	56.00	12.20	46.00	2.11	Pass
1.483	44.10	43.48	43.48	0.29	44.39	43.77	43.77	56.00	12.23	46.00	2.23	Pass
1.485	44.30	43.51	43.59	0.29	44.59	43.80	43.89	56.00	12.20	46.00	2.11	Pass
5.000	43.18	42.37	41.73	0.30	43.48	42.67	42.03	56.00	13.33	46.00	3.97	Pass
8.683	41.99	41.15	39.76	0.33	42.32	41.48	40.09	60.00	18.52	50.00	9.91	Pass
Corrected Emission Level (dBuV) = Uncorrected Reading (dBuV) + Correction Factor (dB) Margin (dB) = Limit (dBuV) - Corrected Emission Level (dBuV)												

<b>Applicant:</b>	Itronix Corporation	<b>Model:</b>	IX260P-AC580BT	<b>FCC ID:</b>	KBCIX260P-AC580BT	<b>IC ID:</b>	1943A-IX260Pf
<b>Rugged Laptop PC with Cirronet BT2022 Bluetooth and co-located Sierra Wireless Dual-Band CDMA</b>							
2005 Celltech Labs Inc This document is not to be reproduced in whole or in part without the written permission of Celltech Labs Inc.							19 of 45

<b>Test Report S/N:</b>	050405KBC-T635-E15B	Issue 1
<b>Test Date(s):</b>	21Sept04 - 14Oct04, 22Oct04	
<b>Test Type(s):</b>	FCC §15.247	IC RSS-210 Issue 5
<b>Lab Registration(s):</b>	FCC #714830	IC Lab File #3874

### B.10. PASS/FAIL

In reference to the results outlined in B.9 the DUT passes the requirements as stated in the reference standards as follows:  
The RF voltage measured in reference to ground on each of the power line conductors does not exceed the limits as outline in FCC 15.207.

### B.11. SIGN-OFF

I attest to the accuracy of the data. All measurements reported herein were performed by me and are correct to the best of my knowledge and belief. I assume full responsibility for the completeness of these measurements.



\_\_\_\_\_  
Duane M. Friesen, C.E.T.  
EMC Manager  
Celltech Labs Inc.

\_\_\_\_\_  
12Oct04  
Date

<b>Applicant:</b>	Itronix Corporation	<b>Model:</b>	IX260P-AC580BT	<b>FCC ID:</b>	KBCIX260P-AC580BT	<b>IC ID:</b>	1943A-IX260Pf	
<b>Rugged Laptop PC with Cirronet BT2022 Bluetooth and co-located Sierra Wireless Dual-Band CDMA</b>								
2005 Celltech Labs Inc This document is not to be reproduced in whole or in part without the written permission of Celltech Labs Inc.							20 of 45	

<b>Test Report S/N:</b>	050405KBC-T635-E15B	Issue 1
<b>Test Date(s):</b>	21Sept04 - 14Oct04, 22Oct04	
<b>Test Type(s):</b>	FCC §15.247	IC RSS-210 Issue 5
<b>Lab Registration(s):</b>	FCC #714830	IC Lab File #3874

### Appendix C - Peak Conducted RF Output Power Measurement

C.1. REFERENCES	
<b>Normative Reference Standard</b>	FCC CFR 47 §15.247(b) (1)
<b>Procedure Reference</b>	FCC 97-114

C.2. LIMITS	
C.2.1. FCC CFR 47	
<p>§15.247(b): The maximum peak output power of the intentional radiator shall not exceed the following:            §15.247(b) (1) For frequency hopping systems operating in the 2400 – 2483.5 MHz band employing at least 75 hopping channels, and all frequency hopping systems in the 5725 – 5850 MHz bands: 1 Watt.*</p>	

\*Appendix E results confirm the number of hopping channels is at least 75.

**Note:** When a reference is made to conducted results outlined in the ACS test report they will be referenced to the conducted power measurements outlined in section 6.4 of that report. The conducted power measurements reported herein were made for correlation purposes and are applicable as references for the measurements described in this report.

C.3. ENVIRONMENTAL CONDITIONS	
<b>Temperature</b>	25.2 +/- 2 °C
<b>Humidity</b>	35 +/- 2 %
<b>Barometric Pressure</b>	96.34 kPa

C.4. EQUIPMENT LIST					
ASSET NUMBER	MANUFACTURER	MODEL	DESCRIPTION	LAST CAL	CAL DUE
00015	Agilent	E4408B	Spectrum Analyzer	29Dec03	29Dec04
00076	Pasternack	PE7014-30	30dB 2 Watt Attenuator	08Jul04*	08Jul05

\*Attenuator verified with power meter prior to use

<b>Test Report S/N:</b>	050405KBC-T635-E15B	Issue 1
<b>Test Date(s):</b>	21Sept04 - 14Oct04, 22Oct04	
<b>Test Type(s):</b>	FCC §15.247	IC RSS-210 Issue 5
<b>Lab Registration(s):</b>	FCC #714830	IC Lab File #3874

<b>C.5. MEASUREMENT EQUIPMENT SETUP</b>	
<b>Measurement Equipment Connections</b>	The equipment was connected as shown in the setup drawing in C.6.
<b>Measurement Equipment Settings</b>	The power is measured within the band with the following spectrum analyzer settings: RBW – 100 kHz VBW – 1 MHz Detector – Peak Average – Power

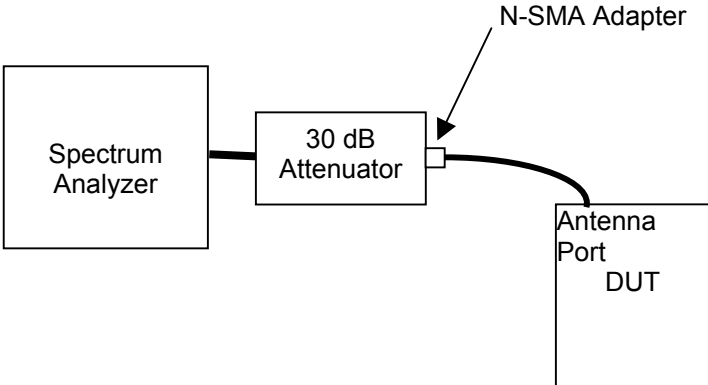
<b>C.6. SETUP DRAWING</b>	
Figure C-1 - Setup Drawing	
	

<b>C.7. DUT OPERATING DESCRIPTION</b>
The unmodulated carrier was set to each of the three frequencies representing the frequency band of operation.

<b>Test Report S/N:</b>	050405KBC-T635-E15B	Issue 1
<b>Test Date(s):</b>	21Sept04 - 14Oct04, 22Oct04	
<b>Test Type(s):</b>	FCC §15.247	IC RSS-210 Issue 5
<b>Lab Registration(s):</b>	FCC #714830	IC Lab File #3874

C.8. TEST RESULTS				
Channel	Frequency	Peak Conducted Power		Limit
		dBm	Watts	Watts
Low	2402	15.40	.0347	1
Mid	2441	15.61	.0364	1
High	2480	15.34	.0342	1

**C.9. PASS/FAIL**

In reference to the results outlined in C.8 the DUT passes the requirements as stated in the reference standards as follows:  
 FCC 15.247 (b) (1): The peak power did not exceed 1 Watt.

**C.10. SIGN-OFF**

I attest to the accuracy of the data. All measurements reported herein were performed by me and are correct to the best of my knowledge and belief. I assume full responsibility for the completeness of these measurements.



\_\_\_\_\_  
 Duane M. Friesen, C.E.T.  
 EMC Manager  
 Celltech Labs Inc.

\_\_\_\_\_  
 14Oct04  
 Date

<b>Test Report S/N:</b>	050405KBC-T635-E15B	Issue 1
<b>Test Date(s):</b>	21Sept04 - 14Oct04, 22Oct04	
<b>Test Type(s):</b>	FCC §15.247	IC RSS-210 Issue 5
<b>Lab Registration(s):</b>	FCC #714830	IC Lab File #3874

### Appendix D - Adjacent Channel Separation

D.1. REFERENCES	
<b>Normative Reference Standard</b>	FCC CFR 47 §15.247 (a) (1)
<b>Test Reference</b>	ACS Test Report: FCC Part 15 Certification Test Report - FCC ID: HSW-BT2022M 2.4 GHz Frequency Hopping Spread Spectrum (Modular Approval) ACS Report Number 03-0193-15BC Issue Date: January 5, 2004

D.2. LIMITS
<i>§15.247(a) (1): Frequency hopping systems shall have hopping channel carrier frequencies separated by a minimum of 25 kHz or 20 dB bandwidth of the hopping channel, whichever is greater.</i>

Note: The 20 dB bandwidth of the hopping channel is described to be 1 MHz as outlined in section 6.5.4 of the ACS report. Therefore the channel separation must be 1 MHz.

D.3. TEST PROCEDURE & RESULTS
The test method used to show compliance to the applicable parts and the results obtained are outlined in the ACS reference test report number 03-0193-15BC section 6.5.1. A channel separation of 1.0 MHz was reported for all channels.

D.4. PASS/FAIL
As stated in the ACS reference test report number 03-0193-15BC, the DUT complies with the applicable requirements of the referenced part.



<b>Test Report S/N:</b>	050405KBC-T635-E15B	Issue 1
<b>Test Date(s):</b>	21Sept04 - 14Oct04, 22Oct04	
<b>Test Type(s):</b>	FCC §15.247	IC RSS-210 Issue 5
<b>Lab Registration(s):</b>	FCC #714830	IC Lab File #3874

### Appendix E - Number of Hopping Channels

<b>E.1. REFERENCES</b>	
<b>Normative Reference Standard</b>	FCC CFR 47 §15.247 (a) (1) (iii)
<b>Test Reference</b>	ACS Test Report: FCC Part 15 Certification Test Report - FCC ID: HSW-BT2022M 2.4 GHz Frequency Hopping Spread Spectrum (Modular Approval) ACS Report Number 03-0193-15BC Issue Date: January 5, 2004

<b>E.2. LIMITS</b>
<i>§15.247 (a) (1) (iii): Frequency hopping systems in the 2400 – 2483.5 MHz band shall use at least 15 non-overlapping channels.</i>

<b>E.3. TEST PROCEDURE &amp; RESULTS</b>
The test method used to show compliance to the applicable parts and the results obtained are outlined in the ACS reference test report number 03-0193-15BC section 6.5.2 The results outlined in the reference test report show that the number of hopping channels is at least 75; which implies an applicable power limit of 1 watt be applied to the results outlined in Appendix C.

<b>E.4. PASS/FAIL</b>
As stated in the ACS reference test report number 03-0193-15BC, the DUT complies with the applicable requirements of the referenced part.

<b>Test Report S/N:</b>	050405KBC-T635-E15B	Issue 1
<b>Test Date(s):</b>	21Sept04 - 14Oct04, 22Oct04	
<b>Test Type(s):</b>	FCC §15.247	IC RSS-210 Issue 5
<b>Lab Registration(s):</b>	FCC #714830	IC Lab File #3874

### Appendix F - Channel Dwell Time

F.1. REFERENCES	
<b>Normative Reference Standard</b>	FCC CFR 47 §15.247 (a) (1), FCC CFR 47 §15.247 (a) (1) (iii)
<b>Test Reference</b>	ACS Test Report: FCC Part 15 Certification Test Report - FCC ID: HSW-BT2022M 2.4 GHz Frequency Hopping Spread Spectrum (Modular Approval) ACS Report Number 03-0193-15BC Issue Date: January 5, 2004

F.2. LIMITS
<p>§15.247 (a) (1): ....The system shall hop to channel frequencies that are selected at the hopping rate from a pseudorandomly ordered list of hopping frequencies. Each frequency must be used equally on the average by each transmitter.</p> <p>§15.247 (a) (1) (iii): .....The average time of occupancy on any channel shall be greater than 0.4 seconds within a period of 0.4 seconds multiplied by the number of hopping channels employed.</p>

F.3. TEST PROCEDURE & RESULTS
The test method used to show compliance to the applicable parts and the results obtained are outlined in the ACS reference test report number 03-0193-15BC section 6.5.3. A channel dwell of 10 mS each 20 seconds was reported.

F.4. PASS/FAIL
As stated in the ACS reference test report number 03-0193-15BC, the DUT complies with the applicable requirements of the referenced part.

<b>Test Report S/N:</b>	050405KBC-T635-E15B	Issue 1
<b>Test Date(s):</b>	21Sept04 - 14Oct04, 22Oct04	
<b>Test Type(s):</b>	FCC §15.247	IC RSS-210 Issue 5
<b>Lab Registration(s):</b>	FCC #714830	IC Lab File #3874

### Appendix G - 20 dB Bandwidth Measurement

G.1. REFERENCES	
<b>Normative Reference Standard</b>	FCC CFR 47 §15.247 (a) (1) (iii)
<b>Test Reference</b>	ACS Test Report: FCC Part 15 Certification Test Report - FCC ID: HSW-BT2022M 2.4 GHz Frequency Hopping Spread Spectrum (Modular Approval) ACS Report Number 03-0193-15BC Issue Date: January 5, 2004

G.2. LIMITS
<p>§15.247 (a) (1) (iii): <i>Frequency hopping systems in the 2400 – 2483.5 MHz band shall use at least 15 non-overlapping channels.</i></p> <p>Note: The channel width as referenced in the results outlined in Appendix C and D is 1 MHz, therefore to be non-overlapping, the 20 dB bandwidth must be no greater than 1 MHz for the system to comply.</p>

G.3. TEST PROCEDURE & RESULTS
The test method used to show compliance to the applicable parts and the results obtained are outlined in the ACS reference test report number 03-0193-15BC section 6.5.4. A 20 dB bandwidth measurement of 1 MHz was reported.

G.4. PASS/FAIL
As stated in the ACS reference test report number 03-0193-15BC, the DUT complies with the applicable requirements of the referenced part.

<b>Test Report S/N:</b>	050405KBC-T635-E15B	Issue 1
<b>Test Date(s):</b>	21Sept04 - 14Oct04, 22Oct04	
<b>Test Type(s):</b>	FCC §15.247	IC RSS-210 Issue 5
<b>Lab Registration(s):</b>	FCC #714830	IC Lab File #3874

## Appendix H - Radiated Spurious Emissions Measurement

H.1. REFERENCES	
<b>Normative Reference Standard</b>	FCC CFR 47 §15.247(c)
<b>Procedure Reference</b>	ANSI C63.4; FCC 97-114

H.2. LIMITS	
H.2.1. FCC CFR 47	
<p>§15.247 (c): In any 100 kHz bandwidth outside the frequency band in which the spread spectrum or digitally modulated intentional radiator is operating, the radio frequency power that is produced by the intentional radiator shall be at least 20 dB below that in the 100 kHz bandwidth within the band that contains the highest level of desired power, based on either an RF conducted or a radiated measurement. Attenuation below the general limits specified in 15.209 (a) is not required.</p>	
<p>Note: Spurious emissions within the restricted bands are reported in Appendix I.</p>	
<p>The maximum carrier field strength @ 3m was determined to be in the horizontal orientation with transmitter set for the mid channel (2441 MHz). The field strength in this configuration was 108.31 dBuV/m and was used as the limit reference. Therefore the calculated limit used was 88.31 dBuV/m (Limit (dBuV/m) = 108.31 (dBuV/m) – 20 dB) for the horizontal polarization and 83.21 dBuV/m (Limit (dBuV/m) = 103.21 (dBuV/m) – 20 dB) for vertical.</p>	

H.3. ENVIRONMENTAL CONDITIONS	
<b>Temperature</b>	27.4 +/- 2 °C
<b>Humidity</b>	33 +/- 2 %
<b>Barometric Pressure</b>	96.24 +/- 0.2 kPa

H.4. EQUIPMENT LIST					
ASSET NUMBER	MANUFACTURER	MODEL	DESCRIPTION	LAST CAL	CAL DUE
00072	EMCO	2075	Mini-mast	n/a	n/a
00073	EMCO	2080	Turn Table	n/a	n/a
00071	EMCO	2090	Multi-Device Controller	n/a	n/a
00035	ETS	3115	Double Ridged Guide Horn	24Mar04	24Mar05
00202	ETS	3160-09	Small Horn Antenna	27May04	27May05
00015	Agilent	E4408B	Spectrum Analyzer	29Dec03	29Dec04
00049	HP	8566B	Spectrum Analyzer RF Section	18May04	18May05
00048	Gore	65474	Microwave Cable	20May04	20May05
00030	HP	83017A	LNA	20May04	20May05

<b>Applicant:</b>	Itronix Corporation	<b>Model:</b>	IX260P-AC580BT	<b>FCC ID:</b>	KBCIX260P-AC580BT	<b>IC ID:</b>	1943A-IX260Pf
<b>Rugged Laptop PC with Cirronet BT2022 Bluetooth and co-located Sierra Wireless Dual-Band CDMA</b>							
2005 Celltech Labs Inc This document is not to be reproduced in whole or in part without the written permission of Celltech Labs Inc.							28 of 45

H.5. MEASUREMENT EQUIPMENT SETUP				
<b>MEASUREMENT EQUIPMENT CONNECTIONS</b>	The measurement equipment was connected as shown in H.6. A number of antennas were used to cover the applicable frequency range test. The ranges in which each antenna was used are as follows:			
	Frequency Range	Antenna		
	1 GHz – 18 GHz	ETS 3115 Horn		
	18 GHz– 26GHz	ETS 3160-09 Horn		
<b>MEASUREMENT EQUIPMENT SETTINGS</b>	The spectrum analyzer was set to the following settings:			
	Frequency Range	RBW	VBW	Detector
	MHz	kHz	kHz	
	> 1000	1000 <sup>1</sup>	1000	Peak <sup>2</sup>
Note 1: As a worse case measurement, when suitable margin could be realized, the applicable limit was applied to measurements made with a peak detector using a 1 MHz RBW. When an average measurement was reported, it was made with 100 kHz RBW using video average with a VBW of 1 Hz.				

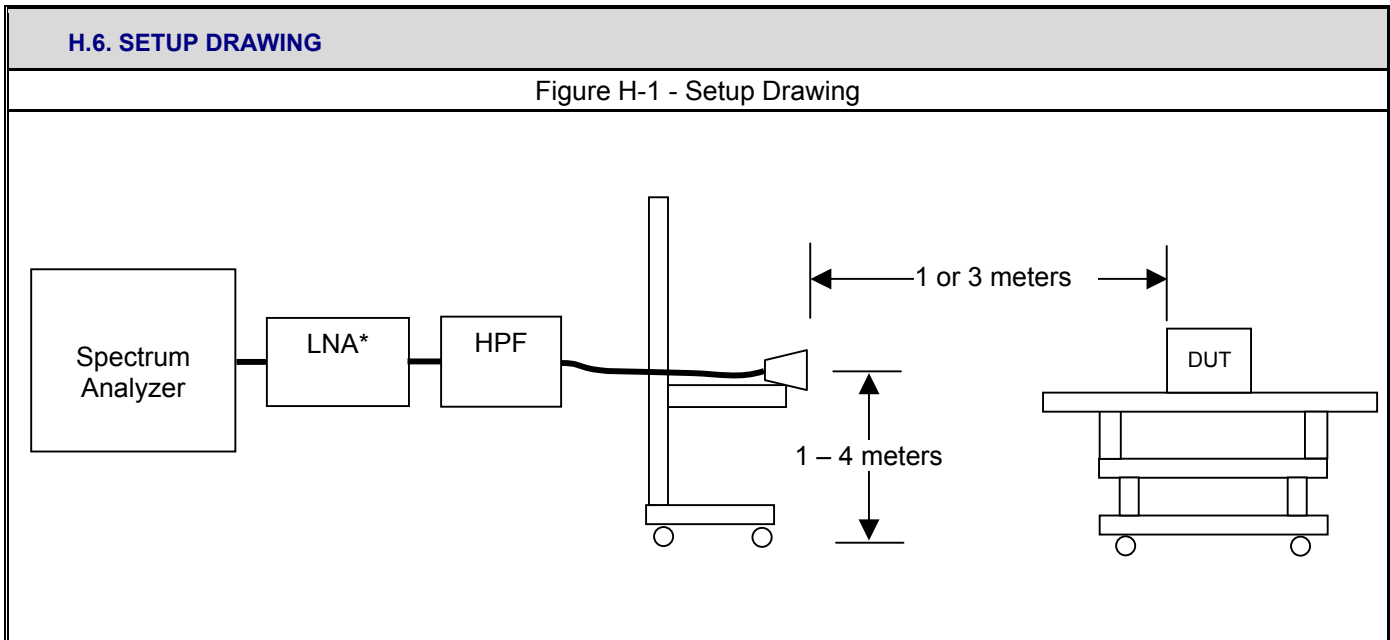

<b>Test Report S/N:</b>	050405KBC-T635-E15B	Issue 1
<b>Test Date(s):</b>	21Sept04 - 14Oct04, 22Oct04	
<b>Test Type(s):</b>	FCC §15.247	IC RSS-210 Issue 5
<b>Lab Registration(s):</b>	FCC #714830	IC Lab File #3874

### H.7. SETUP PHOTOGRAPHS

Photograph H-1 - 3115 Horn Antenna (1-18GHz)



Photograph H-2 - 3160-09 Horn Antenna (18-26GHz)



### H.8. DUT OPERATING DESCRIPTION

Measurements were made at three channels throughout the band, Low Channel (2402 MHz), Mid Channel (2441 MHz), High Channel (2480 MHz). The configuration used was with a gain setting of 250/40 for the low channel, 250/44 for mid channel and 220/45 for the high channel. The modulation was set to 1000. As a worst case, the band-edge measurements were made of the low and high channels with data stream modulation.

<b>Applicant:</b>	Itronix Corporation	<b>Model:</b>	IX260P-AC580BT	<b>FCC ID:</b>	KBCIX260P-AC580BT	<b>IC ID:</b>	1943A-IX260Pf
<b>Rugged Laptop PC with Cirronet BT2022 Bluetooth and co-located Sierra Wireless Dual-Band CDMA</b>							
2005 Celltech Labs Inc This document is not to be reproduced in whole or in part without the written permission of Celltech Labs Inc.							30 of 45

## H.9. TEST RESULTS

### H.9.1. Lower Band-edge Emission Field Strengths @ Specified Distance

Note: (Upper Band-edge (Restricted) is in Appendix I)

#### Channel 0 - Conducted Band-edge Plots

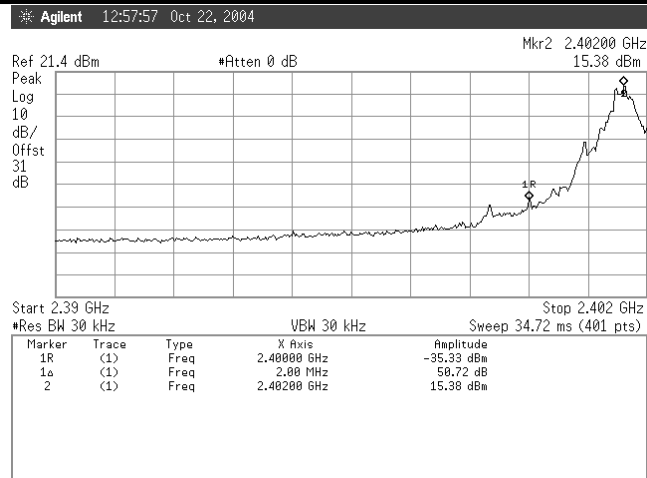

#### Channel 0 - Radiated Carrier Field Strengths

Polarity	Distance m	Rx Antenna	Channel	Frequency	SA Level	Rx AF	Rx CL	Other Rx	Total Rx CF	Field Strength	Detector
				MHz	dBuV	dB/m	dB	dB	dB/m	dBuV/m (PK/QP/AVG)	
H	3	Horn SN6276	0	2402.00	83.90	30.24	3.48	0.00	33.72	117.62	PK
H	3	Horn SN6276	0	2402.00	42.30	30.24	3.48	0.00	33.72	76.02	AV
V	3	Horn SN6276	0	2402.00	75.50	30.24	3.48	0.00	33.72	109.22	PK
V	3	Horn SN6276	0	2402.00	38.70	30.24	3.48	0.00	33.72	72.42	AV

#### Channel 0 - Calculated Band-edge (Out-of-Band) Field Strengths

Polarity	Distance m	Rx Antenna	Channel	Frequency	Carrier Radiated Field Strength	Detector	Marker-Delta	Calculated Bandedge Field Strength	Limit Distance	Limit Distance Correction	Calculated Limit	Margin	Pass/Fail
				MHz	dBuV/m		dB	dBuV/m	m	dB	dBuV/m	dB	
H	3	Horn SN6276	0	2400.0	117.62	PK	50.72	66.9	3	0	97.62	30.72	Pass
H	3	Horn SN6276	0	2400.0	76.02	AV	50.72	25.3	3	0	56.02	30.72	Pass
V	3	Horn SN6276	0	2400.0	109.22	PK	50.72	58.5	3	0	97.62	39.12	Pass
V	3	Horn SN6276	0	2400.0	72.42	AV	50.72	21.7	3	0	56.02	34.32	Pass

Formulae:

Total CF (dB) = Antenna Factor (dB) + Cable Factor (dB) + Other Factor (Amplifier Gain, Filter Loss, etc) (dB)

Field Strength (dBuV/m) = SA Reading (dBuV) + Total CF (dB/m)

Limit Distance Correction (dB) = 40 \* log(d1/d2) for f < 30 MHz, 20\*log(d1/d2) for f > 30 MHz; where d1 is the measurement distance and d2 is the published limit

Limit (dBuV/m) = Published Limit (dBuV/m) + Limit Distance Correction (dB)

Margin (dB) = Limit (dBuV/m) - Field Strength (dBuV/m)

Note: Measurements and calculation reference the Marker-Delta Method Described in FCC Public Notice DA 00-705



Test Report S/N:	050405KBC-T635-E15B	Issue 1
Test Date(s):	21Sept04 - 14Oct04, 22Oct04	
Test Type(s):	FCC §15.247	IC RSS-210 Issue 5
Lab Registration(s):	FCC #714830	IC Lab File #3874

### H.9.2. Spurious Emission Field Strengths @ Specified Distance

Company: 072804KBC-T543-E15B  
 Product: Itronix  
 IX260+ with Bluetooth

Standard: FCC15.247c  
 Test Start Date: 21Sep04  
 Test End Date: 12Oct04

IX260+ with Bluetooth																		
Channel	Polarity	Distance	Rx Antenna	Frequency	SA Level	Noise Floor	Rx AF	Rx CL	Other Rx	*Duty Cycle Correction	Total Rx CF	Field Strength	Detector	Limit Distance	Limit Distance Correction	Calculated Limit	Margin	Pass/Fail
							dB/m	dB	dB	dB	dB/m	dBuV/m	(PK/QP/AV)	m	dB	dBuV/m	dB	
BT-Low	H	3	Horn SN6276	2000.00	14.40	x	29.60	3.18	0.00	-20.00	12.78	27.18	PK	3.00	0.00	88.31	61.13	PASS
BT-Low	H	3	Horn SN6276	7206.72	52.40		38.17	6.21	-34.32	-20.00	-9.94	42.46	PK	3.00	0.00	88.31	45.85	PASS
BT-Low	H	1	Horn SN6276	17986.00	44.90		45.86	10.43	-32.01	-20.00	4.28	49.18	PK	3.00	9.54	97.85	48.68	PASS
BT-Low	V	3	Horn SN6276	2000.00	17.00	x	29.60	3.18	0.00	-20.00	12.78	29.78	PK	3.00	0.00	83.21	53.43	PASS
BT-Low	V	3	Horn SN6276	4804.58	52.70		35.31	4.96	-34.08	-20.00	-13.81	38.89	PK	3.00	0.00	83.21	44.32	PASS
BT-Low	V	3	Horn SN6276	4804.46	50.80		35.31	4.96	-34.08	-20.00	-13.81	36.99	PK	3.00	0.00	83.21	46.22	PASS
BT-Low	V	3	Horn SN6276	7207.22	57.30		38.17	6.21	-34.32	-20.00	-9.93	47.37	PK	3.00	0.00	83.21	35.85	PASS
BT-Low	V	1	Horn SN6276	17874.00	44.50		45.52	10.28	-32.09	-20.00	3.71	48.21	PK	3.00	9.54	92.75	44.54	PASS
BT-Mid	H	3	Horn SN6276	2000.00	14.40	x	29.60	3.18	0.00	-20.00	12.78	27.18	PK	3.00	0.00	88.31	61.13	PASS
BT-Mid	H	3	Horn SN6276	4882.41	55.90		35.46	5.04	-34.09	-20.00	-13.59	42.31	PK	3.00	0.00	88.31	46.00	PASS
BT-Mid	H	3	Horn SN6276	7323.65	50.00		38.38	6.32	-34.32	-20.00	-9.62	40.38	PK	3.00	0.00	88.31	47.93	PASS
BT-Mid	H	1	Horn SN6276	17982.00	44.50		45.88	10.45	-32.01	-20.00	4.32	48.82	PK	3.00	9.54	97.85	49.03	PASS
BT-Mid	V	3	Horn SN6276	2000.00	17.00	x	29.60	3.18	0.00	-20.00	12.78	29.78	PK	3.00	0.00	83.21	53.43	PASS
BT-Mid	V	3	Horn SN6276	4882.23	49.80		35.46	5.04	-34.09	-20.00	-13.59	36.21	PK	3.00	0.00	83.21	47.00	PASS
BT-Mid	V	3	Horn SN6276	7323.74	55.80		38.38	6.32	-34.32	-20.00	-9.62	46.18	PK	3.00	0.00	83.21	37.03	PASS
BT-Mid	V	3	Horn SN6276	9764.87	49.40		40.30	7.41	-34.25	-20.00	-6.54	42.86	PK	3.00	0.00	83.21	40.35	PASS
BT-Mid	V	1	Horn SN6276	18000.00	43.90		45.90	10.48	-32.00	-20.00	4.38	48.28	PK	3.00	9.54	92.75	44.47	PASS
BT-High	H	3	Horn SN6276	2000.00	14.40	x	29.60	3.18	0.00	-20.00	12.78	27.18	PK	3.00	0.00	88.31	61.13	PASS
BT-High	H	3	Horn SN6276	4960.48	52.20		35.62	5.06	-34.10	-20.00	-13.42	38.78	PK	3.00	0.00	88.31	49.53	PASS
BT-High	H	1	Horn SN6276	17862.00	44.70		45.49	10.28	-32.10	-20.00	3.67	48.37	PK	3.00	9.54	97.85	49.49	PASS
BT-High	V	3	Horn SN6276	2000.00	17.00	x	29.60	3.18	0.00	-20.00	12.78	29.78	PK	3.00	0.00	83.21	53.43	PASS
BT-High	V	3	Horn SN6276	4960.39	50.80		35.62	5.06	-34.10	-20.00	-13.42	37.38	PK	3.00	0.00	83.21	45.83	PASS
BT-High	V	3	Horn SN6276	7440.88	49.80		38.59	6.43	-34.32	-20.00	-9.29	40.51	PK	3.00	0.00	83.21	42.70	PASS
BT-High	V	1	Horn SN6276	17936.00	44.70		45.71	10.28	-32.04	-20.00	3.94	48.64	PK	3.00	9.54	92.75	44.11	PASS

**Formulae:**

Total CF (dB) = Antenna Factor (dB) + Cable Factor (dB) + Other Factor (Amplifier Gain, Filter Loss, etc) (dB)  
 Field Strength (dBuV/m) = SA Reading (dBuV) + Total CF (dB/m)  
 Limit Distance Correction (dB) = 40 \* log(d1/d2) for f < 30 MHz, 20\*log(d1/d2) for f > 30 MHz; where d1 is the measurement distance and d2 is the published limit distance  
 Limit (dBuV/m) = Published Limit (dBuV/m) + Limit Distance Correction (dB)  
 Margin (dB) = Limit (dBuV/m) - Field Strength (dBuV/m)  
 Duty Cycle Correction (dB) = 20 \* log (duty cycle ratio\*)  
 Duty Cycle ratio = maximum time on in any 100 mS period (in mS) / 100 mS

\*DUT duty cycle = 10 mS in each 10 seconds

**\*The frequency points reported, describe the highest emission measured in each of the ranges tested and are used to describe the measured spectrum as a whole. Emissions that may be present in the restricted bands are evaluated against the appropriate limits in Appendix I. No out-of-band emissions were measured above the levels noted.**

Applicant:	Itronix Corporation	Model:	IX260P-AC580BT	FCC ID:	KBCIX260P-AC580BT	IC ID:	1943A-IX260Pf	
Rugged Laptop PC with Cirronet BT2022 Bluetooth and co-located Sierra Wireless Dual-Band CDMA								
2005 Celltech Labs Inc This document is not to be reproduced in whole or in part without the written permission of Celltech Labs Inc.							32 of 45	



<b>Test Report S/N:</b>	050405KBC-T635-E15B	Issue 1
<b>Test Date(s):</b>	21Sept04 - 14Oct04, 22Oct04	
<b>Test Type(s):</b>	FCC §15.247	IC RSS-210 Issue 5
<b>Lab Registration(s):</b>	FCC #714830	IC Lab File #3874

**H.10. PASS/FAIL**

In reference to the results outlined in H.9, the DUT passes the requirements as stated in the reference standards as follows:  
FCC 15.247 (c): All emissions within any 100 kHz bandwidth outside the operating frequency band are greater than 20 dB below the maximum 100 kHz bandwidth signal within the operating band.

**H.11. SIGN-OFF**

I attest to the accuracy of the data. All measurements reported herein were performed by me and are correct to the best of my knowledge and belief. I assume full responsibility for the completeness of these measurements.



\_\_\_\_\_  
Russell Pipe  
Senior Compliance Technologist  
Celltech Labs Inc.

\_\_\_\_\_  
22Oct04  
Date

<b>Applicant:</b>	Itronix Corporation	<b>Model:</b>	IX260P-AC580BT	<b>FCC ID:</b>	KBCIX260P-AC580BT	<b>IC ID:</b>	1943A-IX260Pf
<b>Rugged Laptop PC with Cirronet BT2022 Bluetooth and co-located Sierra Wireless Dual-Band CDMA</b>							
2005 Celltech Labs Inc This document is not to be reproduced in whole or in part without the written permission of Celltech Labs Inc.							33 of 45

### Appendix I - Restricted Band Emissions Measurement

I.1. REFERENCES	
Normative Reference Standard	FCC CFR 47 §15.205 (a) (b), FCC CFR 47 §15.209 (a)
Procedure Reference	FCC 97-114

I.2. LIMITS																																																																									
FCC CFR 47 §15.205	(a) Except as shown in paragraph (d) of this section, only spurious emissions are permitted in any of the frequency bands listed below:																																																																								
	<table border="1"> <thead> <tr> <th>MHz</th> <th>MHz</th> <th>MHz</th> <th>GHz</th> </tr> </thead> <tbody> <tr><td>0.090-0.110</td><td>16.42-16.423</td><td>399.9-410</td><td>4.5-5.15</td></tr> <tr><td><sup>1</sup>0.495-0.505</td><td>16.69475-16.69525</td><td>608-614</td><td>5.35-5.46</td></tr> <tr><td>2.1735-2.1905</td><td>16.80425-16.80475</td><td>960-1240</td><td>7.25-7.75</td></tr> <tr><td>4.125-4.128</td><td>25.5-25.67</td><td>1300-1427</td><td>8.025-8.5</td></tr> <tr><td>4.17725-4.17775</td><td>37.5-38.25</td><td>1435-1626.5</td><td>9.0-9.2</td></tr> <tr><td>4.20725-4.20775</td><td>73-74.6</td><td>1645.5-1646.5</td><td>9.3-9.5</td></tr> <tr><td>6.215-6.218</td><td>74.8-75.2</td><td>1660-1710</td><td>10.6-12.7</td></tr> <tr><td>6.26775-6.26825</td><td>108-121.94</td><td>1718.8-1722.2</td><td>13.25-13.4</td></tr> <tr><td>6.31175-6.31225</td><td>123-138</td><td>2200-2300</td><td>14.47-14.5</td></tr> <tr><td>8.291-8.294</td><td>149.9-150.05</td><td>2310-2390</td><td>15.35-16.2</td></tr> <tr><td>8.362-8.366</td><td>156.52475-156.52525</td><td>2483.5-2500</td><td>17.7-21.4</td></tr> <tr><td>8.37625-8.38675</td><td>156.7-156.9</td><td>2655-2900</td><td>22.01-23.12</td></tr> <tr><td>8.41425-8.41475</td><td>162.0125-167.17</td><td>3260-3267</td><td>23.6-24.0</td></tr> <tr><td>12.29-12.293</td><td>167.72-173.2</td><td>3332-3339</td><td>31.2-31.8</td></tr> <tr><td>12.51975-12.52025</td><td>240-285</td><td>3345.8-3358</td><td>36.43-36.5</td></tr> <tr><td>12.57675-12.57725</td><td>322-335.4</td><td>3600-4400</td><td>(<sup>2</sup>)</td></tr> <tr><td>13.36-13.41</td><td></td><td></td><td></td></tr> </tbody> </table> <p><sup>1</sup>Until February 1, 1999, this restricted band shall be 0.490-0.510 MHz.  <sup>2</sup>Above 38.6</p>	MHz	MHz	MHz	GHz	0.090-0.110	16.42-16.423	399.9-410	4.5-5.15	<sup>1</sup> 0.495-0.505	16.69475-16.69525	608-614	5.35-5.46	2.1735-2.1905	16.80425-16.80475	960-1240	7.25-7.75	4.125-4.128	25.5-25.67	1300-1427	8.025-8.5	4.17725-4.17775	37.5-38.25	1435-1626.5	9.0-9.2	4.20725-4.20775	73-74.6	1645.5-1646.5	9.3-9.5	6.215-6.218	74.8-75.2	1660-1710	10.6-12.7	6.26775-6.26825	108-121.94	1718.8-1722.2	13.25-13.4	6.31175-6.31225	123-138	2200-2300	14.47-14.5	8.291-8.294	149.9-150.05	2310-2390	15.35-16.2	8.362-8.366	156.52475-156.52525	2483.5-2500	17.7-21.4	8.37625-8.38675	156.7-156.9	2655-2900	22.01-23.12	8.41425-8.41475	162.0125-167.17	3260-3267	23.6-24.0	12.29-12.293	167.72-173.2	3332-3339	31.2-31.8	12.51975-12.52025	240-285	3345.8-3358	36.43-36.5	12.57675-12.57725	322-335.4	3600-4400	( <sup>2</sup> )	13.36-13.41			
MHz	MHz	MHz	GHz																																																																						
0.090-0.110	16.42-16.423	399.9-410	4.5-5.15																																																																						
<sup>1</sup> 0.495-0.505	16.69475-16.69525	608-614	5.35-5.46																																																																						
2.1735-2.1905	16.80425-16.80475	960-1240	7.25-7.75																																																																						
4.125-4.128	25.5-25.67	1300-1427	8.025-8.5																																																																						
4.17725-4.17775	37.5-38.25	1435-1626.5	9.0-9.2																																																																						
4.20725-4.20775	73-74.6	1645.5-1646.5	9.3-9.5																																																																						
6.215-6.218	74.8-75.2	1660-1710	10.6-12.7																																																																						
6.26775-6.26825	108-121.94	1718.8-1722.2	13.25-13.4																																																																						
6.31175-6.31225	123-138	2200-2300	14.47-14.5																																																																						
8.291-8.294	149.9-150.05	2310-2390	15.35-16.2																																																																						
8.362-8.366	156.52475-156.52525	2483.5-2500	17.7-21.4																																																																						
8.37625-8.38675	156.7-156.9	2655-2900	22.01-23.12																																																																						
8.41425-8.41475	162.0125-167.17	3260-3267	23.6-24.0																																																																						
12.29-12.293	167.72-173.2	3332-3339	31.2-31.8																																																																						
12.51975-12.52025	240-285	3345.8-3358	36.43-36.5																																																																						
12.57675-12.57725	322-335.4	3600-4400	( <sup>2</sup> )																																																																						
13.36-13.41																																																																									
	(b) Except as provided in paragraphs (d) and (e), the field strength of emissions appearing within these frequency bands shall not exceed the limits shown in 15.209. At frequencies equal to or less than 1000 MHz, compliance with the limits in Section 15.209 shall be demonstrated using measurement instrumentation employing a CISPR quasi-peak detector. Above 1000 MHz, compliance with the emission limits in Section 15.209 shall be demonstrated based on the average value of the measured emissions. The provisions of 15.35 apply to these measurements.																																																																								
FCC CFR 47 §15.209	(a) Except as provided elsewhere in this Subpart, the emissions from an intentional radiator shall not exceed the field strength levels specified in the following table:																																																																								
	<table border="1"> <thead> <tr> <th>Frequency</th> <th>Field Strength</th> <th>Measurement Distance</th> </tr> <tr> <th>MHz</th> <th>uV/m</th> <th>Meters</th> </tr> </thead> <tbody> <tr><td>.009 - 0.490</td><td>2400/F(kHz)</td><td>300</td></tr> <tr><td>0.490 - 1.705</td><td>24000/F(kHz)</td><td>30</td></tr> <tr><td>1.705 - 30.0</td><td>30</td><td>30</td></tr> <tr><td>30 - 88</td><td>100</td><td>3</td></tr> <tr><td>88 - 216</td><td>150</td><td>3</td></tr> <tr><td>216 - 960</td><td>200</td><td>3</td></tr> <tr><td>Above 960</td><td>500</td><td>3</td></tr> </tbody> </table>	Frequency	Field Strength	Measurement Distance	MHz	uV/m	Meters	.009 - 0.490	2400/F(kHz)	300	0.490 - 1.705	24000/F(kHz)	30	1.705 - 30.0	30	30	30 - 88	100	3	88 - 216	150	3	216 - 960	200	3	Above 960	500	3																																													
Frequency	Field Strength	Measurement Distance																																																																							
MHz	uV/m	Meters																																																																							
.009 - 0.490	2400/F(kHz)	300																																																																							
0.490 - 1.705	24000/F(kHz)	30																																																																							
1.705 - 30.0	30	30																																																																							
30 - 88	100	3																																																																							
88 - 216	150	3																																																																							
216 - 960	200	3																																																																							
Above 960	500	3																																																																							
	(b) In the emission table above, the tighter limit applies at the band edges.																																																																								

<b>Test Report S/N:</b>	050405KBC-T635-E15B	Issue 1
<b>Test Date(s):</b>	21Sept04 - 14Oct04, 22Oct04	
<b>Test Type(s):</b>	FCC §15.247	IC RSS-210 Issue 5
<b>Lab Registration(s):</b>	FCC #714830	IC Lab File #3874

I.3. ENVIRONMENTAL CONDITIONS	
<b>Temperature</b>	27.4 +/- 2 °C
<b>Humidity</b>	33 +/- 2 %
<b>Barometric Pressure</b>	96.24 +/- 0.2 kPa

I.4. EQUIPMENT LIST					
ASSET NUMBER	MANUFACTURER	MODEL	DESCRIPTION	LAST CAL	CAL DUE
00072	EMCO	2075	Mini-mast	n/a	n/a
00073	EMCO	2080	Turn Table	n/a	n/a
00071	EMCO	2090	Multi-Device Controller	n/a	n/a
00085	EMCO	6502	Loop Antenna	10Aug04	10Aug05
00050	Chase	CBL-6111A	Bilog Antenna	30Apr04	30Apr05
00035	ETS	3115	Double Ridged Guide Horn	24Mar04	24Mar05
00202	ETS	3160-09	Small Horn Antenna	27May04	27May05
00015	Agilent	E4408B	Spectrum Analyzer	29Dec03	29Dec04
00049	HP	8566B	Spectrum Analyzer RF Section	18May04	18May05
00049	HP	85650A	Quasi-peak Adapter	18May04	18May05
00047	HP	85685A	RF Preselector	18May04	18May05
00048	Gore	65474	Microwave Cable	20May04	20May05
00030	HP	83017A	LNA	20May04	20May05

<b>Applicant:</b>	Itronix Corporation	<b>Model:</b>	IX260P-AC580BT	<b>FCC ID:</b>	KBCIX260P-AC580BT	<b>IC ID:</b>	1943A-IX260Pf
<b>Rugged Laptop PC with Cirronet BT2022 Bluetooth and co-located Sierra Wireless Dual-Band CDMA</b>							
2005 Celltech Labs Inc This document is not to be reproduced in whole or in part without the written permission of Celltech Labs Inc.							35 of 45

### I.5. MEASUREMENT EQUIPMENT SETUP

<b>MEASUREMENT EQUIPMENT CONNECTIONS</b>	The measurement equipment was connected as shown in I.6. A number of antennas were used to cover the applicable frequency range test. The ranges in which each antenna was used are as follows:				
	Frequency Range		Antenna		
	10 kHz – 30 MHz		EMCO 6502 Loop		
	30 MHz – 1 GHz		CBL-6111A Bilog		
	1 GHz – 18 GHz		ETS 3115 Horn		
	18 GHz– 26GHz		ETS 3160-09 Horn		
<b>MEASUREMENT EQUIPMENT SETTINGS</b>	The spectrum analyzer was set to the following settings:				
	Frequency Range	RBW	VBW	Quasi-Peak BW	Detector
	MHz	kHz	kHz	kHz	
	0.01 - 0.15	3 <sup>1</sup>	30	0.2	Peak <sup>2</sup>
	0.15 – 30	100 <sup>1</sup>	300	3	Peak <sup>2</sup>
	30 – 1000	1000 <sup>1</sup>	300	120	Peak <sup>2</sup>
	> 1000	1000	1000	na	Peak <sup>2</sup>
Note 1: The Quasi-peak adapter was placed in normal for all measurements below 1000 MHz, therefore its bandwidths take precedence.					
Note 2: As a worse case measurement, when suitable margin could be realized, the average limit was applied to measurements made with a peak detector.					

### I.6. SETUP DRAWING

Figure I-1 - Setup Drawing

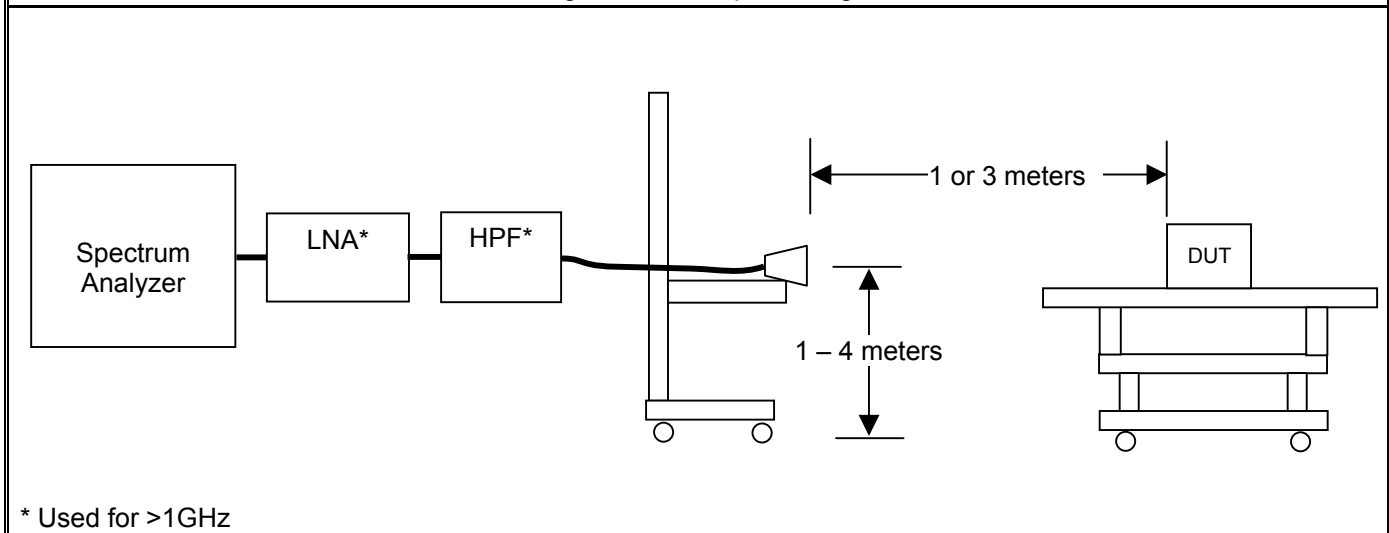

<b>Test Report S/N:</b>	050405KBC-T635-E15B	Issue 1
<b>Test Date(s):</b>	21Sept04 - 14Oct04, 22Oct04	
<b>Test Type(s):</b>	FCC §15.247	IC RSS-210 Issue 5
<b>Lab Registration(s):</b>	FCC #714830	IC Lab File #3874

**I.7. SETUP PHOTOGRAPHS**

Photograph I-1 - Loop Antenna (10kHz -30MHz)



Photograph I-2 - Bilog Antenna (30MHz - 1 GHz)



Photograph I-3 - Horizontal Polarization (30MHz - 1 GHz)



Photograph I-4 - Vertical Polarization (30MHz - 1 GHz)



<b>Applicant:</b>	Itronix Corporation	<b>Model:</b>	IX260P-AC580BT	<b>FCC ID:</b>	KBCIX260P-AC580BT	<b>IC ID:</b>	1943A-IX260Pf	
<b>Rugged Laptop PC with Cirronet BT2022 Bluetooth and co-located Sierra Wireless Dual-Band CDMA</b>								
2005 Celltech Labs Inc This document is not to be reproduced in whole or in part without the written permission of Celltech Labs Inc.							37 of 45	



<b>Test Report S/N:</b>	050405KBC-T635-E15B	Issue 1
<b>Test Date(s):</b>	21Sept04 - 14Oct04, 22Oct04	
<b>Test Type(s):</b>	FCC §15.247	IC RSS-210 Issue 5
<b>Lab Registration(s):</b>	FCC #714830	IC Lab File #3874

Photograph I-5 - Front of Radiated Emission Configuration



Photograph I-6 - Back of Radiated Emission Configuration

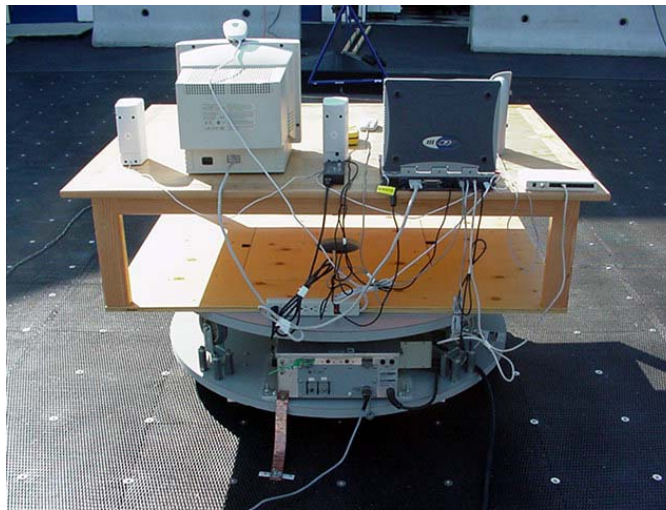

#### I.8. DUT OPERATING DESCRIPTION

Measurements were made at three channels throughout the band, Low Channel (2402 MHz), Mid Channel (2441 MHz), High Channel (2480 MHz). The configuration used was with a gain setting of 250/40 for the low channel, 250/44 for mid channel and 220/45 for the high channel. The modulation was set to 1000. As a worst case, the band-edge measurements were made of the low and high channels with data stream modulation.

<b>Applicant:</b>	Itronix Corporation	<b>Model:</b>	IX260P-AC580BT	<b>FCC ID:</b>	KBCIX260P-AC580BT	<b>IC ID:</b>	1943A-IX260Pf
<b>Rugged Laptop PC with Cirronet BT2022 Bluetooth and co-located Sierra Wireless Dual-Band CDMA</b>							
2005 Celltech Labs Inc This document is not to be reproduced in whole or in part without the written permission of Celltech Labs Inc.							38 of 45

<b>Test Report S/N:</b>	050405KBC-T635-E15B	Issue 1
<b>Test Date(s):</b>	21Sept04 - 14Oct04, 22Oct04	
<b>Test Type(s):</b>	FCC §15.247	IC RSS-210 Issue 5
<b>Lab Registration(s):</b>	FCC #714830	IC Lab File #3874

## I.9. TEST RESULTS

### I.9.1. Upper Band-edge Emission Field Strengths @ Specified Distance

Note: (Lower Band-edge (Out-of-Band) is in Appendix H)

#### Channel 79 - Conducted Band-edge Plots

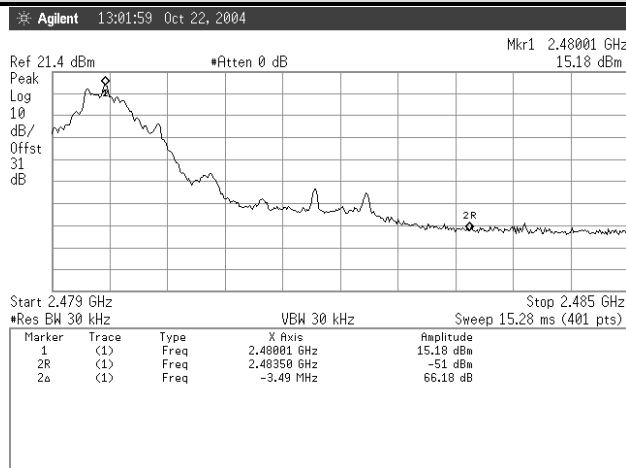

#### Channel 0 - Radiated Carrier Field Strengths

Polarity	Distance	Rx Antenna	Channel	Frequency	SA Level	Rx AF	Rx CL	Other Rx	Total Rx CF	Field Strength	Detector
				MHz	dBuV	dB/m	dB	dB	dB/m	dBuV/m	(PK/QP/AVG)
H	3	Horn SN6276	79	2480.00	83.00	30.37	3.51	0.00	33.88	116.88	PK
H	3	Horn SN6276	79	2480.00	41.80	30.37	3.51	0.00	33.88	75.68	AV
V	3	Horn SN6276	79	2480.00	76.70	30.37	3.51	0.00	33.88	110.58	PK
V	3	Horn SN6276	79	2480.00	39.10	30.37	3.51	0.00	33.88	72.98	AV

#### Channel 0 - Calculated Band-edge (Out-of-Band) Field Strengths

Polarity	Distance	Rx Antenna	Channel	Frequency	Carrier Radiated Field Strength	Detector	Marker-Delta	Calculated Band-edge Field Strength	Limit Distance	Limit Distance Correction	Calculated Limit	Margin	Pass/Fail
				MHz	dBuV/m		dB	dBuV/m	m	dB	dBuV/m	dB	
H	3	Horn SN6276	79	2483.5	116.88	PK	66.18	50.7	3	0	73.98	23.28	Pass
H	3	Horn SN6276	79	2483.5	75.68	AV	66.18	9.5	3	0	53.98	44.48	Pass
V	3	Horn SN6276	79	2483.5	110.58	PK	66.18	44.4	3	0	73.98	29.58	Pass
V	3	Horn SN6276	79	2483.5	72.98	AV	66.18	6.8	3	0	53.98	47.18	Pass

Formulae:

Total CF (dB) = Antenna Factor (dB) + Cable Factor (dB) + Other Factor (Amplifier Gain, Filter Loss, etc) (dB)

Field Strength (dBuV/m) = SA Reading (dBuV) + Total CF (dB/m)

Limit Distance Correction (dB) =  $40 * \log(d1/d2)$  for  $f < 30$  MHz,  $20 * \log(d1/d2)$  for  $f > 30$  MHz, where  $d1$  is the measurement distance and  $d2$  is the published limit

Limit (dBuV/m) = Published Limit (dBuV/m) + Limit Distance Correction (dB)

Margin (dB) = Limit (dBuV/m) - Field Strength (dBuV/m)

**Note: Measurements and calculation reference the Marker-Delta Method Described in FCC Public Notice DA 00-705**

<b>Applicant:</b>	Itronix Corporation	<b>Model:</b>	IX260P-AC580BT	<b>FCC ID:</b>	KBCIX260P-AC580BT	<b>IC ID:</b>	1943A-IX260Pf
<b>Rugged Laptop PC with Cirronet BT2022 Bluetooth and co-located Sierra Wireless Dual-Band CDMA</b>							
2005 Celltech Labs Inc This document is not to be reproduced in whole or in part without the written permission of Celltech Labs Inc.							39 of 45

Test Report S/N:	050405KBC-T635-E15B	Issue 1
Test Date(s):	21Sep04 - 14Oct04, 22Oct04	
Test Type(s):	FCC §15.247	IC RSS-210 Issue 5
Lab Registration(s):	FCC #714830	IC Lab File #3874

### I.9.2. Spurious Emission Field Strengths @ Specified Distance



Company: 072804KBC-T543-E15B  
 Product: Itronix  
 IX260+ with Bluetooth

Standard: FCC15.209  
 Test Start Date: 21Sep04  
 Test End Date: 12Oct04

IX260+ with Bluetooth																			
Channel	Polarity	Distance	Rx Antenna	Frequency	SA Level	Noise Floor	Rx AF	Rx CL	Other Rx	*Duty Cycle Correction	Total Rx CF	Field Strength	Detector	Limit Distance	Limit Distance Correction	Calculated Limit	Margin	Pass/Fail	
																			m
BT-Low	H	3	Horn SN6276	2000.00	14.40	x	29.60	3.18	0.00	-20.00	12.78	27.18	PK	3.00	0.00	53.98	26.80	PASS	
BT-Low	H	3	Horn SN6276	2390.00	36.40		30.22	3.47	0.00	-20.00	13.69	50.09	PK	3.00	0.00	53.98	3.89	PASS	
BT-Low	H	3	Horn SN6276	2483.00	50.90		30.37	3.51	-20.26	-20.00	-6.37	44.53	PK	3.00	0.00	53.98	9.45	PASS	
BT-Low	H	3	Horn SN6276	7206.72	52.40		38.17	6.21	-34.32	-20.00	-9.94	42.46	PK	3.00	0.00	53.98	11.52	PASS	
BT-Low	H	1	Horn SN6276	17986.00	44.90		45.86	10.43	-32.01	-20.00	4.28	49.18	PK	3.00	9.54	63.52	14.35	PASS	
BT-Low	V	3	Horn SN6276	2000.00	17.00	x	29.60	3.18	0.00	-20.00	12.78	29.78	PK	3.00	0.00	53.98	24.20	PASS	
BT-Low	V	3	Horn SN6276	2390.00	29.20		30.22	3.47	0.00	-20.00	13.69	42.89	PK	3.00	0.00	53.98	11.09	PASS	
BT-Low	V	3	Horn SN6276	2483.00	44.00		30.37	3.51	-20.26	-20.00	-6.37	37.63	PK	3.00	0.00	53.98	16.35	PASS	
BT-Low	V	3	Horn SN6276	4804.58	52.70		35.31	4.96	-34.08	-20.00	-13.81	38.89	PK	3.00	0.00	53.98	15.09	PASS	
BT-Low	V	3	Horn SN6276	4804.46	50.80		35.31	4.96	-34.08	-20.00	-13.81	36.99	PK	3.00	0.00	53.98	16.99	PASS	
BT-Low	V	3	Horn SN6276	7207.22	57.30		38.17	6.21	-34.32	-20.00	-9.93	47.37	PK	3.00	0.00	53.98	6.61	PASS	
BT-Low	V	1	Horn SN6276	17874.00	44.50		45.52	10.28	-32.09	-20.00	3.71	48.21	PK	3.00	9.54	63.52	15.31	PASS	
BT-Mid	H	3	Horn SN6276	2000.00	14.40	x	29.60	3.18	0.00	-20.00	12.78	27.18	PK	3.00	0.00	53.98	26.80	PASS	
BT-Mid	H	3	Horn SN6276	2390.00	47.20		30.22	3.47	-20.40	-20.00	-6.71	40.49	PK	3.00	0.00	53.98	13.49	PASS	
BT-Mid	H	3	Horn SN6276	2483.50	51.60		30.37	3.51	-20.26	-20.00	-6.37	45.23	PK	3.00	0.00	53.98	8.75	PASS	
BT-Mid	H	3	Horn SN6276	4882.41	55.90		35.46	5.04	-34.09	-20.00	-13.59	42.31	PK	3.00	0.00	53.98	11.67	PASS	
BT-Mid	H	3	Horn SN6276	7323.65	50.00		38.38	6.32	-34.32	-20.00	-9.62	40.38	PK	3.00	0.00	53.98	13.60	PASS	
BT-Mid	H	1	Horn SN6276	17992.00	44.50		45.88	10.45	-32.01	-20.00	4.32	48.82	PK	3.00	9.54	63.52	14.70	PASS	
BT-Mid	V	3	Horn SN6276	2000.00	17.00	x	29.60	3.18	0.00	-20.00	12.78	29.78	PK	3.00	0.00	53.98	24.20	PASS	
BT-Mid	V	3	Horn SN6276	2390.00	50.30		30.22	3.47	-20.40	-20.00	-6.71	43.59	PK	3.00	0.00	53.98	10.39	PASS	
BT-Mid	V	3	Horn SN6276	2483.50	45.90		30.37	3.51	-20.26	-20.00	-6.37	39.53	PK	3.00	0.00	53.98	14.45	PASS	
BT-Mid	V	3	Horn SN6276	4882.23	49.80		35.46	5.04	-34.09	-20.00	-13.59	36.21	PK	3.00	0.00	53.98	17.77	PASS	
BT-Mid	V	3	Horn SN6276	7323.74	55.80		38.38	6.32	-34.32	-20.00	-9.62	46.18	PK	3.00	0.00	53.98	7.80	PASS	
BT-Mid	V	3	Horn SN6276	9764.87	49.40		40.30	7.41	-34.25	-20.00	-6.54	42.86	PK	3.00	0.00	53.98	11.12	PASS	
BT-Mid	V	1	Horn SN6276	18000.00	43.90		45.90	10.48	-32.00	-20.00	4.38	48.28	PK	3.00	9.54	63.52	15.24	PASS	
BT-High	H	3	Horn SN6276	2000.00	14.40	x	29.60	3.18	0.00	-20.00	12.78	27.18	PK	3.00	0.00	53.98	26.80	PASS	
BT-High	H	3	Horn SN6276	2390.00	50.50		30.22	3.47	-20.40	-20.00	-6.71	43.79	PK	3.00	0.00	53.98	10.19	PASS	
BT-High	H	3	Horn SN6276	2483.50	46.40		30.37	3.51	0.00	-20.00	13.89	60.29	PK	3.00	0.00	73.98	13.69	PASS	
BT-High	H	3	Horn SN6276	2483.50	26.60		30.37	3.51	0.00	-20.00	13.89	40.49	PK	3.00	0.00	53.98	13.49	PASS	
BT-High	H	3	Horn SN6276	4960.48	52.20		35.62	5.06	-34.10	-20.00	-13.42	38.78	PK	3.00	0.00	53.98	15.19	PASS	
BT-High	H	1	Horn SN6276	17862.00	44.70		45.49	10.28	-32.10	-20.00	3.67	48.37	PK	3.00	9.54	63.52	15.16	PASS	
BT-High	V	3	Horn SN6276	2000.00	17.00	x	29.60	3.18	0.00	-20.00	12.78	29.78	PK	3.00	0.00	53.98	24.20	PASS	
BT-High	V	3	Horn SN6276	2390.00	48.00		30.22	3.47	-20.40	-20.00	-6.71	41.29	PK	3.00	0.00	53.98	12.69	PASS	
BT-High	V	3	Horn SN6276	2483.50	40.30		30.37	3.51	0.00	-20.00	13.89	54.19	PK	3.00	0.00	73.98	19.79	PASS	
BT-High	V	3	Horn SN6276	2483.50	24.10		30.37	3.51	0.00	-20.00	13.89	37.99	AV	3.00	0.00	53.98	15.99	PASS	
BT-High	V	3	Horn SN6276	4960.39	50.80		35.62	5.06	-34.10	-20.00	-13.42	37.38	PK	3.00	0.00	53.98	16.59	PASS	
BT-High	V	3	Horn SN6276	7440.88	49.80		38.59	6.43	-34.32	-20.00	-9.29	40.51	PK	3.00	0.00	53.98	13.47	PASS	
BT-High	V	1	Horn SN6276	17936.00	44.70		45.71	10.28	-32.04	-20.00	3.94	48.64	PK	3.00	9.54	63.52	14.88	PASS	

**Formulae:**

Total CF (dB) = Antenna Factor (dB) + Cable Factor (dB) + Other Factor (Amplifier Gain, Filter Loss, etc) (dB)  
 Field Strength (dBuV/m) = SA Reading (dBuV) + Total CF (dB/m)  
 Limit Distance Correction (dB) = 40 \* log(d1/d2) for f < 30 MHz, 20\*log(d1/d2) for f > 30 MHz; where d1 is the measurement distance and d2 is the published limit distance  
 Limit (dBuV/m) = Published Limit (dBuV/m) + Limit Distance Correction (dB)  
 Margin (dB) = Limit (dBuV/m) - Field Strength (dBuV/m)  
 Duty Cycle Correction (dB) = 20 \* log (duty cycle ratio)  
 Duty Cycle ratio = maximum time on in any 100 mS period (in mS) / 100 mS

\*DUT duty cycle = 10 mS in each 10 seconds

\*The frequency points reported, describe the highest emission measured in each of the ranges tested and are used to describe the measured spectrum as a whole. Though a frequency point detailed may not be in a restricted band, it was the highest emission present in the band measured therefore infers that all emissions that may be present within the restricted bands are in compliance if it is in compliance.

Applicant:	Itronix Corporation	Model:	IX260P-AC580BT	FCC ID:	KBCIX260P-AC580BT	IC ID:	1943A-IX260Pf	
Rugged Laptop PC with Cirronet BT2022 Bluetooth and co-located Sierra Wireless Dual-Band CDMA								
2005 Celltech Labs Inc This document is not to be reproduced in whole or in part without the written permission of Celltech Labs Inc.							40 of 45	



<b>Test Report S/N:</b>	050405KBC-T635-E15B	Issue 1
<b>Test Date(s):</b>	21Sept04 - 14Oct04, 22Oct04	
<b>Test Type(s):</b>	FCC §15.247	IC RSS-210 Issue 5
<b>Lab Registration(s):</b>	FCC #714830	IC Lab File #3874

**I.10. PASS/FAIL**

In reference to the results outlined in I.9, the DUT passes the requirements as stated in the reference standards as follows: FCC 15.205 (a) (b) and 15.209 (a): No emissions were measured within the restricted bands as outlined in 15.205 that exceeded the limits stated in 15.209.

**I.11. SIGN-OFF**

I attest to the accuracy of the data. All measurements reported herein were performed by me and are correct to the best of my knowledge and belief. I assume full responsibility for the completeness of these measurements.



Russell Pipe  
Senior Compliance Technologist  
Celltech Labs Inc.

22Oct04

Date

<b>Applicant:</b>	Itronix Corporation	<b>Model:</b>	IX260P-AC580BT	<b>FCC ID:</b>	KBCIX260P-AC580BT	<b>IC ID:</b>	1943A-IX260Pf
<b>Rugged Laptop PC with Cirronet BT2022 Bluetooth and co-located Sierra Wireless Dual-Band CDMA</b>							
2005 Celltech Labs Inc This document is not to be reproduced in whole or in part without the written permission of Celltech Labs Inc.							41 of 45

<b>Test Report S/N:</b>	050405KBC-T635-E15B	Issue 1
<b>Test Date(s):</b>	21Sept04 - 14Oct04, 22Oct04	
<b>Test Type(s):</b>	FCC §15.247	IC RSS-210 Issue 5
<b>Lab Registration(s):</b>	FCC #714830	IC Lab File #3874

## Appendix J - Maximum Permissible Exposure Calculation

J.1. REFERENCES	
<b>Normative Reference Standard</b>	FCC CFR 47§1.1310 IEEE Std C95.1-1992
<b>Procedure Reference</b>	FCC CFR 47§2.1091

J.2. LIMITS	
FCC CFR 47§1.1310 Table 1(b)	1.0 mW/cm <sup>2</sup>

J.3. ENVIRONMENTAL CONDITIONS	
<b>Temperature</b>	na
<b>Humidity</b>	na
<b>Barometric Pressure</b>	na

J.4. EQUIPMENT LIST					
ASSET NUMBER	MANUFACTURER	MODEL	DESCRIPTION	LAST CAL	CAL DUE
na					

J.5. MEASUREMENT EQUIPMENT SETUP	
<b>MEASUREMENT EQUIPMENT CONNECTIONS</b>	The results described herein were determined by the following calculation, so no measurement equipment was used.
<b>MEASUREMENT EQUIPMENT SETTINGS</b>	na

J.6. SETUP PHOTOS	
na	

J.7. SETUP DRAWINGS	
na	

J.8. DUT OPERATING DESCRIPTION	
na	

Test Report S/N:	050405KBC-T635-E15B	Issue 1
Test Date(s):	21Sept04 - 14Oct04, 22Oct04	
Test Type(s):	FCC §15.247	IC RSS-210 Issue 5
Lab Registration(s):	FCC #714830	IC Lab File #3874

### J.9. EVALUATION RESULTS

#### Calculation:

**RangeStar Internal Surface-Mount Antenna:**

Tx Frequency:	2441	(MHz)
RF Output Power at Antenna Input Terminal:	15.61	(dBm)
Antenna gain:	4.50	(dBi)

S= 1.00 (mW/cm<sup>2</sup>)  
 P= 36.3915 (mW)  
 G= 2.82 (numeric)

R = 2.86 (cm)

S at 20cm: 0.02038259 (mW/cm<sup>2</sup>)

#### Formulae:

$S = \frac{PG}{4\pi R^2}$ $R = \sqrt{\frac{P}{4\pi S}}$	<p>where: S = Power Density Limit          P = Power Applied to the Antenna          G = Numeric Antenna Gain          R = Distance from Antenna</p>
---	--

#### Results:

Channel	RF Conducted Output Power	Antenna Gain	MPE Distance	Power Density at 20 cm	Power Density Limit
	dBm	dBi	cm	mW/cm <sup>2</sup>	mW/cm <sup>2</sup>
39	15.61	4.5	2.86	0.020	1.0

<b>Test Report S/N:</b>	050405KBC-T635-E15B	Issue 1
<b>Test Date(s):</b>	21Sept04 - 14Oct04, 22Oct04	
<b>Test Type(s):</b>	FCC §15.247	IC RSS-210 Issue 5
<b>Lab Registration(s):</b>	FCC #714830	IC Lab File #3874

**J.10. PASS/FAIL**

In reference to the results outlined in J.9, the DUT passes the requirements as stated in the reference standards as follows:  
 1) The DUT must comply with the minimum spacing requirement of 20 cm to ensure an exposure of not more than 1 mW/cm<sup>2</sup>.

**J.11. SIGN-OFF**

I attest to the accuracy of the data. All measurements reported herein were performed by me and are correct to the best of my knowledge and belief. I assume full responsibility for the completeness of these measurements.



\_\_\_\_\_  
 Duane M. Friesen, C.E.T.  
 EMC Manager  
 Celltech Labs Inc.

09Oct04  
 \_\_\_\_\_  
 Date

<b>Applicant:</b>	Itronix Corporation	<b>Model:</b>	IX260P-AC580BT	<b>FCC ID:</b>	KBCIX260P-AC580BT	<b>IC ID:</b>	1943A-IX260Pf
<b>Rugged Laptop PC with Cirronet BT2022 Bluetooth and co-located Sierra Wireless Dual-Band CDMA</b>							
2005 Celltech Labs Inc This document is not to be reproduced in whole or in part without the written permission of Celltech Labs Inc.							44 of 45

<b>Test Report S/N:</b>	050405KBC-T635-E15B	Issue 1
<b>Test Date(s):</b>	21Sept04 - 14Oct04, 22Oct04	
<b>Test Type(s):</b>	FCC §15.247	IC RSS-210 Issue 5
<b>Lab Registration(s):</b>	FCC #714830	IC Lab File #3874

**END OF DOCUMENT**

<b>Applicant:</b>	Itronix Corporation	<b>Model:</b>	IX260P-AC580BT	<b>FCC ID:</b>	KBCIX260P-AC580BT	<b>IC ID:</b>	1943A-IX260Pf
<b>Rugged Laptop PC with Cirronet BT2022 Bluetooth and co-located Sierra Wireless Dual-Band CDMA</b>							
2005 Celltech Labs Inc This document is not to be reproduced in whole or in part without the written permission of Celltech Labs Inc.							45 of 45