



AirCard 860 Partial Test Report

For

Industry Canada and FCC Certification

IC: 2417C-AC860
FCC ID: N7NAC860

Prepared by
SIERRA WIRELESS INC.
13811 WIRELESS WAY
RICHMOND, BC V6V 3A4
CANADA

Test Date(s): September 12, 2005,
September 30, 2005

© 2004 Sierra Wireless, Inc.

This document contains information which is proprietary and confidential to Sierra Wireless, Inc. Disclosure to persons other than the officers, employees, agents, or subcontractors of the Company or licensee of this document without the prior written permission of Sierra Wireless, Inc. is strictly prohibited.

Table of Contents

1	Introduction and Purpose	3
2	Test Summary	3
3	Description of Equipment Under Test	4
4	RF Power Output	5
4.1	<i>Test Procedure</i>	5
4.2	<i>Test Equipment</i>	5
4.3	<i>Test Results GSM/EDGE</i>	6
4.4	<i>Test Results UMTS</i>	6
5	Occupied Bandwidth	7
5.1	<i>Test Procedure</i>	7
5.2	<i>Test Results</i>	7
5.3	<i>Test Plots</i>	8
6	Out of Band Emissions at Antenna Terminals	17
6.1	<i>Test Procedure</i>	17
6.2	<i>Test Equipment</i>	17
6.3	<i>Test Results</i>	18
6.4	<i>Test Plots</i>	19
7	Block Edge Compliance	55
7.1	<i>Test Procedure</i>	55
7.2	<i>Test Equipment</i>	55
7.3	<i>Test Results</i>	55
7.4	<i>Test Plots</i>	56
8	Frequency Stability Versus Temperature	62
8.1	<i>Summary of Results</i>	62
8.2	<i>Test Procedure</i>	62
8.3	<i>Test Equipment</i>	62
8.4	<i>Test Results</i>	63
9	Frequency Stability Versus Voltage	67
9.1	<i>Summary of Results</i>	67
9.2	<i>Test Procedure</i>	67
9.3	<i>Test Equipment</i>	67
9.4	<i>Test Results</i>	68

SIERRA WIRELESS, INC.

FCC Part 22 & 24 Test Report	AC860	Sept 30, 2005	Page 3 of 70
------------------------------	-------	---------------	--------------

1 Introduction and Purpose

This document provides the FCC test data for the AC860 wireless modem. The tests included in this report are limited to all conducted tests required. The radiated tests were performed at an external test facility.

2 Test Summary

FCC RULE	DESCRIPTION OF TEST	RESULT	PAGE
2.1046	RF Power Output	Complies	5
2.1049	Occupied Bandwidth	Complies	7
2.1051, 22.901(d) 22.917, 24.238(a)	Out of Band Emissions at Antenna Terminals	Complies	17
FCC part 22H/24E	Block Edge Requirements	Complies	43
2.1053	Field Strength of Spurious Radiation	Complies	See CCS Report
2.1055	Frequency Stability versus Temperature	Complies	61
2.1055	Frequency Stability versus Voltage	Complies	64

The tests described in this report were performed by Mr. Philip Wright at:

Sierra Wireless, Inc.
13811 Wireless Way
Richmond, B.C. V6V 3A4
Canada

SIERRA WIRELESS, INC.

FCC Part 22 & 24 Test Report	AC860	Sept 30, 2005	Page 4 of 70
------------------------------	-------	---------------	--------------

3 Description of Equipment Under Test

The Sierra Wireless Inc. model AirCard AC860 is a quad-band PCMCIA card wireless modem operating on the GSM/GPRS/EDGE/UMTS network. In the US and Canada, only cellular and PCS bands are used for GSM/GPRS operation, so this test report only contains data for these two bands (850MHz and 1900MHz). The EUT was tested in both modes of operation: GMSK modulation, 8-PSK, and WCDMA modulation. The EUT is a production sample and the serial number is: X1720158065E2



4 RF Power Output

FCC 2.1046

4.1 Test Procedure

The transmitter output was connected to a Rohde & Schwarz CMU200 Test Set and configured to operate at maximum power in a call. The power was measured using the spectrum analyzer at three equally spaced operating frequencies for each band. The RBW was set to 300 KHz for the GSM and EDGE measurements, and 5MHz for the WCDMA measurements. The spectrum analyzer was set to measure the RF output power with the cable and coupler losses accounted for.

Test Setup

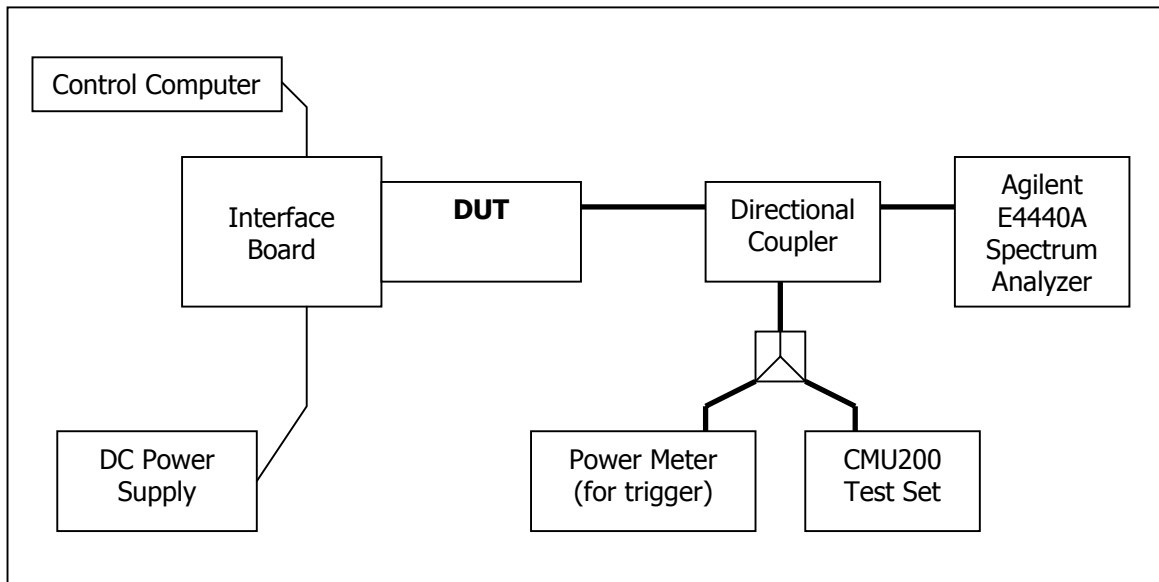

4.2 Test Equipment

Instrument List

EQUIPMENT	MANUFACTURER	MODEL NO.	SERIAL NO.	CAL. DATE
Control Computer	TC	Generic PC	100488	N/A
Wireless Test Set	Rohde & Schwarz	CMU200	836766/030	N/A
Spectrum Analyzer	Agilent	PSA E4440A	US41421268	Sept. 29, 2004
DC Power Supply	HP	6632A	3530A	N/A
Interface Board	Shop built	Minnow	N/A	N/A
Directional Coupler	Mini-Circuits	ZA3PD-2	N/A	N/A

SIERRA WIRELESS, INC.

4.3 Test Results GSM/EDGE

Frequency (MHz)	Channel	Power (dBm)	
		GMSK Mode	8-PSK Mode
824.2	128	31.63	26.84
837.0	192	32.27	26.91
848.8	251	31.69	26.91
1850.2	512	29.23	26.22
1880.0	661	29.04	25.41
1909.8	810	29.19	25.14

4.4 Test Results UMTS

Frequency (MHz)	Channel	Power (dBm)
826.4	4132	22.48
836.4	4182	23.58
846.6	4233	23.19
1852.4	9262	23.54
1880.0	9400	23.05
1907.5	9538	23.12

5 Occupied Bandwidth

FCC 2.1049

5.1 Test Procedure

The transmitter output was connected to a calibrated coaxial cable and coupler, the other end of which was connected to a spectrum analyzer. The occupied bandwidth (defined as the 99% Power Bandwidth) was measured with the spectrum analyzer at the 3 frequencies in each band. The -26dB bandwidth was also measured and recorded.

Test Setup

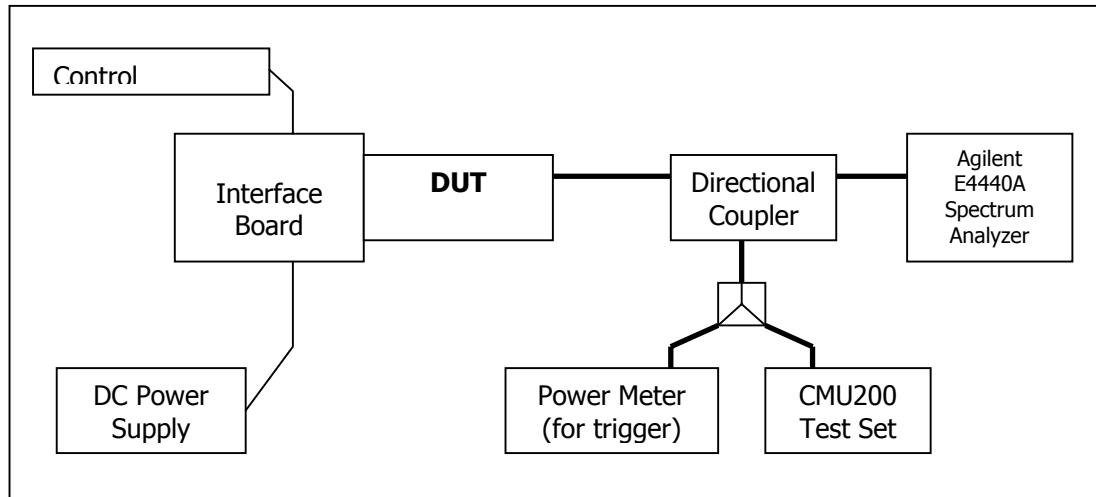

5.2 Test Results

The performance of the GSM 850 MHz cellular band is shown in plots 5.3.1 to 5.3.6.

Performance of the GSM 1900 MHz PCS band is shown in plots 5.3.7 to 5.3.12.

Performance of the UMTS 850 cellular band is shown in plots 5.3.13 to 5.3.15

Performance of the UMTS 1900 PCS band is shown in plots 5.3.16 to 5.3.18

Frequency (MHz)	Channel	99% Occupied Bandwidth (kHz)		-26dBc Occupied Bandwidth (kHz)	
		GMSK Mode	8-PSK Mode	GMSK Mode	8-PSK Mode
824.2	128	244	241	313	312
837.0	192	242	242	311	311
848.8	251	242	243	314	313
1850.2	512	246	245	315	309
1880.0	661	240	244	310	301
1909.8	810	242	246	314	310
Frequency (MHz)	Channel	99% Occupied Bandwidth (MHz)		-26dBc Occupied Bandwidth (MHz)	
826.4	4132	4.13		4.64	
836.4	4182	4.14		4.64	
846.6	4233	4.15		4.64	
1852.4	9262	4.14		4.62	
1880.0	9400	4.13		4.61	
1907.5	9538	4.13		4.62	

5.3 Test Plots

5.3.1) GSMK Occupied Bandwidth, Cellular Low channel, 824.2 MHz, 99% bandwidth

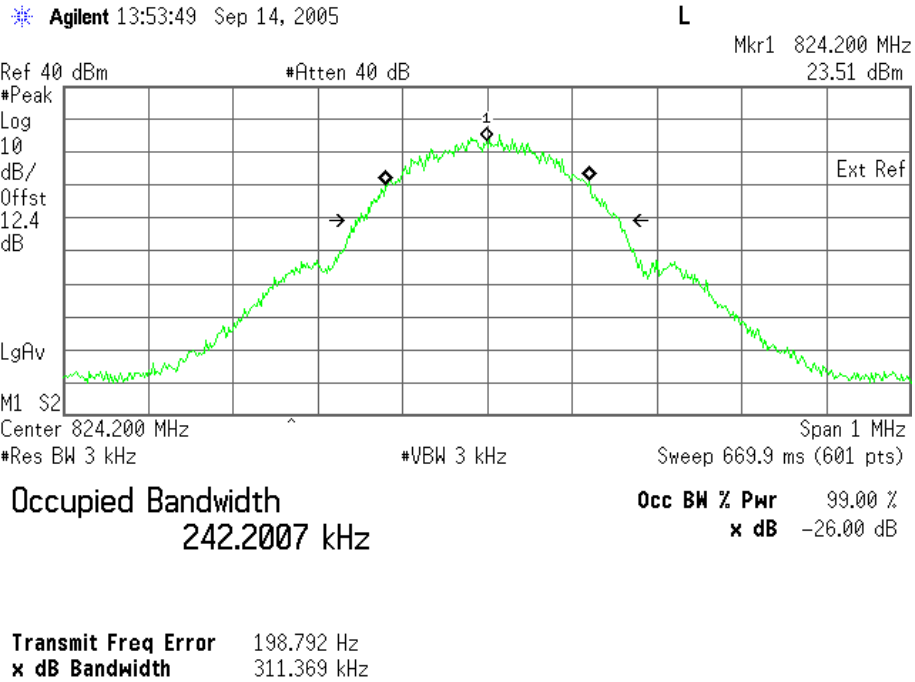

5.3.2) GSMK Occupied Bandwidth, Middle channel, 837 MHz, 99% bandwidth

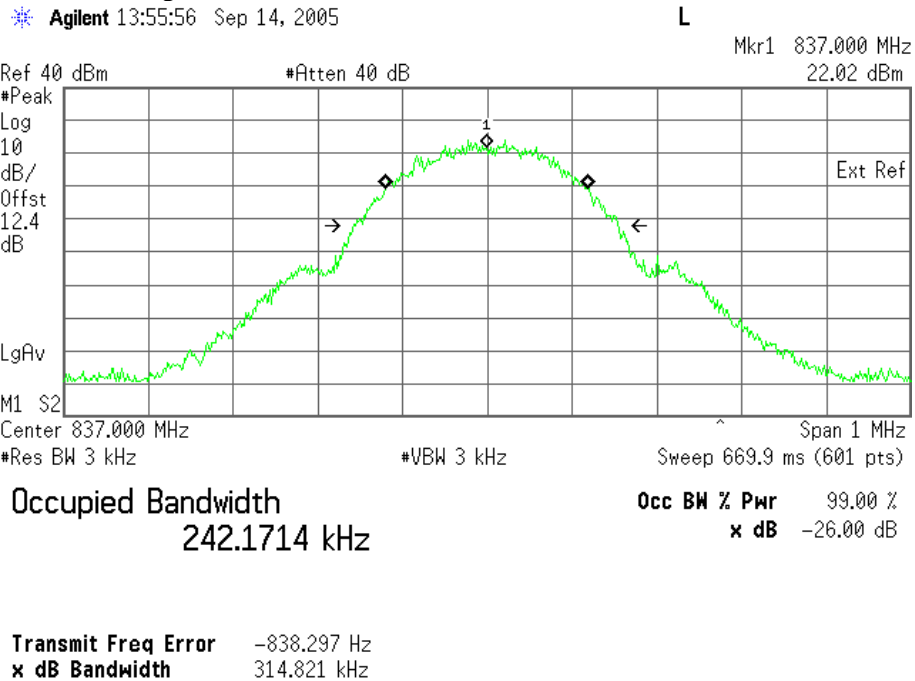

SIERRA WIRELESS, INC.

5.3.3) GMSK Occupied Bandwidth, High channel, 848.8 MHz, 99% bandwidth

Agilent 13:58:19 Sep 14, 2005

L

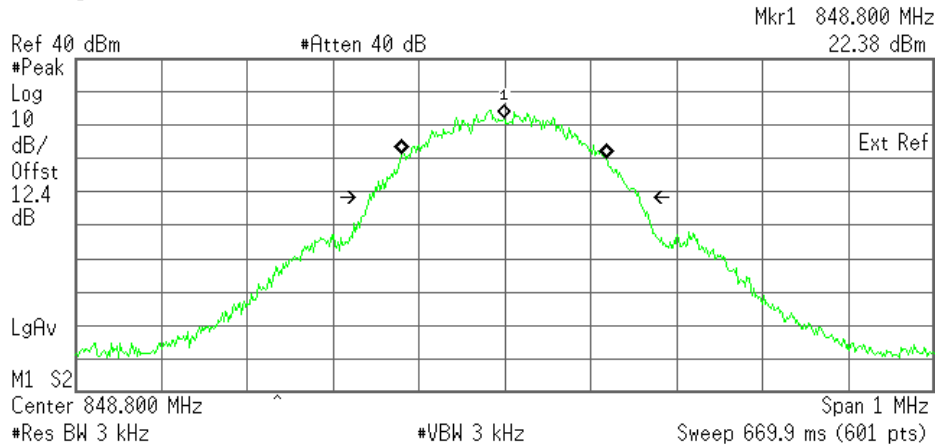

Occupied Bandwidth
242.1669 kHz

Occ BW % Pwr 99.00 %
x dB -26.00 dB

Transmit Freq Error -575.672 Hz
Occupied Bandwidth 317.917 kHz

5.3.4) 8-PSK Occupied Bandwidth, Cellular Low channel, 824.2 MHz, 99% bandwidth

Agilent 14:03:16 Sep 14, 2005

L

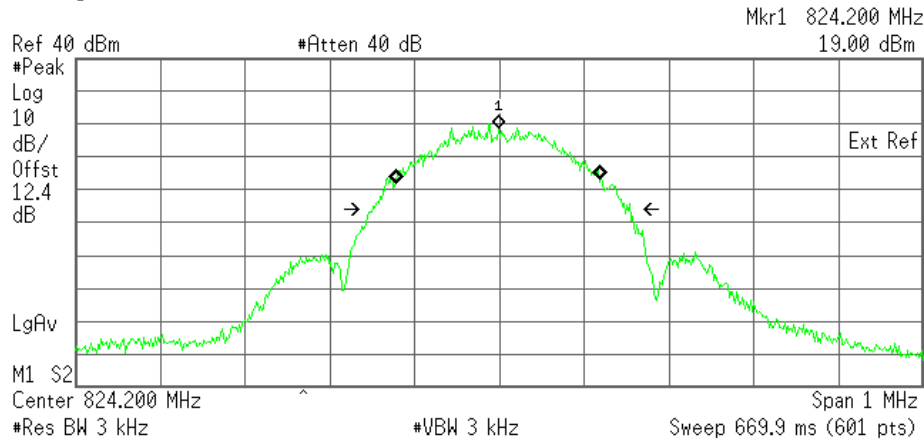

Occupied Bandwidth
244.4062 kHz

Occ BW % Pwr 99.00 %
x dB -26.00 dB

Transmit Freq Error -1.728 kHz
Occupied Bandwidth 306.948 kHz

SIERRA WIRELESS, INC.

5.3.5) 8-PSK Occupied Bandwidth, Middle channel, 837 MHz, 99% bandwidth

Agilent 14:01:33 Sep 14, 2005

L

Mkr1 837.000 MHz
20.07 dBm

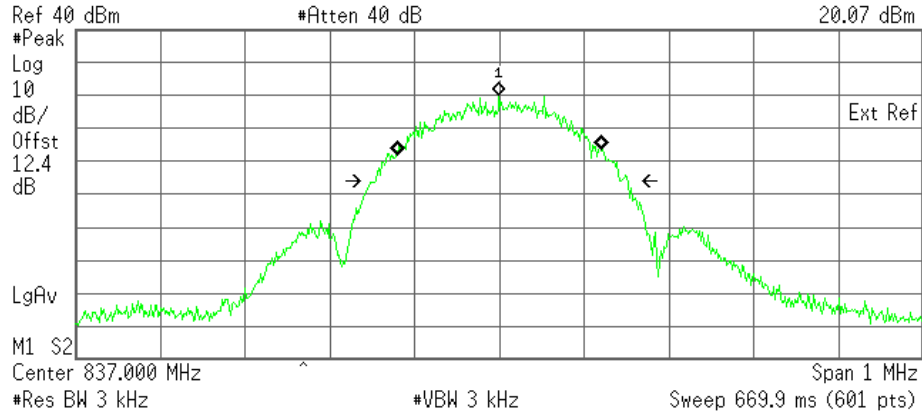

Occupied Bandwidth
242.0839 kHz

Occ BW % Pwr 99.00 %
x dB -26.00 dB

Transmit Freq Error -462.876 Hz
Occupied Bandwidth 300.563 kHz

5.3.6) 8-PSK Occupied Bandwidth, High channel, 848.8 MHz, 99% bandwidth

Agilent 14:05:13 Sep 14, 2005

L

Mkr1 848.800 MHz
18.26 dBm

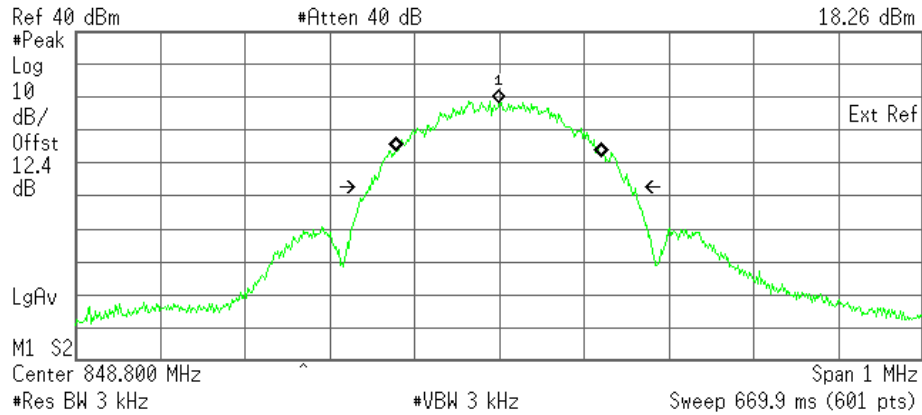

Occupied Bandwidth
245.7973 kHz

Occ BW % Pwr 99.00 %
x dB -26.00 dB

Transmit Freq Error -748.648 Hz
Occupied Bandwidth 311.936 kHz

SIERRA WIRELESS, INC.

5.3.7) GMSK Occupied Bandwidth, PCS Low channel, 1850.2 MHz, 99% bandwidth

Agilent 10:21:17 Sep 30, 2005

L



Occupied Bandwidth
246.3869 kHz

Occ BW % Pwr 99.00 %
x dB -26.00 dB

Transmit Freq Error -251.519 Hz
x dB Bandwidth 315.046 kHz

5.3.8) GMSK Occupied Bandwidth, PCS Middle channel, 1880.0 MHz, 99% bandwidth

Agilent 14:14:34 Sep 14, 2005

L

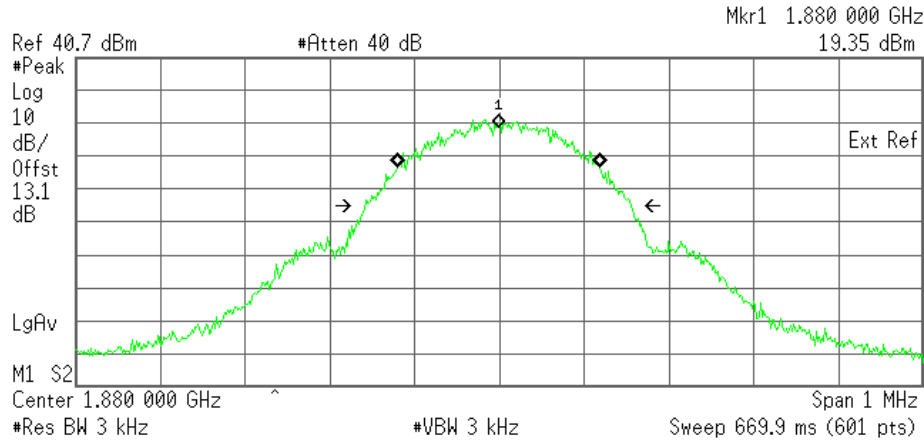

Occupied Bandwidth
241.2322 kHz

Occ BW % Pwr 99.00 %
x dB -26.00 dB

Transmit Freq Error -1.045 kHz
Occupied Bandwidth 316.137 kHz

5.3.9) GMSK Occupied Bandwidth, PCS High channel, 1909.8 MHz, 99% bandwidth

Agilent 10:25:23 Sep 30, 2005

L

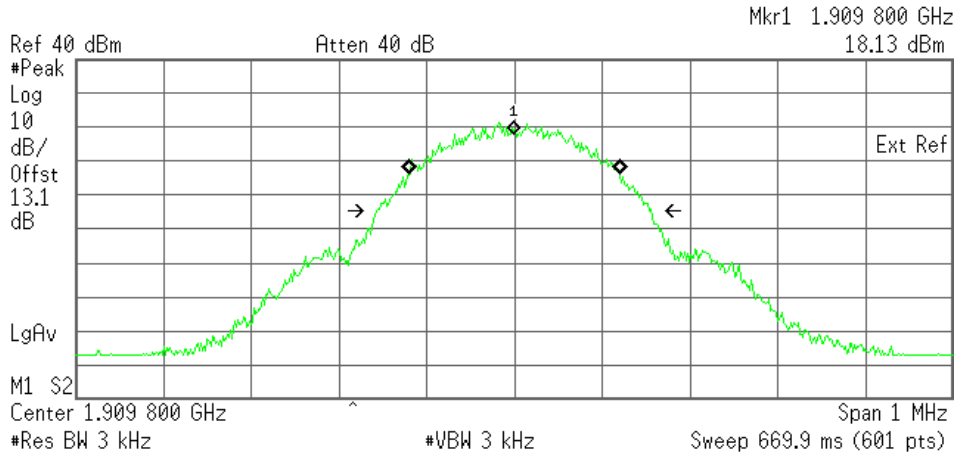

Occupied Bandwidth
242.0121 kHz

Occ BW % Pwr 99.00 %
x dB -26.00 dB

Transmit Freq Error 10.530 Hz
x dB Bandwidth 314.014 kHz

5.3.10) 8-PSK Occupied Bandwidth, PCS Low channel, 1850.2 MHz, 99% bandwidth

Agilent 10:23:30 Sep 30, 2005

L

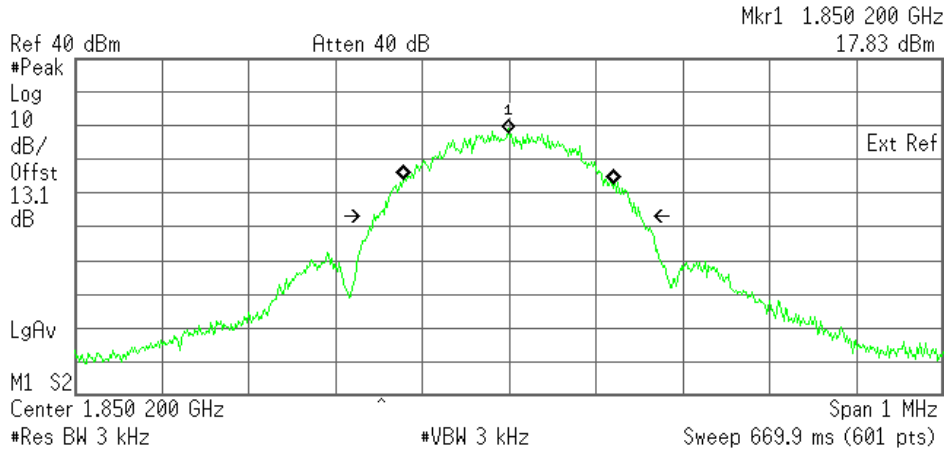

Occupied Bandwidth
245.2192 kHz

Occ BW % Pwr 99.00 %
x dB -26.00 dB

Transmit Freq Error -403.383 Hz
x dB Bandwidth 309.418 kHz

SIERRA WIRELESS, INC.

5.3.11) 8-PSK Occupied Bandwidth, PCS Middle channel, 1880.0 MHz, 99% bandwidth

Agilent 14:21:19 Sep 14, 2005

L

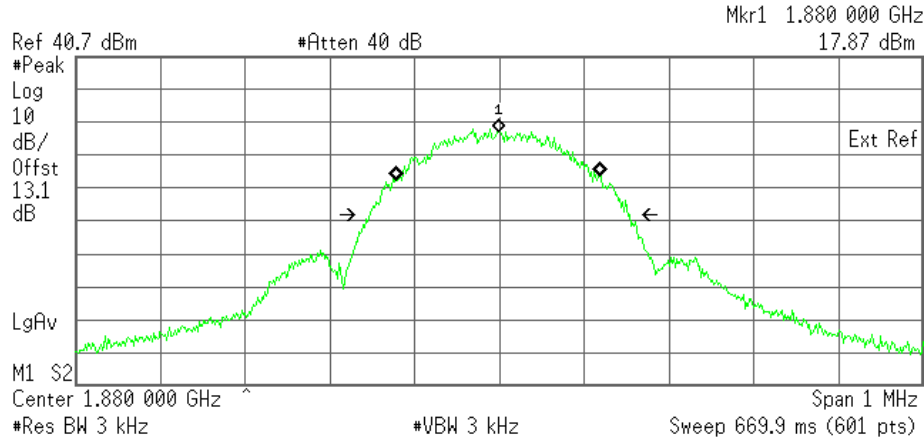

Occupied Bandwidth
243.1739 kHz

Occ BW % Pwr 99.00 %
x dB -26.00 dB

Transmit Freq Error -1.053 kHz
Occupied Bandwidth 307.480 kHz

5.3.12) 8-PSK Occupied Bandwidth, PCS High channel, 1909.8 MHz, 99% bandwidth

Agilent 10:29:41 Sep 30, 2005

L

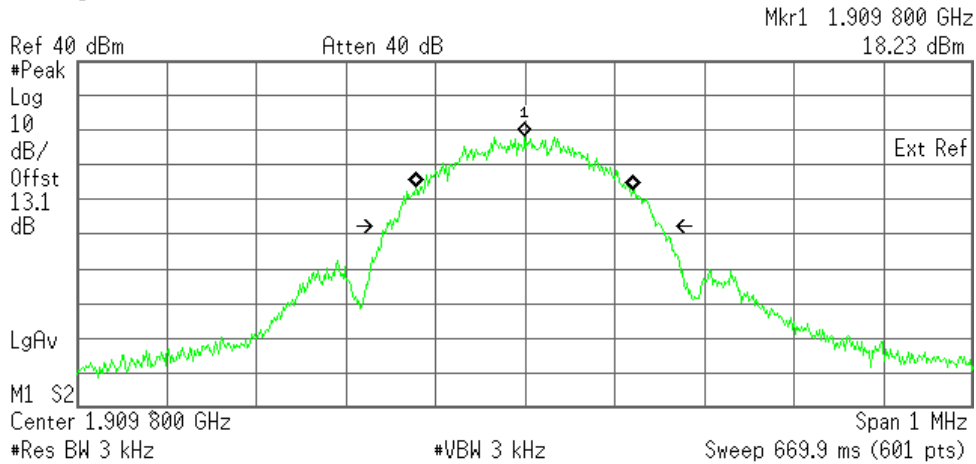

Occupied Bandwidth
245.6533 kHz

Occ BW % Pwr 99.00 %
x dB -26.00 dB

Transmit Freq Error -861.768 Hz
x dB Bandwidth 310.229 kHz

SIERRA WIRELESS, INC.

5.3.13) WCDMA Occupied Bandwidth, Cellular Low channel, 826.4 MHz, 99% bandwidth

Agilent 18:03:17 Sep 12, 2005

L

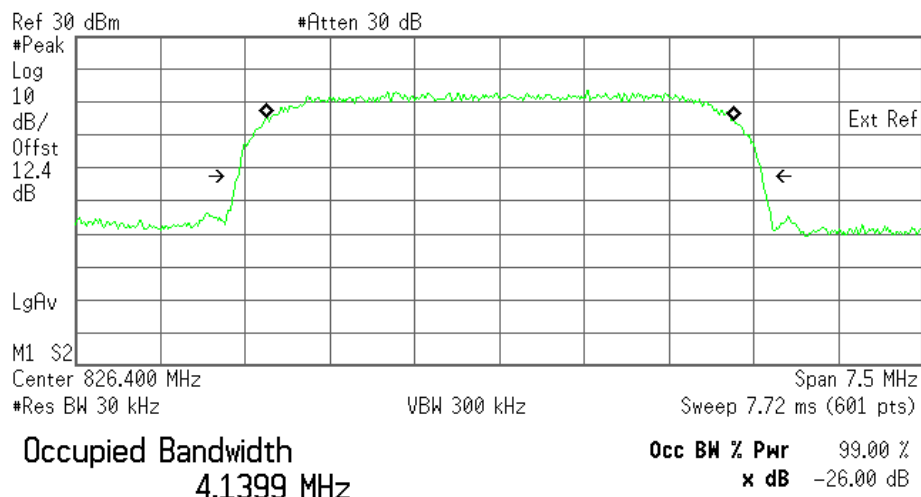

Transmit Freq Error 3.049 kHz

x dB Bandwidth 4.640 MHz

5.3.14) WCDMA Occupied Bandwidth, Cellular Middle channel, 836.4 MHz, 99% bandwidth

Agilent 18:07:33 Sep 12, 2005

L

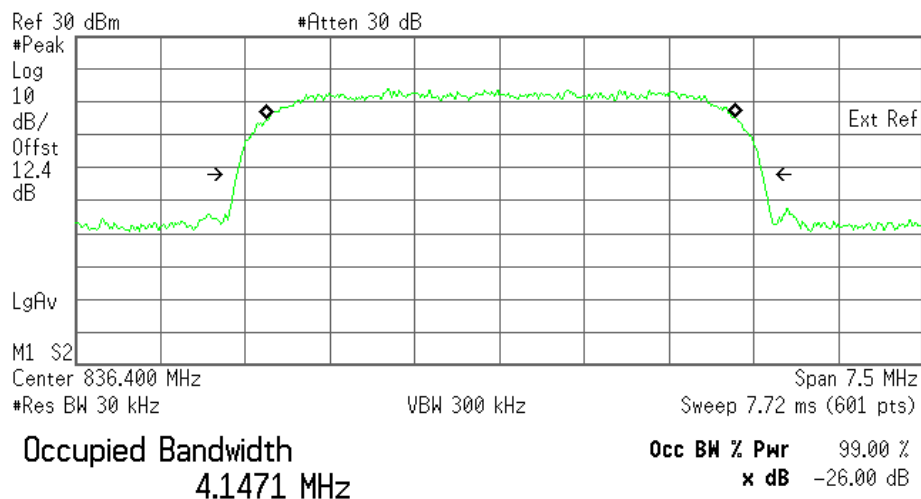

Transmit Freq Error 8.763 kHz

x dB Bandwidth 4.649 MHz

SIERRA WIRELESS, INC.

5.3.15) WCDMA Occupied Bandwidth, Cellular High channel, 846.6 MHz, 99% bandwidth

Agilent 18:08:59 Sep 12, 2005

L

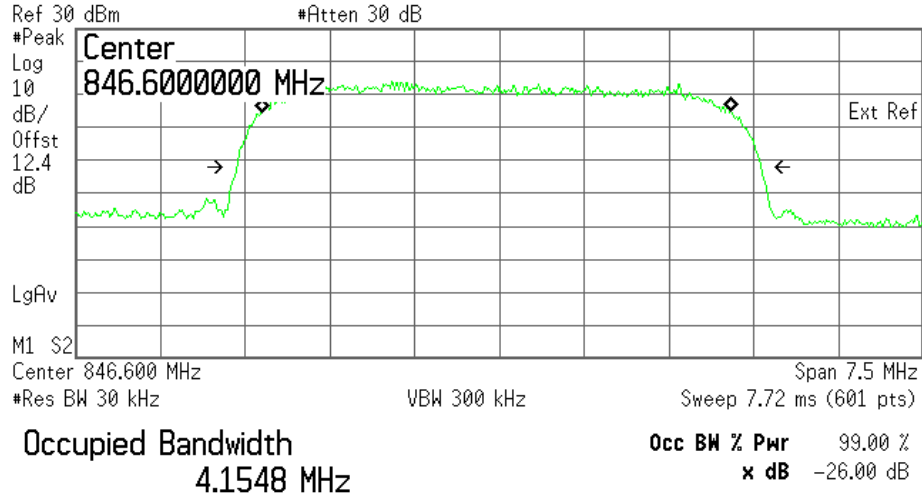

Transmit Freq Error -21.364 kHz

x dB Bandwidth 4.641 MHz

5.3.16) WCDMA Occupied Bandwidth, PCS Low channel, 1852.4 MHz, 99% bandwidth

Agilent 18:12:33 Sep 12, 2005

L

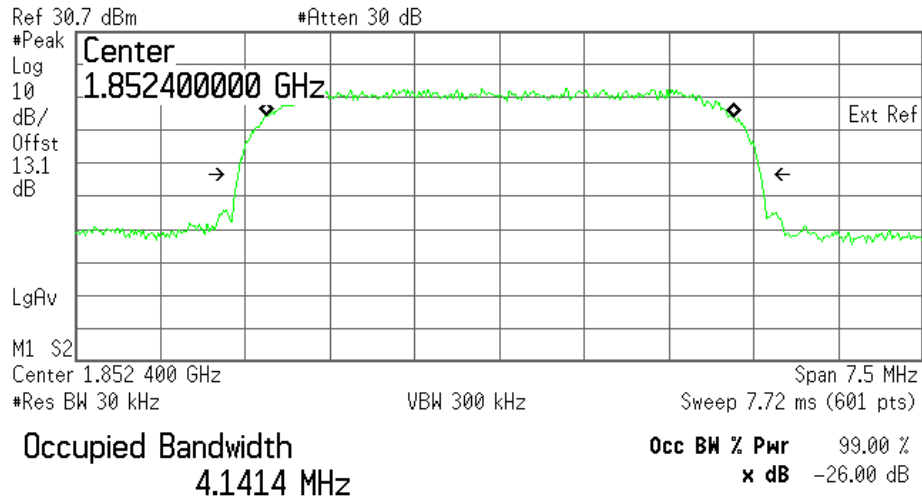

Transmit Freq Error 4.799 kHz

x dB Bandwidth 4.624 MHz

SIERRA WIRELESS, INC.

5.3.17) WCDMA Occupied Bandwidth, PCS Middle channel, 1880 MHz, 99% bandwidth

Agilent 18:13:55 Sep 12, 2005

L

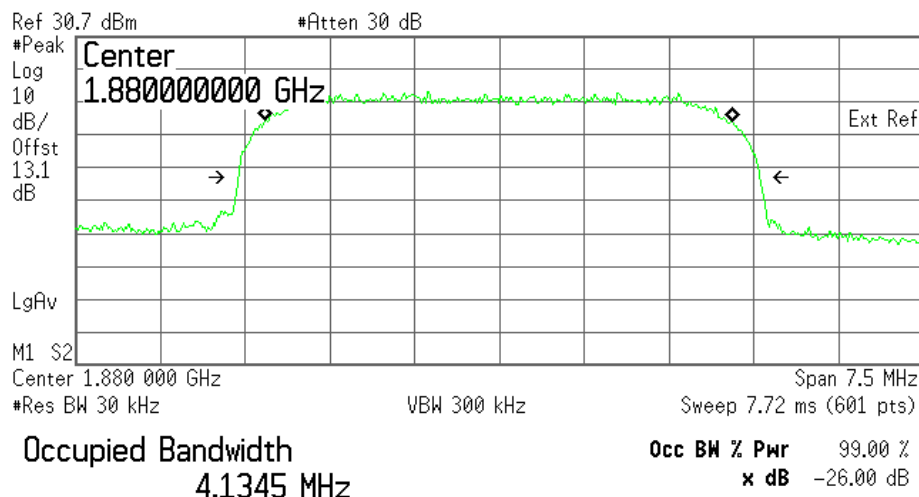

Transmit Freq Error -10.370 kHz
x dB Bandwidth 4.611 MHz

5.3.18) WCDMA Occupied Bandwidth, PCS High channel, 1907.6 MHz, 99% bandwidth

Agilent 18:18:11 Sep 12, 2005

L

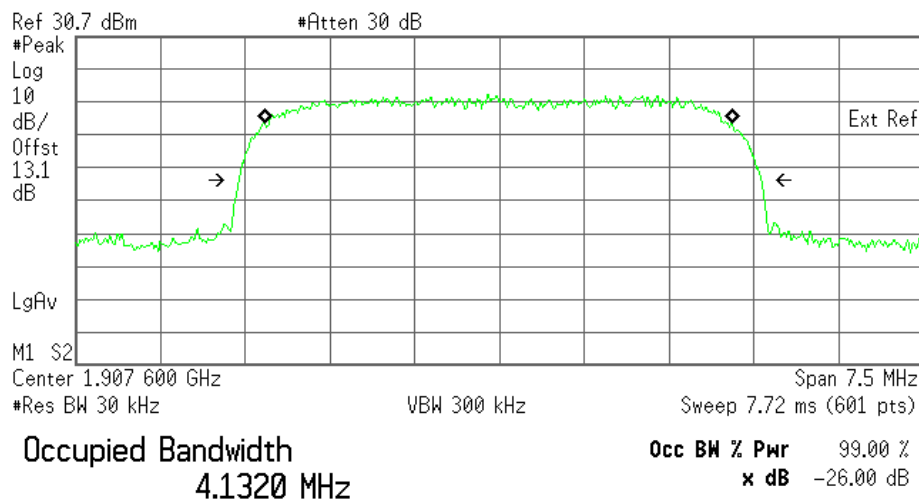

Transmit Freq Error -9.409 kHz
x dB Bandwidth 4.626 MHz

6 Out of Band Emissions at Antenna Terminals

FCC 22.901(d), 22.917, 24.238(a)

Out of Band Emissions:

The mean power of emissions must be attenuated below the mean power of the unmodulated carrier (P) on any frequency outside the frequency band by at least $(43 + 10 \log P)$ dB, in this case, -13dBm.

6.1 Test Procedure

The RF output of the transmitter was connected to a spectrum analyzer through a calibrated coaxial cable. Sufficient scans were taken to show the out-of-band Emissions, if any, up to 10th harmonic. The EUT was scanned for spurious emissions from 1MHz to 20GHz with sufficient bandwidth and video resolution. Data plots are included. The measurement cable path loss at 20GHz (including an attenuator) was 13dB (11dB at lower frequencies). The larger path loss of 13dB was used for all measurements to be conservative. Multiple sweeps were recorded in maximum hold mode using a peak detector to ensure that the worst-case emissions were caught.

Test Setup

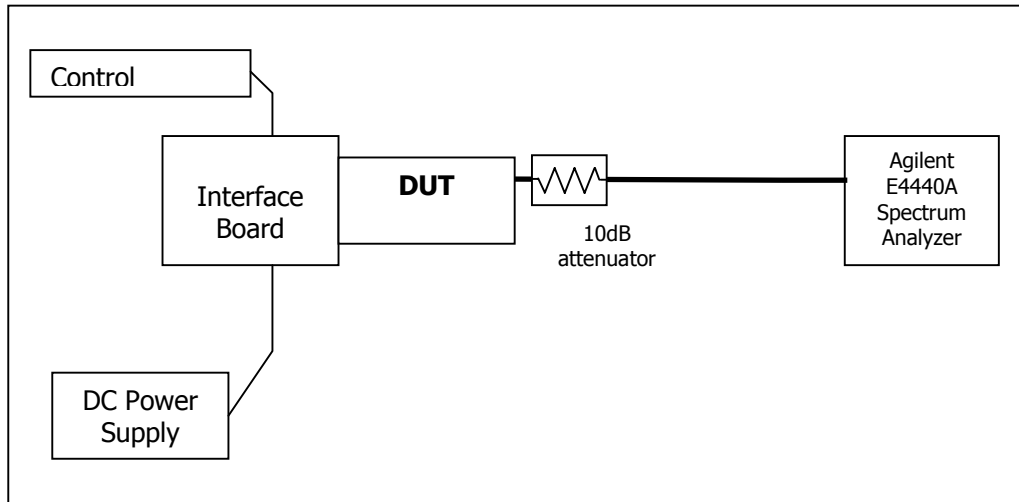

6.2 Test Equipment

EQUIPMENT	MANUFACTURER	MODEL NO.	SERIAL NO.	CAL. DATE
Control Computer	TC	Generic PC	100488	N/A
Wireless Test Set	Rohde & Schwarz	CMU200	836766/030	N/A
Spectrum Analyzer	Agilent	PSA E4440A	US41421268	Sept. 29, 2004
DC Power Supply	HP	6632A	3530A	N/A
Interface Board	Shop built	Minnow	N/A	N/A
Directional Coupler	Mini-Circuits	ZA3PD-2	N/A	N/A

SIERRA WIRELESS, INC.

6.3 Test Results

Refer to the following plots.

- **Cellular Band**

Plot Number	Description
6.4.1 – 6.4.3	GMSK Mode, Low channel, 824.20 MHz
6.4.4 – 6.4.6	GMSK Mode, Middle Channel, 837 MHz
6.4.7 – 6.4.9	GMSK Mode, High Channel, 848.8 MHz
6.4.10 – 6.4.12	8-PSK Mode, Low channel, 824.20 MHz
6.4.13 – 6.4.15	8-PSK Mode, Middle Channel, 837 MHz
6.4.16 – 6.4.18	8-PSK Mode, High Channel, 848.8 MHz

- **PCS Band**

Plot Number	Description
6.4.19 – 6.4.21	GMSK Mode, Low Channel, 1850.2 MHz
6.4.22 – 6.4.24	GMSK Mode, Middle Channel, 1880.0 MHz
6.4.25 – 6.4.27	GMSK Mode, High Channel, 1909.8 MHz
6.4.28 – 6.4.30	8-PSK, Mode, Low Channel, 1850.2 MHz
6.4.31 – 6.4.33	8-PSK Mode, Middle Channel, 1880.0 MHz
6.4.34 – 6.4.36	8-PSK Mode, High Channel, 1909.8 MHz

- **UMTS Cellular Band**

Plot Number	Description
6.4.37 – 6.4.39	WCDMA Mode, Low Channel, 826.4 MHz
6.4.40 – 6.4.42	WCDMA Mode, Middle Channel, 836.4 MHz
6.4.43 – 6.4.45	WCDMA Mode, High Channel, 846.6 MHz

- **UMTS PCS Band**

Plot Number	Description
6.4.46 – 6.4.48	WCDMA Mode, Low Channel, 1852.4 MHz
6.4.49 – 6.4.51	WCDMA Mode, Middle Channel, 1880.0 MHz
6.4.52 – 6.4.54	WCDMA Mode, High Channel, 1907.6 MHz

These plots show that the conducted emission limits requirements are met.

6.4 Test Plots

Plot 6.4.1) Out of Band Emissions at Antenna Terminals

GMSK, Low channel, 824.200 MHz, 1 MHz to 1 GHz

Agilent 18:55:48 Sep 12, 2005

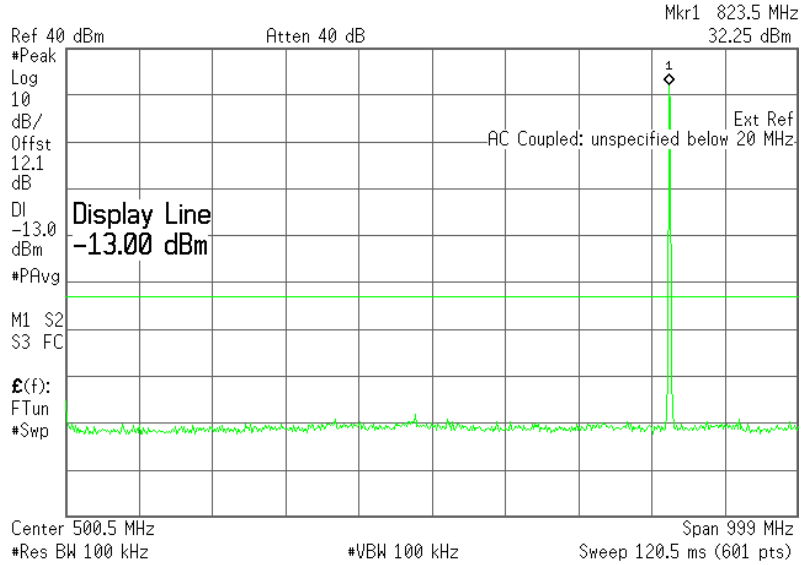

Plot 6.4.2) Out of Band Emissions at Antenna Terminals

GMSK, Low channel, 824.200 MHz, TX signal +/- 20 MHz

Agilent 20:56:09 Sep 12, 2005

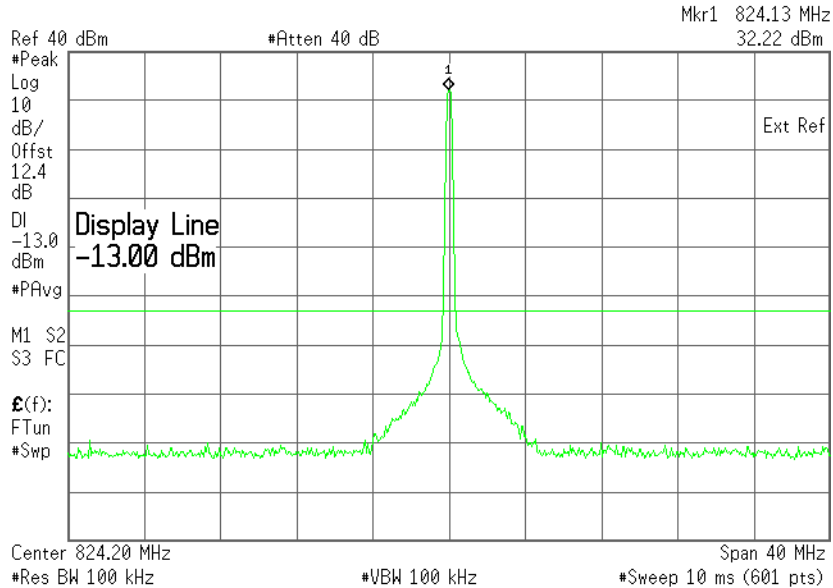

The strong emission shown in each case is the carrier signal.

SIERRA WIRELESS, INC.

Plot 6.4.3) Out of Band Emissions at Antenna Terminals

GMSK, Low channel, 824.200 MHz, 1 GHz to 20 GHz

Agilent 14:32:33 Sep 15, 2005

L

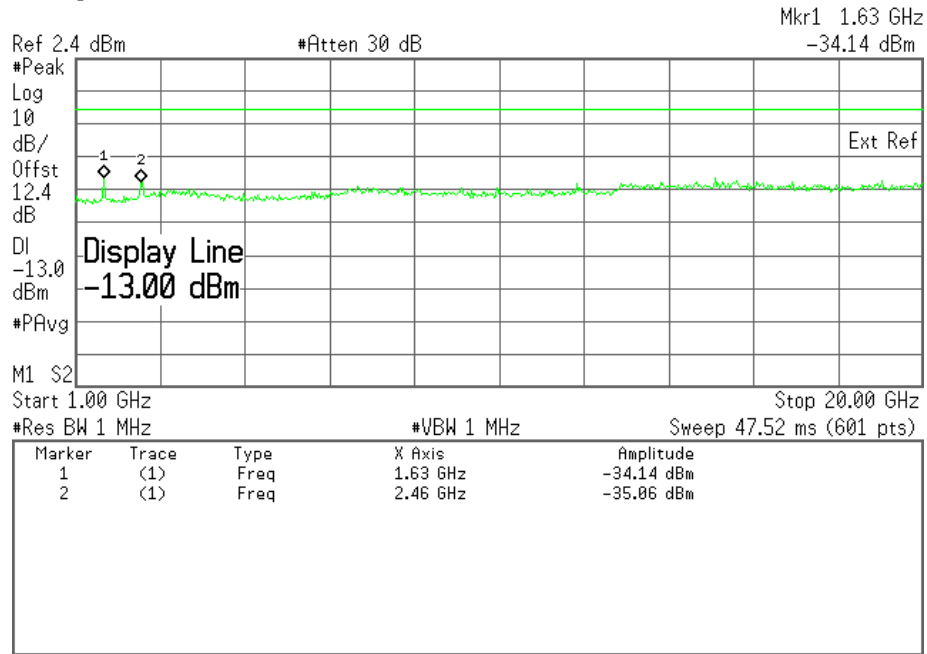

Cellular Harmonics for Ch. 128 (824.2 MHz)	Level (dBm)
Second	-34 dBm
Third	-35 dBm
All others	< -30dBm up to 20GHz

Plot 6.4.4) Out of Band Emissions at Antenna Terminals
 GMSK, Mid Channel, 837 MHz, 1 MHz to 1 GHz

Agilent 19:03:19 Sep 12, 2005

L

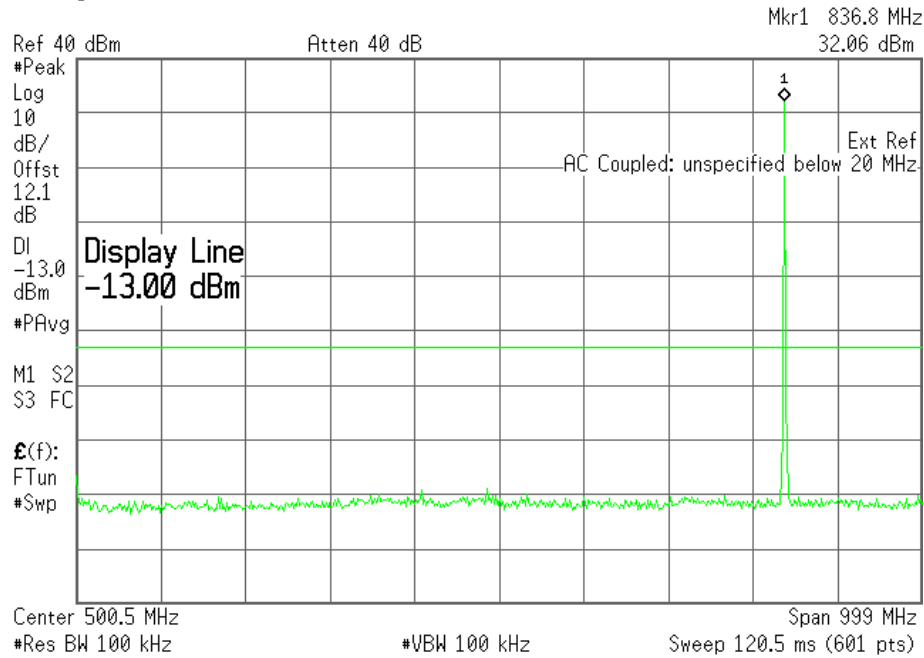

Plot 6.4.5) Out of Band Emissions at Antenna Terminals
 GMSK, Mid Channel, 837 MHz, TX signal +/- 20 MHz

Agilent 20:58:33 Sep 12, 2005

L

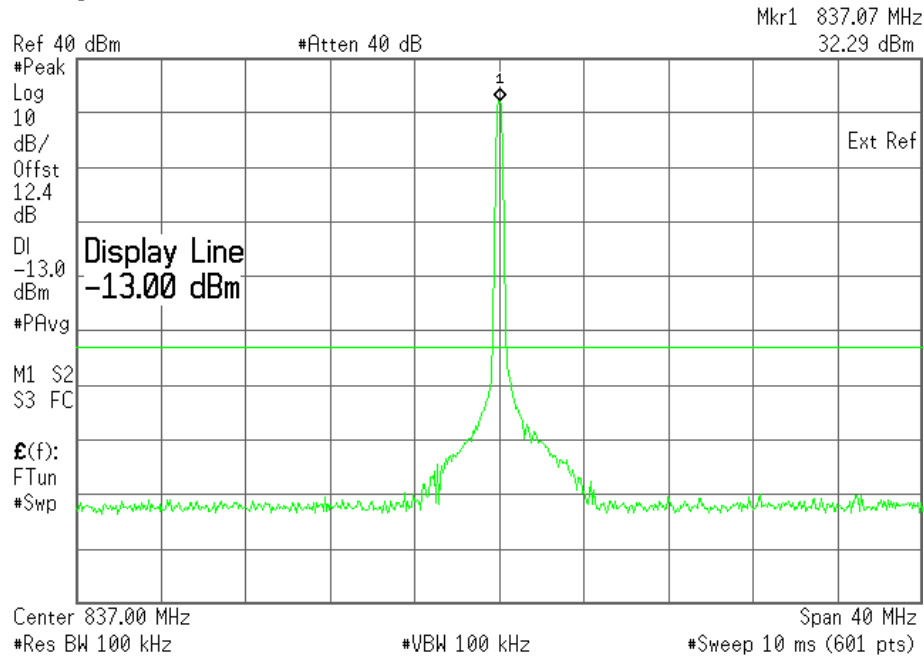

The strong emission shown in each case is the carrier signal.

SIERRA WIRELESS, INC.

Plot 6.4.6) Out of Band Emissions at Antenna Terminals

GMSK, Mid Channel, 837 MHz, 1 GHz to 20 GHz

Agilent 14:31:54 Sep 14, 2005

L

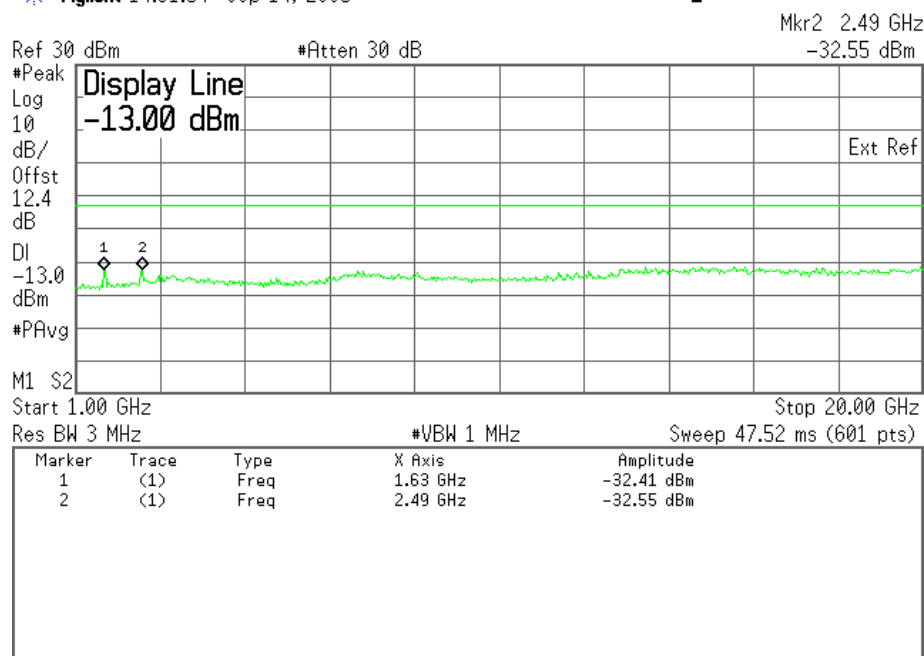

Cellular Harmonics for Ch. 190 (836.6 MHz)	Level (dBm)
Second	-32 dBm
Third	-32 dBm
All others	< -30dBm up to 20GHz

Plot 6.4.7) Out of Band Emissions at Antenna Terminals
 GMSK, High Channel, 848.8 MHz, 1 MHz to 1 GHz

Agilent 19:05:38 Sep 12, 2005

L

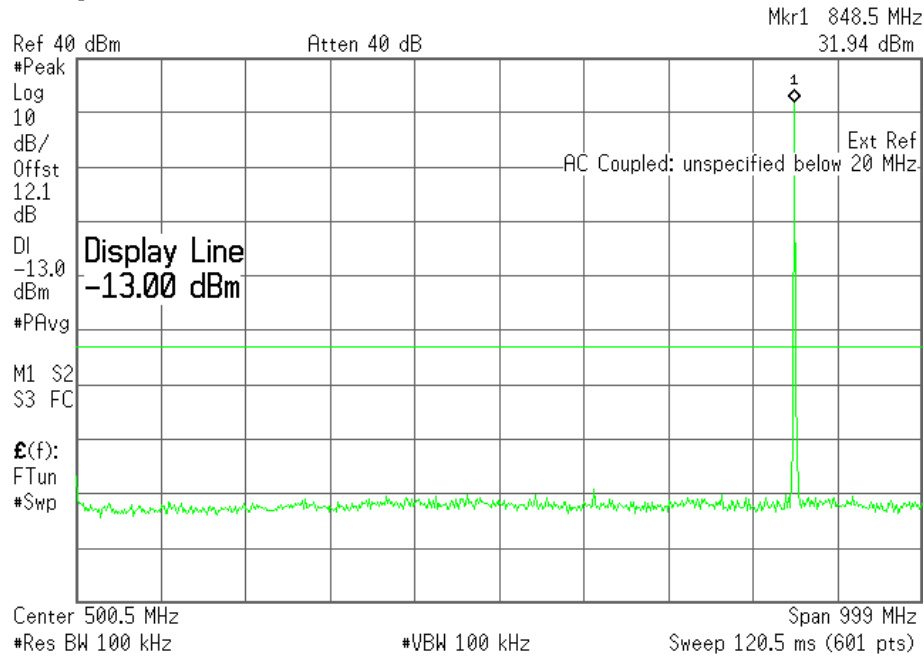

Plot 6.4.8) Out of Band Emissions at Antenna Terminals
 GMSK, High Channel, 848.8 MHz, TX signal +/- 20 MHz

Agilent 20:59:58 Sep 12, 2005

L

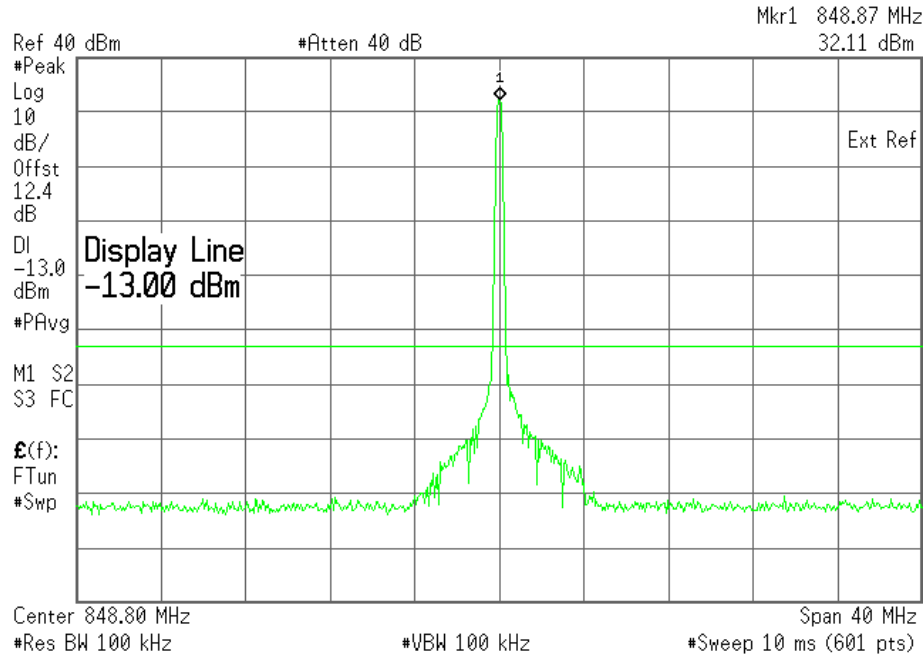

The strong emission shown in each case is the carrier signal.

SIERRA WIRELESS, INC.

Plot 6.4.9) Out of Band Emissions at Antenna Terminals

GMSK, High Channel, 848.8 MHz, 1 GHz to 20 GHz

Agilent 23:10:29 Sep 12, 2005

L

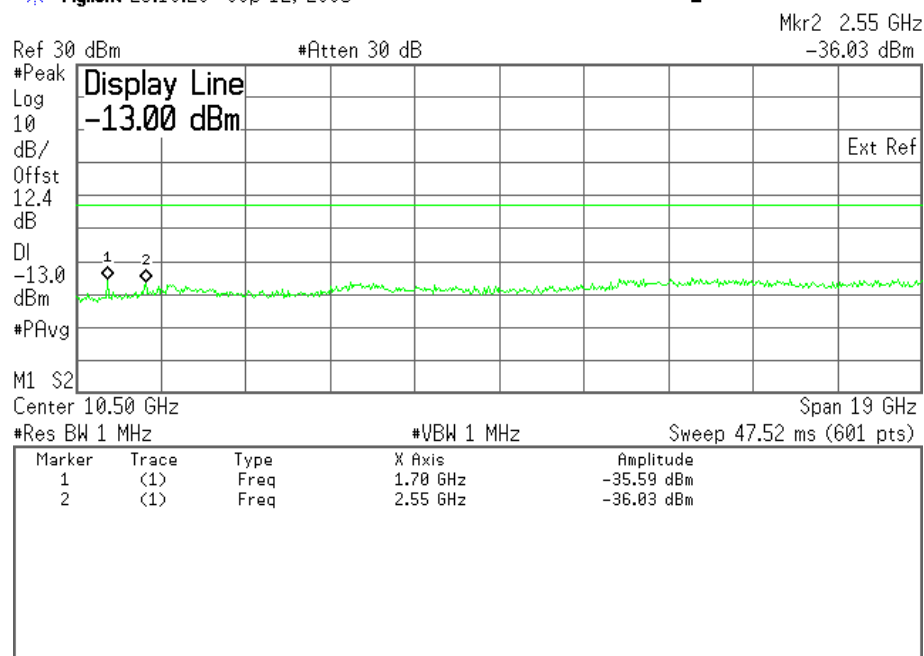

Cellular Harmonics for Ch. 251 (848.8 MHz)	Level (dBm)
Second	-35 dBm
Third	-36 dBm
All others	< -30dBm up to 20GHz

Plot 6.4.10) Out of Band Emissions at Antenna Terminals

8-PSK, Low channel, 824.200 MHz, 1 MHz to 1 GHz

Agilent 19:09:02 Sep 12, 2005

L

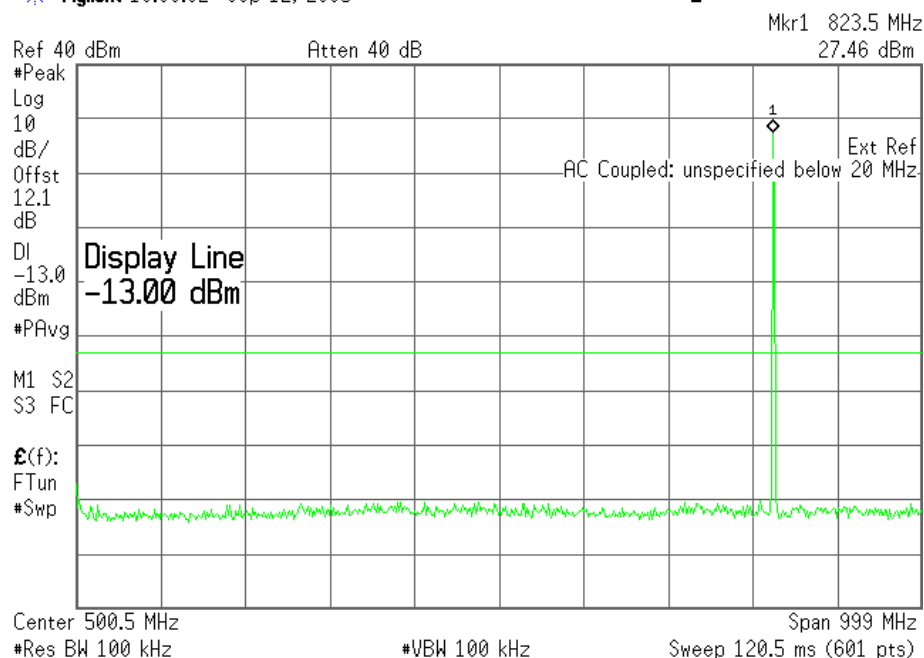

Plot 6.4.11) Out of Band Emissions at Antenna Terminals

8-PSK, Low channel, 824.200 MHz, TX signal +/- 20 MHz

Agilent 21:01:21 Sep 12, 2005

L

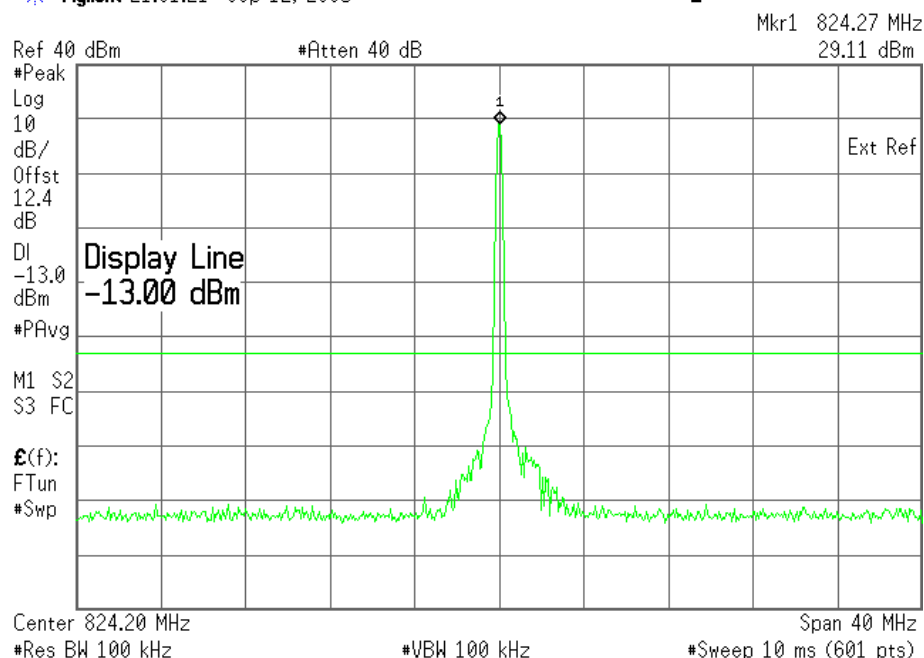

The strong emission shown in each case is the carrier signal.

SIERRA WIRELESS, INC.

Plot 6.4.12) Out of Band Emissions at Antenna Terminals

8-PSK, Low channel, 824.200 MHz, 1 GHz to 20 GHz

Agilent 23:12:59 Sep 12, 2005

L

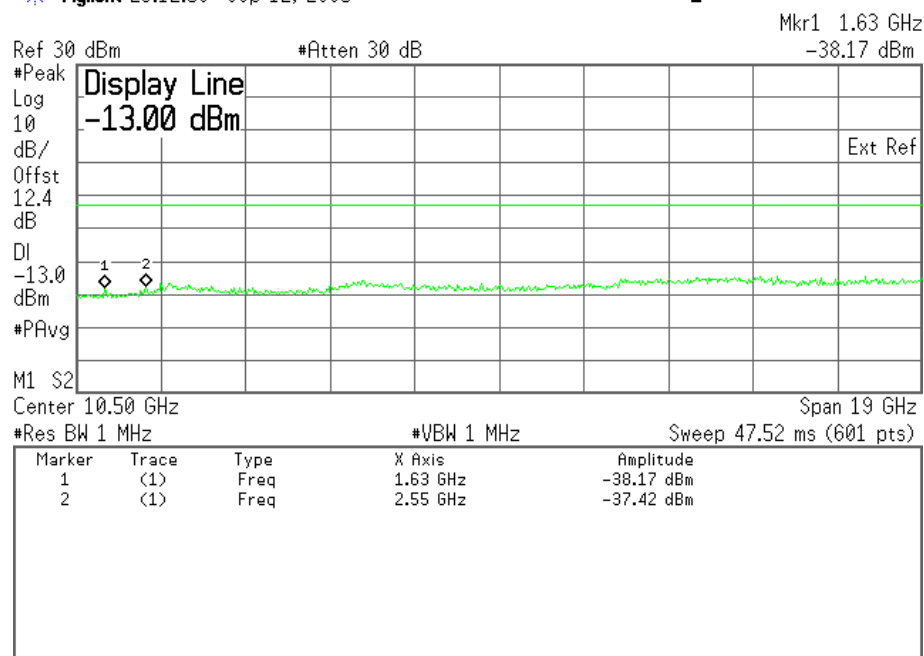

Cellular Harmonics for Ch. 128 (824.2 MHz)	Level (dBm)
Second	-38dBm
Third	-37dBm
All others	< -30dBm up to 20GHz

Plot 6.4.13) Out of Band Emissions at Antenna Terminals

8-PSK, Mid Channel, 837 MHz, 1 MHz to 1 GHz

Agilent 19:10:10 Sep 12, 2005 L

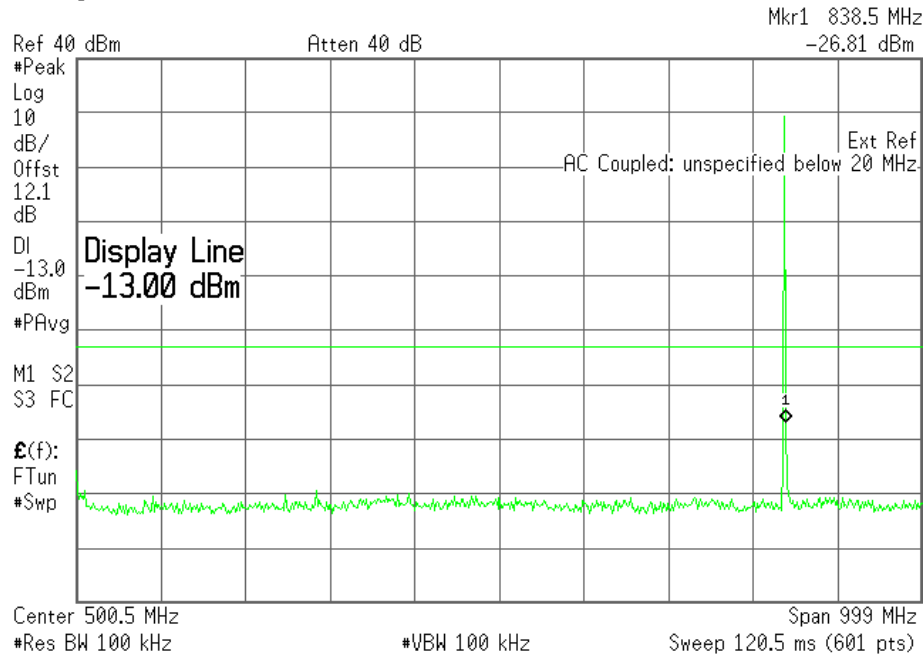

Plot 6.4.14) Out of Band Emissions at Antenna Terminals

8-PSK, Mid Channel, 837 MHz, TX signal +/- 20 MHz

Agilent 21:02:56 Sep 12, 2005 L

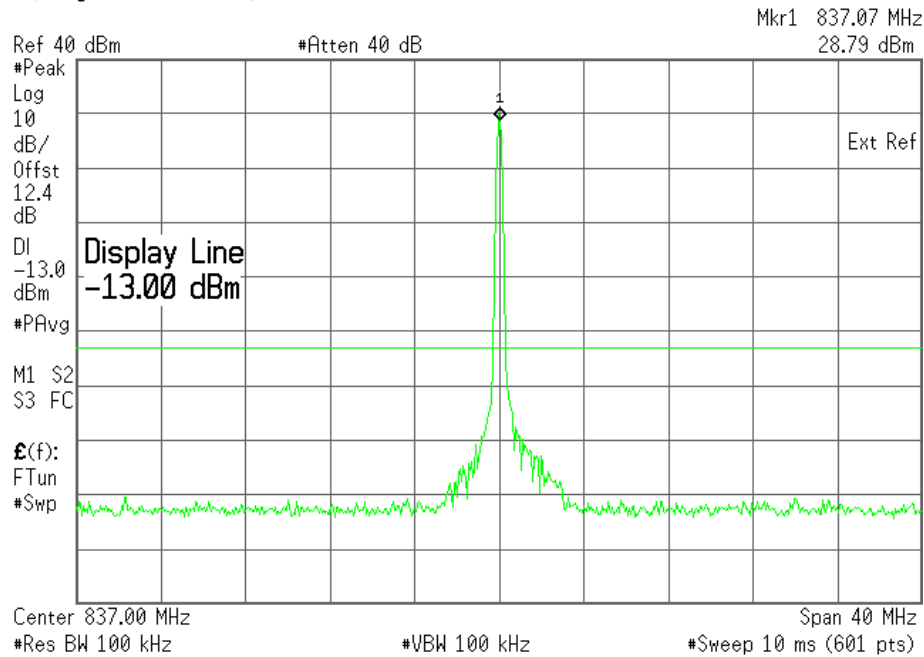

The strong emission shown in each case is the carrier signal.

SIERRA WIRELESS, INC.

Plot 6.4.15) Out of Band Emissions at Antenna Terminals

8-PSK, Mid Channel, 836.6 MHz, 1 GHz to 20 GHz

Agilent 23:14:12 Sep 12, 2005

L

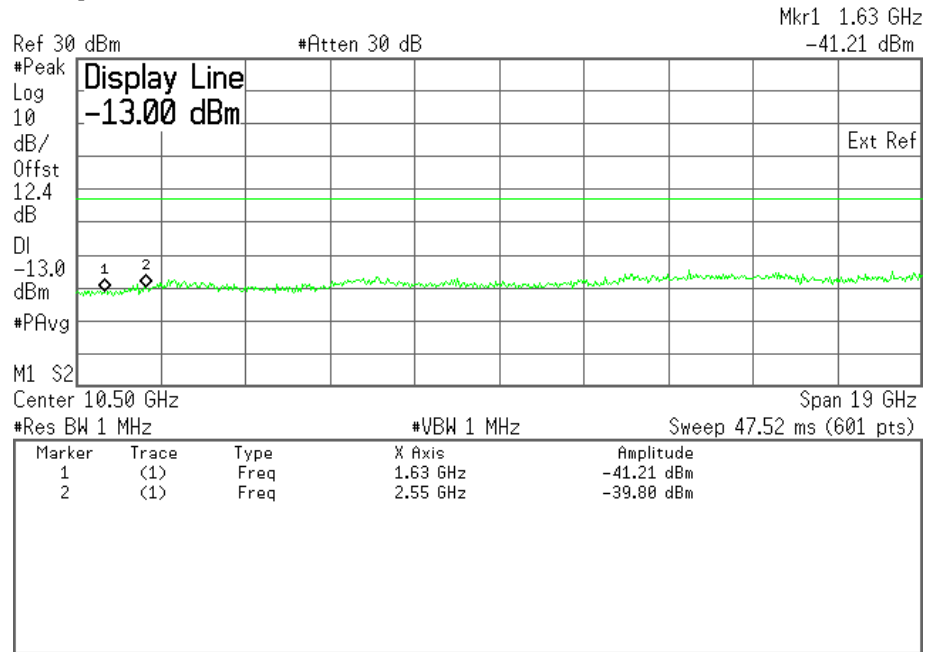

Cellular Harmonics for Ch. 190 (836.6 MHz)	Level (dBm)
Second	--
Third	--
All others	< -30dBm up to 20GHz

Plot 6.4.16) Out of Band Emissions at Antenna Terminals

8-PSK, High Channel, 848.8 MHz, 1 MHz to 1 GHz

Agilent 19:10:57 Sep 12, 2005

L

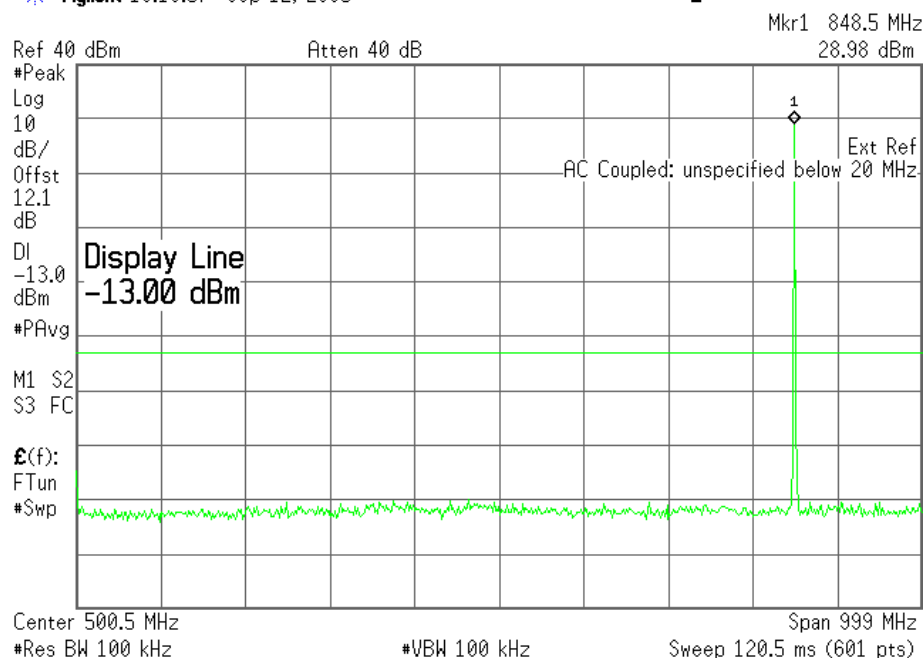

Plot 6.4.17) Out of Band Emissions at Antenna Terminals

8-PSK, High Channel, 848.8 MHz, TX signal +/- 20 MHz

Agilent 21:03:54 Sep 12, 2005

L

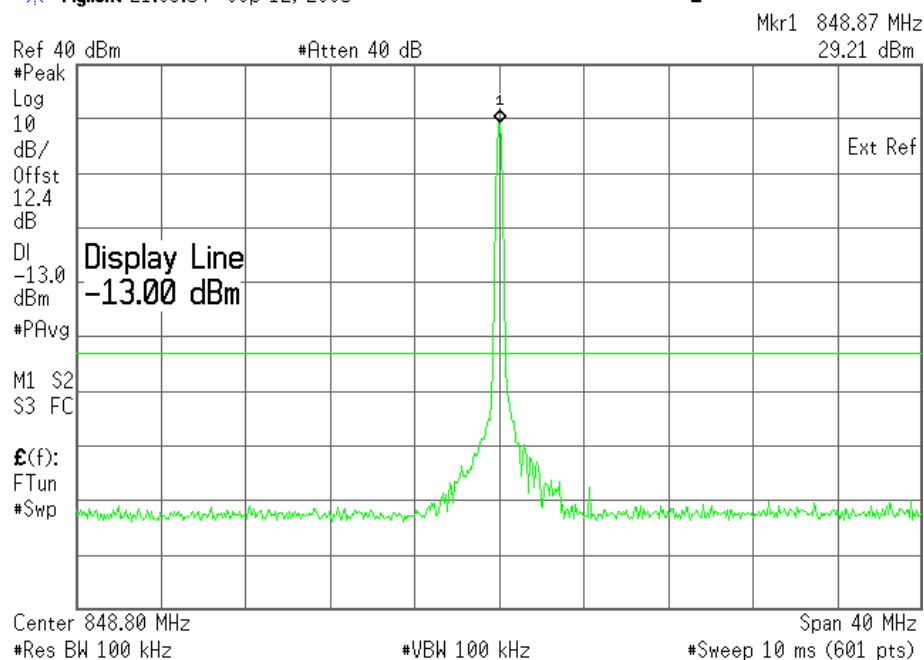

The strong emission shown in each case is the carrier signal.

SIERRA WIRELESS, INC.

Plot 6.4.18) Out of Band Emissions at Antenna Terminals
 8-PSK, High Channel, 848.8 MHz, 1 GHz to 20 GHz

Agilent 23:14:46 Sep 12, 2005

L

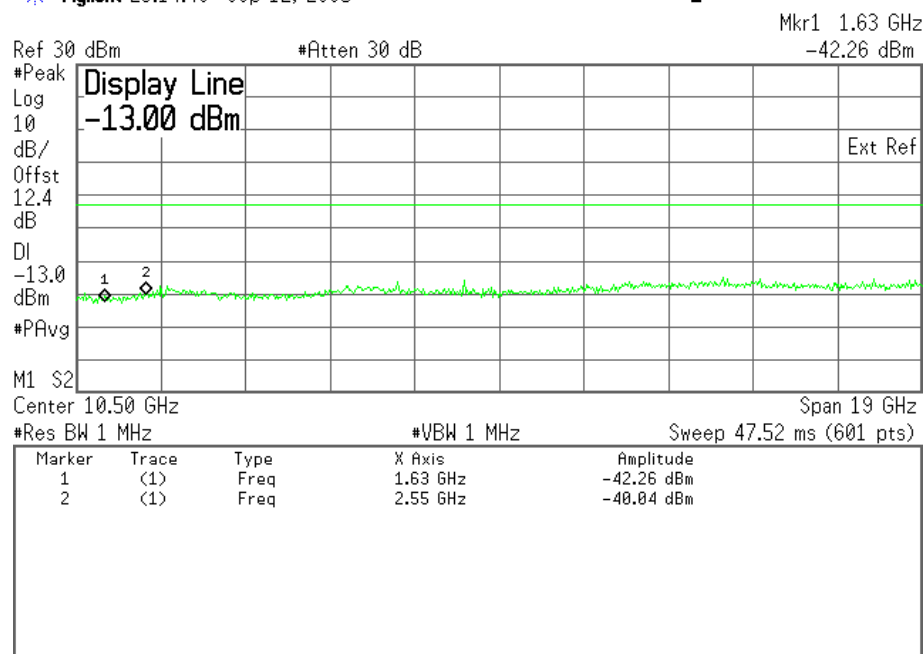

Cellular Harmonics for Ch. 251 (848.8 MHz)	Level (dBm)
Second	--
Third	--
All others	< -30dBm up to 20GHz

Plot 6.4.19) Out of Band Emissions at Antenna Terminals

GMSK, Low channel, 1850.2 MHz, 1 MHz to 1 GHz

Agilent 13:21:52 Sep 30, 2005

L

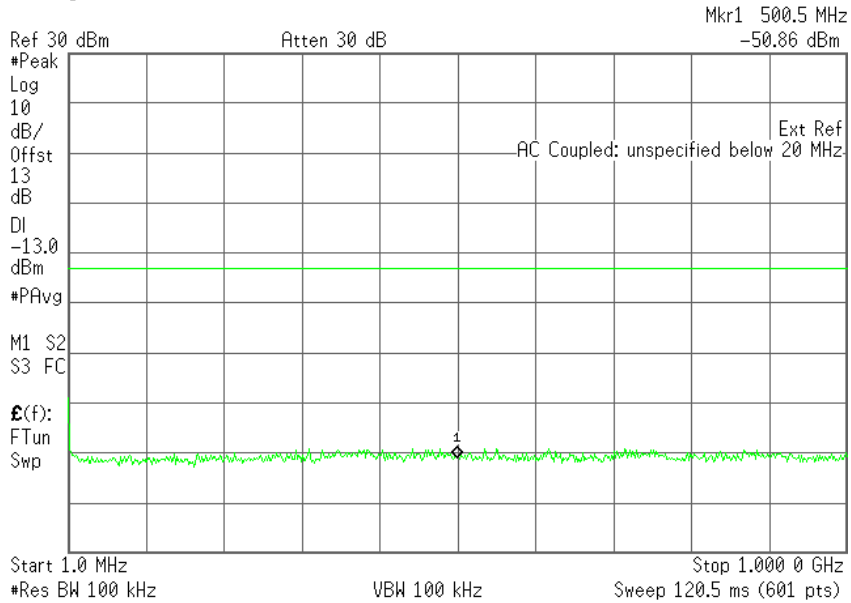

Plot 6.4.20) Out of Band Emissions at Antenna Terminals

GMSK, Low channel, 1850.2 MHz, TX signal +/- 20 MHz

Agilent 13:23:13 Sep 30, 2005

L

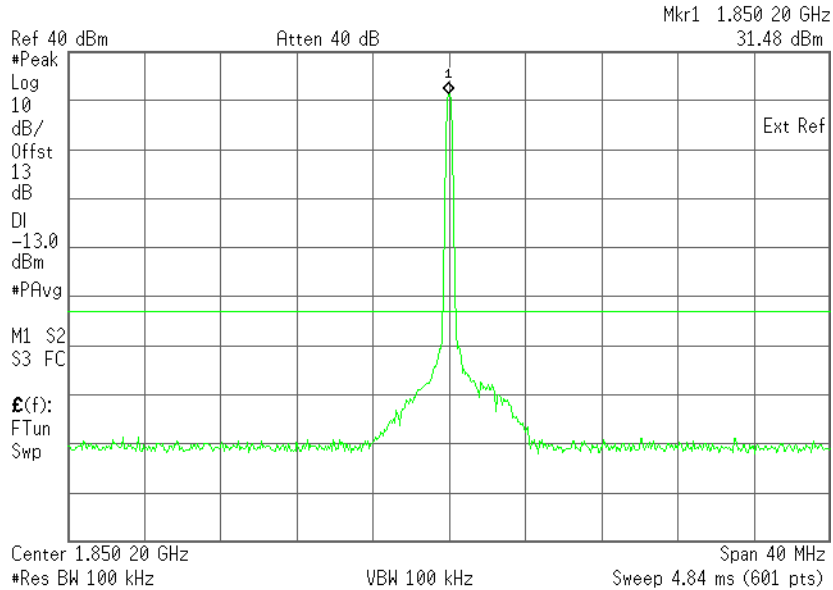

Plot 6.4.21) Out of Band Emissions at Antenna Terminals

GMSK, Low channel, 1850.2 MHz, 1 GHz to 20 GHz

Agilent 13:25:43 Sep 30, 2005

L

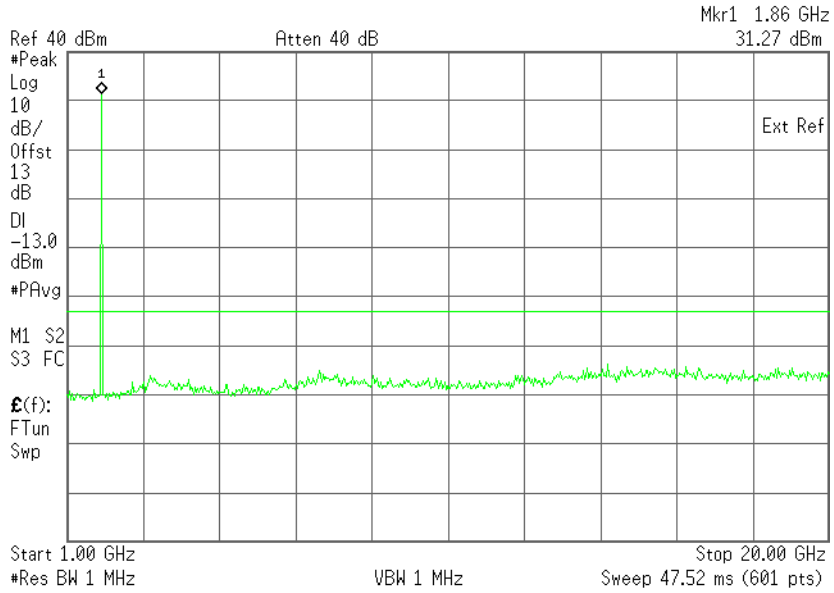

The strong emission shown is the carrier signal.

Plot 6.4.22) Out of Band Emissions at Antenna Terminals

GMSK, Middle channel, 1880.0 MHz, 1 MHz to 1 GHz

Agilent 19:53:42 Sep 12, 2005

L

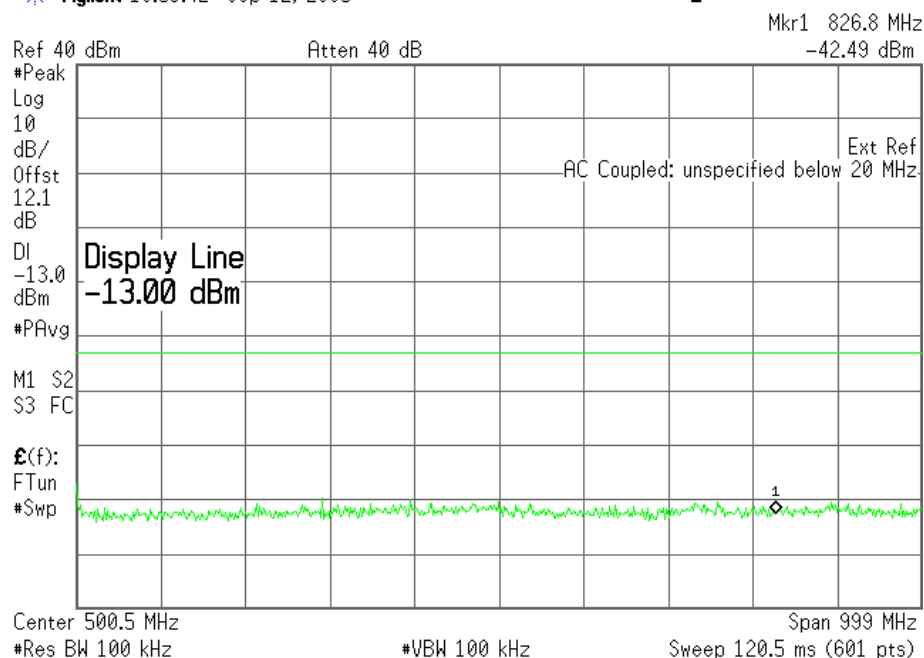

Plot 6.4.23) Out of Band Emissions at Antenna Terminals

GMSK, Middle channel, 1880.0 MHz, TX signal +/- 20 MHz

Agilent 21:41:27 Sep 12, 2005

L

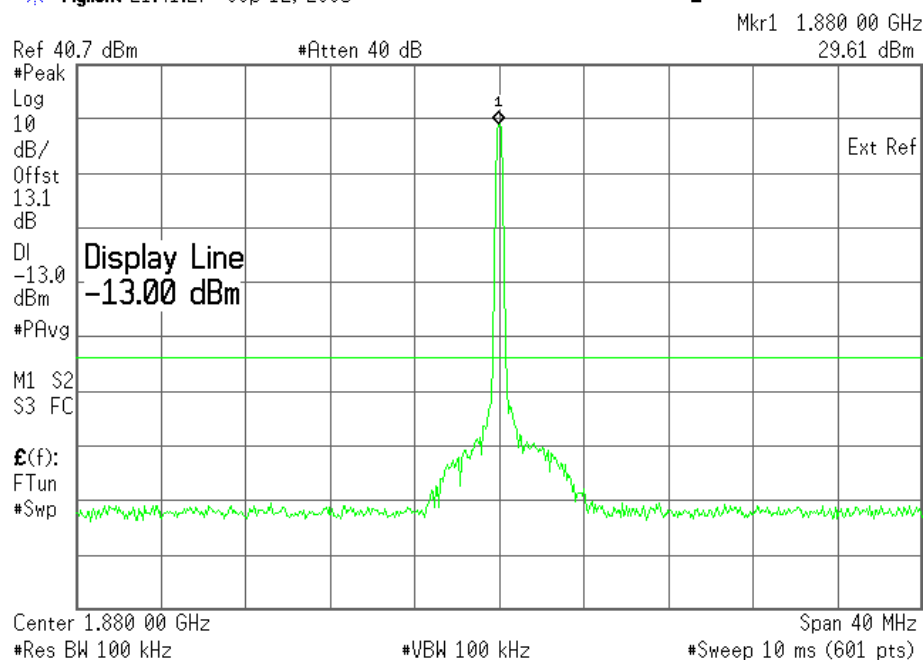

Plot 6.4.24) Out of Band Emissions at Antenna Terminals

GMSK, Middle channel, 1880.0 MHz, 1 GHz to 20 GHz

Agilent 23:17:20 Sep 12, 2005

L

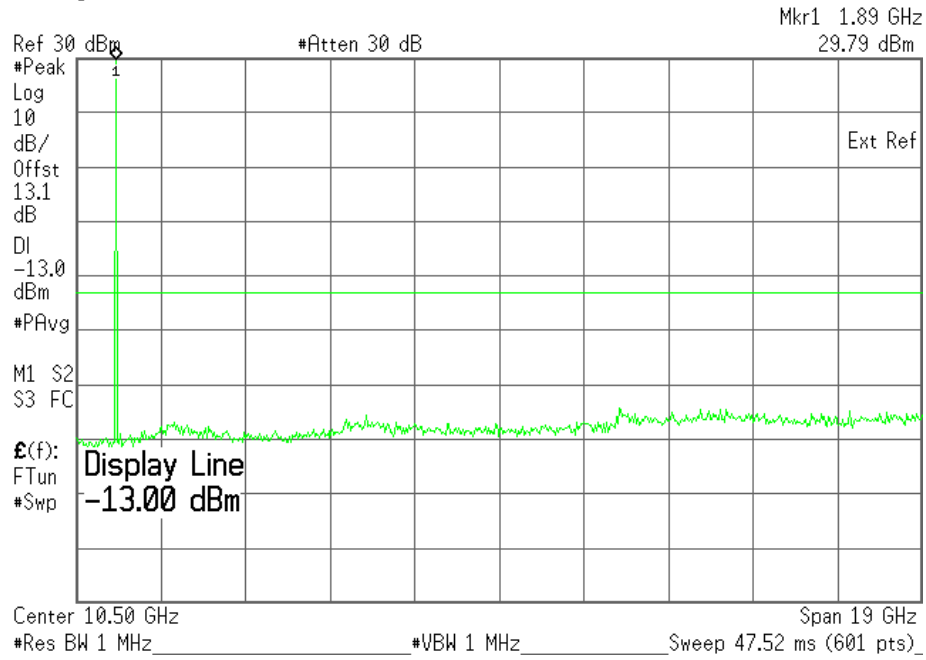

The strong emission shown is the carrier signal.

Plot 6.4.25) Out of Band Emissions at Antenna Terminals

GMSK, High channel, 1909.8 MHz, 1 MHz to 1 GHz

Agilent 13:30:59 Sep 30, 2005

L

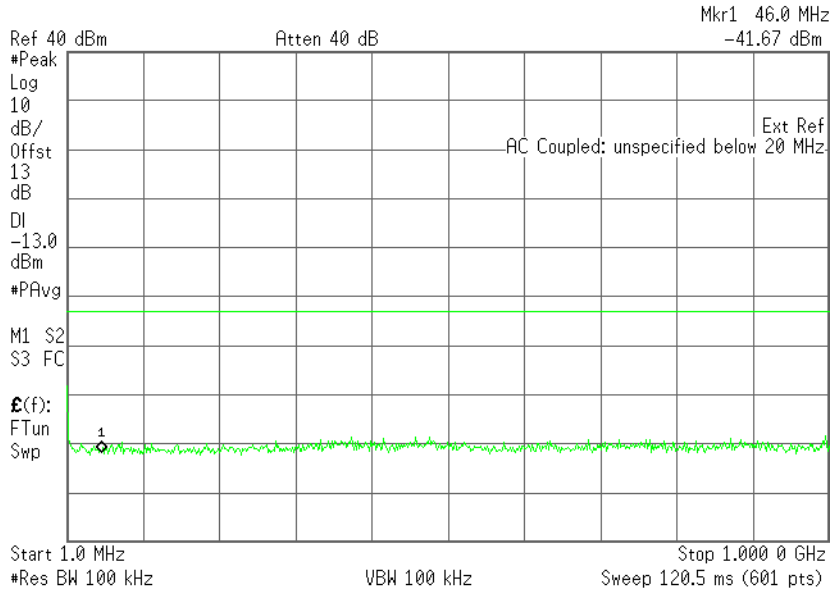

Plot 6.4.26) Out of Band Emissions at Antenna Terminals

GMSK, High channel, 1909.8 MHz, TX signal +/- 20 MHz

Agilent 13:32:49 Sep 30, 2005

L

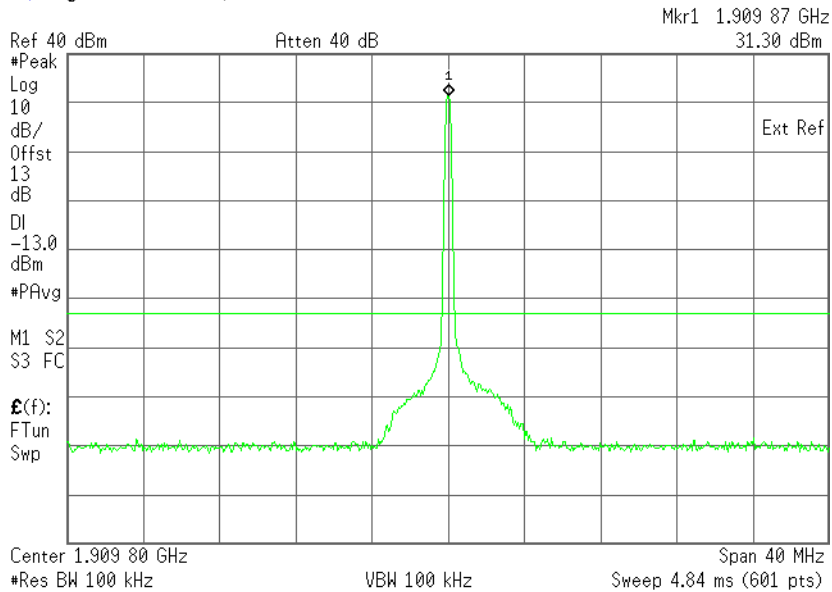

Plot 6.4.27) Out of Band Emissions at Antenna Terminals

GMSK, High channel, 1909.8 MHz, 1 GHz to 20 GHz

Agilent 13:34:19 Sep 30, 2005

L

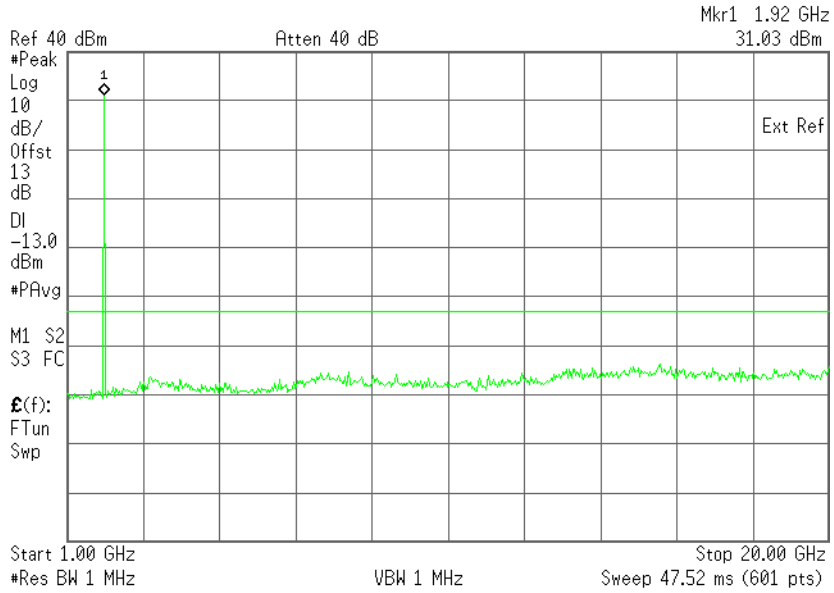

The strong emission shown is the carrier signal.

Plot 6.4.28) Out of Band Emissions at Antenna Terminals

8-PSK, Low channel, 1850.2 MHz, 1 MHz to 1 GHz

Agilent 13:37:39 Sep 30, 2005

L

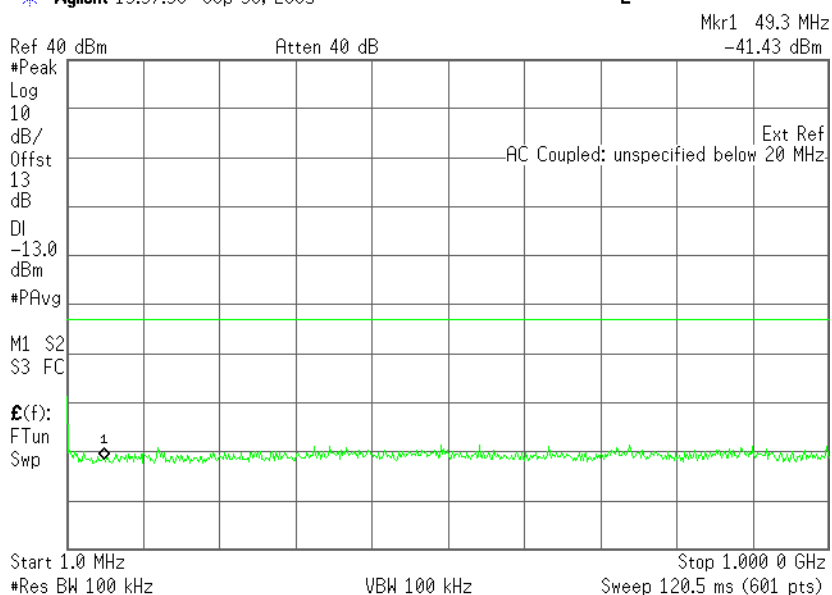

Plot 6.4.29) Out of Band Emissions at Antenna Terminals

8-PSK, Low channel, 1850.2 MHz, TX signal +/- 20 MHz

Agilent 13:42:22 Sep 30, 2005

L

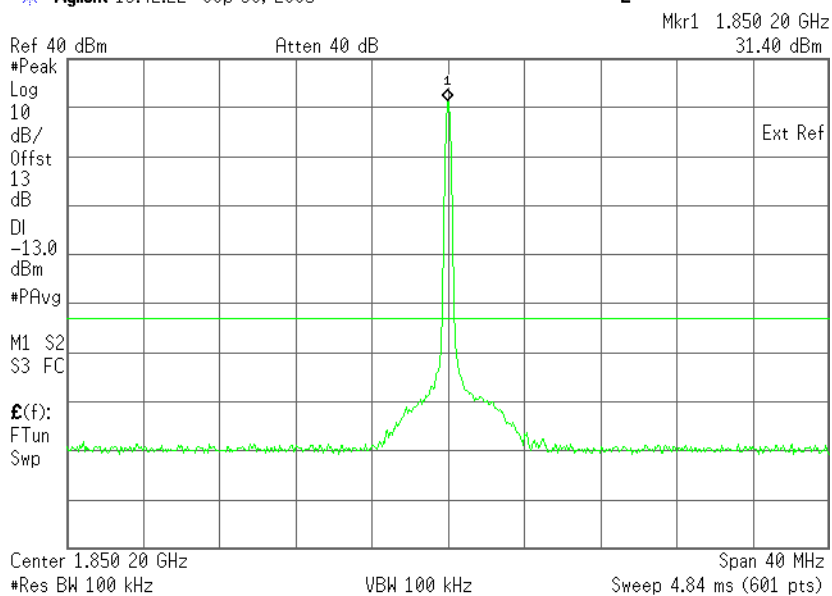

Plot 6.4.30) Out of Band Emissions at Antenna Terminals

8-PSK, Low channel, 1850.2 MHz, 1 GHz to 20 GHz

Agilent 13:43:29 Sep 30, 2005

L

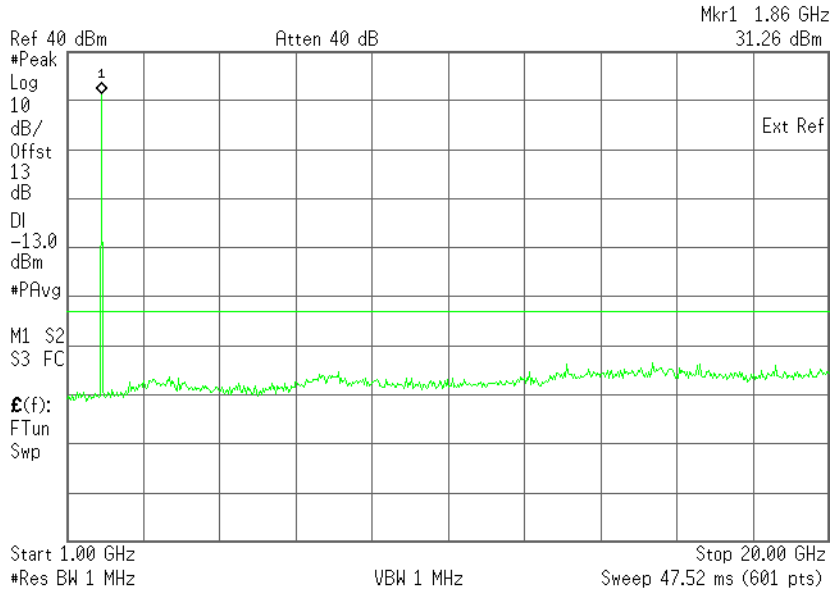

The strong emission shown is the carrier signal.

Plot 6.4.31) Out of Band Emissions at Antenna Terminals

8-PSK, Middle channel, 1880.0 MHz, 1 MHz to 1 GHz

Agilent 19:56:51 Sep 12, 2005

L

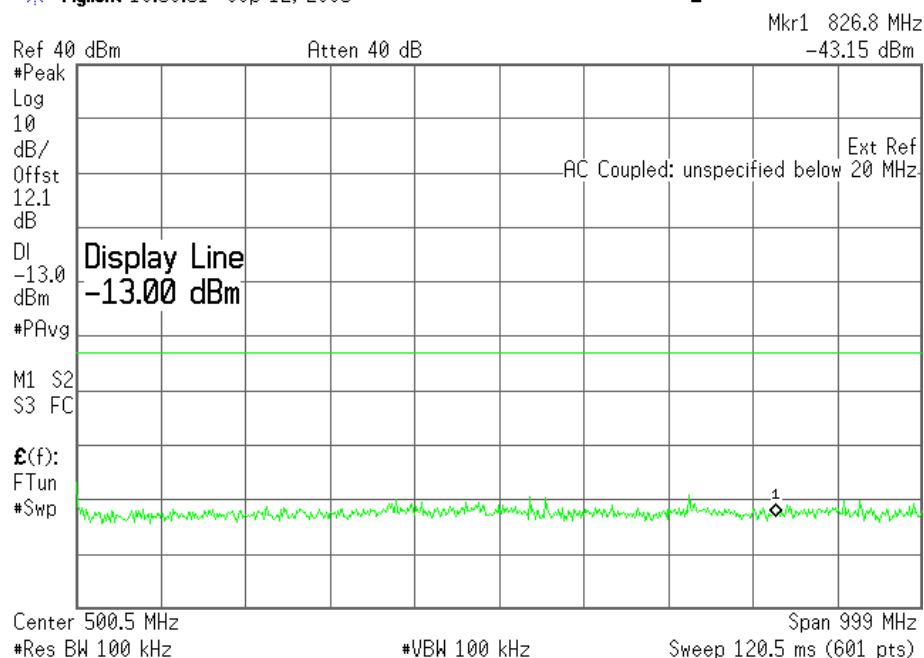

Plot 6.4.32) Out of Band Emissions at Antenna Terminals

8-PSK, Middle channel, 1880.0 MHz, TX signal +/- 20 MHz

Agilent 21:44:56 Sep 12, 2005

L

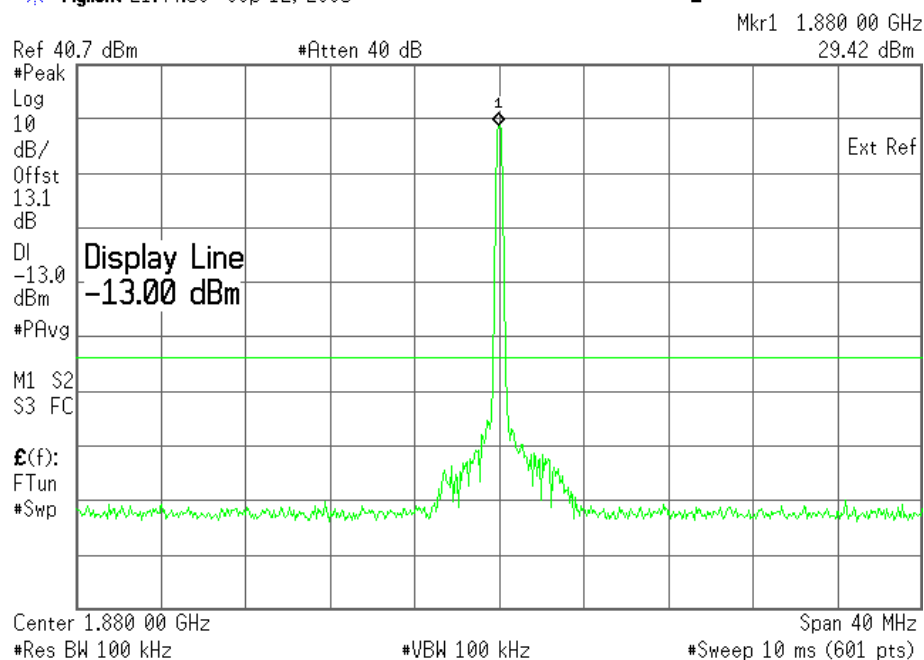

Plot 6.4.33) Out of Band Emissions at Antenna Terminals

8-PSK, Middle channel, 1880.0 MHz, 1 GHz to 20 GHz

Agilent 23:20:16 Sep 12, 2005

L

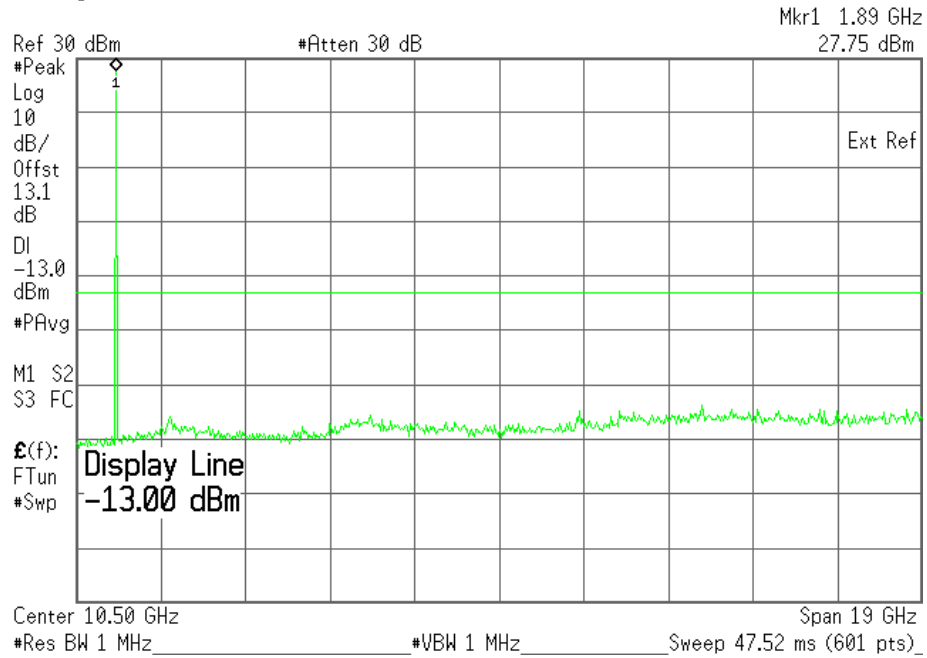

The strong emission shown is the carrier signal.

Plot 6.4.34) Out of Band Emissions at Antenna Terminals

8-PSK, High channel, 1909.8 MHz, 1 MHz to 1 GHz

Agilent 13:48:28 Sep 30, 2005

L

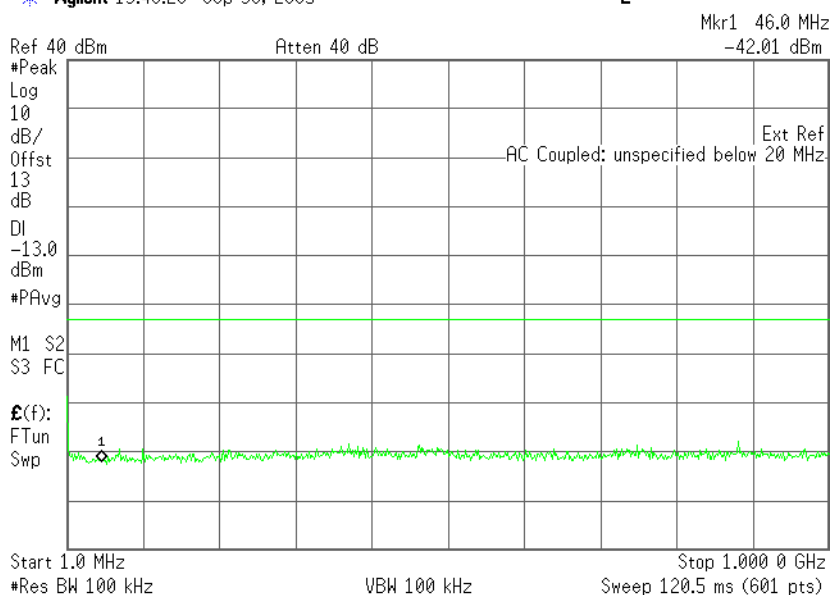

Plot 6.4.35) Out of Band Emissions at Antenna Terminals

8-PSK, High channel, 1909.8 MHz, TX signal +/- 20 MHz

Agilent 13:49:42 Sep 30, 2005

L

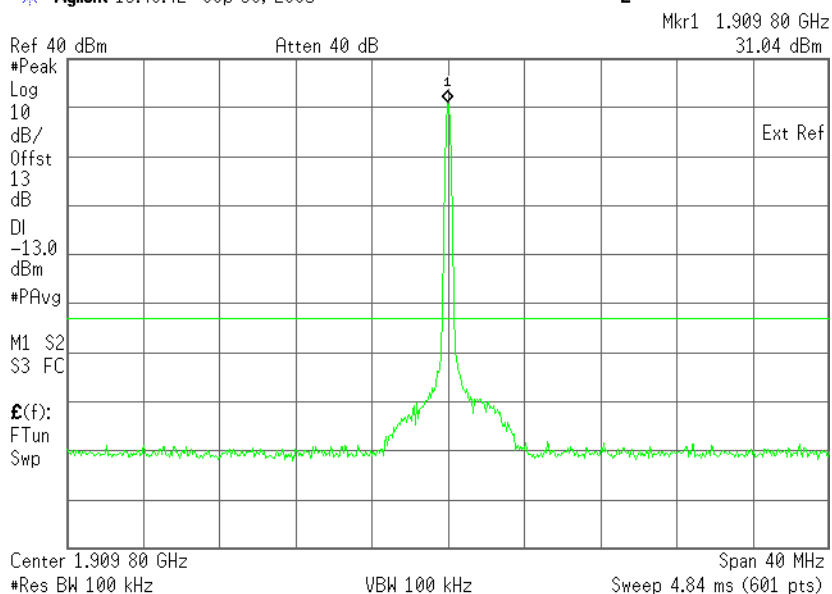

Plot 6.4.36) Out of Band Emissions at Antenna Terminals

8-PSK, High channel, 1909.8 MHz, 1 GHz to 20 GHz

Agilent 13:50:39 Sep 30, 2005

L

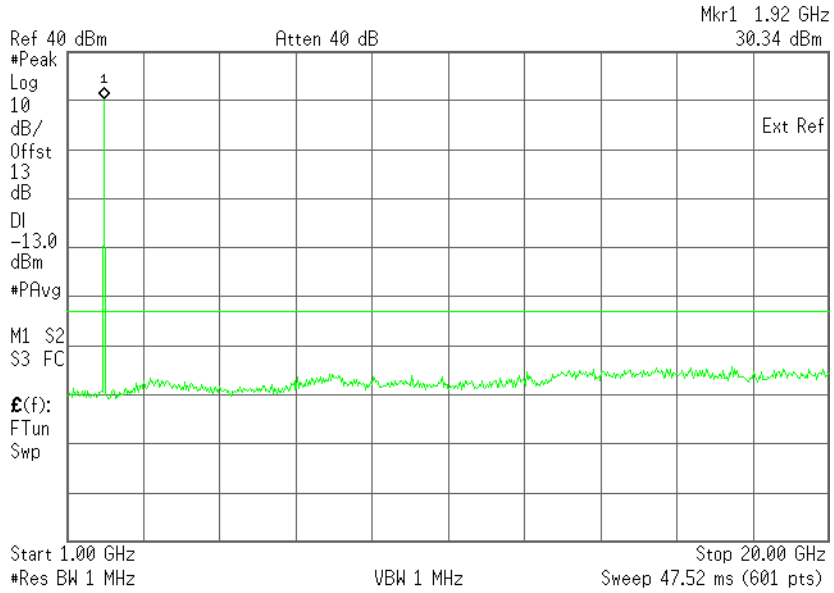

The strong emission shown is the carrier signal.

SIERRA WIRELESS, INC.

Plot 6.4.37) Out of Band Emissions at Antenna Terminals

WCDMA, Low channel, 826.4 MHz, 1 MHz to 1 GHz

Agilent 20:26:16 Sep 12, 2005

L

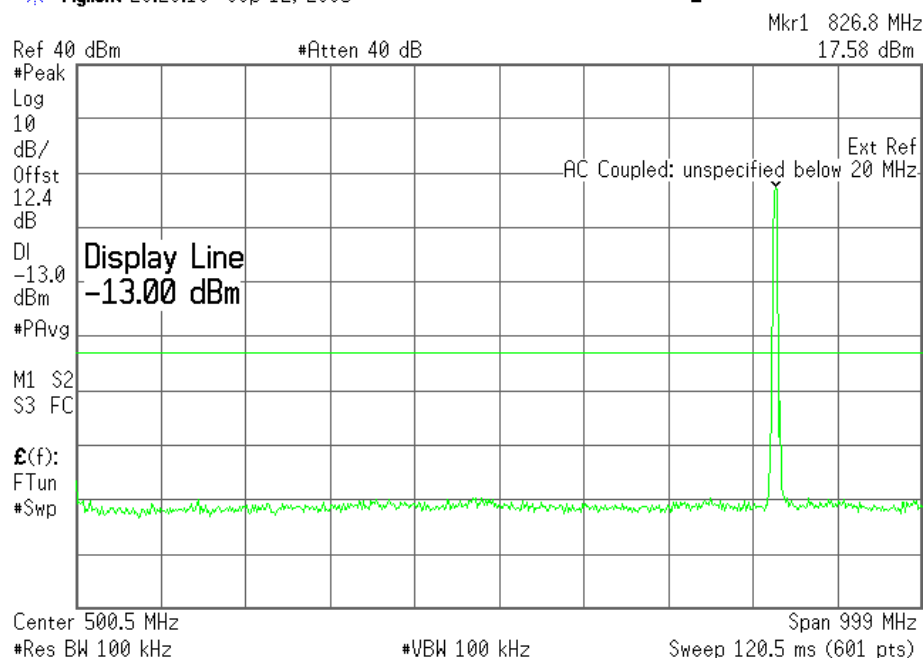

Plot 6.4.38) Out of Band Emissions at Antenna Terminals

WCDMA, Low channel, 826.4 MHz, TX signal +/- 20 MHz

Agilent 21:21:13 Sep 12, 2005

L

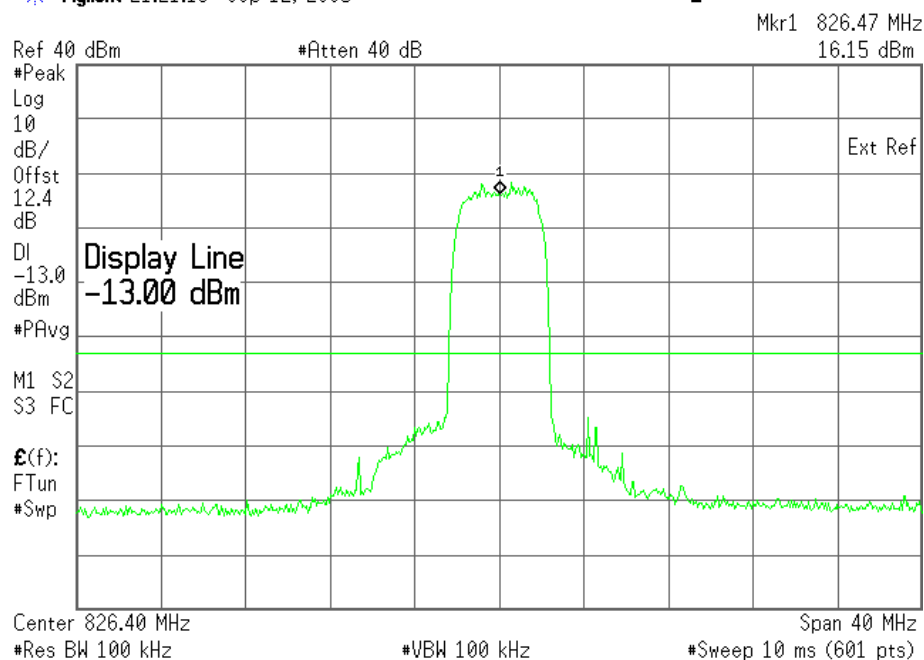

The strong emission shown in each case is the carrier signal.

© 2005 Sierra Wireless, Inc.

The contents of this page are subject to the confidentiality information on page one.

SIERRA WIRELESS, INC.

Plot 6.4.39) Out of Band Emissions at Antenna Terminals

WCDMA, Low channel, 826.4 MHz, 1 GHz to 20 GHz

Agilent 23:49:28 Sep 12, 2005

L

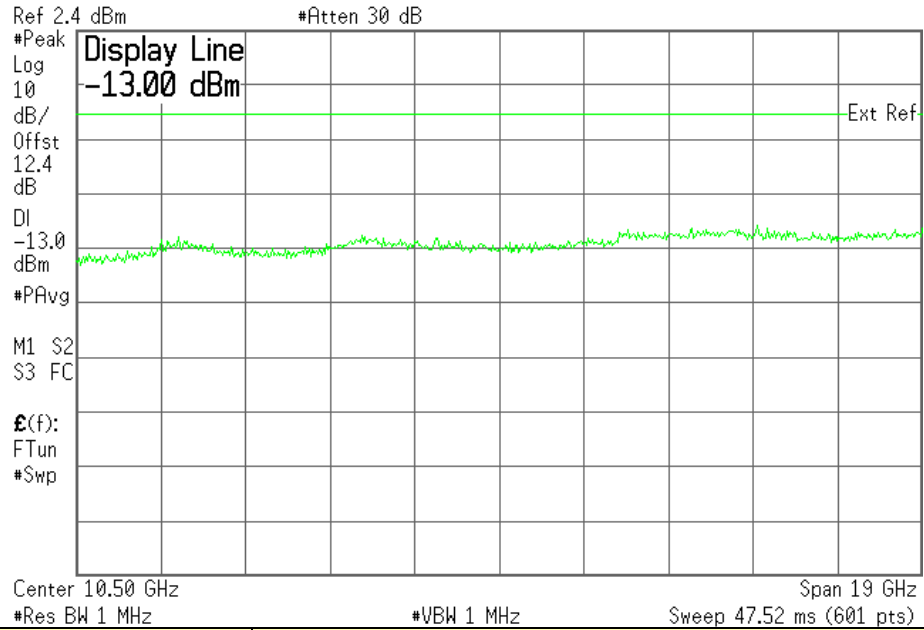

Cellular Harmonics for Ch. 128 (824.2 MHz)	Level (dBm)
Second	--
Third	--
All others	< -30dBm up to 20GHz

Plot 6.4.40) Out of Band Emissions at Antenna Terminals

WCDMA, Middle channel, 836.4 MHz, 1 MHz to 1 GHz

Agilent 20:23:41 Sep 12, 2005

L

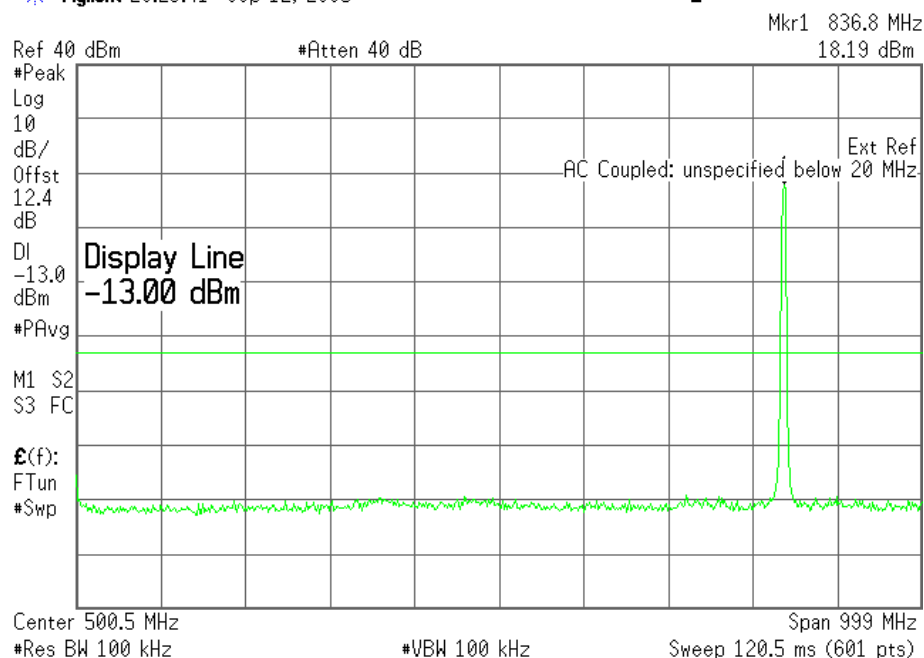

Plot 6.4.41) Out of Band Emissions at Antenna Terminals

WCDMA, Middle channel, 836.4 MHz, TX signal +/- 20 MHz

Agilent 21:22:51 Sep 12, 2005

L

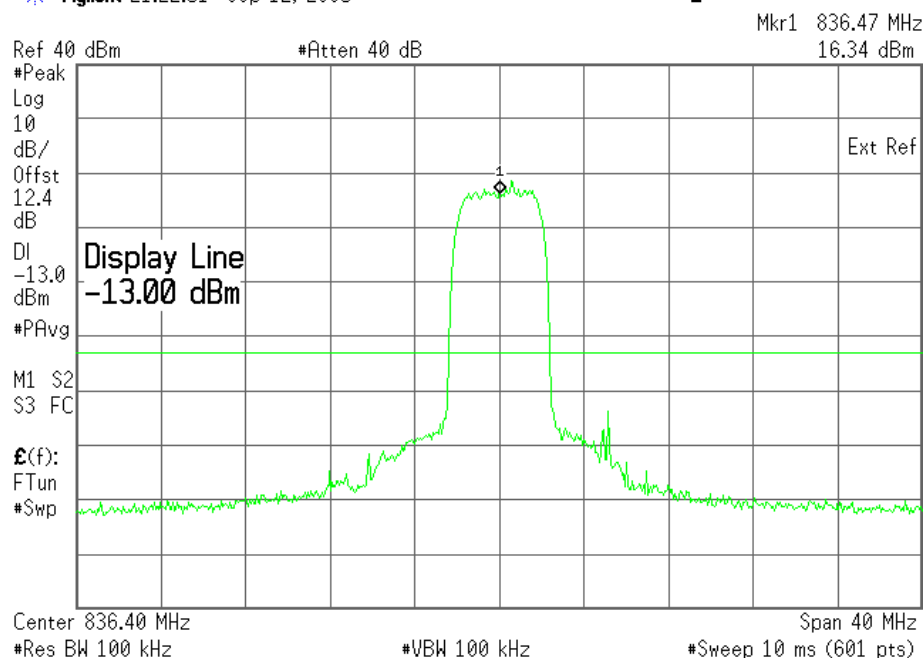

The strong emission shown in each case is the carrier signal.

SIERRA WIRELESS, INC.

Plot 6.4.42) Out of Band Emissions at Antenna Terminals

WCDMA, Middle channel, 836.4 MHz, 1 GHz to 20 GHz

Agilent 23:50:25 Sep 12, 2005

L

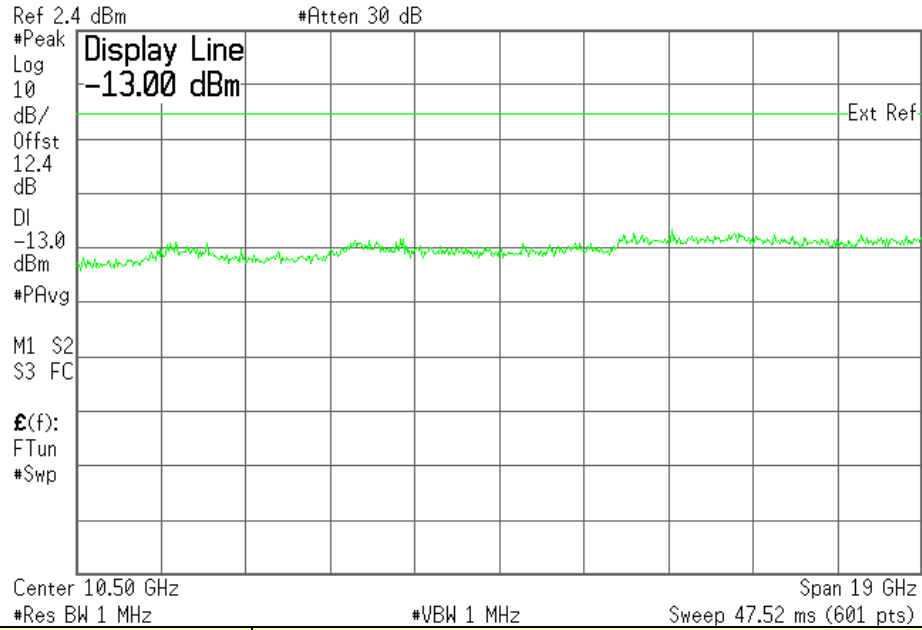

Cellular Harmonics for Ch. 190 (836.6 MHz)	Level (dBm)
Second	--
Third	--
All others	< -30dBm up to 20GHz

Plot 6.4.43) Out of Band Emissions at Antenna Terminals

WCDMA, High Channel, 846.6 MHz, 1 MHz to 1 GHz

Agilent 20:21:42 Sep 12, 2005

L

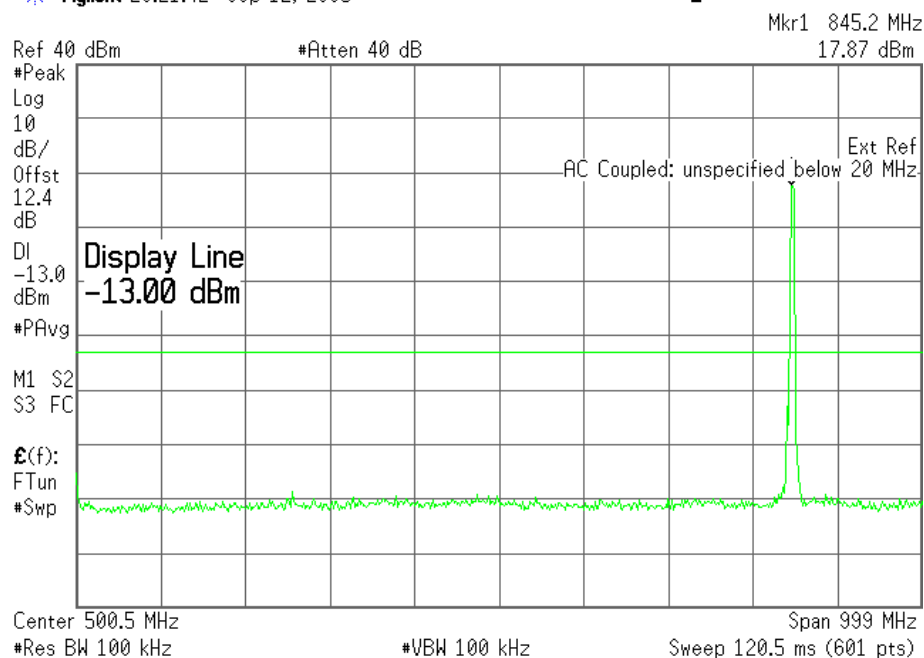

Plot 6.4.44) Out of Band Emissions at Antenna Terminals

WCDMA, High Channel, 846.6 MHz, TX signal +/- 20 MHz

Agilent 21:24:09 Sep 12, 2005

L

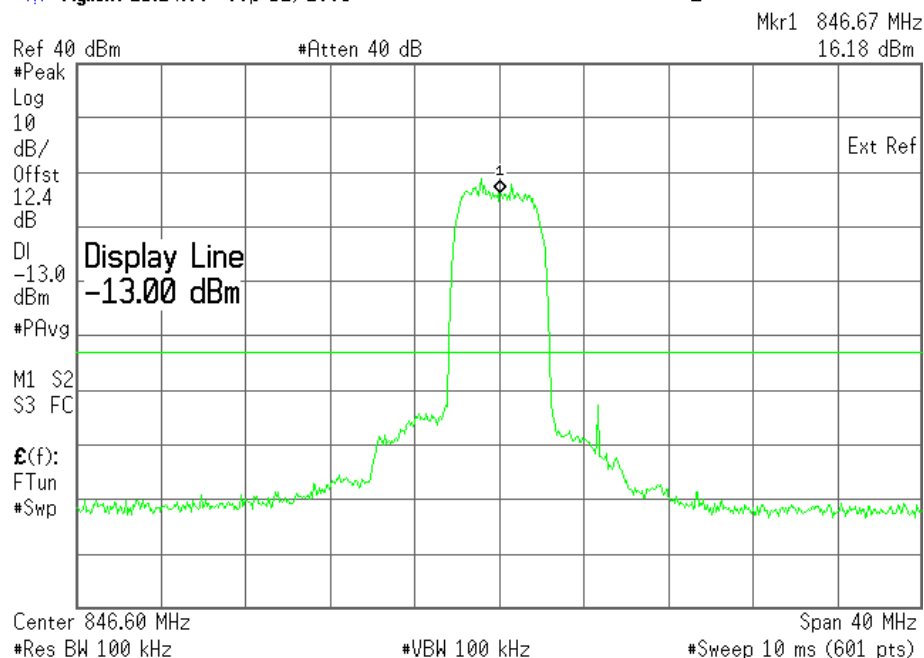

The strong emission shown in each case is the carrier signal.

SIERRA WIRELESS, INC.

Plot 6.4.45) Out of Band Emissions at Antenna Terminals

WCDMA, High Channel, 846.6 MHz, 1 GHz to 20 GHz

Agilent 23:51:28 Sep 12, 2005

L

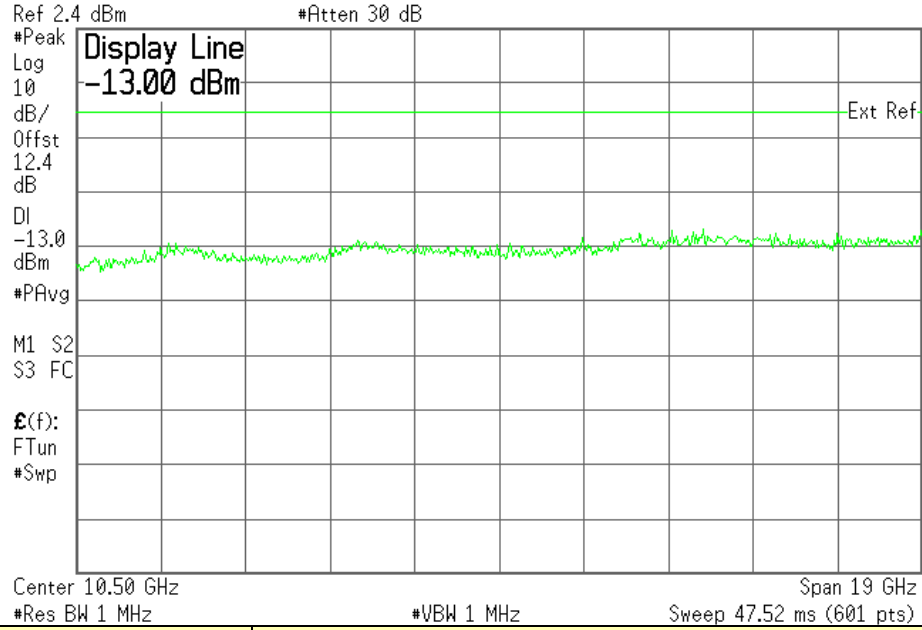

Cellular Harmonics for Ch. 251 (848.8 MHz)	Level (dBm)
Second	--
Third	--
All others	< -30dBm up to 20GHz

SIERRA WIRELESS, INC.

Plot 6.4.46) Out of Band Emissions at Antenna Terminals

WCDMA, Low channel, 1852.4 MHz, 1 MHz to 1 GHz

Agilent 20:11:07 Sep 12, 2005

L

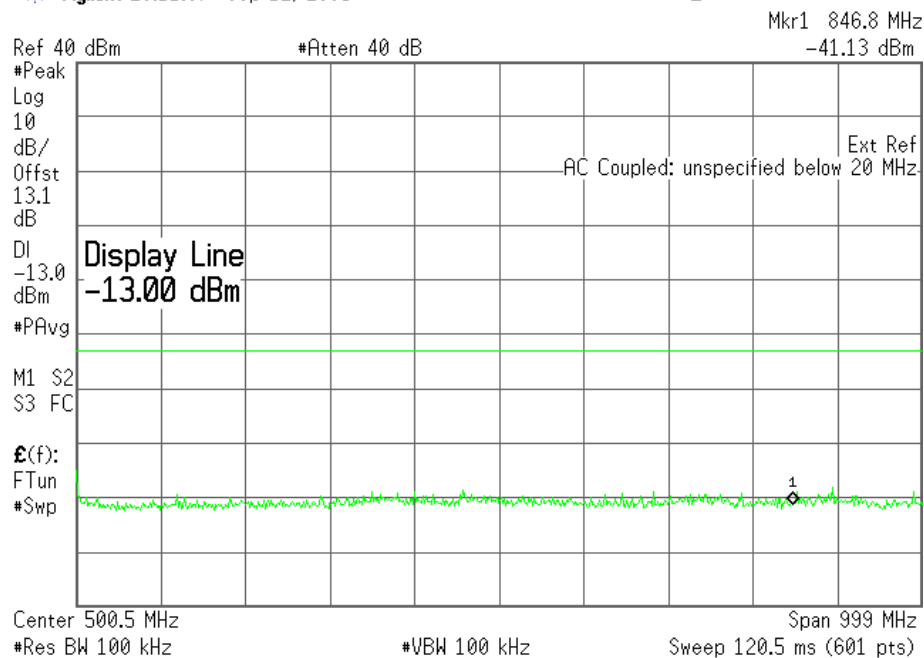

Plot 6.4.47) Out of Band Emissions at Antenna Terminals

WCDMA, Low channel, 1852.4 MHz, TX signal +/- 20 MHz

Agilent 21:26:45 Sep 12, 2005

L

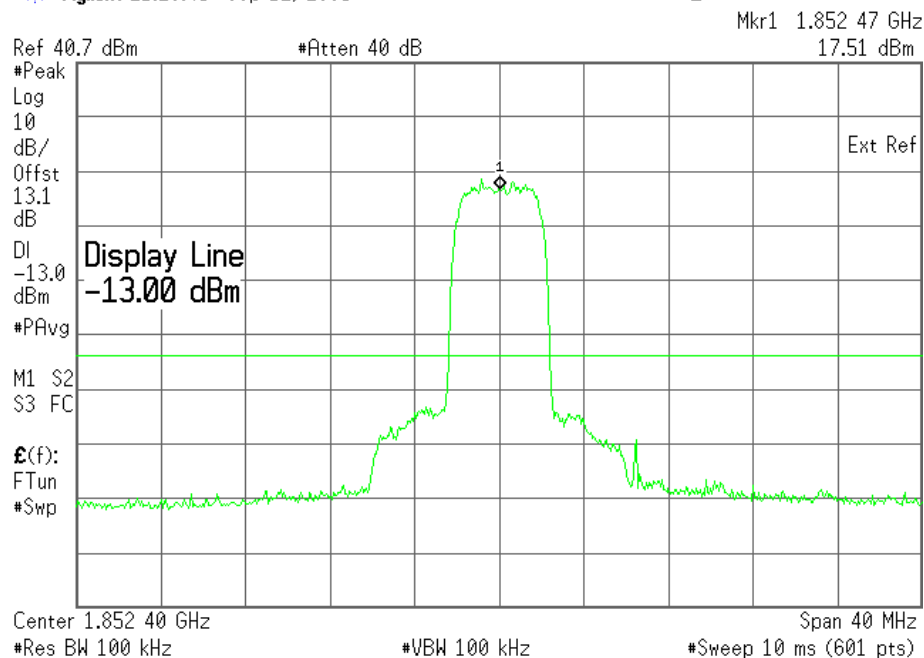

Plot 6.4.48) Out of Band Emissions at Antenna Terminals

WCDMA, Low channel, 1852.4 MHz, 1 GHz to 20 GHz

Agilent 00:04:59 Sep 13, 2005

L

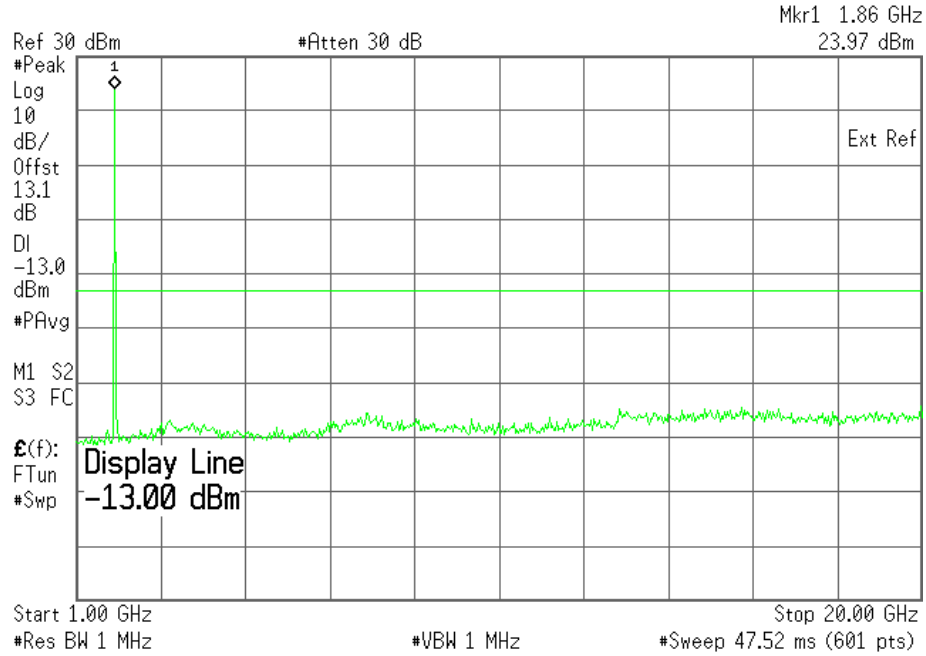

The strong emission shown is the carrier signal.

SIERRA WIRELESS, INC.

Plot 6.4.49) Out of Band Emissions at Antenna Terminals

WCDMA, Middle channel, 1880 MHz, 1 MHz to 1 GHz

Agilent 20:12:02 Sep 12, 2005

L

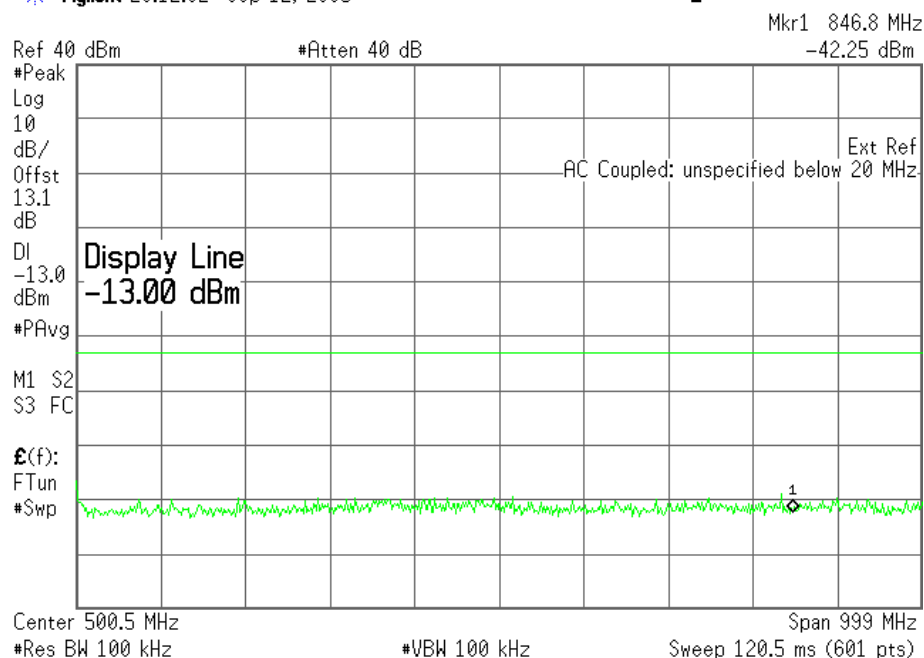

Plot 6.4.50) Out of Band Emissions at Antenna Terminals

WCDMA, Middle channel, 1880 MHz, TX signal +/- 20 MHz

Agilent 21:28:29 Sep 12, 2005

L

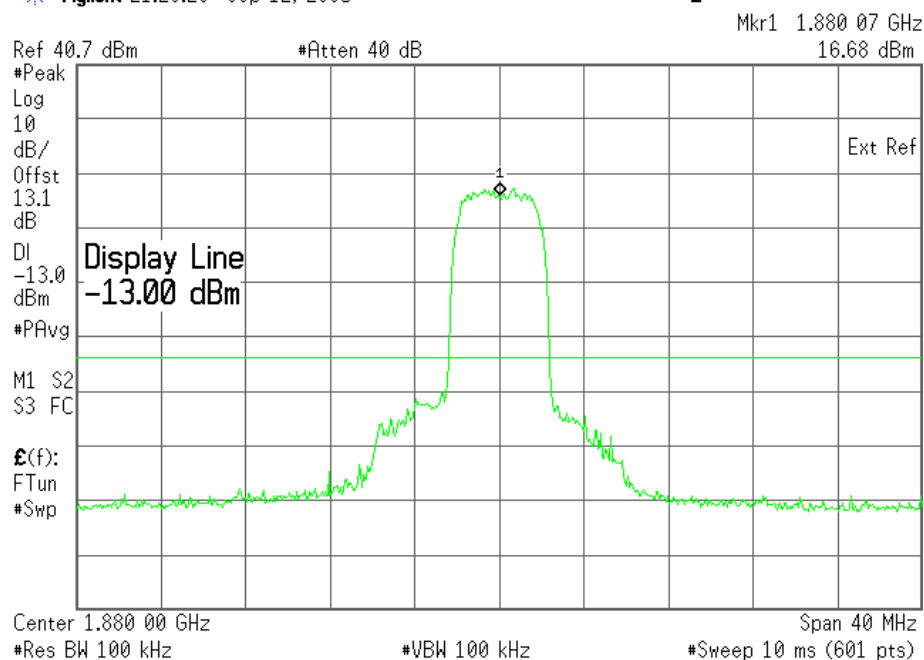

Plot 6.4.51) Out of Band Emissions at Antenna Terminals

WCDMA, Middle channel, 1880 MHz, 1 GHz to 20 GHz

Agilent 00:05:47 Sep 13, 2005

L

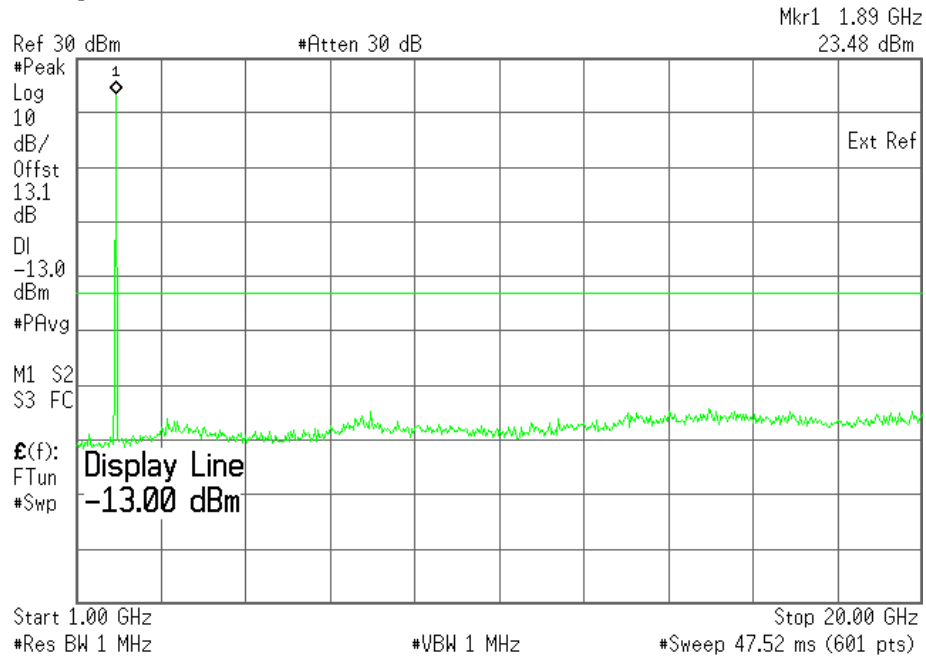

The strong emission shown is the carrier signal.

Plot 6.4.52) Out of Band Emissions at Antenna Terminals

WCDMA, High channel, 1907.6 MHz, 1 MHz to 1 GHz

Agilent 20:13:03 Sep 12, 2005

L

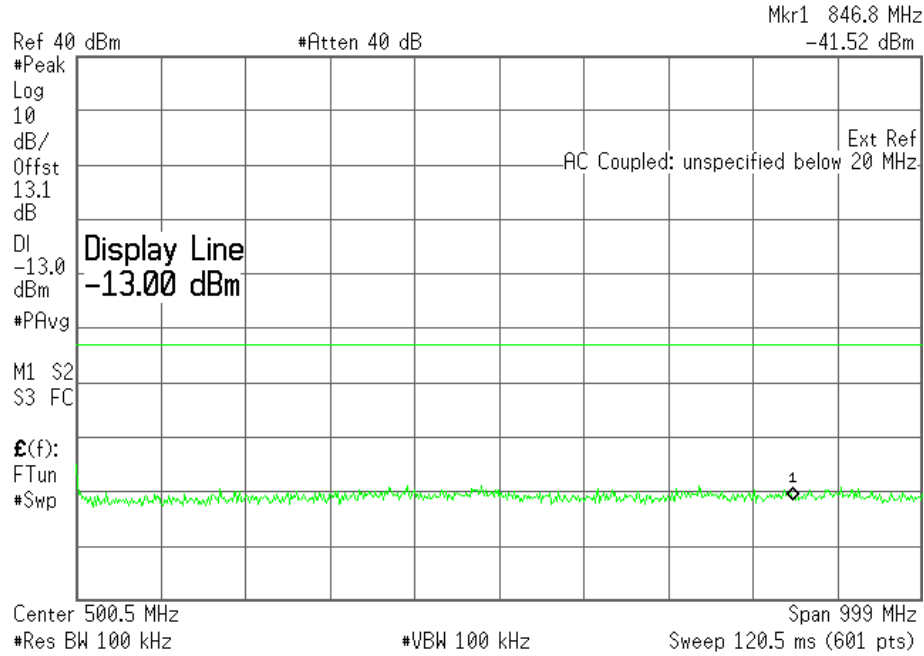

Plot 6.4.53) Out of Band Emissions at Antenna Terminals

WCDMA, High channel, 1907.6 MHz, TX signal +/- 20 MHz

Agilent 21:30:50 Sep 12, 2005

L

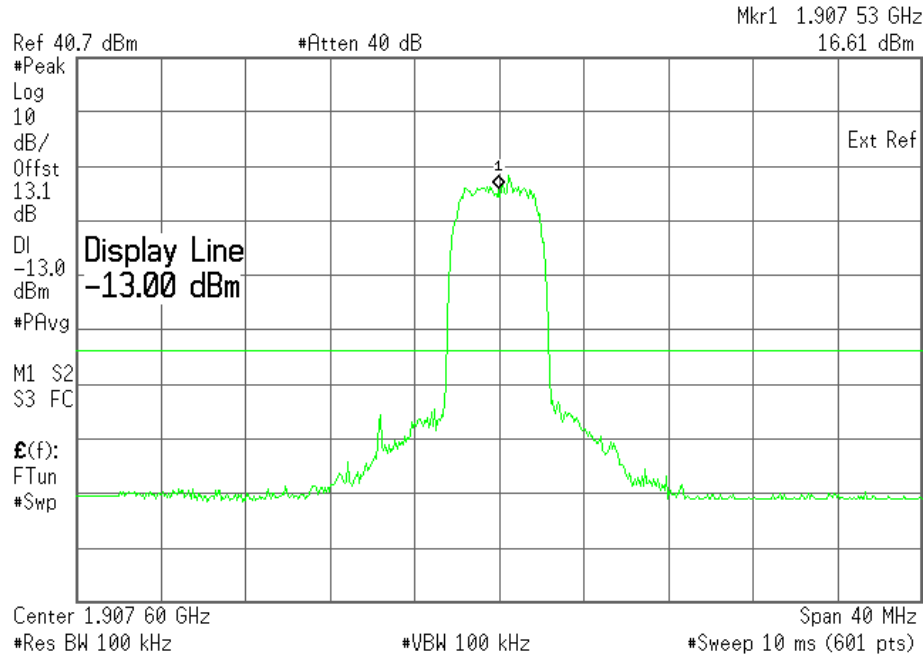

Plot 6.4.54) Out of Band Emissions at Antenna Terminals

WCDMA, High channel, 1907.6 MHz, 1 GHz to 20 GHz

Agilent 00:06:28 Sep 13, 2005

L

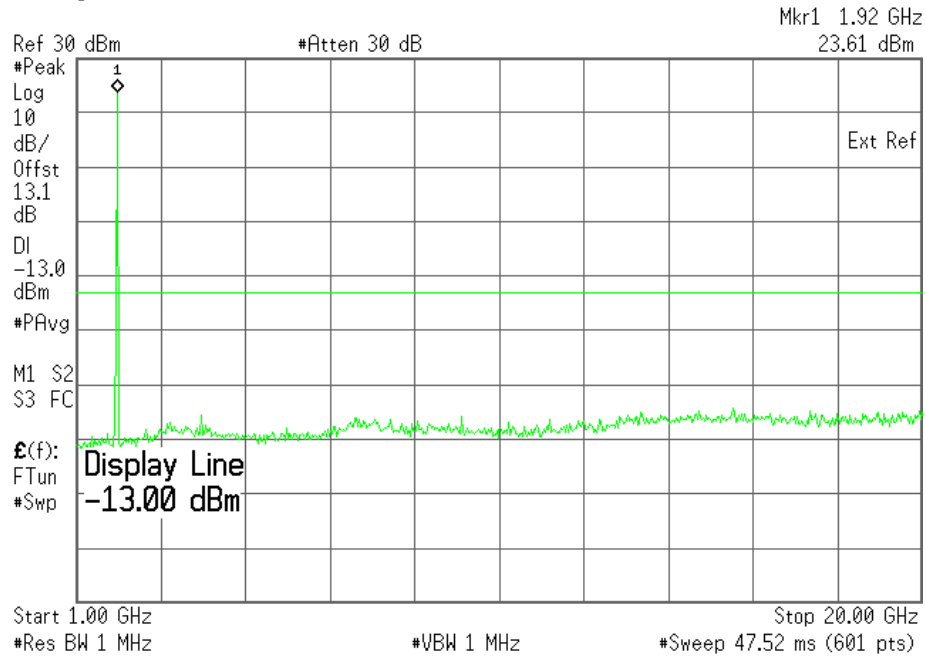

The strong emission shown is the carrier signal.

7 Block Edge Compliance

FCC part 22H/24E

7.1 Test Procedure

The transmitter output was connected to a Rohde & Schwarz CMU200 Test Set and configured to operate at maximum power. The block edge emissions were measured at the required operating frequencies in each band on the Spectrum Analyzer.

Test Setup

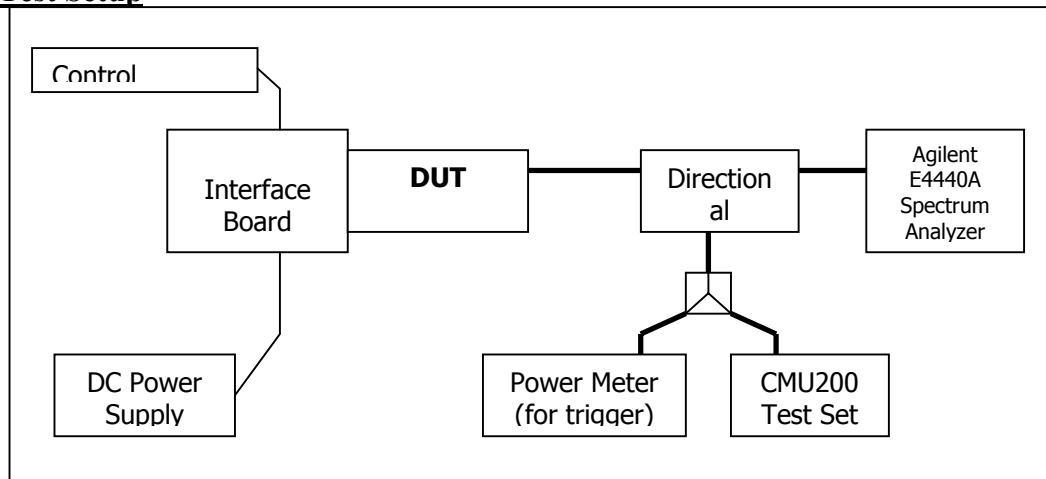

7.2 Test Equipment

Instrument List

EQUIPMENT	MANUFACTURER	MODEL NO.	SERIAL NO.	CAL. DATE
Control Computer	TC	Generic PC	100488	N/A
Wireless Test Set	Rohde & Schwarz	CMU200	836766/030	N/A
Spectrum Analyzer	Agilent	PSA E4440A	US41421268	Sept. 29, 2004
DC Power Supply	HP	6632A	3530A	N/A
Interface Board	Shop built	Minnow	N/A	N/A
Directional Coupler	Mini-Circuits	ZA3PD-2	N/A	N/A

7.3 Test Results

Block Test	Frequency Boundaries (MHz)	Channels Tested	Corresponding Plots	Result
1	GMSK: Below 824 MHz, above 849 MHz	128, 251	7.4.1, 7.4.2	Complies
2	8PSK: Below 824 MHz, above 849 MHz	128, 251	7.4.3, 7.4.4	Complies
3	GMSK: Below 1850MHz, above 1910MHz	512, 810	7.4.5, 7.4.6	Complies
4	8PSK: Below 1850MHz, above 1910MHz	512, 810	7.4.7, 7.4.8	Complies
Block Test	Frequency Boundaries (MHz)	Channels Tested	Corresponding Plots	Result
1	WCDMA: Below 824MHz, above 849MHz	4132, 4233	7.4.9, 7.4.10	Complies
2	WCDMA: Below 1850MHz, above 1910MHz	9262, 9538	7.4.11, 7.4.12	Complies

7.4 Test Plots

Plot 7.4.1) GSMK; Cellular low channel, below 824 MHz

Agilent 09:07:40 Sep 13, 2005

L

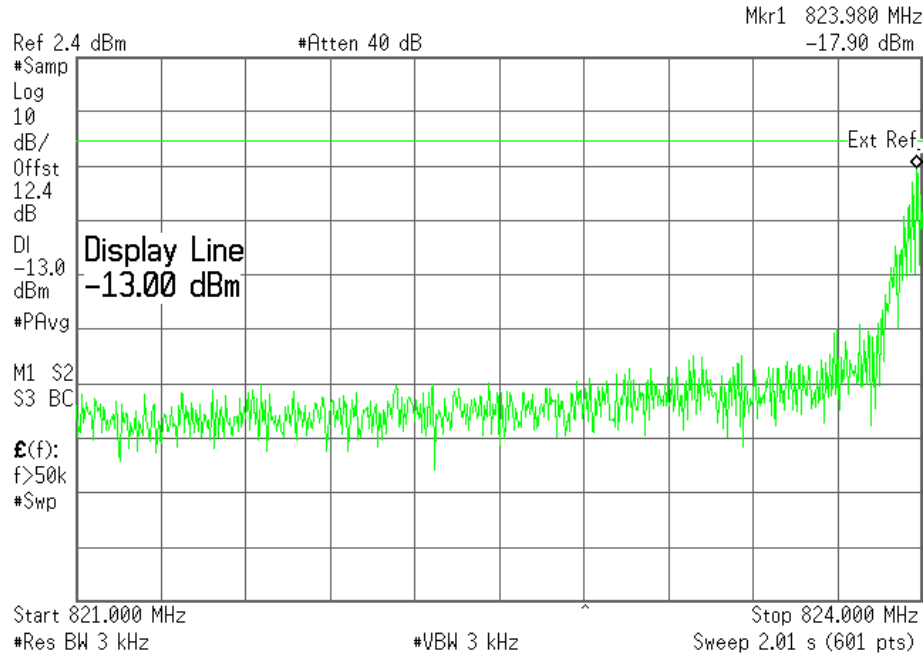

Plot 7.4.2) GSMK; Cellular high channel, above 849 MHz

Agilent 09:09:47 Sep 13, 2005

L

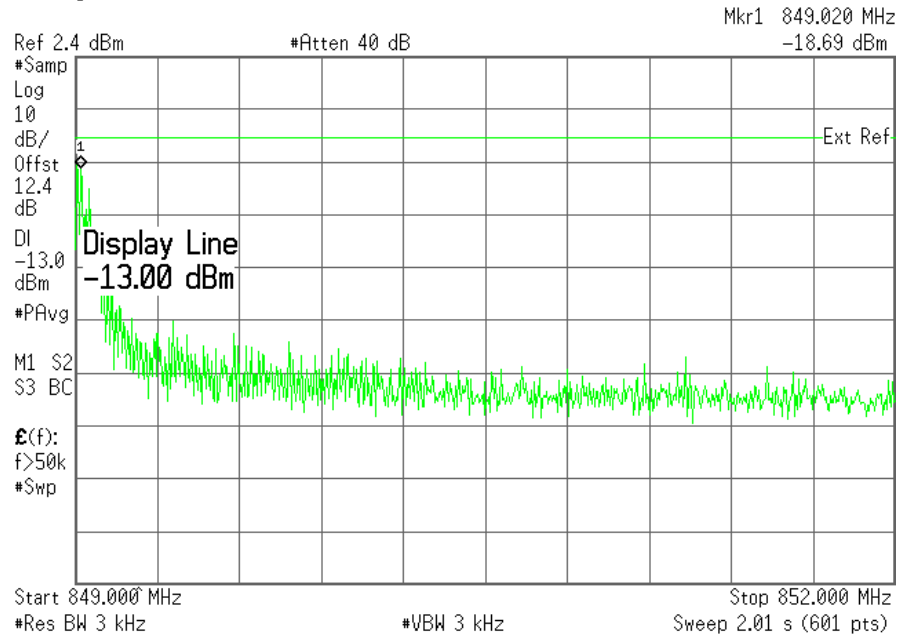

Plot 7.4.3) 8-PSK; Cellular low channel, below 824 MHz

Agilent 09:13:39 Sep 13, 2005

L

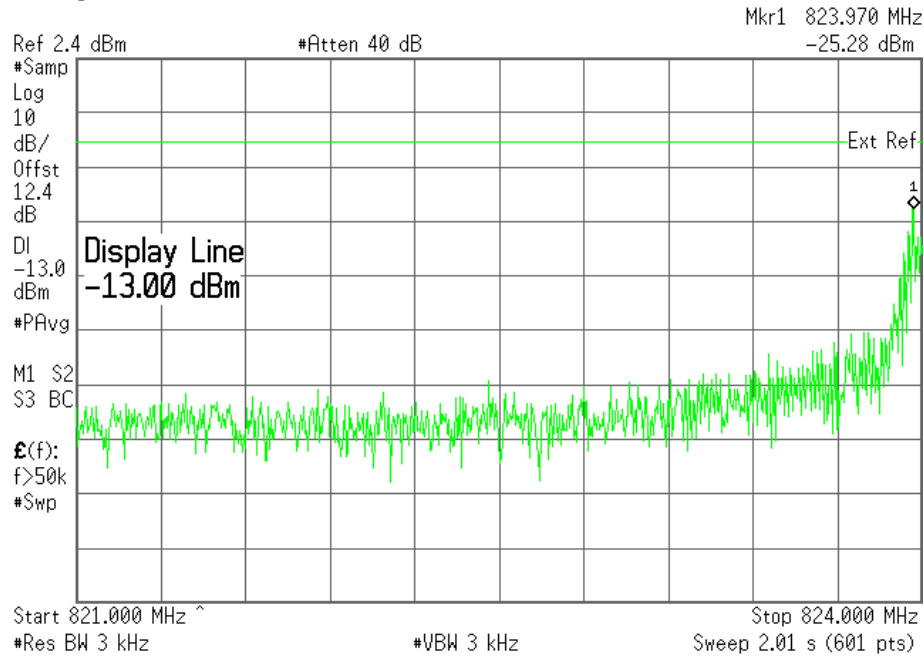

Plot 7.4.4) 8-PSK; Cellular high channel, above 849 MHz

Agilent 09:11:46 Sep 13, 2005

L

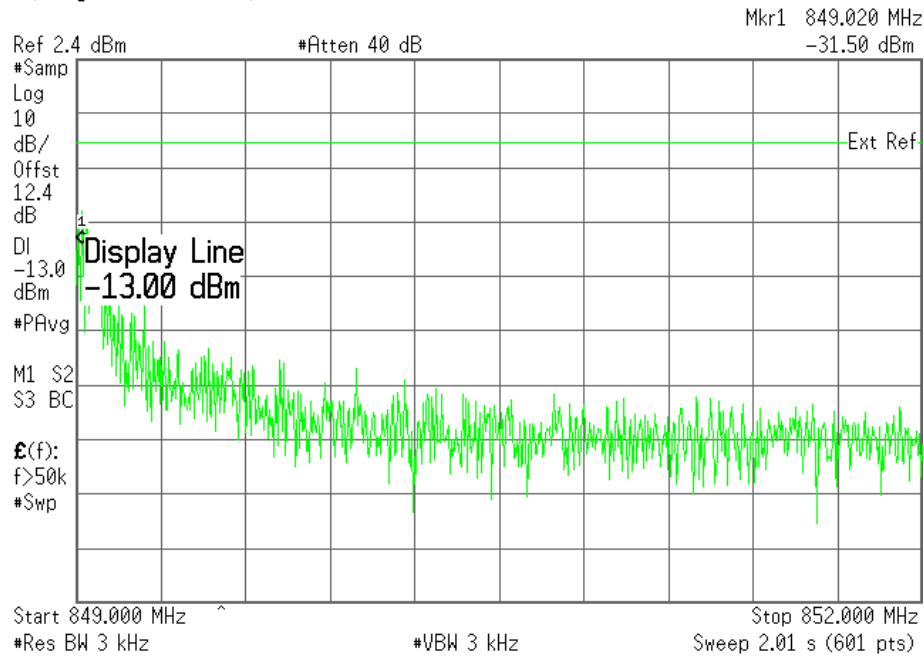

Plot 7.4.5) GMSK; PCS low channel, below 1850 MHz

Agilent 09:49:34 Sep 13, 2005

L

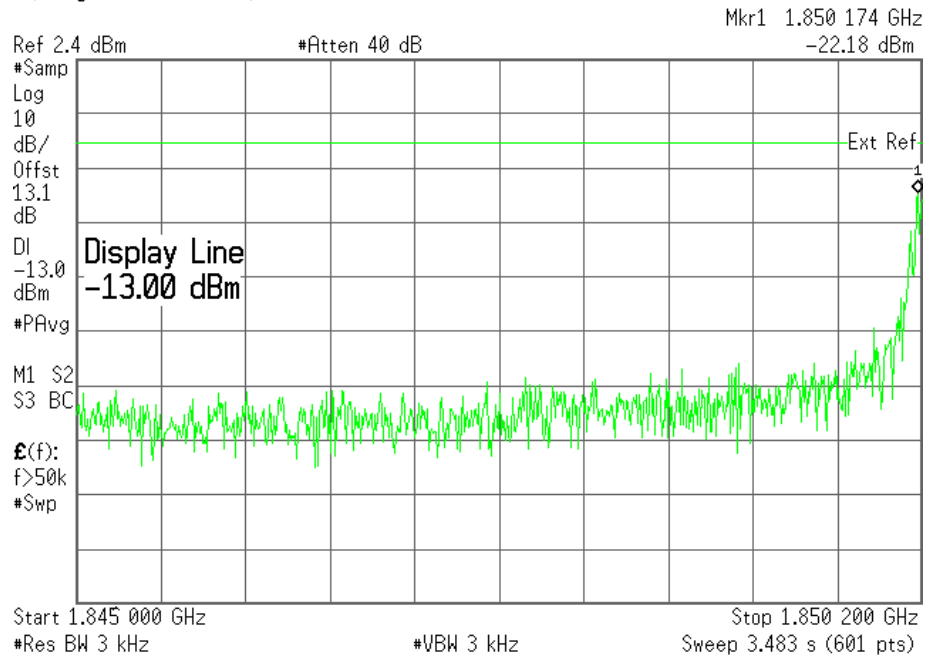

Plot 7.4.6) GMSK; PCS high channel, above 1910 MHz

Agilent 09:58:36 Sep 13, 2005

L

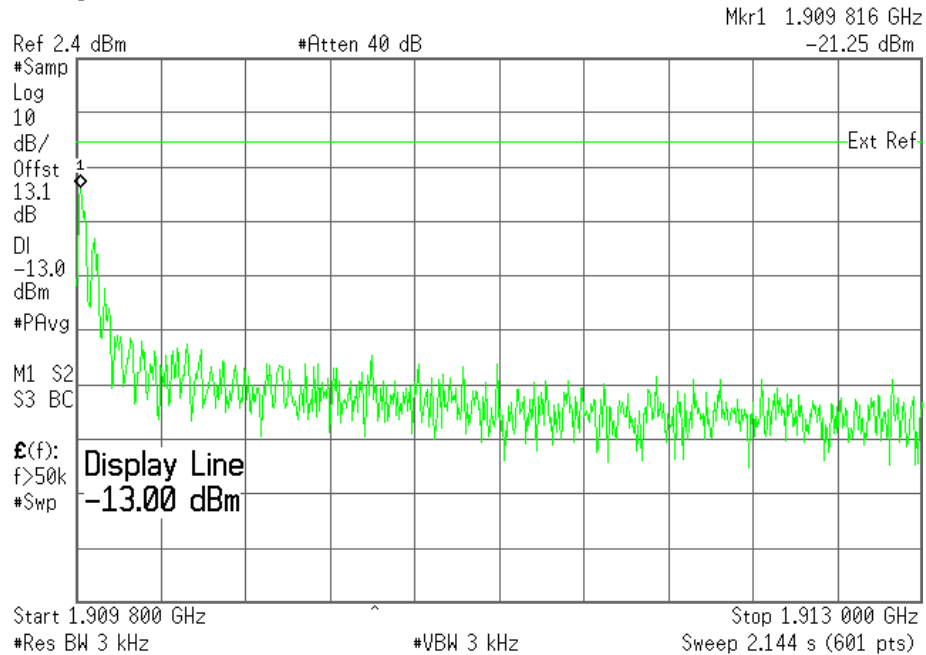

Plot 7.4.7) 8-PSK; PCS low channel, below 1850 MHz

Agilent 10:16:56 Sep 13, 2005

L

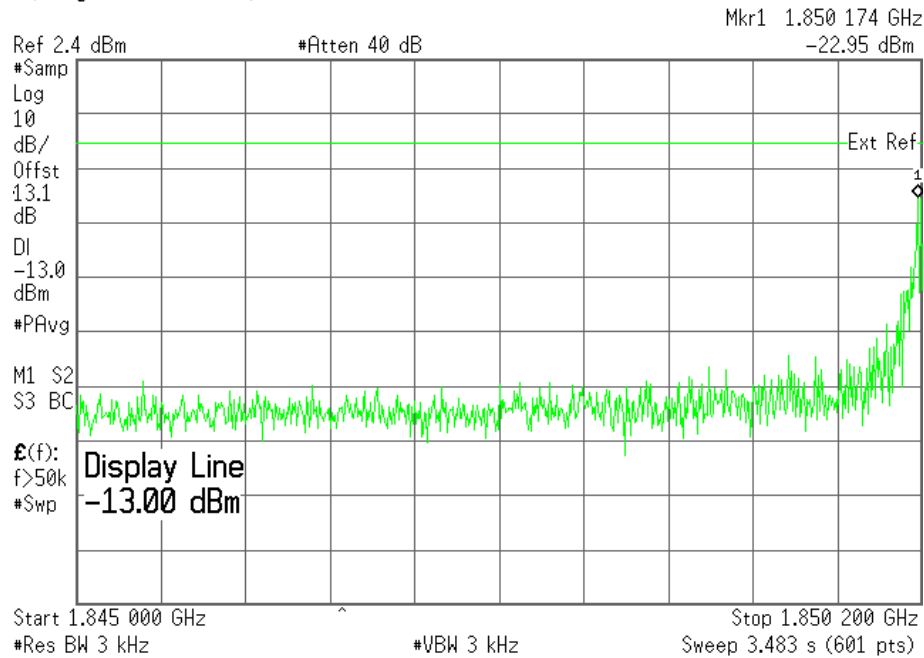

Plot 7.4.8) 8-PSK; PCS high channel, above 1910 MHz

Agilent 10:13:54 Sep 13, 2005

L

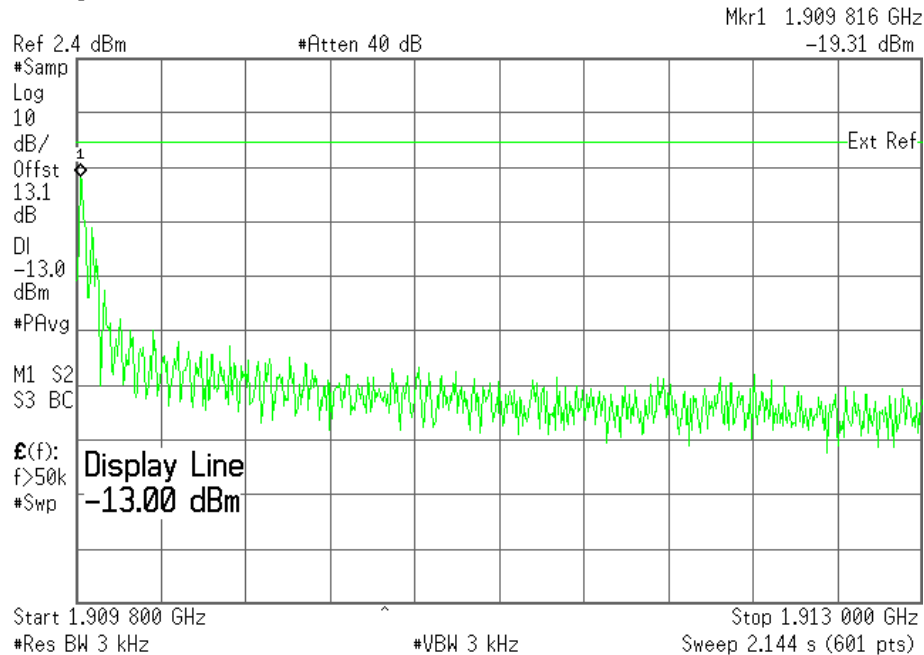

SIERRA WIRELESS, INC.

Plot 7.4.9) WCDMA; Cellular low channel, below 824 MHz

Agilent 12:10:12 Sep 30, 2005

L

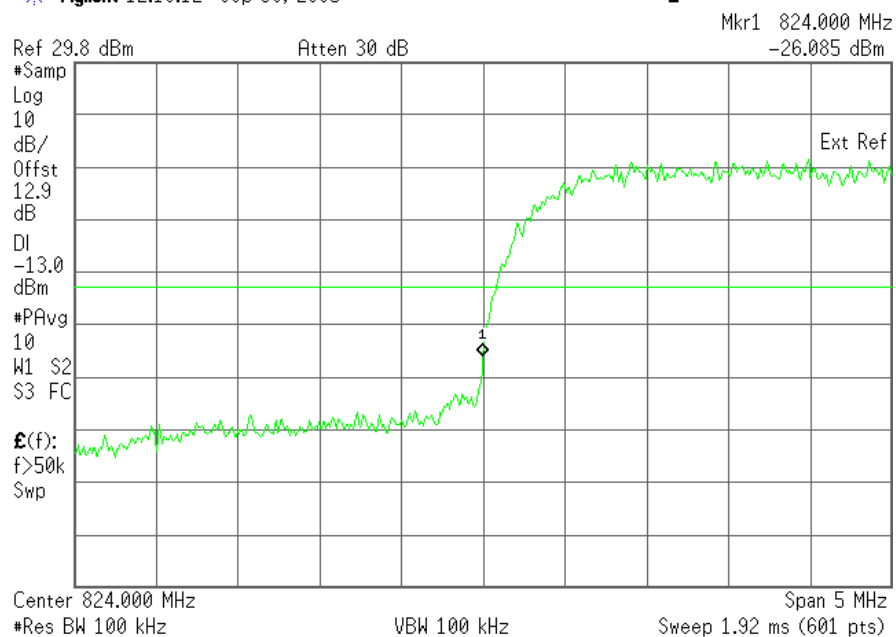

Plot 7.4.10) WCDMA; Cellular high channel, above 849 MHz

Agilent 12:13:33 Sep 30, 2005

L

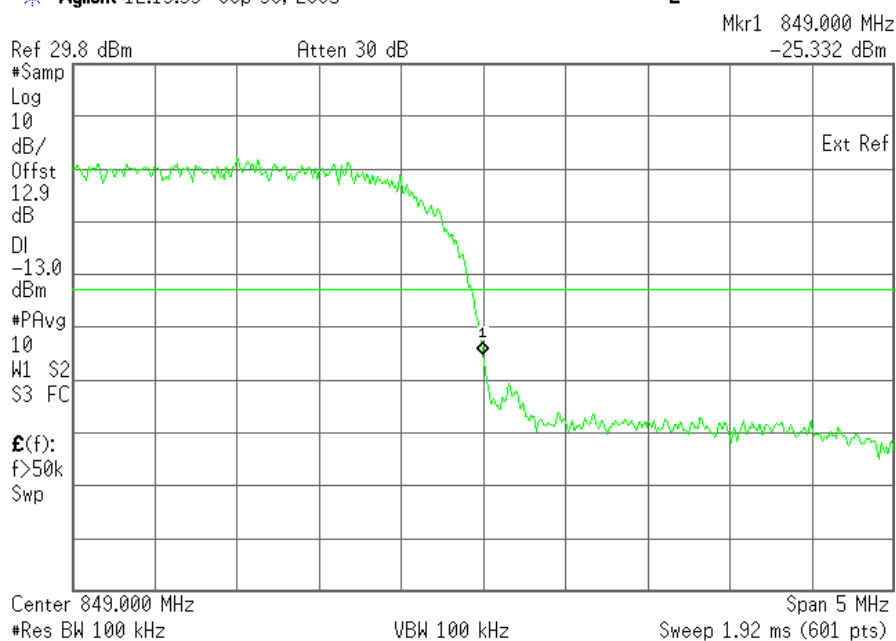

SIERRA WIRELESS, INC.

Plot 7.4.11) WCDMA; PCS low channel, below 1850 MHz

Agilent 12:17:40 Sep 30, 2005

L

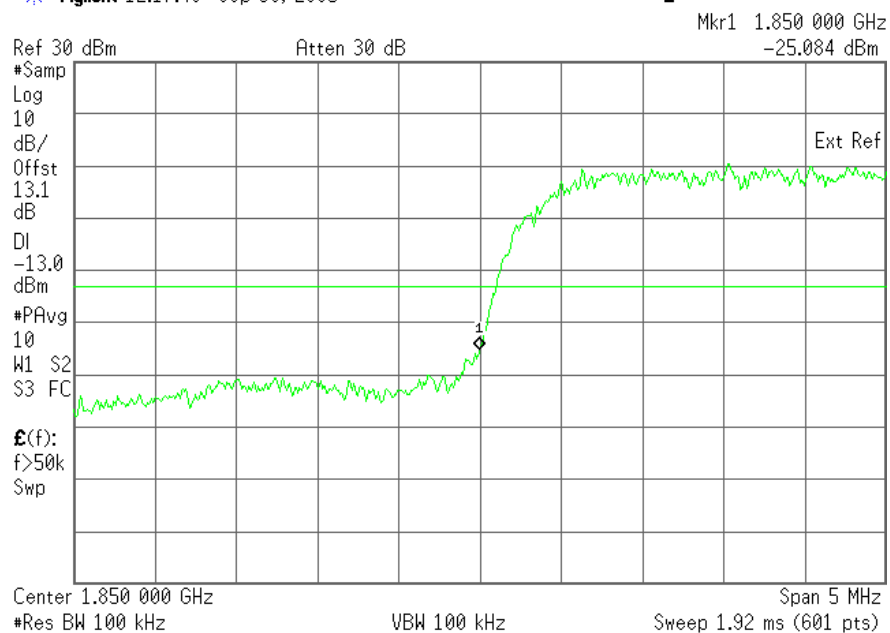

Plot 7.4.12) WCDMA; PCS high channel, above 1910 MHz

Agilent 12:18:58 Sep 30, 2005

L

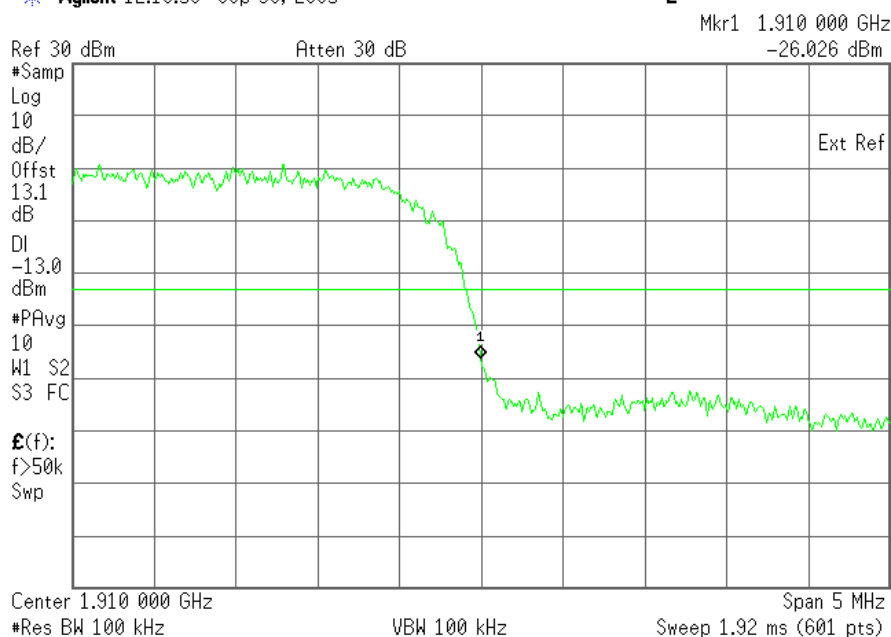

8 Frequency Stability Versus Temperature

FCC 2.1055

8.1 Summary of Results

The AC860 Frequency Stability versus temperature meets the requirement of being within ± 0.1 ppm of the received base station frequency.

8.2 Test Procedure

The AC860 was placed inside the temperature chamber. The transmitting frequency error is measured at 25 degrees C, then the temperature is set to +60 degrees C and allowed to stabilize. After sufficient soak time, the transmitting frequency error is measured. The temperature is decreased by 10 degrees, allowed to stabilize and soak, then the measurement is repeated. This is repeated until -20 degrees C is completed. The process is then repeated back up to +60 degrees C. Frequency metering included internal averaging of the CMU200 to stabilize the reading. Reference power supply voltage for these tests is 5.0 volts.

Test Setup

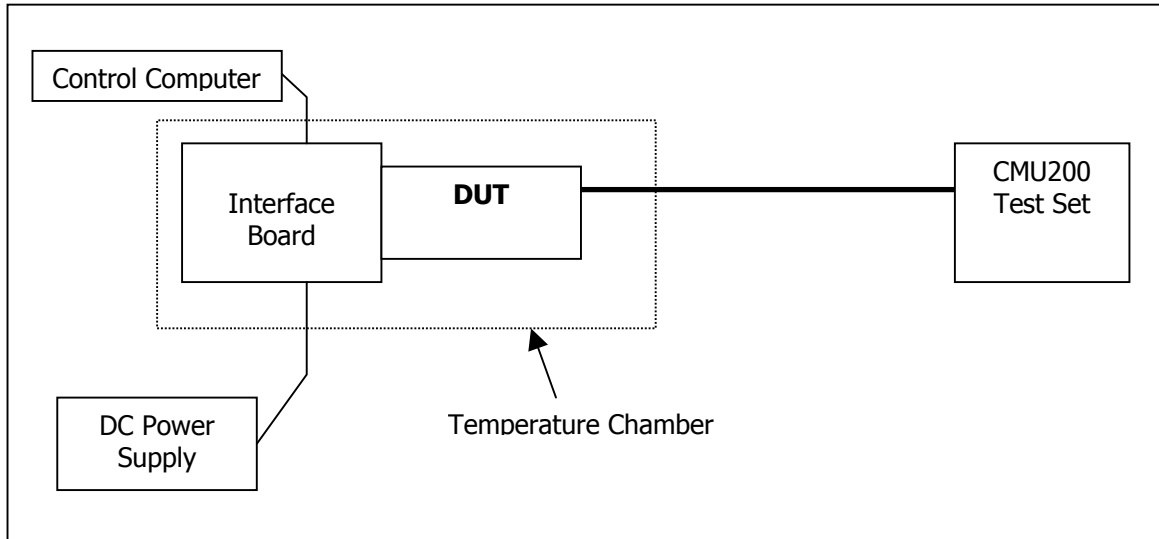

8.3 Test Equipment

EQUIPMENT	MANUFACTURER	MODEL NO.	SERIAL NO.	CAL. DATE
Control Computer	TC	Generic PC	100488	N/A
Wireless Test Set	Rohde & Schwarz	CMU200	836766/030	N/A
Spectrum Analyzer	Agilent	PSA E4440A	US41421268	Sept. 29, 2004
DC Power Supply	HP	6632A	3530A	N/A
Interface Board	Shop built	Minnow	N/A	N/A
Directional Coupler	Mini-Circuits	ZA3PD-2	N/A	N/A

SIERRA WIRELESS, INC.

8.4 Test Results

Low to High Temperature Frequency Error

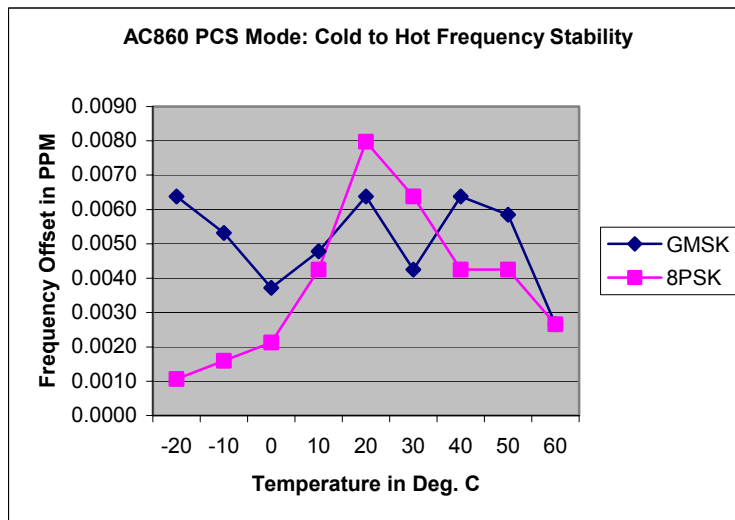
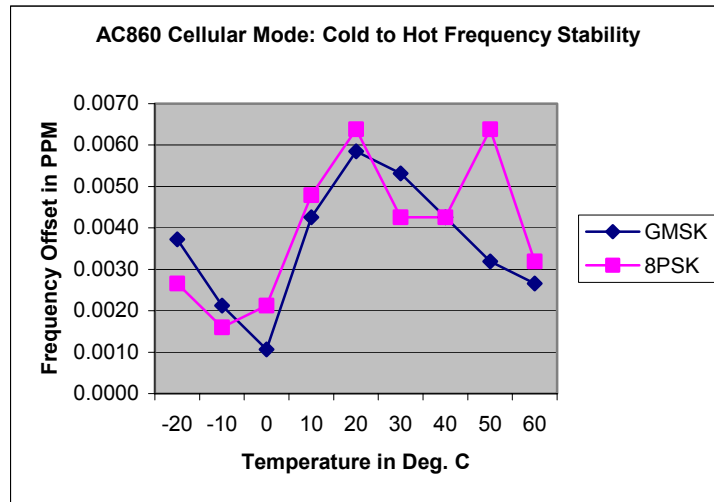

Low to High Temperature Tabular Readings

Temp.(C)	Cellular Mode: 824MHz to 848MHz				PCS Mode: 1850MHz to 1909MHz			
	GMSK Mode		8-PSK Mode		GMSK Mode		8-PSK Mode	
	Offset (Hz)	Offset (ppm)	Offset (Hz)	Offset (ppm)	Offset (Hz)	Offset (ppm)	Offset (Hz)	Offset (ppm)
-20	-7	0.0037	-5	0.0027	-12	0.0064	-2	0.0011
-10	-4	0.0021	-3	0.0016	-10	0.0053	-3	0.0016
0	-2	0.0011	-4	0.0021	7	0.0037	-4	0.0021
10	-8	0.0043	-9	0.0048	-9	0.0048	-8	0.0043
20	-11	0.0059	-12	0.0064	-12	0.0064	-15	0.0080
30	10	0.0053	-8	0.0043	8	0.0043	12	0.0064
40	8	0.0043	-8	0.0043	12	0.0064	8	0.0043
50	-6	0.0032	-12	0.0064	11	0.0059	-8	0.0043
60	-5	0.0027	-6	0.0032	-5	0.0027	5	0.0027

SIERRA WIRELESS, INC.

High to Low Temperature Frequency Error

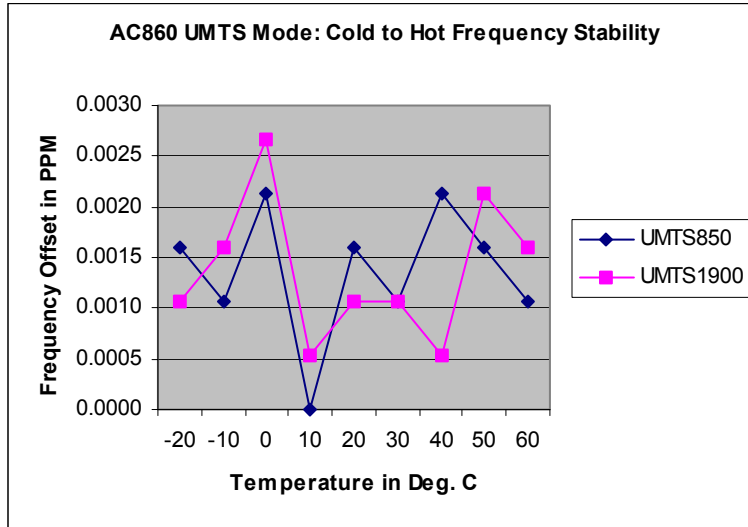

High to Low Temperature Tabular Readings

Temp.(C)	UMTS Mode: 1850MHz to 1909MHz		UMTS Mode: 1850MHz to 1909MHz	
	Offset (Hz)	Offset (Hz)	Offset (Hz)	Offset (ppm)
60	-3	0.0016	2	0.0011
50	2	0.0011	-3	0.0016
40	-4	0.0021	-5	0.0027
30	0	0.0000	1	0.0005
20	-3	0.0016	-2	0.0011
10	2	0.0011	2	0.0011
0	-4	0.0021	-1	0.0005
-10	3	0.0016	4	0.0021
-20	-2	0.0011	3	0.0016

SIERRA WIRELESS, INC.

High to Low Temperature Frequency Error

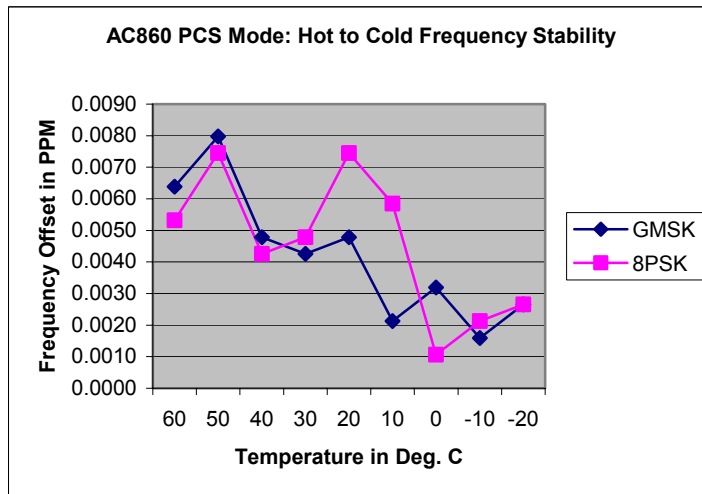
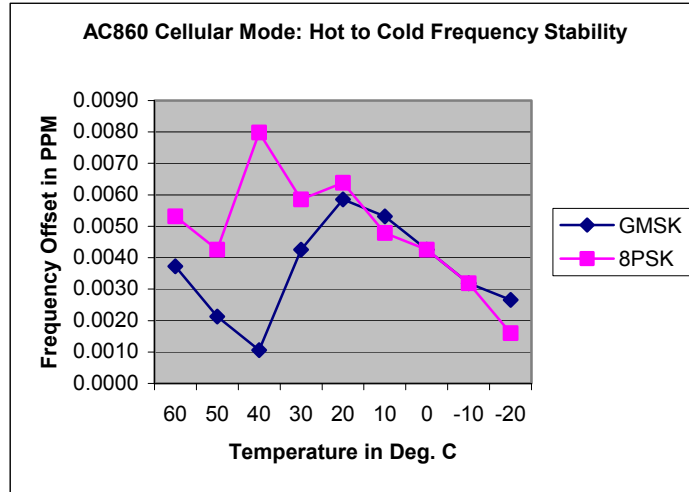

High to Low Temperature Tabular Readings

Temp.(C)	Cellular Mode: 824MHz to 848MHz				PCS Mode: 1850MHz to 1909MHz			
	GMSK Mode		8-PSK Mode		GMSK Mode		8-PSK Mode	
	Offset (Hz)	Offset (ppm)	Offset (Hz)	Offset (ppm)	Offset (Hz)	Offset (ppm)	Offset (Hz)	Offset (ppm)
60	-7	0.0037	-10	0.0053	-12	0.0064	10	0.0053
50	-4	0.0021	-8	0.0043	-15	0.0080	-14	0.0074
40	-2	0.0011	-15	0.0080	-9	0.0048	-8	0.0043
30	-8	0.0043	-11	0.0059	8	0.0043	-9	0.0048
20	-11	0.0059	-12	0.0064	9	0.0048	-14	0.0074
10	10	0.0053	-9	0.0048	-4	0.0021	11	0.0059
0	8	0.0043	-8	0.0043	-6	0.0032	-2	0.0011
-10	-6	0.0032	-6	0.0032	-3	0.0016	-4	0.0021
-20	-5	0.0027	-3	0.0016	-5	0.0027	-5	0.0027

SIERRA WIRELESS, INC.

High to Low Temperature Frequency Error

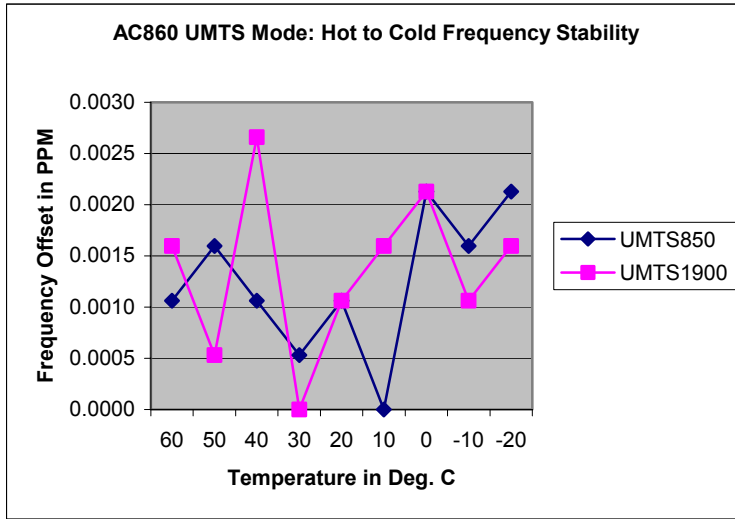

High to Low Temperature Tabular Readings

Temp.(C)	UMTS Mode: 1850MHz to 1909MHz		UMTS Mode: 1850MHz to 1909MHz	
	Offset (Hz)	Offset (Hz)	Offset (ppm)	Offset (ppm)
60	-2	0.0011	-3	0.0016
50	-3	0.0016	1	0.0005
40	2	0.0011	-5	0.0027
30	1	0.0005	0	0.0000
20	2	0.0011	2	0.0011
10	0	0.0000	-3	0.0016
0	-4	0.0021	-4	0.0021
-10	-3	0.0016	-2	0.0011
-20	-4	0.0021	-3	0.0016

9 Frequency Stability Versus Voltage

FCC 2.1055

9.1 Summary of Results

The unit meets the limit of less than 0.1ppm of frequency offset from center for 85% and 115% of the supply voltage for 5.0 volts.

9.2 Test Procedure

The AC860 was connected to a DC Power Supply and a GSM test set (CMU 200) with frequency error measurement capability. The power supply output is adjusted to the test voltage as measured at the input terminals to the module while transmitting. A voltmeter was used to confirm the terminal voltage. The peak frequency error is recorded (worst case).

The test voltages are 4.25 volts to 5.75 volts.

Test Setup

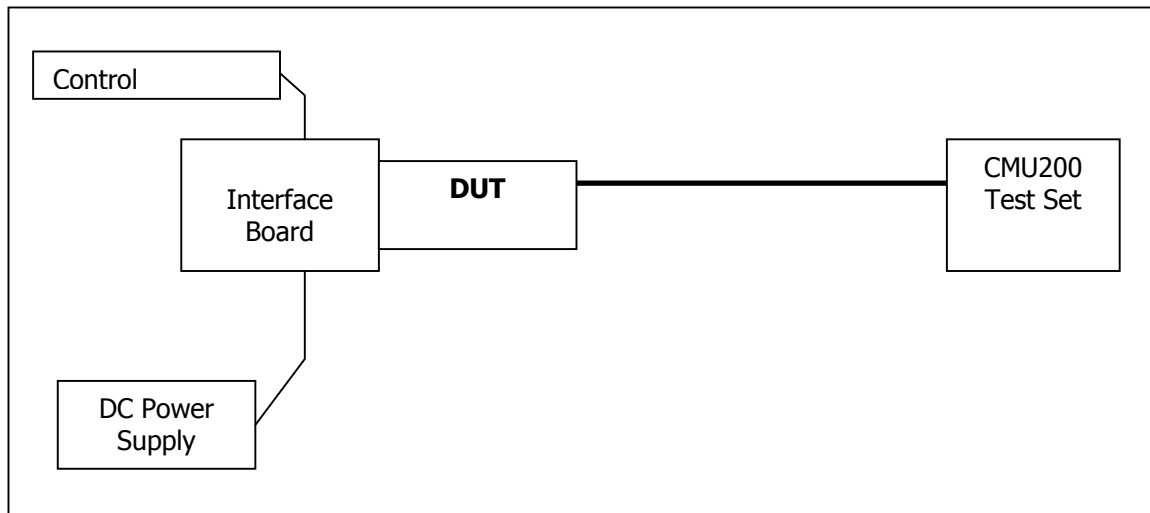

9.3 Test Equipment

EQUIPMENT	MANUFACTURER	MODEL NO.	SERIAL NO.	CAL. DATE
Control Computer	TC	Generic PC	100488	N/A
Wireless Test Set	Rohde & Schwarz	CMU200	836766/030	N/A
Spectrum Analyzer	Agilent	PSA E4440A	US41421268	Sept. 29, 2004
DC Power Supply	HP	6632A	3530A	N/A
Interface Board	Shop built	Minnow	N/A	N/A
Directional Coupler	Mini-Circuits	ZA3PD-2	N/A	N/A

SIERRA WIRELESS, INC.

9.4 Test Results

GSM 85% to 115% of 5 Volts Frequency Error

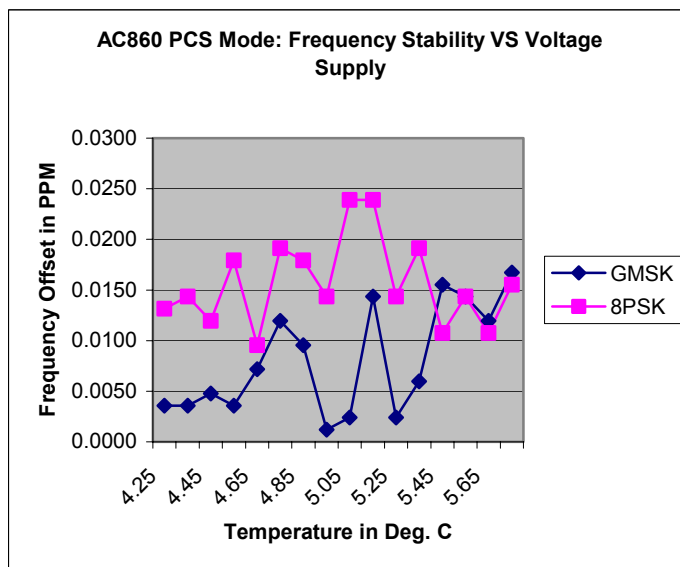
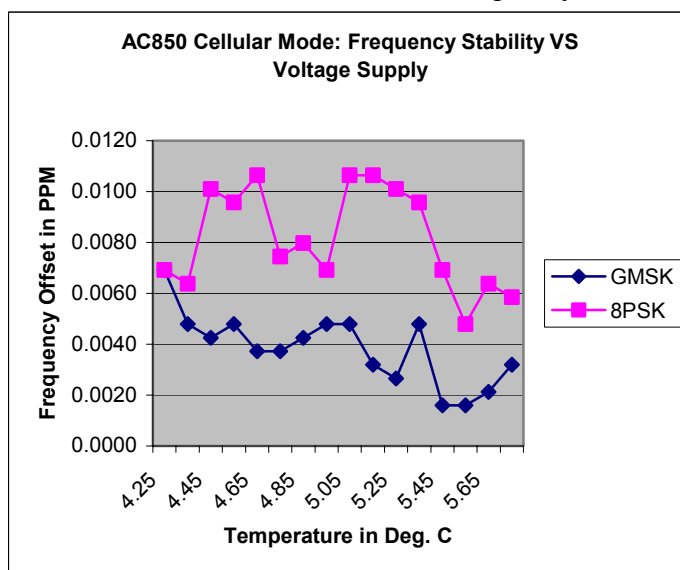

SIERRA WIRELESS, INC.

GSM 85% to 115% of 5 Volts Frequency Error, Tabular Data

Supply (V)	Cellular Mode: 824MHz to 848MHz				PCS Mode: 1850MHz to 1909MHz			
	GMSK Mode		8-PSK Mode		GMSK Mode		8-PSK Mode	
	Offset (Hz)	Offset (ppm)	Offset (Hz)	Offset (ppm)	Offset (Hz)	Offset (ppm)	Offset (Hz)	Offset (ppm)
4.25	-13	0.0069	-13	0.0069	3	0.0036	-11	0.0131
4.35	-9	0.0048	-12	0.0064	3	0.0036	-12	0.0143
4.45	-8	0.0043	-19	0.0101	4	0.0048	-10	0.0119
4.55	-9	0.0048	-18	0.0096	3	0.0036	-15	0.0179
4.65	-7	0.0037	-20	0.0106	-6	0.0072	-8	0.0096
4.75	-7	0.0037	-14	0.0074	10	0.0119	-16	0.0191
4.85	-8	0.0043	-15	0.0080	8	0.0096	-15	0.0179
4.95	-9	0.0048	-13	0.0069	1	0.0012	-12	0.0143
5.05	-9	0.0048	-20	0.0106	-2	0.0024	-20	0.0239
5.15	-6	0.0032	-20	0.0106	-12	0.0143	-20	0.0239
5.25	-5	0.0027	-19	0.0101	-2	0.0024	-12	0.0143
5.35	-9	0.0048	-18	0.0096	5	0.0060	-16	0.0191
5.45	-3	0.0016	-13	0.0069	-13	0.0155	-9	0.0108
5.55	3	0.0016	-9	0.0048	-12	0.0143	-12	0.0143
5.65	4	0.0021	-12	0.0064	-10	0.0119	-9	0.0108
5.75	6	0.0032	-11	0.0059	-14	0.0167	-13	0.0155

SIERRA WIRELESS, INC.

UMTS 85% to 115% of 5 Volts Frequency Error, Tabular Data

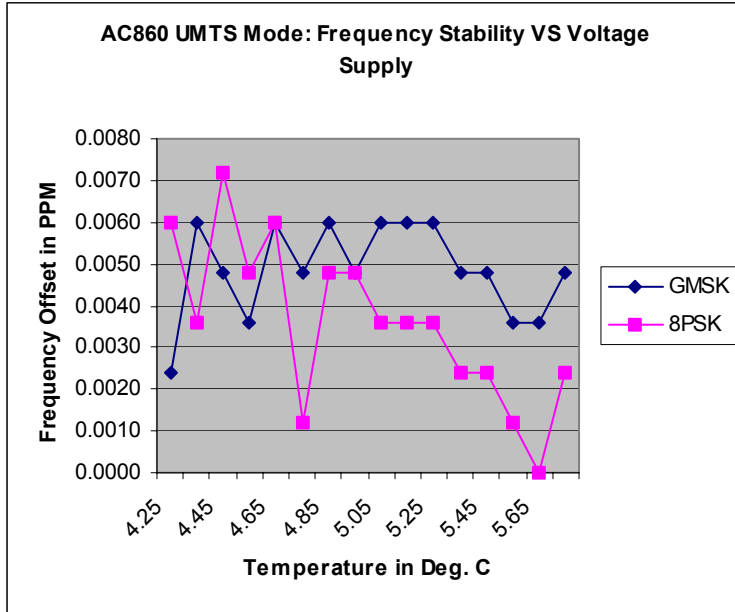

Supply (V)	UMTS Mode			
	850MHz		1900MHz	
	Offset (Hz)	Offset (ppm)	Offset (Hz)	Offset (ppm)
4.25	-13	0.0069	-13	0.0069
4.35	-9	0.0048	-12	0.0064
4.45	-8	0.0043	-19	0.0101
4.55	-8	0.0043	-18	0.0096
4.65	-7	0.0037	-20	0.0106
4.75	-7	0.0037	-20	0.0106
4.85	-8	0.0043	-14	0.0074
4.95	-9	0.0048	-14	0.0074
5.05	-7	0.0037	-20	0.0106
5.15	-6	0.0032	-20	0.0106
5.25	-5	0.0027	-19	0.0101
5.35	-5	0.0027	-18	0.0096
5.45	-3	0.0016	-13	0.0069
5.55	3	0.0016	-13	0.0069
5.65	4	0.0021	-12	0.0064
5.75	6	0.0032	-11	0.0059